

# GA-F2A55M-DS2

## User's Manual

Rev. 1001

12ME-F255MS2-1001R

### Declaration of Conformity

We, Manufacturer/Importer,

G.B.T. Technology Trading GmbH

Address: Bullenkoppel 16, 22047 Hamburg, Germany

Declare that the product

Product Type: **Motherboard**

Product Name: **GA-F2A55M-DS2**

conforms with the essential requirements of the following directives:

- 2004/108/EC EMC Directive:**
  - Conduction & Radiated Emissions: EN55022:2006+A1:2007
  - Immunity: EN55024:1998+A1:2001+A2:2003
  - Power-line harmonics: EN61000-3-2:2006
  - Power-line flicker: EN61000-3-3:2008

- 2006/95/EC LVD Directive**
  - Safety: EN60950-1:2006+A11:2009

- 2011/65/EU RoHS Directive**
  - Restriction of use of certain substances in electronic equipment: This product does not contain any of the restricted substances listed in Annex II, in concentrations and applications banned by the directive.

**CE marking**



Signature: Timmy Huang

(Name) Date: Aug. 20, 2012 Name: Timmy Huang

### DECLARATION OF CONFORMITY

Per FCC Part 2 Section 2.1077(a)



Responsible Party Name: **G.B.T. INC. (U.S.A)**

Address: **17358 Railroad Street**

City of Industry, CA 91748

Phone/Fax No: (626) 854-9338/ (626) 854-9326

hereby declares that the product

**Product Name: Motherboard**

**Model Number: GA-F2A55M-DS2**

Conforms to the following specifications:

FCC Part 15, Subpart B, Section 15.107(a) and Section 15.109

(a), Class B Digital Device

#### Supplementary Information:

This device complies with part 15 of the FCC Rules. Operation is subject to the following two conditions: (1) This device may not cause harmful and (2) this device must accept any interference received, including that may cause undesired operation.

Representative Person's Name: **ERIC LU**

Signature: Eric Lu

Date: Aug. 20, 2012

## **Copyright**

© 2012 GIGA-BYTE TECHNOLOGY CO., LTD. All rights reserved.

The trademarks mentioned in this manual are legally registered to their respective owners.

## **Disclaimer**

Information in this manual is protected by copyright laws and is the property of GIGABYTE. Changes to the specifications and features in this manual may be made by GIGABYTE without prior notice.

No part of this manual may be reproduced, copied, translated, transmitted, or published in any form or by any means without GIGABYTE's prior written permission.

- In order to assist in the use of this product, carefully read the User's Manual.
- For product-related information, check on our website at: <http://www.gigabyte.com>

## **Identifying Your Motherboard Revision**

The revision number on your motherboard looks like this: "REV: X.X." For example, "REV: 1.0" means the revision of the motherboard is 1.0. Check your motherboard revision before updating motherboard BIOS, drivers, or when looking for technical information.

Example:

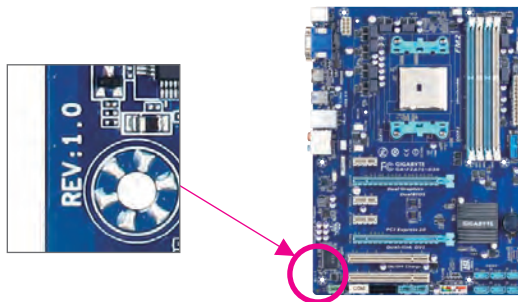

# Table of Contents

GA-F2A55M-DS2 Motherboard Layout .....	5
GA-F2A55M-DS2 Motherboard Block Diagram.....	6
Chapter 1 Hardware Installation .....	7
1-1 Installation Precautions .....	7
1-2 Product Specifications.....	8
1-3 Installing the APU.....	10
1-4 Installing the Memory .....	11
1-5 Installing an Expansion Card .....	11
1-6 Setup of the AMD Dual Graphics Configuration.....	12
1-7 Back Panel Connectors.....	13
1-8 Internal Connectors.....	14
Chapter 2 BIOS Setup .....	21
2-1 Startup Screen .....	22
2-2 The Main Menu .....	23
2-3 M.I.T. ....	25
2-4 System .....	32
2-5 BIOS Features .....	33
2-6 Peripherals .....	35
2-7 Power Management .....	38
2-8 Save & Exit.....	40
Chapter 3 Drivers Installation.....	41
Chapter 4 Appendix .....	41
Configuring SATA Hard Drive(s).....	41
Regulatory Statements.....	44

# GA-F2A55M-DS2 Motherboard Layout

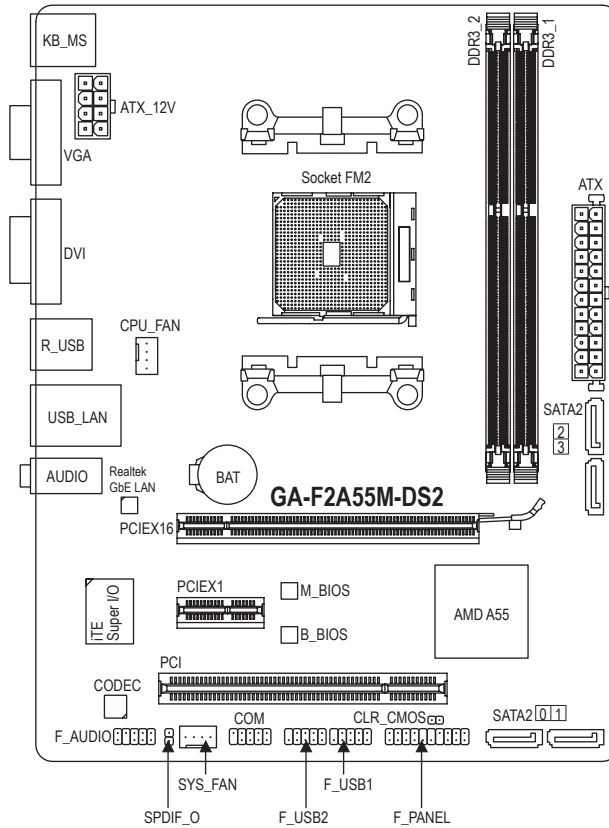

## Box Contents

- GA-F2A55M-DS2 motherboard
- Motherboard driver disk
- User's Manual
- Two SATA cables
- I/O Shield

\* The box contents above are for reference only and the actual items shall depend on the product package you obtain.

# GA-F2A55M-DS2 Motherboard Block Diagram

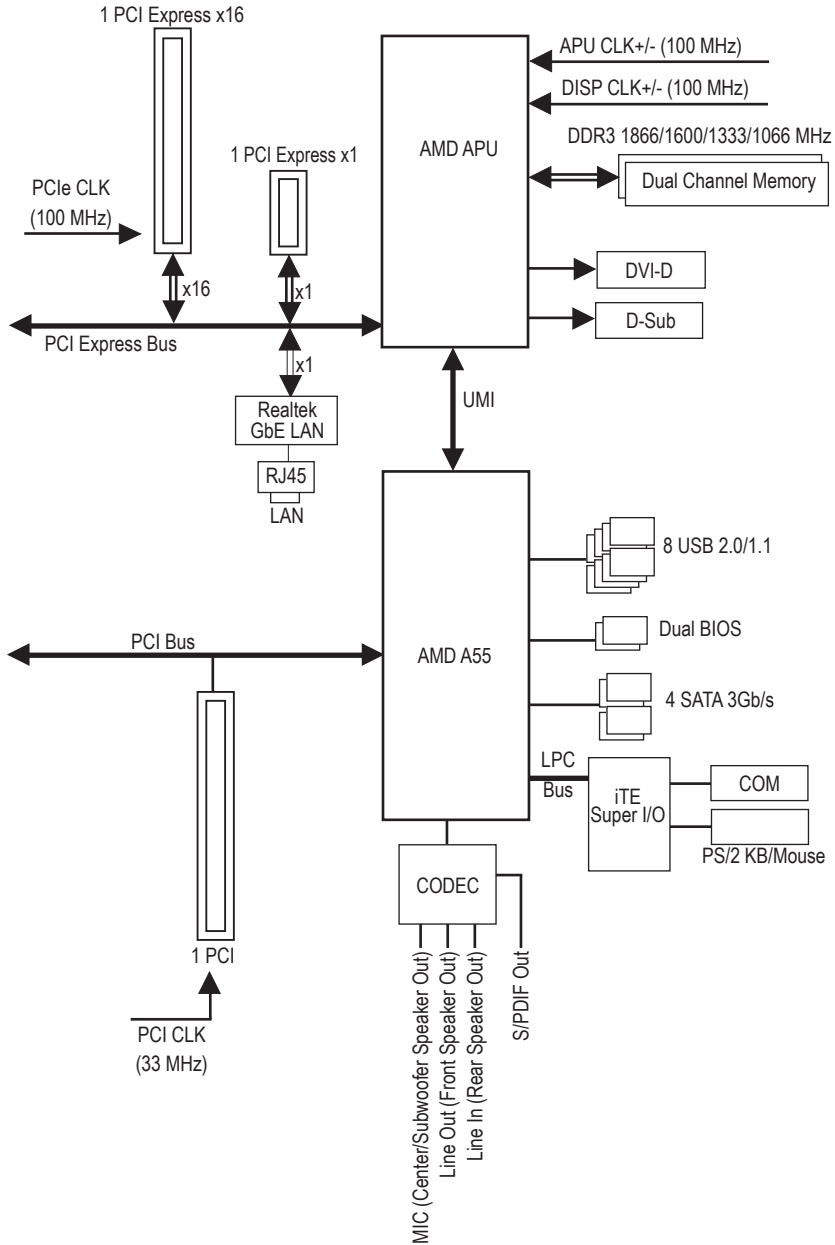

For detailed product information/limitation(s), refer to "1-2 Product Specifications."











# Chapter 1 Hardware Installation

## 1-1 Installation Precautions



The motherboard contains numerous delicate electronic circuits and components which can become damaged as a result of electrostatic discharge (ESD). Prior to installation, carefully read the user's manual and follow these procedures:

- Prior to installation, make sure the chassis is suitable for the motherboard.
- Prior to installation, do not remove or break motherboard S/N (Serial Number) sticker or warranty sticker provided by your dealer. These stickers are required for warranty validation.
- Always remove the AC power by unplugging the power cord from the power outlet before installing or removing the motherboard or other hardware components.
- When connecting hardware components to the internal connectors on the motherboard, make sure they are connected tightly and securely.
- When handling the motherboard, avoid touching any metal leads or connectors.
- It is best to wear an electrostatic discharge (ESD) wrist strap when handling electronic components such as a motherboard, APU or memory. If you do not have an ESD wrist strap, keep your hands dry and first touch a metal object to eliminate static electricity.
- Prior to installing the motherboard, please have it on top of an antistatic pad or within an electrostatic shielding container.
- Before unplugging the power supply cable from the motherboard, make sure the power supply has been turned off.
- Before turning on the power, make sure the power supply voltage has been set according to the local voltage standard.
- Before using the product, please verify that all cables and power connectors of your hardware components are connected.
- To prevent damage to the motherboard, do not allow screws to come in contact with the motherboard circuit or its components.
- Make sure there are no leftover screws or metal components placed on the motherboard or within the computer casing.
- Do not place the computer system on an uneven surface.
- Do not place the computer system in a high-temperature environment.
- Turning on the computer power during the installation process can lead to damage to system components as well as physical harm to the user.
- If you are uncertain about any installation steps or have a problem related to the use of the product, please consult a certified computer technician.

## 1-2 Product Specifications

	APU	<ul style="list-style-type: none"> <li>◆ FM2 Socket:             <ul style="list-style-type: none"> <li>- AMD A series processors</li> <li>- AMD Athlon™ series processors</li> </ul> </li> </ul> <p>(Go to GIGABYTE's website for the latest APU support list.)</p>
	Chipset	<ul style="list-style-type: none"> <li>◆ AMD A55</li> </ul>
	Memory	<ul style="list-style-type: none"> <li>◆ 2 x 1.5V DDR3 DIMM sockets supporting up to 64 GB of system memory             <ul style="list-style-type: none"> <li>* Due to a Windows 32-bit operating system limitation, when more than 4 GB of physical memory is installed, the actual memory size displayed will be less than the size of the physical memory installed.</li> <li>* The maximum 64 GB of system memory can be supported using 16 GB (or above) memory modules. GIGABYTE will update the memory support list on the official website when the memory modules are available on the market.</li> </ul> </li> <li>◆ Dual channel memory architecture</li> <li>◆ Support for DDR3 1866/1600/1333/1066 MHz memory modules</li> <li>◆ Support for AMD Memory Profile (AMP)/Extreme Memory Profile (XMP) memory modules (Go to GIGABYTE's website for the latest supported memory speeds and memory modules.)</li> </ul>
	Onboard Graphics	<ul style="list-style-type: none"> <li>◆ APU:             <ul style="list-style-type: none"> <li>* To use the onboard graphics ports, you must install an AMD APU with integrated graphics.</li> </ul> </li> <li>- 1 x D-Sub port</li> <li>- 1 x DVI-D port, supporting a maximum resolution of 2560x1600             <ul style="list-style-type: none"> <li>* Support for 2560x1600 resolution requires both a monitor and cable that support Dual Link DVI.</li> <li>* The DVI-D port does not support D-Sub connection by adapter.</li> </ul> </li> </ul>
	Audio	<ul style="list-style-type: none"> <li>◆ Realtek ALC887 codec</li> <li>◆ High Definition Audio</li> <li>◆ 2/4/5.1/7.1-channel             <ul style="list-style-type: none"> <li>* To configure 7.1-channel audio, you have to use an HD front panel audio module and enable the multi-channel audio feature through the audio driver.</li> </ul> </li> <li>◆ Support for S/PDIF Out</li> </ul>
	LAN	<ul style="list-style-type: none"> <li>◆ Realtek GbE LAN chip (10/100/1000 Mbit)</li> </ul>
	Expansion Slots	<ul style="list-style-type: none"> <li>◆ 1 x PCI Express x16 slot, running at x16</li> <li>◆ 1 x PCI Express x1 slot</li> </ul> <p>(All PCI Express slots conform to PCI Express 2.0 standard.)</p> <ul style="list-style-type: none"> <li>◆ 1 x PCI slot</li> </ul>
	Multi-Graphics Technology	<ul style="list-style-type: none"> <li>◆ Support for AMD Dual Graphics technology             <ul style="list-style-type: none"> <li>* Only A series APUs support AMD Dual Graphics.</li> </ul> </li> </ul>
	Storage Interface	<ul style="list-style-type: none"> <li>◆ Chipset:             <ul style="list-style-type: none"> <li>- 4 x SATA 3Gb/s connectors supporting up to 4 SATA 3Gb/s devices</li> <li>- Support for RAID 0, RAID 1, RAID 10, and JBOD</li> </ul> </li> </ul>
	USB	<ul style="list-style-type: none"> <li>◆ Chipset:             <ul style="list-style-type: none"> <li>- Up to 8 USB 2.0/1.1 ports (4 ports on the back panel, 4 ports available through the internal USB headers)</li> </ul> </li> </ul>

	Internal Connectors	<ul style="list-style-type: none"> <li>◆ 1 x 24-pin ATX main power connector</li> <li>◆ 1 x 8-pin ATX 12V power connector</li> <li>◆ 4 x SATA 3Gb/s connectors</li> <li>◆ 1 x APU fan header</li> <li>◆ 1 x system fan header</li> <li>◆ 1 x front panel header</li> <li>◆ 1 x front panel audio header</li> <li>◆ 1 x S/PDIF Out header</li> <li>◆ 2 x USB 2.0/1.1 headers</li> <li>◆ 1 x serial port header</li> <li>◆ 1 x Clear CMOS jumper</li> </ul>
	Back Panel Connectors	<ul style="list-style-type: none"> <li>◆ 1 x PS/2 keyboard port</li> <li>◆ 1 x PS/2 mouse port</li> <li>◆ 1 x D-Sub port</li> <li>◆ 1 x DVI-D port</li> <li>◆ 4 x USB 2.0/1.1 ports</li> <li>◆ 1 x RJ-45 port</li> <li>◆ 3 x audio jacks (Line In/Line Out/Microphone)</li> </ul>
	I/O Controller	<ul style="list-style-type: none"> <li>◆ iTE I/O Controller Chip</li> </ul>
	Hardware Monitor	<ul style="list-style-type: none"> <li>◆ System voltage detection</li> <li>◆ APU/System temperature detection</li> <li>◆ APU/System fan speed detection</li> <li>◆ APU overheating warning</li> <li>◆ APU/System fan fail warning</li> <li>◆ APU/System fan speed control <ul style="list-style-type: none"> <li>* Whether the APU/system fan speed control function is supported will depend on the APU/system cooler you install.</li> </ul> </li> </ul>
	BIOS	<ul style="list-style-type: none"> <li>◆ 2 x 32 Mbit flash</li> <li>◆ Use of licensed AMI EFI BIOS</li> <li>◆ Support for DualBIOS™</li> <li>◆ PnP 1.0a, DMI 2.0, SM BIOS 2.6, ACPI 2.0a</li> </ul>
	Unique Features	<ul style="list-style-type: none"> <li>◆ Support for @BIOS</li> <li>◆ Support for Q-Flash</li> <li>◆ Support for Xpress Install</li> <li>◆ Support for EasyTune <ul style="list-style-type: none"> <li>* Available functions in EasyTune may differ by motherboard model.</li> </ul> </li> <li>◆ Support for Smart Recovery 2</li> <li>◆ Support for Auto Green</li> <li>◆ Support for ON/OFF Charge</li> <li>◆ Support for 3TB+ Unlock</li> <li>◆ Support for Q-Share</li> </ul>

 Bundled Software	◆ Norton Internet Security (OEM version)
 Operating System	◆ Support for Microsoft® Windows 8/7/Vista/XP
 Form Factor	◆ Micro ATX Form Factor; 22.5cm x 17.4cm

\* GIGABYTE reserves the right to make any changes to the product specifications and product-related information without prior notice.

\* Please visit GIGABYTE's website to check the supported operating system(s) for the software listed in the "Unique Features" and "Bundled Software" columns.

## 1-3 Installing the APU



Read the following guidelines before you begin to install the APU:

- Make sure that the motherboard supports the APU.  
(Go to GIGABYTE's website for the latest APU support list.)
- Always turn off the computer and unplug the power cord from the power outlet before installing the APU to prevent hardware damage.
- Locate the pin one of the APU. The APU cannot be inserted if oriented incorrectly.
- Apply an even and thin layer of thermal grease on the surface of the APU.
- Do not turn on the computer if the APU cooler is not installed, otherwise overheating and damage of the APU may occur.
- Set the APU host frequency in accordance with the APU specifications. It is not recommended that the system bus frequency be set beyond hardware specifications since it does not meet the standard requirements for the peripherals. If you wish to set the frequency beyond the standard specifications, please do so according to your hardware specifications including the APU, graphics card, memory, hard drive, etc.

### Installing the APU

Locate the pin one (denoted by a small triangle) of the APU socket and the APU.

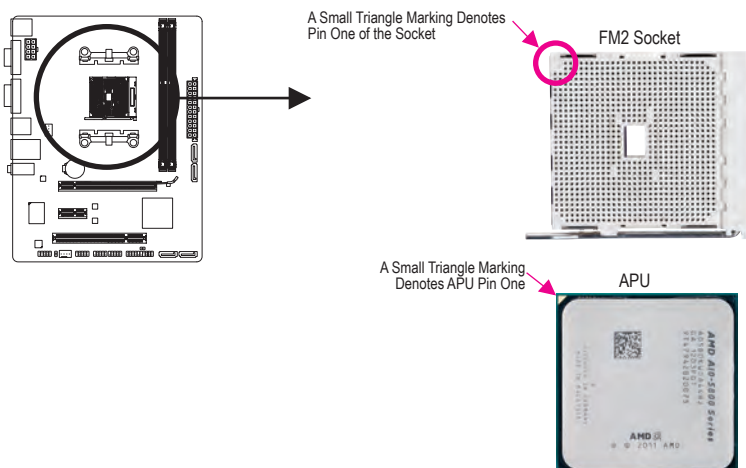

## 1-4 Installing the Memory



Read the following guidelines before you begin to install the memory:

- Make sure that the motherboard supports the memory. It is recommended that memory of the same capacity, brand, speed, and chips be used. (Go to GIGABYTE's website for the latest supported memory speeds and memory modules.)
- Always turn off the computer and unplug the power cord from the power outlet before installing the memory to prevent hardware damage.
- Memory modules have a foolproof design. A memory module can be installed in only one direction. If you are unable to insert the memory, switch the direction.

### Dual Channel Memory Configuration

This motherboard provides two DDR3 memory sockets and supports Dual Channel Technology. After the memory is installed, the BIOS will automatically detect the specifications and capacity of the memory. Enabling Dual Channel memory mode will double the original memory bandwidth.

The two DDR3 memory sockets are divided into two channels and each channel has one memory socket as following:

▶▶ Channel 0: DDR3\_2

▶▶ Channel 1: DDR3\_1

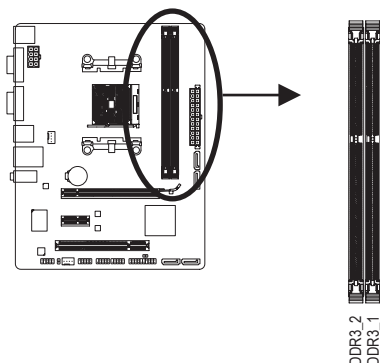

Due to APU limitations, read the following guidelines before installing the memory in Dual Channel mode.

1. Dual Channel mode cannot be enabled if only one DDR3 memory module is installed.
2. When enabling Dual Channel mode with two memory modules, it is recommended that memory of the same capacity, brand, speed, and chips be used for optimum performance.

## 1-5 Installing an Expansion Card



Read the following guidelines before you begin to install an expansion card:

- Make sure the motherboard supports the expansion card. Carefully read the manual that came with your expansion card.
- Always turn off the computer and unplug the power cord from the power outlet before installing an expansion card to prevent hardware damage.

## 1-6 Setup of the AMD Dual Graphics Configuration

Combining the onboard GPU with a discrete graphics card, AMD's Dual Graphics technology can provide significantly advanced display performance for AMD platform. Read the following instructions on configuring a Dual Graphics system.

### A. System Requirements

- AMD A series processor
- Windows 7 operating system
- An AMD Dual Graphics technology-supported motherboard (with the BIOS updated to the latest version) and correct driver (make sure the onboard graphics driver version is Rev. 8.981 or above)
- An AMD Radeon HD 6000 series graphics card that supports AMD Dual Graphics technology (for more details, please visit AMD's official website) and correct driver

### B. Installing the Graphics Cards and Configuring BIOS Setup

Step 1:

Observe the steps in "1-5 Installing an Expansion Card" and install an AMD Dual Graphics technology-supported graphics card on the PCIEX16 slot. Plug the monitor cable into the graphics card and start up your computer.

Step 2:

Enter BIOS Setup to set the following items under the **Peripherals\GFX Configuration** menu:

- Set **Integrated Graphics** to **Force**.
- Set **UMA Frame Buffer Size** to **512M** or above.

Save the settings and exit BIOS Setup. Restart your computer.

### C. Configuring the Graphics Card Driver

After installing the graphics card driver in the operating system, go to the **AMD VISION Engine Control Center**. Browse to **Performance\AMD CrossFire™** and ensure the **Enable CrossFire™** check box is selected.



(Note) Make sure the drivers for the Chipset, onboard graphics, and external graphics card are properly installed.

## 1-7 Back Panel Connectors

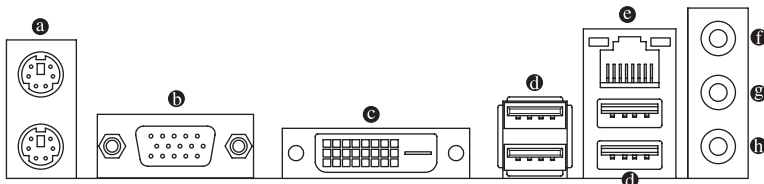

### a PS/2 Keyboard and PS/2 Mouse Port

Use the upper port (green) to connect a PS/2 mouse and the lower port (purple) to connect a PS/2 keyboard.

### b D-Sub Port

The D-Sub port supports a 15-pin D-Sub connector. Connect a monitor that supports D-Sub connection to this port.

### c DVI-D Port (Note)

The DVI-D port conforms to the DVI-D specification and supports a maximum resolution of 2560x1600. Connect a monitor that supports DVI-D connection to this port. Please note that the actual resolutions supported are dependent on the monitor being used and support for 2560x1600 resolution requires both a monitor and cable that support Dual Link DVI.

### d USB 2.0/1.1 Port

The USB port supports the USB 2.0/1.1 specification. Use this port for USB devices such as a USB keyboard/mouse, USB printer, USB flash drive and etc.

### e RJ-45 LAN Port

The Gigabit Ethernet LAN port provides Internet connection at up to 1 Gbps data rate. The following describes the states of the LAN port LEDs.

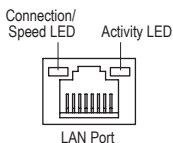

Connection/Speed LED:

State	Description
Orange	1 Gbps data rate
Green	100 Mbps data rate
Off	10 Mbps data rate

Activity LED:

State	Description
Blinking	Data transmission or receiving is occurring
Off	No data transmission or receiving is occurring

### f Line In Jack (Blue)

The default line in jack. Use this audio jack for line in devices such as an optical drive, walkman, etc.

### g Line Out Jack (Green)

The default line out jack. Use this audio jack for a headphone or 2-channel speaker. This jack can be used to connect front speakers in a 4/5.1/7.1-channel audio configuration.

### h Mic In Jack (Pink)

The default Mic in jack. Microphones must be connected to this jack.



To configure 7.1-channel audio, you have to use an HD front panel audio module and enable the multi-channel audio feature through the audio driver.



- When removing the cable connected to a back panel connector, first remove the cable from your device and then remove it from the motherboard.
- When removing the cable, pull it straight out from the connector. Do not rock it side to side to prevent an electrical short inside the cable connector.

(Note) The DVI-D port does not support D-Sub connection by adapter.

## 1-8 Internal Connectors

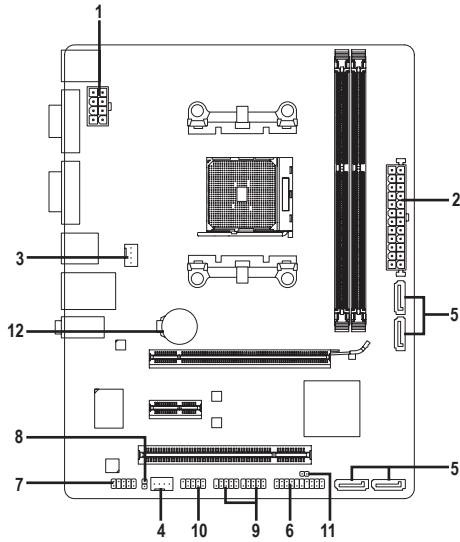

1) ATX_12V	7) F_AUDIO
2) ATX	8) SPDIF_O
3) CPU_FAN	9) F_USB1/F_USB2
4) SYS_FAN	10) COM
5) SATA2 0/1/2/3	11) CLR_CMOS
6) F_PANEL	12) BAT



Read the following guidelines before connecting external devices:

- First make sure your devices are compliant with the connectors you wish to connect.
- Before installing the devices, be sure to turn off the devices and your computer. Unplug the power cord from the power outlet to prevent damage to the devices.
- After installing the device and before turning on the computer, make sure the device cable has been securely attached to the connector on the motherboard.

## 1/2) ATX\_12V/ATX (2x4 12V Power Connector and 2x12 Main Power Connector)

With the use of the power connector, the power supply can supply enough stable power to all the components on the motherboard. Before connecting the power connector, first make sure the power supply is turned off and all devices are properly installed. The power connector possesses a foolproof design. Connect the power supply cable to the power connector in the correct orientation.

The 12V power connector mainly supplies power to the APU. If the 12V power connector is not connected, the computer will not start.



To meet expansion requirements, it is recommended that a power supply that can withstand high power consumption be used (500W or greater). If a power supply is used that does not provide the required power, the result can lead to an unstable or unbootable system.

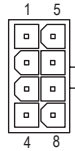
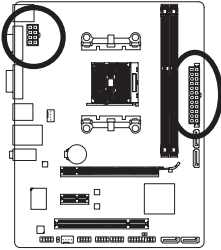

ATX\_12V

ATX\_12V:

Pin No.	Definition
1	GND (Only for 2x4-pin 12V)
2	GND (Only for 2x4-pin 12V)
3	GND
4	GND
5	+12V (Only for 2x4-pin 12V)
6	+12V (Only for 2x4-pin 12V)
7	+12V
8	+12V

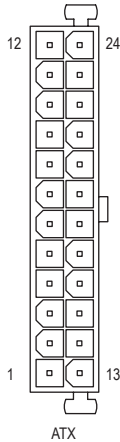

ATX

ATX:

Pin No.	Definition	Pin No.	Definition
1	3.3V	13	3.3V
2	3.3V	14	-12V
3	GND	15	GND
4	+5V	16	PS_ON (soft On/Off)
5	GND	17	GND
6	+5V	18	GND
7	GND	19	GND
8	Power Good	20	-5V
9	5VSB (stand by +5V)	21	+5V
10	+12V	22	+5V
11	+12V (Only for 2x12-pin ATX)	23	+5V (Only for 2x12-pin ATX)
12	3.3V (Only for 2x12-pin ATX)	24	GND (Only for 2x12-pin ATX)

### 3/4) CPU\_FAN/SYS\_FAN (Fan Headers)

All fan headers on this motherboard are 4-pin. Most fan headers possess a foolproof insertion design. When connecting a fan cable, be sure to connect it in the correct orientation (the black connector wire is the ground wire). The motherboard supports APU fan speed control, which requires the use of a APU fan with fan speed control design. For optimum heat dissipation, it is recommended that a system fan be installed inside the chassis.

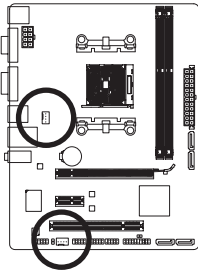

CPU\_FAN



SYS\_FAN

Pin No.	Definition
1	GND
2	+12V
3	Sense
4	Speed Control



- Be sure to connect fan cables to the fan headers to prevent your APU and system from overheating. Overheating may result in damage to the APU or the system may hang.
- These fan headers are not configuration jumper blocks. Do not place a jumper cap on the headers.

### 5) SATA2 0/1/2/3 (SATA 3Gb/s Connectors)

The SATA connectors conform to SATA 3Gb/s standard and are compatible with SATA 1.5Gb/s standard. Each SATA connector supports a single SATA device. The AMD A55 Chipset supports RAID 0, RAID 1, RAID 10, and JBOD. Refer to Chapter 4, "Configuring SATA Hard Drive(s)," for instructions on configuring a RAID array.

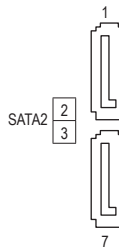
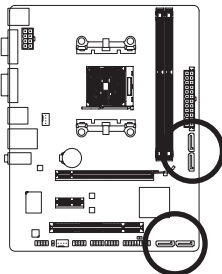

Pin No.	Definition
1	GND
2	TXP
3	TXN
4	GND
5	RXN
6	RXP
7	GND

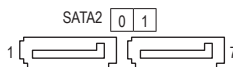

- A RAID 0 or RAID 1 configuration requires at least two hard drives. If more than two hard drives are to be used, the total number of hard drives must be an even number.
- A RAID 10 configuration requires four hard drives.

## 6) F\_PANEL (Front Panel Header)

Connect the power switch, reset switch, speaker, and system status indicator on the chassis to this header according to the pin assignments below. Note the positive and negative pins before connecting the cables.

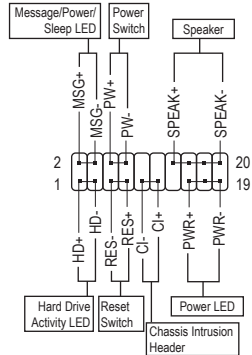
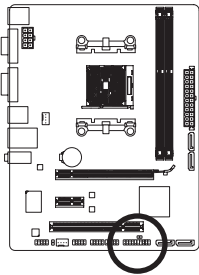

- **MSG/PWR** (Message/Power/Sleep LED):

System Status	LED
S0	On
S3/S4/S5	Off

Connects to the power status indicator on the chassis front panel. The LED is on when the system is operating. The LED is off when the system is in S3/S4 sleep state or powered off (S5).

- **PW** (Power Switch):  
Connects to the power switch on the chassis front panel. You may configure the way to turn off your system using the power switch (refer to Chapter 2, "BIOS Setup," "Power Management," for more information).
- **Speaker** (Speaker):  
Connects to the speaker on the chassis front panel. The system reports system startup status by issuing a beep code. One single short beep will be heard if no problem is detected at system startup.
- **HD** (Hard Drive Activity LED):  
Connects to the hard drive activity LED on the chassis front panel. The LED is on when the hard drive is reading or writing data.
- **RES** (Reset Switch):  
Connects to the reset switch on the chassis front panel. Press the reset switch to restart the computer if the computer freezes and fails to perform a normal restart.
- **CI** (Chassis Intrusion Header):  
Connects to the chassis intrusion switch/sensor on the chassis that can detect if the chassis cover has been removed. This function requires a chassis with a chassis intrusion switch/sensor.



The front panel design may differ by chassis. A front panel module mainly consists of power switch, reset switch, power LED, hard drive activity LED, speaker and etc. When connecting your chassis front panel module to this header, make sure the wire assignments and the pin assignments are matched correctly.

## 7) F\_AUDIO (Front Panel Audio Header)

The front panel audio header supports Intel High Definition audio (HD) and AC'97 audio. You may connect your chassis front panel audio module to this header. Make sure the wire assignments of the module connector match the pin assignments of the motherboard header. Incorrect connection between the module connector and the motherboard header will make the device unable to work or even damage it.

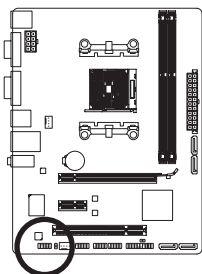

For HD Front Panel Audio:

Pin No.	Definition
1	MIC2_L
2	GND
3	MIC2_R
4	-ACZ_DET
5	LINE2_R
6	GND
7	FAUDIO_JD
8	No Pin
9	LINE2_L
10	GND

For AC'97 Front Panel Audio:

Pin No.	Definition
1	MIC
2	GND
3	MIC Power
4	NC
5	Line Out (R)
6	NC
8	No Pin
9	Line Out (L)
10	NC



- The front panel audio header supports HD audio by default.
- Audio signals will be present on both of the front and back panel audio connections simultaneously.
- Some chassis provide a front panel audio module that has separated connectors on each wire instead of a single plug. For information about connecting the front panel audio module that has different wire assignments, please contact the chassis manufacturer.

## 8) SPDIF\_O (S/PDIF Out Header)

This header supports digital S/PDIF Out and connects a S/PDIF digital audio cable (provided by expansion cards) for digital audio output from your motherboard to certain expansion cards like graphics cards and sound cards. For example, some graphics cards may require you to use a S/PDIF digital audio cable for digital audio output from your motherboard to your graphics card if you wish to connect an HDMI display to the graphics card and have digital audio output from the HDMI display at the same time.

For information about connecting the S/PDIF digital audio cable, carefully read the manual for your expansion card.

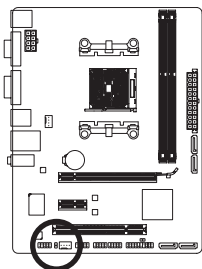

Pin No.	Definition
1	SPDIFO
2	GND

### 9) F\_USB1/F\_USB2 (USB 2.0/1.1 Headers)

The headers conform to USB 2.0/1.1 specification. Each USB header can provide two USB ports via an optional USB bracket. For purchasing the optional USB bracket, please contact the local dealer.

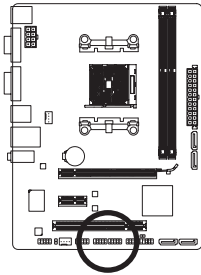

Pin No.	Definition
1	Power (5V)
2	Power (5V)
3	USB DX-
4	USB DY-
5	USB DX+
6	USB DY+
7	GND
8	GND
9	No Pin
10	NC



- Do not plug the IEEE 1394 bracket (2x5-pin) cable into the USB header.
- Prior to installing the USB bracket, be sure to turn off your computer and unplug the power cord from the power outlet to prevent damage to the USB bracket.

### 10) COM (Serial Port Header)

The COM header can provide one serial port via an optional COM port cable. For purchasing the optional COM port cable, please contact the local dealer.

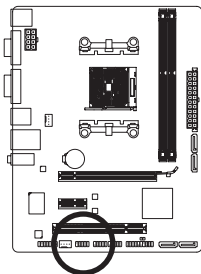

Pin No.	Definition
1	NDCD-
2	NSIN
3	NSOUT
4	NDTR-
5	GND
6	NDSR-
7	NRTS-
8	NCTS-
9	NRI-
10	No Pin

## 11) CLR\_CMOS (Clear CMOS Jumper)

Use this jumper to clear the CMOS values (e.g. date information and BIOS configurations) and reset the CMOS values to factory defaults. To clear the CMOS values, use a metal object like a screwdriver to touch the two pins for a few seconds.

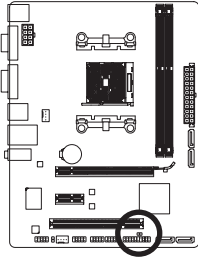

 Open: Normal

 Short: Clear CMOS Values



- Always turn off your computer and unplug the power cord from the power outlet before clearing the CMOS values.
- After system restart, go to BIOS Setup to load factory defaults (select Load Optimized Defaults) or manually configure the BIOS settings (refer to Chapter 2, "BIOS Setup," for BIOS configurations).

## 12) BAT (Battery)

The battery provides power to keep the values (such as BIOS configurations, date, and time information) in the CMOS when the computer is turned off. Replace the battery when the battery voltage drops to a low level, or the CMOS values may not be accurate or may be lost.

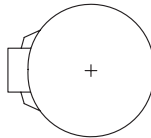
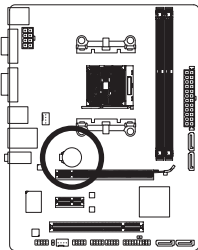

You may clear the CMOS values by removing the battery:

1. Turn off your computer and unplug the power cord.
2. Gently remove the battery from the battery holder and wait for one minute.  
(Or use a metal object like a screwdriver to touch the positive and negative terminals of the battery holder, making them short for 5 seconds.)
3. Replace the battery.
4. Plug in the power cord and restart your computer.



- Always turn off your computer and unplug the power cord before replacing the battery.
- Replace the battery with an equivalent one. Danger of explosion if the battery is replaced with an incorrect model.
- Contact the place of purchase or local dealer if you are not able to replace the battery by yourself or uncertain about the battery model.
- When installing the battery, note the orientation of the positive side (+) and the negative side (-) of the battery (the positive side should face up).
- Used batteries must be handled in accordance with local environmental regulations.

## Chapter 2 BIOS Setup

BIOS (Basic Input and Output System) records hardware parameters of the system in the CMOS on the motherboard. Its major functions include conducting the Power-On Self-Test (POST) during system startup, saving system parameters and loading operating system, etc. BIOS includes a BIOS Setup program that allows the user to modify basic system configuration settings or to activate certain system features.

When the power is turned off, the battery on the motherboard supplies the necessary power to the CMOS to keep the configuration values in the CMOS.

To access the BIOS Setup program, press the <Delete> key during the POST when the power is turned on.

To upgrade the BIOS, use either the GIGABYTE Q-Flash or @BIOS utility.

- Q-Flash allows the user to quickly and easily upgrade or back up BIOS without entering the operating system.
- @BIOS is a Windows-based utility that searches and downloads the latest version of BIOS from the Internet and updates the BIOS.

For instructions on using the Q-Flash and @BIOS utilities, refer to Chapter 4, "BIOS Update Utilities."



- Because BIOS flashing is potentially risky, if you do not encounter problems using the current version of BIOS, it is recommended that you not flash the BIOS. To flash the BIOS, do it with caution. Inadequate BIOS flashing may result in system malfunction.
- It is recommended that you not alter the default settings (unless you need to) to prevent system instability or other unexpected results. Inadequately altering the settings may result in system's failure to boot. If this occurs, try to clear the CMOS values and reset the board to default values. (Refer to the "Load Optimized Defaults" section in this chapter or introductions of the battery or the clear CMOS jumper in Chapter 1 for how to clear the CMOS values.)

## 2-1 Startup Screen

The following startup Logo screen will appear when the computer boots.



### Function Keys:

#### <DEL>: BIOS SETUP/Q-FLASH

Press the <Delete> key to enter BIOS Setup or to access the Q-Flash utility in BIOS Setup.

#### <F9>: SYSTEM INFORMATION

Press the <F9> key to display your system information.

#### <F12>: BOOT MENU

Boot Menu allows you to set the first boot device without entering BIOS Setup. In Boot Menu, use the up arrow key <↑> or the down arrow key <↓> to select the first boot device, then press <Enter> to accept. The system will boot from the device immediately.

Note: The setting in Boot Menu is effective for one time only. After system restart, the device boot order will still be based on BIOS Setup settings.

#### <END>: Q-FLASH

Press the <End> key to access the Q-Flash utility directly without having to enter BIOS Setup first.

## 2-2 The Main Menu

### A. The 3D BIOS Screen (Default)

On GIGABYTE's uniquely designed 3D BIOS screen, you can use your mouse to move through the motherboard image and click to enter the function menu in each area for quick configuration. For example, pass your mouse arrow over the CPU and memory sockets and enter the **System Tuning** menu to configure CPU/memory frequency, memory timings, and voltage settings. For more detailed configuration items, you can click the function menu icons at the bottom of the screen or press <F1> to switch to the main menu of the BIOS Setup program. (If a mouse is not connected, the 3D BIOS screen will automatically switch to the main menu of the BIOS Setup Program.)



### B. The Main Menu of the BIOS Setup Program

On the main menu of the BIOS Setup program, press arrow keys to move among the items and press <Enter> to accept or enter a sub-menu. Or you can use your mouse to select the item you want.

(Sample BIOS Version: F1b)

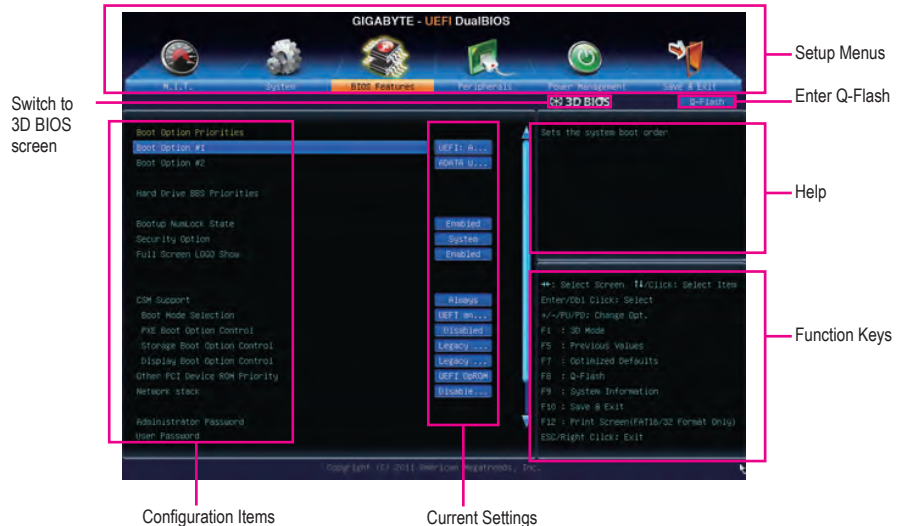

## BIOS Setup Program Function Keys

<<-><->>	Move the selection bar to select a setup menu
<↑><↓>	Move the selection bar to select an configuration item on a menu
<Enter>	Execute command or enter a menu
<+>/<Page Up>	Increase the numeric value or make changes
<->/<Page Down>	Decrease the numeric value or make changes
<F1>	Switch to 3D BIOS screen
<F5>	Restore the previous BIOS settings for the current submenus
<F7>	Load the Optimized BIOS default settings for the current submenus
<F8>	Access the Q-Flash utility
<F9>	Display system information
<F10>	Save all the changes and exit the BIOS Setup program
<F12>	Capture the current screen as an image and save it to your USB drive
<Esc>	Main Menu: Exit the BIOS Setup program Submenus: Exit current submenu

## BIOS Setup Menus

### ■ M.I.T.

Use this menu to configure the clock, frequency, and voltages of your CPU and memory, etc. Or check the system/CPU temperatures, voltages, and fan speeds.

### ■ System

Use this menu to configure the default language used by the BIOS and system time and date. This menu also displays information on the devices connected to the SATA ports.

### ■ BIOS Features

Use this menu to configure the device boot order, advanced features available on the CPU, and the primary display adapter.

### ■ Peripherals

Use this menu to configure all peripheral devices, such as SATA, USB, integrated audio, and integrated LAN, etc.

### ■ Power Management

Use this menu to configure all the power-saving functions.

### ■ Save & Exit

Save all the changes made in the BIOS Setup program to the CMOS and exit BIOS Setup. You can save the current BIOS settings to a profile or load optimized defaults for optimal-performance system operations.



- When the system is not stable as usual, select the **Load Optimized Defaults** item to set your system to its defaults.
- The BIOS Setup menus described in this chapter are for reference only and may differ by BIOS version.

## 2-3 M.I.T.



Whether the system will work stably with the overclock/overvoltage settings you made is dependent on your overall system configurations. Incorrectly doing overclock/overvoltage may result in damage to CPU, chipset, or memory and reduce the useful life of these components. This page is for advanced users only and we recommend you not to alter the default settings to prevent system instability or other unexpected results. (Inadequately altering the settings may result in system's failure to boot. If this occurs, clear the CMOS values and reset the board to default values.)



This section provides information on the BIOS version, CPU base clock, CPU frequency, memory frequency, total memory size, CPU temperature, Vcore, and memory voltage.

▶ **M.I.T. Current Status**

This screen provides information on CPU/memory frequencies/parameters.

▶ **Advanced Frequency Settings**



☞ **BCLK/PCIE Clock Control**

Allows you to manually set the CPU base clock and PCIe bus frequency in 1 MHz increments. (Default: Auto)

**Important:** It is highly recommended that the CPU frequency be set in accordance with the CPU specifications.

☞ **Processor Graphics Clock**

Allows you to set the onboard graphics clock. The adjustable range is from 300 MHz to 2000 MHz.

☞ **NB Clock Control**

Enables or disables the control of CPU North Bridge frequency. (Default: Auto)

☞ **NB Clock (Mhz)**

Allows you to manually set the CPU North Bridge frequency. The adjustable range is from 800 MHz to 6000 MHz. This item is configurable only when **NB Clock Control** is set to **Manual**.

☞ **CPU Clock Ratio**

Allows you to alter the clock ratio for the installed CPU. The adjustable range is dependent on the CPU being installed.

☞ **CPU Frequency**

Displays the current operating CPU frequency.

## ▶ Advanced CPU Core Features



### ☞ CPU Clock Ratio, CPU Frequency

The settings above are synchronous to those under the same items on the **Advanced Frequency Settings** menu.

### ☞ Core Performance Boost <sup>(Note)</sup>

Allows you to determine whether to enable the Core Performance Boost (CPB) technology, a CPU performance-boost technology. (Default: Enabled) (Default: Auto)

### ☞ CPB Ratio <sup>(Note)</sup>

Allows you alter the ratio for the CPB. The adjustable range is dependent on the CPU being installed. (Default: Auto)

### ☞ Cool&Quiet

- ▶▶ Enabled Lets the AMD Cool'n'Quiet driver dynamically adjust the CPU clock and VID to reduce heat output from your computer and its power consumption. (Default)
- ▶▶ Disabled Disables this function.

### ☞ SVM Mode

Virtualization enhanced by Virtualization Technology will allow a platform to run multiple operating systems and applications in independent partitions. With virtualization, one computer system can function as multiple virtual systems. (Default: Enabled)

### ☞ C6 Mode

Allows you to determine whether to let the CPU enter C6 mode in system halt state. When enabled, the CPU core frequency will be reduced during system halt state to decrease power consumption. The C6 state is a more enhanced power-saving state than C1. (Default: Enabled)

### ☞ C1E SUPPORT

Allows you to determine whether to let the CPU enter C1 mode in system halt state. When enabled, the CPU core frequency and voltage will be reduced during system halt state to decrease power consumption. (Default: Disabled)

(Note) This item is present only when you install a CPU that supports this feature.

➤ **AMD Memory Profile (A.M.P.)** <sup>(Note)</sup>

Allows the BIOS to read the SPD data on AMP memory module(s) to enhance memory performance when enabled.

- Disabled Disables this function. (Default)
- Profile1 Uses Profile 1 settings.
- Profile2 <sup>(Note)</sup> Uses Profile 2 settings.

➤ **System Memory Multiplier**

Allows you to set the system memory multiplier. **Auto** sets memory multiplier according to memory SPD data. (Default: Auto)

➤ **Memory Frequency (MHz)**

This value is automatically adjusted according to the **BCLK/PCIe Clock Control** and **System Memory Multiplier** settings.

▶ **Advanced Memory Settings**



➤ **AMD Memory Profile (A.M.P.)** <sup>(Note)</sup>, **System Memory Multiplier**, **Memory Frequency(MHz)**

The settings above are synchronous to those under the same items on the **Advanced Frequency Settings** menu.

➤ **DRAM Timing Selectable**

**Quick** and **Expert** allows the memory timing settings below to be configurable. Options are: Auto (default), Quick, Expert.

➤ **Profile DDR Voltage**

When using a non-AMP memory module or **AMD Memory Profile (A.M.P.)** is set to **Disabled**, this item will display as **1.50V**. When **AMD Memory Profile (A.M.P.)** is set to **Profile1** or **Profile2**, this item will display the value based on the SPD data on the AMP memory.

(Note) This item is present only when you install a memory module that supports this feature.

🔗 **Profile VTT Voltage**

The value displayed here is dependent on the CPU being used.

🔗 **Rank Interleaving**

Enables or disables memory rank interleaving. **Enabled** allows the system to simultaneously access different ranks of the memory to increase memory performance and stability. (Default: Enabled)

🔗 **Channel Interleaving**

Enables or disables memory channel interleaving. **Enabled** allows the system to simultaneously access different channels of the memory to increase memory performance and stability. (Default: Enabled)

▶ **Channel A/B Timing Settings**



This sub-menu provides memory timing settings for each channel of memory. The respective timing setting screens are configurable only when **DRAM Timing Selectable** is set to **Quick** or **Expert**. Note: Your system may become unstable or fail to boot after you make changes on the memory timings. If this occurs, please reset the board to default values by loading optimized defaults or clearing the CMOS values.

## ▶ Advanced Voltage Settings



This sub-menu allows you to set CPU, Chipset, and memory voltages.

## ▶ PC Health Status



### ☞ Reset Case Open Status

- ▶▶ Disabled Keeps or clears the record of previous chassis intrusion status. (Default)
- ▶▶ Enabled Clears the record of previous chassis intrusion status and the **Case Open** field will show "No" at next boot.

### ☞ **Case Open**

Displays the detection status of the chassis intrusion detection device attached to the motherboard CI header. If the system chassis cover is removed, this field will show "Yes", otherwise it will show "No". To clear the chassis intrusion status record, set **Reset Case Open Status** to **Enabled**, save the settings to the CMOS, and then restart your system.

### ☞ **CPU Vcore/Dram Voltage/+3.3V/+5V/+12V**

Displays the current system voltages.

### ☞ **CPU/System Temperature**

Displays current CPU/system temperature.

### ☞ **CPU/System FAN Speed**

Displays current CPU/system fan speeds.

### ☞ **CPU Warning Temperature**

Sets the warning threshold for CPU temperature. When CPU temperature exceeds the threshold, BIOS will emit warning sound. Options are: Disabled (default), 60°C/140°F, 70°C/158°F, 80°C/176°F, 90°C/194°F.

### ☞ **CPU/System Fan Fail Warning**

Allows the system to emit warning sound if the CPU fan or system fan are not connected or fail. Check the fan condition or fan connection when this occurs. (Default: Disabled)

### ☞ **CPU Fan Speed Control**

Allows you to determine whether to enable the CPU fan speed control function and adjust the fan speed.

- ▶▶ Normal Allows the CPU fan to run at different speeds according to the CPU temperature. You can adjust the fan speed with EasyTune based on your system requirements. (Default)
- ▶▶ Silent Allows the CPU fan to run at slow speeds.
- ▶▶ Manual Allows you to control the CPU fan speed under the **Slope PWM** item.
- ▶▶ Disabled Allows the CPU fan to run at full speeds.

### ☞ **Slope PWM**

Allows you to control the CPU fan speed. This item is configurable only when **CPU Fan Speed Control** is set to **Manual**. Options are: 0.75 PWM value /°C ~ 2.50 PWM value /°C.

### ☞ **System Fan Speed Control**

Allows you to determine whether to enable the system fan speed control function and adjust the fan speed.

- ▶▶ Normal Allows the system fan to run at different speeds according to the system temperature. You can adjust the fan speed with EasyTune based on your system requirements. (Default)
- ▶▶ Silent Allows the system fan to run at slow speeds.
- ▶▶ Manual Allows you to control the system fan speed under the **Slope PWM** item.
- ▶▶ Disabled Allows the system fan to run at full speeds.

### ☞ **Slope PWM**

Allows you to control the system fan speed. This item is configurable only when **System Fan Speed Control** is set to **Manual**. Options are: 0.75 PWM value /°C ~ 2.50 PWM value /°C.

## 2-4 System



This section provides information on your CPU, memory, motherboard model, and BIOS version. You can also select the default language used by the BIOS and manually set the system time.

### System Language

Selects the default language used by the BIOS.

### System Date

Sets the system date. The date format is week (read-only), month, date, and year. Use <Enter> to switch between the Month, Date, and Year fields and use the <Page Up> or <Page Down> key to set the desired value.

### System Time

Sets the system time. The time format is hour, minute, and second. For example, 1 p.m. is 13:0:0. Use <Enter> to switch between the Hour, Minute, and Second fields and use the <Page Up> or <Page Down> key to set the desired value.

### Access Level

Displays the current access level depending on the type of password protection used. (If no password is set, the default will display as Administrator.) The Administrator level allows you to make changes to all BIOS settings; the User level only allows you to make changes to certain BIOS settings but not all.

### ATA Port Information

This section provides information on the device connected to each SATA port controlled by AMD Chipset.

## 2-5 BIOS Features



### Boot Option Priorities

Specifies the overall boot order from the available devices. For example, you can set hard drive as the first priority (**Boot Option #1**) and DVD ROM drive as the second priority (**Boot Option #2**). The list only displays the device with the highest priority for a specific type. For example, only hard drive defined as the first priority on the **Hard Drive BBS Priorities** submenu will be presented here.

Removable storage devices that support GPT format will be prefixed with "UEFI:" string on the boot device list. To boot from an operating system that supports GPT partitioning, select the device prefixed with "UEFI:" string.

Or if you want to install an operating system that supports GPT partitioning such as Windows 7 64-bit, select the optical drive that contains the Windows 7 64-bit installation disk and is prefixed with "UEFI:" string.

### Hard Drive/CD/DVD ROM Drive/Floppy Drive/Network Device BBS Priorities

Specifies the boot order for a specific device type, such as hard drives, optical drives, floppy disk drives, and devices that support Boot from LAN function, etc. Press <Enter> on this item to enter the submenu that presents the devices of the same type that are connected. This item is present only if at least one device for this type is installed.

### Bootup NumLock State

Enables or disables Numlock feature on the numeric keypad of the keyboard after the POST. (Default: Enabled)

### Security Option

Specifies whether a password is required every time the system boots, or only when you enter BIOS Setup. After configuring this item, set the password(s) under the **Administrator Password/User Password** item.

- ▶▶ Setup            A password is only required for entering the BIOS Setup program. (Default)
- ▶▶ System          A password is required for booting the system and for entering the BIOS Setup program.

### ☞ Full Screen LOGO Show

Allows you to determine whether to display the GIGABYTE Logo at system startup. **Disabled** skips the GIGABYTE Logo when the system starts up. (Default: Enabled)

### ☞ CSM Support

Enables or disables UEFI CSM (Compatibility Support Module) to support a legacy PC boot process.

- ▶▶ Always Enables UEFI CSM. (Default)
- ▶▶ Never Disables UEFI CSM and supports UEFI BIOS boot process only.

### ☞ Boot Mode Selection

Allows you to select which type of operating system to boot.

- ▶▶ UEFI and Legacy Allows booting from operating systems that support legacy option ROM or UEFI option ROM. (Default)
- ▶▶ Legacy Only Allows booting from operating systems that only support legacy option ROM.
- ▶▶ UEFI Only Allows booting from operating systems that only support UEFI option ROM.

This item is configurable only when **CSM Support** is set to **Always**.

### ☞ PXE Boot Option Control

Allows you to select whether to enable the UEFI or legacy option ROM for the LAN controller.

- ▶▶ Disabled Disables option ROM. (Default)
- ▶▶ Legacy Only Enables legacy option ROM only.
- ▶▶ UEFI Only Enables UEFI option ROM only.
- ▶▶ Legacy First Enables legacy option ROM first.
- ▶▶ UEFI First Enables UEFI option ROM first.

This item is configurable only when **CSM Support** is set to **Always**.

### ☞ Storage Boot Option Control

Allows you to select whether to enable the UEFI or legacy option ROM for the storage device controller.

- ▶▶ Disabled Disables option ROM.
- ▶▶ Legacy Only Enables legacy option ROM only. (Default)
- ▶▶ UEFI Only Enables UEFI option ROM only.
- ▶▶ Legacy First Enables legacy option ROM first.
- ▶▶ UEFI First Enables UEFI option ROM first.

This item is configurable only when **CSM Support** is set to **Always**.

### ☞ Display Boot Option Control

Allows you to select whether to enable the UEFI or legacy option ROM for the graphics controller.

- ▶▶ Disabled Disables option ROM.
- ▶▶ Legacy Only Enables legacy option ROM only. (Default)
- ▶▶ UEFI Only Enables UEFI option ROM only.
- ▶▶ Legacy First Enables legacy option ROM first.
- ▶▶ UEFI First Enables UEFI option ROM first.

This item is configurable only when **CSM Support** is set to **Always**.

### ☞ Other PCI Device ROM Priority

Allows you to select whether to enable the UEFI or Legacy option ROM for the PCI device controller other than the LAN, storage device, and graphics controllers.

- ▶▶ Legacy OpROM Enables legacy Option ROM only.
- ▶▶ UEFI OpROM Enables UEFI Option ROM only. (Default)

### ☞ Network stack

Disables or enables booting from the network to install a GPT format OS, such as installing the OS from the Windows Deployment Services server. (Default: Disable Link)

### ☞ Ipv4 PXE Support

Enables or disables IPv4 PXE Support. This item is configurable only when **Network stack** is enabled.

### ↳ **IPv6 PXE Support**

Enables or disables IPv6 PXE Support. This item is configurable only when **Network stack** is enabled.

### ↳ **Administrator Password**

Allows you to configure an administrator password. Press <Enter> on this item, type the password, and then press <Enter>. You will be requested to confirm the password. Type the password again and press <Enter>. You must enter the administrator password (or user password) at system startup and when entering BIOS Setup. Differing from the user password, the administrator password allows you to make changes to all BIOS settings.

### ↳ **User Password**

Allows you to configure a user password. Press <Enter> on this item, type the password, and then press <Enter>. You will be requested to confirm the password. Type the password again and press <Enter>. You must enter the administrator password (or user password) at system startup and when entering BIOS Setup. However, the user password only allows you to make changes to certain BIOS settings but not all.

To cancel the password, press <Enter> on the password item and when requested for the password, enter the correct one first. When prompted for a new password, press <Enter> without entering any password. Press <Enter> again when prompted to confirm.

## 2-6 Peripherals



### ↳ **OnChip SATA Channel**

Enables or disables the integrated SATA controllers. (Default: Enabled)

### ↳ **OnChip SATA Type**

Enables or disables RAID for the SATA controllers integrated in the AMD Chipset or configures the SATA controllers to AHCI mode.

- ▶▶ **Native IDE** Configures the SATA controller to IDE mode. (Default)
- ▶▶ **RAID** Enables RAID for the SATA controller.
- ▶▶ **AHCI** Configures the SATA controllers to AHCI mode. Advanced Host Controller Interface (AHCI) is an interface specification that allows the storage driver to enable advanced Serial ATA features such as Native Command Queuing and hot plug.

- ☞ **Enable all USB device**  
 Enables or disables the integrated USB 2.0/1.1 controller. (Default: Enabled)
- ☞ **HD Audio Azalia Device**  
 Enables or disables the onboard audio function. (Default: Enabled)  
 If you wish to install a 3rd party add-in audio card instead of using the onboard audio, set this item to **Disabled**.
- ☞ **IOMMU**  
 Enables or disables AMD IOMMU support. (Default: Enabled)
- ☞ **Onboard LAN Controller**  
 Enables or disables the onboard LAN function. (Default: Enabled)  
 If you wish to install a 3rd party add-in network card instead of using the onboard LAN, set this item to **Disabled**.
- ☞ **Legacy USB Support**  
 Allows USB keyboard/mouse to be used in MS-DOS. (Default: Enabled)
- ☞ **EHCI Hand-off**  
 Determines whether to enable EHCI Hand-off feature for an operating system without EHCI Hand-off support. (Default: Disabled)
- ☞ **Port 60/64 Emulation**  
 Enables or disables emulation of I/O ports 64h and 60h. This should be enabled for full legacy support for USB keyboards/mice in MS-DOS or in operating system that does not natively support USB devices. (Default: Disabled)
- ☞ **USB Storage Devices**  
 Displays a list of connected USB mass storage devices. This item appears only when a USB storage device is installed.

▶ **SATA Configuration**



➤ **PORT0 Hot Plug~PORT3 Hot Plug**

Enables or disable the hot plug capability for each SATA port. (Default: Disabled)

➤ **SATA Power on PORT0~SATA Power on PORT3**

Enables or disables each SATA port. (Default: Enabled)

▶ **GFX Configuration**

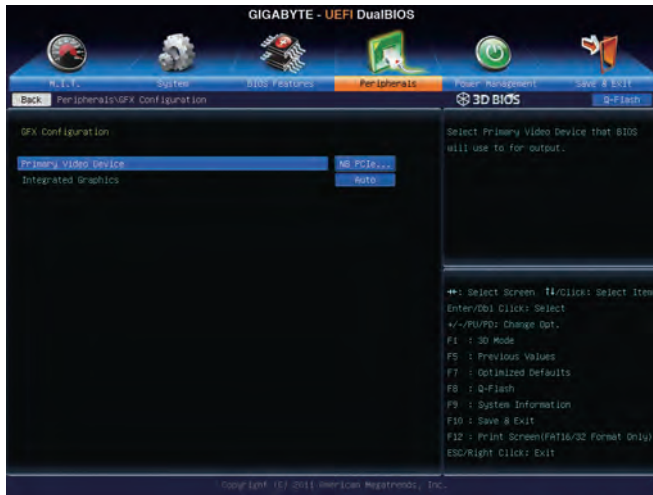

➤ **Primary Video Device**

Specifies the first initiation of the monitor display from the installed PCI Express graphics card or the onboard graphics.

- ▶▶ IGD Video Sets the onboard graphics as the first display.
- ▶▶ NB PCIe Slot Video Sets the PCI Express graphics card on the PCI Express slot controlled by the North Bridge as the first display. (Default)
- ▶▶ SB PCIe Slot Video Sets the PCI Express graphics card on the PCI Express slot controlled by the South Bridge as the first display.

➤ **Integrated Graphics**

Enables or disables the onboard graphics function.

- ▶▶ Auto The BIOS will automatically enable or disable the onboard graphics depending on the graphics card being installed. (Default)
- ▶▶ Disabled Disables the onboard graphics.
- ▶▶ Force Always activates the onboard graphics, whether or not a PCI Express card is installed.

➤ **UMA Frame Buffer Size**

This item is configurable only when **Integrated Graphics** is set to **Force**. Frame buffer size is the total amount of system memory allocated solely for the onboard graphics controller. MS-DOS, for example, will use only this memory for display. Options are: Auto (default), 256M, 512M, 1G, 2G.

▶ **Super IO Configuration**

This section provides information on the super I/O chip and allows you to configure the serial port.

➤ **Serial Port A**

Enables or disables the onboard serial port. (Default: Enabled)

## 2-7 Power Management



### ☞ Resume by Alarm

Determines whether to power on the system at a desired time. (Default: Disabled)

If enabled, set the date and time as following:

▶▶ Wake up day: Turn on the system at a specific time on each day or on a specific day in a month.

▶▶ Wake up hour/minute/second: Set the time at which the system will be powered on automatically.

Note: When using this function, avoid inadequate shutdown from the operating system or removal of the AC power, or the settings may not be effective.

### ☞ HPET Timer (Note)

Enables or disables High Precision Event Timer (HPET) for Windows 7/Vista operating system. (Default: Enabled)

### ☞ ErP

Determines whether to let the system consume least power in S5 (shutdown) state. (Default: Disabled)

Note: When this item is set to **Enabled**, the following functions will become unavailable: PME event wake up, power on by mouse, power on by keyboard, and wake on LAN.

### ☞ Soft-Off by PWR-BTtn

Configures the way to turn off the computer in MS-DOS mode using the power button.

▶▶ Instant-Off Press the power button and then the system will be turned off instantly. (Default)

▶▶ Delay 4 Sec Press and hold the power button for 4 seconds to turn off the system. If the power button is pressed for less than 4 seconds, the system will enter suspend mode.

### ☞ AC BACK

Determines the state of the system after the return of power from an AC power loss.

▶▶ Memory The system returns to its last known awake state upon the return of the AC power.

▶▶ Always On The system is turned on upon the return of the AC power.

▶▶ Always Off The system stays off upon the return of the AC power. (Default)

(Note) Supported on Windows 7/Vista operating system only.

### ☞ **Power On By Keyboard**

Allows the system to be turned on by a PS/2 keyboard wake-up event.

Note: To use this function, you need an ATX power supply providing at least 1A on the +5VSB lead.

- ▶▶ Disabled      Disables this function. (Default)
- ▶▶ Password      Set a password with 1~5 characters to turn on the system.
- ▶▶ Keyboard 98    Press POWER button on the Windows 98 keyboard to turn on the system.
- ▶▶ Any Key        Press any key to turn on the system.

### ☞ **Power On Password**

Set the password when **Power On by Keyboard** is set to **Password**.

Press <Enter> on this item and set a password with up to 5 characters and then press <Enter> to accept.

To turn on the system, enter the password and press <Enter>.

Note: To cancel the password, press <Enter> on this item. When prompted for the password, press <Enter> again without entering the password to clear the password settings.

### ☞ **Power On By Mouse**

Allows the system to be turned on by a PS/2 mouse wake-up event.

Note: To use this function, you need an ATX power supply providing at least 1A on the +5VSB lead.

- ▶▶ Disabled      Disables this function. (Default)
- ▶▶ Move          Move the mouse to turn on the system.
- ▶▶ Double Click    Double click on left button on the mouse to turn on the system.

## 2-8 Save & Exit



### ☞ Save & Exit Setup

Press <Enter> on this item and select **Yes**. This saves the changes to the CMOS and exits the BIOS Setup program. Select **No** or press <Esc> to return to the BIOS Setup Main Menu.

### ☞ Exit Without Saving

Press <Enter> on this item and select **Yes**. This exits the BIOS Setup without saving the changes made in BIOS Setup to the CMOS. Select **No** or press <Esc> to return to the BIOS Setup Main Menu.

### ☞ Load Optimized Defaults

Press <Enter> on this item and select **Yes** to load the optimal BIOS default settings. The BIOS default settings help the system to operate in optimum state. Always load the Optimized defaults after updating the BIOS or after clearing the CMOS values.

### ☞ Boot Override

Allows you to select a device to boot immediately. Press <Enter> on the device you select and select **Yes** to confirm. Your system will restart automatically and boot from that device.

### ☞ Save Profiles

This function allows you to save the current BIOS settings to a profile. You can create up to 8 profiles and save as Setup Profile 1~ Setup Profile 8. Press <Enter> to complete. Or you can select **Select File in HDD/USB/FDD** to save the profile to your storage device.

### ☞ Load Profiles

If your system becomes unstable and you have loaded the BIOS default settings, you can use this function to load the BIOS settings from a profile created before, without the hassles of reconfiguring the BIOS settings. First select the profile you wish to load and then press <Enter> to complete. You can select **Select File in HDD/USB/FDD** to input the profile previously created from your storage device or load the profile automatically created by the BIOS, such as reverting the BIOS settings to the last settings that worked properly (last known good record).

## Chapter 3 Drivers Installation



- Before installing the drivers, first install the operating system.
- After installing the operating system, insert the motherboard driver disk into your optical drive. The driver Autorun screen is automatically displayed which looks like that shown in the screen shot below. (If the driver Autorun screen does not appear automatically, go to My Computer, double-click the optical drive and execute the **Run.exe** program.)

After inserting the driver disk, "Xpress Install" will automatically scan your system and then list all the drivers that are recommended to install. You can click the **Install All** button and "Xpress Install" will install all the recommended drivers. Or click **Install Single Items** to manually select the drivers you wish to install.



## Chapter 4 Appendix

### Configuring SATA Hard Drive(s)

#### Before you begin

- At least two SATA hard drives (to ensure optimal performance, it is recommended that you use two hard drives with identical model and capacity). If you do not want to create RAID, you may prepare only one hard drive.
- Windows 7/Vista/XP setup disk.
- Motherboard driver disk.
- A USB floppy disk drive (needed during Windows XP installation)
- An empty formatted floppy disk (needed during Windows XP installation)

### Configuring the Onboard SATA Controller

#### A. Installing SATA hard drive(s) in your computer

Attach one end of the SATA signal cable to the rear of the SATA hard drive and the other end to available SATA port on the motherboard. Then connect the power connector from your power supply to the hard drive.

## B. Configuring SATA controller mode in BIOS Setup

Make sure to configure the SATA controller mode correctly in system BIOS Setup. For the BIOS Setup menus, refer to Chapter 2, "BIOS Setup," "Integrated Peripherals."

Steps:

1. Turn on your computer and press <Delete> to enter BIOS Setup during the POST (Power-On Self-Test). Ensure **OnChip SATA Channel** is enabled under **Peripherals**. To enable RAID for the SATA2 0/1/2/3 connectors, set **OnChip SATA Type** to **RAID**.
2. Save changes and exit BIOS Setup.



The BIOS Setup menus described in this section may differ from the exact settings for your motherboard. The actual BIOS Setup menu options you will see shall depend on the motherboard you have and the BIOS version.

## C. Configuring RAID set in RAID BIOS

Enter the RAID BIOS setup utility to configure a RAID array. After the POST memory test begins and before the operating system boot begins, look for a message which says "Press <Ctrl-F> to enter RAID Option ROM Utility". Press <Ctrl> + <F> to enter the RAID BIOS setup utility. To create a new array, press <2> to enter the **LD View/LD Define Menu** window. To create an array, press <Ctrl+C> to access the **LD Define Menu**. In the **LD Define Menu**, use the up or down arrow key to move to an item for further configuration. In the following procedure, we'll create RAID 0 as an example.

Steps:

1. Under the **RAID Mode** section, press the <SPACE> key to select **RAID 0**.
2. Set the **Stripe Block** size. 64 KB is the default.
3. Under the **Drives Assignments** section, press the up or down arrow key to highlight a drive.
4. Press the <SPACE> key or <Y> to change the **Assignment** option to **Y**. This action adds the drive to the disk array. The **Drv** section will show the number of disks assigned.
5. Press <Ctrl>+<Y> keys to save the information. The message in Figure 1 will appear. Press <Ctrl>+<Y> to input the array name. If you do not input the array name, the default array name will be used.

Please press Ctrl-Y key to input the LD Name  
or press any key to exit.  
If you do not input any LD name, the default  
LD name will be used.

Figure 1

6. When the next message appears, press <Ctrl>+<Y> to clear the MBR or press other keys to ignore this option.

Fast Initialization Option has been selected  
It will erase the MBR data of the disk.  
<Press Ctrl-Y Key if you are sure to erase it>  
<Press any other key to ignore this option>

Figure 2

7. Then, the message in Figure 3 will appear. Press <Ctrl>+<Y> to set the capacity of the RAID array or press other keys to set the array to its maximum capacity.

Press Ctrl-Y to Modify Array Capacity or press any  
other key to use maximum capacity...

Figure 3

8. After the creation is complete, the screen will return to **LD View Menu** where you will see the newly-created array.
9. Press <Esc> to return to **Main Menu** and press <Esc> again if you want to exit the RAID BIOS utility.

### **Making a SATA RAID/AHCI Driver Diskette**

Before installing Windows XP, connect a USB floppy disk drive to your computer first because you need to install the SATA RAID/AHCI driver from a floppy disk that contains the driver during the OS installation. To copy the RAID/AHCI driver for Windows XP, copy all files in the **\BootDrv\Hxp** folder in the motherboard driver disk to your floppy disk.

### **Installing the SATA RAID/AHCI Driver and Operating System**

#### **A. Installing Windows XP**

Restart your system to boot from the Windows XP setup disk and press <F6> as soon as you see the message "Press F6 if you need to install a 3rd party SCSI or RAID driver." Insert the floppy disk containing the SATA RAID/AHCI driver. Follow the on-screen instructions to install the driver that suits your operating system. When completed, proceed with the Windows XP installation.

#### **B. Installing Windows 7/Vista**

Restart your system to boot from the Windows 7/Vista setup disk and perform standard OS installation steps. Select **Load Driver**. Insert the motherboard driver disk and then browse to the location of the driver. Then follow the on-screen instructions to load the driver. The locations of the drivers for Windows 7 are as follows:

RAID driver for Windows 32-bit: `\BootDrv\Hw7\RAID\X86`

RAID driver for Windows 64-bit: `\BootDrv\Hw7\RAID\X64`

AHCI driver for Windows 32-bit: `\BootDrv\Hw7\AHC\I\W7`

AHCI driver for Windows 64-bit: `\BootDrv\Hw7\AHC\I\W764A`

After loading the driver, continue the OS installation.

# Regulatory Statements

## Regulatory Notices

This document must not be copied without our written permission, and the contents there of must not be imparted to a third party nor be used for any unauthorized purpose. Contravention will be prosecuted. We believe that the information contained herein was accurate in all respects at the time of printing. GIGABYTE cannot, however, assume any responsibility for errors or omissions in this text. Also note that the information in this document is subject to change without notice and should not be construed as a commitment by GIGABYTE.

## Our Commitment to Preserving the Environment

In addition to high-efficiency performance, all GIGABYTE motherboards fulfill European Union regulations for RoHS (Restriction of Certain Hazardous Substances in Electrical and Electronic Equipment) and WEEE (Waste Electrical and Electronic Equipment) environmental directives, as well as most major worldwide safety requirements. To prevent releases of harmful substances into the environment and to maximize the use of our natural resources, GIGABYTE provides the following information on how you can responsibly recycle or reuse most of the materials in your "end of life" product.

## Restriction of Hazardous Substances (RoHS) Directive Statement

GIGABYTE products have not intended to add and safe from hazardous substances (Cd, Pb, Hg, Cr+6, PBDE and PBB). The parts and components have been carefully selected to meet RoHS requirement. Moreover, we at GIGABYTE are continuing our efforts to develop products that do not use internationally banned toxic chemicals.

## Waste Electrical & Electronic Equipment (WEEE) Directive Statement

GIGABYTE will fulfill the national laws as interpreted from the 2002/96/EC WEEE (Waste Electrical and Electronic Equipment) directive. The WEEE Directive specifies the treatment, collection, recycling and disposal of electric and electronic devices and their components. Under the Directive, used equipment must be marked, collected separately, and disposed of properly.

## WEEE Symbol Statement



The symbol shown below is on the product or on its packaging, which indicates that this product must not be disposed of with other waste. Instead, the device should be taken to the waste collection centers for activation of the treatment, collection, recycling and disposal procedure.

The separate collection and recycling of your waste equipment at the time of disposal will help to conserve natural resources and ensure that it is recycled in a manner that protects human health and the environment. For more information about where you can drop off your waste equipment for recycling, please contact your local government office, your household waste disposal service or where you purchased the product for details of environmentally safe recycling.

- When your electrical or electronic equipment is no longer useful to you, "take it back" to your local or regional waste collection administration for recycling.
- If you need further assistance in recycling, reusing in your "end of life" product, you may contact us at the Customer Care number listed in your product's user's manual and we will be glad to help you with your effort.

Finally, we suggest that you practice other environmentally friendly actions by understanding and using the energy-saving features of this product (where applicable), recycling the inner and outer packaging (including shipping containers) this product was delivered in, and by disposing of or recycling used batteries properly. With your help, we can reduce the amount of natural resources needed to produce electrical and electronic equipment, minimize the use of landfills for the disposal of "end of life" products, and generally improve our quality of life by ensuring that potentially hazardous substances are not released into the environment and are disposed of properly.









## Contact Us

---

### GIGA-BYTE TECHNOLOGY CO., LTD.

Address: No.6, Bao Chiang Road, Hsin-Tien Dist., New Taipei City 231, Taiwan

TEL: +886-2-8912-4000, FAX: +886-2-8912-4003

Tech. and Non-Tech. Support (Sales/Marketing) : <http://ggts.gigabyte.com.tw>

WEB address (English): <http://www.gigabyte.com>

WEB address (Chinese): <http://www.gigabyte.tw>

---

You may go to the GIGABYTE website, select your language in the language list on the top right corner of the website.

- **GIGABYTE Global Service System**



To submit a technical or non-technical (Sales/Marketing) question, please link to:

<http://ggts.gigabyte.com.tw>

Then select your language to enter the system.