

TravelMate 5744

User's Manual



© 2011 All Rights Reserved.
TravelMate 5744 User's Manual
Original Issue: 05/2011

Model number: _____

Serial number: _____

Date of purchase: _____

Place of purchase: _____

INFORMATION FOR YOUR SAFETY AND COMFORT

SAFETY INSTRUCTIONS

Read these instructions carefully. Keep this document for future reference. Follow all warnings and instructions marked on the product.

Turning the product off before cleaning

Unplug this product from the wall outlet before cleaning. Do not use liquid cleaners or aerosol cleaners. Use a damp cloth for cleaning.

Warnings

Accessing the power cord

Be sure that the power outlet you plug the power cord into is easily accessible and located as close to the equipment operator as possible. When you need to disconnect power to the equipment, be sure to unplug the power cord from the electrical outlet.

Disconnecting the power source

Observe the following guidelines when connecting and disconnecting power to the power supply unit:

Install the power supply unit before connecting the power cord to the AC power outlet.

Unplug the power cord before removing the power supply unit from the computer.

If the system has multiple sources of power, disconnect power from the system by unplugging all power cords from the power supplies.

Using electrical power

- This product should be operated from the type of power indicated on the marking label. If you are not sure of the type of power available, consult your dealer or local power company.
- Do not allow anything to rest on the power cord. Do not locate this product where people will walk on the cord.
- If an extension cord is used with this product, make sure that the total ampere rating of the equipment plugged into the extension cord does not exceed the extension cord ampere rating. Also, make sure that the total rating of all products plugged into the wall outlet does not exceed the fuse rating.
- Do not overload a power outlet, strip or receptacle by plugging in too many devices. The overall system load must not exceed 80% of the branch circuit rating. If power strips are used, the load should not exceed 80% of the power strip's input rating.
- This product's AC adapter is equipped with a three-wire grounded plug. The plug only fits in a grounded power outlet. Make sure the power outlet is properly grounded before inserting the AC adapter plug. Do not insert the plug into a non-grounded power outlet. Contact your electrician for details.

Warning! The grounding pin is a safety feature. Using a power outlet that is not properly grounded may result in electric shock and/or injury.

Note: The grounding pin also provides good protection from unexpected noise produced by other nearby electrical devices that may interfere with the performance of this product.

- The system can be powered using a wide range of voltages; 100 to 120 or 220 to 240 V AC. The power cord included with the system meets the requirements for use in the country/region where the system was purchased. Power cords for use in other countries/regions must meet the requirements for that country/region. For more information on power cord requirements, contact an authorized reseller or service provider.

Protecting your hearing

Warning: Permanent hearing loss may occur if earphones or headphones are used at high volume for prolonged periods of time.



To protect your hearing, follow these instructions.

- Increase the volume gradually until you can hear clearly and comfortably.
- Do not increase the volume level after your ears have adjusted.
- Do not listen to music at high volumes for extended periods.

Information for your safety and comfort - 5

- Do not increase the volume to block out noisy surroundings.
- Decrease the volume if you can't hear people speaking near you.

Bundled dummy cards

Note: Information in this section may not apply to your computer.

Your computer shipped with plastic dummies installed in the card slots. Dummies protect unused slots from dust, metal objects or other particles. Save the dummies for use when no cards are in the slots.

General

- Do not use this product near water.
- Do not place this product on an unstable cart, stand or table. If the product falls, it could be seriously damaged.
- Slots and openings are provided for ventilation to ensure reliable operation of the product and to protect it from overheating. These openings must not be blocked or covered. The openings should never be blocked by placing the product on a bed, sofa, rug or other similar surface. This product should never be placed near or over a radiator or heat register, or in a built-in installation unless proper ventilation is provided.
- Never push objects of any kind into this product through cabinet slots as they may touch dangerous voltage points or short-out parts that could result in a fire or electric shock. Never spill liquid of any kind onto or into the product.

- To avoid damage of internal components and to prevent battery leakage, do not place the product on a vibrating surface.
- Never use it under sporting, exercising, or any vibrating environment which will probably cause unexpected short current or damage rotor devices, HDD, Optical drive, and even exposure risk from lithium battery pack.
- The bottom surface, areas around ventilation openings and AC adapter may get hot. To avoid injury, ensure they do not come in contact with your skin or body.
- Your device and its enhancements may contain small parts. Keep them out of the reach of small children.

Product servicing

Do not attempt to service this product yourself, as opening or removing covers may expose you to dangerous voltage points or other risks. Refer all servicing to qualified service personnel.

Unplug this product from the wall outlet and refer servicing to qualified service personnel when:

- The power cord or plug is damaged, cut or frayed.
- Liquid was spilled into the product.
- The product was exposed to rain or water.
- The product has been dropped or the case has been damaged.
- The product exhibits a distinct change in performance, indicating a need for service.

Information for your safety and comfort - 7

- The product does not operate normally after following the operating instructions.

Note: Adjust only those controls that are covered by the operating instructions, since improper adjustment of other controls may result in damage and will often require extensive work by a qualified technician to restore the product to normal condition.

Guidelines for safe battery usage

This notebook uses a Lithium-ion battery. Do not use it in a humid, wet or corrosive environment. Do not put, store or leave your product in or near a heat source, in a high temperature location, in strong direct sunlight, in a microwave oven or in a pressurized container, and do not expose it to temperatures over 60° C (140° F). Failure to follow these guidelines may cause the battery to leak acid, become hot, explode or ignite and cause injury and/or damage. Do not pierce, open or disassemble the battery. If the battery leaks and you come into contact with the leaked fluids, rinse thoroughly with water and seek medical attention immediately. For safety reasons, and to prolong the lifetime of the battery, charging will not occur at temperatures below 0° C (32° F) or above 40° C (104° F).

The full performance of a new battery is achieved only after two or three complete charge and discharge cycles. The battery can be charged and discharged hundreds of times, but it will eventually wear out. When the operation time becomes noticeably shorter than normal, buy a new battery. Use only the approved batteries, and recharge your battery only with the approved chargers designated for this device.

Use the battery only for its intended purpose. Never use any charger or battery that is damaged. Do not short-circuit the battery. Accidental short-circuiting can occur when a metallic object such as a coin, clip or pen causes direct connection of the positive (+) and negative (-) terminals of the battery. (These look like metal strips on the battery.) This might happen, for example, when you carry a spare battery in your pocket or purse. Short-circuiting the terminals may damage the battery or the connecting object.

The capacity and lifetime of the battery will be reduced if the battery is left in hot or cold places, such as in a closed car in summer or winter. Always try to keep the battery between 15°C and 25°C (59°F and 77°F). A device with a hot or cold battery may not work temporarily, even when the battery is fully charged. Battery performance is especially limited in temperatures well below freezing.

Do not dispose of batteries in a fire as they may explode. Batteries may also explode if damaged. Dispose of batteries according to local regulations. Please recycle when possible. Do not dispose as household waste.

Wireless devices may be susceptible to interference from the battery, which could affect performance.

Note: Please refer to **www.acer.com** for battery shipping documents.

Replacing the battery pack

The notebook uses lithium batteries. Replace the battery with the same type as that which came bundled with your product. Use of another battery may present a risk of fire or explosion.

Warning! Batteries may explode if not handled properly. Do not disassemble or dispose of them in fire. Keep them away from children. Follow local regulations when disposing of used batteries.

CAUTION FOR OPTICAL DRIVE DEVICE

Note: Information in this section may not apply to your computer.

CAUTION: This appliance contains a laser system and is classified as a "CLASS 1 LASER PRODUCT." In case of any trouble with this device, please contact your nearest AUTHORIZED service station. To prevent direct exposure to the laser beam, do not try to open the enclosure.

CLASS 1 LASER PRODUCT

CAUTION: INVISIBLE LASER RADIATION WHEN OPEN. AVOID EXPOSURE TO BEAM.

APPAREIL A LASER DE CLASSE 1 PRODUIT

LASERATTENTION: RADIATION DU FAISCEAU LASER INVISIBLE EN CAS D'OUVERTURE. EVITER TOUTE EXPOSITION AUX RAYONS.

LUOKAN 1 LASERLAITE LASER KLASSE 1

VORSICHT: UNSICHTBARE LASERSTRAHLUNG, WENN ABDECKUNG
GEÖFFNET NICHT DEM STRAHL AUSSETZEN

PRODUCTO LÁSER DE LA CLASE I

ADVERTENCIA: RADIACIÓN LÁSER INVISIBLE AL SER ABIERTO. EVITE
EXPONERSE A LOS RAYOS.

ADVARSEL: LASERSTRÅLING VEDÅBNING SE IKKE IND I STRÅLEN.

VARO! LAVATTAESSA OLET ALTTINA LASERSÄTEILYLLE.

VARNING: LASERSTRÅLNING NÅR DENNA DEL ÅR ÖPPNAD ÅLÅ
TUIJOTA SÄTEESEENSTIRRA EJ IN I STRÅLEN

VARNING: LASERSTRÅLNING NAR DENNA DEL ÅR ÖPPNADSTIRRA EJ
IN I STRÅLEN

ADVARSEL: LASERSTRÅLING NAR DEKSEL ÅPNESSTIRR IKKE INN I
STRÅLEN

Warning! For safety reasons, do not use non-compliant parts when adding or changing components. Consult your reseller for purchase options.

RADIO FREQUENCY INTERFERENCE

Warning! For safety reasons, turn off all wireless or radio transmitting devices when using your laptop under the following conditions. These devices may include, but are not limited to: wireless LAN (WLAN), Bluetooth and/or 3G.

Information for your safety and comfort - 11

Remember to follow any special regulations in force in any area, and always switch off your device when its use is prohibited or when it may cause interference or danger. Use the device only in its normal operating positions. This device meets RF exposure guidelines when used normally, and it and its antenna are positioned at least 1.5 centimeters (5/8 inches) away from your body. It should not contain metal and you should position the device the above-stated distance from your body. To successfully transmit data files or messages, this device requires a good quality connection to the network. In some cases, transmission of data files or messages may be delayed until such a connection is available. Ensure that the above separation distance instructions are followed until the transmission is completed. Parts of the device are magnetic. Metallic materials may be attracted to the device, and persons with hearing aids should not hold the device to the ear with the hearing aid. Do not place credit cards or other magnetic storage media near the device, because information stored on them may be erased.

MEDICAL DEVICES

Operation of any radio transmitting equipment, including wireless phones, may interfere with the functionality of inadequately protected medical devices. Consult a physician or the manufacturer of the medical device to determine if they are adequately shielded from external RF energy or if you have any questions. Switch off your device in health care facilities when any regulations posted in these areas instruct you to do so. Hospitals or health care facilities may be using equipment that could be sensitive to external RF transmissions.

Pacemakers. Pacemaker manufacturers recommend that a minimum separation of 15.3 centimeters (6 inches) be maintained between wireless devices and a pacemaker to avoid potential interference with the pacemaker. These recommendations are consistent with the independent research by and recommendations of Wireless Technology Research. Persons with pacemakers should do the following:

- Always keep the device more than 15.3 centimeters (6 inches) from the pacemaker
- Not carry the device near your pacemaker when the device is switched on.

If you suspect interference, switch off your device, and move it.

Hearing aids. Some digital wireless devices may interfere with some hearing aids. If interference occurs, consult your service provider.

VEHICLES

RF signals may affect improperly installed or inadequately shielded electronic systems in motor vehicles such as electronic fuel injection systems, electronic anti-skid (anti-lock) braking systems, electronic speed control systems, and air bag systems. For more information, check with the manufacturer, or its representative, of your vehicle or any equipment that has been added. Only qualified personnel should service the device, or install the device in a vehicle. Faulty installation or service may be dangerous and may invalidate any warranty that may apply to the device. Check regularly that all wireless equipment in your vehicle is mounted and operating properly. Do not store or carry flammable liquids, gases, or explosive materials in the same compartment as the device, its

Information for your safety and comfort - 13

parts, or enhancements. For vehicles equipped with an air bag, remember that air bags inflate with great force. Do not place objects, including installed or portable wireless equipment in the area over the air bag or in the air bag deployment area. If in-vehicle wireless equipment is improperly installed, and the air bag inflates, serious injury could result. Using your device while flying in aircraft is prohibited. Switch off your device before boarding an aircraft. The use of wireless teledevices in an aircraft may be dangerous to the operation of the aircraft, disrupt the wireless telephone network, and may be illegal.

POTENTIALLY EXPLOSIVE ENVIRONMENTS

Switch off your device when in any area with a potentially explosive atmosphere and obey all signs and instructions. Potentially explosive atmospheres include areas where you would normally be advised to turn off your vehicle engine. Sparks in such areas could cause an explosion or fire resulting in bodily injury or even death. Switch off the device at refueling points such as near gas pumps at service stations. Observe restrictions on the use of radio equipment in fuel depots, storage, and distribution areas; chemical plants; or where blasting operations are in progress. Areas with a potentially explosive atmosphere are often, but not always, clearly marked. They include below deck on boats, chemical transfer or storage facilities, vehicles using liquefied petroleum gas (such as propane or butane), and areas where the air contains chemicals or particles such as grain, dust or metal powders. Do not switch the notebook on when wireless phone use is prohibited or when it may cause interference or danger.

EMERGENCY CALLS

Warning: You cannot make emergency calls through this device. To make an emergency call you shall dial out through your mobile phone or other telephone call system.

DISPOSAL INSTRUCTIONS

Do not throw this electronic device into the trash when discarding. To minimize pollution and ensure utmost protection of the global environment, please recycle. For more information on the Waste from Electrical and Electronics Equipment (WEEE) regulations, visit www.acer-group.com/public/Sustainability/sustainability01.htm

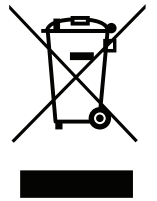

Mercury advisory

For bulb-inside projectors or electronic products containing a non-LED-backlit-LCD/CRT monitor or display: Lamp(s) inside this product contain mercury and must be recycled or disposed of according to local, state or federal laws. For more information, contact the Electronic Industries Alliance at www.eiae.org. For lamp-specific disposal information, check www.lamprecycle.org.



ENERGY STAR



Acer's ENERGY STAR qualified products save your money by reducing energy cost and protecting the environment without sacrificing features or performance. Acer is proud to offer our customers products with the ENERGY STAR mark.

What is ENERGY STAR?

Products that are ENERGY STAR qualified use less energy and prevent greenhouse gas emissions by meeting strict energy efficiency guidelines set by the U.S. Environmental Protection Agency. Acer is committed to offering products and services worldwide that help customers save money, conserve energy and improve the quality of our environment. The more energy we can save through higher energy efficiency, the more we reduce greenhouse gases and the risks of climate change. More information refers to

www.energystar.gov or www.energystar.gov/powermanagement.

Note: Information in this section may not apply to your computer.

Acer ENERGY STAR qualified products:

- Produce less heat and reduce cooling loads, and warmer climates.
- Automatically go into "display sleep" and "computer sleep" mode after 10 and 30 minutes of inactivity respectively.
- Wake the computer from sleep mode by pushing keyboard or moving mouse.
- Computers will save more than 80% energy at "sleep" mode.

ENERGY STAR and the ENERGY STAR mark are registered U.S. marks

TIPS AND INFORMATION FOR COMFORTABLE USE

Computer users may complain of eyestrain and headaches after prolonged use. Users are also at risk of physical injury after long hours of working in front of a computer. Long work periods, bad posture, poor work habits, stress, inadequate working conditions, personal health and other factors greatly increase the risk of physical injury.

Incorrect computer usage may lead to carpal tunnel syndrome, tendonitis, tenosynovitis or other musculoskeletal disorders. The following symptoms may appear in the hands, wrists, arms, shoulders, neck or back:

- Numbness, or a burning or tingling sensation.
- Aching, soreness or tenderness.
- Pain, swelling or throbbing.
- Stiffness or tightness.
- Coldness or weakness.

If you have these symptoms, or any other recurring or persistent discomfort and/or pain related to computer use, consult a physician immediately and inform your company's health and safety department.

The following section provides tips for more comfortable computer use.

Finding your comfort zone

Find your comfort zone by adjusting the viewing angle of the monitor, using a footrest, or raising your sitting height to achieve maximum comfort. Observe the following tips:

- Refrain from staying too long in one fixed posture.
- Avoid slouching forward and/or leaning backward.
- Stand up and walk around regularly to remove the strain on your leg muscles.
- Take short rests to relax your neck and shoulders.
- Avoid tensing your muscles or shrugging your shoulders.
- Install the external display, keyboard and mouse properly and within comfortable reach.
- If you view your monitor more than your documents, place the display at the center of your desk to minimize neck strain.

Taking care of your vision

Long viewing hours, wearing incorrect glasses or contact lenses, glare, excessive room lighting, poorly focused screens, very small typefaces and low-contrast displays could stress your eyes. The following sections provide suggestions on how to reduce eyestrain.

Eyes

- Rest your eyes frequently.
- Give your eyes regular breaks by looking away from the monitor and focusing on a distant point.

- Blink frequently to keep your eyes from drying out.

Display

- Keep your display clean.
- Keep your head at a higher level than the top edge of the display so your eyes point downward when looking at the middle of the display.
- Adjust the display brightness and/or contrast to a comfortable level for enhanced text readability and graphics clarity.
- Eliminate glare and reflections by:
 - placing your display in such a way that the side faces the window or any light source,
 - minimizing room light by using drapes, shades or blinds,
 - using a task light,
 - changing the display's viewing angle,
 - using a glare-reduction filter,
 - using a display visor, such as a piece of cardboard extended from the display's top front edge.
- Avoid adjusting your display to an awkward viewing angle.
- Avoid looking at bright light sources for extended periods of time.

Developing good work habits

The following work habits make computer use more relaxing and productive:

- Take short breaks regularly and often.

- Perform some stretching exercises.
- Breathe fresh air as often as possible.
- Exercise regularly and maintain a healthy body.

Warning! We do not recommend using the computer on a couch or bed. If this is unavoidable, work for only short periods, take breaks regularly, and do some stretching exercises.

Note: For more information, please refer to "**Regulations and safety notices**" on page 88.

FIRST THINGS FIRST

We would like to thank you for making an Acer notebook your choice for meeting your mobile computing needs.

YOUR GUIDES

To help you use your Acer notebook, we have designed a set of guides: First off, the **setup poster** helps you get started with setting up your computer.

The **TravelMate User's Manual** contains useful information applying to your new computer. It covers basic topics such as using the keyboard and audio, etc.

The **Quick Guide** introduces you to the basic features and functions of your new computer. For more on how your computer can help you to be more productive, please refer to the **TravelMate User's Manual**. This guide contains detailed information on such subjects as system utilities, data recovery, expansion options and troubleshooting. In addition it contains warranty information and the general regulations and safety notices for your notebook. It is available from your computer desktop; simply double-click the **Acer User's Guide** icon.

BASIC CARE AND TIPS FOR USING YOUR COMPUTER

Turning your computer on and off

To turn on the computer, simply press and release the power button. Please refer to the setup poster for the location of the power button.

To turn the power off, do any of the following:

- Use the Windows shutdown command: click **Start** then Click **Shut Down**.
- Use the power button.
- You can also put the computer in sleep mode by pressing the sleep hotkey <**Fn**> + <**F4**>.

Note: If you cannot power off the computer normally, press and hold the power button for more than four seconds to shut down the computer. If you turn off the computer and want to turn it on again, wait at least two seconds before powering up.

Taking care of your computer

Your computer will serve you well if you take care of it.

- Do not expose the computer to direct sunlight. Do not place it near sources of heat, such as a radiator.
- Do not expose the computer to temperatures below 0° C (32° F) or above 50° C (122° F).
- Do not subject the computer to magnetic fields.
- Do not expose the computer to rain or moisture.

- Do not spill water or any liquid on the computer.
- Do not subject the computer to heavy shock or vibration.
- Do not expose the computer to dust or dirt.
- Never place objects on top of the computer.
- Do not slam the computer display when you close it.
- Never place the computer on uneven surfaces.

Taking care of your AC adapter

Here are some ways to take care of your AC adapter:

- Do not connect the adapter to any other device.
- Do not step on the power cord or place heavy objects on top of it. Carefully route the power cord and any cables away from foot traffic.
- When unplugging the power cord, do not pull on the cord itself but pull on the plug.
- The total ampere ratings of the equipment plugged in should not exceed the ampere rating of the cord if you are using an extension cord. Also, the total current rating of all equipment plugged into a single wall outlet should not exceed the fuse rating.

Taking care of your battery pack

Here are some ways to take care of your battery pack:

- Use only batteries of the same kind as replacements. Turn the power off before removing or replacing batteries.
- Do not tamper with batteries. Keep them away from children.

- Dispose of used batteries according to local regulations. Recycle if possible.

Cleaning and servicing

When cleaning the computer, follow these steps:

1. Turn off the computer and remove the battery pack.
2. Disconnect the AC adapter.
3. Use a soft, moist cloth. Do not use liquid or aerosol cleaners.

If either of the following occurs:

- The computer has been dropped or the body has been damaged;
- The computer does not operate normally

Please refer to "**Frequently asked questions**" on page 81 .

Table of contents

Information for your safety and comfort	3
Safety instructions	3
Warnings	3
Caution for Optical Drive Device	10
Radio frequency interference	11
Medical devices	12
Vehicles	13
Potentially explosive environments	14
Emergency calls	15
Disposal instructions	15
Mercury advisory	15
ENERGY STAR	16
Tips and information for comfortable use	17

First things first	21
Your guides	21
Basic care and tips for using your computer	22

Turning your computer on and off	22
Taking care of your computer	22
Taking care of your AC adapter	23
Taking care of your battery pack	23
Cleaning and servicing	24
<hr/>	
Your Acer notebook tour	30
Top view	31
Left view	33
Right view	34
Base view	36
<hr/>	
Touchpad	37
Touchpad basics (with two buttons)	37
<hr/>	
Using the keyboard	39
Lock keys and embedded numeric keypad	39
Hotkeys	40
Windows keys	42
<hr/>	
Acer Backup Manager	44
<hr/>	
Acer eRecovery Management	46
Creating a recovery backup	47
Recovering your system	50

To recover your system	51
Types of recovery	52
Recovering pre-installed software and drivers	52
Returning to a previous system condition	53
Returning your system to its factory condition	54

Taking your notebook PC with you **58**

Disconnecting from the desktop	58
Moving around	58
Preparing the computer	59
What to bring to meetings	59
Taking the computer home	60
Preparing the computer	60
What to take with you	60
Special considerations	61
Setting up a home office	61
Traveling with the computer	62
Preparing the computer	62
What to take with you	62
Special considerations	62
Traveling internationally with the computer	63
Preparing the computer	63
What to bring with you	63
Special considerations	63

Securing your computer **65**

Using a computer security lock	65
--------------------------------	----

Using passwords	65
Entering passwords	66
Setting passwords	67

BIOS utility	68
Boot sequence	68
Enable disk-to-disk recovery	68
Setting passwords	68

Connecting to a network	69
Connectivity options	69
Built-in network feature	69

Playing DVD movies	71
---------------------------	-----------

Upgrading memory	73
-------------------------	-----------

Universal Serial Bus (USB)	75
-----------------------------------	-----------

Battery pack	76
Battery pack characteristics	76

Charging the battery	76
Optimizing battery life	78
Checking the battery level	79
Battery-low warning	79
Installing and removing the battery pack	80

Frequently asked questions **81**

Requesting service	84
Troubleshooting	86
Troubleshooting tips	86
Error messages	86

Regulations and safety notices **88**

YOUR ACER NOTEBOOK TOUR



After setting up your computer as illustrated in the setup poster, let us show you around your new Acer notebook.

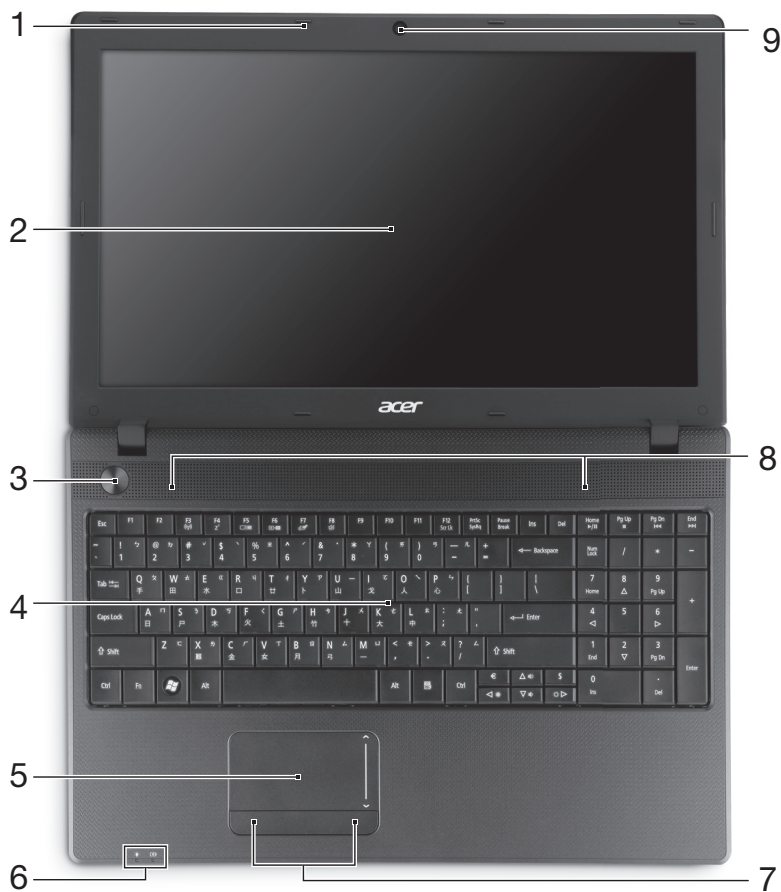

TOP VIEW







#	Icon	Item	Description
1		Microphone	Internal microphone for sound recording.

#	Icon	Item	Description
2		Display screen	Also called Liquid-Crystal Display (LCD), displays computer output (configuration may vary by model).
3		Power button	Turns the computer on and off.
4		Keyboard	For entering data into your computer.
5		Touchpad	Touch-sensitive pointing device which functions like a computer mouse.
6		Power indicator	Indicates the computer's power status.
		Battery indicator button	Press to indicate the computer's battery status.
7		Click buttons (left and right)	The left and right buttons function like the left and right mouse buttons.
8		Speakers	Deliver stereo audio output.
9		Integrated webcam	Web camera for video communication.

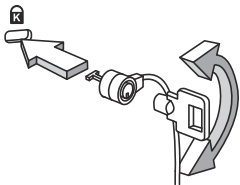
LEFT VIEW







#	Icon	Item	Description
1		Kensington lock slot 	Connects to a Kensington-compatible computer security lock. Note: Wrap the computer security lock cable around an immovable object such as a table or handle of a locked drawer. Insert the lock into the notch and turn the key to secure the lock. Some keyless models are also available.
2		External display (VGA) port	Connects to a display device (e.g., external monitor, LCD projector).
3		Ethernet (RJ-45) port	Connects to an Ethernet 10/100-based network.
4		USB 2.0 ports	Connect to USB 2.0 devices (e.g., USB mouse, USB camera).

#	Icon	Item	Description
6		2-in-1 card reader	Accepts Secure Digital (SD), MultiMediaCard (MMC). Note: Push to remove/install the card. Only one card can operate at any time.

RIGHT VIEW





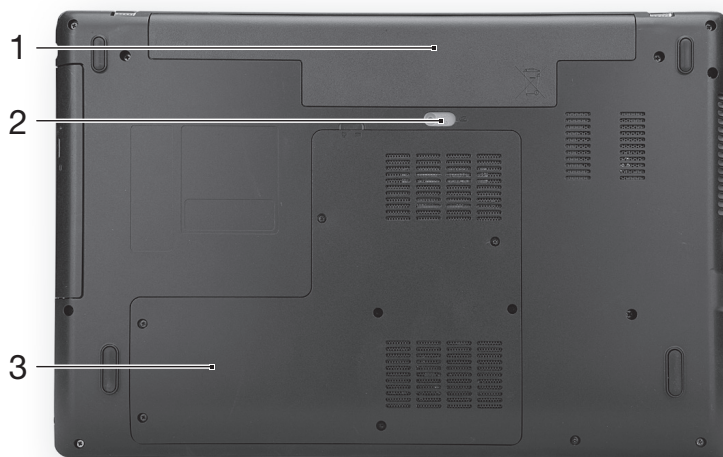

#	Icon	Item	Description
1		Microphone jack	Accepts inputs from external microphones.
		Headphone/speaker jack	Connects to audio devices (e.g., speakers, headphones).
2		USB 2.0 ports	Connect to USB 2.0 devices (e.g., USB mouse, USB camera).
3		Optical drive	Internal optical drive; accepts CDs or DVDs.
4		Optical disk access indicator	Lights up when the optical drive is active.

#	Icon	Item	Description
5		Optical drive eject button	Ejects the optical disk from the drive.
6		Emergency eject hole	Ejects the optical drive tray when the computer is turned off. Note: Insert a paper clip to the emergency eject hole to eject the optical drive tray when the computer is off.
7		DC-in jack	Connects to an AC adapter.

BASE VIEW



#	Icon	Item	Description
1		Battery bay	Houses the computer's battery pack.
2		Battery release latch/ lock	Releases the battery for removal. Insert a suitable tool into the latch and slide to release.
3		Memory compartment	Houses the computer's main memory.
		Hard disk bay	Houses the computer's hard disk (secured with screws).

TOUCHPAD

The built-in touchpad is a pointing device that senses movement on its surface. This means the cursor responds as you move your finger across the surface of the touchpad. The central location on the palmrest provides optimum comfort and support.

TOUCHPAD BASICS (WITH TWO BUTTONS)

The following items show you how to use the touchpad with two buttons.

- Move your finger across the touchpad to move the cursor.
- Press the left and right buttons located beneath the touchpad to perform selection and execution functions. These two buttons are similar to the left and right buttons on a mouse. Tapping on the touchpad is the same as clicking the left button.

Function	Left button	Right button	Main touchpad
Execute	Quickly click twice.		Tap twice (at the same speed as double-clicking a mouse button).
Select	Click once.		Tap once.

Function	Left button	Right button	Main touchpad
Drag	Click and hold, then use finger on the touchpad to drag the cursor.		Tap twice (at the same speed as double-clicking a mouse button); rest your finger on the touchpad on the second tap and drag the cursor.
Access context menu		Click once.	

Note: Illustrations for reference only. The exact configuration of your PC depends on the model purchased.

Note: When using the touchpad, keep it — and your fingers — dry and clean. The touchpad is sensitive to finger movement; hence, the lighter the touch, the better the response. Tapping harder will not increase the touchpad's responsiveness.

Note: By default, vertical and horizontal scrolling is enabled on your touchpad. It can be disabled under Mouse settings in Windows Control Panel.

USING THE KEYBOARD

The keyboard has full-sized keys and an embedded numeric keypad*, separate cursor, lock, Windows, function and special keys.

LOCK KEYS AND EMBEDDED NUMERIC KEYPAD

Note: Information in this section may not apply to your computer. The keyboard has three lock keys which you can toggle on and off.

Lock key	Description
Caps Lock	When Caps Lock is on, all alphabetic characters typed are in uppercase.
Num Lock <Fn> + <F11>*	When Num Lock is on, the embedded keypad is in numeric mode. The keys function as a calculator (complete with the arithmetic operators +, -, *, and /). Use this mode when you need to do a lot of numeric data entry. A better solution would be to connect an external keypad.
Scroll Lock <Fn> + <F12>	When Scroll Lock is on, the screen moves one line up or down when you press the up or down arrow keys respectively. Scroll Lock does not work with some applications.

The embedded numeric keypad functions like a desktop numeric keypad. It is indicated by small characters located on the upper right corner of the



keycaps. To simplify the keyboard legend, cursor-control key symbols are not printed on the keys.









Desired access	Num Lock on	Num Lock off
Number keys on embedded keypad	Type numbers in a normal manner.	
Cursor-control keys on embedded keypad	Hold <Shift> while using cursor-control keys.	Hold <Fn> while using cursor-control keys.
Main keyboard keys	Hold <Fn> while typing letters on embedded keypad.	Type the letters in a normal manner.

Hotkeys

The computer employs hotkeys or key combinations to access most of the computer's controls like screen brightness and volume output.

To activate hotkeys, press and hold the <Fn> key before pressing the other key in the hotkey combination.









Hotkey	Icon	Function	Description
<Fn> + <F3>		Communication key	Enables / disables the computer's communication devices. (Communication devices may vary by configuration.)
<Fn> + <F4>		Sleep	Puts the computer in Sleep mode.











Hotkey	Icon	Function	Description
<Fn> + <F5>		Display toggle	Switches display output between the display screen, external monitor (if connected) and both.
<Fn> + <F6>		Display off	Turns the display screen backlight off to save power. Press any key to return.
<Fn> + <F7>		Touchpad toggle	Turns the built-in touchpad on and off.
<Fn> + <F8>		Speaker toggle	Turns the speakers on and off.
<Fn> + <F11>		NumLk	Turns the embedded numeric keypad on or off (only for certain models).
<Fn> + <▷>		Brightness up	Increases the screen brightness.
<Fn> + <◁>		Brightness down	Decreases the screen brightness.
<Fn> + <△>		Volume up	Increases the sound volume.
<Fn> + <▽>		Volume down	Decreases the sound volume.
<Fn> + <Home>		Play/Pause	Play or pause a selected media file.

Hotkey	Icon	Function	Description
<Fn> + <Pg Up>	■	Stop	Stop playing the selected media file.
<Fn> + <Pg Dn>	⏮	Previous	Return to the previous media file.
<Fn> + <End>	⏭	Next	Jump to the next media file.

WINDOWS KEYS

The keyboard has two keys that perform Windows-specific functions.

Key	Description
 Windows key	<p>Pressed alone it launches the Start menu. It can also be used with other keys for other functions:</p> <ul style="list-style-type: none"> <  >: Open or close the Start menu <  > + <D>: Display the desktop <  > + <E>: Open Windows Explorer <  > + <F>: Search for a file or folder <  > + <G>: Cycle through Sidebar gadgets <  > + <L>: Lock your computer (if connected to a domain), or switch users (if not connected to a domain) <  > + <M>: Minimize all windows

Key	Description
<  > + < R >	Open the Run dialog box
<  > + < T >	Cycle through programs on the taskbar
<  > + < U >	Open Ease of Access Center
<  > + < X >	Open Windows Mobility Center
<  > + < Break >	Display System Properties
<  > + < Shift+M >	Restore minimized windows
<  > + < Tab >	Cycle through programs on the taskbar by using Windows Flip 3-D
<  > + < Space >	Bring all gadgets to the front and select Windows Sidebar
< CTRL > + <  > + < F >	Search for network computers
< CTRL > + <  > + < Tab >	Use the arrow keys to cycle through open programs using Windows Flip 3-D



Application key

This key has the same effect as clicking the right mouse button; it opens the application's context menu.

Note: Depending on your edition of Windows, some shortcuts may not function as described.

ACER BACKUP MANAGER

Acer Backup Manager is a simple three-step process that allows you to create backup copies of your entire system or selected files and folders according to a schedule or as you need to.

To start Acer Backup Manager, press the Acer Backup Manager key above the keyboard. Alternatively, you can go to **Start > All Programs > Acer Backup Manager > Acer Backup Manager**. This will open the Welcome screen; from this screen you can select the type of backup you'd like to create.

- **Back Up my Files:** Select files to back up.
- **Image My Drive:** Create a backup file for the entire drive. You can burn this file to a DVD to restore your computer at a later time or create the file on a USB drive.
- **Migrate My Files:** Allows you to copy files to a USB device so that you can migrate your files to a new computer.

Select the backup type you'd like to make and select the files or drive you want to back up, then follow the onscreen instructions:

1. Select the content you want to back up. The less content you select, the quicker the process will be, but it will increase your risks of losing data.
2. Select where you want the backup copies to be stored. You will need to select an external drive or your D: drive; Acer Backup Manager cannot store a backup on the source drive.

3. Select how often you want Acer Backup Manager to create backups. Once you have finished these three steps, backups will be created according to the schedule. You can also create backups manually by pressing the Acer Backup Manager key.

If you wish to change your settings at any time, run Acer Backup Manager from the **Start** menu and go through the steps outlined above.



ACER eRECOVERY MANAGEMENT

If your computer experiences problems that are not recoverable by other methods, you may need to reinstall the Windows operating system and factory-loaded software and drivers. To ensure you can recover your computer when needed, you should create a recovery backup as soon as possible.

Acer eRecovery Management consists of the following functions:

1. Backup:

- Create Factory Default Backup
- Backup Drivers and Applications

2. Restore:

- Restore Operating System to Factory Defaults
- Restore Operating System and Retain User Data
- Reinstall Drivers or Applications

This chapter will guide you through each process.

To use the password protection feature of Acer eRecovery Management, you must first set the password. The password is set by launching Acer eRecovery Management and clicking **Settings**.

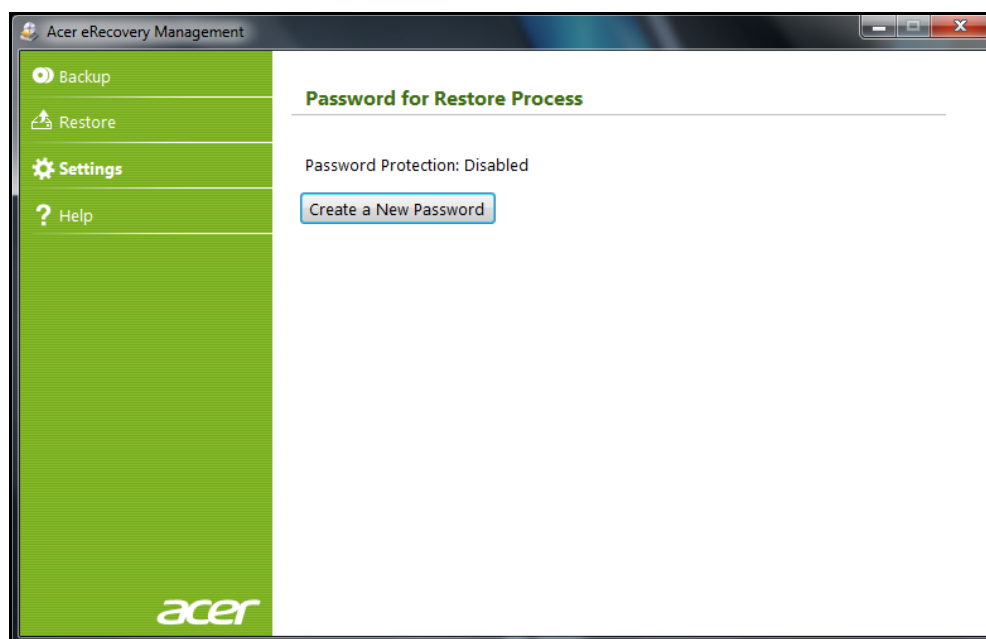

CREATING A RECOVERY BACKUP

To reinstall using a backup on optical discs, you must create the recovery disc beforehand. Throughout the process, you will be guided by onscreen instructions. Please read them carefully!

1. Click **Start > All Programs > Acer**, then click **Acer eRecovery Management**.

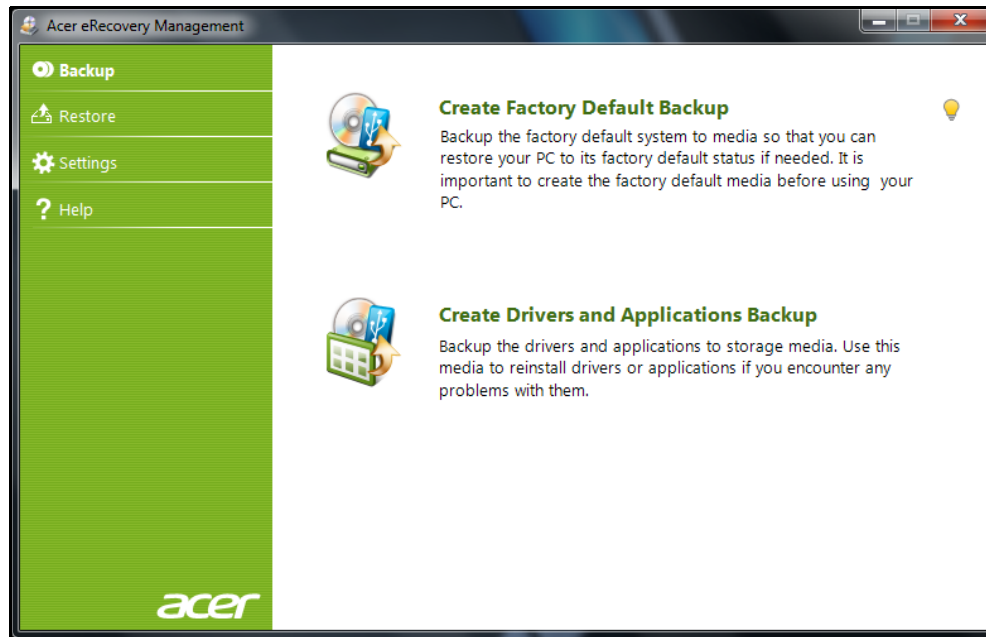

To create recovery discs for the hard drive's entire original contents, including Windows and all factory-loaded software and drivers, click **Create Factory Default Disc**.

- OR -

To create a recovery disc for only the factory-loaded software and drivers, click **Create Drivers and Applications Backup Disc**.

Important: We recommend that you create each type of recovery backup as soon as possible.

The Create Factory Default Backup dialog box tells you the number of blank, recordable discs you will need to complete the recovery discs.

Make sure that you have the required number of identical, blank discs ready before continuing.

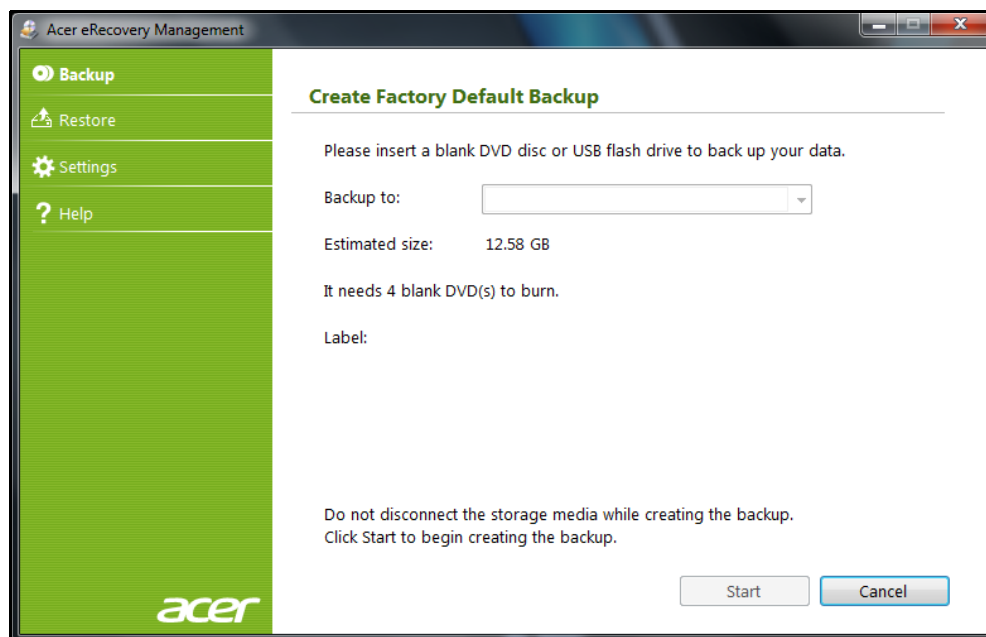

2. Insert a blank disc into the drive indicated in the **Backup to** list, then click **Next**. You will be shown the backup progress on the screen.

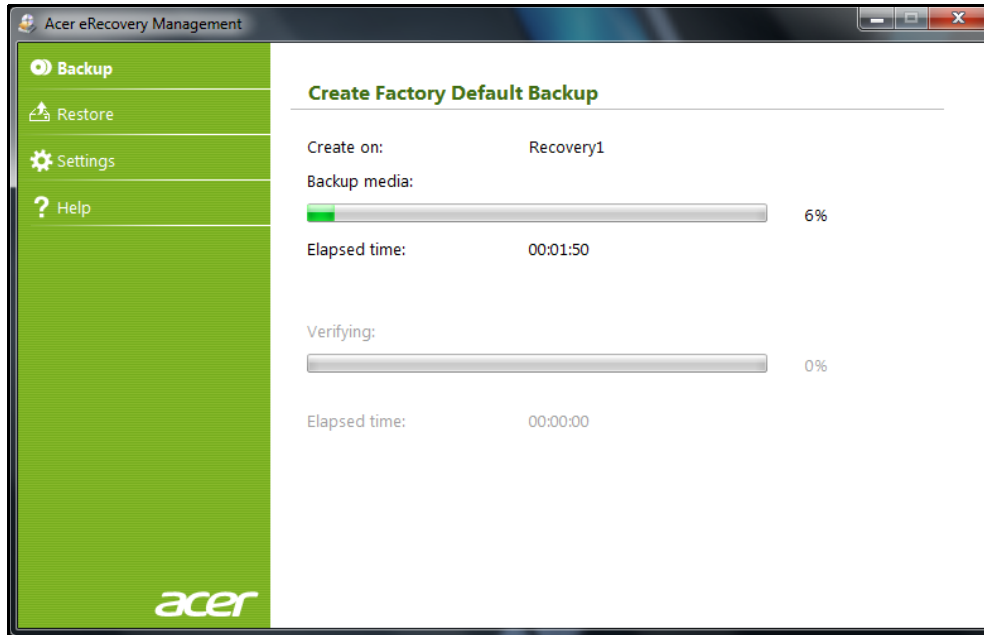

The drive ejects each disc as it completes burning it.

3. Remove the disc from the drive and mark it with a permanent marker.

Note: Write a unique, descriptive label on each disc, such as 'Windows Recovery Disc 1 of 2' or 'Apps/Drivers Recovery disc'. Make sure you keep the discs in a safe place that you will remember.

4. If multiple discs are required, insert a new disc when prompted, then click **OK**. Continue recording discs until the process is complete.

RECOVERING YOUR SYSTEM

If calling Acer support did not help fix your problem, you can use the Acer eRecovery Management program. This will restore your computer to the

same state as when you purchased it, while giving you an option to retain all settings and personal data for later retrieval.

To recover your system

1. Perform minor fixes.

If only one or two items of software or hardware have stopped working correctly, the problem may be solved by reinstalling the software or the device drivers. To recover software and drivers that were pre-installed at the factory, see **"Recovering pre-installed software and drivers" on page 52**. For instructions on reinstalling software and drivers that were not pre-installed, see that product's documentation or technical support Web site.

2. Revert to a previous system condition.

If reinstalling software or drivers does not help, then the problem may be solved by returning your system to a previous state when everything was working correctly. For instructions, see **"Returning to a previous system condition" on page 53**.

3. Reset your system to its factory condition.

If nothing else has solved the problem and you want to reset your system to factory condition, see **"Returning your system to its factory condition" on page 54**.

TYPES OF RECOVERY

Recovering pre-installed software and drivers

As a troubleshooting step, you may need to reinstall the software and device drivers that came pre-installed on your computer from the factory. You can recover using either your hard drive or the recovery discs you have created.

- **New software:** If you need to recover software that did not come pre-installed on your computer, you need to follow that software's installation instructions.
- **New device drivers:** If you need to recover device drivers that did not come pre-installed on your computer, follow the instructions provided with the device.

To recover your pre-installed software and drivers:

Click **Start** > **All Programs** > **Acer**, then click **Acer eRecovery Management**.

- OR -

If you are recovering from your driver and application recovery disc, insert it into the disc drive, then go to Step 3 after the Acer Application Recovery main menu opens.

1. Click the **Restore** tab, then click **Reinstall Drivers or Applications** to display the Acer Application Recovery main menu.

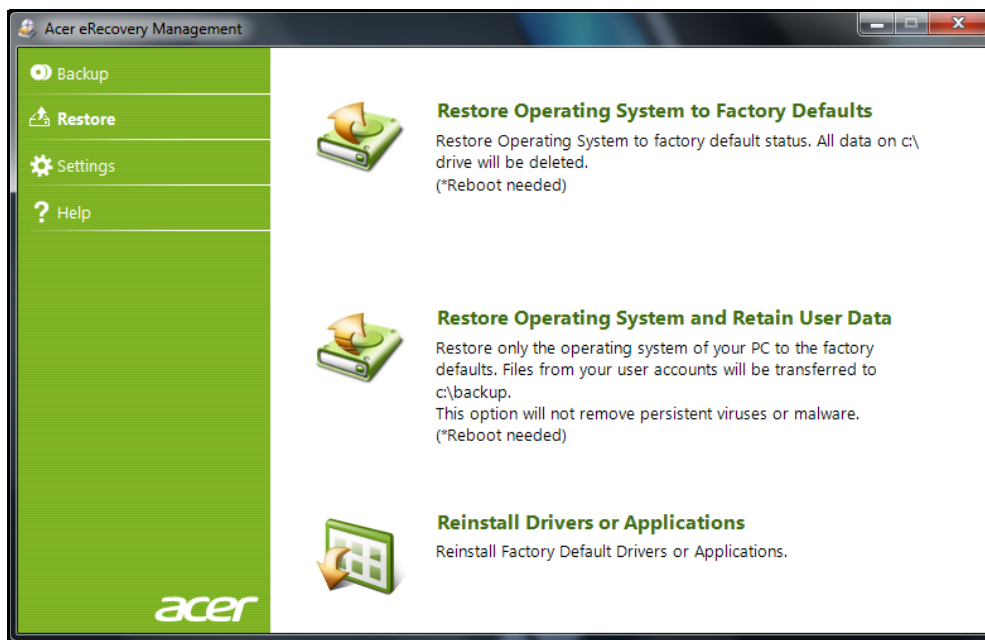

2. Click **Contents** to show a list of software and device drivers.
3. Click the install icon for the item you want to install, then follow the onscreen prompts to complete the installation. Repeat this step for each item you want to reinstall.

Returning to a previous system condition

Microsoft System Restore periodically takes 'snapshots' of your system settings and saves them as restore points. In most cases of hard-to-

resolve software problems, you can return to one of these restore points to get your system running again.

Windows automatically creates an additional restore point each day, and also each time you install software or device drivers.

Tip: For more information about using Microsoft System Restore, click Start, then click Help and Support. Type windows system restore in the Search Help box, then press Enter.

To return to a restore point:

1. Click **Start** > **Control Panel** > **System and Security** > **Action Center**, then click **Recovery**.
2. Click **Open System Restore**, then **Next**.
3. Select the restore point you want, click **Next**, then **Finish**. A confirmation message box will appear.
4. Click **Yes**. Your system is restored using the restore point you specified. This process may take several minutes, and may restart your computer.

Returning your system to its factory condition

If your computer experiences problems that are not recoverable by other methods, you may need to reinstall everything to return your system to its factory condition. You can reinstall using either your hard drive or the recovery discs you have created.

Warning: This complete recovery deletes everything on your hard drive, then reinstalls Windows and all software and drivers that

were pre-installed on your system. If you can access important files on your hard drive, back them up now.

If you can still run Windows, see "**Recovering from within Windows**" on page 55.

If you cannot run Windows and your original hard drive is still working, see "**Recovering from the hard drive during startup**" on page 56.

If you cannot run Windows and your original hard drive has been completely re-formatted or you have installed a replacement hard drive, see "**Recovering from your recovery discs**" on page 56.

Recovering from within Windows

To reinstall Windows and all pre-installed software and drivers:

Click **Start** > **All Programs** > **Acer**, then click **Acer eRecovery Management**.

Click the **Restore** tab, then **Restore Operating System to Factory Defaults**.

Click **Yes**, then **Start**. A dialog box will display information about the hard drive that the operating system will be recovered to.

Warning: Continuing the process will erase all files on your hard drive.

Click **OK**. The recovery process begins by restarting your computer, then continues by copying files to your hard drive. This process may take a while, the Acer eRecovery Management screen displays the progress.

When the recovery has finished, a dialog box will prompt you to restart your computer.

Click **OK** to restart your computer.

Follow the onscreen prompts for first-time system setup.

Recovering from the hard drive during startup

To reinstall Windows and all pre-installed software and drivers:

1. Turn on your computer, then press <**Alt**> + <**F10**> during startup to open Acer eRecovery Management.
2. Click **Restore Operating System to Factory Defaults**.
3. Warning: Continuing the process will erase all files on your hard drive.
4. Click **Next**. Your hard drive's original, factory-loaded contents will be recovered. This process will take several minutes.

Recovering from your recovery discs

To reinstall Windows and all pre-installed software and drivers:

1. Turn on your computer, insert the first system recovery disc into your optical disc drive, then restart your computer.

Warning: Continuing the process will erase all files on your hard drive.

If it is not already enabled, you must enable the F12 Boot Menu:

Press <**F2**> when starting your computer.

Use the left or right arrow keys to select the Main menu.

Press the down key until F12 Boot Menu is selected, press <**F5**> to change this setting to Enabled.

Use the left or right arrow keys to select the Exit menu.

Select **Save Changes and Exit** and press Enter. Select **OK** to confirm.

Your computer will restart.

1. During startup, press <**F12**> to open the boot menu. The boot menu allows you to select which device to start from, such as the hard drive or an optical disc.
2. Use your arrow keys to select the line **CDROM/DVD** (this line may start with 'IDE 1...'), then press <**Enter**>. Windows will install from the recovery disc you inserted.
3. Insert the second recovery disc when prompted, then follow the onscreen prompts to complete the recovery.

TAKING YOUR NOTEBOOK PC WITH YOU

This section gives you tips and hints to consider when moving around or traveling with your computer.

DISCONNECTING FROM THE DESKTOP

Follow these steps to disconnect your computer from external accessories:

1. Save any open files.
2. Remove any media, floppy disks or compact disks from the drive(s).
3. Shut down the computer.
4. Close the display cover.
5. Disconnect the cord from the AC adapter.
6. Disconnect the keyboard, pointing device, printer, external monitor and other external devices.
7. Disconnect the Kensington lock if you are using one to secure the computer.

MOVING AROUND

When you are just moving within short distances, for example, from your office desk to a meeting room.

Preparing the computer

Before moving the computer, close and latch the display cover to place it in Sleep mode. You can now safely take the computer anywhere you go within the building. To bring the computer out of Sleep mode, open the display; then press and release the power button.

If you are taking the computer to a client's office or a different building, you may choose to shut down the computer:

Click **Start** then click **Shut Down**.

Or:

You can put the computer in Sleep mode by pressing <Fn> + <F4>. Then close and latch the display.

When you are ready to use the computer again, unlatch and open the display; then press and release the power button.

Note: If the Sleep indicator is off, the computer has entered Hibernation mode and is turned off. If the power indicator is off but the Sleep indicator is on, the computer has entered Sleep mode. In both cases, press and release the power button to turn the computer back on. Note that the computer may enter Hibernation mode after being in Sleep mode for a period of time.

What to bring to meetings

If your meeting is relatively short, you probably do not need to bring anything with you other than your computer. If your meeting will be longer, or if your battery is not fully charged, you may want to bring the AC adapter with you to plug in your computer in the meeting room.

If the meeting room does not have an electrical outlet, reduce the drain on the battery by putting the computer in Sleep mode. Press <Fn> + <F4> or close the display cover whenever you are not actively using the computer. To resume, open the display (if closed), then press and release the power button.

TAKING THE COMPUTER HOME

When you are moving from your office to your home or vice versa.

Preparing the computer

After disconnecting the computer from your desktop, follow these steps to prepare the computer for the trip home:

- Check that you have removed all media and compact discs from the drive(s). Failure to remove the media can damage the drive head.
- Pack the computer in a protective case that can prevent the computer from sliding around and cushion it if it should fall.

Caution: Avoid packing items next to the top cover of the computer. Pressure against the top cover can damage the screen.

What to take with you

Unless you have some items at home, take the following items with you:

- AC adapter and power cord.
- The printed setup poster.

Special considerations

Follow these guidelines to protect your computer while traveling to and from work:

- Minimize the effects of temperature changes by keeping the computer with you.
- If you need to stop for an extended period of time and cannot carry the computer with you, leave the computer in the trunk of the car to avoid exposing the computer to excessive heat.
- Changes in temperature and humidity can cause condensation. Allow the computer to return to room temperature, and inspect the screen for condensation before turning on the computer. If the temperature change is greater than 10° C (18° F), allow the computer to come to room temperature slowly. If possible, leave the computer for 30 minutes in an environment with a temperature between outside and room temperature.

Setting up a home office

If you frequently work on your computer at home, you may want to purchase a second AC adapter for use at home. With a second AC adapter, you can avoid carrying the extra weight to and from home.

If you use your computer at home for significant periods of time, you might also want to add an external keyboard, monitor or mouse.

TRAVELING WITH THE COMPUTER

When you are moving within a larger distance, for instance, from your office building to a client's office building or traveling locally.

Preparing the computer

Prepare the computer as if you were taking it home. Make sure that the battery in the computer is charged. Airport security may require you to turn on your computer when carrying it into the gate area.

What to take with you

Take the following items with you:

- AC adapter
- Spare, fully-charged battery pack(s)
- Additional printer driver files if you plan to use another printer

Special considerations

In addition to the guidelines for taking the computer home, follow these guidelines to protect your computer while traveling:

- Always take the computer as carry-on luggage.
- If possible, have the computer inspected by hand. Airport security X-ray machines are safe, but do not put the computer through a metal detector.
- Avoid exposing floppy disks to hand-held metal detectors.

TRAVELING INTERNATIONALLY WITH THE COMPUTER

When you are moving from country to country.

Preparing the computer

Prepare the computer as you would normally prepare it for traveling.

What to bring with you

Bring the following items with you:

- AC adapter
- Power cords that are appropriate for the country to which you are traveling
- Spare, fully-charged battery packs
- Additional printer driver files if you plan to use another printer
- Proof of purchase, in case you need to show it to customs officials
- International Travelers Warranty passport

Special considerations

Follow the same special considerations as when traveling with the computer.

In addition, these tips are useful when traveling internationally:

- When traveling in another country, check that the local AC voltage and the AC adapter power cord specifications are compatible. If not, purchase a power cord that is compatible with the local AC voltage. Do not use converter kits sold for appliances to power the computer.

- If you are using the modem, check if the modem and connector are compatible with the telecommunications system of the country you are traveling in.

SECURING YOUR COMPUTER

Your computer is a valuable investment that you need to take care of. Learn how to protect and take care of your computer.

Security features include hardware and software locks — a security notch and passwords.

USING A COMPUTER SECURITY LOCK

The notebook comes with a Kensington-compatible security slot for a security lock.

Wrap a computer security lock cable around an immovable object such as a table or handle of a locked drawer. Insert the lock into the notch and turn the key to secure the lock. Some keyless models are also available.

USING PASSWORDS

Passwords protect your computer from unauthorized access. Setting these passwords creates several different levels of protection for your computer and data:

- Supervisor Password prevents unauthorized entry into the BIOS utility. Once set, you must enter this password to gain access to the BIOS utility. See "**BIOS utility**" on page 13.

- User Password secures your computer against unauthorized use. Combine the use of this password with password checkpoints on boot-up and resume from Hibernation for maximum security.
- Password on Boot secures your computer against unauthorized use. Combine the use of this password with password checkpoints on boot-up and resume from Hibernation for maximum security.

Important! Do not forget your Supervisor Password! If you forget your password, please get in touch with your dealer or an authorized service center.

Entering passwords

When a password is set, a password prompt appears in the center of the display screen.

- When the Supervisor Password is set, a prompt appears when you press <**F2**> to enter the BIOS utility at boot-up.
- Type the Supervisor Password and press <**Enter**> to access the BIOS utility. If you enter the password incorrectly, a warning message appears. Try again and press <**Enter**>.
- When the User Password is set and the password on boot parameter is enabled, a prompt appears at boot-up.
- Type the User Password and press <**Enter**> to use the computer. If you enter the password incorrectly, a warning message appears. Try again and press <**Enter**>.

Important! You have three chances to enter a password. If you fail to enter the password correctly after three tries, the system

halts. Press and hold the power button for four seconds to shut down the computer. Then turn on the computer again, and try again.

Setting passwords

You can set passwords using the BIOS utility.

BIOS UTILITY

The BIOS utility is a hardware configuration program built into your computer's BIOS.

Your computer is already properly configured and optimized, and you do not need to run this utility. However, if you encounter configuration problems, you may need to run it.

To activate the BIOS utility, press <**F2**> during the POST while the notebook PC logo is being displayed.

BOOT SEQUENCE

To set the boot sequence in the BIOS utility, activate the BIOS utility, then select **Boot** from the categories listed at the top of the screen.

ENABLE DISK-TO-DISK RECOVERY

To enable disk-to-disk recovery (hard disk recovery), activate the BIOS utility, then select **Main** from the categories listed at the top of the screen. Find **D2D Recovery** at the bottom of the screen and use the <**F5**> and <**F6**> keys to set this value to **Enabled**.

SETTING PASSWORDS

To set a password on boot, activate the BIOS utility, then select **Security** from the categories listed at the top of the screen. Find **Password on boot:** and use the <**F5**> and <**F6**> keys to enable this feature.

CONNECTING TO A NETWORK

Your notebook PC offers you a complete mobile computing experience.

CONNECTIVITY OPTIONS

Ports allow you to connect peripheral devices to your computer as you would with a desktop PC. For instructions on how to connect different external devices to the computer, read the following section.

Built-in network feature

The built-in network feature allows you to connect your computer to an Ethernet-based network.

To use the network feature, connect an Ethernet cable from the Ethernet (RJ-45) port on the chassis of the computer to a network jack or hub on your network.

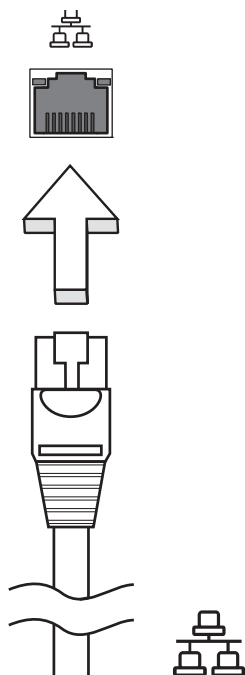

PLAYING DVD MOVIES

When the DVD drive module is installed in the optical drive bay, you can play DVD movies on your computer.

1. Eject the DVD.

Important! When you launch the DVD player for the first time, the program asks you to enter the region code. DVD discs are divided into 6 regions. Once your DVD drive is set to a region code, it will play DVD disks of that region only. You can set the region code a maximum of five times (including the first time), after which the last region code set will remain permanent. Recovering your hard disk does not reset the number of times the region code has been set. Refer to the table below for DVD movie region code information.

2. The DVD movie will automatically play after a few seconds.

Region code	Country or region
1	USA, Canada
2	Europe, Middle East, South Africa, Japan
3	Southeast Asia, Taiwan, South Korea
4	Latin America, Australia, New Zealand
5	Former USSR, parts of Africa, India
6	People's Republic of China

Note: To change the region code, insert a DVD movie of a different region into the DVD drive. Please refer to the online help for more information.

UPGRADING MEMORY

Follow these steps to install memory:

1. Turn off the computer, unplug the AC adapter (if connected) and remove the battery pack. Then turn the computer over to access its base.
2. Remove the screws from the memory cover; then lift and remove the memory cover.
3. **(a)** Insert the memory module diagonally into the slot, then **(b)** gently press it down until it clicks into place.

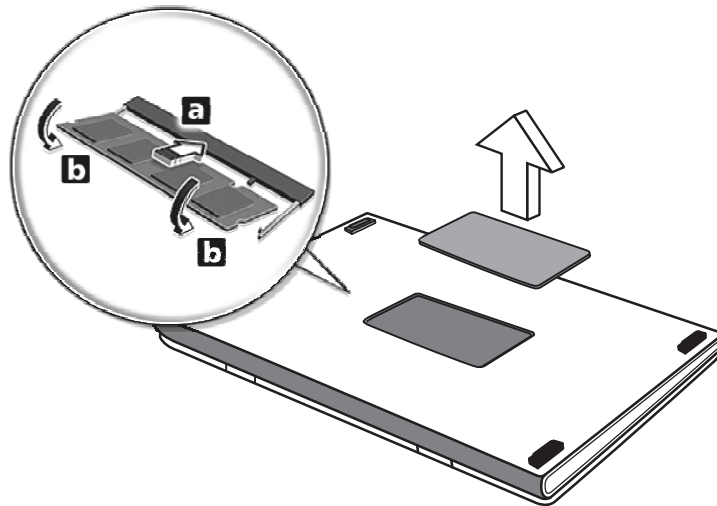

4. Replace the memory cover and secure it with the screw.
5. Reinstall the battery pack, and reconnect the AC adapter.
6. Turn on the computer.

The computer automatically detects and reconfigures the total memory size. Please consult a qualified technician or contact your local Acer dealer.

UNIVERSAL SERIAL BUS (USB)

The USB 2.0 port is a high-speed serial bus which allows you to connect USB peripherals without taking up system resources.

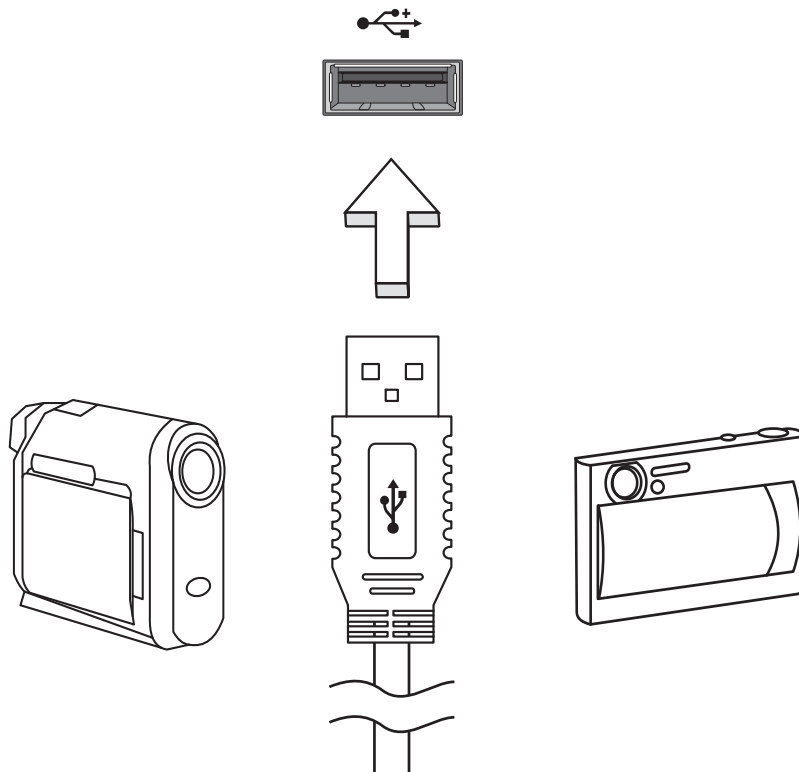

BATTERY PACK

The computer uses a battery pack that gives you long use between charges.

BATTERY PACK CHARACTERISTICS

The battery pack has the following characteristics:

- Employs current battery technology standards.
- Delivers a battery-low warning.

The battery is recharged whenever you connect the computer to the AC adapter. Your computer supports charge-in-use, enabling you to recharge the battery while you continue to operate the computer. However, recharging with the computer turned off results in a significantly faster charge time.

The battery will come in handy when you travel or during a power failure. It is advisable to have an extra fully charged battery pack available as backup. Contact your dealer for details on ordering a spare battery pack.

Charging the battery

To charge the battery, first make sure that it is correctly installed in the battery bay. Plug the AC adapter into the computer, and connect to a mains power outlet. You can continue to operate your computer on AC power while your battery is charging. However, charging the battery with the computer turned off results in a significantly faster charge time.

Note: You are advised to charge the battery before retiring for the day. Charging the battery overnight before traveling enables you to start the next day with a fully charged battery.

Conditioning a new battery pack

Before you use a battery pack for the first time, there is a conditioning process that you should follow:

1. Insert the new battery without turning the computer on.
2. Connect the AC adapter and fully charge the battery.
3. Disconnect the AC adapter.
4. Turn on the computer and operate using battery power.
5. Fully deplete the battery until the battery-low warning appears.
6. Reconnect the AC adapter and fully charge the battery again.

Follow these steps again until the battery has been charged and discharged three times.

Use this conditioning process for all new batteries, or if a battery hasn't been used for a long time. If the computer is to be stored for more than two weeks, you are advised to remove the battery pack from the unit.

Warning: Do not expose battery packs to temperatures below 0° C (32° F) or above 45° C (113° F). Extreme temperatures may adversely affect the battery pack.

By following the battery conditioning process you condition your battery to accept the maximum possible charge. Failure to follow this procedure

will prevent you from obtaining the maximum battery charge, and will also shorten the effective lifespan of the battery.

In addition, the useful lifespan of the battery is adversely affected by the following usage patterns:

- Using the computer on constant AC power with the battery inserted. If you want to use constant AC power, you are advised to remove the battery pack after it is fully charged.
- Not discharging and recharging the battery to its extremes, as described above.
- Frequent use; the more you use the battery, the faster it will reach the end of its effective life. A standard computer battery has a life span of about 300 charges.

Optimizing battery life

Optimizing battery life helps you get the most out of battery operation, prolonging the charge/recharge cycle and improving recharging efficiency. You are advised to follow the suggestions set out below:

- Purchase an extra battery pack.
- Use AC power whenever possible, reserving battery for on-the-go use.
- Eject a PC Card if it is not being used, as it will continue to draw power (for selected models).
- Store the battery pack in a cool, dry place. The recommended temperature is 10° C (50° F) to 30° C (86° F). Higher temperatures cause the battery to self-discharge faster.
- Excessive recharging decreases the battery life.

- Look after your AC adapter and battery.

Checking the battery level

The Windows power meter indicates the current battery level. Rest the cursor over the battery/power icon on the taskbar to see the battery's present charge level.

Battery-low warning

When using battery power pay attention to the Windows power meter.

Warning: Connect the AC adapter as soon as possible after the battery-low warning appears. Data will be lost if the battery to become fully depleted and the computer shuts down.

When the battery-low warning appears, the recommended course of action depends on your situation:

Situation	Recommended Action
The AC adapter and a power outlet are available.	<ol style="list-style-type: none">1. Plug the AC adapter into the computer, and then connect to the mains power supply.2. Save all necessary files.3. Resume work. <p>Turn off the computer if you want to recharge the battery rapidly.</p>

Situation	Recommended Action
An extra fully charged battery pack is available.	<ol style="list-style-type: none"> 1. Save all necessary files. 2. Close all applications. 3. Turn off the computer. 4. Replace the battery pack. 5. Turn on the computer and resume work.
The AC adapter or a power outlet is unavailable. You have no spare battery pack.	<ol style="list-style-type: none"> 1. Save all necessary files. 2. Close all applications. 3. Turn off the computer.

Installing and removing the battery pack

Important! Before removing the battery from the unit, connect the AC adapter if you want to continue using your computer. Otherwise, turn off the computer first.

To install a battery pack:

1. Align the battery with the open battery bay; make sure that the end with the contacts will enter first, and that the top surface of the battery is facing up.
2. Slide the battery into the battery bay and gently push until the battery locks in place.

To remove a battery pack:

1. Slide the battery release latch to release the battery.
2. Pull the battery from the battery bay.

FREQUENTLY ASKED QUESTIONS

The following is a list of possible situations that may arise during the use of your computer. Easy solutions are provided for each one.

I turned on the power, but the computer does not start or boot up.

Look at the power indicator:

- If it is not lit, no power is being supplied to the computer. Check the following:
 - If you are using on the battery, it may be low and unable to power the computer. Connect the AC adapter to recharge the battery pack.
 - Make sure that the AC adapter is properly plugged into the computer and to the power outlet.
- If it is lit, check the following:
 - Is a disc in the optical drive? Remove it and press <Ctrl> + <Alt> + to restart the system.
 - Do you have a USB storage device (USB disk or smartphone) plugged into your computer? Unplug it and press <Ctrl> + <Alt> + to restart the system.

Nothing appears on the screen.

The computer's power management system automatically blanks the screen to save power. Press any key to turn the display back on.

If pressing a key does not turn the display back on, three things might be the cause:

- The brightness level might be too low. Press <Fn> + <▷> (increase) to adjust the brightness level.
- The display device might be set to an external monitor. Press the display toggle hotkey <Fn> + <F5> to toggle the display back to the computer.
- If the Sleep indicator is lit, the computer is in Sleep mode. Press and release the power button to resume.

No audio is heard from the computer.

Check the following:

- The volume may be muted. In Windows, look at the volume control (speaker) icon on the taskbar. If it is crossed-out, click the icon and deselect the **Mute all** option.
- The volume level may be too low. In Windows, look at the volume control icon on the taskbar. You can also use the volume control buttons to adjust the volume.
- If headphones, earphones or external speakers are connected to the line-out port on the computer, the internal speakers automatically turn off.

I want to eject the optical drive tray without turning on the power.

There is a mechanical eject hole on the optical drive. Simply insert the tip of a pen or paperclip into the hole and push to eject the tray.

The keyboard does not respond.

Try attaching an external keyboard to a USB port on the computer. If it works, contact your dealer or an authorized service center as the internal keyboard cable may be loose.

The printer does not work.

Check the following:

- Make sure that the printer is connected to a power outlet and that it is turned on.
- Make sure that the printer cable is connected securely to a USB port and the corresponding port on the printer.

I want to restore my computer to its original settings without recovery CDs.

Note: If your system is the multilingual version, the operating system and language you choose when you first turn on the system will be the only option for future recovery operations.

This recovery process helps you restore the C: drive with the original software content that is installed when you purchased your notebook. Follow the steps below to rebuild your C: drive. (Your C: drive will be reformatted and all data will be erased.) It is important to back up all data files before using this option.

Before performing a restore operation, please check the BIOS settings.

1. Check to see if **Acer disk-to-disk recovery** is enabled or not.
2. Make sure the **D2D Recovery** setting in **Main** is **Enabled**.

3. Exit the BIOS utility and save changes. The system will reboot.

Note: To activate the BIOS utility, press <**F2**> during POST.

To start the recovery process:

1. Restart the system.
2. While the Acer logo is showing, press <**Alt**> + <**F10**> at the same time to enter the recovery process.
3. Refer to the onscreen instructions to perform system recovery.

Important! This feature occupies 15 GB in a hidden partition on your hard disk.

REQUESTING SERVICE

International Travelers Warranty (ITW)

Your computer is backed by an International Travelers Warranty (ITW) that gives you security and peace of mind when traveling. Our worldwide network of service centers are there to give you a helping hand.

An ITW passport comes with your computer. This passport contains all you need to know about the ITW program. A list of available, authorized service centers is in this handy booklet. Read this passport thoroughly.

Always have your ITW passport on hand, especially when you travel, to receive the benefits from our support centers. Place your proof-of-purchase in the flap located inside the front cover of the ITW passport.

If the country you are traveling in does not have an Acer-authorized ITW service site, you can still get in contact with our offices worldwide. Please visit **www.acer.com**.

Before you call

Please have the following information available when you call Acer for online service, and please be at your computer when you call. With your support, we can reduce the amount of time a call takes and help solve your problems efficiently. If there are error messages or beeps reported by your computer, write them down as they appear on the screen (or the number and sequence in the case of beeps).

You are required to provide the following information:

Name: _____

Address: _____

Telephone number: _____

Machine and model type: _____

Serial number: _____

Date of purchase: _____

TROUBLESHOOTING

This chapter shows you how to deal with common system problems. Read it before calling a technician if a problem occurs. Solutions to more serious problems require opening up the computer. Do not attempt to open the computer yourself; contact your dealer or authorized service center for assistance.

Troubleshooting tips

This notebook PC incorporates an advanced design that delivers onscreen error message reports to help you solve problems.

If the system reports an error message or an error symptom occurs, see "Error messages" below. If the problem cannot be resolved, contact your dealer. See "**Requesting service**" on page 84.

Error messages

If you receive an error message, note the message and take the corrective action. The following table lists the error messages in alphabetical order together with the recommended course of action.

Error messages	Corrective action
CMOS battery bad	Contact your dealer or an authorized service center.
CMOS checksum error	Contact your dealer or an authorized service center.

Error messages	Corrective action
Disk boot failure	Insert a system (bootable) disk, then press < Enter > to reboot.
Equipment configuration error	Press < F2 > (during POST) to enter the BIOS utility, then press Exit in the BIOS utility to reboot.
Hard disk 0 error	Contact your dealer or an authorized service center.
Hard disk 0 extended type error	Contact your dealer or an authorized service center.
I/O parity error	Contact your dealer or an authorized service center.
Keyboard error or no keyboard connected	Contact your dealer or an authorized service center.
Keyboard interface error	Contact your dealer or an authorized service center.
Memory size mismatch	Press < F2 > (during POST) to enter the BIOS utility, then press Exit in the BIOS utility to reboot.

If you still encounter problems after going through the corrective measures, please contact your dealer or an authorized service center for assistance.

REGULATIONS AND SAFETY NOTICES

FCC STATEMENT

This device has been tested and found to comply with the limits for a Class B digital device pursuant to Part 15 of the FCC rules. These limits are designed to provide reasonable protection against harmful interference in a residential installation. This device generates, uses, and can radiate radio frequency energy and, if not installed and used in accordance with the instructions, may cause harmful interference to radio communications.

However, there is no guarantee that interference will not occur in a particular installation. If this device does cause harmful interference to radio or television reception, which can be determined by turning the device off and on, the user is encouraged to try to correct the interference by one or more of the following measures:

- Reorient or relocate the receiving antenna.
- Increase the separation between the device and receiver.
- Connect the device into an outlet on a circuit different from that to which the receiver is connected.
- Consult the dealer or an experienced radio/television technician for help.

Notice: Shielded cables

All connections to other computing devices must be made using shielded cables to maintain compliance with FCC regulations.

NOTICE: PERIPHERAL DEVICES

Only peripherals (input/output devices, terminals, printers, etc.) certified to comply with the Class B limits may be attached to this equipment. Operation with non-certified peripherals is likely to result in interference to radio and TV reception.

Caution: Changes or modifications not expressly approved by the manufacturer could void the user's authority, which is granted by the Federal Communications Commission, to operate this computer.

NOTICE FOR CANADA

This Class B digital apparatus complies with Canadian ICES-003.

Remarque à l'intention des utilisateurs canadiens

Cet appareil numérique de la classe B est conforme à la norme NMB-003 du Canada.

COMPLIANT WITH RUSSIAN REGULATORY CERTIFICATION



LCD PIXEL STATEMENT

The LCD unit is produced with high-precision manufacturing techniques. Nevertheless, some pixels may occasionally misfire or appear as black or red dots. This has no effect on the recorded image and does not constitute a malfunction.

RADIO DEVICE REGULATORY NOTICES

Note: Below regulatory information is for models with wireless LAN and / or Bluetooth only.

To prevent radio interference to the licensed service, this device is intended to be operated indoors.

This product complies with the radio frequency and safety standards of any country or region in which it has been approved for wireless use. Depending on configurations, this product may or may not contain wireless radio devices (such as wireless LAN and/or Bluetooth modules). Below information is for products with such devices.

Declaration of Conformity for EU countries

Hereby, Acer, declares that this computer is in compliance with the essential requirements and other relevant provisions of Directive 1999/5/EC.

Wireless operation channels for different domains

N. America	2.412-2.462 GHz	Ch01 through Ch11
Japan	2.412-2.484 GHz	Ch01 through Ch14
Europe ETSI	2.412-2.472 GHz	Ch01 through Ch13

France: Restricted wireless frequency bands

Some areas of France have a restricted frequency band. The worst case maximum authorized power indoors is:

- 10 mW for the entire 2.4 GHz band (2400 MHz - 2483.5 MHz)
- 100 mW for frequencies between 2446.5 MHz and 2483.5 MHz

Note: Channels 10 through 13 inclusive operate in the band 2446.6 MHz to 2483.5 MHz.

There are few possibilities for outdoor use: On private property or on the private property of public persons, use is subject to a preliminary authorization procedure by the Ministry of Defense, with maximum authorized power of 100 mW in the 2446.5 - 2483.5 MHz band. Use outdoors on public property is not permitted.

In the departments listed below, for the entire 2.4 GHz band:

- Maximum authorized power indoors is 100 mW
- Maximum authorized power outdoors is 10 mW

Departments in which the use of the 2400 - 2483.5 MHz band is permitted with an EIRP of less than 100 mW indoors and less than 10 mW outdoors:

01 Ain Orientales	25 Doubs	59 Nord	71 Saone et Loire
02 Aisne	26 Drome	60 Oise	75 Paris
03 Allier	32 Gers	61 Orne	82 Tarn et Garonne
05 Hautes Alpes	36 Indre	63 Puy Du Dome	84 Vaucluse
08 Ardennes	37 Indre et Loire	64 Pyrenees Atlantique	88 Vosges
09 Ariege	41 Loir et Cher	66 Pyrenees	89 Yonne
11 Aude	45 Loret	67 Bas Rhin	90 Territoire de Belfort
12 Aveyron	50 Manche	68 Haut Rhin	94 Val de Marne
16 Charente	55 Meuse	70 Haute Saone	
24 Dordogne	58 Nievre		

This requirement is likely to change over time, allowing you to use your wireless LAN card in more areas within France.

Please check with ART for the latest information (www.art-telecom.fr).

Note: Your WLAN Card transmits less than 100 mW, but more than 10 mW.

List of national codes

This equipment may be operated in the following countries:

Country	ISO 3166 2 letter code	Country	ISO 3166 2 letter code
Austria	AT	Malta	MT
Belgium	BE	Netherlands	NT
Cyprus	CY	Poland	PL
Czech Republic	CZ	Portugal	PT
Denmark	DK	Slovakia	SK
Estonia	EE	Slovenia	SL
Finland	FI	Spain	ES
France	FR	Sweden	SE
Germany	DE	United Kingdom	GB
Greece	GR	Iceland	IS
Hungary	HU	Liechtenstein	LI
Ireland	IE	Norway	NO
Italy	IT	Switzerland	CH
Latvia	LV	Bulgaria	BG
Lithuania	LT	Romania	RO
Luxembourg	LU	Turkey	TR

The FCC RF safety requirement

The radiated output power of the wireless LAN Mini PCI Card and Bluetooth card is far below the FCC radio frequency exposure limits. Nevertheless, the notebook PC series shall be used in such a manner that the potential for human contact during normal operation is minimized as follows:

1. Users are requested to follow the RF safety instructions on wireless option devices that are included in the user's manual of each RF option device.

Caution: To comply with FCC RF exposure compliance requirements, a separation distance of at least 20 cm (8 inches) must be maintained between the antenna for the integrated wireless LAN Mini PCI Card built in to the screen section and all persons.

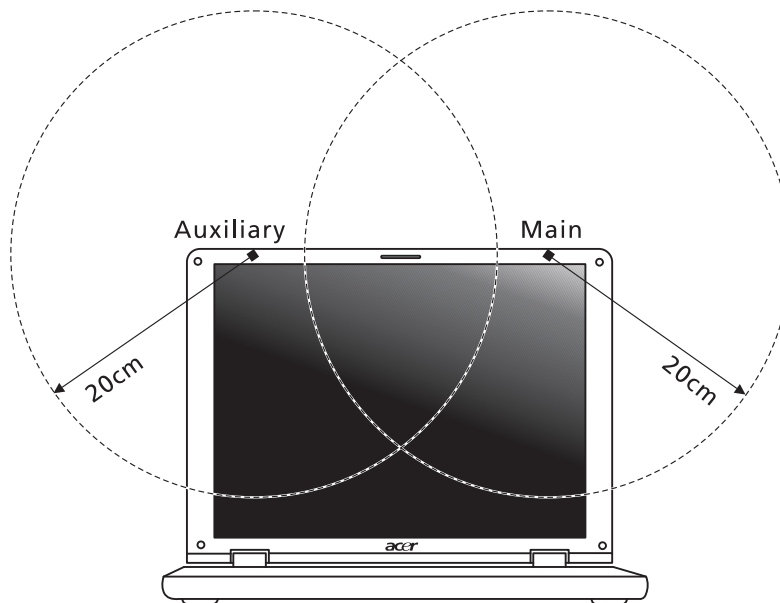

Note: The wireless Mini PCI adapter implements a transmission diversity function. The function does not emit radio frequencies simultaneously from both antennas. One of the antennas is selected automatically or manually (by users) to ensure good quality radiocommunication.

1. This device is restricted to indoor use due to its operation in the 5.15 to 5.25 GHz frequency range. FCC requires this product to be used indoors for the frequency

range 5.15 to 5.25 GHz to reduce the potential for harmful interference to co-channel Mobile Satellite systems.

2. High power radar is allocated as the primary user of the 5.25 to 5.35 GHz and 5.65 to 5.85 GHz bands. These radar stations can cause interference with and/or damage this device.
3. An improper installation or unauthorized use may cause harmful interference to radio communications. Also any tampering of the internal antenna will void the FCC certification and your warranty.

CANADA — LOW-POWER LICENSE-EXEMPT RADIO COMMUNICATION DEVICES (RSS-210)

Exposure of humans to RF fields (RSS-102)

The notebook PC series employs low gain integral antennas that do not emit RF field in excess of Health Canada limits for the general population; consult Safety Code 6, obtainable from Health Canada's website at www.hc-sc.gc.ca/rpb.

This device complies with RSS210 of Industry Canada.

This Class B digital apparatus complies with Canadian ICES-003, Issue 4, and RSS-210, No 4 (Dec 2000) and No 5 (Nov 2001).

"To prevent radio interference to the licensed service, this device is intended to be operated indoors and away from windows to provide maximum shielding. Equipment (or its transmit antenna) that is installed outdoors is subject to licensing."

Cet appareil numérique de la classe B est conforme à la norme NMB-003, No. 4, et CNR-210, No 4 (Dec 2000) et No 5 (Nov 2001).

« Pour empêcher que cet appareil cause du brouillage au service faisant l'objet d'une licence, il doit être utilisé à l'intérieur et devrait être placé loin des fenêtres afin de fournir un écran de blindage maximal. Si le matériel (ou son antenne d'émission) est installé à l'extérieur, il doit faire l'objet d'une licence.

Caution: When using IEEE 802.11a wireless LAN, this product is restricted to indoor use due to its operation in the 5.15- to 5.25-GHz frequency range. Industry Canada requires this product to be used indoors for the frequency range of 5.15 GHz to 5.25

GHz to reduce the potential for harmful interference to co-channel mobile satellite systems. High power radar is allocated as the primary user of the 5.25 to 5.35 GHz and 5.65 to 5.85-GHz bands. These radar stations can cause interference with and/or damage to this device.

The maximum allowed antenna gain for use with this device is 6 dBi in order to comply with the E.I.R.P limit for the 5.25- to 5.35 and 5.725 to 5.85 GHz frequency range in point-to-point operation.

LCD PANEL ERGONOMIC SPECIFICATIONS

Design viewing distance	500 mm
Design inclination angle	0.0°
Design azimuth angle	90.0°
Viewing direction range class	Class IV
Screen tilt angle	85.0°
Design screen illuminance	- Illuminance level: [250 + (250cos α)] lx where $\alpha = 85^\circ$ - Color: Source D65
Reflection class of LCD panel (positive and negative polarity)	- Ordinary LCD: Class I - Protective LCD: Class III
Image polarity	Both
Reference white:	- Yn
Pre-setting of luminance and color temperature @ 6500K (tested under BM7)	- u'n - v'n
Pixel fault class	Class II