

Packard Bell dot s Series Service Guide

Service guide files and updates are available on the ACER/CSD web; for more information, please refer to <http://csd.acer.com.tw>

PRINTED IN TAIWAN

Revision History

Please refer to the table below for the updates made to this service guide.

Date	Chapter	Updates

Copyright

Copyright © 2009 by Acer Incorporated. All rights reserved. No part of this publication may be reproduced, transmitted, transcribed, stored in a retrieval system, or translated into any language or computer language, in any form or by any means, electronic, mechanical, magnetic, optical, chemical, manual or otherwise, without the prior written permission of Acer Incorporated.

Disclaimer

The information in this guide is subject to change without notice.

Acer Incorporated makes no representations or warranties, either expressed or implied, with respect to the contents hereof and specifically disclaims any warranties of merchantability or fitness for any particular purpose. Any Acer Incorporated software described in this manual is sold or licensed "as is". Should the programs prove defective following their purchase, the buyer (and not Acer Incorporated, its distributor, or its dealer) assumes the entire cost of all necessary servicing, repair, and any incidental or consequential damages resulting from any defect in the software.

Acer is a registered trademark of Acer Corporation.

Intel is a registered trademark of Intel Corporation.

Pentium and Pentium II/III are trademarks of Intel Corporation.

Other brand and product names are trademarks and/or registered trademarks of their respective holders.

Conventions

The following conventions are used in this manual:

SCREEN MESSAGES	Denotes actual messages that appear on screen.
NOTE	Gives bits and pieces of additional information related to the current topic.
WARNING	Alerts you to any damage that might result from doing or not doing specific actions.
CAUTION	Gives precautionary measures to avoid possible hardware or software problems.
IMPORTANT	Reminds you to do specific actions relevant to the accomplishment of procedures.

Preface

Before using this information and the product it supports, please read the following general information.

1. This Service Guide provides you with all technical information relating to the BASIC CONFIGURATION decided for Acer's "global" product offering. To better fit local market requirements and enhance product competitiveness, your regional office MAY have decided to extend the functionality of a machine (e.g. add-on card, modem, or extra memory capability). These LOCALIZED FEATURES will NOT be covered in this generic service guide. In such cases, please contact your regional offices or the responsible personnel/channel to provide you with further technical details.
2. Please note WHEN ORDERING FRU PARTS, that you should check the most up-to-date information available on your regional web or channel. If, for whatever reason, a part number change is made, it will not be noted in the printed Service Guide. For ACER-AUTHORIZED SERVICE PROVIDERS, your Acer office may have a DIFFERENT part number code to those given in the FRU list of this printed Service Guide. You MUST use the list provided by your regional Acer office to order FRU parts for repair and service of customer machines.

System Specifications	1
Features	1
System Block Diagram	4
Front View	5
Left View	5
Right View	5
Bottom and Rear View	6
Keyboard Area and LCD Panel	7
Touchpad Basics	9
Using the Keyboard	10
Lock Keys and Embedded Numeric Keypad	10
Windows Keys	11
System Keys	12
Hot Keys	13
Special Key	14
Hardware Specifications and Configurations	15
 System Utilities	 19
BIOS Setup Utility	19
Navigating the BIOS Utility	19
Information	20
Main	21
Security	22
Boot	25
Exit	26
BIOS Flash Utility	27
DOS Flash Utility	28
WinFlash Utility	30
Remove HDD/BIOS Password Utilities	31
Miscellaneous Utilities	33
 Machine Disassembly and Replacement	 37
Disassembly Requirements	37
General Information	38
Pre-disassembly Instructions	38
Disassembly Process	38
External Module Disassembly Process	39
External Modules Disassembly Flowchart	39
Removing the Battery Pack	40
Removing the SD Dummy Card	41
Removing the DIMM Module	42
Removing the HDD Module	44
Removing the WLAN Module	47
Removing the 3G Module	49
Main Unit Disassembly Process	51
Main Unit Disassembly Flowchart	51
Removing the Keyboard	52
Removing the Upper Cover	54
Removing the Button Board	58
Removing the Power Board	60
Removing the LED Board	61
Removing the Function Board	62
Removing the Bluetooth Module	64
Removing the Bridge Board	65

Table of Contents

Removing the I/O Board	66
Removing the Mainboard	68
Removing the Thermal Module	69
Removing the LCD Module	71
Removing the Speaker Module	73
LCD Module Disassembly Process	75
LCD Module Disassembly Flowchart	75
Removing the LCD Bezel	76
Removing the Camera Module	78
Removing the LCD Panel	79
Removing the LCD Brackets and Cable	80
Removing the Microphone Module	82
Removing the 3G Antennas	83
Removing the WLAN Antennas	85
LCD Module Reassembly Procedure	87
Replacing the WLAN Antennas	87
Replacing the 3G Antennas	88
Replacing the Microphone	90
Replacing the LCD Cable	92
Replacing the LCD Panel	93
Replacing the Camera Module	95
Replacing the LCD Bezel	97
Main Module Reassembly Procedure	99
Replacing the Speakers	99
Replacing the LCD Module	100
Replacing the Thermal Module	102
Replacing the Mainboard	105
Replacing the I/O Board	107
Replacing the Bridge Board	108
Replacing the Bluetooth Module	109
Replacing the Function Board	110
Replacing the LED Board	111
Replacing the Power Board	113
Replacing the Button Board	114
Replacing the Upper Cover	116
Replacing the Keyboard	121
Replacing the 3G Module	122
Replacing the WLAN Module	123
Replacing the Hard Disk Drive	124
Replacing the DIMM Module	126
Replacing the Lower Covers	126
Replacing the Battery	127
Replacing the SD Dummy Card	128

Troubleshooting

129

Common Problems	129
Power On Issue	130
No Display Issue	131
Random Loss of BIOS Settings	132
LCD Failure	133
Built-In Keyboard Failure	133
TouchPad Failure	134
Internal Speaker Failure	134
Internal Microphone Failure	136
HDD Not Operating Correctly	137

Table of Contents

USB Failure	138
Wireless Function Failure	138
Thermal Unit Failure	139
External Mouse Failure	139
Other Failures	140
Intermittent Problems	141
Undetermined Problems	141
Post Codes	142
Jumper and Connector Locations	149
Mainboard Description	149
Bottom View	150
Clearing Password Check and BIOS Recovery	151
Clearing Password Check	151
BIOS Recovery by Crisis Disk	152
FRU (Field Replaceable Unit) List	153
Exploded Diagrams	153
Main Assembly	153
LCD Assembly	153
FRU List	154
Screw List	161
Model Definition and Configuration	162
Test Compatible Components	163
Online Support Information	167
Index	169

Table of Contents

System Specifications

Features

Below is a brief summary of the computer's many features:

Operating System

- Genuine Windows® 7 Starter for Small Notebook PCs
- Genuine Windows® 7 Home Basic (China only)

Platform

- Intel® Atom™ processor N450 (512 KB L2 cache, 1.66 GHz, DDR2 667 MHz)
- Mobile Intel® NM10 Express Chipset

System Memory

- Single channel with one soDIMM slot
 - DDR2 667 MHz SDRAM memory interface design
 - soDIMM slot: Supports 1 GB soDIMMs for total system memory of up to 1 GB

Display

- 10.1" SD 1024 x 600 (WSVGA) pixel resolution, high-brightness (200-nit) LED-backlit TFT LCD graphics

Storage subsystem

- 2.5" (9.5 mm) 160/250 GB hard disk drive
- Multi-in-1 card reader:
 - Supporting Secure Digital™ (SD) Card, MultiMediaCard (MMC), Reduced-Size Multimedia Card (RS-MMC), Memory Stick™ (MS), Memory Stick PRO™ (MS PRO), xD-Picture Card™ (xD)
 - Supporting storage cards with adapter: miniSD™, microSD™, Memory Stick Duo™, Memory Stick PRO Duo™

Audio

- High-definition audio support
- Two built-in stereo speakers
- MS-Sound compatible
- Built-in digital microphone

I/O Interface

- Multi-in-1 card reader
- Three USB 2.0 ports
- External display (VGA) port
- Headphone/speaker/line-out jack
- Microphone-in jack
- Ethernet (RJ-45) port
- DC-in jack for AC adapter

Dimensions and Weight

- 258.5 (W) x 185 (D) x 25.2 (H) mm (10.17 x 7.28 x 0.99 inches)
- 1.1 kg (2.43 lbs.) for models with 3-cell battery pack
- 1.25 kg (2.76 lbs.) for models with 6-cell battery pack

Communication

- Video conferencing solution, featuring:
 - Webcam with 640 x 480 resolution
- WLAN:
 - 802.11b/g/n Wi-Fi CERTIFIED™
 - 802.11b/g Wi-Fi CERTIFIED™
- WPAN: Bluetooth® 2.1+EDR
- WWAN: UMTS/HSPA at 850/1900/2100 MHz and quad-band GSM/GPRS/EDGE (850/900/1800/1900 MHz), upgradeable to 7.2 Mb/s HSDPA and 2 Mb/s HSUPA, supporting receiver diversity and equalizing at 2100 MHz (for 3G model)
- LAN: 10/100 Mbps Fast Ethernet

Privacy Control

- BIOS user, supervisor, HDD passwords
- Kensington lock slot

Power subsystem

- Product Safety Electric Appliance and Materials (PSE) certified for battery pack
- 63 W 5600 mAh 6-cell Li-ion battery pack
 - 10-hour battery life⁸
- 48 W 4400 mAh 6-cell Li-ion battery pack
 - 8-hour battery life⁸
- 24 W 2200 mAh 3-cell Li-ion battery pack
 - 4-hour battery life⁸
- 40 W AC adapter with power plug

Special keys and controls

- 84-key keyboard, 93% of standard-size keyboard
- Multi-gesture touchpad, supporting two-finger scroll, pinch, rotate, flip
- 12 function keys, four cursor keys, one Windows[®] key, hotkey controls, embedded numeric keypad, international language support
- Power button with LED

Environment

- Temperature:
 - Operating: TBD
 - Non-operating: TBD
- Humidity (non-condensing):
 - Operating: TBD
 - Non-operating: TBD

System Block Diagram

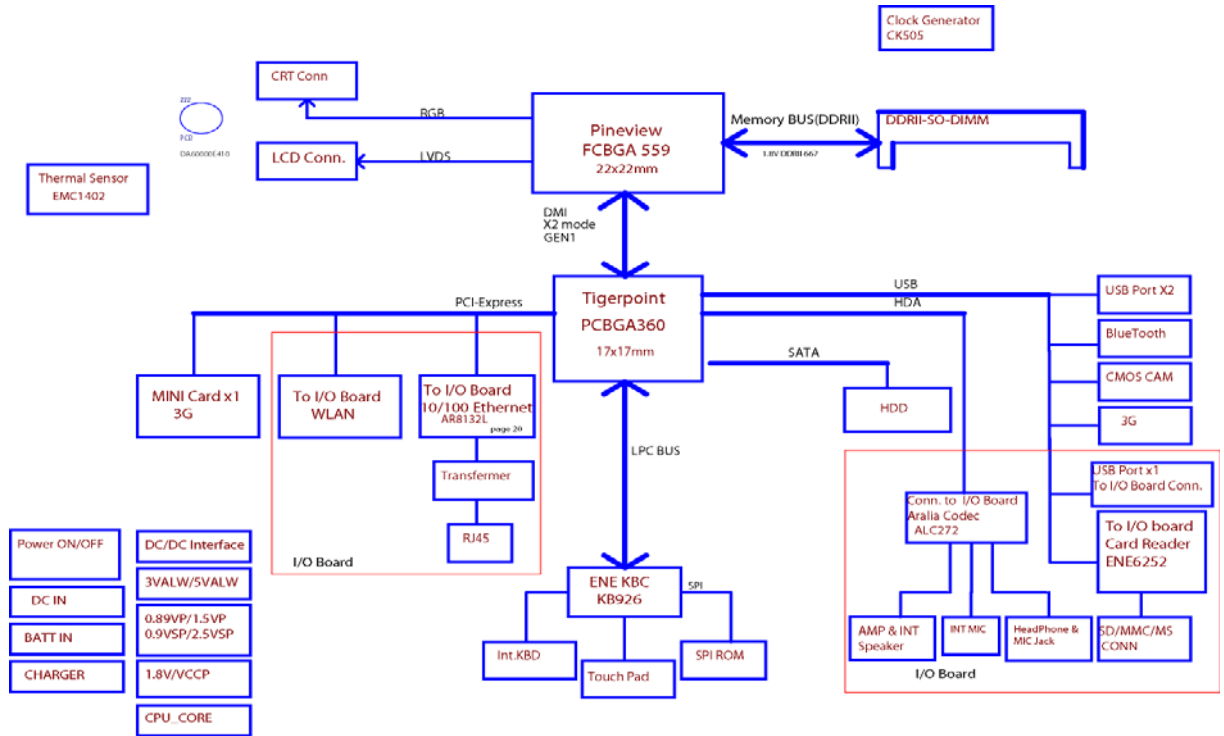

Front View



#	Component	Icon	Description
1	Status Indicators		Light-Emitting Diodes (LED) that light up to show the status of the computer's functions and components.

Left View

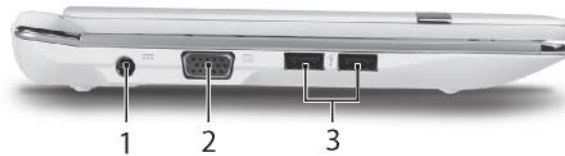



#	Component	Icon	Description
1	DC-in jack		Connects to an AC adapter.
2	External display (VGA) port		Connects to a display device (e.g., external monitor, LCD projector).
3	USB 2.0 port		Connects to USB 2.0 devices (e.g., USB mouse).

Right View





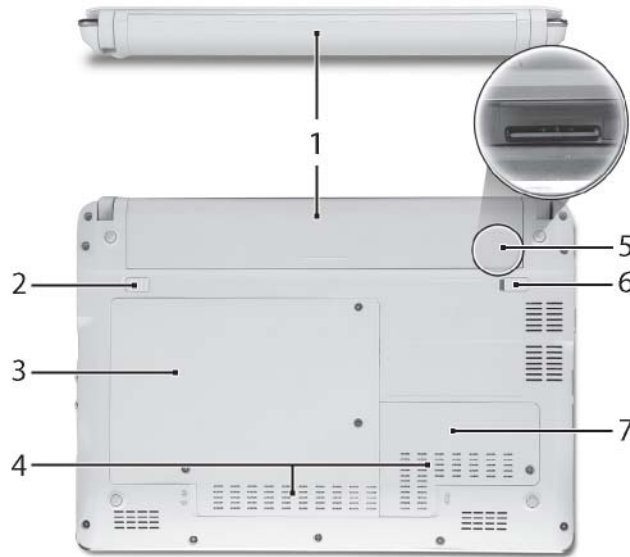

#	Component	Icon	Description
1	Multi-in-1 card reader		Accepts Secure Digital (SD), MultiMediaCard (MMC), Memory Stick (MS), Memory Stick PRO (MS PRO), xD-Picture Card (xD). Note: Push to remove/install the card. Only one card can operate at any given time.
2	Headphone/speaker/line-out jack		Connects to line-out audio devices (e.g., speakers, headphones).
3	Microphone-in jack		Accepts input from external microphones.
4	USB 2.0 port		Connects to USB 2.0 devices (e.g., USB mouse).

#	Component	Icon	Description
5	Kensington lock slot		Connects to a Kensington-compatible computer security lock.
6	Ethernet (RJ-45) port		Connects to an Ethernet 10/100-based network.





Bottom and Rear View

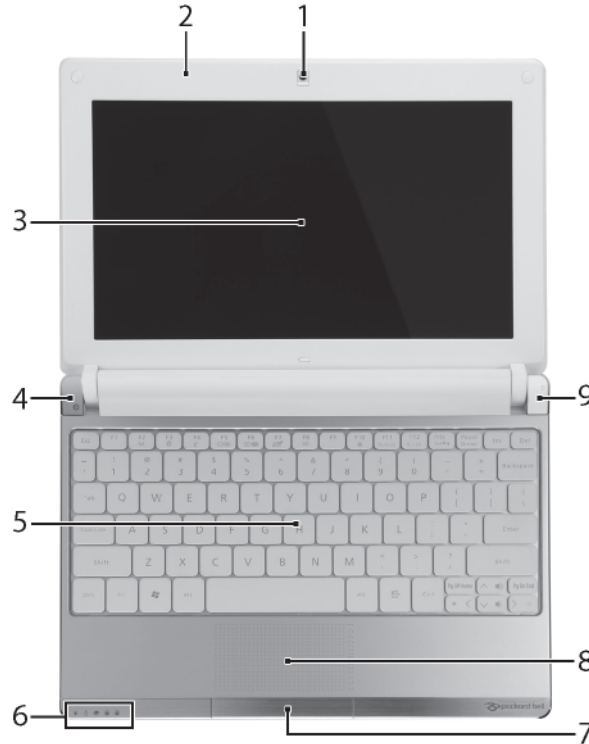

#	Component	Icon	Description
1	Battery bay		Houses the computer's battery pack. Note: The battery shown is for reference only. Your PC may have a different battery, depending on the model purchased.
2	Battery release latch		Releases the battery for removal.
3	Hard disk/3G/Wireless LAN communication bay		Houses the computer's hard disk/3G/Wireless LAN communication (secured with screws).
4	Ventilation slots and/or cooling fan		Enables the computer to stay cool, even after prolonged use. Note: Do not cover or obstruct the opening of the fan.
5	3G SIM card slot		Accepts a 3G SIM card for 3G connectivity. (only for certain models)
6	Battery lock		Locks the battery in position.
7	Memory compartment		Houses the computer's main memory

Keyboard Area and LCD Panel



No.	Component	Icon	Description
1	Webcam		Web camera for video communication
2	Microphone		Internal microphone for sound recording.
3	Display screen		Also called Liquid-Crystal Display (LCD), displays computer output.
4	Power button/indicator		Indicates when the computer is turned on.
5	Keyboard		Provides all the features of a full-sized, computer keyboard.
6	Power indicator		Indicates the computer's power status.
	Battery indicator		Indicates the computer's battery status.
	HDD indicator		Indicates when the hard disk drive is active.
	Num Lock indicator		Lights up when Num Lock is activated.
	Caps Lock indicator		Lights up when Caps Lock is activated.
7	Click buttons (left, and right)		The left and right buttons function like the left and right mouse buttons.
8	Touchpad		Touch-sensitive pointing device which functions like a computer mouse.

No.	Component	Icon	Description
9	Bluetooth communication indicator 3G/Wireless LAN communication indicator		Indicates the status of the Bluetooth communication. (only for certain models) Indicates the status of 3G/Wireless LAN communication: <ul style="list-style-type: none">• Blue light on — 3G on / WiFi on or off• Orange light on — 3G off / WiFi on• Not lit — 3G off / WiFi off

Touchpad Basics

The following items show you how to use the TouchPad:

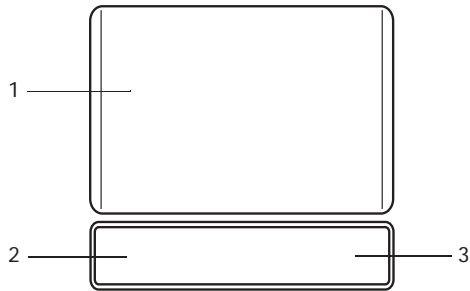

- Move your finger across the TouchPad (1) to move the cursor.
- Press the left (2) and right (3) buttons located beneath the TouchPad to perform selection and execution functions. These two buttons are similar to the left and right buttons on a mouse. Tapping on the TouchPad is the same as clicking the left button.

Function	Left Button (2)	Right Button (3)	Main TouchPad (1)
Execute	Quickly click twice.		Tap twice (at the same speed as double-clicking a mouse button).
Select	Click once.		Tap once.
Drag	Click and hold, then use finger on the TouchPad to drag the cursor.		Tap twice (at the same speed as double-clicking a mouse button); rest your finger on the TouchPad on the second tap and drag the cursor.
Access context menu		Click once.	

NOTE: When using the TouchPad, keep it - and your fingers - dry and clean. The TouchPad is sensitive to finger movement; hence, the lighter the touch, the better the response. Tapping too hard will not increase the TouchPad's responsiveness.

Using the Keyboard

Your Packard Bell Dot S has a close-to-full-sized keyboard and an embedded numeric keypad, separate cursor, lock, function and special keys.

Lock Keys and Embedded Numeric Keypad

The keyboard has three lock keys which you can toggle on and off.



















Lock key	Description
Caps Lock	When Caps Lock is on, all alphabetic characters typed are in uppercase.
Num Lock <Fn> + <F11>	When Num Lock is on, the embedded keypad is in numeric mode. The keys function as a calculator (complete with the arithmetic operators +, -, *, and /). Use this mode when you need to do a lot of numeric data entry. A better solution would be to connect an external keypad.
Scroll Lock <Fn> + <F12>	When Scroll Lock is on, the screen moves one line up or down when you press the up or down arrow keys respectively. Scroll Lock does not work with some applications.

The embedded numeric keypad functions like a desktop numeric keypad. It is indicated by small characters located on the upper right corner of the keycaps. To simplify the keyboard legend, cursor-control key symbols are not printed on the keys.

Desired access	Num Lock on	Num Lock off
Number keys on embedded keypad	Type numbers in a normal manner.	
Main keyboard keys	Hold <Fn> while typing letters on embedded keypad.	Type the letters in a normal manner.

Windows Keys











The keyboard has two keys that perform Windows-specific functions.

Key	Description
 Windows key	<p>Pressed alone, this key has the same effect as clicking on the Windows Start button; it launches the Start menu. It can also be used with other keys to provide a variety of functions:</p> <ul style="list-style-type: none"> <  >: Open or close the Start menu <  > + <D>: Display the desktop <  > + <E>: Open Windows Explore <  > + <F>: Search for a file or folder <  > + <G>: Cycle through Sidebar gadgets <  > + <L>: Lock your computer (if you are connected to a network domain), or switch users (if you're not connected to a network domain) <  > + <M>: Minimizes all windows <  > + <R>: Open the Run dialog box <  > + <T>: Cycle through programs on the taskbar <  > + <U>: Open Ease of Access Center <  > + <X>: Open Windows Mobility Center <  > + <BREAK>: Display the System Properties dialog box <  > + <SHIFT+M>: Restore minimized windows to the desktop <  > + <TAB>: Cycle through programs on the taskbar by using Windows Flip 3-D <  > + <SPACEBAR>: Bring all gadgets to the front and select Windows Sidebar <CTRL> + <  > + <F>: Search for computers (if you are on a network) <CTRL> + <  > + <TAB>: Use the arrow keys to cycle through programs on the taskbar by using Windows Flip 3-D <p>Note: Depending on your edition of Windows 7, some shortcuts may not function as described.</p>
 Application key	<p>This key has the same effect as clicking the right mouse button; it opens the application's context menu.</p>

System Keys

The computer employs hotkeys or key combinations to access most of the computer's controls like screen brightness, Bluetooth and WiFi.











To activate hot keys, press and hold the <Fn> key before pressing the other key in the hotkey combination.

Function Key		Description
<Fn> + <F2>		Turn the wireless radio on or off.
<Fn> + <F3>		Turn the Bluetooth radio on or off.
<Fn> + <F4>		Sleep
<Fn> + <F5>		Display toggle
<Fn> + <F6>		Screen blank (backlight off)
<Fn> + <F7>		TouchPad toggle
<Fn> + <F8>		Speaker toggle
<Fn> + <D>		Brightness up
<Fn> + <Q>		Brightness down
<Fn> + <A>		Volume up
<Fn> + <V>		Volume down

Hot Keys

The computer employs hotkeys or key combinations to access most of the computer's controls like screen brightness and volume output.

To activate hotkeys, press and hold the <Fn> key before pressing the other key in the hotkey combination.

Hotkey	Icon	Function	Description
<Fn> + <F1>		Hot key help	Displays the hot key menu description
<Fn> + <F2>		Wireless toggle	Turn the wireless radio on or off.
<Fn> + <F3>		Bluetooth toggle	Turn the Bluetooth radio on or off.
<Fn> + <F4>		Sleep	Puts the computer in Sleep mode.
<Fn> + <F5>		Display toggle	Switches display output between the display screen, external monitor (if connected) and both.
<Fn> + <F6>		Screen blank	Turns the display screen backlight off to save power. Press any key to return.
<Fn> + <F7>		TouchPad toggle	Turns the internal TouchPad on and off.
<Fn> + <F8>		Speaker toggle	Turns the speakers on and off.
<Fn> + <▷>		Brightness up	Increases the screen brightness.
<Fn> + <◁>		Brightness down	Decreases the screen brightness.
<Fn> + <△>		Volume up	Increases the sound volume.
<Fn> + <▽>		Volume down	Decreases the sound volume.

Special Key

You can locate the Euro symbol and the US dollar sign at the upper-center and/or bottom-right of your keyboard.

The Euro symbol

1. Open a text editor or word processor.
2. Hold <Alt Gr> and then press the <5> key at the upper-center of the keyboard.

NOTE: Some fonts and software do not support the Euro symbol.

The US dollar sign

1. Open a text editor or word processor.
2. Hold <Shift> and then press the <4> key at the upper-center of the keyboard.

NOTE: This function varies according to the language settings.

Hardware Specifications and Configurations

Processor

Item	Specification
CPU	<ul style="list-style-type: none"> Intel® Pineview-M (N450, N470) Processor Micro-FCBGA8 packaging technologies On die 512-kB, 8-way L2 cache
Core Logic	<ul style="list-style-type: none"> AMD M880G Chipset

Processor Specifications

Item	CPU Speed	Cores	Mfg. Tech	cache Size	Package	Power	Acer P/N
Atom N450B	1.667	1		512 K	TBD	TBD	KC.ANB01.450
Atom 470B	1.833	1		512 K	TBD	TBD	KC.ANB01.470

CPU Fan True Value Table

Fan On Temp (°C)	Fan Speed (rpm)	SPL Spec (dBA)
43	5200	26
50	5700	29
55	6000	31

- Throttling 50%: On=100°C, Off=80°C
- OS Shutdown: 100°C
- H/W Shutdown: 90°C

BIOS

Item	Specification
BIOS vendor	InsydeH20
BIOS Version	3.5

System Memory

Item	Specification
Memory controller	AMD M880G Chipset
Memory size	0MB (onboard)
DIMM socket number	2
Supports memory size per socket	2048MB
Supports maximum memory size	2048MB
Supports DIMM type	200-pin DDRII SO-DIMM
Supports DIMM Speed	533/667 mHz
Supports DIMM voltage	TBD

Graphics Controller

Item	Specification
VGA Chip	Intel® Atom™ processor with Intel® Graphics Media Accelerator 3150 (Intel® GMA 3150), 64 MB of dedicated video memory, supporting Microsoft® DirectX® 9

Item	Specification
Supports	<ul style="list-style-type: none"> External resolution - VGA port up to 1600 x 900: 60 Hz 16.7 million colors
Resolution	<ul style="list-style-type: none"> TBD

LAN Interface

Item	Specification
LAN Chipset	Atheros AR8132L for 10/100LAN
LAN connector type	RJ-45
LAN connector location	Right side
Features	Support for 10/100

Hard Disk Drive Interface

Item	Specification	
Vendor	Seagate	
Model Name	ST9160310AS	ST9320320AS
Capacity (MB)	160	250
Bytes per sector	512	
Data heads	2	4
Drive Format		
Disks	1	2
Spindle speed (RPM)	5,400	
Performance Specifications		
Buffer size	8 MB	
Interface	SATA	
Internal transfer rate (Mbits/sec max)	830	
I/O data transfer rate (Mbytes/sec max)	300	
DC Power Requirements		
Voltage tolerance	5V(DC) +/- 5%	

Audio Interface

Item	Specification
Audio Controller	TBD
<ul style="list-style-type: none"> Features 	<ul style="list-style-type: none">

Power and Keyboard Controller

Item	Specification
Controller	TBD
Total number of keypads	
Windows logo key	Yes
Internal & external keyboard work simultaneously	Yes
Features	<ul style="list-style-type: none"> Support Application keys for Windows 7

Battery

Item	Specification		
	3 Cell	6 Cell 2.2	6 Cell 2.8
Vendor & model name	SIMPLO UM09G75	SIMPLO UM09H75	SIMPLO UM09H70
Battery Type	Li-ion	Li-ion	Li-ion
Pack capacity	2200 mAh	4400 mAh	5600 mAh
Normal Voltage	11.1V	11.1V	11.1
Charge Voltage	12.6V	12.6V	12.6
Fast Charge Current	2.94~3.5A	2.94~3.5A	2.94~3.5A
Package configuration	3S2P	3S2P	3S2P

LCD

Item	Specification
Vendor/model name	AUO B101AW03 CMO N101L6-L02 Innolux BT101W01 LPL LP101WSA-TLA1 Samsung LP101WSA-TLA1
Screen Diagonal (mm)	256.54
Display Area (mm)	222 x 124.97
Display resolution (pixels)	1024x600/1280x720
Pixel Pitch	0.218 x 0.209
Display Mode	TBD
Typical White Luminance (cd/m ²) (also called Brightness)	200
Contrast Ratio	400:1
Response Time (Optical Rise Time/ Fall Time) msec	16
Typical Power Consumption (watt)	2.8
Weight (g)	190 Max.
Physical Size (mm)	235 x 143 x 5.2
Electrical Interface	TBD
Support Color	262K
Viewing Angle (H/D)	90 / 50

System Utilities

BIOS Setup Utility

The BIOS Setup Utility is a hardware configuration program built into your computer's BIOS (Basic Input/Output System).

Your computer is already properly configured and optimized, and you do not need to run this utility. However, if you encounter configuration problems, you may need to run Setup. Please also refer to Chapter 4 Troubleshooting when problem arises.

To activate the BIOS Utility, press **F2** during POST (when **Press <F2> to enter Setup** message is prompted on the bottom of screen).

Press **F2** to enter setup. The default parameter of F12 Boot Menu is set to "disabled". If you want to change boot device without entering BIOS Setup Utility, please set the parameter to "enabled".

Press **<F12>** during POST to enter multi-boot menu. In this menu, user can change boot device without entering BIOS SETUP Utility.

Navigating the BIOS Utility

There are six menu options: Information, Main, Advanced, Security, Power, Boot, and Exit.

Follow these instructions:

- To choose a menu, use the left and right arrow keys.
- To choose an item, use the up and down arrow keys.
- To change the value of a parameter, press **F5** or **F6**.
- A plus sign (+) indicates the item has sub-items. Press **Enter** to expand this item.
- Press **Esc** while you are in any of the menu options to go to the Exit menu.
- In any menu, you can load default settings by pressing **F9**. You can also press **F10** to save any changes made and exit the BIOS Setup Utility.

NOTE: You can change the value of a parameter if it is enclosed in square brackets. Navigation keys for a particular menu are shown on the bottom of the screen. Help for parameters are found in the Item Specific Help part of the screen. Read this carefully when making changes to parameter values. **Please note that system information is subject to different models.**

Information

The Information screen displays a summary of your computer hardware information.

InsydeH20 Setup Utility				Rev. 3.5
Information	Main	Security	Boot	Exit
CPU Type	Intel(R) Atom(TM)	CPU	N450	
CPU Speed	1.66GHz			
HDD Model Name:	ST9250315AS			
HDD Serial Number:	5VC8K25L			
ATAPI Model Name:	None			
System BIOS Version:	V0.13			
VGA BIOS Version:	Intel V1818			
Serial Number:				
Asset Tag Number:				
Product Name:	DOTS2			
Manufacturer Name:	Packard Bell			
UUID:	214BB15DCE9611DDA5BC00262273B259			

F1 Help	↑↓ Select Item	F5/F6 Change Values	F9 Setup Default
ESC Exit	← Select Menu	Enter Select ► SubMenu	F10 Save and Exit

NOTE: The system information is subject to different models.

Parameter	Description
CPU Type	This field shows the CPU type and speed of the system.
CPU Speed	This field shows the speed of the CPU.
HDD Model Name	This field shows the model name of HDD installed on primary IDE master.
HDD Serial Number	This field displays the serial number of HDD installed on primary IDE master.
ATAPI Model Name	This field displays the ATAPI Model Name.
System BIOS Version	This field displays the system BIOS version.
VGA BIOS Version	This field displays the VGA firmware version of the system.
Serial Number	This field displays the serial number of this unit.
Asset Tag Number	This field displays the asset tag number of the system.
Product Name	This field shows product name of the system.
Manufacturer Name	This field displays the manufacturer of this system.
UUID	Universally Unique Identifier (UUID) is an identifier standard used in software construction, standardized by the Open Software Foundation (OSF) as part of the Distributed Computing Environment (DCE).

Main

The Main screen allows the user to set the system time and date as well as enable and disable boot option and recovery.

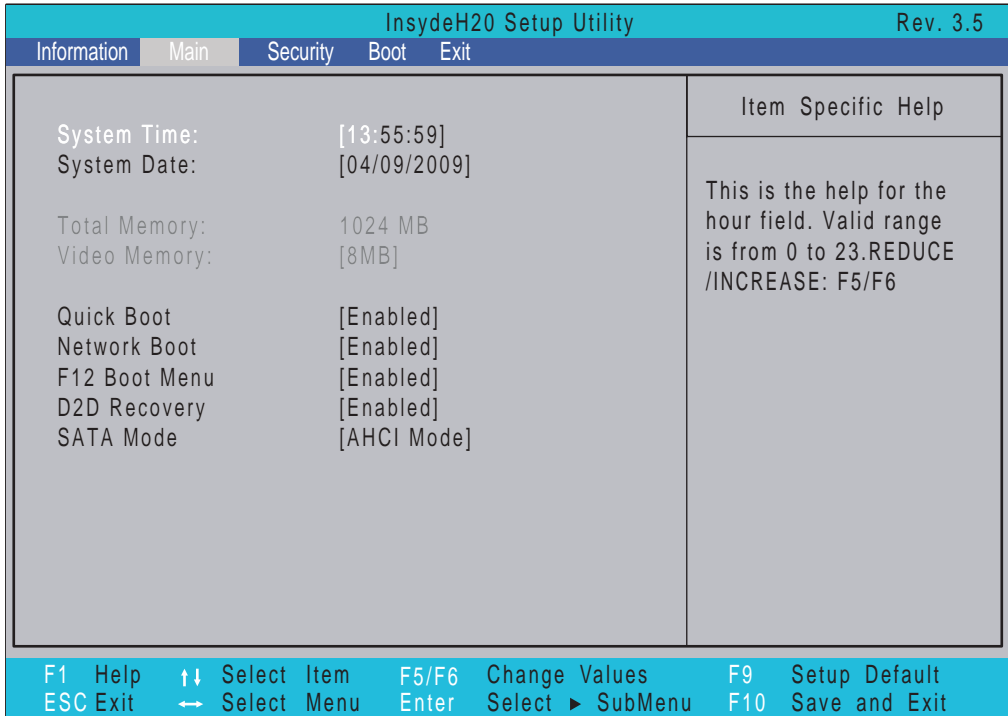

NOTE: The screen above is for your reference only. Actual values may differ.

The table below describes the parameters in this screen. Settings in **boldface** are the default and suggested parameter settings.

Parameter	Description	Format/Option
System Time	Sets the system time. The hours are displayed with 24-hour format.	Format: HH:MM:SS (hour:minute:second)
System Date	Sets the system date.	Format MM/DD/YYYY (month/day/year)
Total Memory	This field reports the memory size of the system. Memory size is fixed to 3017 MB.	N/A
Video Memory	Shows the video memory size. VGA Memory size=32 MB	N/A
Quick Boot	Allows startup to skip certain tests while booting, decreasing the time needed to boot the system.	Option: Enabled or Disabled
Network Boot	Enables, disables the system boot from LAN (remote server).	Option: Enabled or Disabled
F12 Boot Menu	Enables, disables Boot Menu during POST.	Option: Enabled or Disabled
D2D Recovery	Enables, disables D2D Recovery function. The function allows the user to create a hidden partition on hard disc drive to store operation system and restore the system to factory defaults.	Option: Enabled or Disabled
SATA Mode	Control the mode in which the SATA controller should operate.	Option: AHCI or IDE

Security

The Security screen contains parameters that help safeguard and protect your computer from unauthorized use.

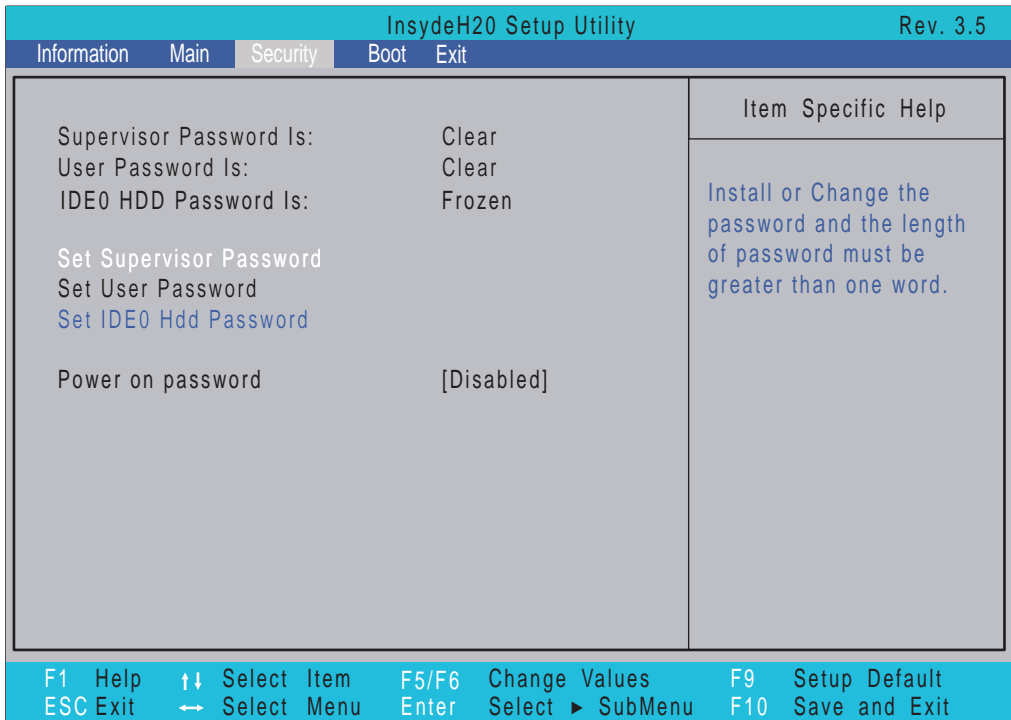

The table below describes the parameters in this screen. Settings in **boldface** are the default and suggested parameter settings.

Parameter	Description	Option
Supervisor Password Is	Shows the setting of the Supervisor password	Clear or Set
User Password Is	Shows the setting of the user password.	Clear or Set
IDEO HDD Password Is	Shows the setting of the HDD password	Clear or Set
Set Supervisor Password	Press Enter to set the supervisor password. When set, this password protects the BIOS Setup Utility from unauthorized access. The user can not either enter the Setup menu nor change the value of parameters.	
Set User Password	Press Enter to set the user password. When user password is set, this password protects the BIOS Setup Utility from unauthorized access. The user can enter Setup menu only and does not have right to change the value of parameters.	
Set IDEO Hdd Password	Enter to set the HDD password.	
Power on password	Defines whether a password is required or not while the events defined in this group happened. The following sub-options are all requires the Supervisor password for changes and should be grayed out if the user password was used to enter setup.	Enabled or Disabled

NOTE: When you are prompted to enter a password, you have three tries before the system halts. Don't forget your password. If you forget your password, you may have to return your notebook computer to your dealer to reset it.

Setting a Password

Follow these steps as you set the user or the supervisor password:

1. Use the ↑ and ↓ keys to highlight the Set Supervisor Password parameter and press the **Enter** key. The Set Supervisor Password box appears:

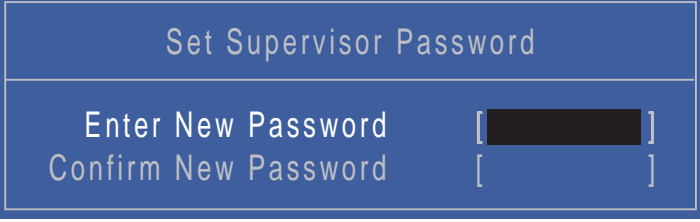

Set Supervisor Password	
Enter New Password	[██████████]
Confirm New Password	[]

2. Type a password in the “Enter New Password” field. The password length can not exceeds 8 alphanumeric characters (A-Z, a-z, 0-9, not case sensitive). Retype the password in the “Confirm New Password” field.

IMPORTANT: Be very careful when typing your password because the characters do not appear on the screen.

3. Press **Enter**. After setting the password, the computer sets the User Password parameter to “Set”.
4. If desired, you can opt to enable the Password on boot parameter.
5. When you are done, press F10 to save the changes and exit the BIOS Setup Utility.

Removing a Password

Follow these steps:

1. Use the ↑ and ↓ keys to highlight the Set Supervisor Password parameter and press the **Enter** key. The Set Password box appears:



Set Supervisor Password	
Enter Current Password	[██████████]
Enter New Password	[]
Confirm New Password	[]

2. Type the current password in the Enter Current Password field and press **Enter**.
3. Press **Enter** twice **without** typing anything in the Enter New Password and Confirm New Password fields. The computer then sets the Supervisor Password parameter to “Clear”.
4. When you have changed the settings, press u to save the changes and exit the BIOS Setup Utility.

Changing a Password

1. Use the ↑ and ↓ keys to highlight the Set Supervisor Password parameter and press the **Enter** key. The Set Password box appears.

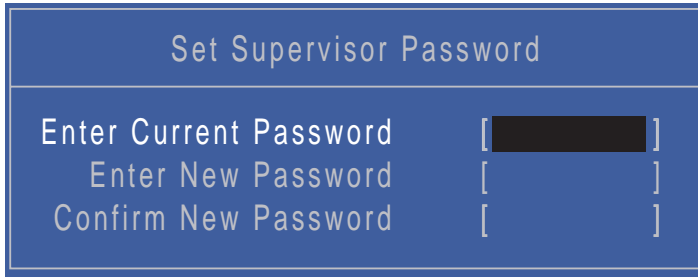

The screenshot shows a blue-themed BIOS screen titled "Set Supervisor Password". It contains three input fields: "Enter Current Password", "Enter New Password", and "Confirm New Password". The first field is filled with blacked-out characters, while the other two are empty.

2. Type the current password in the Enter Current Password field and press **Enter**.
3. Type a password in the Enter New Password field. Retype the password in the Confirm New Password field.
4. Press **Enter**. After setting the password, the computer sets the User Password parameter to "Set".
5. If desired, you can enable the Password on boot parameter.
6. When you are done, press **F10** to save the changes and exit the BIOS Setup Utility.

If the verification is OK, the screen will display as following.

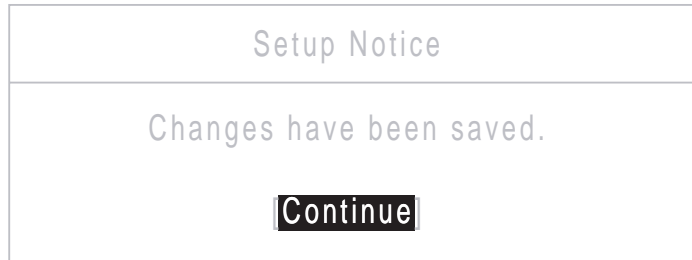

The screenshot shows a white-themed BIOS screen titled "Setup Notice". The text "Changes have been saved." is displayed in the center. At the bottom, there is a black button labeled "Continue".

The password setting is complete after the user presses **Enter**.

If the current password entered does not match the actual current password, the screen will show you the Setup Warning.



The screenshot shows a white-themed BIOS screen titled "Setup Warning" in red text. Below the title, the message "Invalid Password." is displayed in red. At the bottom, there is a black button labeled "Continue".

If the new password and confirm new password strings do not match, the screen displays the following message.



The screenshot shows a white-themed BIOS screen titled "Setup Warning" in red text. Below the title, the message "Passwords do not match. Re-enter password." is displayed in red. At the bottom, there is a black button labeled "Continue".

Boot

This menu allows the user to decide the order of boot devices to load the operating system. Bootable devices includes the USB diskette drives, the onboard hard disk drive and the DVD drive in the module bay.

InsydeH20 Setup Utility				Rev. 3.5
Information	Main	Security	Boot	Exit
Boot priority order:				Item Specific Help
1. IDE0 : ST9250315AS				Use <↑> or <↓> to select a device, then press <F5> to move it down the list, or <F6> to move it up the list. Press <Esc> to escape the menu
2. IDE1 :				
3. USB FDD :				
4. Network Boot : LAN				
5. USB HDD :				
6. USB CDROM :				
F1 Help	↑↓ Select Item	F5/F6 Change Values	F9 Setup Default	
ESC Exit	←→ Select Menu	Enter Select ► SubMenu	F10 Save and Exit	

Exit

The Exit screen allows you to save or discard any changes you made and quit the BIOS Utility.

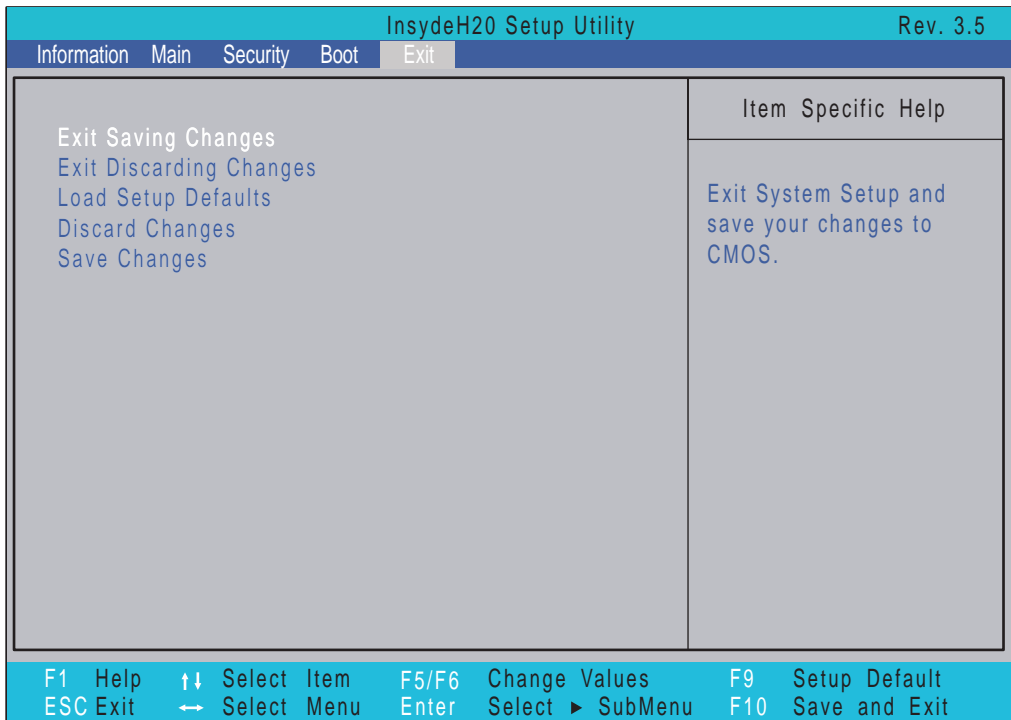

The table below describes the parameters in this screen.

Parameter	Description
Exit Saving Changes	Exit System Setup and save your changes to CMOS.
Exit Discarding Changes	Exit utility without saving setup data to CMOS.
Load Setup Default	Load default values for all SETUP item.
Discard Changes	Load previous values from CMOS for all SETUP items.
Save Changes	Save Setup Data to CMOS.

BIOS Flash Utility

The BIOS flash memory update is required for the following conditions:

- New versions of system programs
- New features or options
- Restore a BIOS when it becomes corrupted.

Use the Phlash utility to update the system BIOS flash ROM.

NOTE: If you do not have a crisis recovery diskette at hand, then you should create a **Crisis Recovery Diskette** before you use the Phlash utility.

NOTE: Do not install memory-related drivers (XMS, EMS, DPMI) when you use the Phlash.

NOTE: Please use the AC adaptor power supply when you run the Phlash utility. If the battery pack does not contain enough power to finish BIOS flash, you may not boot the system because the BIOS is not completely loaded.

Follow the steps below to run the Phlash.

1. Prepare a bootable diskette.
2. Copy the flash utilities to the bootable diskette.
3. Then boot the system from the bootable diskette. The flash utility has auto-execution function.

DOS Flash Utility

Perform the following steps to use the DOS Flash Utility:

1. Press F2 during boot to enter the Setup Menu.
2. Select **Boot Menu** to modify the boot priority order, for example, if using USB HDD to Update BIOS, move USB HDD to position 1.

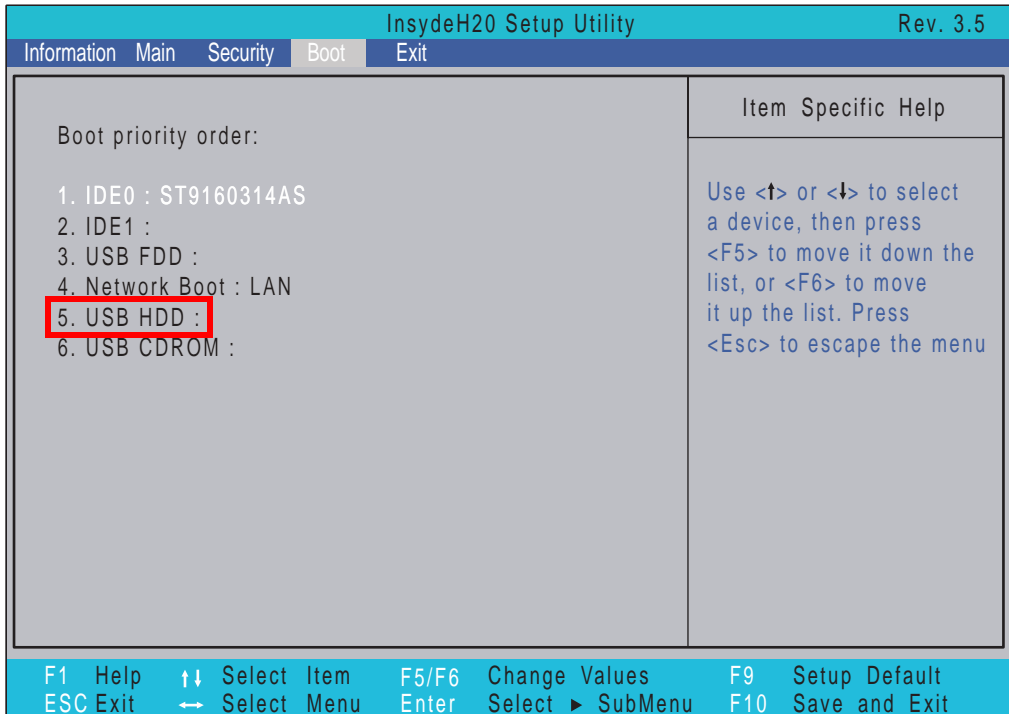

3. Execute the **IFLASH.BAT** batch file to update BIOS.

The flash process begins as shown.



4. In flash BIOS, the message **Please do not remove AC Power Source** displays.

NOTE: If the AC power is not connected, the following message displays.

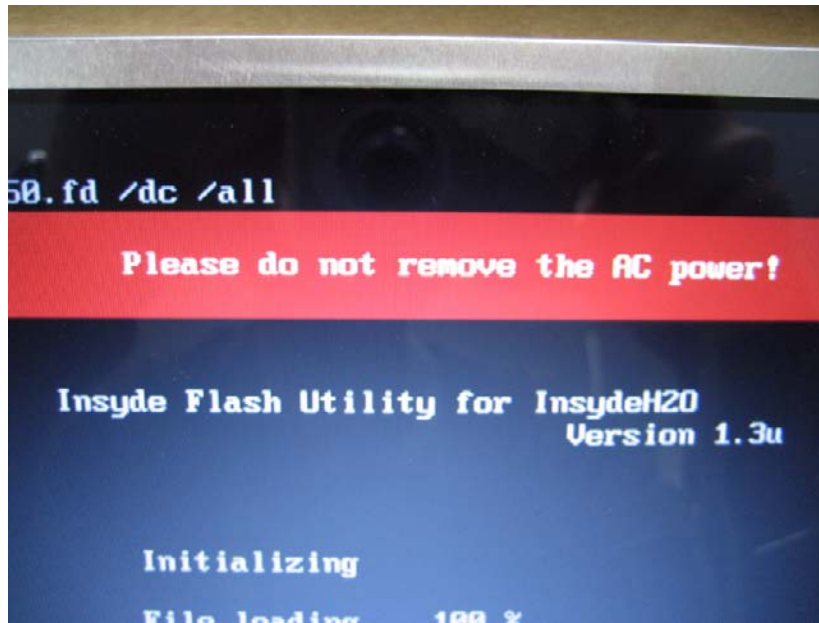

Plug in the AC power to continue.

5. Flash is complete when the message Flash programming complete displays.

WinFlash Utility

Perform the following steps to use the WinFlash Utility:

1. Double click the WinFlash executable.
2. Click **OK** to begin the update. A progress screen displays.

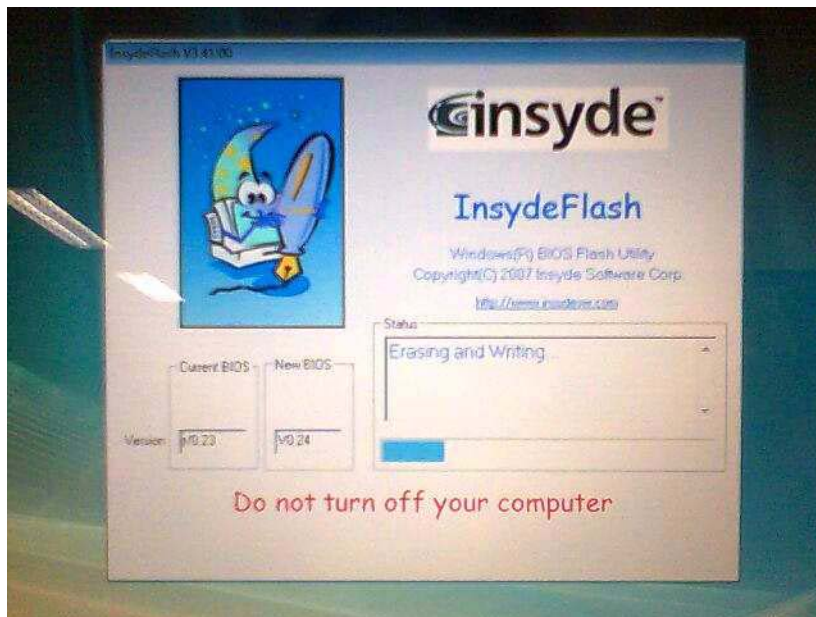

3. When the process is complete, close all programs and applications and reboot the system.

Remove HDD/BIOS Password Utilities

This section provides you with details about removing HDD/BIOS password methods:

Removing HDD Password:

If you key in the wrong HDD password three times, an error is generated.

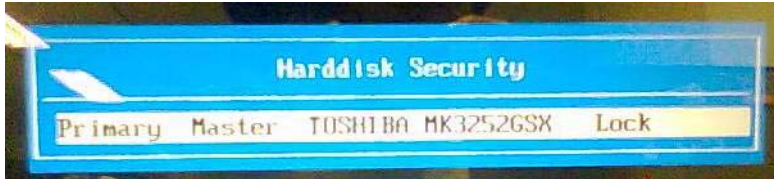

To reset the HDD password, perform the following steps:

1. After the error is displayed, select the **Enter Unlock Password** option on the screen.



2. An Encode key is generated for unlocking utilities. Note down this key.

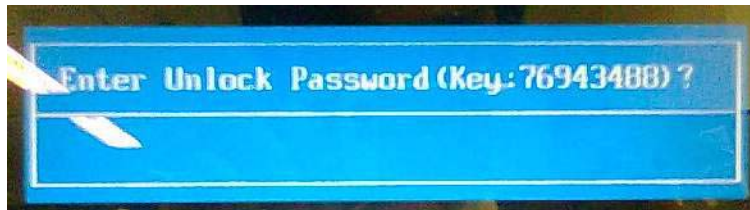

3. Execute the **UnlockHD.EXE** file to create the unlock code in DOS Mode using the format **UnlockHD [Encode key]** with the code noted in the previous step, as follows:

```
UnlockHD 76943488
```

4. The command generates a password which can be used for unlocking the HDD.

```
Password : 46548274
```

5. Key in the password from the previous step to unlock the HDD as shown.

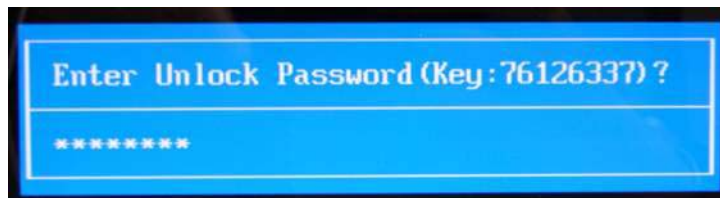

Removing BIOS Passwords:

To clear the User or Supervisor passwords, open the RAM door and use a metal instrument to short the **U72** jumper as shown below.

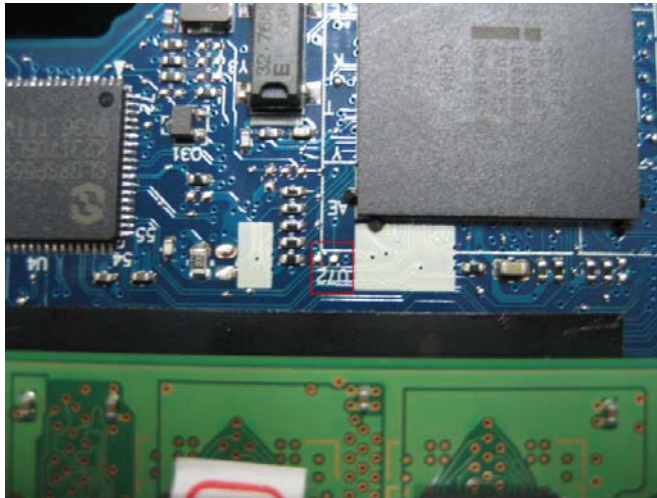

Cleaning BIOS Passwords

To clean the User or Supervisor passwords, perform the following steps:

1. From a DOS prompt, execute **clnPwd.exe**
2. Press **1** or **2** to clean the desired password shown on the screen.

```
d:\ClnPwd>clnPwd
ACER Clean Password Utility V1.00
Press 1 or 2 to clean any password shown as below
  1.User Password
  2.Supervisor Password

Clean User Password Successfully!
```

The onscreen message determines whether the function is successful or not.

Miscellaneous Utilities

Using Boot Sequence Selector

Boot Sequence Selector allows the boot order to be changes without accessing the BIOS. To use Boot Sequence Selector, perform the following steps:

1. Enter into DOS.
2. Execute BS.exe to display the usage screen.

```
d:\BOOTSEQ>bs

*** Boot Sequence Selector Version 0.03 ***
Create by Rockwell Chuang 10/01/2005.

Usage:
      BS [ 1 | 2 | 3 | 4 ]

BS 1 : [ Floppy ] => [ HardDisk ] => [ CD-ROM ] => [ LAN   ]
BS 2 : [ HardDisk ] => [ CD-ROM ] => [ LAN   ] => [ Floppy ]
BS 3 : [ CD-ROM ] => [ HardDisk ] => [ LAN   ] => [ Floppy ]
BS 4 : [ LAN   ] => [ Floppy ] => [ HardDisk ] => [ CD-ROM ]

d:\BOOTSEQ>
```

3. Select the desired boot sequence by entering the corresponding sequence, for example, enter BS2 to change the boot sequence to HDD|CD ROM|LAN|Floppy.

Using DMITools

The DMI (Desktop Management Interface) Tool copies BIOS information to eeprom to be used in the DMI pool for hardware management.

When the BIOS displays **Verifying DMI pool data** it is checking the table correlates with the hardware before sending to the operating system (Windows, etc.).

To update the DMI Pool, perform the following steps:

1. Enter into DOS.
2. Execute **dmitools.exe**. The following messages show dmitools usage:
DMITools [/R | /WP | /WS | /WU] [STRING]
 - dmitools /r ==> Read dmi string from bios
 - dmitools /wm xxxx ==> Write manufacturer name to eeprom
 - dmitools /wp xxxx ==> Write product name to eeprom
 - dmitools /ws xxxx ==> Write serial number to eeprom
 - dmitools /wu xxxx ==> Write uuid to eeprom
 - dmitools /wa xxxx ==> Write asset tag to eeprom

IMPORTANT:The following write examples (2 to 5) require a system reboot to take effect

Example 1: Read DMI Information from Memory

Input:

```
dmitools /r
```

Output:

```
Manufacturer (Type1, Offset04h): Acer  
Product Name (Type1, Offset05h): Aspire one xxxxx  
Serial Number (Type1, Offset07h): 01234567890123456789  
UUID String (Type1, Offset08h): xxxxxxxx-xxxx-xxxx-xxxx-xxxxxxxxxxxx  
Asset Tag (Type3, Offset04h): Acer Asstag
```

Example 2: Write Product Name to EEPROM

Input:

```
dmitools /wp Acer
```

Example 3: Write Serial Number to EEPROM

Input:

```
dmitools /ws 01234567890123456789
```

Example 4: Write UUID to EEPROM (Create UUID from Intel WFM20.pdf)

Input:

```
dmitools /wu
```

Example 5: Write Asset Tag to EEPROM

Input:

```
dmitools /wa Acer Asstag
```

Using the LAN MAC Utility

Perform the following steps to write MAC information to eeprom:

1. Use a text editor, for example Notepad, to edit the MAC.CFG file as shown:



```
MAC.CFG - 記事本  
檔案(F) 編輯(E) 格式(O) 檢視(V) 說明(H)  
Title= MAC Address byte  
WriteData='001122334455'  
StartAddr=7A  
WriteLeng=6  
KeepByte=0
```

- WriteData= '001122334455' <----- MAC value
- StartAddr=7A <----- MAC address
- WriteLeng=6 <----- MAC value length
- KeepByte=0 <----- can be any value

2. Boot into DOS.

-
3. Execute **MAC.BAT** to write MAC information to eeprom.

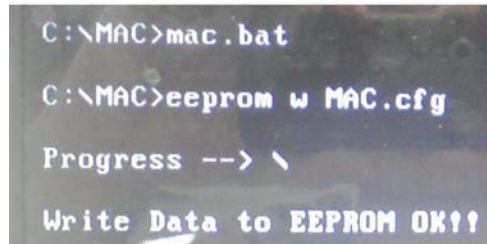

```
C:\MAC>mac.bat  
C:\MAC>eeprom w MAC.cfg  
Progress --> \  
Write Data to EEPROM OK!!
```

Machine Disassembly and Replacement

IMPORTANT: The outside housing and color may vary from the mass produced model.

This chapter contains step-by-step procedures on how to disassemble the notebook computer for maintenance and troubleshooting.

Disassembly Requirements

To disassemble the computer, you need the following tools:

- Wrist grounding strap and conductive mat for preventing electrostatic discharge
- Flat screwdriver
- Philips screwdriver
- Plastic flat screwdriver
- Plastic tweezers

NOTE: The screws for the different components vary in size. During the disassembly process, group the screws with the corresponding components to avoid mismatch when putting back the components.

General Information

Pre-disassembly Instructions

Before proceeding with the disassembly procedure, make sure that you do the following:

1. Turn off the power to the system and all peripherals.
2. Unplug the AC adapter and all power and signal cables from the system.



3. Place the system on a flat, stable surface.
4. Remove the battery pack.

Disassembly Process

The disassembly process is divided into the following stages:

- External module disassembly
- Main unit disassembly
- LCD module disassembly

The flowcharts provided in the succeeding disassembly sections illustrate the entire disassembly sequence. Observe the order of the sequence to avoid damage to any of the hardware components. For example, if you want to remove the mainboard, you must first remove the keyboard, then disassemble the inside assembly frame in that order.

Main Screw List

Screw	Quantity	Part Number
M2*4 Ni	2	86.WH202.001
M2*4	7	86.WH202.002
M2*8	11	86.WH202.004
M2*3	26	86.WH202.005
M3*3 Ni	4	86.WH202.006

External Module Disassembly Process

IMPORTANT:The outside housing and color may vary from the mass produced model.

External Modules Disassembly Flowchart

The flowchart below gives you a graphic representation on the entire disassembly sequence and instructs you on the components that need to be removed during servicing. For example, if you want to remove the main board, you must first remove the keyboard, then disassemble the inside assembly frame in that order.

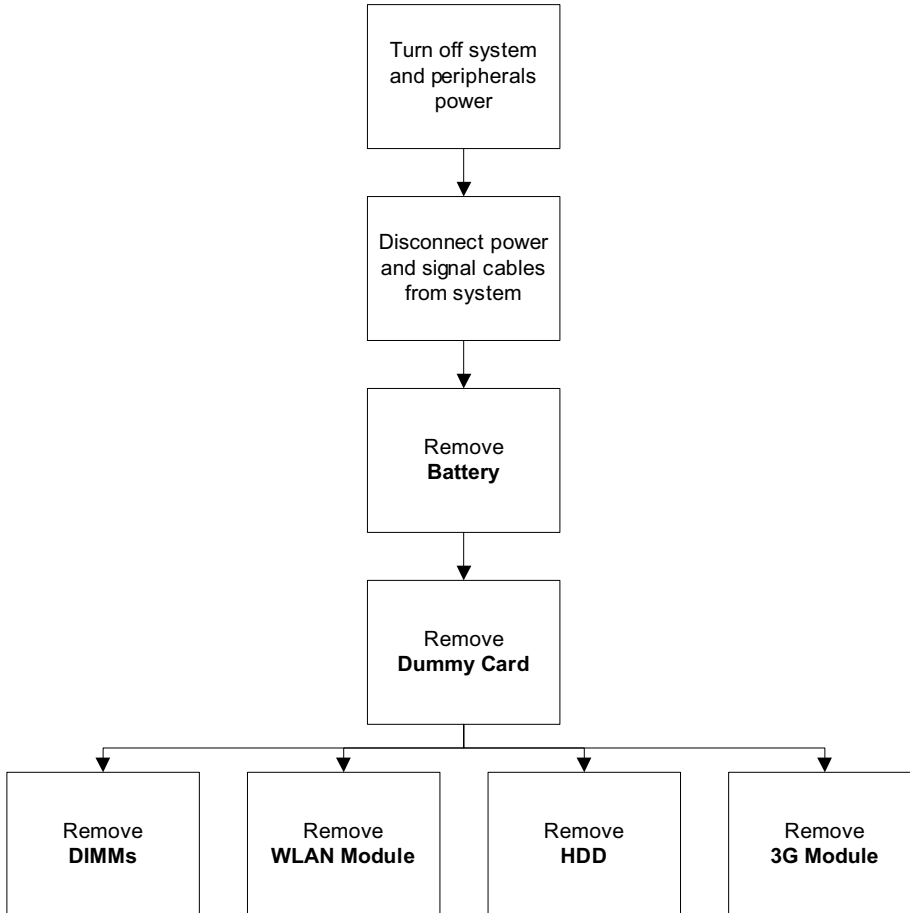

Screw List

Step	Screw	Quantity	Part No.
WLAN Module	M2*3	1	86.WH202.005
3G Module	M2*3	1	86.WH202.005
HDD Carrier	M3*3	4	86.WH202.006

Removing the Battery Pack

1. Turn computer over. Slide the battery lock in the direction shown.



2. Slide and hold the battery release latch to the release position (1), then lift out the battery pack from the main unit (2).



Removing the SD Dummy Card

1. Push the SD dummy card inwards to eject it.



2. Pull the card out from the slot.



Removing the DIMM Module

1. Remove the one (1) captive screws of the RAM cover.



2. Lift off the RAM cover.



3. Push out the release latches on both sides of the DIMM socket to release the DIMM module.

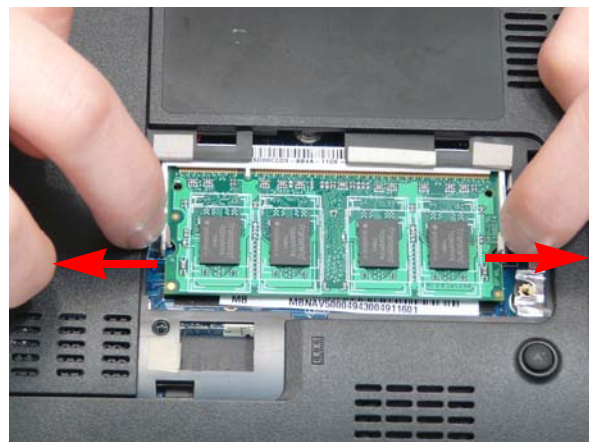

4. Remove the DIMM module.



Removing the HDD Module

1. See "Removing the Battery Pack" on page 40.
2. Loosen the three (3) captive screws on the HDD cover.



3. Pry up the HDD cover at the location shown and remove.



4. Lift out the pull-tab.

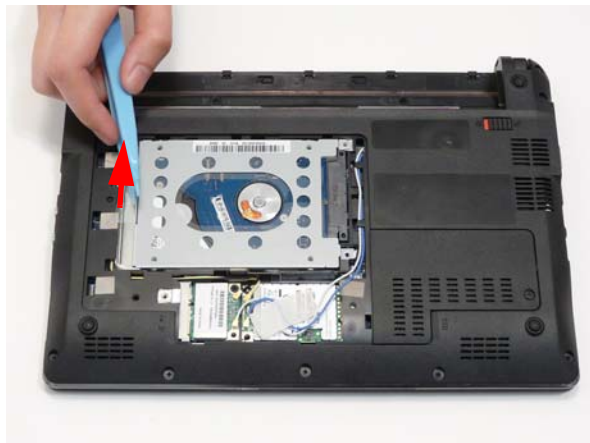

5. Grasp the pull-tab and pull the HDD module out of the bay.

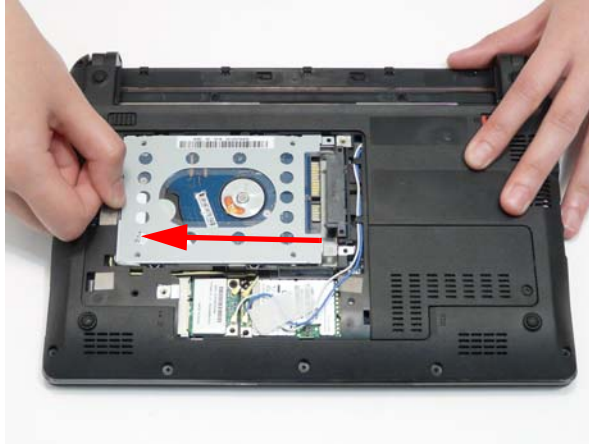

6. Remove the HDD module.



7. Remove the four (4) screws (two each side) securing the hard disk to the carrier.

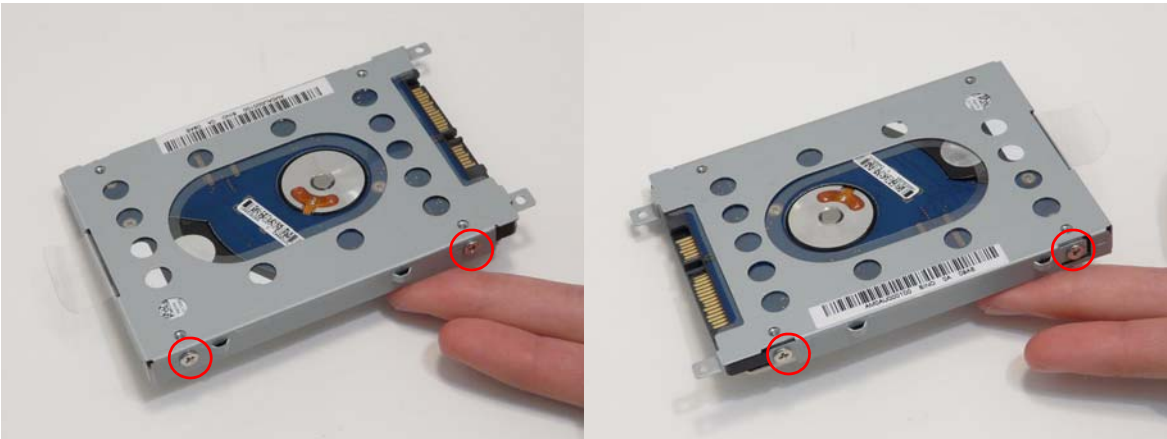

Step	Size	Quantity	Screw Type
HDD Carrier	M3*3	4	

8. Remove the HDD from the carrier.



Removing the WLAN Module

1. See “Removing the Battery Pack” on page 40.
2. Loosen the three (3) captive screws on the HDD cover.



3. Pry up the HDD cover at the location shown and remove.



4. Disconnect the antenna cables from the WLAN Module.

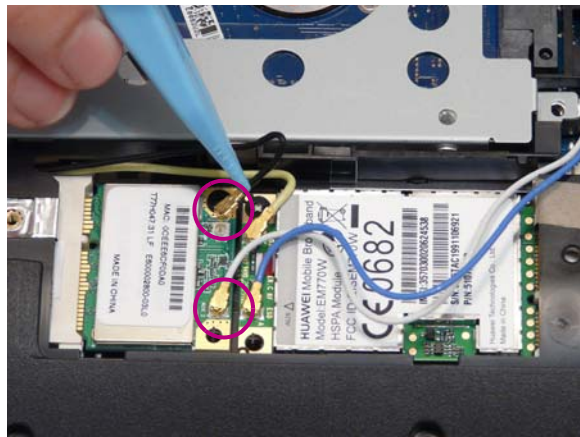

NOTE: Cable placement is **Black** to the **MAIN** terminal (top) and **White** to the **AUX** terminal (bottom).

5. Move the antennas away and remove the one (1) screw.



Step	Size	Quantity	Screw Type
WLAN Module	M2*3	1	

6. Remove the WLAN Module from the WLAN socket.



NOTE: When reattaching the antennas, ensure the cables are tucked into the chassis to prevent damage.

Removing the 3G Module

1. See "Removing the Battery Pack" on page 40.
2. Loosen the three (3) captive screws on the HDD cover.



3. Pry up the HDD cover and remove.



4. Disconnect the antenna cables from the 3G module.



NOTE: Cable placement is **BLUE** to the **MAIN** terminal (bottom) and **White** to the **AUX** terminal (top).

5. Move the antennas away and remove the one (1) screw.



Step	Size	Quantity	Screw Type
3G Module	M2*3	1	

6. Remove the 3G Module from the 3G socket.

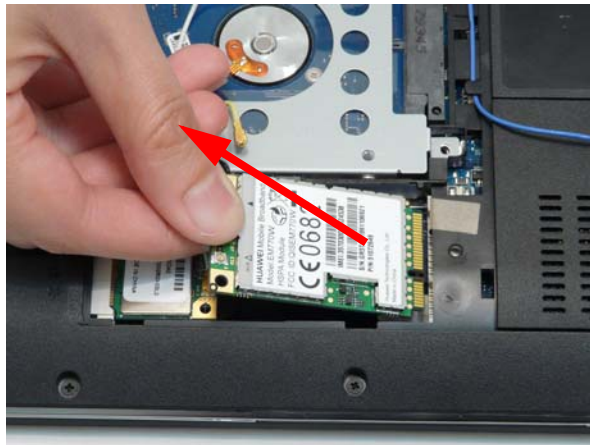

When reattaching the antennas, ensure the cables are tucked into the chassis to prevent damage.

Main Unit Disassembly Process

Main Unit Disassembly Flowchart

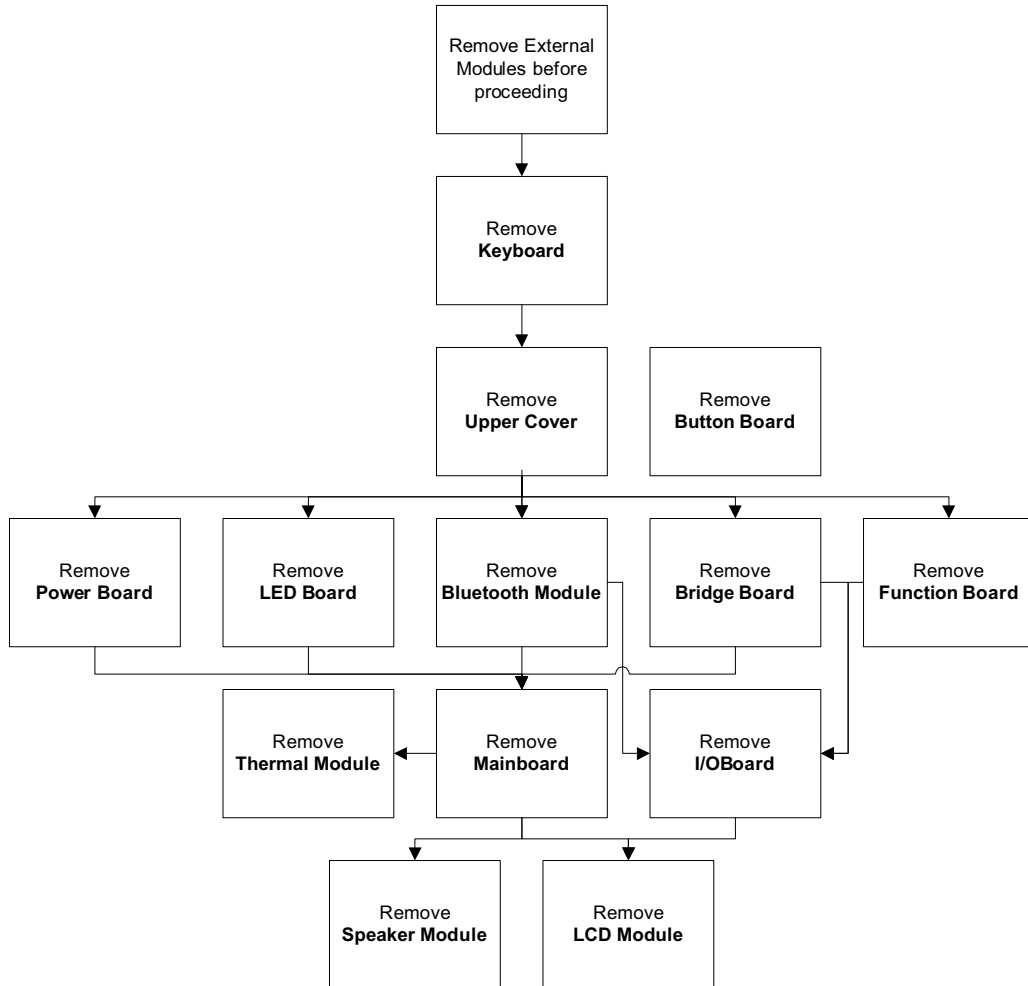

Screw List

Step	Screw	Quantity	Part No.
Upper Cover	M2*8	7	86.WH202.004
Lower Cover	M2*8	4	86.WH202.004
	M2*3	2	86.WH202.005
	M2*4	5	86.WH202.002
Button Board	M2*3	2	86.WH202.005
LED Board	M2*3	1	86.WH202.005
Bridge Board	M2*3	2	86.WH202.005
I/O Board	M2*3	1	86.WH202.005
Mainboard	M2*3	1	86.WH202.005
Thermal Module	M2*3	3	86.WH202.005
LCD Hinges	M2*4	2	86.WH202.002
Speakers	M2*3	4	86.WH202.005

Removing the Keyboard

1. Push down on the latch holding the top center of the keyboard.



2. Pry up the keyboard at the top center.

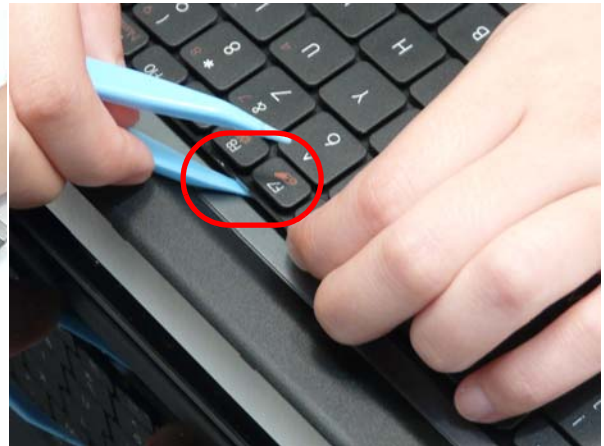

3. Lift up the left and right corners of the keyboard forcefully to release latches under the board.



4. Turn the keyboard over.



5. Unlock the FPC.

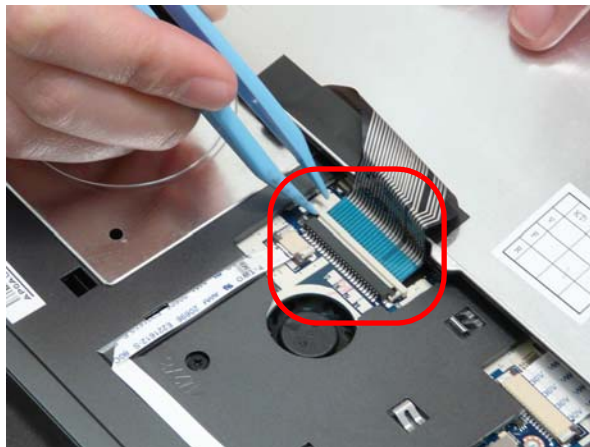

6. Remove the FPC and the keyboard.

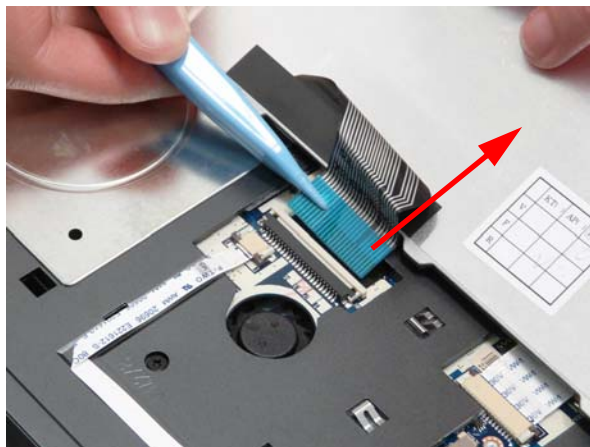

Removing the Upper Cover

1. See "Removing the Keyboard" on page 52.
2. Unlock and remove the power FFC.



3. Unlock and remove the buttonboard FFC.

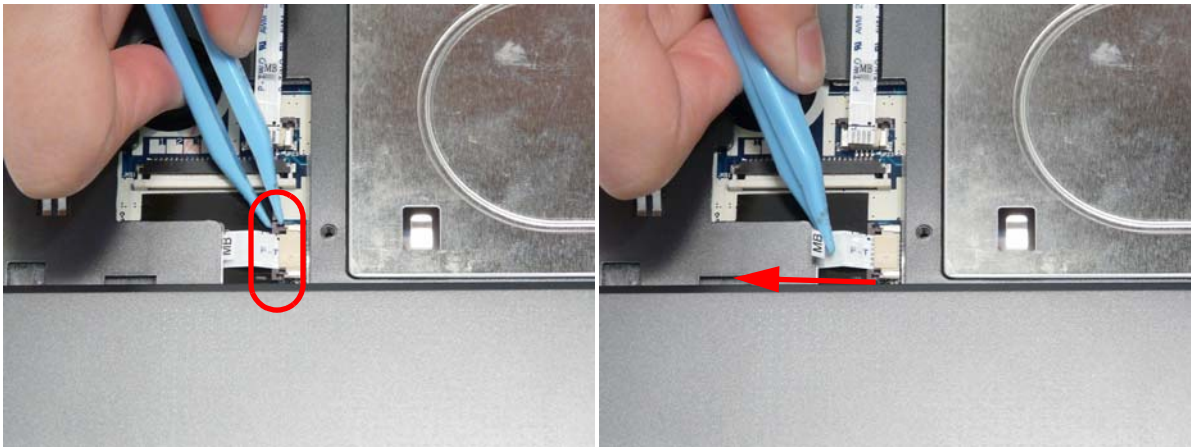

4. Remove the seven (7) screws in the upper cover.

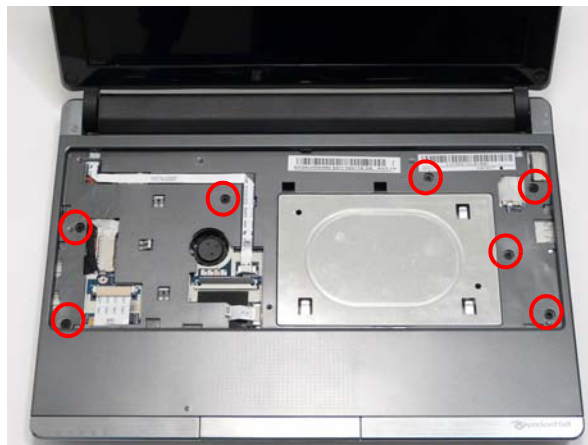





Step	Size	Quantity	Screw Type
Upper Cover	M2*8	7	

5. Turn the computer over. Detach the antenna cables from the retention guides.

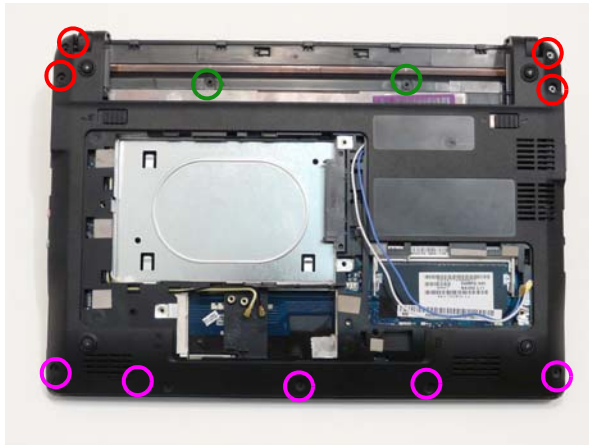

6. Remove the eleven (11) screws in the lower cover.



Step	Size	Quantity	Screw Type
Lower Cover	M2*8 (red call out)	4	
	M2x3 (green call out)	2	
	M2x4 (purple call out)	5	

-
7. Open the LCD module, stand the LCD module vertically, then pry the upper cover away from the lower cover at the location shown.



8. Continue to pry the covers apart long the front edge.



9. Pry apart the upper cover along the sides.



10. Firmly pull the upper cover up off the latches underneath the cover.



11. Remove the upper cover.

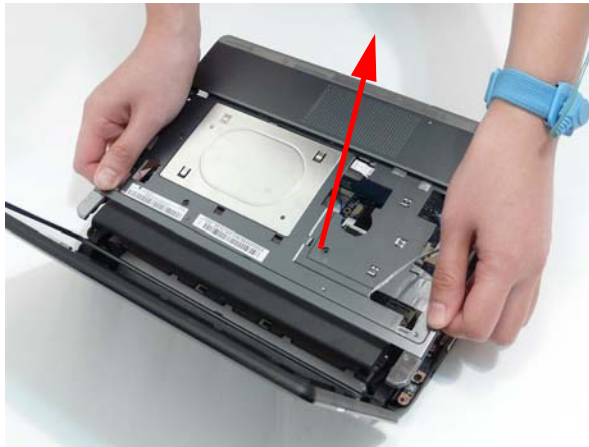

Removing the Button Board

1. See "Removing the Upper Cover" on page 54.
2. Remove the tape from the touchpad FFC.

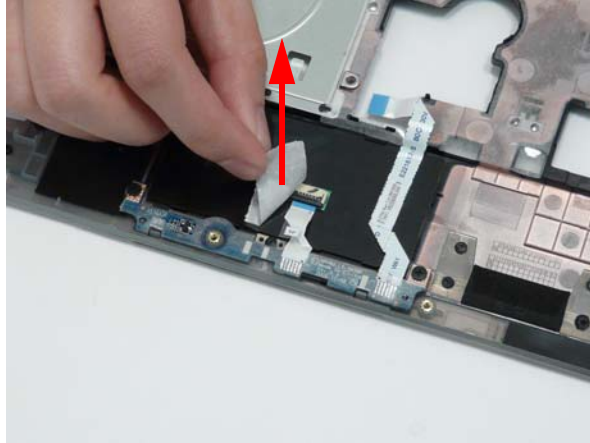

3. Release the touchpad FFC locking latch and disconnect the touchPad FFC from the cover.

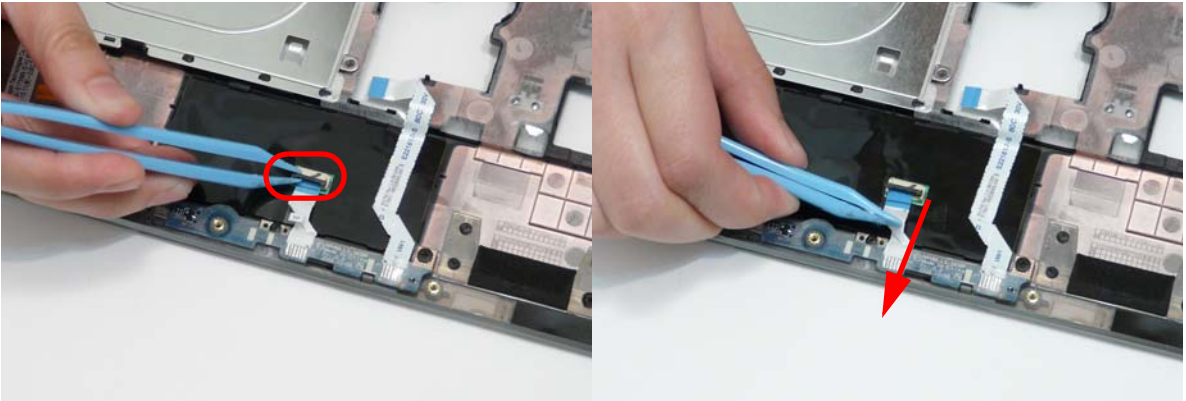

4. Pull the button board FFC off the adhesive.

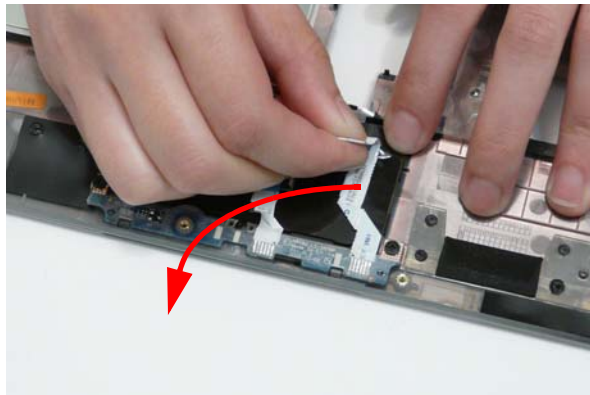

5. Remove the two (2) screws securing the TouchPad Bracket to the Upper Cover.

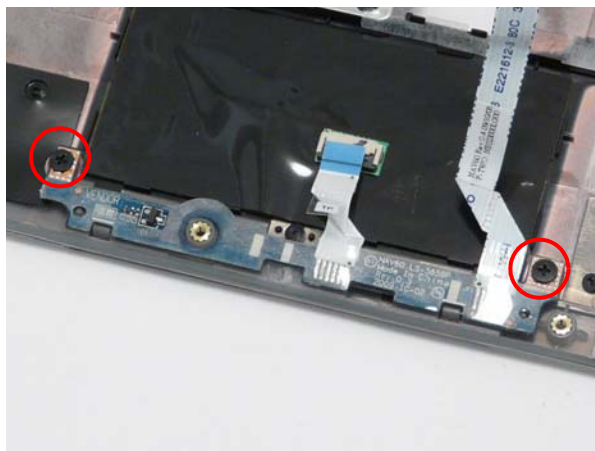

Step	Size	Quantity	Screw Type
Button Board	M2*3	2	

6. Remove the button board from the Upper Cover.

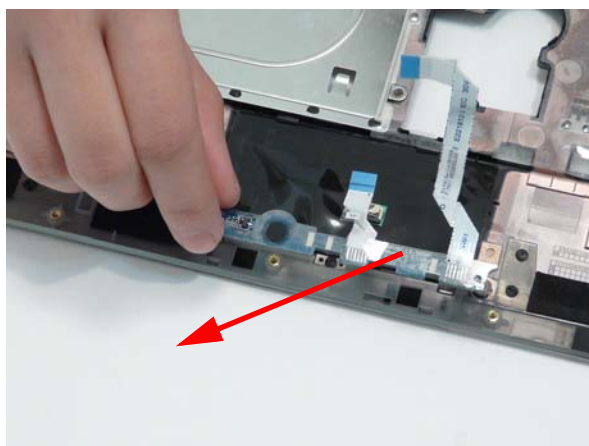

Removing the Power Board

1. See "Removing the Upper Cover" on page 54.
2. Pry the power board off the adhesive and remove.

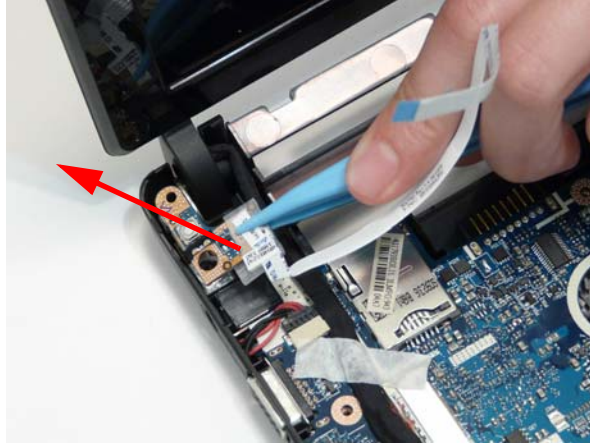

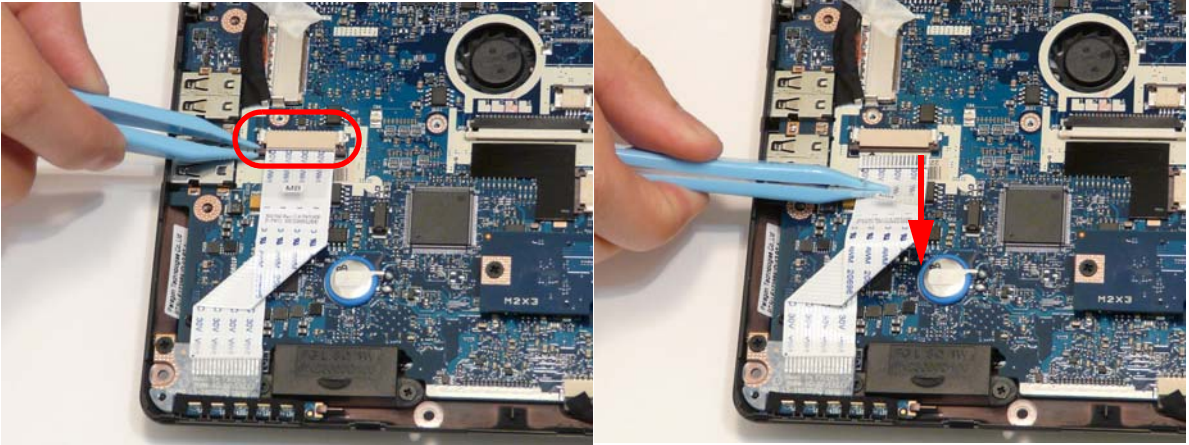

Removing the LED Board

1. See "Removing the Upper Cover" on page 54.
2. Unlock and remove the LED FFC from the mainboard.

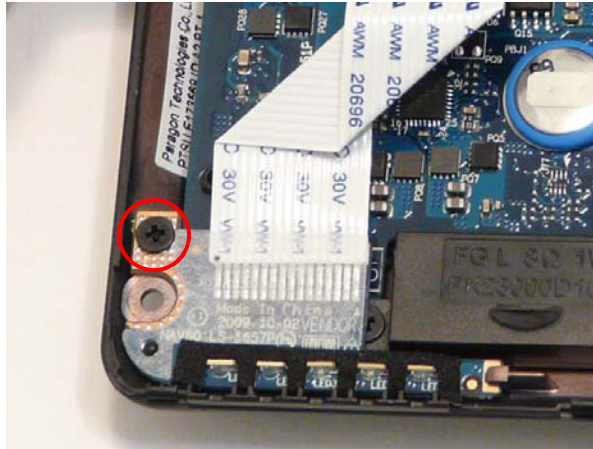

3. Remove the one (1) screw.



Step	Size	Quantity	Screw Type
LED Board	M2*3	1	

4. Lift the LED Board away from the chassis.

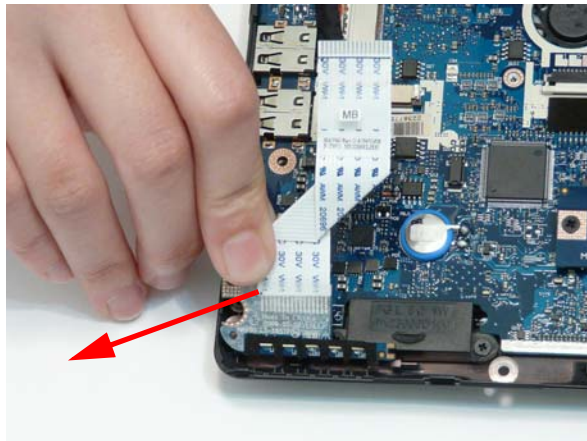

Removing the Function Board

1. See "Removing the Upper Cover" on page 54.
2. Remove the tape over the cables.

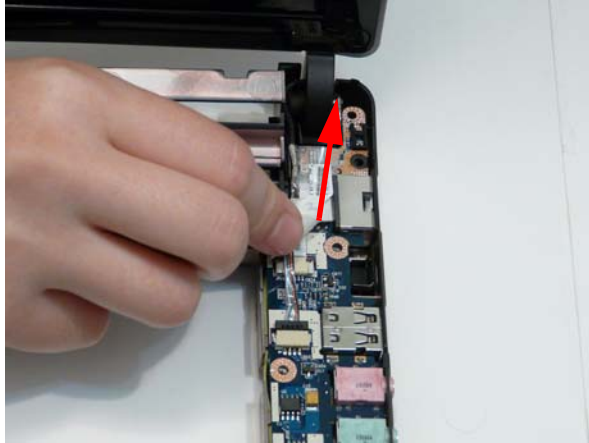

3. Disconnect the microphone cable.

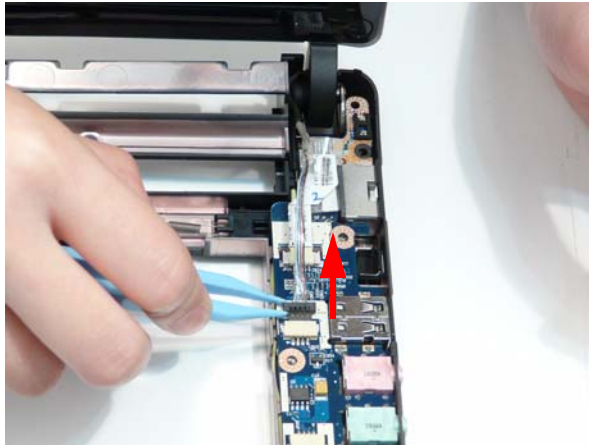

4. Unlock and disconnect the function board FFC.



5. Pry up the function board and remove.

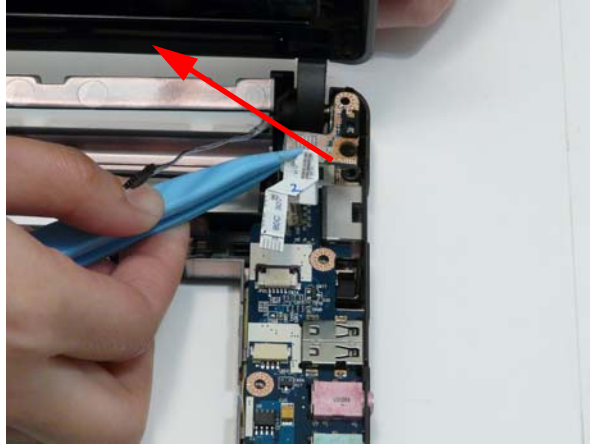

Removing the Bluetooth Module

1. See “Removing the Upper Cover” on page 54.
2. Disconnect the Bluetooth cable from the mainboard connector.

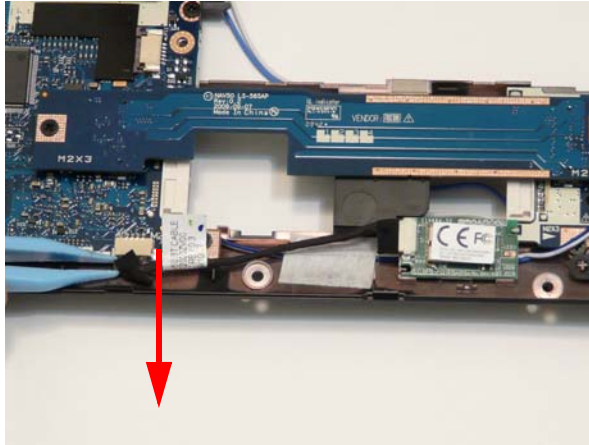

3. Pry the Bluetooth module off the adhesive.

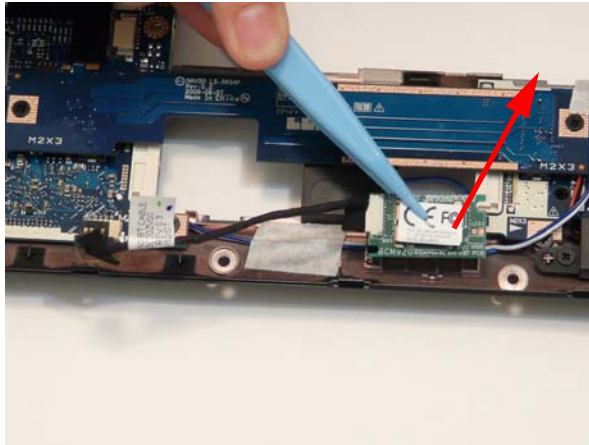

4. Disconnect the cable from the Bluetooth module.

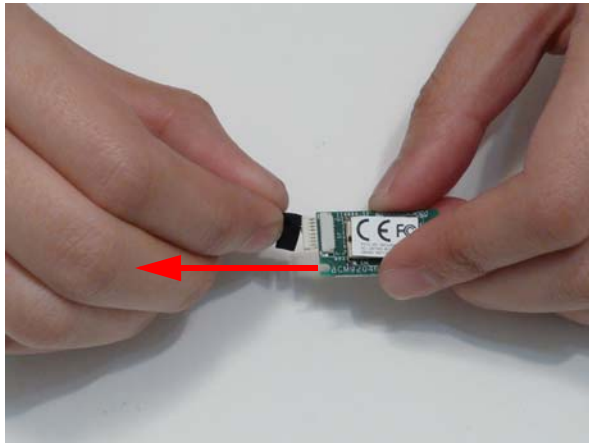

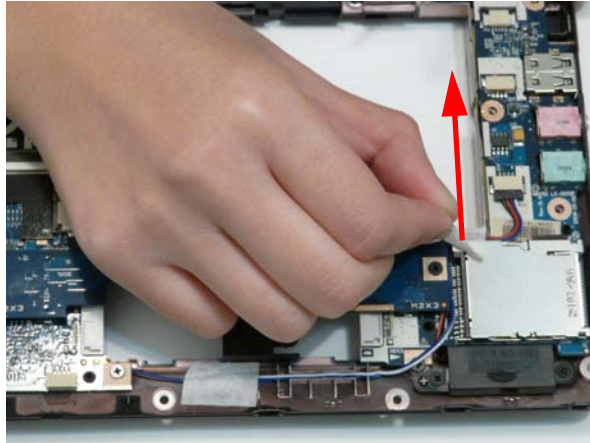

Removing the Bridge Board

1. See "Removing the Upper Cover" on page 54.
2. Remove the tape over the cables.

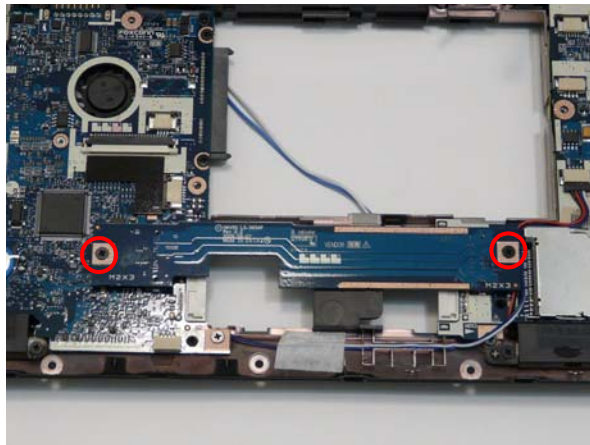

3. Remove the two (2) screws.



Step	Size	Quantity	Screw Type
Bridge Board	M2*3	2	

4. Remove the bridge board from the chassis.

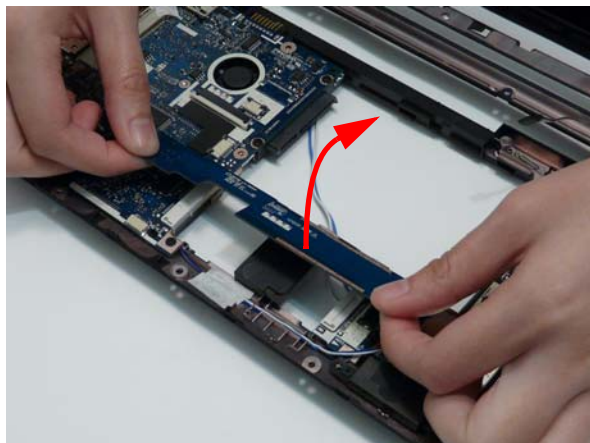

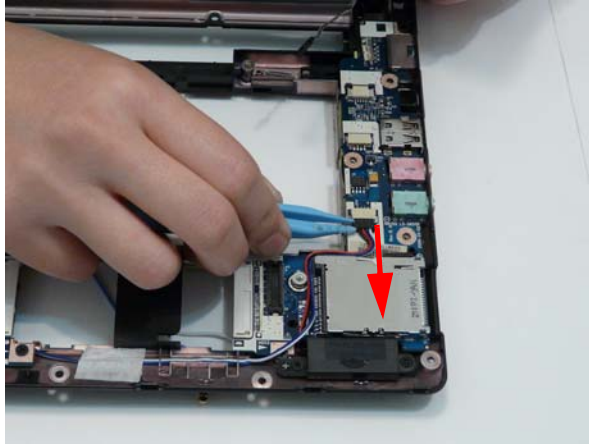

Removing the I/O Board

1. See "Removing the Upper Cover" on page 54.
2. See "Removing the Function Board" on page 62.
3. See "Removing the Bridge Board" on page 65.
4. Disconnect the speaker cable.

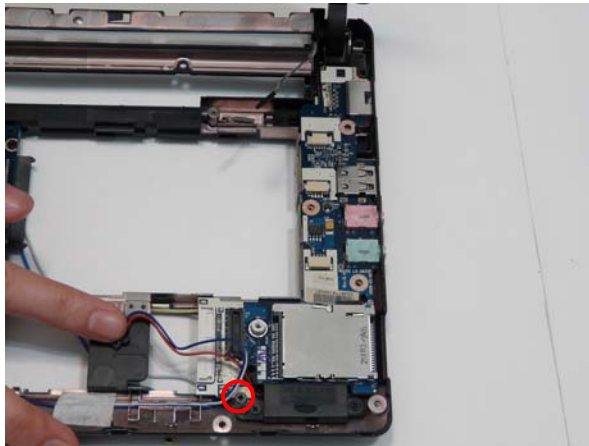

5. Remove the one (1) screw.



Step	Size	Quantity	Screw Type
I/O Board	M2*3	1	

6. Remove the I/O board from the chassis.

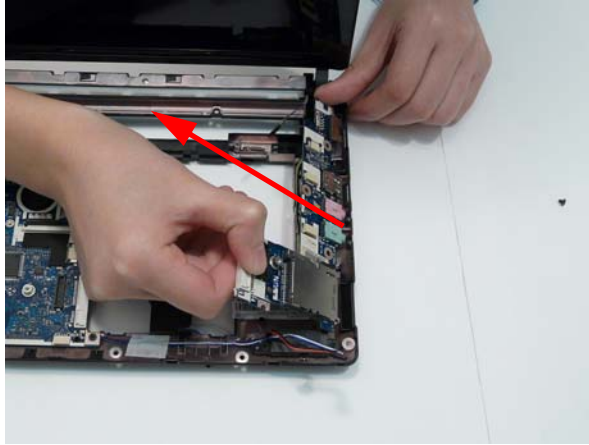

Removing the Mainboard

1. See “Removing the Power Board” on page 60.
2. See “Removing the LED Board” on page 61.
3. See “Removing the Function Board” on page 62.
4. See “Removing the Bluetooth Module” on page 64.
5. See “Removing the Bridge Board” on page 65.
6. Remove the tape from the LCD cable.



7. Disconnect the LCD cable.

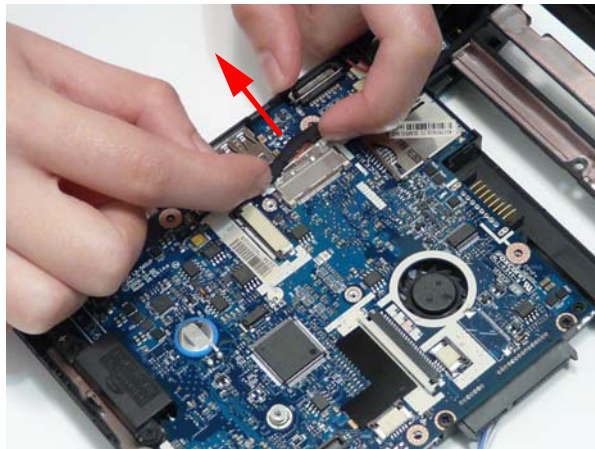

8. Disconnect the DC cable.

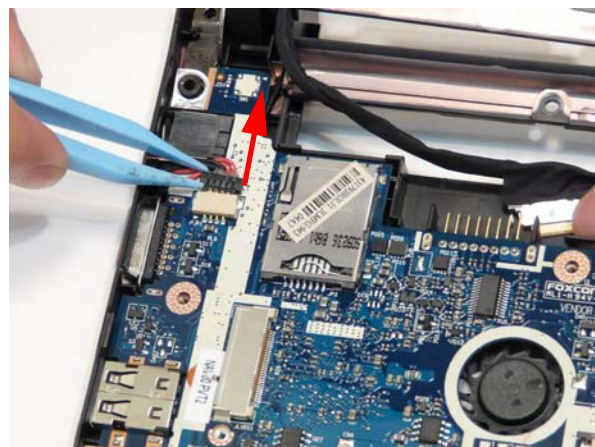

9. Remove the one (1) screw.



Step	Size	Quantity	Screw Type
Mainboard	M2*3	1	

Removing the Thermal Module

1. See “Removing the Mainboard” on page 68.
2. Disconnect the fan cable.

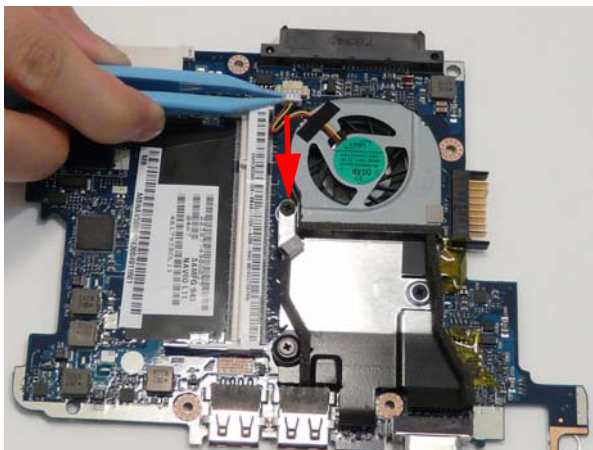

3. Remove the three (3) screws.



Step	Size	Quantity	Screw Type
Thermal Module	M2*3	3	

4. Remove the thermal module from the mainboard.

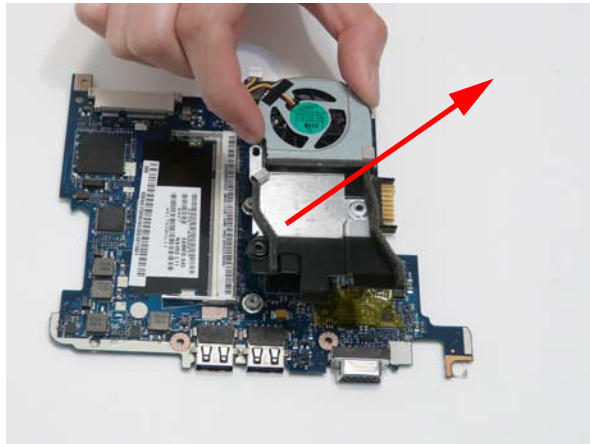

Removing the LCD Module

1. See “Removing the Mainboard” on page 68.
2. Remove the DC jack housing.



3. Lift up the chassis and pull the left antenna cables through to the front.

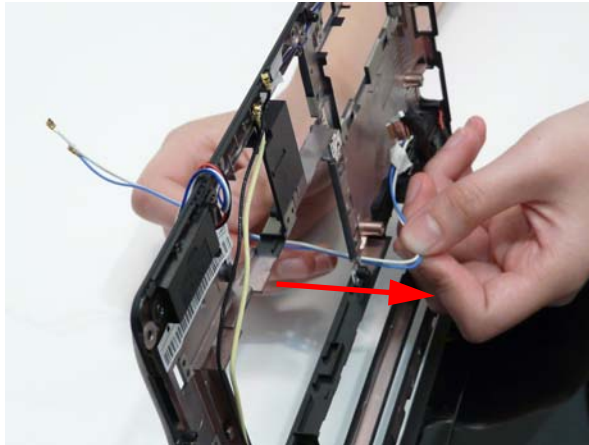

4. Remove the adhesive tape from the antenna cables.

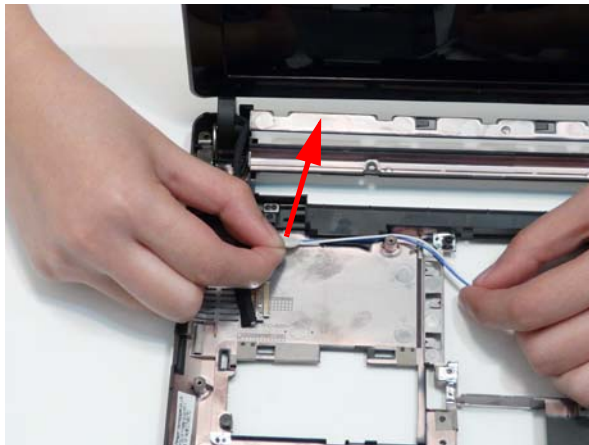

5. Remove the left antenna cables from the retention guides.

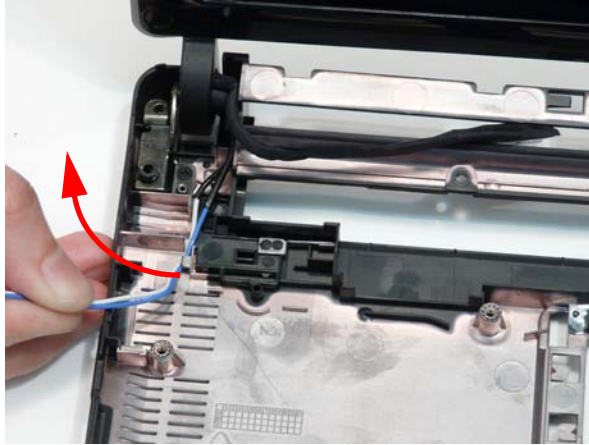

6. Remove the right antenna cables from the antenna guides.

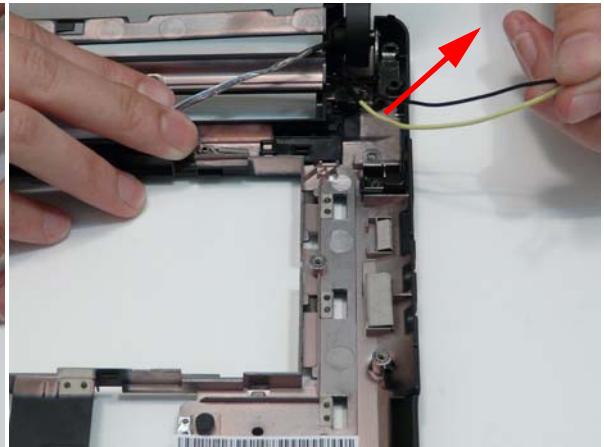
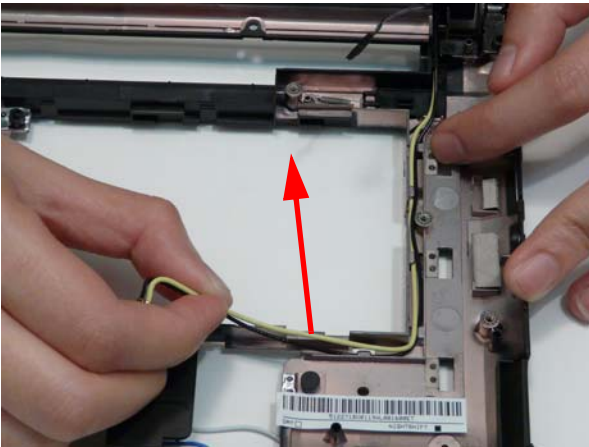

7. Remove the two (2) screws.

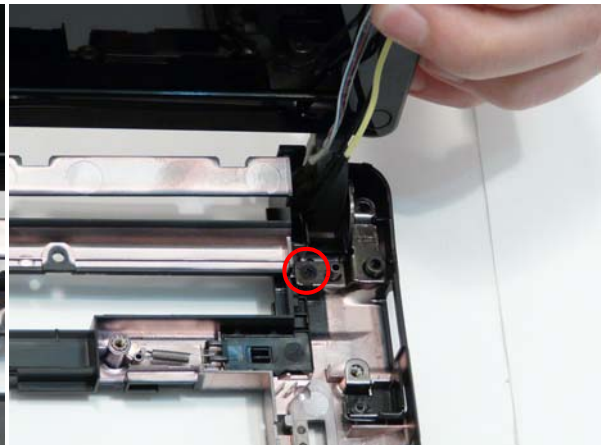
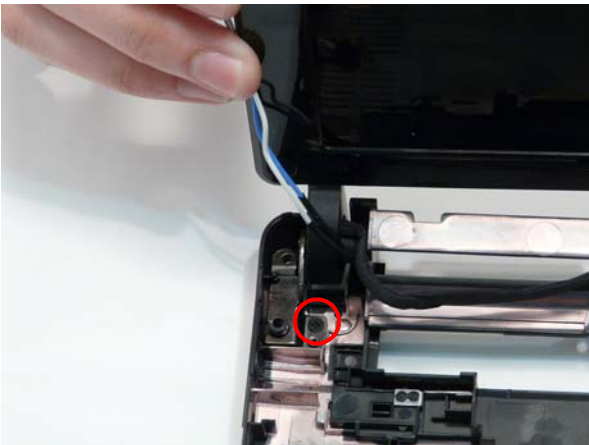

Step	Size	Quantity	Screw Type
LCD Module	M2*4	2	

8. Remove the LCD module from the chassis.

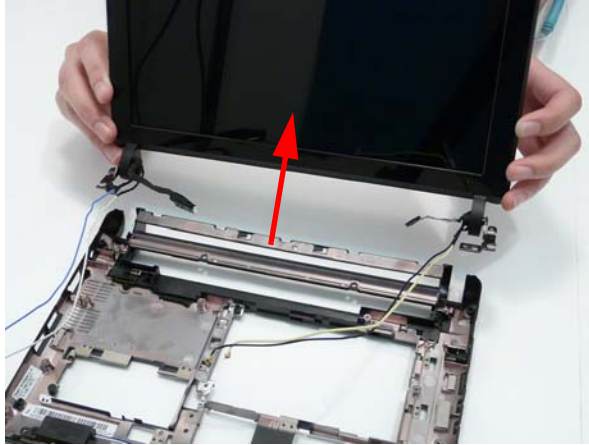

Removing the Speaker Module

1. See "Removing the I/O Board" on page 66.
2. See "Removing the Mainboard" on page 68.
3. Remove the four (4) screws.

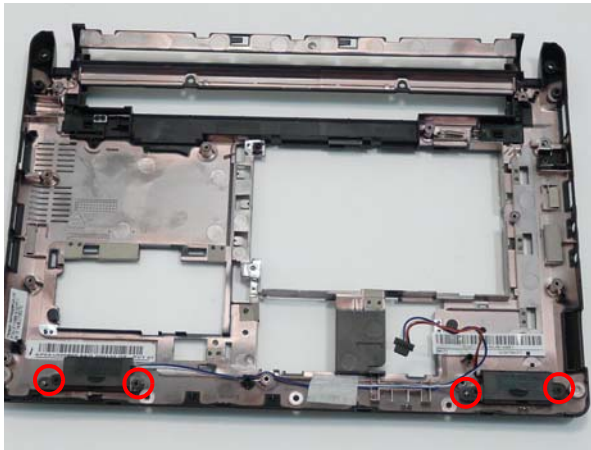

Step	Size	Quantity	Screw Type
Speakers	M2*3	4	

4. Remove the adhesive tape off the speaker cables.

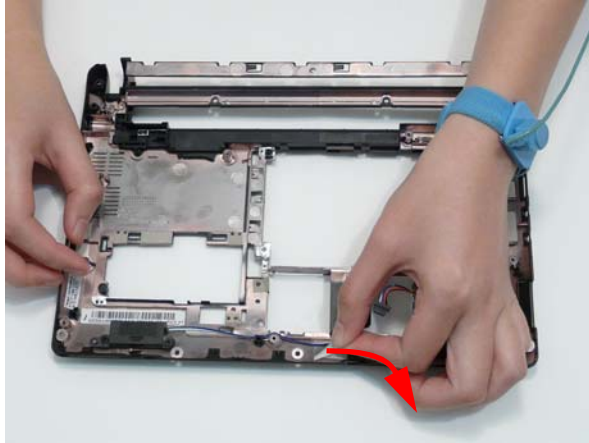

5. Remove the cables from the retention guides and pull away.

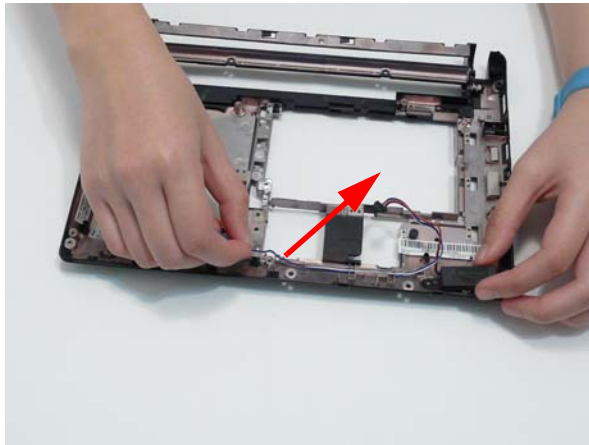

LCD Module Disassembly Process

LCD Module Disassembly Flowchart

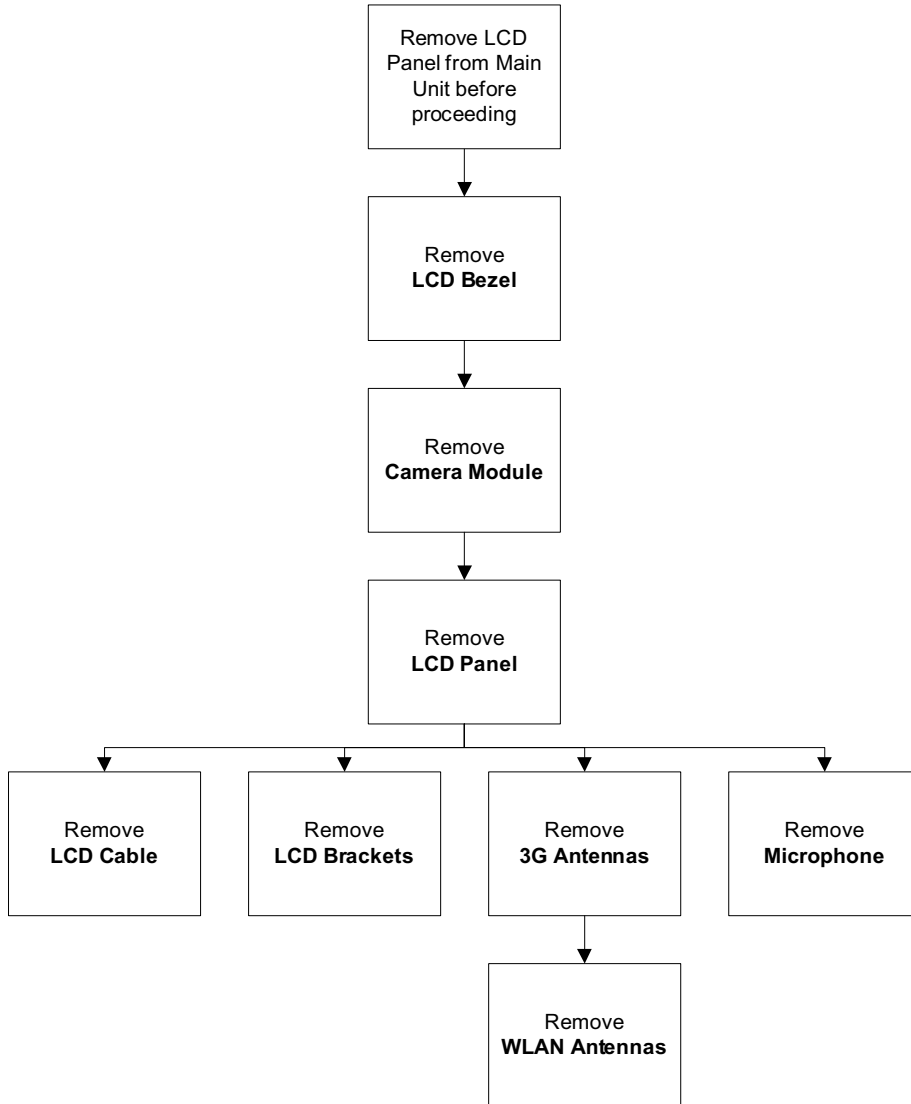

Screw List

Step	Screw	Quantity	Part No.
LCD Bezel	M2*4 Ni	2	86.WH202.001
LCD Panel	M2*3	4	86.WH202.005
LCD Brackets	M2*3	4	86.WH202.005

Removing the LCD Bezel

1. See "Removing the LCD Module" on page 71.
2. Remove the two (2) screw caps.



3. Remove the two (2) screws.



Step	Size	Quantity	Screw Type
LCD Bezel	M2*4 Ni	2	

4. Starting from the bottom center of the bezel, pry the bezel upwards and away from the panel. Move along the edge and down each side until all sides of the bezel are removed.

NOTE: If necessary, use a pry to lift up the outside edges of the bezel.



Removing the Camera Module

1. See "Removing the LCD Bezel" on page 76.
2. Disconnect the camera cable.

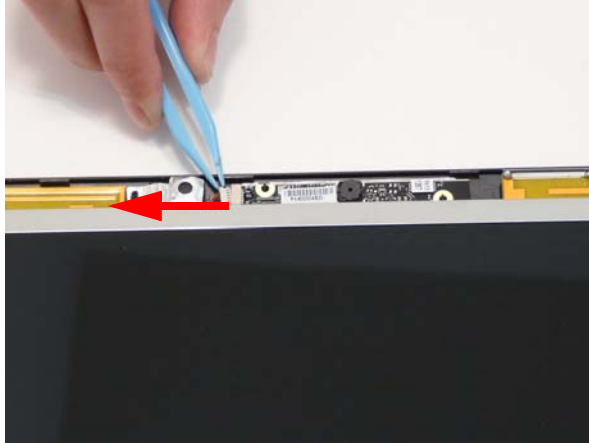

3. Pry the camera from the module.

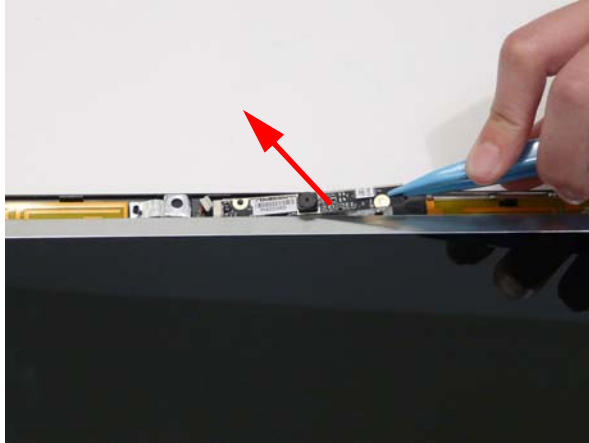

Removing the LCD Panel

1. See "Removing the Camera Module" on page 78.
2. Lift the foil off the LCD cable.

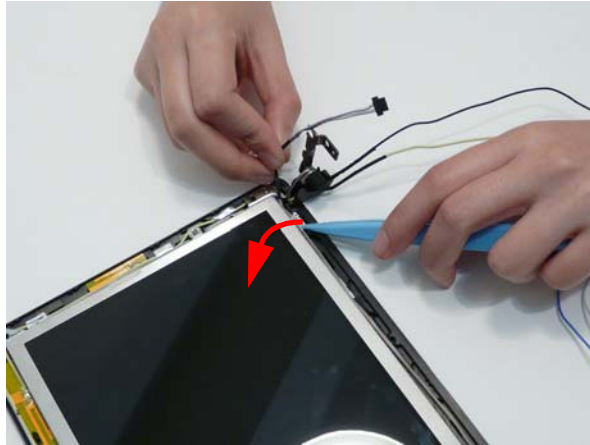

3. Remove the four (4) securing screws from the LCD Panel.



Step	Size	Quantity	Screw Type
LCD Panel	M2*3	4	

4. Lift the LCD Panel out of the module, top edge first, as shown.

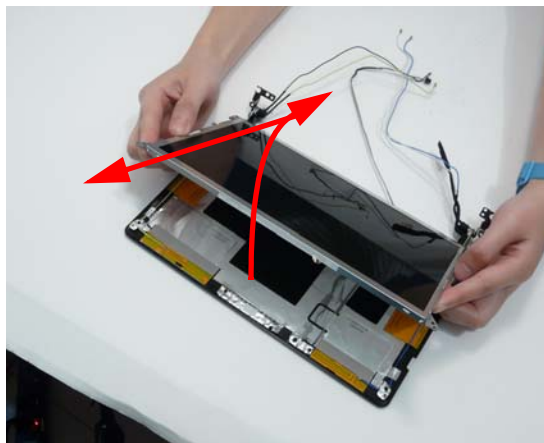

Removing the LCD Brackets and Cable

1. See "Removing the LCD Panel" on page 79.
2. Remove the four (4) screws of the LCD brackets.



Step	Size	Quantity	Screw Type
LED Panel Brackets	M2*3	4	

3. Turn the LCD panel over to expose the rear. Lift the cable as shown to disengage the adhesive strip securing it in place.

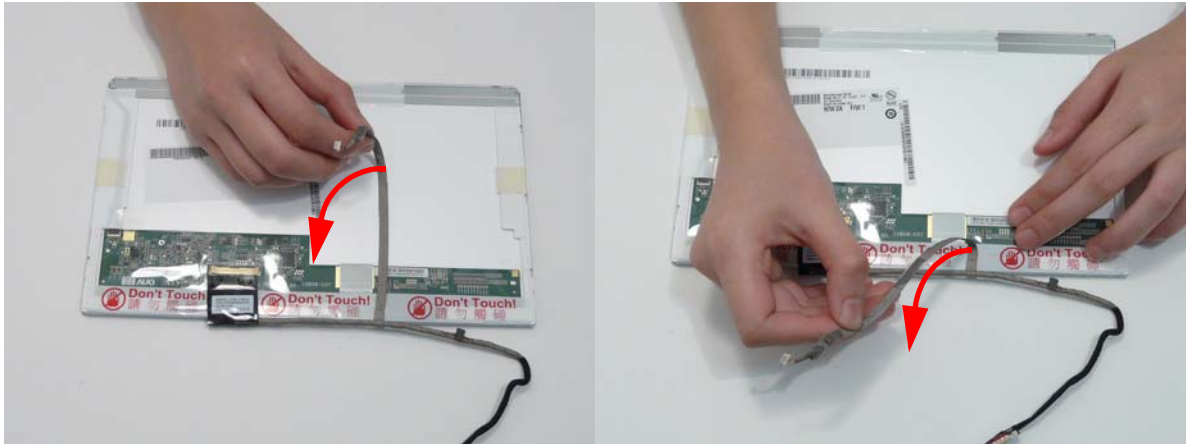

4. Lift up the transparent adhesive protector securing the cable to the LCD Panel.

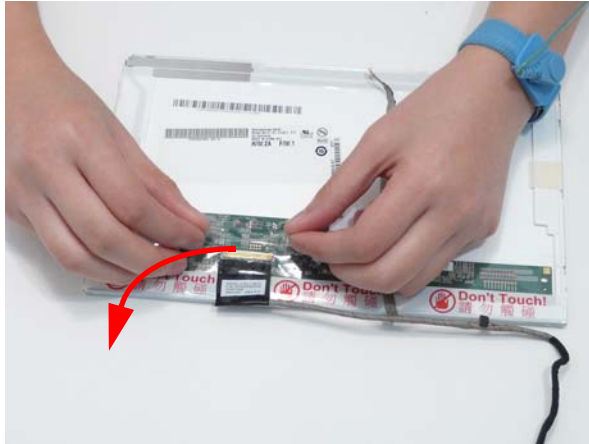

5. Disconnect the cable from the panel connector and lift the FPC cable from the panel.



Removing the Microphone Module

1. See "Removing the LCD Panel" on page 79.
2. Lift the foil tabs off the microphone cable.



3. Lift the foil tab off the microphone module.

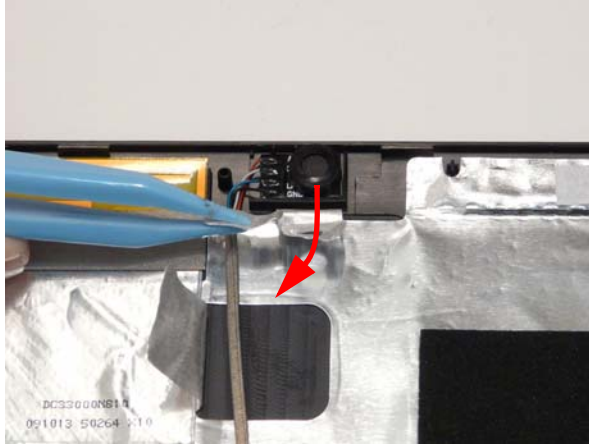

4. Lift the microphone module clear of the module.

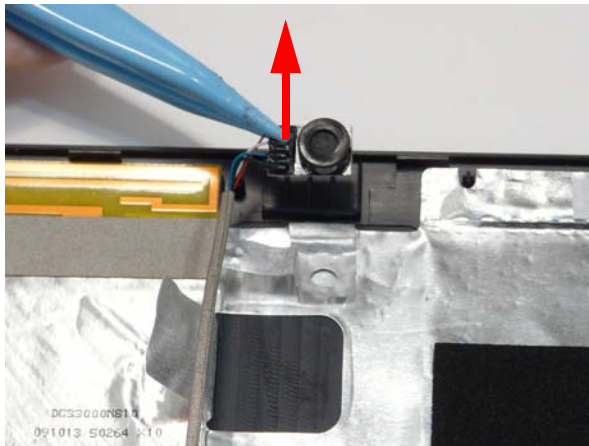

Removing the 3G Antennas

1. See "Removing the LCD Panel" on page 79.
2. Lift the foil tabs off the 3G right cable.

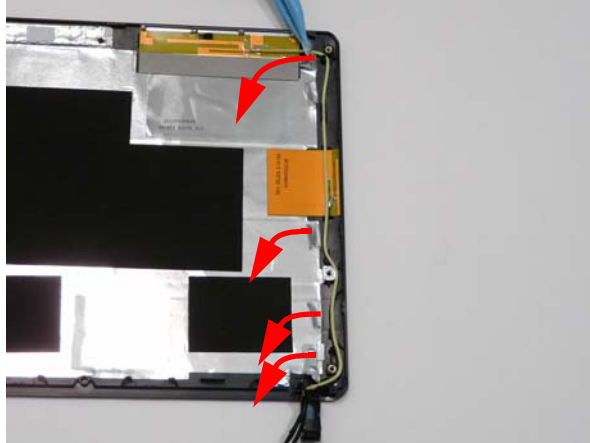

3. Lift the right 3G antenna cable out of the retention guides.

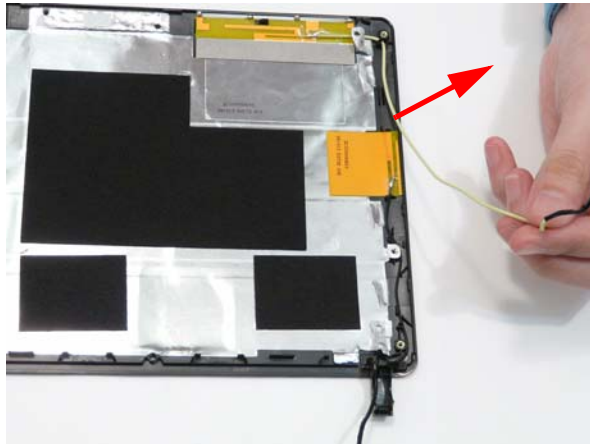

4. Pry the right 3G antenna off the LCD module cover.

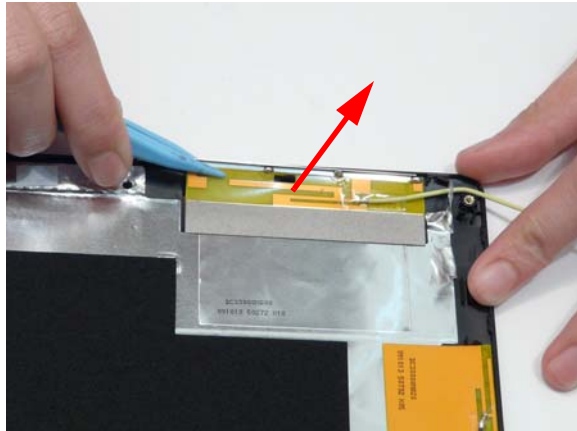

5. Lift the right antenna foil off the adhesive backing.

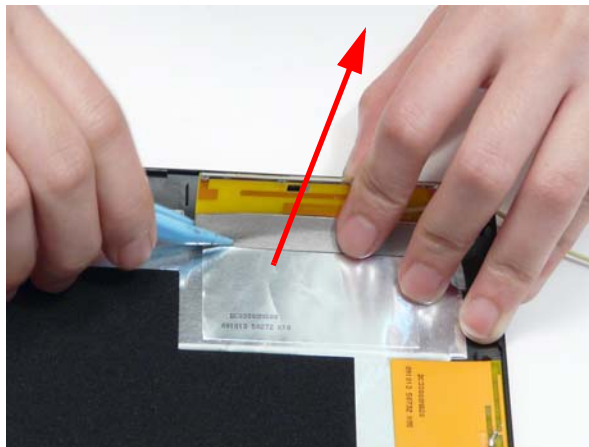

6. Lift the foil tab off the left 3G antenna cable.

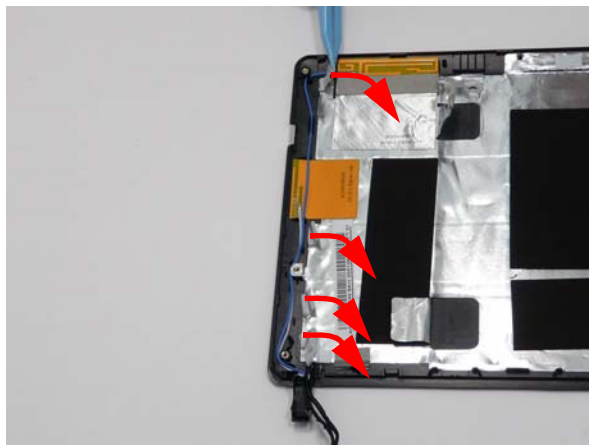

7. Pull the left 3G antenna cable out of the retention guides.

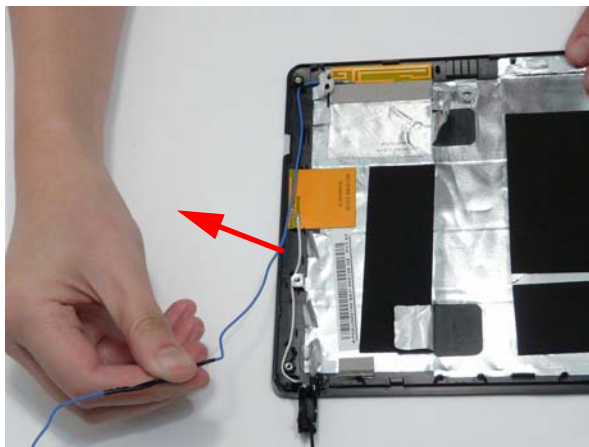

8. Pry the left 3G antenna off the LCD module cover.

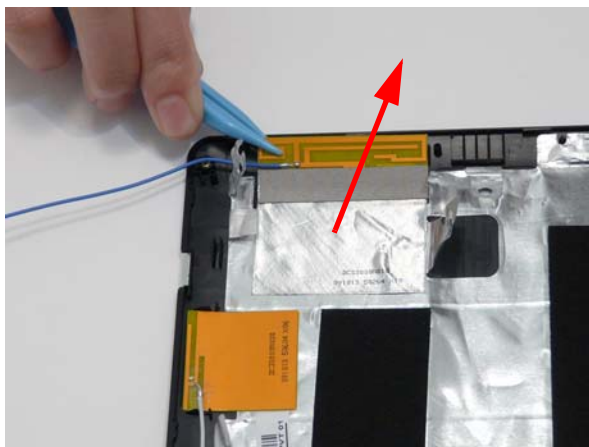

Removing the WLAN Antennas

1. See "Removing the 3G Antennas" on page 83.
2. Remove the right WLAN antenna cable from the cable retention guides.

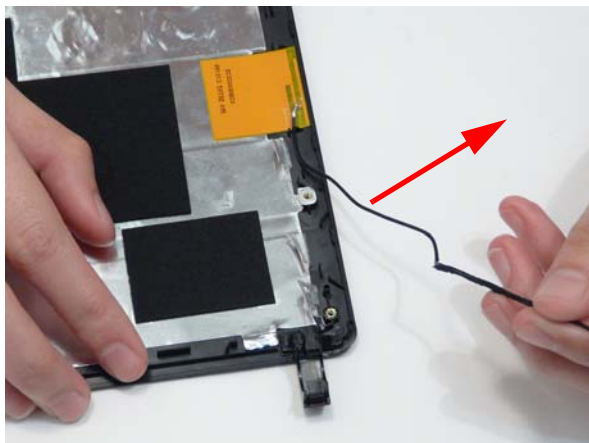

3. Pry the right WLAN antenna off the LCD module cover.

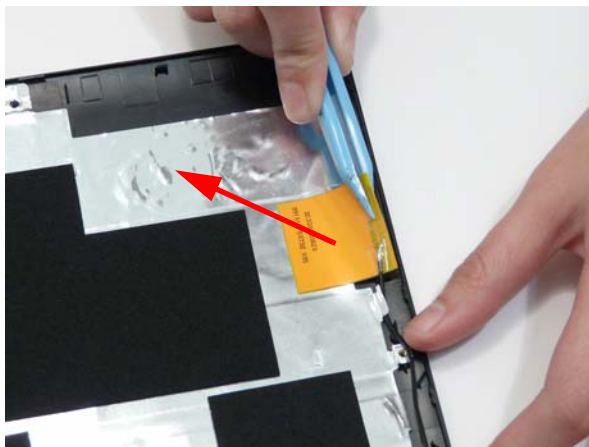

4. Remove the left WLAN antenna cable away from the retention guides.

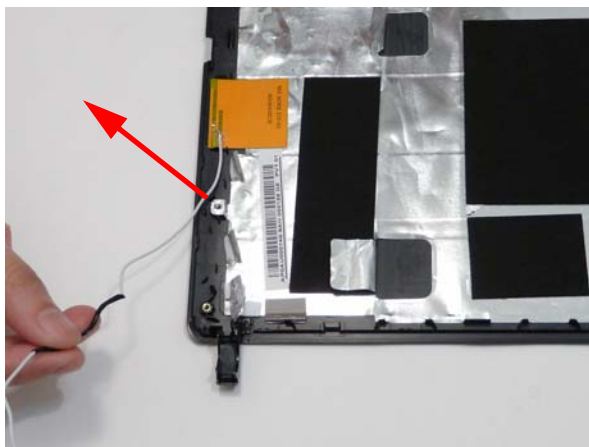

5. Pry the WLAN antenna off the LCD module cover.

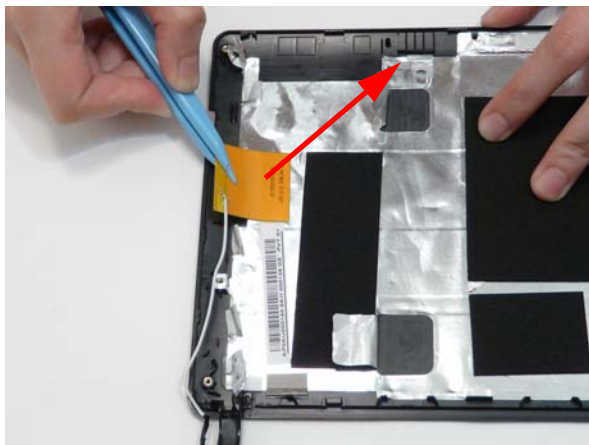

LCD Module Reassembly Procedure

Replacing the WLAN Antennas

1. Replace the left (white cable) and right (black cable) antennas as shown. Press down on the adhesive pads to secure the antennas in place.

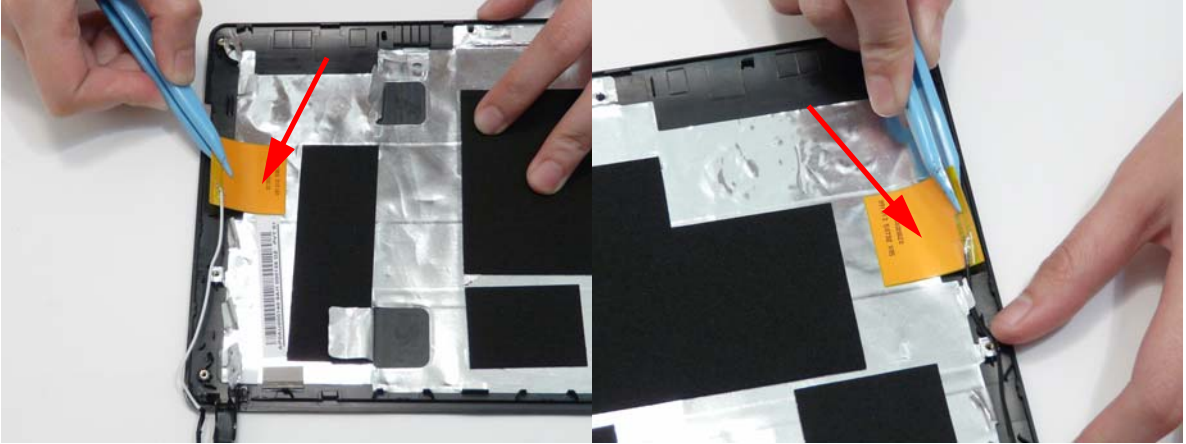

2. Lay the cables along the cable channel.

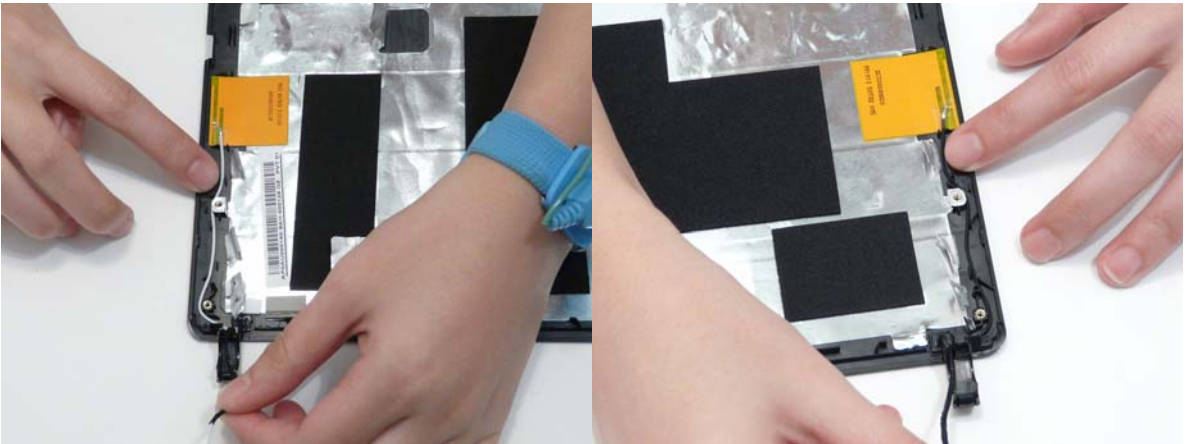

Replacing the 3G Antennas

1. Adhere the left 3G antenna (blue cable) onto the LCD module cover.

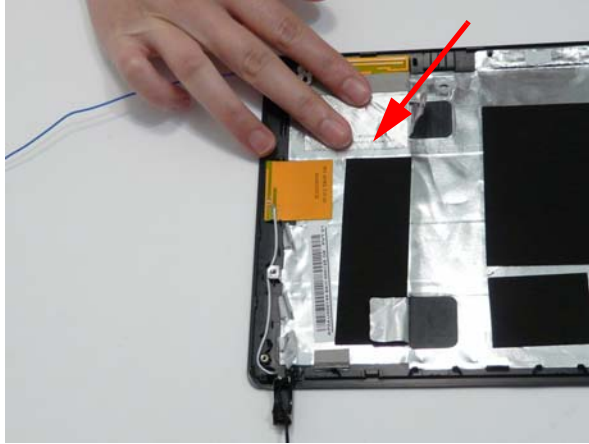

2. Lay the cable through the cable channel guides.



3. Replace the foil tabs over the cables.

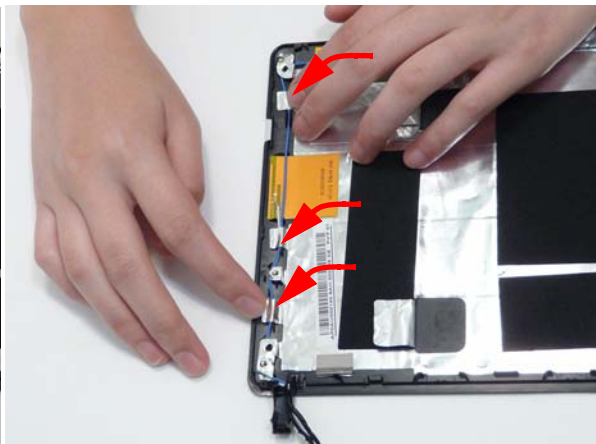
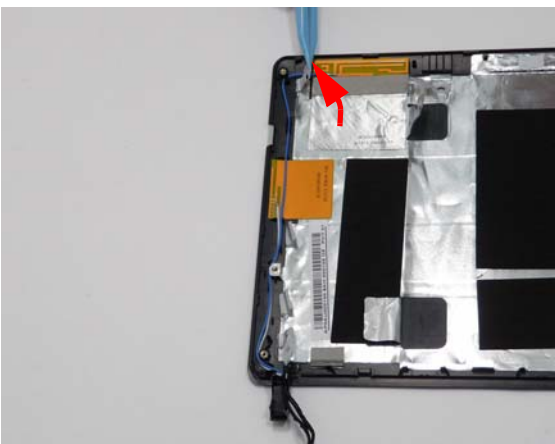

4. Adhere the right side 3G antenna (yellow cable) to the LCD module case.

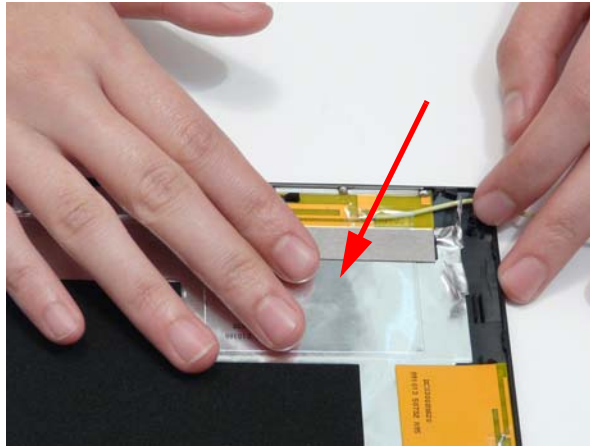

5. Lay the cable through the cable channel guides.

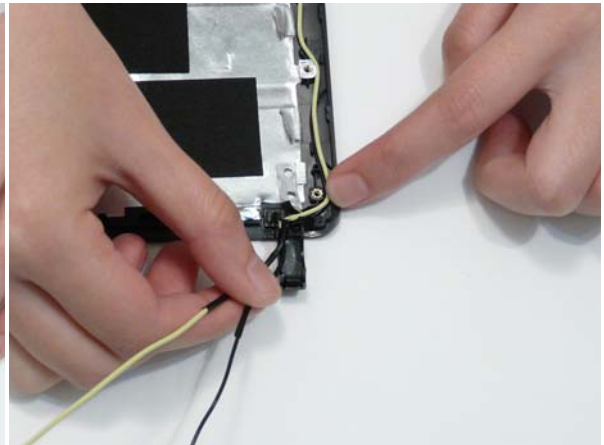
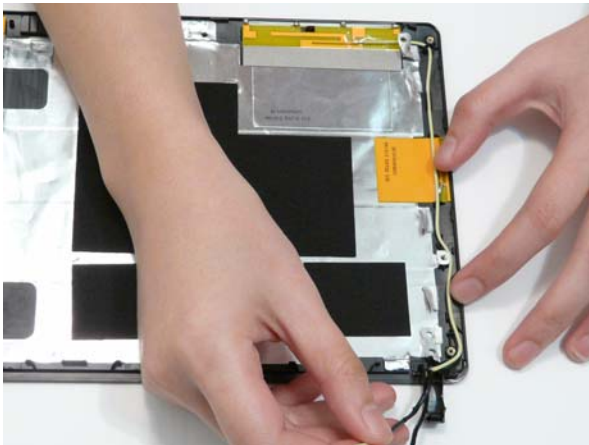

6. Replace the foil tabs over the cables.

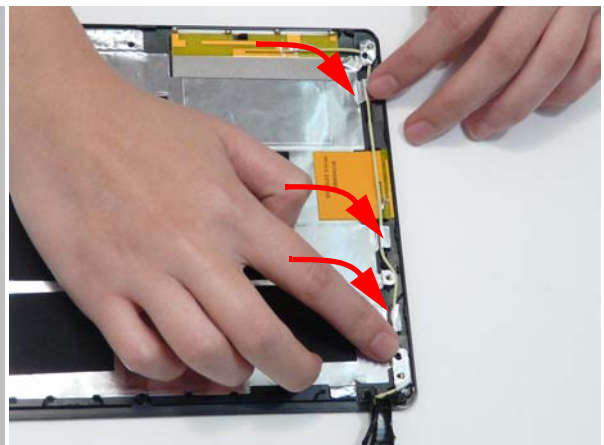
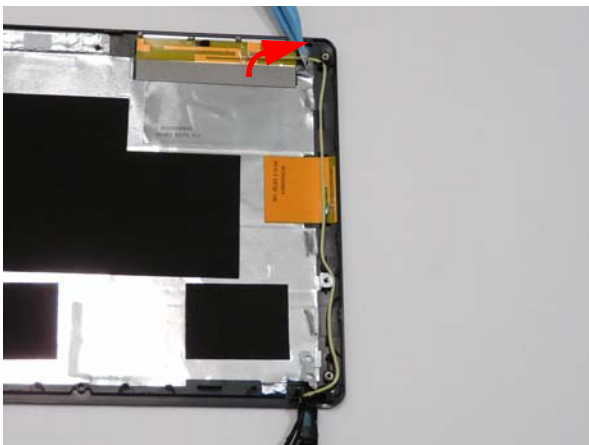

Replacing the Microphone

1. Adhere the microphone into the LCD module cover.

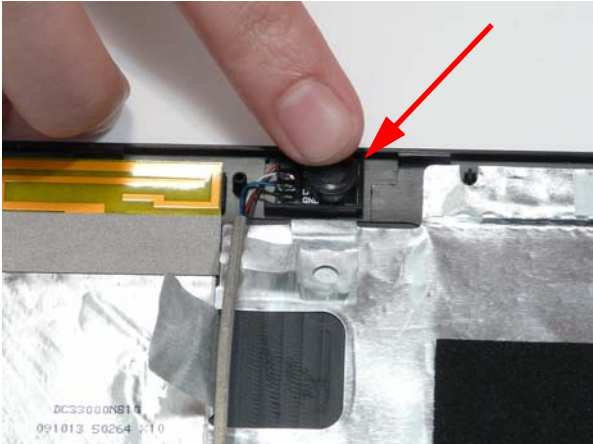

2. Replace the foil tab over the microphone.

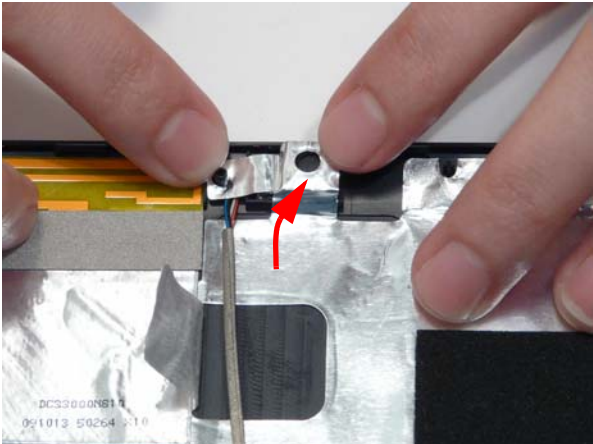

3. Lay the microphone cable onto the LCD module cover.

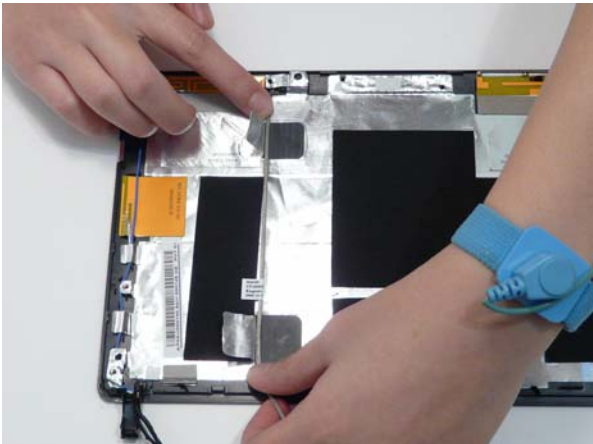

4. Replace the foil tabs.

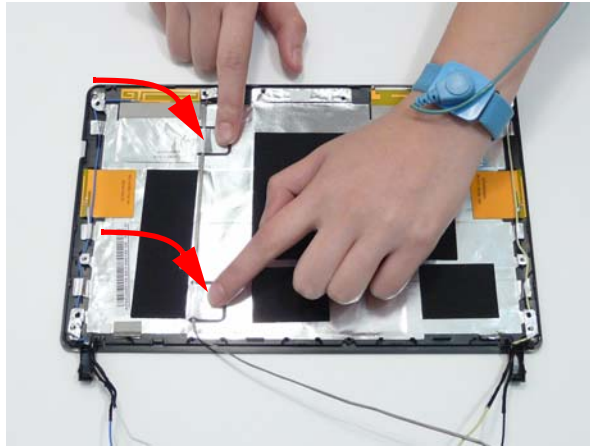

Replacing the LCD Cable

1. Replace the LCD cable connector.

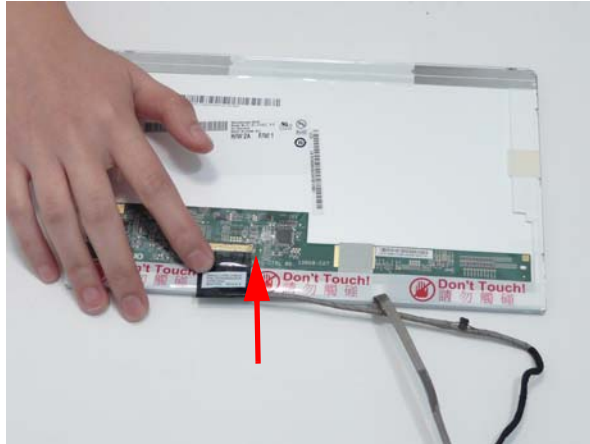

2. Adhere the transparent connector protector.



3. Adhere the LCD cable to LCD panel bottom side edge as shown.



NOTE: The circular portion of the cable runs along the panel side. The flat portion of the cable is adhered to the panel base.

4. Adhere the webcam LCD cable arm to the LCD panel.



NOTE: Pay attention to the proper location of the webcam cable arm.

Replacing the LCD Panel

1. Align the left and right LCD panel brackets with the panel.



2. Replace the four (4) screws.



Step	Size	Quantity	Screw Type
LCD Module Brackets	M2*3	1	

3. Replace the LCD panel into the LCD module cover bottom edge first.

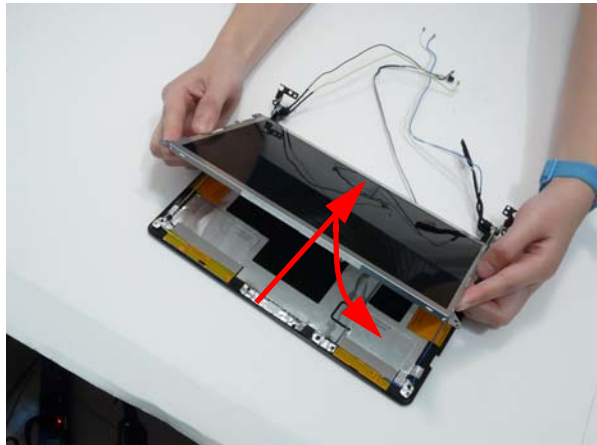

4. Replace the four (4) screws.



Step	Size	Quantity	Screw Type
LCD Module Brackets	M2*3	4	

5. Adhere the LCD cable along the panel edge.

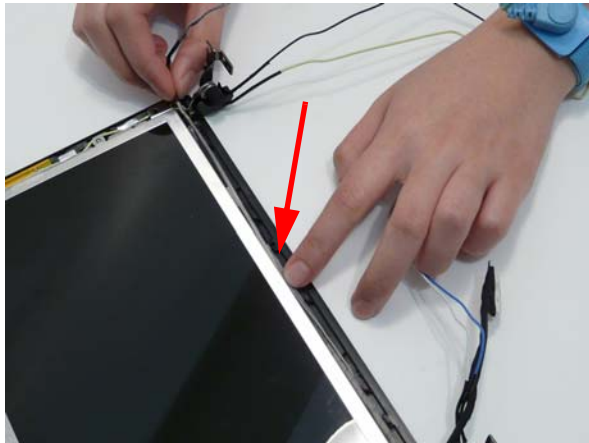

6. Lay the cables through the left and right hinges as shown.

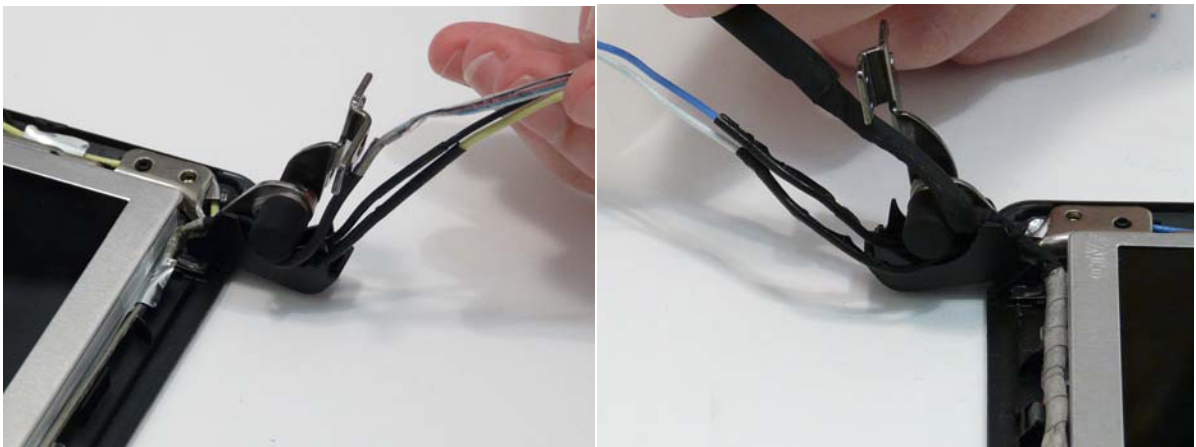

Replacing the Camera Module

1. Adhere the camera to the LCD module cover.

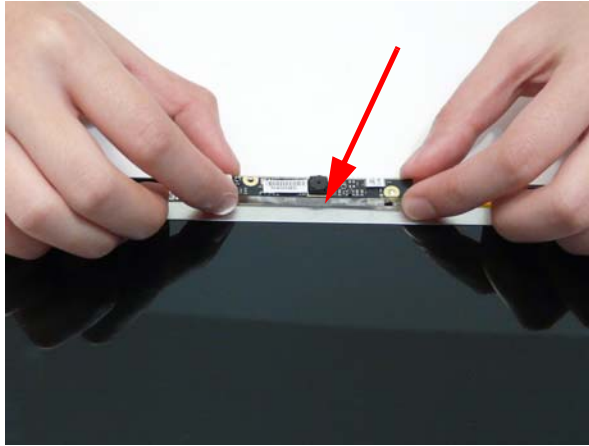

2. Connect the webcam cable.

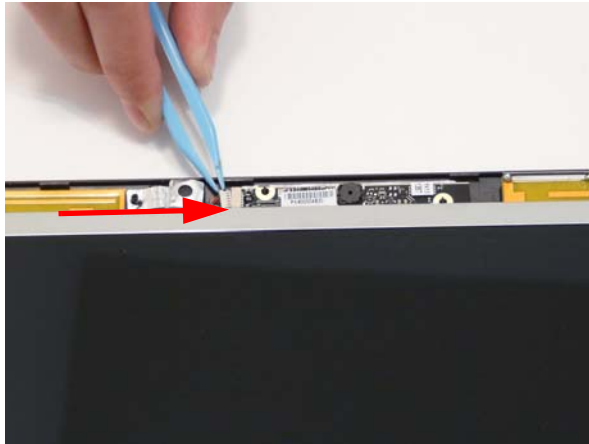

Replacing the LCD Bezel

1. Locate the bezel hinges first and press down until there are no gaps between the bezel and the LCD module cover hinge wells.

IMPORTANT: Ensure that the LCD cables pass through the hinge wells and are not trapped by the bezel.

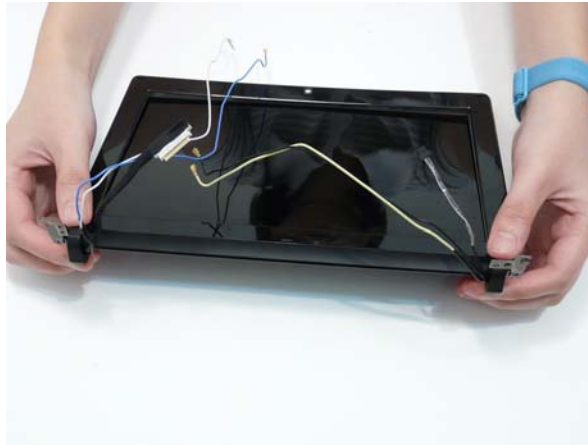

2. Press down around the entire perimeter of the bezel until there are no gaps between the bezel and the LCD Module.

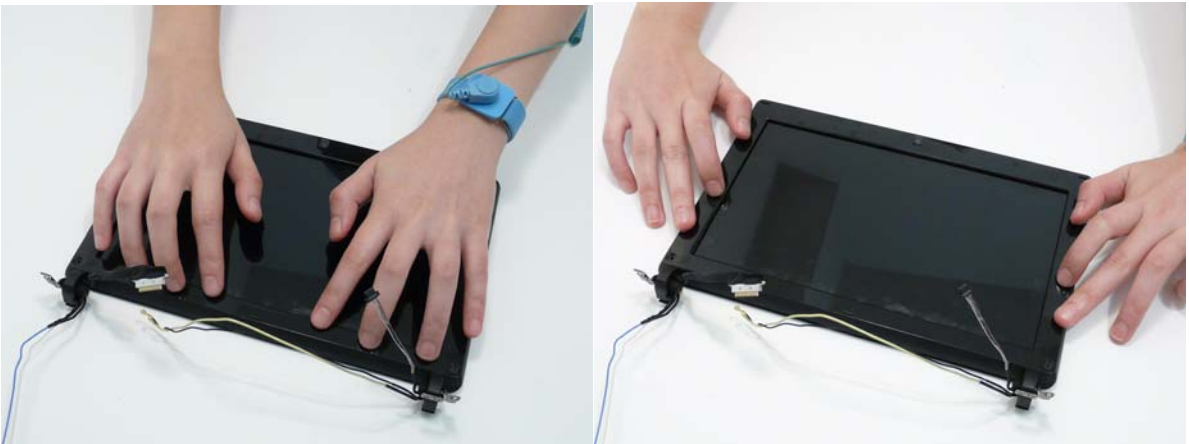

3. Replace the two (2) screws.



Step	Size	Quantity	Screw Type
LCD Bezel	M2*4 Ni	2	

4. Replace the two (2) screw covers.



Main Module Reassembly Procedure

Replacing the Speakers

1. Replace the two speaker housings into the bottom cover.

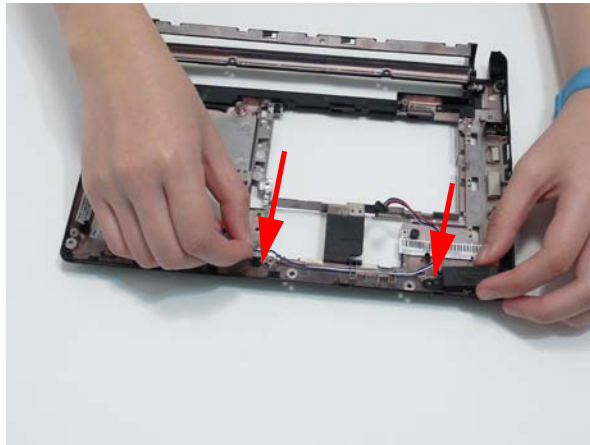

2. Lay the speaker cables into the retention guides.

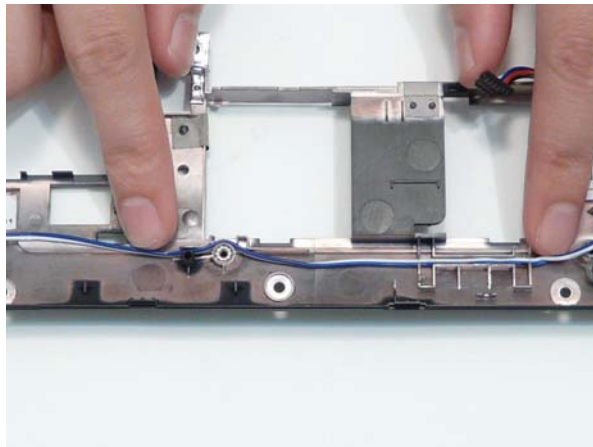

3. Replace the adhesive tape.

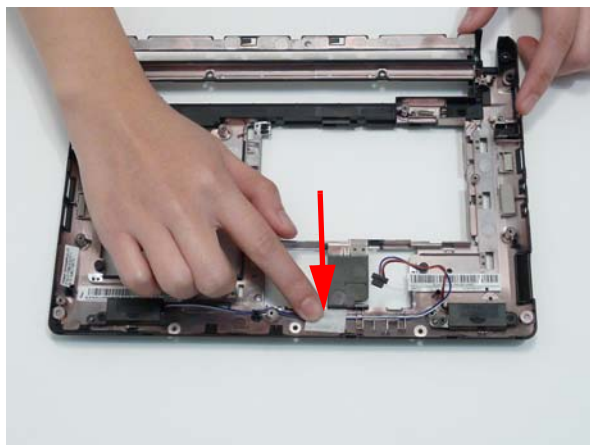

4. Replace the four (4) screws.

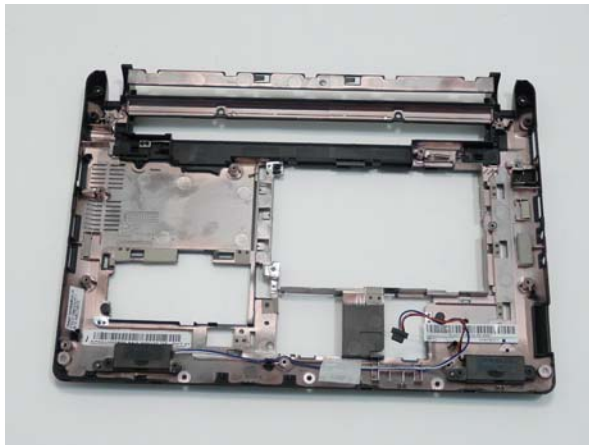

Step	Size	Quantity	Screw Type
Speakers	M2*3	4	

Replacing the LCD Module

1. Place the LCD module onto the main unit lower cover.

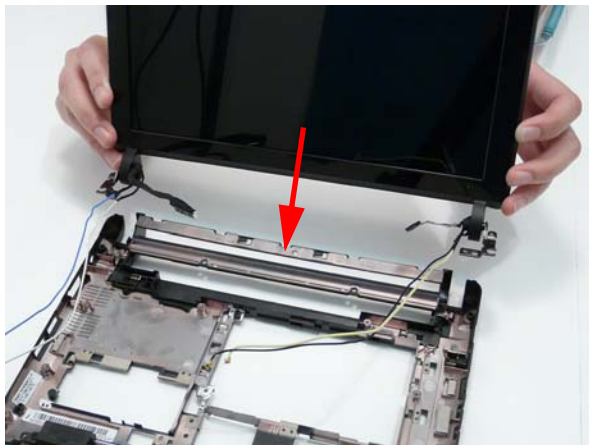

2. Replace the two (2) screws.



Step	Size	Quantity	Screw Type
LCD Hinges	M2*4	2	

3. Lay the right side cables into the retention guides.

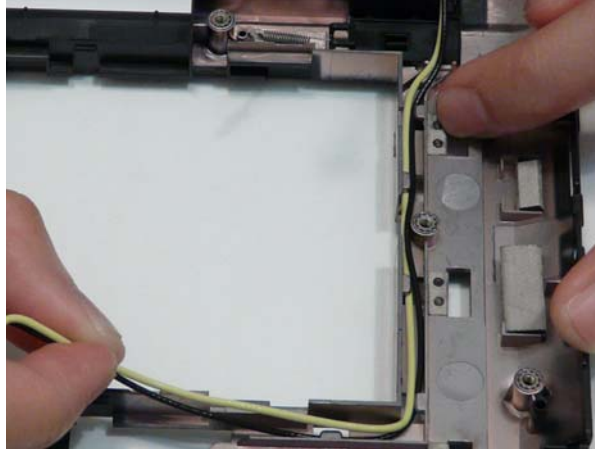

4. Lay the left side cables into the retention guides.



5. Replace the adhesive tape.

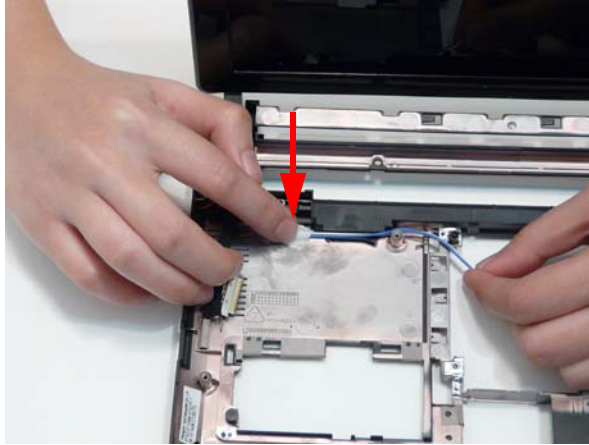

6. Push the left side cables through the slot in the lower cover.

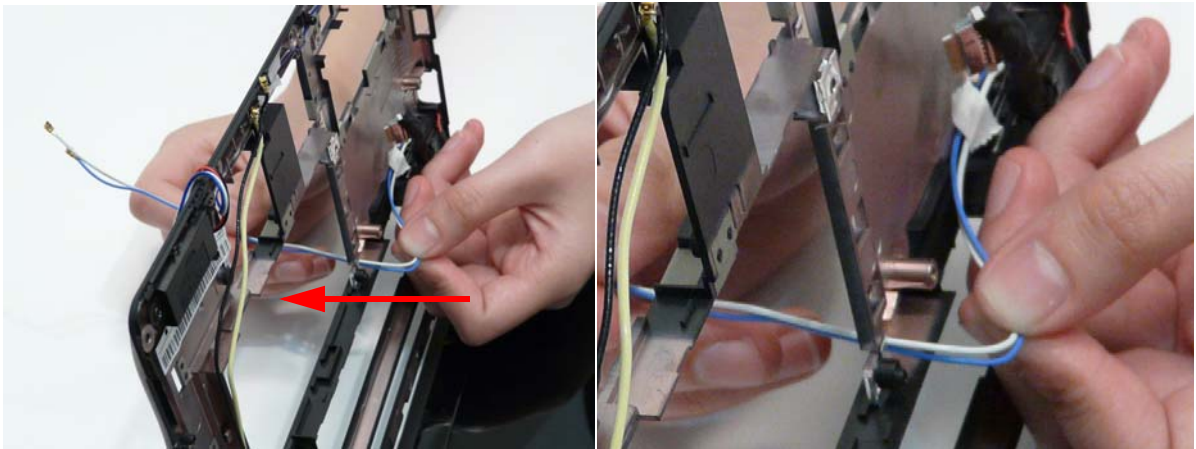

7. Replace the DC power jack.



Replacing the Thermal Module

IMPORTANT: Apply a suitable thermal grease and ensure all heat pads are in place before replacing the Thermal Module.

The following thermal grease types are approved for use:

- Silmore GP50
- Honeywell PCM45F-SP

- ShinEtsu 7762

The following thermal pads are approved for use:

1. Eapus XR-PERemove all traces of thermal grease from the CPU using a lint-free cloth or cotton swab and Isopropyl Alcohol, Acetone, or other approved cleaning agent.
2. Apply a small amount of thermal grease to the centre of the CPU—there is no need to spread the grease manually, the force used during the installation of the Thermal Module is sufficient.
3. Align the screw holes on the Thermal Module and Mainboard and lower the module into place. Keep the module as level as possible to spread the thermal grease evenly.



4. Tighten the three (3) captive screws in numerical order: 1, 2 then 3.

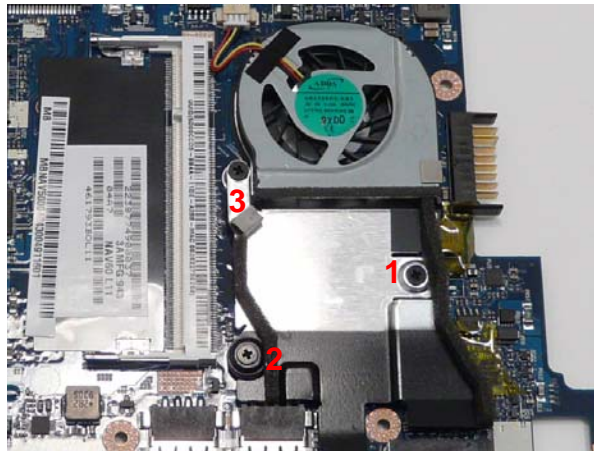

Step	Size	Quantity	Screw Type
Thermal Module	M2*3	4	

5. Connect the thermal module cable to the mainboard.

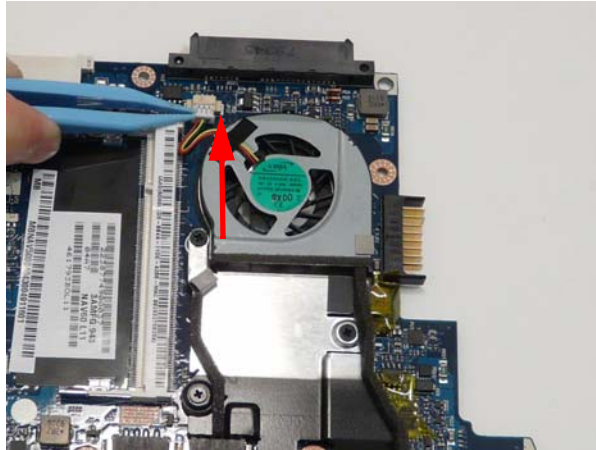

Replacing the Mainboard

1. Ensure that the Mainboard is face up (the CPU is not visible). Place the Mainboard in the chassis, left side first (1), then rotate it downward into position (2).

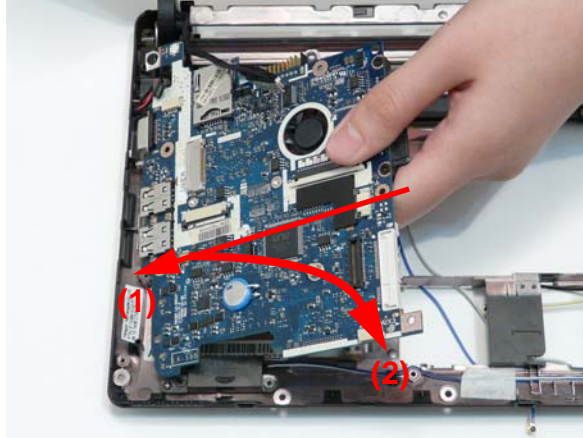

2. Replace the one (1) screw in the mainboard.



Step	Size	Quantity	Screw Type
Mainboard	M2*3	4	

3. Connect the DC power cable.

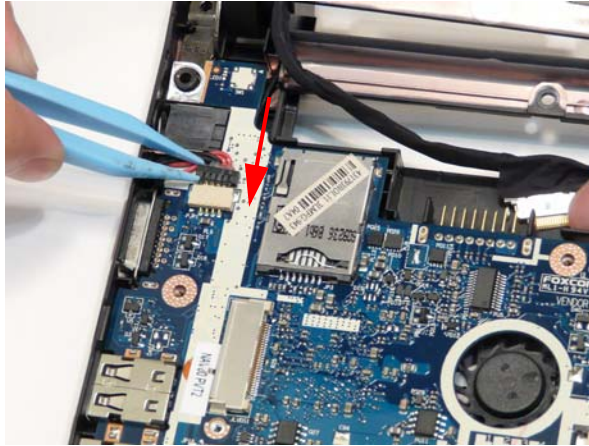

4. Connect the LCD cable.

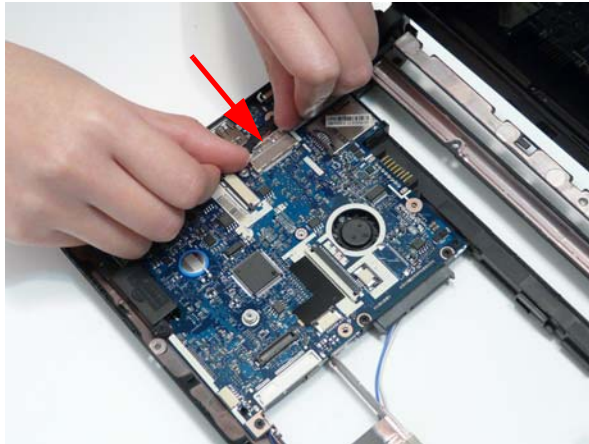

5. Replace the adhesive tape over the LCD cable.

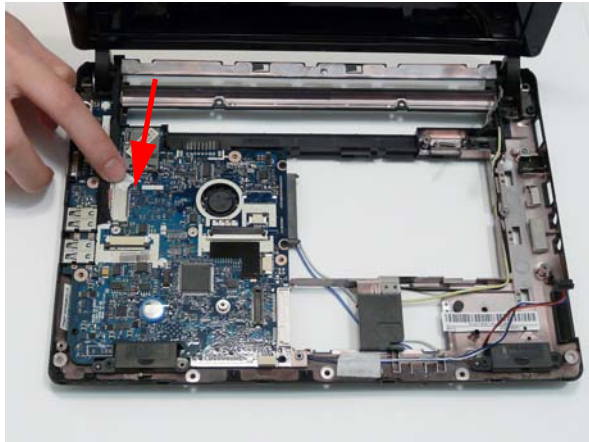

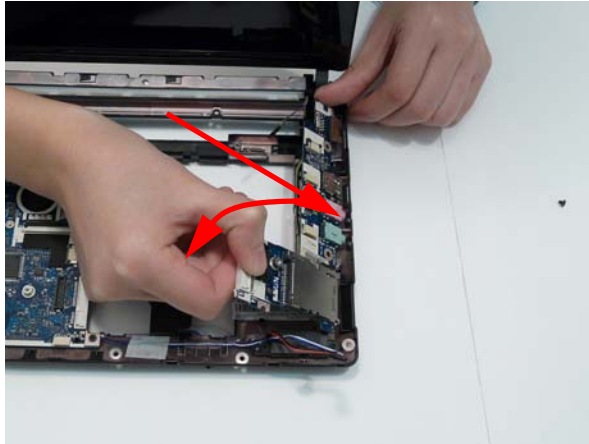

Replacing the I/O Board

1. Replace the I/O board, inserting the external connectors first 1, then lowering the board into place 2.

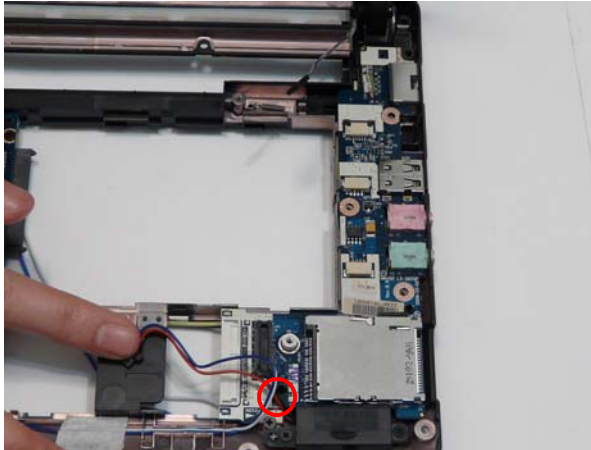

2. Replace the one (1) screw.



Step	Size	Quantity	Screw Type
I/O Board	M2*3	1	

3. Connect the speaker cable.

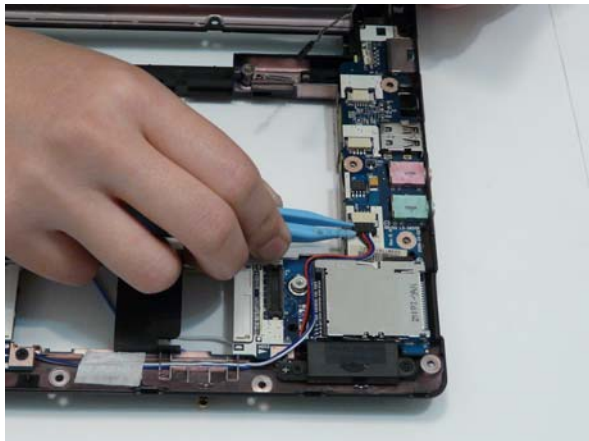

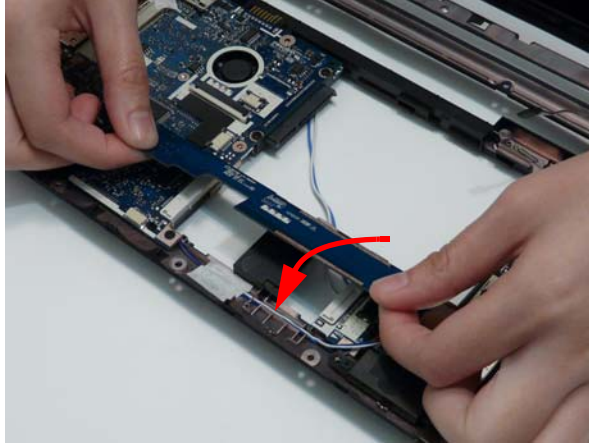

Replacing the Bridge Board

1. Replace the bridge board, firmly seating the pcb in the underside connectors.

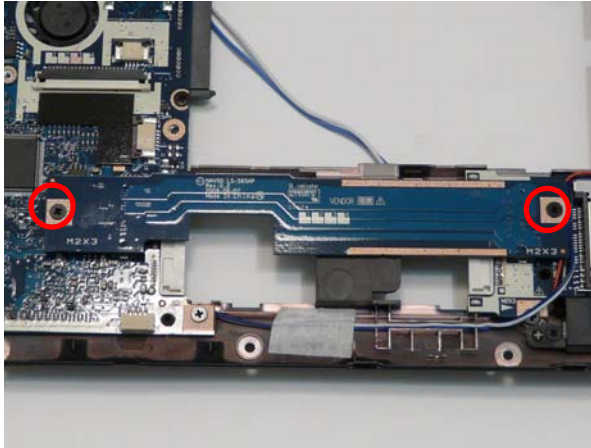

2. Replace the two (2) screws.



Step	Size	Quantity	Screw Type
Bridge Board	M2*3	2	

3. Replace the adhesive tape over the speaker cable.

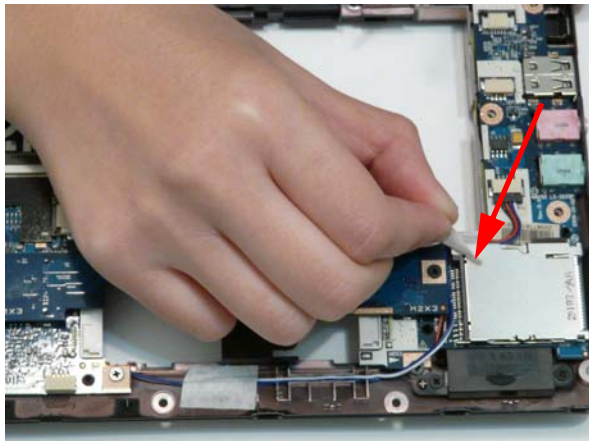

Replacing the Bluetooth Module

1. Connect the Bluetooth cable to the Bluetooth module

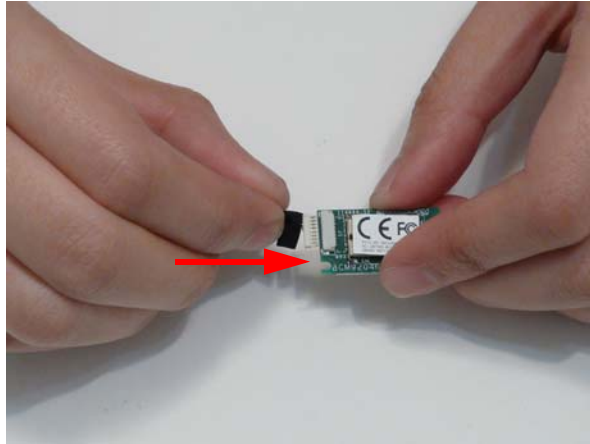

2. Replace the Bluetooth module.

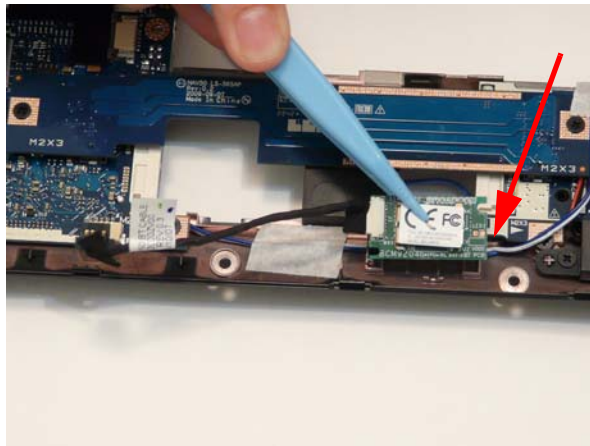

3. Connect the Bluetooth cable to the mainboard.

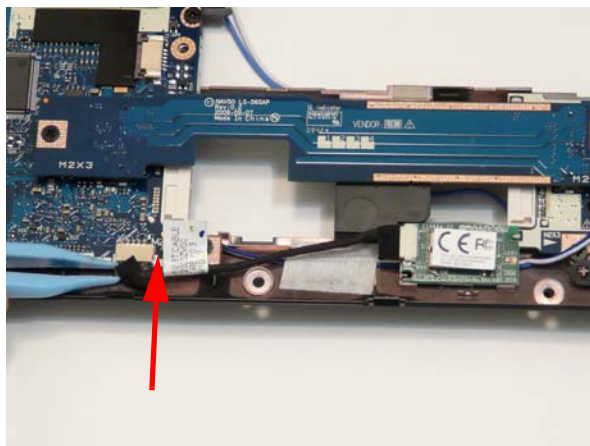

Replacing the Function Board

1. Replace the function board.

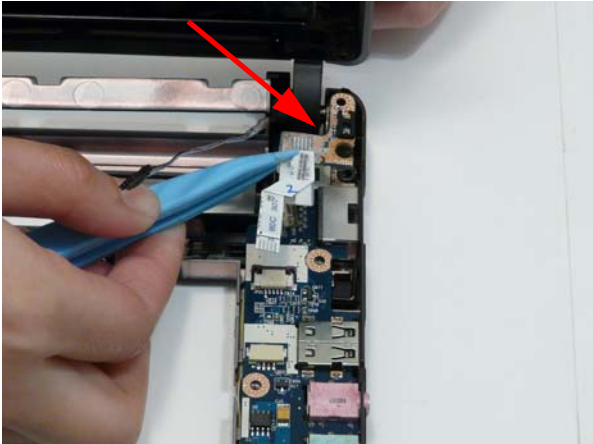

2. Connect the function board FFC to the I/O board.

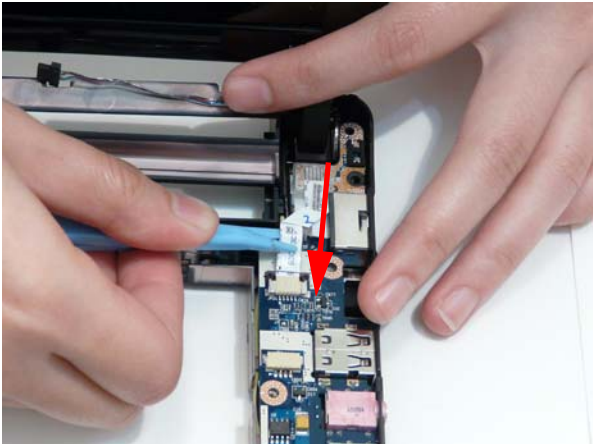

3. Lock the function board FFC.

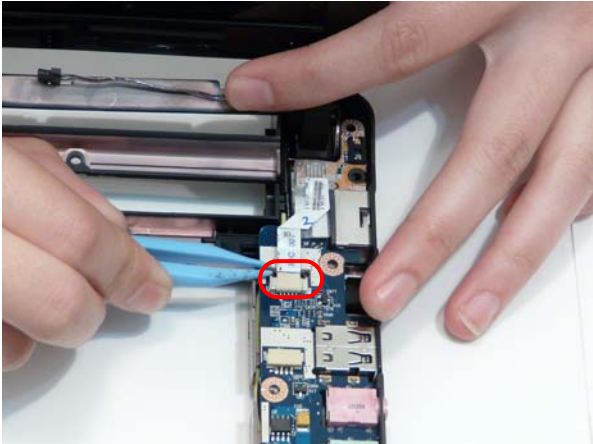

4. Connect the microphone cable to the I/O board.

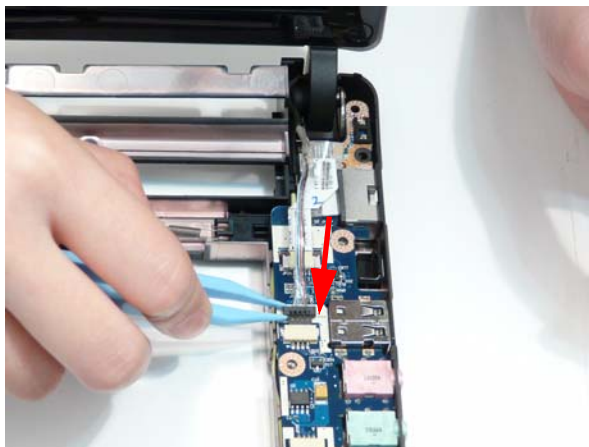

5. Replace the adhesive tape over the cables as shown.

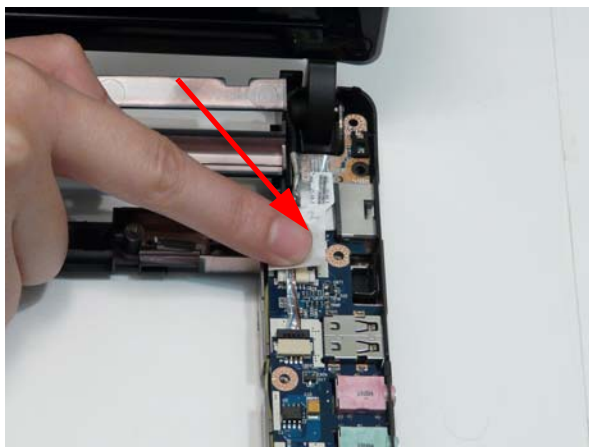

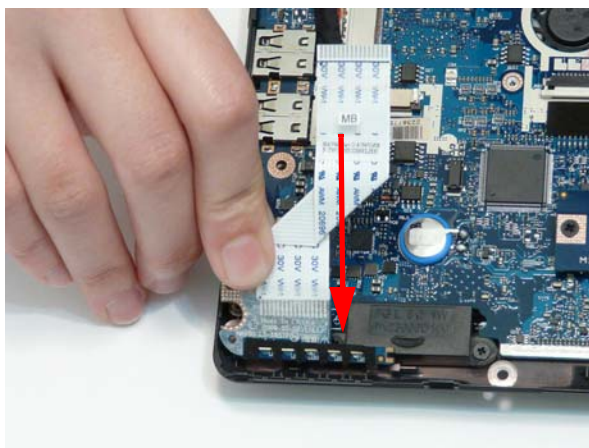

Replacing the LED Board

1. Replace the LED board.

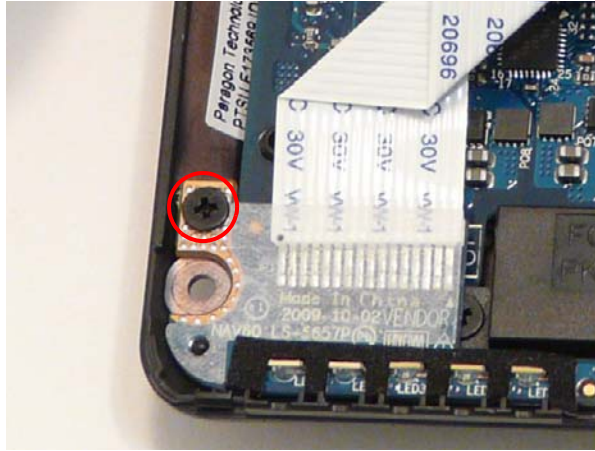

2. Replace the one (1) screw.



Step	Size	Quantity	Screw Type
LED Board	M2*3	1	

3. Connect the LED board FFC.

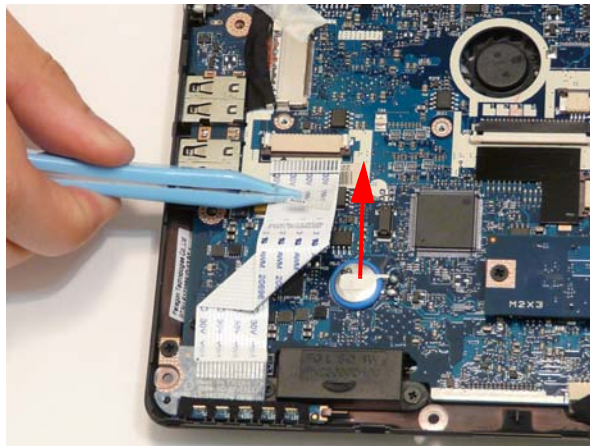

4. Lock the LED board FFC.

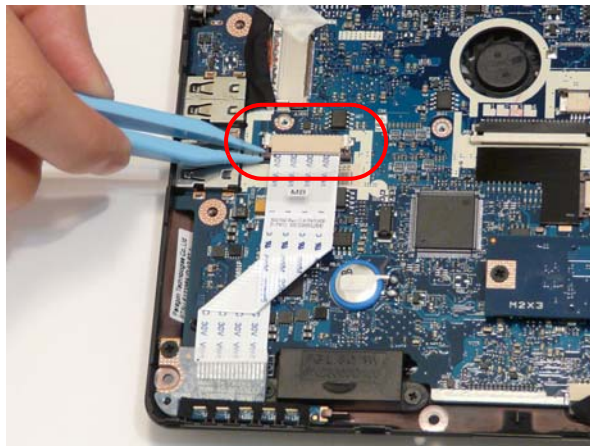

Replacing the Power Board

1. Replace the power board.

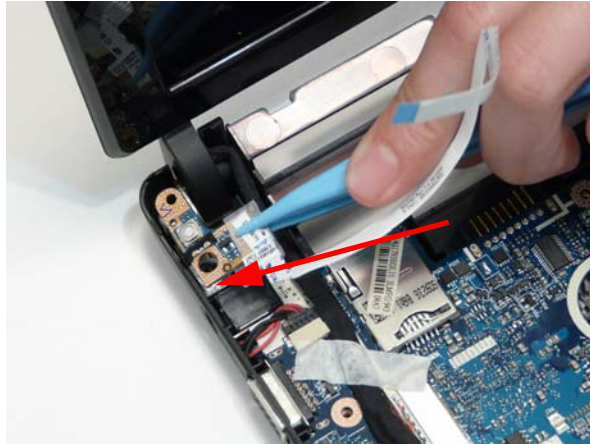

2. Press down firmly to adhere in location.

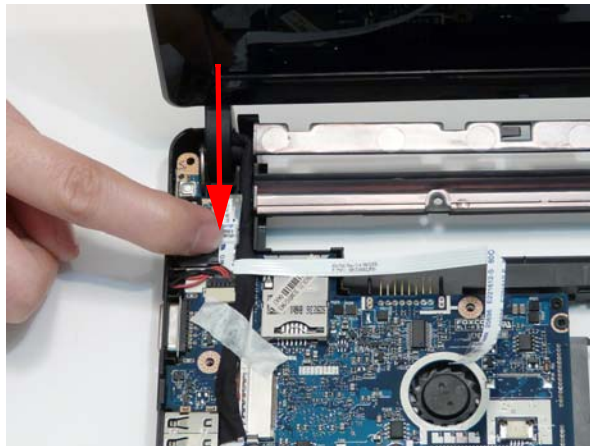

Replacing the Button Board

1. Replace the button board.

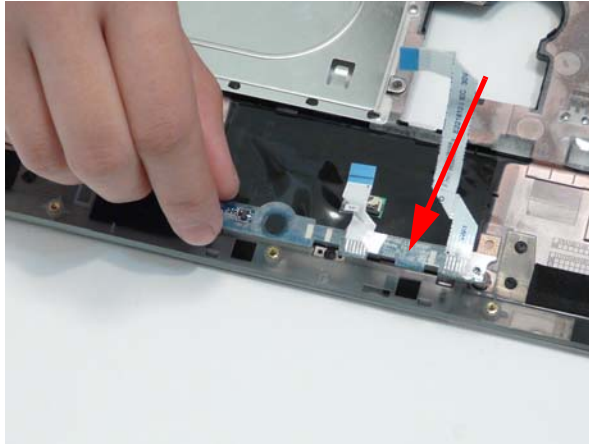

2. Replace the two (2) screws.



3. Adhere the button board FFC to the upper cover.

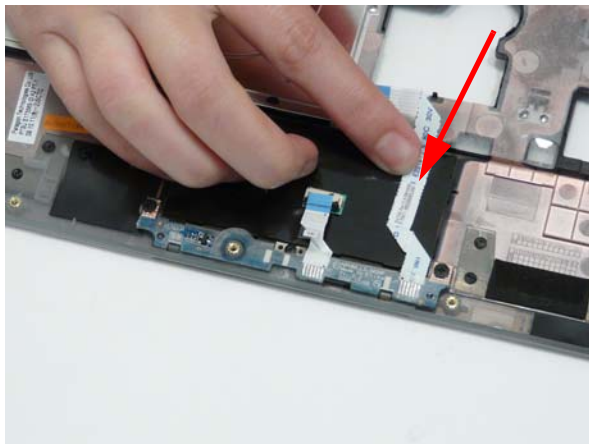

4. Connect the touchpad FFC.

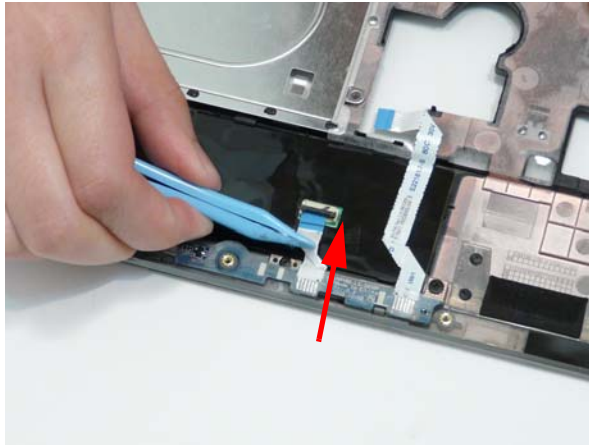

5. Lock the touchpad FFC.

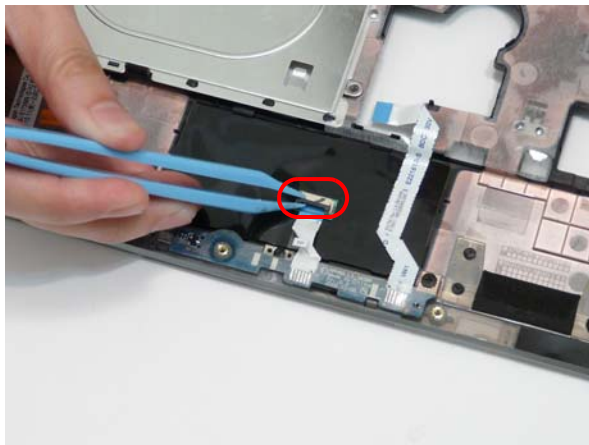

6. Replace the adhesive tape.

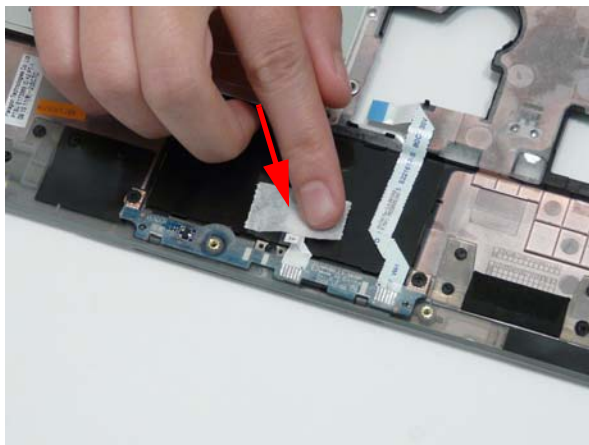

Replacing the Upper Cover

1. Pull the power board FFC through the upper cover.



2. Replace the upper cover ensuring the hinge covers are seated properly.



3. Press down on the top left and right upper cover edges.



4. Press down around the upper cover edges.



5. Press down firmly on the upper cover on the locations shown to ensure the underside latches engage properly.

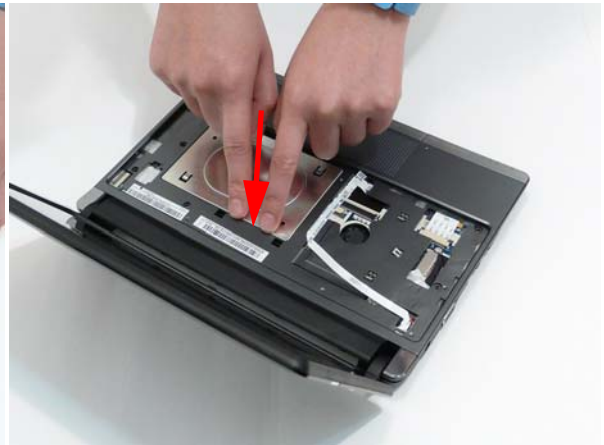
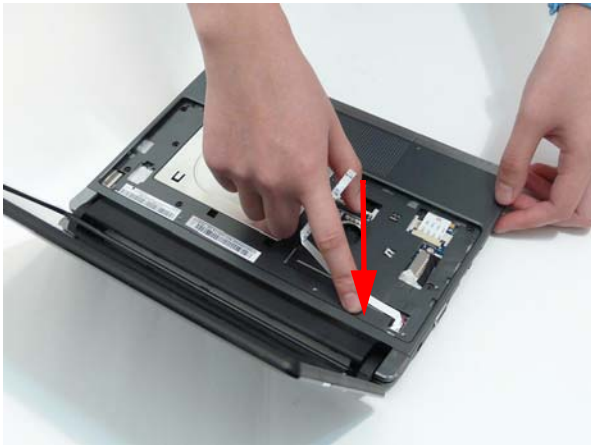

6. Squeeze the bottom edge closed as shown.



7. Turn the computer over and press down on the upper cover top edge.

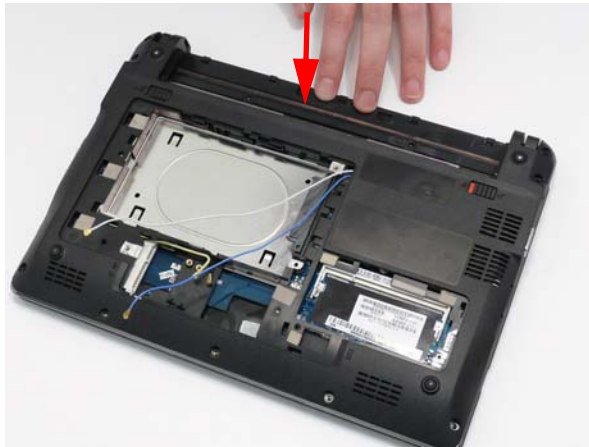

8. Replace the eleven (11) screws in the lower cover.

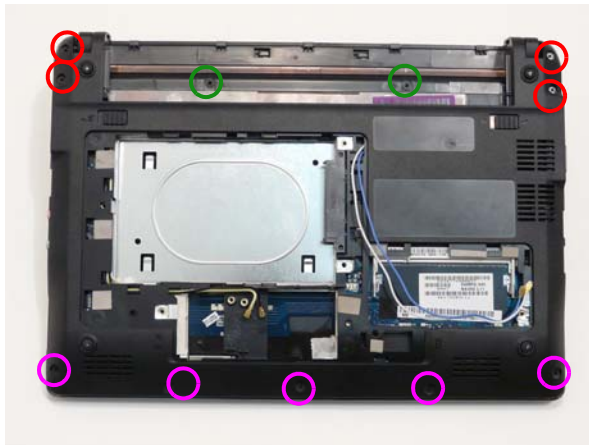

Step	Size	Quantity	Screw Type
Lower Cover	M2*8 (red call out)	4	
	M2x3 (green call out)	2	
	M2x4 (purple call out)	5	

9. Pull the cable through completely.



10. Lay the cable through the retention guides.

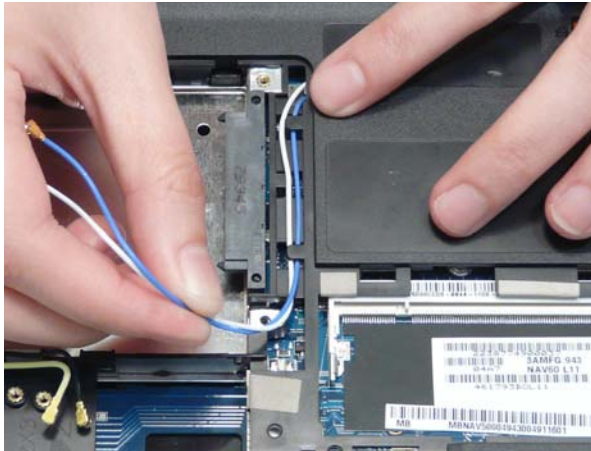

11. Replace the seven (7) screws in the upper cover.

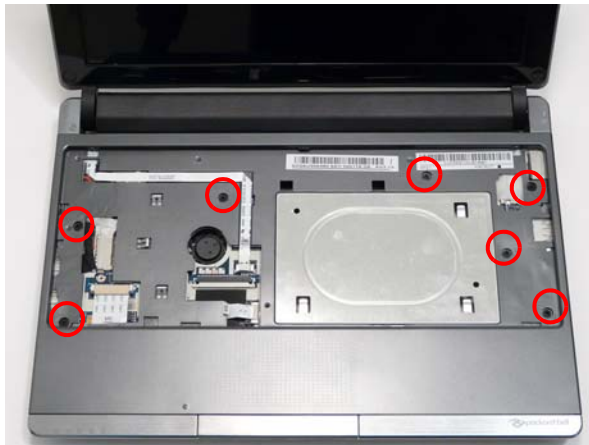

Step	Size	Quantity	Screw Type
Upper Cover	M2*8	7	

12. Connect the button board FCC i) and lock it ii).

i)

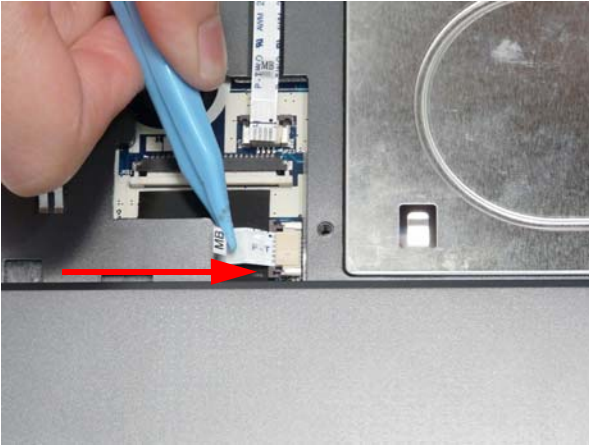

ii)

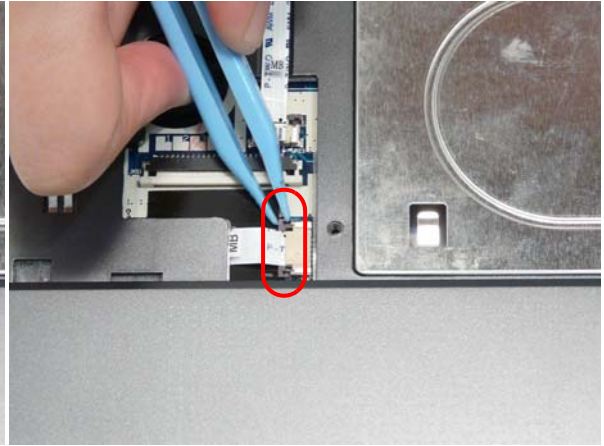

13. Connect the power FFC i) and lock it ii).

i)



ii)



Replacing the Keyboard

1. Connect the keyboard FPC i) and lock it ii).

i)

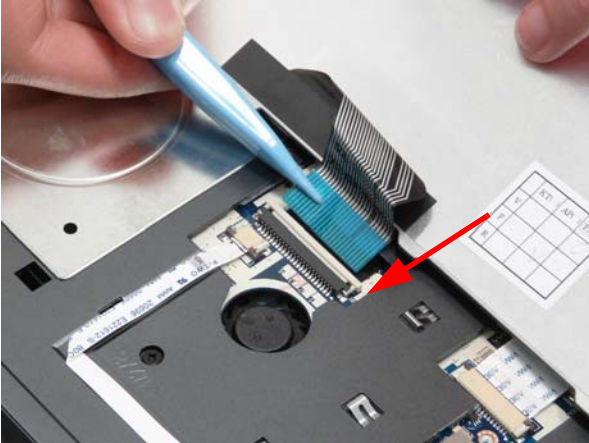

ii)

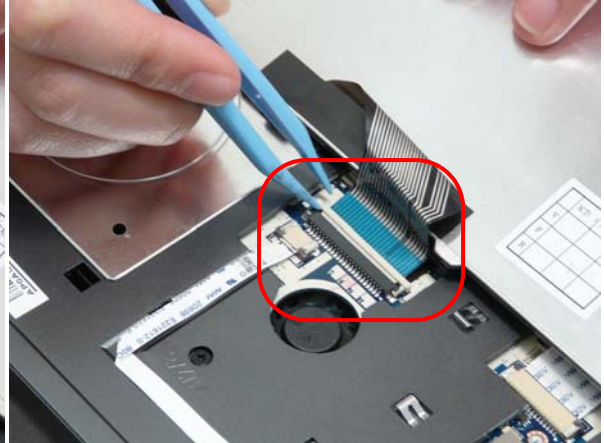

2. Turn the keyboard over.



3. Press down on the keyboard to engage the top center latch.



Replacing the 3G Module

1. Replace the 3G module.



2. Replace the on (1) screw.



Step	Size	Quantity	Screw Type
3G Module	M2*3	1	

3. Replace the two (2) connectors. Yellow cable on the HDD bay side connector, Blue on the right side connector.



Replacing the WLAN Module

1. Replace the WLAN module.

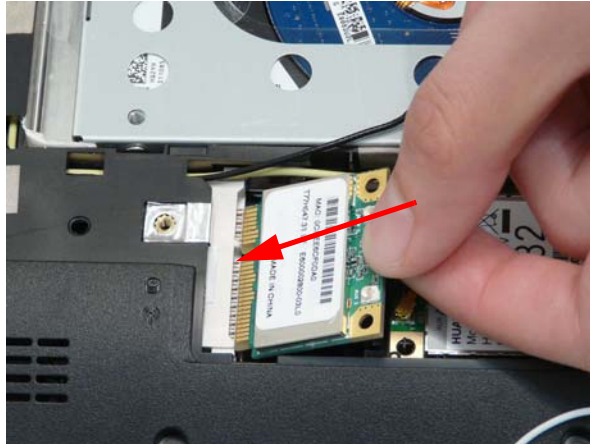

2. Replace the one (1) screw.



Step	Size	Quantity	Screw Type
WLAN Module	M2*3	1	

3. Replace the two connectors. The Black cable on the HDD bay side connector, the White cable on the right side edge connector.

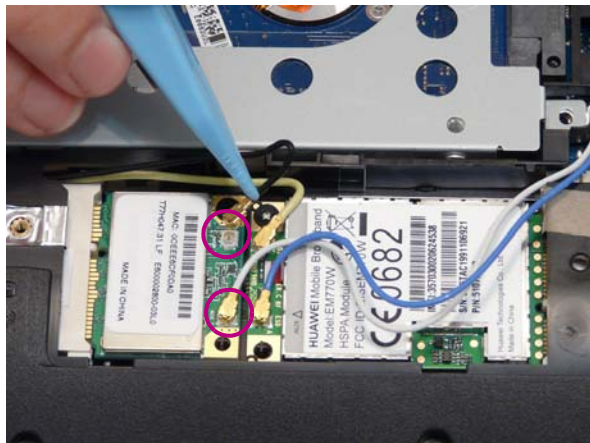

Replacing the Hard Disk Drive

1. Replace the HDD into the carrier.

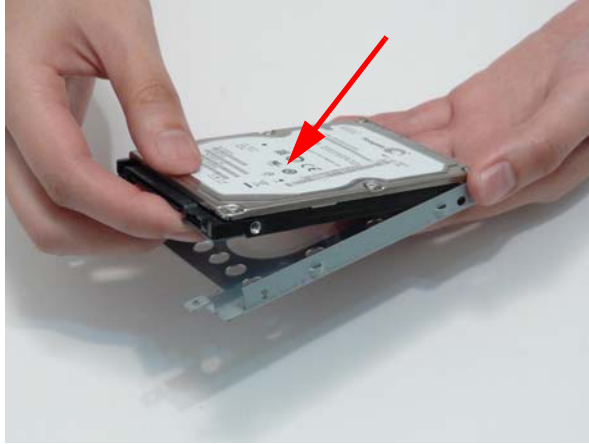

2. Replace the four (4) screws, two (2) on each side.

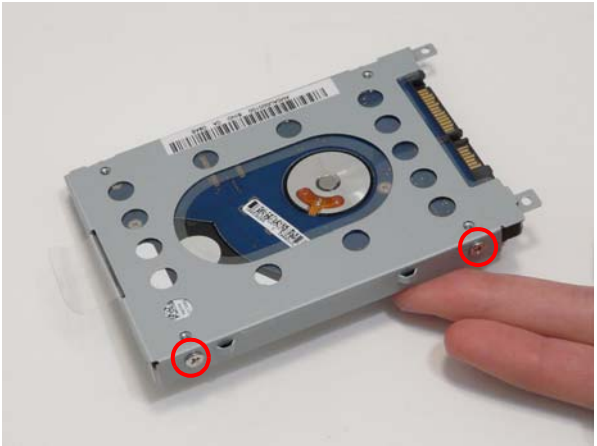
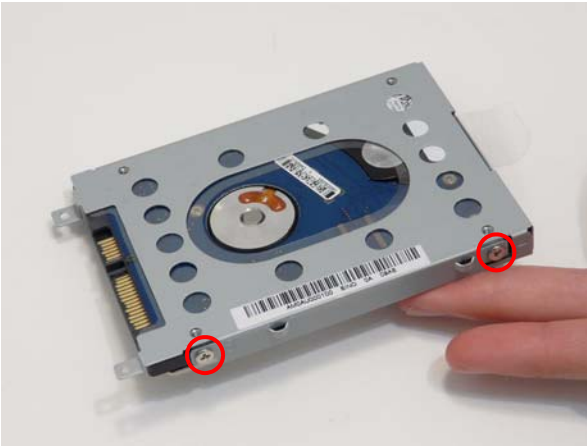

Step	Size	Quantity	Screw Type
HDD Module	M3*3	4	

3. Replace the HDD module into the HDD bay.



4. Slide the HDD module forward to engage the connectors.

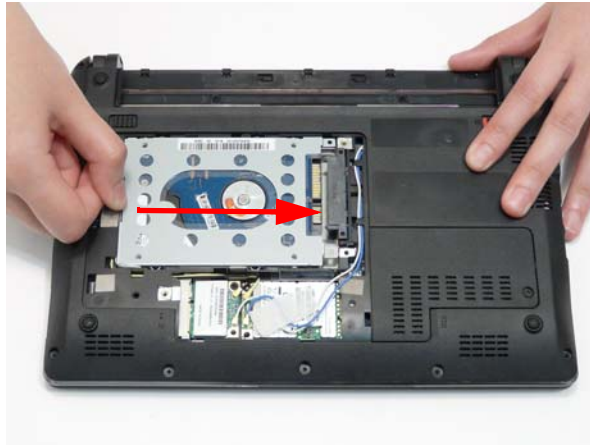

5. Ensure the pull tab is tucked down neatly.



Replacing the DIMM Module

1. Replace the DIMM module.



2. Press the DIMM module to lock into place.



Replacing the Lower Covers

1. Replace the HDD cover by first locating the external edge flanges (1) and then lowering into place (2).

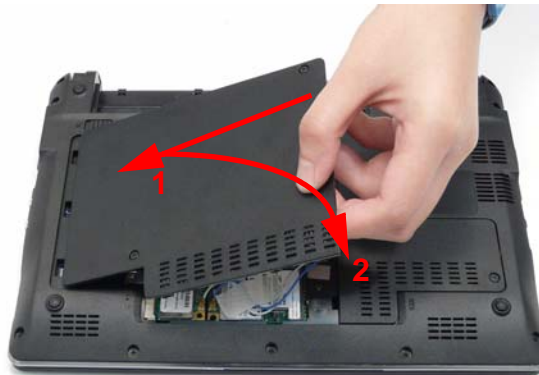

-
2. Replace the DIMM module cover by first inserting the internal edge (1) and then lowering into place (2) as shown.



3. Tighten the three (3) captive screws of the HDD cover and the one (1) captive screw of the DIMM cover.

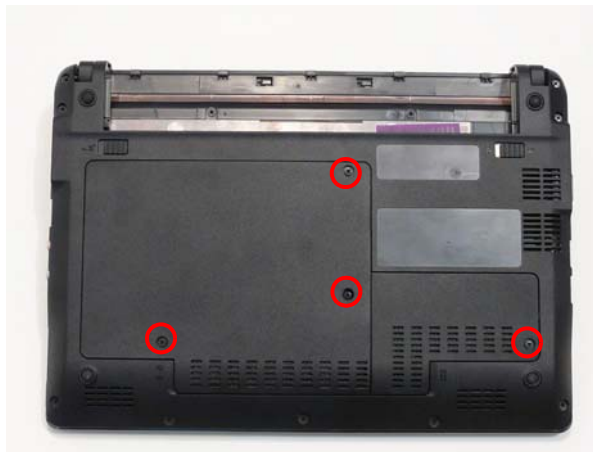

Replacing the Battery

1. Slide and hold the battery release latch to the release position (1), insert the battery pack and press down (2).
2. Slide the battery lock in the direction shown to secure the battery in place.



Replacing the SD Dummy Card

- 1. Insert the SD Dummy Card into the slot and push until the card clicks into place and is flush with the casing.



Troubleshooting

Common Problems

Use the following procedure as a guide for computer problems.

NOTE: The diagnostic tests are intended to test only Acer products. Non-Acer products, prototype cards, or modified options can give false errors and invalid system responses.

1. Obtain the failing symptoms in as much detail as possible.
2. Verify the symptoms by attempting to re-create the failure by running the diagnostic test or by repeating the same operation.
3. Use the following table with the verified symptom to determine which page to go to.

Symptoms (Verified)	Go To
Power On Issue	Page 130
No Display Issue	Page 131
LCD Failure	Page 133
Internal Keyboard Failure	Page 133
TouchPad Failure	Page 134
Internal Speaker Failure	Page 134
Internal Microphone Failure	Page 136
WLAN Failure	Page 138
Thermal Unit Failure	Page 139
Other Functions Failure	Page 140
Intermittent Failures	Page 141
Undermined Failures	Page 141

4. If the Issue is still not resolved, see "Online Support Information" on page 167.

Power On Issue

If the system doesn't power on, perform the following actions one at a time to correct the problem. Do not replace a non-defective FRUs:

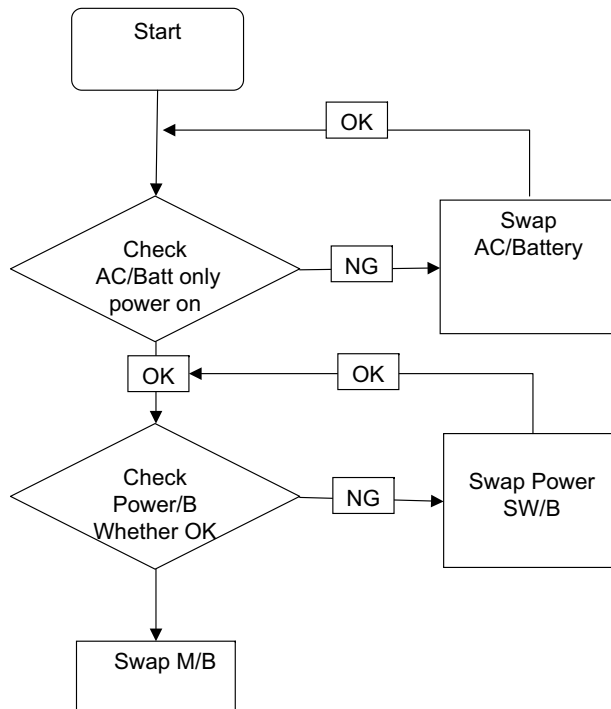

Computer Shutdown Intermittently

If the system powers off at intervals, perform the following actions one at a time to correct the problem.

1. Check the power cable is properly connected to the computer and the electrical outlet.
2. Remove any extension cables between the computer and the outlet.
3. Remove any surge protectors between the computer and the electrical outlet. Plug the computer directly into a known good electrical outlet.
4. Disconnect the power and open the casing to check the Thermal Unit (see "Thermal Unit Failure" on page 139) and fan airways are free of obstructions.
5. Remove all external and non-essential hardware connected to the computer that are not necessary to boot the computer to the failure point.
6. Remove any recently installed software.
7. If the Issue is still not resolved, see "Online Support Information" on page 167.

No Display Issue

If the **Display** doesn't work, perform the following actions one at a time to correct the problem. Do not replace a non-defective FRUs:

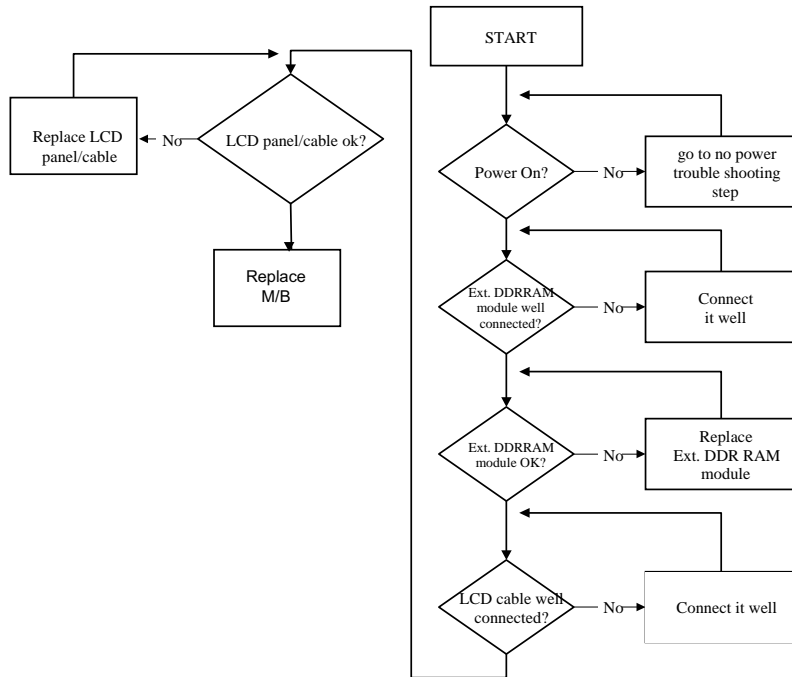

No POST or Video

If the POST or video doesn't display, perform the following actions one at a time to correct the problem.

1. Make sure that the internal display is selected. On this notebook model, switching between the internal display and the external display is done by pressing **Fn+F5**. Reference Product pages for specific model procedures.
2. Make sure the computer has power by checking at least one of the following occurs:
 - Fans start up
 - Status LEDs light up

If there is no power, see "Power On Issue" on page 130.

3. Drain any stored power by removing the power cable and battery and holding down the power button for 10 seconds. Reconnect the power and reboot the computer.
4. Connect an external monitor to the computer and switch between the internal display and the external display is by pressing **Fn+F5** (on this model).

If the POST or video appears on the external display, see "LCD Failure" on page 133.

5. Disconnect power and all external devices including port replicators or docking stations. Remove any memory cards and CD/DVD discs. Restart the computer.

If the computer boots correctly, add the devices one by one until the failure point is discovered.

6. Reseat the memory modules.
7. Remove the drives (see "Disassembly Process" on page 38).
8. If the Issue is still not resolved, see "Online Support Information" on page 167.

Abnormal Video Display

If video displays abnormally, perform the following actions one at a time to correct the problem.

1. Reboot the computer.
2. If permanent vertical/horizontal lines or dark spots display in the same location, the LCD is faulty and should be replaced. See “Disassembly Process” on page 38.
3. If extensive pixel damage is present (different colored spots in the same locations on the screen), the LCD is faulty and should be replaced. See “Disassembly Process” on page 38.
4. Adjust the brightness to its highest level. See the User Manual for instructions on adjusting settings.
NOTE: Ensure that the computer is not running on battery alone as this may reduce display brightness.
If the display is too dim at the highest brightness setting, the LCD is faulty and should be replaced. See “Disassembly Process” on page 38.
5. Check the display resolution is correctly configured:
 - a. Minimize or close all Windows.
 - b. If display size is only abnormal in an application, check the view settings and control/mouse wheel zoom feature in the application.
 - c. If desktop display resolution is not normal, right-click on the desktop and select **Personalize**→ **Display Settings**.
 - d. Click and drag the Resolution slider to the desired resolution.
 - e. Click **Apply** and check the display. Readjust if necessary.
6. Roll back the video driver to the previous version if updated.
7. Remove and reinstall the video driver.
8. Check the Device Manager to determine that:
 - The device is properly installed. There are no red Xs or yellow exclamation marks.
 - There are no device conflicts.
 - No hardware is listed under Other Devices.
9. If the Issue is still not resolved, see “Online Support Information” on page 167.
10. Run the Windows Memory Diagnostic from the operating system DVD and follow the onscreen prompts.
11. If the Issue is still not resolved, see “Online Support Information” on page 167.

Random Loss of BIOS Settings

If the computer is experiencing intermittent loss of BIOS information, perform the following actions one at a time to correct the problem.

1. If the computer is more than one year old, replace the CMOS battery.
2. Run a complete virus scan using up-to-date software to ensure the computer is virus free.
3. If the computer is experiencing HDD or ODD BIOS information loss, disconnect and reconnect the power and data cables between devices.
If the BIOS settings are still lost, replace the cables.
4. If HDD information is missing from the BIOS, the drive may be defective and should be replaced.
5. Replace the Motherboard.
6. If the Issue is still not resolved, see “Online Support Information” on page 167.

LCD Failure

If the **LCD** fails, perform the following actions one at a time to correct the problem. Do not replace a non-defective FRUs:

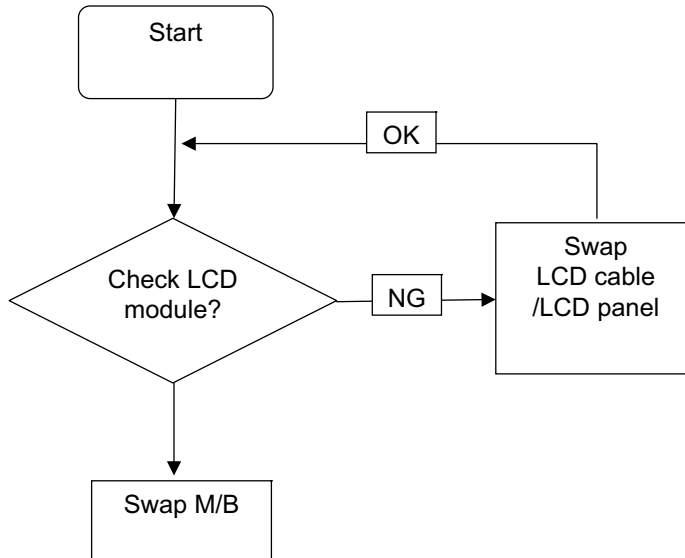

Built-In Keyboard Failure

If the built-in **Keyboard** fails, perform the following actions one at a time to correct the problem. Do not replace a non-defective FRUs:

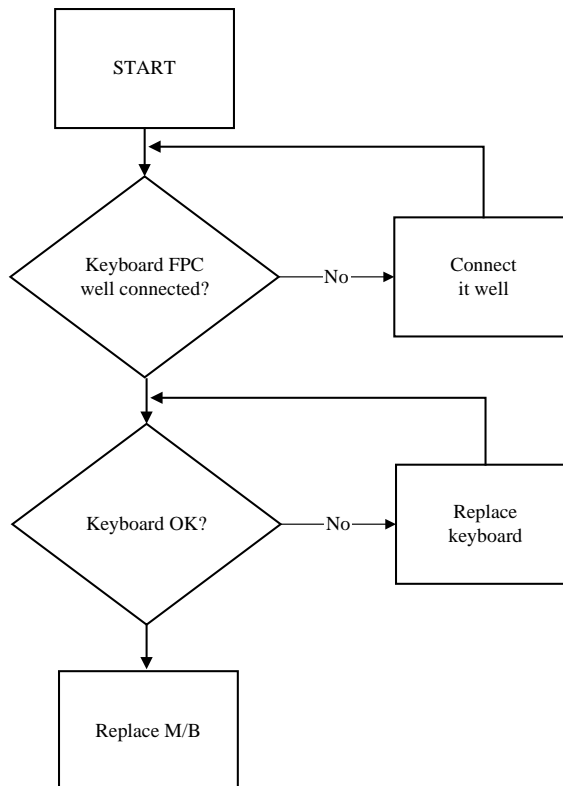

TouchPad Failure

If the **TouchPad** doesn't work, perform the following actions one at a time to correct the problem. Do not replace a non-defective FRUs:

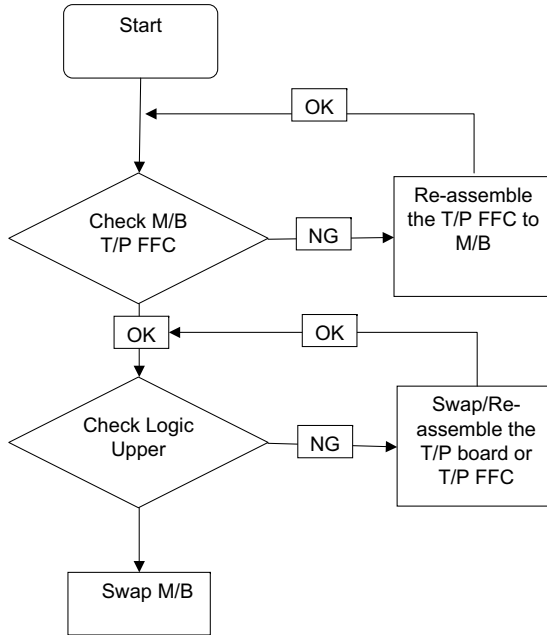

Internal Speaker Failure

If the internal **Speakers** fail, perform the following actions one at a time to correct the problem. Do not replace a non-defective FRUs:

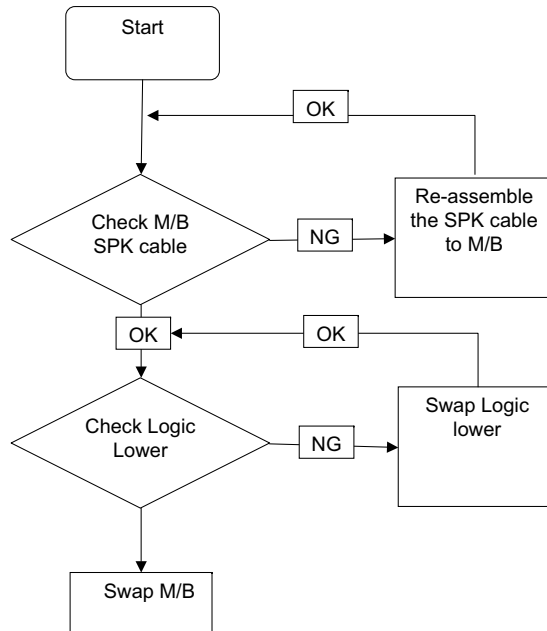

Sound Problems

If sound problems are experienced, perform the following actions one at a time to correct the problem.

-
1. Reboot the computer.
 2. Navigate to **Start**→ **Control Panel**→ **System and Maintenance**→ **System**→ **Device Manager**. Check the Device Manager to determine that:
 - The device is properly installed.
 - There are no red Xs or yellow exclamation marks.
 - There are no device conflicts.
 - No hardware is listed under Other Devices.
 3. Roll back the audio driver to the previous version, if updated recently.
 4. Remove and reinstall the audio driver.
 5. Ensure that all volume controls are set mid range:
 - a. Click the volume icon on the taskbar and drag the slider to 50. Ensure that the volume is not muted.
 - b. Click Mixer to verify that other audio applications are set to 50 and not muted.
 6. Navigate to **Start**→ **Control Panel**→ **Hardware and Sound**→ **Sound**. Ensure that Speakers are selected as the default audio device (green check mark).

NOTE: If Speakers does not show, right-click on the **Playback** tab and select **Show Disabled Devices** (clear by default).
 7. Select Speakers and click **Configure** to start **Speaker Setup**. Follow the onscreen prompts to configure the speakers.
 8. Remove and recently installed hardware or software.
 9. Restore system and file settings from a known good date using **System Restore**.

If the issue is not fixed, repeat the preceding steps and select an earlier time and date.
 10. Reinstall the Operating System.
 11. If the Issue is still not resolved, see "Online Support Information" on page 167.

Internal Microphone Failure

If the internal **Microphone** fails, perform the following actions one at a time to correct the problem. Do not replace a non-defective FRUs:

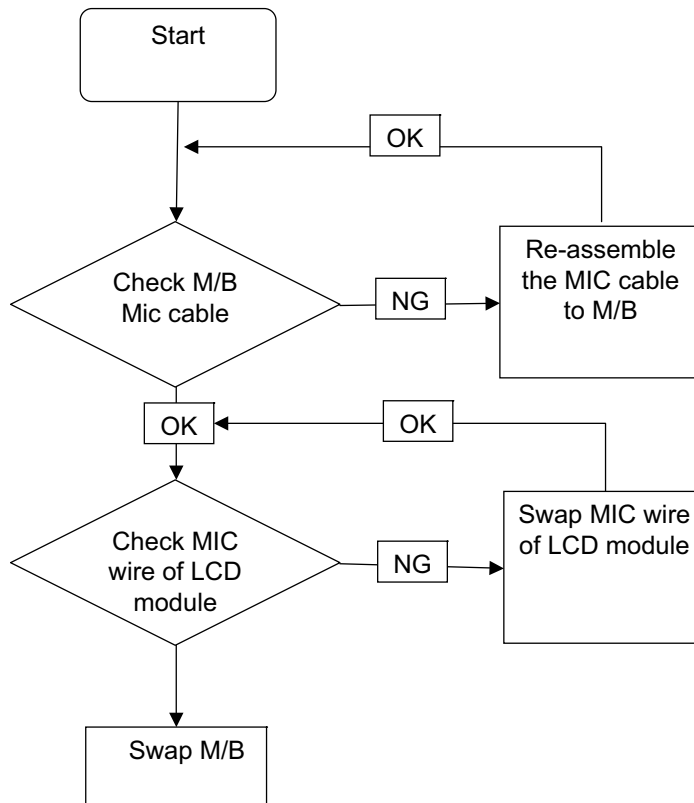

Microphone Problems

If internal or external **Microphones** do not operate correctly, perform the following actions one at a time to correct the problem.

1. Check that the microphone is enabled. Navigate to **Start** → **Control Panel** → **Hardware and Sound** → **Sound** and select the **Recording** tab.
2. Right-click on the **Recording** tab and select **Show Disabled Devices** (clear by default).
3. The microphone appears on the **Recording** tab.
4. Right-click on the microphone and select **Enable**.
5. Select the microphone then click **Properties**. Select the **Levels** tab.
6. Increase the volume to the maximum setting and click **OK**.
7. Test the microphone hardware:
 - a. Select the microphone and click **Configure**.
 - b. Select **Set up microphone**.
 - c. Select the microphone type from the list and click **Next**.
 - d. Follow the onscreen prompts to complete the test.
8. If the Issue is still not resolved, see “Online Support Information” on page 167.

HDD Not Operating Correctly

If the **HDD** does not operate correctly, perform the following actions one at a time to correct the problem.

1. Disconnect all external devices.
2. Run a complete virus scan using up-to-date software to ensure the computer is virus free.
3. Run the Windows 7 Startup Repair Utility:
 - a. insert the Windows 7 Operating System DVD in the ODD and restart the computer.
 - b. When prompted, press any key to start to the operating system DVD.
 - c. The **Install Windows** screen displays. Click **Next**.
 - d. Select **Repair your computer**.
 - e. The **System Recovery Options** screen displays. Click **Next**.
 - f. Select the appropriate operating system, and click **Next**.

NOTE: Click **Load Drivers** if controller drives are required.

- g. Select **Startup Repair**.
- h. Startup Repair attempts to locate and resolve issues with the computer.
- i. When complete, click **Finish**.

If an issue is discovered, follow the onscreen information to resolve the problem.

4. Run the Windows Memory Diagnostic Tool. For more information see Windows Help and Support.
5. Restart the computer and press F2 to enter the BIOS Utility. Check the BIOS settings are correct and that CD/DVD drive is set as the first boot device on the Boot menu.
6. Ensure all cables and jumpers on the HDD and ODD are set correctly.
7. Remove any recently added hardware and associated software.
8. Run the Windows Disk Defragmenter. For more information see Windows Help and Support.
9. Run Windows Check Disk by entering **chkdsk /r** from a command prompt. For more information see Windows Help and Support.
10. Restore system and file settings from a known good date using **System Restore**.

If the issue is not fixed, repeat the preceding steps and select an earlier time and date.
11. Replace the HDD. See "Disassembly Process" on page 38.

USB Failure

If the USB fails, perform the following actions one at a time to correct the problem. Do not replace a non-defective FRU:

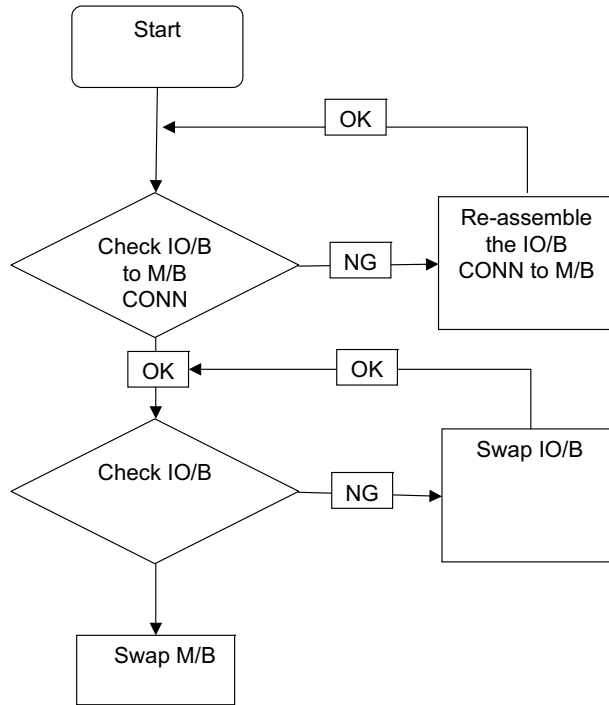

Wireless Function Failure

If the **WLAN** fails, perform the following actions one at a time to correct the problem. Do not replace a non-defective FRUs:

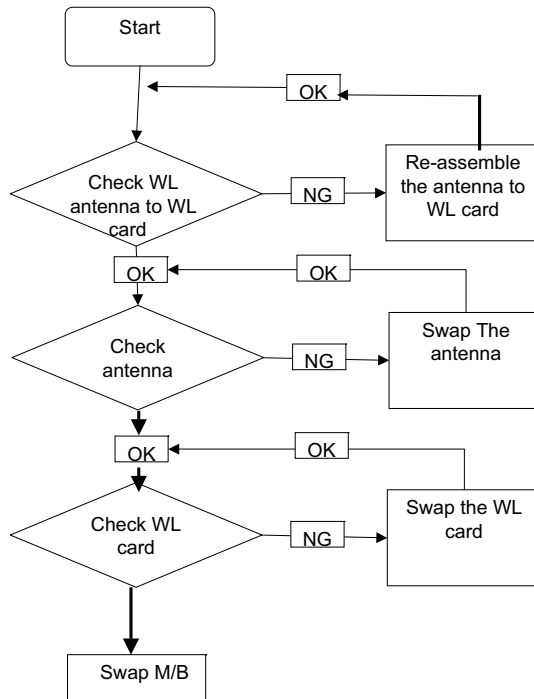

Thermal Unit Failure

If the **Thermal Unit** fails, perform the following actions one at a time to correct the problem. Do not replace a non-defective FRUs:

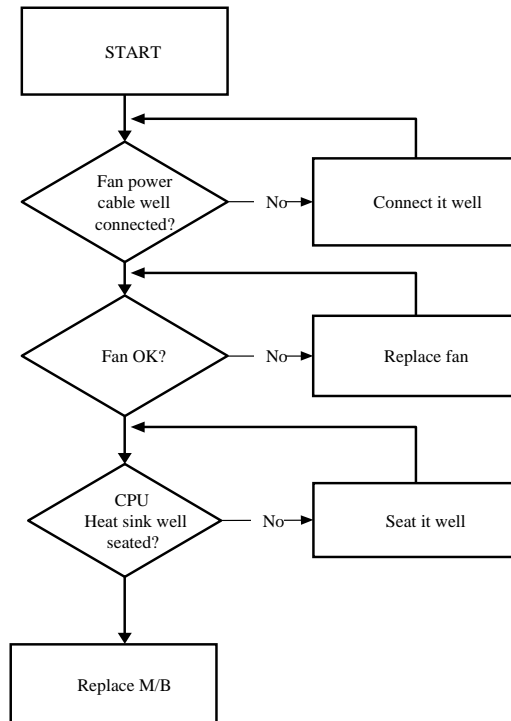

External Mouse Failure

If an external **Mouse** fails, perform the following actions one at a time to correct the problem.

1. Try an alternative mouse.
2. If the mouse uses a wireless connection, insert new batteries and confirm there is a good connection. See the mouse user manual.
3. If the mouse uses a USB connection, try an alternate USB port.
4. Try an alternative program to verify mouse operation. Reinstall the program experiencing mouse failure.
5. Restart the computer.
6. Remove any recently added hardware and associated software.
7. Remove any recently added software and reboot.
8. Restore system and file settings from a known good date using **System Restore**.
If the issue is not fixed, repeat the preceding steps and select an earlier time and date.
9. Run the Event Viewer to check the events log for errors. For more information see Windows Help and Support.
10. Roll back the mouse driver to the previous version if updated recently.
11. Remove and reinstall the mouse driver.
12. Check the Device Manager to determine that:
 - The device is properly installed. There are no red Xs or yellow exclamation marks.
 - There are no device conflicts.
 - No hardware is listed under Other Devices.

13. If the Issue is still not resolved, see "Online Support Information" on page 167.

Other Failures

If the CRT Switch, Dock, LAN Port, external MIC or Speakers, PCI Express Card, 5-in-1 Card Reader or Volume Wheel fail, perform the following general steps to correct the problem. Do not replace a non-defective FRUs:

1. Check Drive whether is OK.
2. Check Test Fixture is ok.
3. Swap M/B to Try.

Intermittent Problems

Intermittent system hang problems can be caused by a variety of reasons that have nothing to do with a hardware defect, such as: cosmic radiation, electrostatic discharge, or software errors. FRU replacement should be considered only when a recurring problem exists.

When analyzing an intermittent problem, do the following:

1. Run the advanced diagnostic test for the system board in loop mode at least 10 times.
2. If no error is detected, do not replace any FRU.
3. If any error is detected, replace the FRU. Rerun the test to verify that there are no more errors.

Undetermined Problems

The diagnostic problems does not identify which adapter or device failed, which installed devices are incorrect, whether a short circuit is suspected, or whether the system is inoperative.

Follow these procedures to isolate the failing FRU (do not isolate non-defective FRU).

NOTE: Verify that all attached devices are supported by the computer.

NOTE: Verify that the power supply being used at the time of the failure is operating correctly. (See “Power On Issue” on page 130.):

1. Power-off the computer.
2. Visually check them for damage. If any problems are found, replace the FRU.
3. Remove or disconnect all of the following devices:
 - Non-Acer devices
 - Printer, mouse, and other external devices
 - Battery pack
 - Hard disk drive
 - DIMM
 - CD-ROM/Diskette drive Module
 - PC Cards
4. Power-on the computer.
5. Determine if the problem has changed.
6. If the problem does not recur, reconnect the removed devices one at a time until you find the failing FRU.
7. If the problem remains, replace the following FRU one at a time. Do not replace a non-defective FRU:
 - System board
 - LCD assembly

Post Codes

These tables describe the POST codes and descriptions during the POST.

Post Code Range

Phase	POST Code Range
SEC	0x01 - 0x0F
PEI	0x70 - 0x9F
DXE	0x40 - 0x6F
BDS	0x10 - 0x3F
SMM	0xA0 - 0xBF
S3	0xC0 - 0xCF
ASL	0x51 – 0x55
	0xE1 – 0xE4
PostBDS	0xF9 – 0xFE
InsydeH2ODDT™ Reserve	0xD0 – 0xD7
OEM Reserve	0xE8 – 0xEB
Reserved	0xD8 – 0xE0
	0xE5 – 0xE7
	0xEC – 0xF8

SEC Phase POST Code Table

Functionality Name (Include PostCode.h)	Phase	Post Code	Description
SEC_SYSTEM_POWER_ON	SEC	1	CPU power on and switch to Protected mode
SEC_BEFORE_MICROCODE_PATCH	SEC	2	Patching CPU microcode
SEC_AFTER_MICROCODE_PATCH	SEC	3	Setup Cache as RAM
SEC_ACCESS_CSR	SEC	4	PCIE MMIO Base Address initial
SEC_GENERIC_MSRRINIT	SEC	5	CPU Generic MSR initialization
SEC_CPU_SPEEDCFG	SEC	6	Setup CPU speed
SEC_SETUP_CAR_OK	SEC	7	Cache as RAM test
SEC_FORCE_MAX_RATIO	SEC	8	Tune CPU frequency ratio to maximum level
SEC_GO_TO_SECSTARTUP	SEC	9	Setup BIOS ROM cache
SEC_GO_TO_PEICORE	SEC	0A	Enter Boot Firmware Volume

NOTE: The color bar items indicate 3rd party related functions that are platform dependent.

PEI Phase POST Code Table:

Functionality Name (Include\ PostCode.h)	Phase	Post Code	Description
PEI_SIO_INIT	PEI	70	Super I/O Initialization
PEI_CPU_REG_INIT	PEI	71	CPU Early Initialization
PEI_CPU_AP_INIT	PEI	72	Multi-processor Early Initial
PEI_CPU_HT_RESET	PEI	73	HyperTransport Initialization
PEI_PCIE_MMIO_INIT	PEI	74	PCIE MMIO BAR Initialization
PEI_NB_REG_INIT	PEI	75	North Bridge Early Initialization
PEI_SB_REG_INIT	PEI	76	South Bridge Early Initialization
PEI_PCIE_TRAINING	PEI	77	PCIE Training
PEI_TPM_INIT	PEI	78	TPM Initialization
PEI_SMBUS_INIT	PEI	79	SMBUS Early Initialization
PEI_PROGRAM_CLOCK_GEN	PEI	7A	Clock Generator Initialization
PEI_IGD_EARLY_INITIAL	PEI	7B	Internal Graphic device early Initialization
PEI_HECI_INIT	PEI	7C	HECI Initialization
PEI_WATCHDOG_INIT	PEI	7D	Watchdog timer Initialization
PEI_MEMORY_INIT	PEI	7E	Memory Initial for Normal boot.
PEI_MEMORY_INIT_FOR_CRISIS	PEI	7F	Memory Initial for Crisis Recovery
PEI_MEMORY_INSTALL	PEI	80	Simple Memory test
PEI_TXTPEI	PEI	81	TXT function early Initialization
PEI_SWITCH_STACK	PEI	82	Start to use Memory
PEI_MEMORY_CALLBACK	PEI	83	Set cache for physical memory
PEI_ENTER_RECOVERY_MODE	PEI	84	Recovery device Initialization
PEI_RECOVERY_MEDIA_FOUND	PEI	85	Found Recovery image
PEI_RECOVERY_MEDIA_NOT_FOUND	PEI	86	Recovery image not found
PEI_RECOVERY_LOAD_FILE_DONE	PEI	87	Load Recovery Image completed
PEI_RECOVERY_START_FLASH	PEI	88	Start Flash BIOS with Recovery image
PEI_ENTER_DXEIPL	PEI	89	Loading BIOS image to RAM
PEI_FINDING_DXE_CORE	PEI	8A	Loading DXE core
PEI_GO_TO_DXE_CORE	PEI	8B	Enter DXE core

NOTE: The color bar items indicate 3rd party related functions that are platform dependent.

DXE Phase POST Code Table:

Functionality Name (Include PostCode.h)	Phase	PostCode	Description
DXE_TCGDXE	DXE	40	TPM initial in DXE
DXE_SB_SPI_INIT	DXE	41	South bridge SPI initialization
DXE_CF9_RESET	DXE	42	Setup Reset service
DXE_SB_SERIAL_GPIO_INIT	DXE	43	South bridge Serial GPIO initialization
DXE_SMMACCESS	DXE	44	Setup SMM ACCE SS service
DXE_NB_INIT	DXE	45	North bridge Middle initialization
DXE_SIO_INIT	DXE	46	Super I/O DXE initialization
DXE_LEGACY_REGION	DXE	47	Setup Legacy Region service
DXE_SB_INIT	DXE	48	South Bridge Middle initialization
DXE_IDENTIFY_FLASH_DEVICE	DXE	49	Identify Flash device
DXE_FTW_INIT	DXE	4A	Fault Tolerant Write verification
DXE_VARIABLE_INIT	DXE	4B	Variable Service initialization
DXE_VARIABLE_INIT_FAIL	DXE	4C	Fail to initial Variable Service
DXE_MTC_INIT	DXE	4D	MTC Initial
DXE_CPU_INIT	DXE	4E	CPU Middle Initialization
DXE_MP_CPU_INIT	DXE	4F	Multi-processor MiddleInitialization
DXE_SMBUS_INIT	DXE	50	SMBUS Driver Initialization
DXE_SMART_TIMER_INIT	DXE	51	8259 Initialization
DXE_PCRTC_INIT	DXE	52	RTC Initialization
DXE_SATA_INIT	DXE	53	SATA Controller earlyInitialization
DXE_SMM_CONTROLLER_INIT	DXE	54	Setup SMM Control service
DXE_LEGACY_INTERRUPT	DXE	55	Setup Legacy Interrupt service
DXE_RELOCATE_SMBASE	DXE	56	Relocate SMM BASE
DXE_FIRST_SMI	DXE	57	SMI test
DXE_VTD_INIT	DXE	58	VTD Initial
DXE_BEFORE_CSM16_INIT	DXE	59	Legacy BIOS Initialization
DXE_AFTER_CSM16_INIT	DXE	5A	Legacy interrupt function Initialization
DXE_LOAD_ACPI_TABLE	DXE	5B	ACPI Table Initialization
DXE_SB_DISPATCH	DXE	5C	Setup SB SMM Dispatcher service
DXE_SB_IOTRAP_INIT	DXE	5D	Setup SB IOTRAP Service
DXE_SUBCLASS_DRIVER	DXE	5E	Build AMT Table
DXE_PPM_INIT	DXE	5F	PPM Initialization
DXE_HECIDRV_INIT	DXE	60	HECIDRV Initialization

NOTE: The color bar items indicate 3rd party related functions that are platform dependent.

BDS Phase POST Code Table:

Functionality Name (Include PostCode.h)	Phase	Post Code	Description
BDS_ENTER_BDS	BDS	10	Enter BDS entry
BDS_INSTALL_HOTKEY	BDS	11	Install Hotkey service
BDS_ASF_INIT	BDS	12	ASF Initialization
BDS_PCI_ENUMERATION_START	BDS	13	PCI enumeration
BDS_BEFORE_PCIE_INSTALL	BDS	14	PCI resource assign complete
BDS_PCI_ENUMERATION_END	BDS	15	PCI enumeration complete
BDS_CONNECT_CONSOLE_IN	BDS	16	Keyboard Controller, Keyboard and Mouse initialization
BDS_CONNECT_CONSOLE_OUT	BDS	17	Video device initialization
BDS_CONNECT_STD_ERR	BDS	18	Error report device initialization
BDS_CONNECT_USB_HC	BDS	19	USB host controller initialization
BDS_CONNECT_USB_BUS	BDS	1A	USB BUS driver initialization
BDS_CONNECT_USB_DEVICE	BDS	1B	USB device driver initialization
BDS_NO_CONSOLE_ACTION	BDS	1C	Console device initial fail
BDS_DISPLAY_LOGO_SYSTEM_INFO	BDS	1D	Display logo or system information
BDS_START_IDE_CONTROLLER	BDS	1E	IDE controller initialization
BDS_START_SATA_CONTROLLER	BDS	1F	SATA controller initialization
BDS_START_ISA_ACPI_CONTROLLER	BDS	20	SIO controller initialization
BDS_START_ISA_BUS	BDS	21	ISA BUS driver initialization
BDS_START_ISA_FDD	BDS	22	Floppy device initialization
BDS_START_ISA_SEIRAL	BDS	23	Serial device initialization
BDS_START_IDE_BUS	BDS	24	IDE device initialization
BDS_START_AHCI_BUS	BDS	25	AHCI device initialization
BDS_CONNECT_LEGACY_ROM	BDS	26	Dispatch option ROMs
BDS_ENUMERATE_ALL_BOOT_OPTION	BDS	27	Get boot device information
BDS_END_OF_BOOT_SELECTION	BDS	28	End of boot selection
BDS_ENTER_SETUP	BDS	29	Enter Setup Menu
BDS_ENTER_BOOT_MANAGER	BDS	2A	Enter Boot manager
BDS_BOOT_DEVICE_SELECT	BDS	2B	Try to boot system to OS
BDS_EFI64_SHADOW_ALL_LEGACY_ROM	BDS	2C	Shadow Misc Option ROM
BDS_ACPI_S3SAVE	BDS	2D	Save S3 resume required data in RAM
BDS_READY_TO_BOOT_EVENT	BDS	2E	Last Chipset initial before boot to OS
BDS_GO_LEGACY_BOOT	BDS	2F	Start to boot Legacy OS
BDS_GO_UEFI_BOOT	BDS	30	Start to boot UEFI OS
BDS_LEGACY16_PREPARE_TO_BOOT	BDS	31	Prepare to Boot to Legacy OS
BDS_EXIT_BOOT_SERVICES	BDS	32	Send END of POST Message to ME via HECI
BDS_LEGACY_BOOT_EVENT	BDS	33	Last Chipset initial before boot to Legacy OS.
BDS_ENTER_LEGACY_16_BOOT	BDS	34	Ready to Boot Legacy OS.
BDS_RECOVERY_START_FLASH	BDS	35	Fast Recovery Start Flash.

NOTE: The color bar items indicate 3rd party related functions that are platform dependent.

PostBDS POST Code Table

Functionality Name (Include\ PostCode.h)	Phase	Post Code	Description
POST_BDS_NO_BOOT_DEVICE	POST_BDS	F9	No Boot Device
POST_BDS_START_IMAGE	POST_BDS	FB	UEFI Boot Start Image
POST_BDS_ENTER_INT19	POST_BDS	FD	Legacy 16 boot entry
POST_BDS_JUMP_BOOT_SECTOR	POST_BDS	FE	Try to Boot with INT 19

S3 Functions POST Code Table

Functionality Name (Include\ PostCode.h)	Phase	Post Code	Description
POST_BDS_NO_BOOT_DEVICE	POST_BDS	F9	No Boot Device
POST_BDS_START_IMAGE	POST_BDS	FB	UEFI Boot Start Image
POST_BDS_ENTER_INT19	POST_BDS	FD	Legacy 16 boot entry
POST_BDS_JUMP_BOOT_SECTOR	POST_BDS	FE	Try to Boot with INT 19

ACPI Functions POST Code Table

Functionality Name (Include\ PostCode.h)	Phase	Post Code	Description
ASL_ENTER_S1	ASL	51	Prepare to enter S1
ASL_ENTER_S3	ASL	53	Prepare to enter S3
ASL_ENTER_S4	ASL	54	Prepare to enter S4
ASL_ENTER_S5	ASL	55	Prepare to enter S5
ASL_WAKEUP_S1	ASL	E1	System wakeup from S1
ASL_WAKEUP_S3	ASL	E3	System wakeup from S3
ASL_WAKEUP_S4	ASL	E4	System wakeup from S4

SMM Functions POST Code Table

Functionality Name (Include\ PostCode.h)	Phase	Post Code	Description
SMM_IDENTIFY_FLASH_DEVICE	SMM	0xA0	Identify Flash device in SMM
SMM_SMM_PLATFORM_INIT	SMM	0xA2	SMM service initial
SMM_ACPI_ENABLE_START	SMM	0xA6	OS call ACPI enable function
SMM_ACPI_ENABLE_END	SMM	0xA7	ACPI enable function complete
SMM_S1_SLEEP_CALLBACK	SMM	0xA1	Enter S1
SMM_S3_SLEEP_CALLBACK	SMM	0xA3	Enter S3

Functionality Name (Include\ PostCode.h)	Phase	Post Code	Description
SMM_S4_SLEEP_CALLBACK	SMM	0xA4	Enter S4
SMM_S5_SLEEP_CALLBACK	SMM	0xA5	Enter S5
SMM_ACPI_DISABLE_START	SMM	0xA8	OS call ACPI disable function
SMM_ACPI_DISABLE_END	SMM	0xA9	ACPI disable function complete

InsydeH2ODDT Debugger POST Code Table

Functionality Name (Include\ PostCode.h)	PostCode	Description
Used by Insyde debugger	0x0D	Waiting for device connect
Used by Insyde debugger	0xD0	Waiting for device connect
Used by Insyde debugger	0xD1	InsydeH2ODDT Ready
Used by Insyde debugger	0xD2	EHCI not found
Used by Insyde debugger	0xD3	Debug port connect low speed device
Used by Insyde debugger	0xD4	DDT Cable become low speed device
Used by Insyde debugger	0xD5	DDT Cable Transmission Error (Get descriptor fail)
Used by Insyde debugger	0xD6	DDT Cable Transmission Error (Set Debug mode fail)
Used by Insyde debugger	0xD7	DDT Cable Transmission Error (Set address fail)

Jumper and Connector Locations

Mainboard Description

Top View

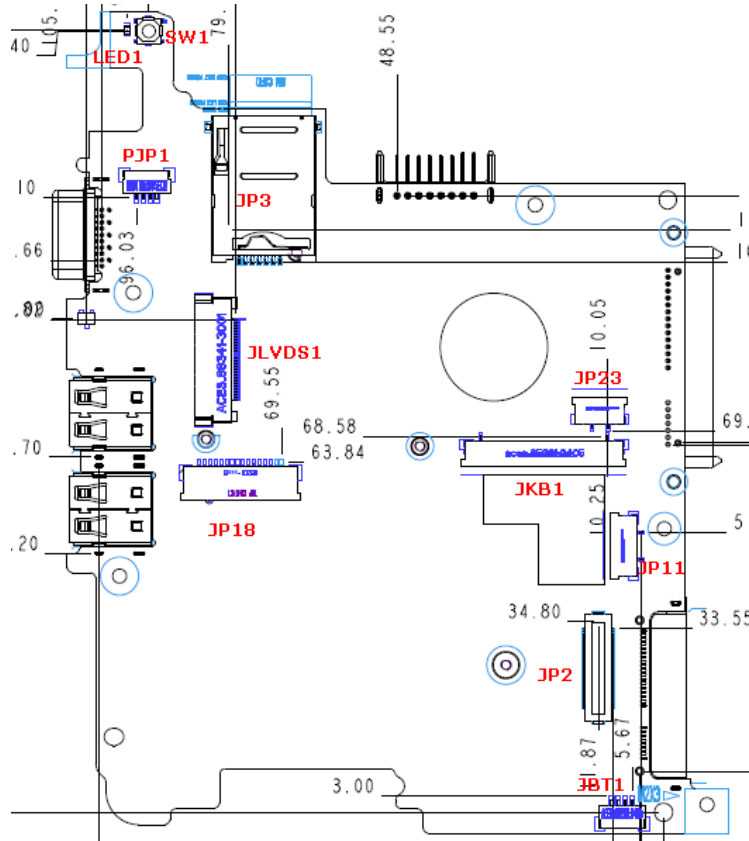

ITEM	DESCRIPTION
SW1	NAV50 Power Button
LED1	NAV50 Power LED
PJP1	AC-IN Jack
JP3	SIM Connector
JLVDS1	LCD Connector
JP18	LED/B Connector
JP23	NAV60 Power/B Connector
JKB1	Internal Keyboard Connector
JP11	T/P Connector
JP2	Bridge/B Connector
JBT1	B/T connector

Bottom View

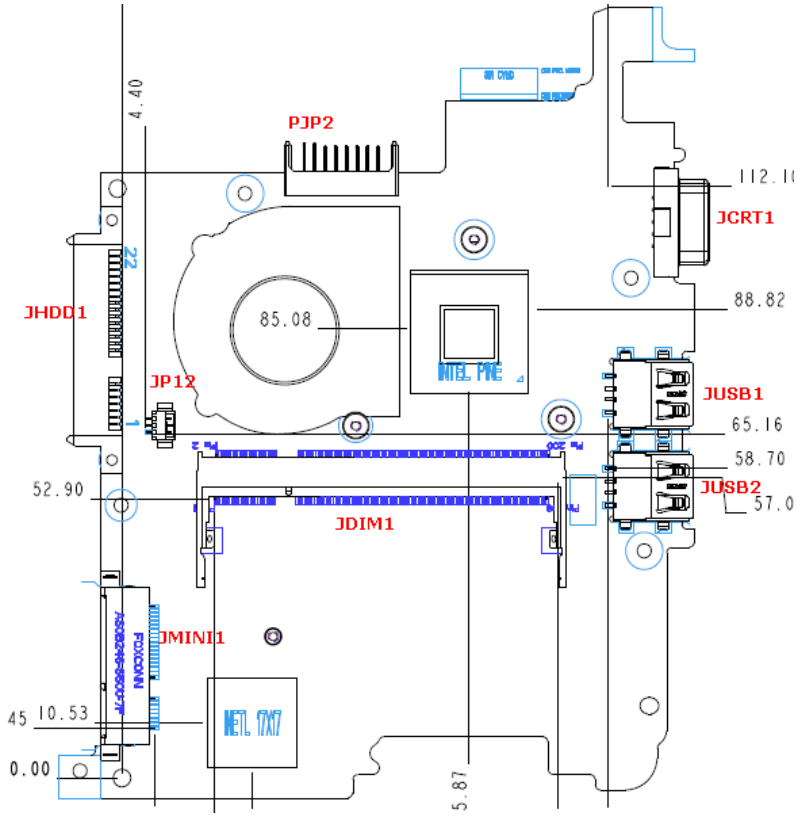

ITEM	DESCRIPTION
PJP2	Battery Connector
JCRT1	CRT Connector
JUSB1	USB Connector
JUSB2	USB Connector
JHDD1	HDD Connector
JDIM1	WWAN Connector
JP12	FAN Connector
JDIM1	RAM Connector

Clearing Password Check and BIOS Recovery

This section provide you the standard operating procedures of clearing password and BIOS recovery for the computer. There is one Hardware Open Gap on the mainboard for clearing password check, and one Hotkey for enabling BIOS Recovery.

Clearing Password Check

Hardware Open Gap Description is as follows:

Item	Description
R1184	Clear CMOS Jumper

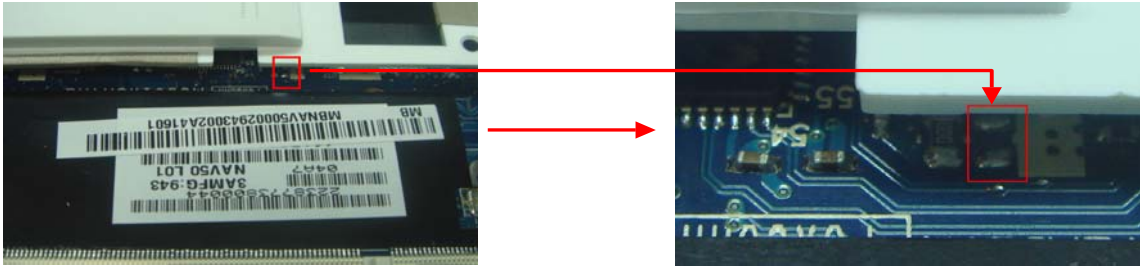

The J3 jumper is located on the mainboard close to the DIMM module.

J3 Electrical Schematic

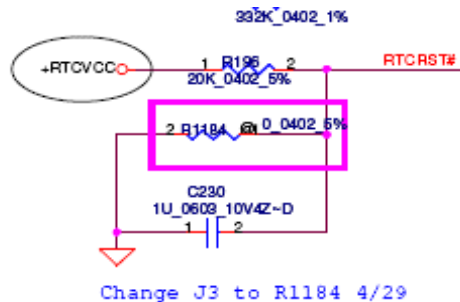

Steps for Clearing BIOS Password Check

If users set BIOS Password (Supervisor Password and/or User Password) for a security reason, BIOS will ask the password during systems POST or when systems enter to BIOS Setup menu. However, once it is necessary to bypass the password check, users need to short the HW Gap to clear the password by the following steps:

1. Power Off the system, and remove HDD, AC and Battery from the machine.
2. Disconnect the RTC Battery cable and locate the R1184 jumper in the DIMM bay.
3. Use an electric conductivity tool to short the two points of the HW Gap.
4. Plug in AC, keep the short condition on the HW Gap, and press Power Button to power on the system till BIOS POST finish. Then remove the tool from the HW Gap.
5. Restart system. Press **F2** key to enter BIOS Setup menu.
6. If there is no Password request, BIOS Password is cleared. Otherwise, please follow the steps and try again.

NOTE: These steps are only for clearing BIOS Password (Supervisor Password and User Password).

BIOS Recovery by Crisis Disk

BIOS Recovery Boot Block:

BIOS Recovery Boot Block is a special block of BIOS. It is used to boot up the system with minimum BIOS initialization. Users can enable this feature to restore the BIOS firmware to a successful one once the previous BIOS flashing process failed.

BIOS Recovery Hotkey:

The system provides a function hotkey: **Fn+Esc**, for enable BIOS Recovery process when system is powered on during BIOS POST. To use this function, it is strongly recommended to have the AC adapter and Battery present. If this function is enabled, the system will force the BIOS to enter a special BIOS block, called Boot Block.

Steps for BIOS Recovery from USB Storage:

Before doing this, prepare the Crisis USB key. The Crisis USB key could be made by executing the Crisis Disk program in another system with Windows XP OS.

Follow the steps below:

1. Save ROM file (file name: **JAL90x64.fd**) to the root directory of USB storage.
2. Plug USB storage into USB port.
3. Press **Fn + ESC** button then plug in AC.

The Power button flashes once.

4. Press **Power** button to initiate system CRISIS mode.

When CRISIS is complete, the system auto restarts with a workable BIOS.

5. Update the latest version BIOS for this machine by regular BIOS flashing process.

Steps for BIOS Recovery by Crisis Disk:

Before doing this, a Crisis Diskette should be prepared ready in hand. The Crisis Diskette could be made by executing the Crisis Disk program in another system with Windows XP OS.

Follow the steps below:

1. Power Off failed system.
2. Attach a USB floppy drive to the failed system.
3. Copy **xxxxx.wph** to tool's folder and rename it as **BIOS.wph**.
4. Execute **wincris.exe** to start the Crisis Disk Build.
5. Select **Removable** and click **Start**.
6. Select **Quick Format Disk** and click **Start**. A progress screen displays.
7. Click **OK** to complete the process.
8. Insert the Crisis Disk in to the USB floppy drive attached to the BIOS flash failed system.
9. In the power-off state, press and hold **Fn+Esc** then press the Power button.

The system powers on and the Crisis BIOS Recovery process begins.

BIOS Boot Block begins restoring the BIOS code from the Crisis floppy disk to BIOS ROM on the failed systems.

When the Crisis flash process is finished, the system restarts with a workable BIOS.

Update to the latest version BIOS for the system using the regular BIOS flashing process.

FRU (Field Replaceable Unit) List

This chapter gives you the FRU (Field Replaceable Unit) listing in global configurations of the computer. Refer to this chapter whenever ordering for parts to repair or for RMA (Return Merchandise Authorization).

Please note that WHEN ORDERING FRU PARTS, you should check the most up-to-date information available on your regional web or channel. For whatever reasons a part number change is made, it will not be noted on the printed Service Guide. For ACER AUTHORIZED SERVICE PROVIDERS, your Acer office may have a DIFFERENT part number code from those given in the FRU list of this printed Service Guide. You MUST use the local FRU list provided by your regional Acer office to order FRU parts for repair and service of customer machines.

NOTE: To scrap or to return the defective parts, you should follow the local government ordinance or regulations on how to dispose it properly, or follow the rules set by your regional Acer office on how to return it.

Exploded Diagrams

Main Assembly

No.	Description	Acer P/N	No.	Description	Acer P/N







LCD Assembly

No.	Description	Acer P/N	No.	Description	Acer P/N

FRU List

CATEGORY	Acer Description	AcerPN
BOARD		
	BLUE TOOTH 2.1	BH.21100.004
	CARD READER BOARD	55.WH202.001
	BRIDGE BOARD	55.WH202.002
	BUTTON BOARD	55.WH202.003
	LED BOARD	55.WH202.004
	POWER BOARD	55.WH202.005
	FUNCTION BOARD	55.WH202.006
	FOXCONN WIRELESS LAN Atheros HB93 1X2 BGN (HM)	NI.23600.046
	FOXCONN WIRELESS LAN Atheros HB95 1X1 BG (HM)	NI.23600.047
	FOXCONN WIRELESS LAN BROADCOM 4312H BG (HM)	NI.23600.053
	HUAWEI EM770W	LC.21300.008
		TBD
	QUALCOMM GOBI2000-VERIZON	LC.21300.032
	FOXCONN BROADCOM BCM970010 MEDIA PROCESSOR MINI-CARD LINK W/ H.264/VC1/MPEG2	LA.20500.003
	FOXCONN QUARTICS QV1721 MEDIA CO-PROCESSOR MINI-CARD TTH130.00 W	LA.23700.001
CABLE		

CATEGORY	Acer Description	AcerPN
	BLUE TOOTH CABLE	50.WH202.001
	DC-IN CABLE	50.WH202.002
	POWER CORD US 3 PIN	27.TAVV5.001
	POWER CORD EU 3 PIN	27.TAVV5.002
	POWER CORD AUS 3 PIN	27.TAVV5.003
	POWER CORD UK 3 PIN	27.TAVV5.004
	POWER CORD CHINA 3 PIN	27.TAVV5.005
	POWER CORD SWISS 3 PIN	27.TAVV5.006
	POWER CORD ITALIAN 3 PIN	27.TAVV5.007
	POWER CORD DENMARK 3 PIN	27.TAVV5.008
	POWER CORD JP 3 PIN	27.TAVV5.009
	POWER CORD SOUTH AFRICA 3 PIN	27.TAVV5.010
	POWER CORD KOREA 3 PIN	27.TAVV5.011
	POWER CORD ISRAEL 3 PIN	27.TAVV5.012
	POWER CORD INDIA 3 PIN	27.TAVV5.013
	POWER CORD TWN 3 PIN	27.TAVV5.014
	POWER CORD ARGENTINA 3 PIN	27.APV02.001
	AC CLIP US	27.WH202.001
	AC CLIP EU	27.WH202.002
	AC CLIP AUSTRALIA	27.WH202.003
	AC CLIP UK	27.WH202.004
	AC CLIP ARGENTINA	27.WH202.005
	AC CLIP CHINA	27.WH202.006
	AC CLIP BRAZIL	27.WH202.007
	AC CLIP S-AFRICA	27.WH202.008
	AC CLIP KOREA	27.WH202.009
	ANTENNA WLAN-MAIN	50.WH202.003
	ANTENNA WLAN-AUX	50.WH202.004

CATEGORY	Acer Description	AcerPN
	LCD CABLE	50.WH202.005
	ANTENNA 3G-MAIN	50.WH302.001
	ANTENNA 3G-AUX	50.WH302.002
CASE/COVER/BRACKET ASSEMBLY		
	UPPER CASE ASSY FOR W/BT, INCL. TP/TP MYLAR - SILVER - GTW	60.WH402.001
	UPPER CASE ASSY FOR W/O BT, INCL. TP/TP MYLAR - BLACK SILVER - GTW	60.WH202.002
	UPPER CASE ASSY FOR W/O BT, INCL. TP/TP MYLAR - SILVER - GTW	60.WH402.002
	UPPER CASE ASSY FOR W/BT, INCL. TP/TP MYLAR - BLACK SILVER - PB	60.BGL02.001
	UPPER CASE ASSY FOR W/BT, INCL. TP/TP MYLAR - SILVER - PB	60.BGN02.001
	UPPER CASE ASSY FOR W/O BT, INCL. TP/TP MYLAR - BLACK SILVER - PB	60.BGL02.002
	UPPER CASE ASSY FOR W/O BT, INCL. TP/TP MYLAR - SILVER - PB	60.BGN02.002
	LOWER CASE ASSY FOR W/3G-BLACK	60.WH202.003
	LOWER CASE ASSY FOR W/3G-WHITE	60.WH402.003
	LOWER CASE ASSY FOR W/O 3G-BLACK	60.WH202.004
	LOWER CASE ASSY FOR W/O 3G-WHITE	60.WH402.004
	HDD DOOR-BLACK	42.WH202.001
	HDD DOOR-WHITE	42.WH402.001
	RAM DOOR-BLACK	42.WH202.002
	RAM DOOR-WHITE	42.WH402.002

CATEGORY	Acer Description	AcerPN
	HDD HOUSING	33.WH202.001
	LCD COVER-BLACK GTW	60.WH202.005
	LCD COVER-BLACK PB	60.BGL02.003
	LCD COVER-WHITE GTW	60.WH402.005
	LCD COVER-WHITE PB	60.BGN02.003
	LCD BEZEL-BLACK	60.WH202.006
	LCD BEZEL-WHITE	60.WH402.006
	LCD BRACKET R&L	33.WH202.002
CAMERA		
	CAMERA 0.3M	57.WH202.001
HEATSINK		
	THERMAL MOUDLE (FAN)	60.WH202.007

CATEGORY	Acer Description	AcerPN
KEYBOARD		
	Keyboard GATEWAY GP-0T SJV01_PT Internal 10 Standard 84KS Black US International Texture	KB.I100G.026
	Keyboard GATEWAY GP-0T SJV01_PT Internal 10 Standard 84KS Black Arabic Texture	KB.I100G.002
	Keyboard GATEWAY GP-0T SJV01_PT Internal 10 Standard 84KS Black Chinese Texture	KB.I100G.006
	Keyboard GATEWAY GP-0T SJV01_PT Internal 10 Standard 84KS Black Russian Texture	KB.I100G.018
	Keyboard GATEWAY GP-0T SJV01_PT Internal 10 Standard 84KS Black US International w/ Hebrew Texture	KB.I100G.027
	Keyboard GATEWAY GP-0T SJV01_PT Internal 10 Standard 84KS Black Thailand Texture	KB.I100G.023
	Keyboard GATEWAY GP-0T SJV01_PT Internal 10 Standard 85KS Black UK Texture	KB.I100G.025
	Keyboard GATEWAY GP-0T SJV01_PT Internal 10 Standard 85KS Black German Texture	KB.I100G.010
	Keyboard GATEWAY GP-0T SJV01_PT Internal 10 Standard 85KS Black Swiss/G Texture	KB.I100G.022
	Keyboard GATEWAY GP-0T SJV01_PT Internal 10 Standard 85KS Black Belgium Texture	KB.I100G.003
	Keyboard GATEWAY GP-0T SJV01_PT Internal 10 Standard 85KS Black Danish Texture	KB.I100G.007
	Keyboard GATEWAY GP-0T SJV01_PT Internal 10 Standard 85KS Black Italian Texture	KB.I100G.013
	Keyboard GATEWAY GP-0T SJV01_PT Internal 10 Standard 85KS Black French Texture	KB.I100G.009
	Keyboard GATEWAY GP-0T SJV01_PT Internal 10 Standard 85KS Black Hungarian Texture	KB.I100G.012
	Keyboard GATEWAY GP-0T SJV01_PT Internal 10 Standard 85KS Black Norwegian Texture	KB.I100G.016
	Keyboard GATEWAY GP-0T SJV01_PT Internal 10 Standard 85KS Black Portuguese Texture	KB.I100G.017
	Keyboard GATEWAY GP-0T SJV01_PT Internal 10 Standard 85KS Black Spanish Texture	KB.I100G.020
	Keyboard GATEWAY GP-0T SJV01_PT Internal 10 Standard 85KS Black US w/ Canadian French Texture	KB.I100G.028
	Keyboard GATEWAY GP-0T SJV01_PT Internal 10 Standard 85KS Black Turkish Texture	KB.I100G.024
	Keyboard GATEWAY GP-0T SJV01_PT Internal 10 Standard 85KS Black Sweden Texture	KB.I100G.021
	Keyboard GATEWAY GP-0T SJV01_PT Internal 10 Standard 85KS Black FR/Arabic Texture	KB.I100G.008
	Keyboard GATEWAY GP-0T SJV01_PT Internal 10 Standard 85KS Black Nordic Texture	KB.I100G.015
Keyboard GATEWAY GP-0T SJV01_PT Internal 10 Standard 85KS Black SLO/CRO Texture	KB.I100G.019	
Keyboard GATEWAY GP-0T SJV01_PT Internal 10 Standard 85KS Black CZ/SK Texture	KB.I100G.005	

CATEGORY	Acer Description	AcerPN
	Keyboard GATEWAY GP-0T SJV01_PT Internal 10 Standard 85KS Black Brazilian Portuguese Texture	KB.I100G.004
	Keyboard GATEWAY GP-0T SJV01_PT Internal 10 Standard 88KS Black Japanese Texture	KB.I100G.014
	Keyboard GATEWAY GP-0T White SJV01_PT Internal 10 Standard 84KS White US International Texture	KB.I100G.055
	Keyboard GATEWAY GP-0T White SJV01_PT Internal 10 Standard 84KS White Greek Texture	KB.I100G.039
	Keyboard GATEWAY GP-0T White SJV01_PT Internal 10 Standard 84KS White Arabic Texture	KB.I100G.030
	Keyboard GATEWAY GP-0T White SJV01_PT Internal 10 Standard 84KS White Chinese Texture	KB.I100G.034
	Keyboard GATEWAY GP-0T White SJV01_PT Internal 10 Standard 84KS White Russian Texture	KB.I100G.047
	Keyboard GATEWAY GP-0T White SJV01_PT Internal 10 Standard 84KS White US International w/ Hebrew Tex	KB.I100G.056
	Keyboard GATEWAY GP-0T White SJV01_PT Internal 10 Standard 84KS White Thailand Texture	KB.I100G.052
	Keyboard GATEWAY GP-0T White SJV01_PT Internal 10 Standard 85KS White UK Texture	KB.I100G.054
	Keyboard GATEWAY GP-0T White SJV01_PT Internal 10 Standard 85KS White German Texture	KB.I100G.038
	Keyboard GATEWAY GP-0T White SJV01_PT Internal 10 Standard 85KS White Swiss/G Texture	KB.I100G.051
	Keyboard GATEWAY GP-0T White SJV01_PT Internal 10 Standard 85KS White Belgium Texture	KB.I100G.031
	Keyboard GATEWAY GP-0T White SJV01_PT Internal 10 Standard 85KS White Danish Texture	KB.I100G.035
	Keyboard GATEWAY GP-0T White SJV01_PT Internal 10 Standard 85KS White Italian Texture	KB.I100G.041
	Keyboard GATEWAY GP-0T White SJV01_PT Internal 10 Standard 85KS White French Texture	KB.I100G.037
	Keyboard GATEWAY GP-0T White SJV01_PT Internal 10 Standard 85KS White Hungarian Texture	KB.I100G.040
	Keyboard GATEWAY GP-0T White SJV01_PT Internal 10 Standard 85KS White Norwegian Texture	KB.I100G.045
	Keyboard GATEWAY GP-0T White SJV01_PT Internal 10 Standard 85KS White Portuguese Texture	KB.I100G.046
	Keyboard GATEWAY GP-0T White SJV01_PT Internal 10 Standard 85KS White Spanish Texture	KB.I100G.049
	Keyboard GATEWAY GP-0T White SJV01_PT Internal 10 Standard 85KS White US w/ Canadian French Texture	KB.I100G.057
	Keyboard GATEWAY GP-0T White SJV01_PT Internal 10 Standard 85KS White Turkish Texture	KB.I100G.053
	Keyboard GATEWAY GP-0T White SJV01_PT Internal 10 Standard 85KS White Sweden Texture	KB.I100G.050
	Keyboard GATEWAY GP-0T White SJV01_PT Internal 10 Standard 85KS White FR/Arabic Texture	KB.I100G.036
	Keyboard GATEWAY GP-0T White SJV01_PT Internal 10 Standard 85KS White Nordic Texture	KB.I100G.044

CATEGORY	Acer Description	AcerPN
	Keyboard GATEWAY GP-0T White SJV01_PT Internal 10 Standard 85KS White SLO/CRO Texture	KB.I100G.048
	Keyboard GATEWAY GP-0T White SJV01_PT Internal 10 Standard 85KS White CZ/SK Texture	KB.I100G.033
	Keyboard GATEWAY GP-0T White SJV01_PT Internal 10 Standard 85KS White Brazilian Portuguese Texture	KB.I100G.032
	Keyboard GATEWAY GP-0T White SJV01_PT Internal 10 Standard 88KS White Japanese Texture	KB.I100G.042
LCD		
	ASSY LED MODULE 10.1" WSVGA None Glare W/ ANTENNA, CCD, BLACK - GTW	6M.WH202.001
	ASSY LED MODULE 10.1" WSVGA Glare W/ANTENNA, CCD, BLACK - GTW	6M.WH202.002
	ASSY LED MODULE 10.1" WSVGA Glare W/ANTENNA, CCD, BLACK - PB	6M.BGL02.002
	ASSY LED MODULE 10.1" WSVGA None Glare W/ ANTENNA, CCD, WHITE - GTW	6M.WH402.001
	ASSY LED MODULE 10.1" WSVGA Glare W/ANTENNA, CCD, WHITE - GTW	6M.WH402.002
	ASSY LED MODULE 10.1" WSVGA None Glare W/ ANTENNA, CCD, WHITE - PB	6M.BGN02.001
	ASSY LED MODULE 10.1" WSVGA None Glare W/ ANTENNA, CCD, RED - GTW	6M.WH602.001
	ASSY LED MODULE 10.1" WSVGA Glare W/ANTENNA, CCD, RED - GTW	6M.WH602.002
	ASSY LED MODULE 10.1" WSVGA None Glare W/ ANTENNA, CCD, RED - PB	6M.BGM02.001
	ASSY LED MODULE 10.1" WSVGA None Glare W/ ANTENNA, CCD, 3G, BLACK - GTW	6M.WH302.001
	ASSY LED MODULE 10.1" WSVGA None Glare W/ ANTENNA, CCD, 3G, WHITE - GTW	6M.WH502.001
	ASSY LED MODULE 10.1" WSVGA Glare W/ANTENNA, CCD, 3G, WHITE - GTW	6M.WH502.002
	ASSY LED MODULE 10.1" WSVGA None Glare W/ ANTENNA, CCD, 3G, WHITE - PB	6M.BGR02.001
	ASSY LED MODULE 10.1" WSVGA Glare W/ANTENNA, CCD, 3G, WHITE - PB	6M.BGR02.002
Mainboard		
	LT21 LF N450/NM10/3G	MB.BGL02.001
	DOT S2 LF N450/NM10/3G	MB.BGP02.001
MISCELLANEOUS		
	CU FOIL FOR MEDIA PROCESSOR	47.WH202.001
	LCD SCREW MYLAR-BLACK	47.WH202.002
SPEAKER		

CATEGORY	Acer Description	AcerPN
	MIC SET FOR W/3G	23.WH302.001

Screw List

CATEGORY	Acer Description	AcerPN
SCREW		

Model Definition and Configuration

Model	Acer Part No	Description	CPU	LCD
DOTS2-21G25n	LU.BGL0D.002	DOTS2-21G25n SNW7ST32DTDE1 UMACkk 1*1G/250/BT/6L2.2/5R/ CBSD_bgn_0.3D_BAG_GEk_DE41 DOT_S2.GE/120	ATMN 450B	NLED10. 1WSVGA G
DOTS2-21G16n	LU.BGL0B.002	DOTS2-21G16n AOXPHTFR1 UMACkk 1*1G/160/6L2.2/5R/ CB_bgn_0.3D_GEk_FR51 DOT_S2.FR/002	ATMN 450B	NLED10. 1WSVGA G
DOTS2-21G16n	LU.BGL0B.001	DOTS2-21G16n AOXPHTFR1 UMACkk 1*1G/160/3L2.2/5R/ CB_bgn_0.3D_GEk_FR51 DOT_S2.FR/001	ATMN 450B	NLED10. 1WSVGA G
DOTS2-21G25n	LU.BGL0D.001	DOTS2-21G25n SNW7ST32DTFR1 UMACkk 1*1G/250/6L2.2/5R/ CB_bgn_0.3D_GEk_FR51 DOT_S2.FR/003	ATMN 450B	NLED10. 1WSVGA G
DOTS2-21G16n	LU.BGN0D.001	DOTS2-21G16n SNW7ST32DTPT1 UMACww 1*1G/160/6L2.2/5R/ CB_bgn_0.3D_BAG_XSync_GEw_P T41 DOT_S2/W.PT/001	ATMN 450B	NLED10. 1WSVGA G

HDD 1(GB)	Wireless LAN1	Bluetooth	Battery
N250GB5.4KS	3rd WiFi 1x2 BGN	BT 2.1	6CELL2.2
N160GB5.4KS	3rd WiFi 1x2 BGN	N	6CELL2.2
N160GB5.4KS	3rd WiFi 1x2 BGN	N	3CELL2.2
N250GB5.4KS	3rd WiFi 1x2 BGN	N	6CELL2.2
N160GB5.4KS	3rd WiFi 1x2 BGN	N	6CELL2.2

Test Compatible Components

This computer's compatibility is tested and verified by Acer's internal testing department. All of its system functions are tested under the Windows® 7 environment.

Refer to the following lists for components, adapter cards, and peripherals which have passed these tests. Regarding configuration, combination and test procedures, please refer to the appropriate Compatibility Test Report released by the Acer Mobile System Testing Department.

BRAND	Type	Description
3G		
	UNDP-1	3G UNDP-1
Huawei	EM770W	Huawei EM770W
Qualcomm	Gobi2000-Verizon	Qualcomm Gobi2000-Verizon
A cover		
	Black IMR	Black IMR
	Red IMR	Red IMR
	White IMR	White IMR
Accessory		
	USB Bridge Dongle	Accessory USB Bridge dongle device - XSYNC
Gateway	Gateway 10inch Bag Black	Gateway Accessory Gateway 10" Netbook Bag Black
PackardBell	PackardBell 10inch Bag Black	PackardBell Accessory PackardBell 10" Netbook Bag Black
Adapter		
DELTA	40W	Adapter DELTA 40W 19V 1.7x5.5x11 Black ADP-40 TH AA, LV5 wall-mounted, OBL LF
Audio Codec		
Realtek	ALC272X	Realtek Audio Codec ALC272X
B cover		
	Mirror w/Camera	Mirror w/Camera
Battery		
PANASONIC	3CELL2.2	Battery PANASONIC UM-2009G Li-Ion 3S1P PANASONIC 3 cell 2200mAh Main COMMON ID:UM09G51
PANASONIC	6CELL2.2	Battery PANASONIC UM-2009H Li-Ion 3S2P PANASONIC 6 cell 4400mAh Main COMMON ID:UM09H51
SANYO	3CELL2.2	Battery SANYO UM-2009G Li-Ion 3S1P SANYO 3 cell 2200mAh Main COMMON ID:UM09G31
SANYO	3CELL2.2	Battery SANYO UM-2009GW Li-Ion 3S1P SANYO 3 cell 2200mAh Main COMMON ID:UM09G31 , white
SANYO	6CELL2.2	Battery SANYO UM-2009H Li-Ion 3S2P SANYO 6 cell 4400mAh Main COMMON ID:UM09H31
SANYO	6CELL2.8	Battery SANYO UM-2009H Li-Ion 3S2P SANYO 6 cell 5600mAh Main COMMON ID:UM09H36
SANYO	6CELL2.2	Battery SANYO UM-2009HW Li-Ion 3S2P SANYO 6 cell 4400mAh Main COMMON ID:UM09H31 , white

BRAND	Type	Description
SIMPLO	3CELL2.2	Battery SIMPLO UM-2009G Li-Ion 3S1P LGC 3 cell 2200mAh Main COMMON ID:UM09G73
SIMPLO	3CELL2.2	Battery SIMPLO UM-2009G Li-Ion 3S1P PANASONIC 3 cell 2200mAh Main COMMON ID:UM09G71
SIMPLO	3CELL2.2	Battery SIMPLO UM-2009G Li-Ion 3S1P SAMSUNG 3 cell 2200mAh Main COMMON ID:UM09G75
SIMPLO	3CELL2.2	Battery SIMPLO UM-2009GW Li-Ion 3S1P SAMSUNG 3 cell 2200mAh Main COMMON ID:UM9G75 , white
SIMPLO	6CELL2.2	Battery SIMPLO UM-2009H Li-Ion 3S2P LGC 6 cell 4400mAh Main COMMON ID: UM09H73
SIMPLO	6CELL2.8	Battery SIMPLO UM-2009H Li-Ion 3S2P LGC 6 cell 5600mAh Main COMMON ID:UM09H78
SIMPLO	6CELL2.2	Battery SIMPLO UM-2009H Li-Ion 3S2P PANASONIC 6 cell 4400mAh Main COMMON ID:UM9H71
SIMPLO	6CELL2.2	Battery SIMPLO UM-2009H Li-Ion 3S2P SAMSUNG 6 cell 4400mAh Main COMMON ID:UM09H75
SIMPLO	6CELL2.8	Battery SIMPLO UM-2009H Li-Ion 3S2P SAMSUNG 6 cell 5600mAh Main COMMON ID:UM09H70
SIMPLO	6CELL2.2	Battery SIMPLO UM-2009HW Li-Ion 3S2P PANASONIC 6 cell 4400mAh Main COMMON ID:UM09H71 , white
SIMPLO	6CELL2.8	Battery SIMPLO UM-2009HW Li-Ion 3S2P SAMSUNG 6 cell 5600mAh Main COMMON ID:UM09H70, white
SONY	3CELL2.2	Battery SONY UM-2009G Li-Ion 3S1P SONY 3 cell 2200mAh Main COMMON ID:UM09G41
SONY	6CELL2.2	Battery SONY UM-2009H Li-Ion 3S2P SONY 6 cell 4400mAh Main COMMON ID:UM09H41
Bluetooth		
Foxconn	BT 2.1	Foxconn Bluetooth BRM 2046 BT.1 (T60H928.33) f/w:861
Camera		
Chicony	0.3M LDV	Chicony 0.3M LDV Lilac_3GA (CNF9042-G)
Chicony	0.3M LDV	Chicony Camera Lilac_2G
Liteon	0.3M LDV	Liteon 0.3M LDV Lily_2GA
Suyin	0.3M LDV	Suyin Camera Rose_2G
Suyin	0.3M LDV	Suyin Camera Rose_3G
Card Reader		
	5 in 1-Build in	5 in 1-Build in MS, MS Pro, SD, SC, XD
CPU		
INTEL	ATMN450B	CPU Intel Atom N450 BGA 1.66G 512K
HDD		
HGST	N160GB5.4KS	HDD HGST 2.5" 5400rpm 160GB HTS545016B9A300 Panther B SATA LF F/W:C60F Disk imbalance criteria = 0.014g-cm
HGST	N250GB5.4KS	HDD HGST 2.5" 5400rpm 250GB HTS545025B9A300 Panther B SATA LF F/W:C60F Disk imbalance criteria = 0.014g-cm
SEAGATE	N160GB5.4KS	HDD SEAGATE 2.5" 5400rpm 160GB ST9160314AS Wyatt SATA LF F/W:0001SDM1
SEAGATE	N250GB5.4KS	HDD SEAGATE 2.5" 5400rpm 250GB ST9250315AS Wyatt SATA LF F/W:0001SDM1

BRAND	Type	Description
TOSHIBA	N160GB5.4KS	HDD TOSHIBA 2.5" 5400rpm 160GB MK1655GSX Libra SATA LF F/W: FG011J
TOSHIBA	N250GB5.4KS	HDD TOSHIBA 2.5" 5400rpm 250GB MK2555GSX Libra SATA LF F/W:FG001J
WD	N160GB5.4KS	HDD WD 2.5" 5400rpm 160GB WD1600BEVT-22ZCT0 ML160 SATA LF F/W:11.01A11
WD	N250GB5.4KS	HDD WD 2.5" 5400rpm 250GB WD2500BEVT-22ZCT0 ML160 SATA LF F/W:11.01A11
Keyboard		
GATEWAY	GP-0T	Keyboard GATEWAY GP-0T SJV01_PT Internal 10 Standard Black NONE Texture
LAN		
Atheros	AR8132L	Atheros AR8132L
LCD		
AUO	NLED10.1WSVG AG	LED LCD AUO 10.1" WSVGA Glare B101AW03 V0 2A (3G) LF 200nit 8ms 500:1
CMO	NLED10.1WSVG AG	LED LCD CMO 10.1" WSVGA Glare N101L6-L02 C2 (3G) LF 200nit 10ms 650:1
INNOLUX	NLED10.1WSVG AG	LED LCD INNOLUX 10.1" WSVGA Glare BT101IW01 V1 LF 200nit 8ms 400:1
LPL	NLED10.1WSVG AG	LED LCD LPL 10.1" WSVGA Glare LP101WSA-TLA1 LF 200nit 16ms 400:1
SAMSUNG	NLED10.1WSVG AG	LED LCD SAMSUNG 10.1" WSVGA Glare LTN101NT02-A04 LF 200nit 16ms 400:1
MEM		
ELPIDA	SO1GBII8	Memory ELPIDA SO-DIMM DDRII 800 1GB EBE10UE8AFSA-8G-F LF 128*8 0.065um
HYNIX	SO1GBII8	Memory HYNIX SO-DIMM DDRII 800 1GB HYMP112S64CP6-S6 LF 64*16 0.065um
MICRON	SO1GBII8	Memory MICRON SO-DIMM DDRII 800 1GB MT8HTF12864HDY-800G1 LF 64*16 0.065um
NANYA	SO1GBII8	Memory NANYA SO-DIMM DDRII 800 1GB NT1GT64UH8D0FN-AD LF 64*16 0.07um
SAMSUNG	SO1GBII8	Memory SAMSUNG SO-DIMM DDRII 800 1GB M470T2864EH3-CF7 LF 64*16 0.055um
NB Chipset		
INTEL	NM10	NB Chipset Intel CS CG82NM10
Software		
	NIS	Antivirus application NIS
VGA Chip		
None	UMA	UMA (Intel)
WiFi Antenna		
WNC	PIFA	PIFA
Wireless LAN		
Foxconn	3rd WiFi 1x2 BGN	Foxconn Wireless LAN Atheros HB93 1x2 BGN (HM)
Foxconn	3rd WiFi BG	Foxconn Wireless LAN Broadcom 4312H BG (HM)
Foxconn	3rd WiFi BG	Foxconn Wirelss LAN Atheros HB95 1x1 BG (HM)

Online Support Information

This section describes online technical support services available to help you repair your Acer Systems.

If you are a distributor, dealer, ASP or TPM, please refer your technical queries to your local Acer branch office. Acer Branch Offices and Regional Business Units may access our website. However some information sources will require a user i.d. and password. These can be obtained directly from Acer CSD Taiwan.

Acer's Website offers you convenient and valuable support resources whenever you need them.

In the Technical Information section you can download information on all of Acer's Notebook, Desktop and Server models including:

- Service guides for all models
- User's manuals
- Training materials
- Bios updates
- Software utilities
- Spare parts lists
- TABs (Technical Announcement Bulletin)

For these purposes, we have included an Acrobat File to facilitate the problem-free downloading of our technical material.

Also contained on this website are:

- Detailed information on Acer's International Traveler's Warranty (ITW)
- Returned material authorization procedures
- An overview of all the support services we offer, accompanied by a list of telephone, fax and email contacts for all your technical queries.

We are always looking for ways to optimize and improve our services, so if you have any suggestions or comments, please do not hesitate to communicate these to us.

A

- AFLASH Utility 35
- Antennas
 - Removing 98

B

- Battery Pack
 - Removing 46
 - Replacing 131
- BIOS
 - vendor 17
 - Version 17
- BIOS Utility 27–35
 - Boot 33
 - Exit 34
 - Navigating 27
 - Onboard Device Configuration 31
 - Power 33
 - Save and Exit 34
 - Security 30
 - System Security 34
- Board Layout
 - Top View 155

C

- Camera Module
 - Removing 92
 - Replacing 105
- Common Problems 134
- CPU
 - Removing 89
 - Replacing 108
- CPU Fan
 - Removing 87
 - Replacing 109

D

- DIMM Modules
 - Removing 51
 - Replacing 128
- Display 4

E

- EasyTouch Failure 148

- External Module Disassembly
 - Flowchart 45

F

- Features 1
- Flash Utility 35
- FPC Cable
 - Removing 95
 - Replacing 103
- FRU (Field Replaceable Unit) List 161

H

- Hard Disk Drive Modules
 - Replacing 127
- HDD1
 - Removing 54
 - Replacing 127
- HDD2
 - Removing 56
 - Replacing 127
- HDTV Switch Failure 149
- Hot Keys 13

I

- Indicators 11
- Intermittent Problems 150
- Internal Microphone Failure 140
- Internal Speaker Failure 138

J

- Jumper and Connector Locations 155

K

- Keyboard
 - Removing 63
 - Replacing 123
- Keyboard Failure 137

L

- LCD Bezel
 - Removing 91
 - Replacing 106

- LCD Brackets
 - Removing 95
 - Replacing 103
- LCD Failure 137
- LCD Module
 - Removing 65
 - Replacing 120
- LCD Module Disassembly
 - Flowchart 90
- LCD Module Reassembly Procedure 100
- LCD Panel
 - Removing 93
 - Replacing 103
- LED Board
 - Removing 76
 - Replacing 115
- Lower Covers
 - Removing 48
 - Replacing 129

M

- Main Module Reassembly Procedure 108
- Main Unit Disassembly
 - Flowchart 58
- Mainboard
 - Removing 84
 - Replacing 111
- Media Board
 - Removing 62
 - Replacing 124
- Media Board FFC
 - Removing 75
 - Replacing 115
- Memory Check 134
- MIC Board
 - Replacing 100
- Microphone Module
 - Removing 97
- Model Definition 176
- Modem Board
 - Removing 80
 - Replacing 113
- Modem Cable
 - Removing 85
 - Replacing 110
- Modem Failure 145

N

- No Display Issue 135

O

- ODD Failure 142
- ODD Module
 - Removing 49
 - Replacing 129
- Online Support Information 189

P

- Panel 5
 - Bottom 8
 - left 5
- PC Card 11
- Power Board
 - Removing 94
 - Replacing 100
- Power On Failure 134
- Primary HDD
 - Removing 54
 - Replacing 127

R

- RJ-11 Jack
 - Removing 85
 - Replacing 110
- RTC Battery
 - Removing 79

S

- SD Dummy Card
 - Removing 47
 - Replacing 131
- Secondary HDD
 - Removing 56
 - Replacing 127
- Speaker Module
 - Removing 77
 - Replacing 114
- Switch Cover
 - Removing 59
 - Replacing 125
- System
 - Block Diagram 4

T

Test Compatible Components 183

Thermal Grease 108

Thermal Module

 Removing 88

 Replacing 108

Thermal Unit Failure 148

TouchPad Bracket

 Removing 74

 Replacing 116

TouchPad Failure 138

Troubleshooting

 Built-in KB Failure 137

 EasyTouch Buttons 148

 HDTV Switch 149

 Internal Microphone 140

 Internal Speakers 138

 LCD Failure 137

 Modem 145

 No Display 135

 ODD 142

 Other Failures 149

 Power On 134

 Thermal Unit 148

 TouchPad 138

 WLAN 146

U

Undetermined Problems 150

Upper Cover

 Removing 70

 Replacing 116

USB Board

 Removing 82

 Replacing 112

utility

 BIOS 27–35

W

Windows 2000 Environment Test 184

Wireless Function Failure 146

WLAN Module

 Removing 52

 Replacing 128

