

# XPS™

## SETUP GUIDE





# XPS™

## SETUP GUIDE

Regulatory model: P09E

Regulatory type: P09E002

[Downloaded from LpManual.com](http://LpManual.com) Manuals

# Notes, Cautions, and Warnings

 **NOTE:** A NOTE indicates important information that helps you make better use of your computer.

 **CAUTION:** A CAUTION indicates either potential damage to hardware or loss of data and tells you how to avoid the problem.

 **WARNING:** A WARNING indicates a potential for property damage, personal injury, or death.

If you purchased a Dell™ n Series computer, any references in this document to the Microsoft® Windows® operating systems are not applicable.

This item incorporates copy protection technology that is protected by U.S. patents and other intellectual property rights of Rovi Corporation. Reverse engineering and disassembly are prohibited.

---

**Information in this document is subject to change without notice.**

**© 2010 Dell Inc. All rights reserved.**

Reproduction of these materials in any manner whatsoever without the written permission of Dell Inc. is strictly forbidden.

Trademarks used in this text: Dell™, the DELL logo, XPS™, and DellConnect™ are trademarks of Dell Inc.; Intel® and Centrino® are registered trademarks and Core™ is a trademark of Intel Corporation in the U.S. and other countries; Microsoft®, Windows®, and the Windows start button logo  are either trademarks or registered trademarks of Microsoft Corporation in the United States and/or other countries; Blu-ray Disc™ is a trademark of the Blu-ray Disc Association; Bluetooth® is a registered trademark owned by Bluetooth SIG, Inc. and is used by Dell under license.

Other trademarks and trade names may be used in this document to refer to either the entities claiming the marks and names or their products. Dell Inc. disclaims any proprietary interest in trademarks and trade names other than its own.

**August 2011**

**P/N C4XC4**

**Rev. A01**

[Downloaded from LpManual.com Manuals](http://LpManual.com/Manuals)

# Contents

|  |          |   |           |
|--|----------|---|-----------|
| <b>Setting Up Your XPS Laptop . . . . .</b>            | <b>7</b> | <b>Using Your XPS Laptop. . . . .</b>           | <b>26</b> |
| Before Setting Up Your Computer . . . . .              | 7        | Right View Features . . . . .                   | 26        |
| Connect the AC Adapter . . . . .                       | 8        | Left View Features . . . . .                    | 30        |
| Connect the Network Cable<br>(Optional) . . . . .      | 9        | Back View Features . . . . .                    | 32        |
| Press the Power Button . . . . .                       | 10       | Computer Base and Keyboard<br>Features. . . . . | 34        |
| Set Up Microsoft Windows . . . . .                     | 11       | Status Lights and Indicators. . . . .           | 38        |
| Create System Recovery Media<br>(Recommended). . . . . | 12       | Disabling Battery Charging . . . . .            | 39        |
| Install the SIM Card (Optional) . . . . .              | 14       | Touch Pad Gestures . . . . .                    | 40        |
| Enable or Disable Wireless (Optional). . .             | 16       | Multimedia Control Keys . . . . .               | 42        |
| Set Up Wireless Display (Optional) . . . .             | 18       | Control Strip Features . . . . .                | 44        |
| Set Up the TV Tuner (Optional) . . . . .               | 19       | Using the Optical Drive . . . . .               | 46        |
| Set Up Stereoscopic 3D (Optional). . . .               | 20       | Display Features . . . . .                      | 48        |
| Set Up 3D TV (Optional). . . . .                       | 21       | Touch Screen Gestures (Optional) . . . .        | 50        |
| Connect to the Internet (Optional). . . .              | 23       | Removing and Replacing<br>the Battery. . . . .  | 52        |

## Contents

|   |           |  |           |
|---|-----------|--|-----------|
| Software Features . . . . .                       | 54        | <b>Restoring Your Operating System . . .</b>                         | <b>77</b> |
| Dell DataSafe Online Backup . . . . .             | 55        | System Restore . . . . .   | 78        |
| NVIDIA Optimus Technology<br>(Optional) . . . . . | 56        | Dell DataSafe Local Backup . . . . .                                 | 79        |
| NVIDIA 3DTV Play . . . . .                        | 57        | System Recovery Media . . . . .                                      | 81        |
| Dell Stage . . . . .                              | 61        | Dell Factory Image Restore . . . . .                                 | 82        |
| Free Fall Sensor . . . . .                        | 62        | <b>Getting Help . . . . .</b>  | <b>84</b> |
| <b>Solving Problems . . . . .</b>                 | <b>63</b> | Technical Support and Customer<br>Service . . . . .                  | 85        |
| Beep Codes . . . . .                              | 63        | DellConnect . . . . .  | 85        |
| Touch Screen Problems . . . . .                   | 64        | Online Services . . . . .  | 86        |
| Network Problems . . . . .                        | 65        | Automated Order-Status Service . . . . .                             | 87        |
| Power Problems . . . . .                          | 66        | Product Information . . . . .  | 87        |
| Memory Problems . . . . .                         | 67        | Returning Items for Repair Under<br>Warranty or for Credit . . . . . | 88        |
| Lockups and Software Problems . . . . .           | 68        | Before You Call . . . . .  | 89        |
| <b>Using Support Tools . . . . .</b>              | <b>70</b> | Contacting Dell . . . . .  | 91        |
| Dell Support Center . . . . .                     | 70        |  |           |
| My Dell Downloads . . . . .                       | 71        |  |           |
| Hardware Troubleshooter . . . . .                 | 72        |  |           |
| Dell Diagnostics . . . . .                        | 72        |  |           |

|   |            |
|---|------------|
| <b>Finding More Information and Resources</b> .....                       | <b>92</b>  |
| <b>Specifications</b> .....   | <b>94</b>  |
| <b>Appendix</b> .....   | <b>101</b> |
| Information for NOM, or Official Mexican Standard (Only for Mexico) . . . | 101        |
| <b>Index</b> .....  | <b>102</b> |



# Setting Up Your XPS Laptop

This section provides information about setting up your Dell XPS laptop.

## Before Setting Up Your Computer

When positioning your computer, ensure that you allow easy access to a power source, adequate ventilation, and a level surface to place your computer.

Restricting airflow around your laptop may cause it to overheat. To prevent overheating ensure that you leave a minimum of 5.1 cm (2 inches) on the right and left sides. You should never place your computer in an enclosed space, such as a cabinet or drawer while it is powered on.

 **WARNING:** Do not block, push objects into, or allow dust to accumulate in the air vents. Do not place your Dell computer in a low-airflow environment, such as a closed briefcase, or on fabric surfaces, such as carpets or rugs, while it is powered on. Restricting the airflow can damage the computer, deteriorate the computer performance, or cause a fire. The computer turns on the fan when the computer gets hot. Fan noise is normal and does not indicate a problem with the fan or the computer.

 **CAUTION:** Placing or stacking heavy or sharp objects on the computer may result in permanent damage to the computer.

## Connect the AC Adapter

Connect the AC adapter to the computer and then plug it into an electrical outlet or surge protector.

**⚠ WARNING:** The AC adapter works with electrical outlets worldwide. However, power connectors and power strips vary among countries. Using an incompatible cable or improperly connecting the cable to a power strip or electrical outlet may cause fire or permanent damage to your computer.

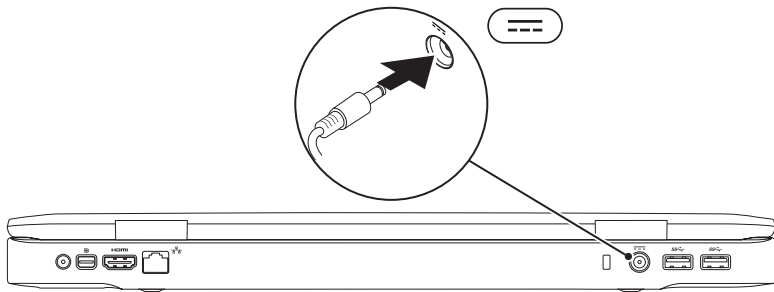

## Connect the Network Cable (Optional)

To use a wired network connection, connect the network cable.

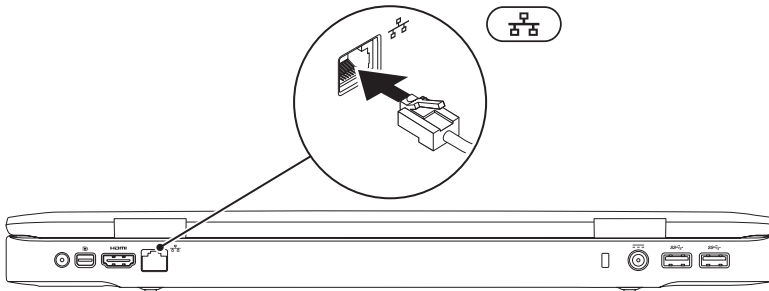



## Press the Power Button



## Set Up Microsoft Windows

Your Dell computer is preconfigured with the Microsoft Windows operating system. To set up Windows for the first time, follow the instructions on the screen. These steps are mandatory and may take some time to complete. The Windows setup screens will take you through several procedures including accepting license agreements, setting preferences, and setting up an Internet connection.

-  **CAUTION:** Do not interrupt the operating system's setup process. Doing so may render your computer unusable and you will need to reinstall the operating system.
-  **NOTE:** For optimal performance of your computer, it is recommended that you download and install the latest BIOS and drivers for your computer available at [support.dell.com](http://support.dell.com).
-  **NOTE:** For more information on the operating system and features, go to [support.dell.com/MyNewDell](http://support.dell.com/MyNewDell).

# Create System Recovery Media (Recommended)

 **NOTE:** It is recommended that you create a system recovery media as soon as you set up Microsoft Windows.

The system recovery media can be used to restore your computer to the operating state it was in when you purchased the computer, while preserving data files (without the need of the *Operating System* disc). You can use the system recovery media if changes to the hardware, software, drivers, or other system settings have left the computer in an undesirable operating state.

You will require the following to create the system recovery media:

- Dell DataSafe Local Backup
- USB key with a minimum capacity of 8 GB or DVD-R/DVD+R/Blu-ray Disc



 **NOTE:** Dell DataSafe Local Backup does not support rewritable discs.

To create a system recovery media:

1. Ensure that the AC adapter is connected (see “Connect the AC Adapter” on page 8).
2. Insert the disc or USB key in the computer.
3. Click **Start**  → **All Programs** → **Dell DataSafe Local Backup**.
4. Click **Create Recovery Media**.
5. Follow the instructions on the screen.

 **NOTE:** For information on restoring your operating system using the system recovery media, see “System Recovery Media” on page 81.

# Install the SIM Card (Optional)

-  **NOTE:** Installing a SIM card is not required if you are using an EVDO card to access the Internet.
-  **NOTE:** Installing a mini B-CAS card into the SIM card slot is required to set up and view ISDB-T digital TV in Japan.

Installing a Subscriber Identity Module (SIM) card on your computer allows you to connect to the Internet. To access the Internet you must be within the network of your cellular service provider.

To install the SIM card:

1. Turn off your computer.
2. Remove the battery (see “Removing and Replacing the Battery” on page 52).
3. In the battery bay, slide the SIM card into the SIM card slot.
4. Replace the battery (see “Removing and Replacing the Battery” on page 52).
5. Turn on your computer.

To remove the SIM card, press and eject the SIM card.

## Setting Up Your XPS Laptop

- 1 SIM card
- 2 battery bay
- 3 SIM card slot

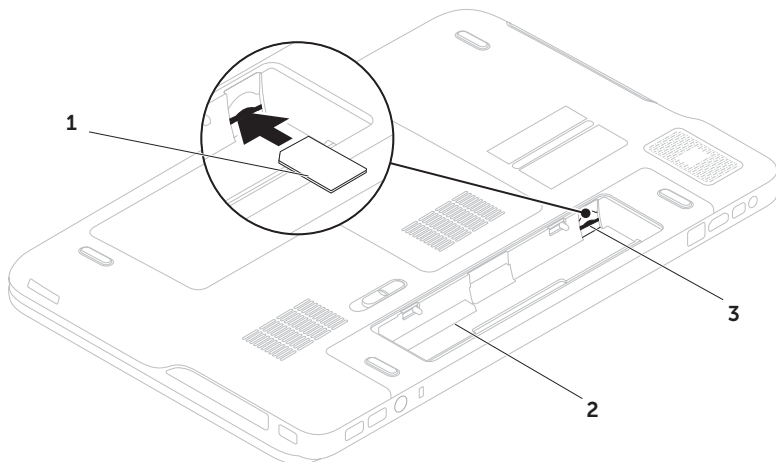

## Enable or Disable Wireless (Optional)

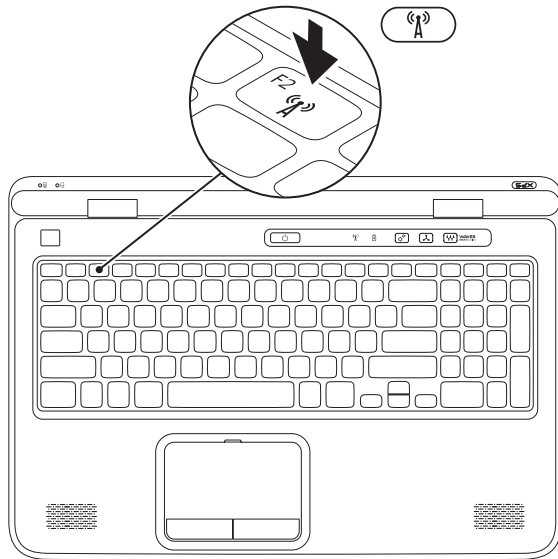

To enable or disable wireless:

1. Ensure that your computer is turned on.
2. Press the <Fn><F2> keys on the keyboard.  
The current status of the wireless radios appears on the screen.

Wireless enabled



Wireless disabled



3. Press the <Fn><F2> keys again to switch between the wireless enabled or disabled states.
-  **NOTE:** Pressing the <Fn><F2> keys allows you to quickly turn off wireless radios (Wi-Fi and Bluetooth), such as when you are asked to disable all wireless radios on an airplane flight.

# Set Up Wireless Display (Optional)

 **NOTE:** The wireless display feature may not be supported on all computers. For information about the hardware and software requirements for setting up wireless display, go to [www.intel.com](http://www.intel.com).

The Intel wireless display feature allows you to share your computer display to a TV without the use of cables. You must connect a wireless display adapter to your TV before setting up wireless display.

 **NOTE:** The wireless display adapter does not ship with your computer and must be purchased separately.

If your computer supports the wireless display feature, the Intel Wireless Display icon  will be available on the Windows desktop.

To set up wireless display:

1. Turn on your computer.
2. Ensure that wireless is enabled (see “Enable or Disable Wireless (Optional)” on page 16).
3. Connect the wireless display adapter to the TV.
4. Turn on the TV.
5. Select the appropriate video source for your TV, such as HDMI1, HDMI2, or S-Video.
6. Double-click the Intel Wireless Display icon  on the desktop. The **Intel Wireless Display** window appears.
7. Select **Scan for available displays**.
8. Select your wireless display adapter from the **Detected wireless displays** list.
9. Enter the security code that appears on your TV.

To enable wireless display:

1. Double-click the Intel Wireless Display icon  on the desktop.

The **Intel Wireless Display** window appears.

2. Select **Connect to Existing Adapter**.

 **NOTE:** You can download and install the latest driver for “Intel Wireless Display Connection Manager” from **support.dell.com**.

 **NOTE:** For more information about wireless display, see the wireless display adapter documentation.

## Set Up the TV Tuner (Optional)

 **NOTE:** Availability of the TV tuner may vary by region.

To set up the TV tuner:

1. If not already inserted, turn off the computer and insert the mini B-CAS card into the SIM card slot on your computer (Japan only).
2. Connect the TV/digital antenna cable or the cable adapter to the antenna-in connector on your computer.
3. Turn on your computer.
4. Click **Start**  → **All Programs** → **Windows Media Center** → **Tasks** → **Settings** → **TV**.
5. Follow the instructions on the screen.

## Set Up Stereoscopic 3D (Optional)

 **NOTE:** For information on using the NVIDIA 3D Vision glasses (optional), see the *NVIDIA 3D Vision User Guide* at [support.dell.com/manuals](http://support.dell.com/manuals).

Stereoscopic 3D allows you to view 3D content with visible depth.

1. Right-click the desktop and select **NVIDIA Control Panel**.
2. In the **NVIDIA Control Panel** window, click **Stereoscopic 3D** to expand the selection (if not already expanded) and then click **Setup Stereoscopic 3D**.
  - a. Select the **Enable stereoscopic 3D** check box.
  - b. From the **Stereoscopic 3D display type** drop-down menu select **Dell 3D Vision Laptop**.

 **NOTE:** If the **Stereoscopic 3D display type** section displays **3D TV Play**, your computer display will not support Stereoscopic 3D. You can view content in Stereoscopic 3D by connecting your computer to a 3DTV. For more information, see “Set Up 3D TV (Optional)” on page 21

- c. From the **Test stereoscopic 3D** drop-down menu select **Run Setup Wizard**. The Set up NVIDIA 3D Vision wizard appears.
3. Follow the instructions on the screen to complete the setup.

 **NOTE:** If you experience discomfort while viewing 3D display, stop viewing the display, remove your 3D glasses, and take rest.

## Set Up 3D TV (Optional)

-  **NOTE:** To know if your TV supports the 3D features available on your computer, see **System Requirements** at [www.nvidia.com/3dtv](http://www.nvidia.com/3dtv).

Connect your computer to the 3D TV using a HDMI cable.

-  **NOTE:** The HDMI cable transmits both audio and video signals.

1. Set up the HDMI 1.4 3D TV:
  - a. Browse to the TV's 3D settings menu.
  - b. Set the 3D mode to **Automatic**.
  - c. Set the eye order for the glasses to **default** or **normal**.



-  **NOTE:** Do not change the eye order settings when using NVIDIA 3DTV Play as the application controls the timing of the glasses.

-  **NOTE:** If you are unable to view the entire Windows desktop on your TV, use the 3D TV's settings to reduce the display

-  **NOTE:** For more information about configuring the 3D settings, see the documentation that shipped with your TV.

2. Set your TV as the primary display:
  - a. Right-click the desktop and select **NVIDIA Control Panel**.
  - b. In the **NVIDIA Control Panel** window, click **Display** to expand the selection (if not already expanded) and then click **Set up multiple display**.
  - c. In the **Verify the display configuration** section, right-click the 3D TV and select **Make this the Windows primary display**.

## Setting Up Your XPS Laptop

3. Set up the NVIDIA 3DTV Play application:
  - a. In the **NVIDIA Control Panel** window, click **Stereoscopic 3D** to expand the selection (if not already expanded) and then click **Set up stereoscopic 3D**.
  - b. Select the **Enable stereoscopic 3D** check box. The 3DTV Play setup wizard appears.
  - c. Ensure that the 3DTV Play logo appears in the control panel.
4. Change the desktop resolution to match the resolution of the 3D content type:
  - a. In the **NVIDIA Control Panel** window, click **Display** to expand the selection (if not already expanded) and then click **Change resolution**.
  - b. For 3D gaming, set the resolution to **720p, 1280x720** and refresh rate to **60/59 Hz** in HD 3D mode.
    - c. For Blu-ray 3D playback, set the resolution to **1080p, 1920x1080** and refresh rate to **24/23 Hz** in HD 3D mode.
      -  **NOTE:** For TVs using PAL system with refresh rates of 50 Hz or 100 Hz or NTSC system with refresh rates of 60 Hz or 120 Hz, set the resolution to **720p** and refresh rate to **60/59 Hz**.
      -  **NOTE:** The performance of games may reduce in HD 3D mode even if 3DTV Play is disabled. To maximize performance, select HD or SD mode when 3DTV Play is disabled.
5. Check the HDMI audio on the TV by playing a video, game, or music and adjusting the volume on the TV.
  -  **NOTE:** For more information on 3D TV, see "NVIDIA 3DTV Play" on page 57.

## Connect to the Internet (Optional)

To connect to the Internet, you need an external modem or network connection and an Internet Service Provider (ISP).

If an external USB modem or WLAN adapter is not a part of your original order, you can purchase one from **dell.com**.

### Setting Up a Wired Connection

- If you are using a dial-up connection, connect the telephone line to the optional external USB modem and to the telephone wall connector before you set up your Internet connection.
- If you are using a DSL or cable/satellite modem connection, contact your ISP or cellular telephone service for setup instructions.

To complete setting up your wired Internet connection, follow the instructions in "Setting Up Your Internet Connection" on page 24.

[Downloaded from LpManual.com Manuals](http://LpManual.com/Manuals)

## Setting Up a Wireless Connection

 **NOTE:** To set up your wireless router, see the documentation that shipped with your router.

Before you can use your wireless Internet connection, you need to connect to your wireless router.

To set up your connection to a wireless router:

1. Ensure that wireless is enabled on your computer (see "Enable or Disable Wireless (Optional)" on page 16).
2. Save and close any open files, and exit any open programs.
3. Click **Start**  → **Control Panel**.
4. In the search box, type `network`, and then click **Network and Sharing Center** → **Connect to a network**.
5. Follow the instructions on the screen to complete the setup.

### Setting Up Your Internet Connection

ISPs and ISP offerings vary by country. Contact your ISP for offerings available in your country.

If you cannot connect to the Internet but have successfully connected in the past, the ISP might have a service outage. Contact your ISP to check the service status, or try connecting again later.

Have your ISP information ready. If you do not have an ISP, the **Connect to the Internet** wizard can help you get one.

To set up your Internet connection:

1. Save and close any open files, and exit any open programs.
2. Click **Start**  → **Control Panel**.
3. In the search box, type `network`, and then click **Network and Sharing Center** → **Set up a new connection or network** → **Connect to the Internet**.

The **Connect to the Internet** window appears.

-  **NOTE:** If you do not know which type of connection to select, click **Help me choose** or contact your ISP.
4. Follow the instructions on the screen and use the setup information provided by your ISP to complete the setup.



# Using Your XPS Laptop

This section provides information about the features available on your Dell XPS laptop.

## Right View Features

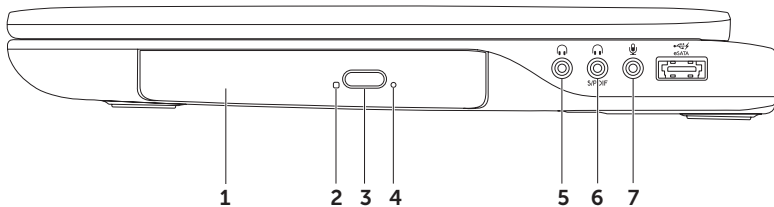

- 
- 1 Optical drive** – Plays or records CDs, DVDs, and Blu-ray Discs (optional). For more information, see “Using the Optical Drive” on page 46.

---

  - 2 Optical drive light** – Blinks when you press the optical drive eject button or when you insert a disc and it is being read.

---

  - 3 Optical drive eject button** – Opens the optical drive tray when pressed.

---

  - 4 Emergency eject hole** – Use to open the optical drive tray if it does not open when you press the eject button. For more information, see “Using the Emergency Eject Hole” on page 46.
- 

**5**  **Audio-out/Headphone connector** – Connects to a pair of headphones or to a powered speaker or sound system.

---

**6**  **Headphone/digital S/PDIF combo connector** – Connects to amplifiers, speakers, or TVs for digital audio output. Can also be used to connect to a pair of headphones.

**NOTE:** You must use a S/PDIF (mini-TOSLINK) adapter to connect a S/PDIF cable. The S/PDIF (mini-TOSLINK) adapter does not ship with your computer and must be purchased separately.

---

**7**  **Audio-in/Microphone connector** – Connects to a microphone or inputs signal for use with audio programs.

---

 **NOTE:** You can set up 5.1 channel speakers by using the three audio connectors (5, 6, and 7) or by using the S/PDIF connector (6).

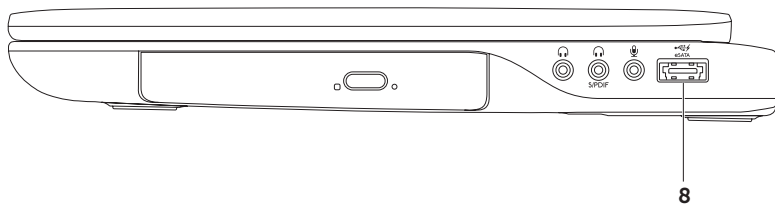

- 
- 8  **eSATA/USB combo connector with USB PowerShare** — Connects to eSATA compatible storage devices (such as external hard drives or optical drives) or USB devices (such as a mouse, keyboard, printer, external drive, or MP3 player). The USB PowerShare feature allows you to charge USB devices when the computer is powered on/off or in sleep state.

**NOTE:** Certain USB devices may not charge when the computer is powered off or in sleep state. In such cases, turn on the computer to charge the device.

**NOTE:** If you turn off your computer while charging a USB device, the device stops charging. To continue charging, disconnect the USB device and connect it again.

**NOTE:** The USB PowerShare feature is automatically shut off when only 10% of the total battery life remains.

---

## Left View Features

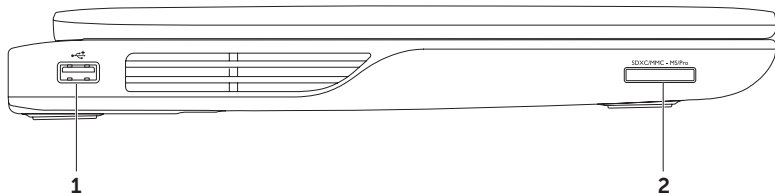

---

1  **USB 2.0 connector** — Connects to USB devices, such as a mouse, keyboard, printer, external drive, or MP3 player.

---

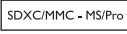
2  **9-in-1 Media Card Reader** — Provides a fast and convenient way to view and share digital photos, music, videos, and documents stored on memory cards. For the supported memory cards, see “Specifications” on page 94.

**NOTE:** Your computer ships with a plastic blank installed in the media card slot. Blanks protect unused slots from dust and other particles. Save the blank for use when no media card is installed in the slot; blanks from other computers may not fit your computer.

---

## Back View Features

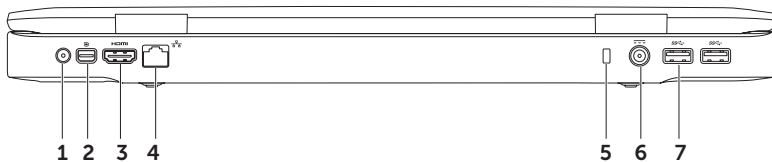

- 
- 1 Antenna-in connector (on supported models)** – Connects to an external antenna (included) or coaxial cable (adapter included) to view programs using the TV tuner card (optional).

---

  -  **Mini-DisplayPort connector** – Digital interface standard connector that connects to external DisplayPort monitors and projectors.

---

  -  **HDMI connector** – Connects to a TV for both 5.1 audio and video signals.  
**NOTE:** When used with a monitor, only the video signal is read.

---

  -  **Network connector** – Connects your computer to a network or a broadband device if you are using a wired network.

---

  - 5 Security cable slot** – Attaches a commercially available security cable to the computer.  
**NOTE:** Before you buy a security cable, ensure that it fits into the security cable slot on your computer.

---







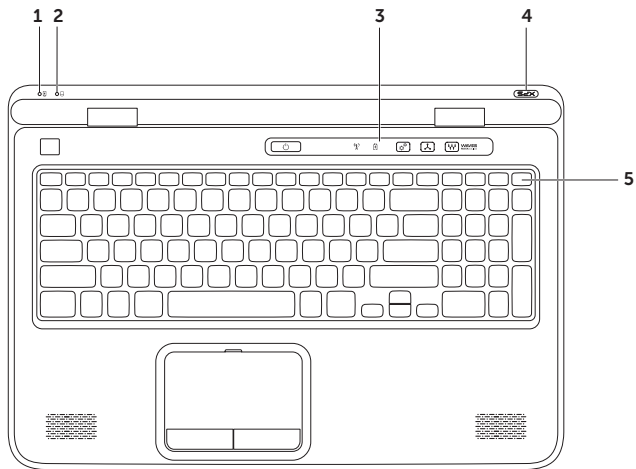

  -  **AC adapter connector** – Connects to the AC adapter to power the computer and charge the battery.

---

  -  **USB 3.0 connectors (2)** – Connect to USB devices, such as a mouse, keyboard, printer, external drive, or MP3 player. Provide faster data transmission between your computer and USB devices.
-

## Computer Base and Keyboard Features



- 
-  **Battery status light** — Indicates the battery charge status. For more information on the battery status light, see “Status Lights and Indicators” on page 38.
- 
-  **Hard drive activity light** — Turns on when the computer reads or writes data. A solid white light indicates hard drive activity.  
 **CAUTION: To avoid loss of data, never turn off the computer when the hard drive activity light is on.**
- 
- Control strip** — The power button, status lights, and touch-sensitive controls are located in this strip. For more information on the control strip, see “Control Strip Features” on page 44.
- 
- XPS logo light** — The light on the XPS logo indicates the power states. For more information on the logo light, see “Status Lights and Indicators” on page 38.
- 
- Function key row** — The dual display enable or disable key , wireless enable or disable key , brightness increase  and decrease  keys, touch pad enable or disable key , and the multimedia keys are located in this row.  
For more information on the multimedia keys, see “Multimedia Control Keys” on page 42.
-

## Using Your XPS Laptop

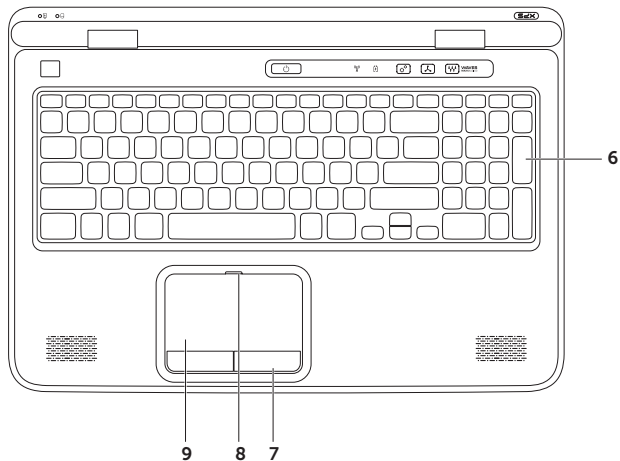

---

**6 Keyboard/Backlit Keyboard (optional)** — If you have purchased the optional backlit keyboard, the F6 key has the backlit keyboard icon  on it. The optional backlit keyboard provides visibility in dark environments by illuminating all symbols on the keys.

 **Backlit keyboard brightness settings** — Press the <Fn><F6> keys to toggle the three lighting states (in the given order):

- half keyboard brightness
- full keyboard brightness
- no lighting

---

**7 Touch pad buttons (2)** — Provide left-click and right-click functions like those on a mouse.

---

**8 Touch pad status light** — Turns on if the touch pad is disabled.

---

**9 Touch pad** — Provides the functionality of a mouse to move the cursor, drag or move selected items, and left-click by tapping the surface.

The touch pad supports the **Scroll**, **Flick**, **Zoom**, and **Rotate** features. To change the touch pad settings, double-click the **Synaptics Pointing Device** icon in the notification area of your desktop. For more information, see “Touch Pad Gestures” on page 40.

**NOTE:** To enable or disable the touch pad, press the <Fn><F3> keys on the keyboard.

---

## Status Lights and Indicators

### Battery Status Light

|                   | Indicator light status | Computer state(s)            | Battery charge status |
|-------------------|------------------------|------------------------------|-----------------------|
| <b>AC adapter</b> | solid white            | on/standby/off/<br>hibernate | charging              |
|                   | off                    | on/standby/off/<br>hibernate | fully charged         |
| <b>Battery</b>    | solid amber            | on/standby                   | low battery (<= 10%)  |
|                   | off                    | on/standby/off/<br>hibernate | not charging          |

### Power Button Light or XPS Logo Light

| Indicator light status | Computer state(s) |
|------------------------|-------------------|
| solid white            | on                |
| breathing white        | standby           |
| off                    | off/hibernate     |

 **NOTE:** For information on power problems, see “Power Problems” on page 66.

## Disabling Battery Charging

You may be required to disable the battery charging feature while on an airplane flight. To quickly disable the battery charging feature:

1. Ensure that your computer is turned on.
2. Click **Start** .
3. In the search box, type `Power Options` and press <Enter>.
4. In the **Power Options** window, click **Dell Battery Meter**.
5. In the **Battery Settings** window, click **Turn off Battery Charging** and then click **OK**.

 **NOTE:** Battery charging can also be disabled in the System Setup (BIOS) utility.

## Touch Pad Gestures

### Scroll

Allows you to scroll through content. The scroll feature includes:

**Scroll Vertical** — Allows you to scroll up or down on the active window.

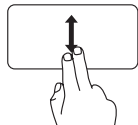

Move two fingers up or down to scroll the selected object.

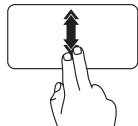

Move two fingers up or down at a fast pace to activate vertical auto scrolling.

Tap on the touch pad to stop auto scrolling

**Scroll Horizontal** — Allows you to scroll left or right on the active window.

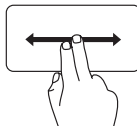

Move two fingers left or right to scroll the selected object.

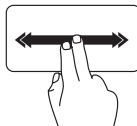

Move two fingers left or right at a fast pace to activate horizontal auto scrolling.

Tap on the touch pad to stop auto scrolling

### Flick

Allows you to flip content forward or backward based on the direction of the flick.

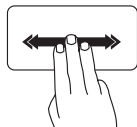

Move three fingers quickly in the desired direction to flip content in the active window.

## Zoom

Allows you to increase or decrease the magnification of the screen content. The zoom feature includes:

**Pinch** — Allows you to zoom-in or zoom-out by moving two fingers apart or bringing them closer together on the touch pad.

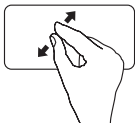

To zoom in:  
Move two fingers apart to enlarge the view of the active window.

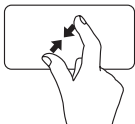

To zoom out:  
Move two fingers close together to reduce the view of the active window.

## Rotate

Allows you to rotate the active content on the screen. The rotate feature includes:

**Twist** — Allows you to rotate the active content using two fingers where one finger is anchored and the other rotates.



Keeping the thumb in place, move the index finger in an arced direction right or left to rotate the selected item clockwise or counterclockwise.

## Multimedia Control Keys

The multimedia control keys are located on the function key row on the keyboard. To use the multimedia controls, press the required key. You can configure the multimedia control keys using the **System Setup** (BIOS) utility or **Windows Mobility Center**.

### System Setup

1. Press <F2> during POST (Power On Self Test) to enter the System Setup (BIOS) utility.
2. In the **Function Key Behavior**, select **Multimedia Key First** or **Function Key First**.

**Function Key First** — This is the default option. Press any function key to perform the associated function. For multimedia action, press <Fn> + the required multimedia key.

**Multimedia Key First** — Press any multimedia key to perform the associated multimedia action. For function, press <Fn> + the required function key.

 **NOTE:** The **Multimedia Key First** option is active only in the operating system.

### Windows Mobility Center

1. Press the <Windows><X> keys or touch the Windows Mobility Center control  on the control strip to launch Windows Mobility Center.
2. In the **Function Key Row**, select **Function Key** or **Multimedia Key**.



---

 Play the previous track or chapter

---

 Play or pause

---

 Play the next track or chapter

---

---

 Decrease the volume level

---

 Increase the volume level

---

 Mute the sound

---

## Control Strip Features

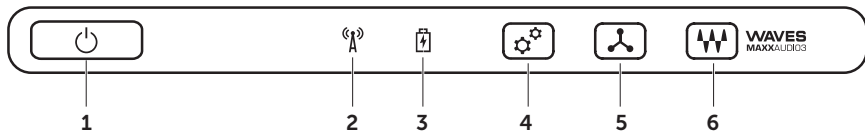

- 
- 1  **Power button and light** — Turns the computer on or off when pressed. The light on the button indicates the power states. For more information on the power button light, see “Status Lights and Indicators” on page 38.

---

  - 2  **Wireless status light** — Turns on if wireless is enabled. For more information, see “Enable or Disable Wireless (Optional)” on page 16.

---

  - 3  **Battery status light** — Indicates the battery charge status. For more information on the battery status light, see “Status Lights and Indicators” on page 38.  
**NOTE:** The battery is charging when the computer is powered using the AC adapter.

---

  - 4  **Windows Mobility Center control** — Touch to launch the Windows Mobility Center.

---

  - 5  **Instant launch control** — Touch to launch a predefined application of your choice.

---

  - 6  **Audio control-panel control** — Touch to launch the **Dell Audio** control panel. The control panel allows you to setup studio-quality audio output on your computer. You can also change the audio settings such as volume, external speaker setup, and microphone setup.
-

## Using the Optical Drive

 **CAUTION:** Do not press down on the optical drive tray when you open or close it. Keep the optical drive tray closed when you are not using the drive.

 **CAUTION:** Do not move the computer while playing or recording a disc.

The optical drive plays or records CDs, DVDs, and Blu-ray Discs (optional). Ensure that the side with print or writing is facing upward when placing discs on the optical drive tray.

To place a disc in the optical drive:

1. Press the eject button on the optical drive.
2. Pull out the optical drive tray.
3. Place the disc, label-side up, in the center of the optical drive tray and snap the disc onto the spindle.
4. Push the optical drive tray back into the drive.

## Using the Emergency Eject Hole

If the optical drive tray does not eject when you press the eject button, you can use the emergency eject hole to open the drive tray. To open the drive tray using the emergency eject hole:

1. Turn off the computer.
2. Insert a small pin or unfolded paper clip into the emergency eject hole and push firmly until the drive tray opens.

- 
- 1 disc

---

  - 2 spindle

---

  - 3 optical drive tray

---

  - 4 emergency eject hole

---

  - 5 eject button

---

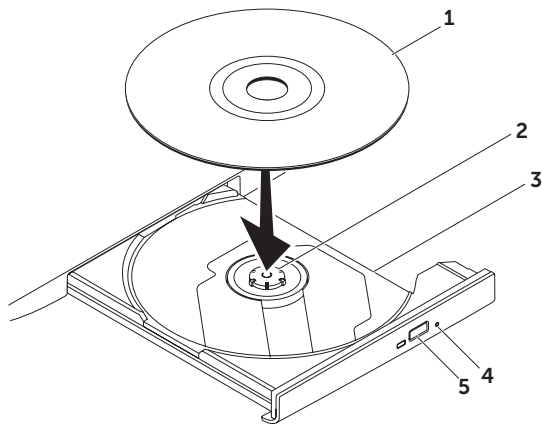

## Display Features

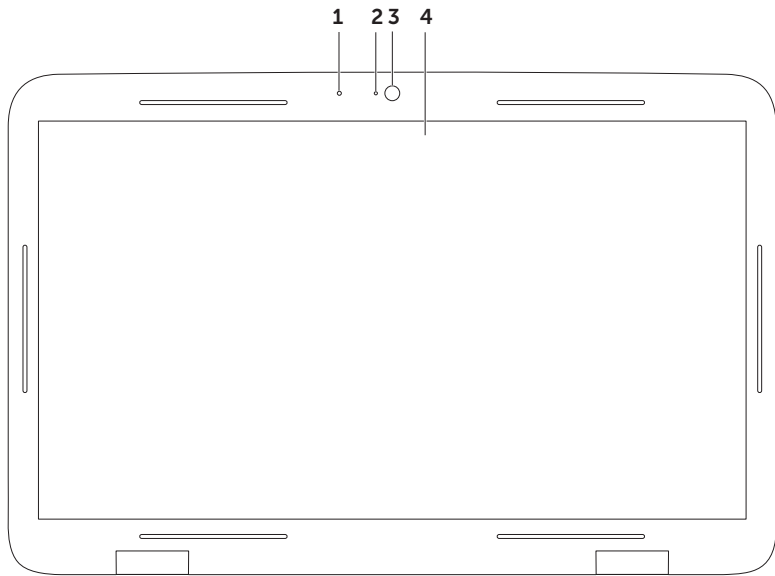

- 
- 1 **Microphone** — Provides high quality sound for video conferencing and voice recording.

---

  - 2 **Camera indicator light** — Indicates if the camera is on or off.

---

  - 3 **Camera** — Built-in camera for video capture, conferencing, and chat. The camera supports the H.264 video compression codec, which provides high quality video at low data transmission rates.

---

  - 4 **Display** — Your display can vary based on selections you made when purchasing your computer. The display may support the touch screen feature if you selected the option at the time of purchase. For information on the touch screen features, see “Touch Screen Gestures (Optional)” on page 50.
-

## Touch Screen Gestures (Optional)

 **NOTE:** Some of these gestures are application-specific and may not work across applications.

### Zoom

Allows you to increase or decrease the magnification of the screen content.

**Pinch** — Allows you to zoom-in or zoom-out by moving two fingers apart or bringing them closer together on the screen.



To zoom in:  
Move two fingers apart to enlarge the view of the active window.



To zoom out:  
Move two fingers close together to reduce the view of the active window.

### Dwell

Allows you to access additional information by simulating a right-click.

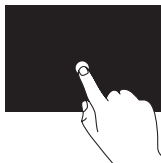

Press and hold a finger on the touch screen, to open context-sensitive menus.

### Flick

Allows you to flip content forward or backward based on the direction of the flick.

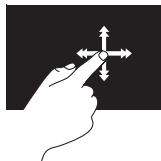

Move a finger quickly in the desired direction to flip through content in the active window like pages in a book. Flick also works vertically when navigating content such as images or songs in a playlist.

## Scroll

Allows you to scroll through content. The scroll features include:

**Pan** — Allows you to move the focus on the selected object when the entire object is not visible.

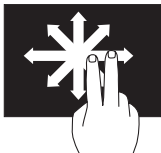

Move two fingers in the desired direction to pan scroll the selected object.

**Scroll Vertical** — Allows you to scroll up or scroll down on the active window.

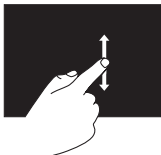

Move a finger up or down to activate vertical scrolling.

**Scroll Horizontal** — Allows you to scroll right or left on the active window.

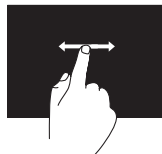

Move a finger to the right or left to activate horizontal scrolling.

## Rotate

Allows you to rotate the active content on the screen.

**Twist** — Allows you to rotate the active content using two fingers.



Keeping a finger or thumb in place, move the other finger in an arced direction right or left. You can also rotate the active content by moving both the fingers in a circular motion.

## Removing and Replacing the Battery

 **WARNING:** Before you begin any of the procedures in this section, follow the safety instructions that shipped with your computer.

 **WARNING:** Using an incompatible battery may increase the risk of fire or explosion. This computer should only use a battery purchased from Dell. Do not use batteries from other computers.

 **WARNING:** Before removing the battery, shut down the computer, and remove external cables (including the AC adapter).

To remove the battery:

1. Turn off the computer and turn it over.
2. Slide the battery release latch to the side.
3. Lift the battery up at an angle and remove it from the battery bay.

To replace the battery:

1. Align the tabs on the battery with the slots on the battery bay.
2. Press the battery down until the battery release latch clicks.

- 1 battery release latch
- 2 battery
- 3 tabs (3)

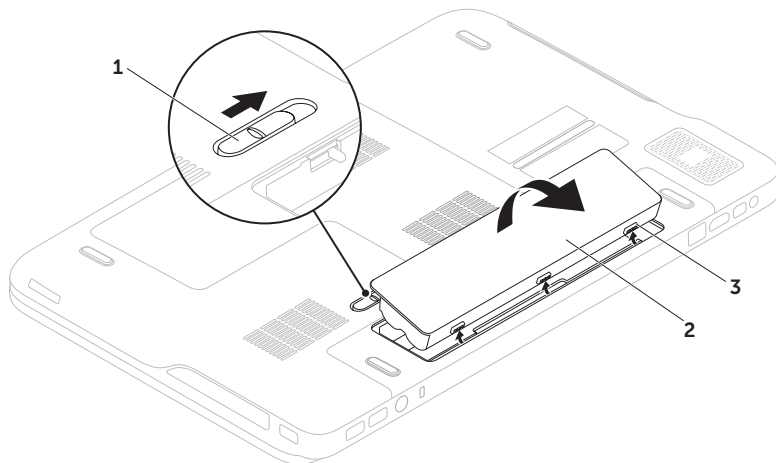

## Software Features

### FastAccess Facial Recognition

Your computer may have the FastAccess facial recognition feature. This feature helps keep your Dell computer secure by learning the unique appearance of your face and uses this to verify your identity to automatically supply login information when you would normally enter this information yourself (such as for logging on to a Windows account or secure websites). For more information, click

**Start**  → **All Programs** → **FastAccess**.

### Productivity and Communication

You can use your computer to create presentations, brochures, greeting cards, fliers, and spreadsheets. You can also edit and view digital photographs and images. Check your purchase order for software installed on your computer.

After connecting to the Internet, you can access websites, setup an e-mail account, and upload or download files.

## Entertainment and Multimedia

You can use your computer to watch videos, play games, create your own CDs/DVDs, listen to music and Internet radio stations.

You can download or copy pictures and video files from portable devices, such as digital cameras and cell phones. Optional software applications enable you to organize and create music and video files that can be recorded to disc, saved on portable products such as MP3 players and handheld entertainment devices, or played and viewed directly on connected TVs, projectors, and home theater equipment.

## Dell DataSafe Online Backup

 **NOTE:** Dell DataSafe Online is supported only on Windows operating systems.

 **NOTE:** A broadband connection is recommended for fast upload/download speeds.

Dell DataSafe Online is an automated backup and recovery service that helps protect your data and other important files from catastrophic incidents like theft, fire, or natural disasters. You can access the service on your computer using a password-protected account.

For more information, go to **DellDataSafe.com**.

To schedule backups:

1. Double-click the Dell DataSafe Online icon  in the notification area of your desktop.
2. Follow the instructions on the screen.

# NVIDIA Optimus Technology (Optional)

Your XPS laptop is equipped with NVIDIA's Optimus technology. The Optimus technology enhances the performance of your computer, while minimizing the impact on battery life. It enables you to combine the graphic processing capability of the integrated Intel graphic processing unit (GPU) with the discrete NVIDIA GPU while running graphic-intensive applications such as 3D games. The NVIDIA GPU is turned on only for preset applications and thus extends the battery life. The Optimus technology is enabled through an application profile. When an application is launched, the video drivers check if the application has an associated application profile.

- If an application profile exists, the NVIDIA GPU is enabled and the application runs in performance mode. The NVIDIA GPU is disabled automatically when the application is closed.
- If an application profile does not exist, only the integrated Intel GPU is used.

The default list of application profiles is updated frequently by NVIDIA and is automatically downloaded to your computer when you are connected to the Internet.

You can also create application profiles for any application on your computer. This may be required for newly released games or applications that do not have a default application profile.

## Changing the Application Profile Settings

1. Right-click the desktop and select **NVIDIA Control Panel**.
2. In the **NVIDIA Control Panel** window, click **3D Settings** to expand the selection (if not already expanded) and then click **Manage 3D Settings**.
3. In the **Program Settings** tab, click **Add** and browse to select the application's executable file (**.exe**). Once added, you can change the settings for that application.

To change the settings for a specific application, select the application in the **Select a program to customize:** list and make the desired changes.

-  **NOTE:** For more information on the NVIDIA control panel's options and settings, click **Help**.

## NVIDIA 3DTV Play

The NVIDIA 3DTV Play application installed on your computer allows you to play 3D games, watch Blu-ray 3D videos, and browse 3D photos.

-  **NOTE:** For information on using the NVIDIA 3D Vision glasses (optional), see the *NVIDIA 3D Vision User Guide* at [support.dell.com/manuals](http://support.dell.com/manuals).

## 3D Games

The NVIDIA 3DTV Play application supports the same games as NVIDIA 3D Vision.

-  **NOTE:** For a list of supported 3D games, go to [www.nvidia.com](http://www.nvidia.com).

## Playing Games in 3D

1. Launch the game in full-screen mode.
2. If you see a message stating that the current mode is not HDMI 1.4 compatible, set the in-game resolution to **720p**, **1280x720** in HD 3D mode.

## Using Your XPS Laptop

### Keyboard Shortcuts

The following are some of the keyboard shortcuts available for 3D gaming:

| Keys                | Description                             | Function   |
|---------------------|---|--|
| <Ctrl><t>           | Show/hide stereoscopic 3D effects       | Turns 3DTV Play on/off.<br><b>NOTE:</b> The gaming performance may reduce when using HD 3D mode even if 3DTV Play is disabled. To maximize performance, select HD or SD mode when 3DTV Play is disabled. |
| <Ctrl><F4>          | Increases 3D depth                      | Increases the 3D depth real-time in the current game.  |
| <Ctrl><F3>          | Decreases 3D depth                      | Decreases the 3D depth real-time in the current game.  |
| <Ctrl><F11>         |   | Captures a 3D screenshot of the current game, and saves the file in the <b>My Documents\NVSteroscopic3D.IMG</b> folder. To view the file, use the NVIDIA 3D Photo Viewer.                                |
| <Ctrl><Alt><Insert> | Show/hide in-game compatibility message | Displays the settings recommended by NVIDIA for the current game.  |

---

|            |                       |  |
|------------|-----------------------|--|
| <Ctrl><F6> | Increases convergence | Moves objects towards you; maximum convergence places all objects in front of the scene in your space; also used to place the laser sight. |
| <Ctrl><F5> | Decreases convergence | Moves objects away from you; minimum convergence places all objects behind the scene in your space; also used to place the laser sight.    |

---

### Customizing Shortcut Keys

To customize the keyboard shortcuts:

1. Right-click the desktop and select **NVIDIA Control Panel**.
2. In the **NVIDIA Control Panel** window, click **Stereoscopic 3D** to expand the selection (if not already expanded) and then click **Set keyboard shortcuts**.
3. Click the box displaying the shortcut you want to change.
4. Press the desired key combination.
5. Click **OK** to save and exit.

### 3D Photos

You can view stereoscopic 3D photos using the NVIDIA Photo Viewer available in the NVIDIA 3DTV Play application. The photo viewer also allows you to edit the 3D effects on the photo.

 **NOTE:** For more information on using the photo viewer and to download 3D photos, go to [www.nvidia.com](http://www.nvidia.com).

### Blu-ray 3D

The NVIDIA 3DTV Play application allows you to watch Blu-ray 3D videos at 1080p resolution. For 3D Blu-ray playback, set the resolution to **1080p, 1920x1080** and refresh rate to **24/23 Hz** in HD 3D mode. To watch Blu-ray 3D videos, use the CyberLink PowerDVD application installed on your computer. The CyberLink PowerDVD application detects your 3D TV automatically.

 **NOTE:** For more information on the CyberLink PowerDVD's configuration options and settings, click **Help** within the application.

 **NOTE:** For more information about using Blu-ray 3D, go to [www.nvidia.com](http://www.nvidia.com).

 **NOTE:** To see knowledge base articles and frequently asked questions, go to [support.nvidia.com](http://support.nvidia.com).

## Dell Stage

The Dell Stage software provides access to your favorite media and multi-touch applications.

To launch Dell Stage, click **Start**  → **All Programs** → **Dell Stage** → **Dell Stage**.

 **NOTE:** Some of the applications on Dell Stage can also be launched from the **All Programs** menu.

You can customize Dell Stage as follows:

- Rearrange an application shortcut — Select and hold the application shortcut until it blinks and then drag the application shortcut to a desired location on Dell Stage.
- Minimize — Drag the Dell Stage window to the bottom of the screen.
- Personalize — Select the settings icon and then choose the desired option.

The following are the applications available on Dell Stage:

- **NOTE:** Some of the applications may not be available based on the selections you made while purchasing your computer.
- **MUSIC** — Play music or browse through your music files by album, artist, or song title. You can also listen to radio stations from across the globe. The optional Napster application allows you to download songs when connected to the Internet.
- **YOU PAINT** — Draw and edit pictures.
- **GAMES** — Play touch-enabled games.
- **DOCUMENTS** — Provides quick access to the Documents folder on your computer.
- **PHOTO** — View, organize, or edit your pictures. You can create slideshows and collections of your pictures and upload them to **Facebook** or **Flickr** when connected to the Internet.

## Using Your XPS Laptop

- **DELL WEB** — Provides a preview of up to four of your favorite web pages. Click or tap the web page preview to open it in the web browser.
- **VIDEO** — View videos. The optional CinemaNow application allows you to purchase or rent movies and TV shows when connected to the Internet.
- **SHORTCUTS** — Provides quick access to your frequently-used programs.
- **STICKYNOTES** — Create notes or reminders using the keyboard or touch screen. These notes will appear on the bulletin board the next time you access STICKYNOTES. You can also save notes on your desktop.
- **Web Tile** — Provides a preview of up to four of your favorite web pages. The tile allows you to add, edit, or delete a web page preview. Click or tap the web page preview to open it in the web browser. You can also create multiple Web Tiles through the Apps Gallery.

## Free Fall Sensor

Free fall sensor protects your computer hard drive from possible damage, by detecting a free fall state caused by accidentally dropping the computer. When a free fall state is detected, the hard drive is placed in a *safe state* to protect against damage to the read/write head and possible data loss. Your hard drive returns to normal operation, when the free fall state is no longer detected.

# Solving Problems

This section provides troubleshooting information for your computer. If you cannot solve your problem using the following guidelines, see “Using Support Tools” on page 70 or “Contacting Dell” on page 91.

 **WARNING: Only trained service personnel should remove the computer cover. See the *Service Manual* at [support.dell.com/manuals](http://support.dell.com/manuals) for advanced service instructions.**

## Beep Codes



Your computer might emit a series of beeps during start-up if there are errors or problems. This series of beeps, called a beep code, identifies a problem. If this occurs, write down the beep code and contact Dell (see “Contacting Dell” on page 91) for assistance.

 **NOTE:** To replace parts, see the *Service Manual* at [support.dell.com](http://support.dell.com).

| Beep Code | Possible Problem  |
|-----------|---|
| One       | Possible system board failure – BIOS ROM checksum failure   |
| Two       | No RAM detected<br><b>NOTE:</b> If you installed or replaced the memory module, ensure that the memory module is seated properly. |
| Three     | Possible system board failure – Chipset error   |
| Four      | RAM read/write failure  |
| Five      | Real Time Clock failure   |
| Six       | Video card or chip failure  |
| Seven     | Processor failure   |
| Eight     | Display failure   |

## Touch Screen Problems

**Some or all multi-touch features are not working** –

- Certain touch and multi-touch features may be disabled. To enable them, double-click the **Flicks** icon  in the notification area of your desktop. In the **Pen and Touch** window, select the **Touch** tab and ensure that **Use your finger as an input device** and **Enable multi-touch gestures and inking** options are selected.
- The multi-touch feature may not be supported by the application.
- The touch screen is calibrated at the factory, and does not require re-calibration. If you choose to calibrate the touch screen, click **Start**  → **Control panel** → **Hardware and Sound** → **Tablet PC Settings** → **Calibrate...**

 **NOTE:** Improper calibration may lead to inaccurate touch sensitivity.

**If the touch screen starts losing its**

**sensitivity** – The touch screen may have foreign particles (such as sticky notes) that are blocking the touch sensors. To remove these particles:

1. Turn off the computer.
2. Disconnect the AC adapter from the wall outlet.

 **CAUTION: Do not use water or a cleaning liquid to wipe the touch screen.**

3. Use a clean, lint-free cloth (can spray mild, non abrasive cleaner or water on cloth if needed, but not on the screen) and wipe the surface and sides of the touch screen to remove any dirt or fingerprints.

# Network Problems

## Wireless Connections

### **If the wireless network connection is lost —**

The wireless router is offline or wireless has been disabled on the computer.

- Check your wireless router to ensure it is powered on and connected to your data source (cable modem or network hub).
- Check if wireless is enabled on the computer (see "Enable or Disable Wireless (Optional)" on page 16).
- Re-establish your connection to the wireless router (see "Setting Up a Wireless Connection" on page 23).
- Interference may be blocking or interrupting your wireless connection. Try moving the computer closer to your wireless router.

## Wired Connections

### **If the wired network connection is lost —**

The network cable is loose or damaged.

- Check the network cable to ensure it is plugged in and not damaged.

# Power Problems

**If the power light is off** — The computer is either turned off, in hibernate mode, or is not receiving power.

- Press the power button. The computer resumes normal operation if it is off or in hibernate mode.
- Reseat the AC adapter cable into both the power connector on the computer and the electrical outlet.
- If the AC adapter cable is plugged into a power strip, ensure that the power strip is plugged into an electrical outlet and that the power strip is turned on. Also bypass power protection devices, power strips, and power extension cables to verify that the computer turns on properly.
- Ensure that the electrical outlet is working by testing it with another device, such as a lamp.

- Check the AC adapter cable connections. If the AC adapter has a light, ensure that the light on the AC adapter is on.

**If the power light is solid white and the computer is not responding** — The display may not be responding.

- Press the power button until the computer turns off and then turn it back on.
- If the problem persists, contact Dell (see “Contacting Dell” on page 91).

**If the power light is breathing white** — The computer is in standby or the display may not be responding.

- Press a key on the keyboard, move the connected mouse or a finger on the touch pad, or press the power button to resume normal operation.
- If the display is not responding, press the power button until the computer turns off and then turn it back on.
- If the problem persists, contact Dell (see “Contacting Dell” on page 91).

**If you encounter interference that hinders reception on your computer** — An unwanted signal is creating interference by interrupting or blocking other signals. Some possible causes of interference are:

- Power, keyboard, and mouse extension cables.
- Too many devices connected to a power strip.
- Multiple power strips connected to the same electrical outlet.

## Memory Problems

**If you receive an insufficient memory message** —

- Save and close any open files and exit any open programs you are not using to see if that resolves the problem.
- See the software documentation for minimum memory requirements. If necessary, install additional memory (see the *Service Manual* at [support.dell.com/manuals](http://support.dell.com/manuals)).
- Reseat the memory module(s) into the connector(s) (see the *Service Manual* at [support.dell.com/manuals](http://support.dell.com/manuals)).
- If the problem persists, contact Dell (see “Contacting Dell” on page 91).

**If you experience other memory problems** —

- Run Dell Diagnostics (see “Dell Diagnostics” on page 72).
- If the problem persists, contact Dell (see “Contacting Dell” on page 91).

## Lockups and Software Problems

**If the computer does not start up** — Ensure that the AC adapter cable is firmly connected to the computer and to the electrical outlet.

**If a program stops responding** —

End the program:

1. Press <Ctrl><Shift><Esc> simultaneously.
2. Click **Applications**.
3. Select the program that is no longer responding
4. Click **End Task**.

**If a program crashes repeatedly** — Check the software documentation. If necessary, uninstall and then reinstall the program.

 **NOTE:** Software usually includes installation instructions in its documentation or on the CD.

**If a program is designed for an earlier Microsoft Windows operating system** —

Run the Program Compatibility Wizard. The Program Compatibility Wizard configures a program so that it runs in an environment similar to an earlier version of Microsoft Windows operating system.

To run the Program Compatibility Wizard:

1. Click **Start**  → **Control Panel** → **Programs** → **Run programs made for previous versions of Windows**.
2. In the welcome screen, click **Next**.
3. Follow the instructions on the screen.

**If the computer stops responding or a solid blue screen appears —**

 **CAUTION: You might lose data if you are unable to perform an operating system shutdown.**

If you are unable to get a response by pressing a key on your keyboard, or by moving your mouse, press the power button for at least 8 to 10 seconds until the computer turns off and then restart your computer.

**If you have other software problems —**

- Back up your files immediately.
- Use a virus-scanning program to check the hard drive or CDs.
- Save and close any open files or programs and shut down your computer through the **Start**  menu.

- Check the software documentation or contact the software manufacturer for troubleshooting information:
  - Ensure that the program is compatible with the operating system installed on your computer.
  - Ensure that your computer meets the minimum hardware requirements needed to run the software. See the software documentation for information.
  - Ensure that the program is installed and configured properly.
  - Verify that the device drivers do not conflict with the program.
  - If necessary, uninstall and then reinstall the program.
  - Write down any error message that is displayed to help in troubleshooting when contacting Dell.

# Using Support Tools

## Dell Support Center

**All the support you need – one convenient location.**

The **Dell Support Center** provides system alerts, performance improvement offers, system information, and links to other Dell tools and diagnostic services.

To launch the application, click **Start**  → **All Programs** → **Dell** → **Dell Support Center** → **Launch Dell Support Center**.

The **Dell Support Center** home page displays your computer's model number, service tag, express service code, warranty status, and alerts on improving the performance of your computer.

The home page also provides links to access:

**PC Checkup** — Run hardware diagnostics, see which program occupies the maximum memory on your hard drive, and track the changes made to your computer each day.

### PC Checkup Utilities

- **Drive Space Manager** — Manage your hard drive using a visual representation of the space consumed by each type of file.
- **Performance and Configuration History** — Monitor system events and changes over time. This utility displays all hardware scans, tests, system changes, critical events and restoration points on the day they occurred.

**Detailed System Information** — View detailed information about your hardware and operating system configurations; access copies of your service contracts, warranty information, and warranty renewal options.

**Get Help** — View Dell Technical Support options, Customer Support, Tours and Training, Online Tools, Owner's Manual, Warranty Information, FAQs, and so on.

**Backup and Recovery** — Create recovery media, launch recovery tool, and online file backup.

### **System Performance Improvement**

**Offers**— Acquire software and hardware solutions that will help improve your system performance.

For more information about **Dell Support Center** and to download and install the available support tools, go to **DellSupportCenter.com**.

## My Dell Downloads

 **NOTE:** My Dell Downloads may not be available in all regions.

Some of the software pre-installed on your new Dell computer do not include a backup CD or DVD. This software is available on the My Dell Downloads website. From this website you can download available software for reinstallation or create your own backup media.

To register and use My Dell Downloads:

1. Go to **DownloadStore.dell.com/media**.
2. Follow the instructions on the screen to register and download the software.
3. Reinstall the software or create a backup media for future use.

### Hardware Troubleshooter

If a device is either not detected during the operating system setup or is detected but incorrectly configured, you can use the **Hardware Troubleshooter** to resolve the incompatibility.

To start the Hardware Troubleshooter:

1. Click **Start**  → **Help and Support**.
2. Type `hardware troubleshooter` in the search field and press <Enter> to start the search.
3. In the search results, select the option that best describes the problem and follow the remaining troubleshooting steps.

### Dell Diagnostics

If you experience a problem with your computer, perform the checks in “Lockups and Software Problems” on page 68 and run Dell Diagnostics before you contact Dell for technical assistance.

 **NOTE:** Dell Diagnostics works only on Dell computers.

 **NOTE:** The *Drivers and Utilities* disc may not ship with your computer.

Ensure that the device that you want to test is displayed in the system setup program and is active. Press <F2> during POST (Power On Self Test) to enter the System Setup (BIOS) utility.

Start Dell Diagnostics from your hard drive or from the *Drivers and Utilities* disc.

## Starting Dell Diagnostics From Your Hard Drive

Dell Diagnostics is located on a hidden diagnostic utility partition on your hard drive.

 **NOTE:** If your computer cannot display a screen image, contact Dell (see “Contacting Dell” on page 91) for assistance.

1. Ensure that the computer is connected to an electrical outlet that is known to be working properly.
2. Turn on (or restart) your computer.
3. When the DELL logo appears, press <F12> immediately. Select **Diagnostics** from the boot menu and press <Enter>. This may invoke the Pre-Boot System Assessment (PSA) on your computer.

 **NOTE:** If you wait too long and the operating system logo appears, continue to wait until you see the Microsoft Windows desktop; then, shut down your computer and try again.

 **NOTE:** If you see a message stating that no diagnostics utility partition has been found, run Dell Diagnostics from the *Drivers and Utilities* disc.

*If PSA is invoked:*

- a. The PSA will start running tests.
- b. If the PSA completes successfully, the following message appears :  
“No problems have been found with this system so far. Do you want to run the remaining memory tests? This will take about 30 minutes or more. Do you want to continue? (Recommended).”

## Using Support Tools

c. If you are experiencing memory issues, press <y>, otherwise press <n>. The following message appears: "Booting Dell Diagnostic Utility Partition. Press any key to continue."

d. Press any key to go to the **Choose An Option** window.

*If PSA is not invoked:*

Press any key to start Dell Diagnostics from the diagnostic utility partition on your hard drive and to go to the **Choose An Option** window.

4. Select the test you want to run.

5. If a problem is encountered during a test, a message with an error code and a description of the problem appears on your screen. Write down the error code and problem description and contact Dell (see "Contacting Dell" on page 91) for assistance.

 **NOTE:** The Service Tag for your computer is displayed at the top of each test screen. The Service Tag helps you identify your computer when you contact Dell.

6. When the tests complete, close the test screen to return to the **Choose An Option** window.

7. To exit Dell Diagnostics and restart the computer, click **Exit**.

## Starting Dell Diagnostics From the Drivers and Utilities Disc

 **NOTE:** The *Drivers and Utilities* disc may not ship with your computer.

1. Insert the *Drivers and Utilities* disc.
2. Shut down and restart the computer.  
When the DELL logo appears, press <F12> immediately.

 **NOTE:** If you wait too long and the operating system logo appears, continue to wait until you see the Microsoft Windows desktop; then, shut down your computer and try again.

 **NOTE:** The next steps change the boot sequence for one time only. On the next start-up, the computer boots according to the devices specified in the system setup program.

3. When the boot device list appears, highlight **CD/DVD/CD-RW** and press <Enter>.
4. Select the **Boot from CD-ROM** option from the menu that appears and press <Enter>.
5. Type 1 to start the CD menu and press <Enter> to proceed.
6. Select **Run the 32 Bit Dell Diagnostics** from the numbered list. If multiple versions are listed, select the version appropriate for your computer.
7. Select the test you want to run.

## Using Support Tools

8. If a problem is encountered during a test, a message with an error code and a description of the problem appears on your screen. Write down the error code and problem description and contact Dell (see "Contacting Dell" on page 91) for assistance.

 **NOTE:** The Service Tag for your computer is displayed at the top of each test screen. The Service Tag helps you identify your computer when you contact Dell.

9. When the tests complete, close the test screen to return to the **Choose An Option** window.
10. To exit Dell Diagnostics and restart the computer, click **Exit**.
11. Remove the *Drivers and Utilities* disc.

# Restoring Your Operating System

You can restore the operating system on your computer using any of the following options:

 **CAUTION:** Using Dell Factory Image Restore or the *Operating System* disc to restore your operating system permanently deletes all data files on your computer. If possible, backup your data files before using these options.

| Option                       | Use   |
|------------------------------|---|
| System Restore               | as the first solution   |
| Dell DataSafe Local Backup   | when System Restore does not resolve your problem   |
| System recovery media        | when operating system failure prevents the use of System Restore and DataSafe Local Backup<br>when installing the Dell factory-installed software on a newly installed hard drive |
| Dell Factory Image Restore   | to restore your computer to the operating state it was in when you received your computer   |
| <i>Operating System</i> disc | to reinstall only the operating system on your computer   |

 **NOTE:** The *Operating System* disc may not ship with your computer.

# System Restore

The Microsoft Windows operating systems provide a System Restore option which allows you to return your computer to an earlier operating state (without affecting data files) if changes to the hardware, software, or other system settings have left the computer in an undesirable operating state. Any changes that System Restore makes to your computer are completely reversible.

 **CAUTION:** Make regular backups of your data files. System Restore does not monitor your data files or recover them.

## Starting System Restore

1. Click **Start** .
2. In the search box, type `System Restore` and press <Enter>.

 **NOTE:** The **User Account Control** window may appear. If you are an administrator on the computer, click **Continue**; otherwise, contact your administrator to continue the desired action.

3. Click **Next** and follow the instructions on the screen.

In the event that System Restore did not resolve the issue, you may undo the last system restore.

## Undoing the Last System Restore

 **NOTE:** Before you undo the last system restore, save and close all open files and exit any open programs. Do not alter, open, or delete any files or programs until the system restoration is complete.

1. Click **Start** .
2. In the search box, type `System Restore` and press <Enter>.
3. Click **Undo my last restoration** and click **Next**.

## Dell DataSafe Local Backup

 **CAUTION:** Using Dell DataSafe Local Backup to restore your operating system permanently removes any programs or drivers installed after you received your computer. Create backup media of applications you need to install on your computer before using Dell DataSafe Local Backup. Use Dell DataSafe Local Backup only if System Restore did not resolve your operating system problem.

 **CAUTION:** Although Dell Datasafe Local Backup is designed to preserve the data files on your computer, it is recommended that you backup your data files before using Dell DataSafe Local Backup.

 **NOTE:** If Dell DataSafe Local Backup is not available on your computer, use Dell Factory Image Restore (see “Dell Factory Image Restore” on page 82) to restore your operating system.

You can use Dell DataSafe Local Backup to restore your hard drive to the operating state it was in when you purchased your computer, while preserving the data files.

Dell DataSafe Local Backup allows you to:

- Backup and restore your computer to an earlier operating state
- Create system recovery media (see “Create System Recovery Media (Recommended)” on page 12)

### Dell DataSafe Local Backup Basic

To restore the operating system and Dell factory-installed software while preserving the data files:

1. Turn off your computer.
2. Disconnect all the devices (USB drive, printer, and so on) connected to the computer and remove any newly added internal hardware.

 **NOTE:** Do not disconnect the AC adapter.

## Restoring Your Operating System

3. Turn on your computer.
4. When the DELL logo appears, press <F8> several times to access the **Advanced Boot Options** window.

 **NOTE:** If you wait too long and the operating system logo appears, continue to wait until you see the Microsoft Windows desktop; then, shut down your computer and try again.

5. Select **Repair Your Computer**.
6. Select **Dell DataSafe Restore and Emergency Backup** from the **System Recovery Options** menu and follow the instructions on the screen.

 **NOTE:** The restoration process may take an hour or more depending on the size of the data to be restored.

 **NOTE:** For more information, see knowledge base article 353560 at [support.dell.com](http://support.dell.com).

## Upgrading to Dell DataSafe Local Backup Professional

 **NOTE:** Dell DataSafe Local Backup Professional may be installed on your computer, if you ordered it at the time of purchase.

Dell DataSafe Local Backup Professional provides additional features that allow you to:

- Backup and restore your computer based on file types
- Backup files to a local storage device
- Schedule automated backups

To upgrade to Dell DataSafe Local Backup Professional:

1. Double-click the Dell DataSafe Local Backup icon  in the notification area of your desktop.
2. Click **UPGRADE NOW!**
3. Follow the instructions on the screen.

## System Recovery Media

 **CAUTION:** Although the system recovery media is designed to preserve the data files on your computer, it is recommended that you backup your data files before using the system recovery media.

You can use the system recovery media, created using Dell DataSafe Local Backup, to return your hard drive to the operating state it was in when you purchased the computer while preserving the data files on your computer.

Use the system recovery media in case of:

- Operating system failure that prevents the use of the recovery options installed on your computer.
- Hard drive failure that prevents data from being recovered.

To restore the operating system and Dell factory-installed software on your computer using the system recovery media:

1. Insert the system recovery disc or USB key and restart the computer.
2. When the DELL logo appears, press <F12> immediately.

 **NOTE:** If you wait too long and the operating system logo appears, continue to wait until you see the Microsoft Windows desktop; then, shut down your computer and try again.

3. Select the appropriate boot device from the list and press <Enter>.
4. Follow the instructions on the screen.

## Dell Factory Image Restore

 **CAUTION:** Using Dell Factory Image Restore to restore your operating system permanently deletes all data on the hard drive and removes any programs or drivers installed after you received your computer. If possible, back up the data before using this option. Use Dell Factory Image Restore only if System Restore did not resolve your operating system problem.

 **NOTE:** Dell Factory Image Restore may not be available in certain countries or on certain computers.

 **NOTE:** If Dell Factory Image Restore is not available on your computer, use Dell DataSafe Local Backup (see “Dell DataSafe Local Backup” on page 79) to restore your operating system.

Use Dell Factory Image Restore only as the last method to restore your operating system. This option restores your hard drive to the operating state it was in when you purchased the computer. Any programs or files added since you received your computer—including data files—are permanently deleted from the hard drive. Data files include documents, spreadsheets, e-mail messages, digital photos, music files, and so on. If possible, back up all data before using Dell Factory Image Restore.

### Starting Dell Factory Image Restore

1. Turn on the computer.
2. When the DELL logo appears, press <F8> several times to access the **Advanced Boot Options** window.

 **NOTE:** If you wait too long and the operating system logo appears, continue to wait until you see the Microsoft Windows desktop; then, shut down your computer and try again.

3. Select **Repair Your Computer**.

The **System Recovery Options** window appears.

4. Select a keyboard layout and click **Next**.

5. To access the recovery options, log on as a local user. To access the command prompt, type `administrator` in the **User name** field, then click **OK**.

6. Click **Dell Factory Image Restore**.

The **Dell Factory Image Restore** welcome screen appears.

 **NOTE:** Depending upon your configuration, you may need to select **Dell Factory Tools**, then **Dell Factory Image Restore**.

7. Click **Next**.

The **Confirm Data Deletion** screen appears.

 **NOTE:** If you do not want to proceed with the Factory Image Restore, click **Cancel**.

8. Select the check box to confirm that you want to continue to reformat the hard drive and restore the system software to the factory condition, then click **Next**.

The restore process begins and may take five or more minutes to complete. A message appears when the operating system and factory-installed applications have been restored to factory condition.

9. Click **Finish** to restart the computer.

# Getting Help

If you experience a problem with your computer, you can complete the following steps to diagnose and troubleshoot the problem:

1. See “Solving Problems” on page 63 for information and procedures that pertain to the problem your computer is experiencing.
2. See “Dell Diagnostics” on page 72 for procedures on how to run Dell Diagnostics.
3. Fill out the “Diagnostic Checklist” on page 90.
4. Use Dell’s extensive suite of online services available at Dell Support ([support.dell.com](http://support.dell.com)) for help with installation and troubleshooting procedures. See “Online Services” on page 86 for a more extensive list of Dell Support online.
5. If the preceding steps have not resolved the problem, see “Before You Call” on page 89.

 **NOTE:** Call Dell Support from a telephone near or at the computer so that the support staff can assist you with any necessary procedures.

 **NOTE:** Dell’s Express Service Code system may not be available in all countries.

When prompted by Dell’s automated telephone system, enter your Express Service Code to route the call directly to the proper support personnel. If you do not have an Express Service Code, open the **Dell Accessories** folder, double-click the **Express Service Code** icon, and follow the directions.

 **NOTE:** Some of the services are not always available in all locations outside the continental U.S. Call your local Dell representative for information on availability.

## Technical Support and Customer Service

Dell's support service is available to answer your questions about Dell hardware. Our support staff use computer-based diagnostics to provide fast, accurate answers.

To contact Dell's support service, see "Before You Call" on page 89 and then see the contact information for your region or go to **[support.dell.com](http://support.dell.com)**.

## DellConnect

DellConnect is a simple online access tool that allows a Dell service and support associate to access your computer through a broadband connection, diagnose your problem and repair it all under your supervision. For more information, go to **[dell.com/DellConnect](http://dell.com/DellConnect)**.

# Online Services

You can learn about Dell products and services on the following websites:

- **dell.com**
- **dell.com/ap** (Asian/Pacific countries only)
- **dell.com/jp** (Japan only)
- **euro.dell.com** (Europe only)
- **dell.com/la** (Latin American and Caribbean countries)
- **dell.ca** (Canada only)

You can access Dell Support through the following websites and e-mail addresses:

## Dell Support Websites

- **support.dell.com**
- **support.jp.dell.com** (Japan only)
- **support.euro.dell.com** (Europe only)
- **supportapj.dell.com** (Asia Pacific only)

## Dell Support E-mail Addresses

- **mobile\_support@us.dell.com**
- **support@us.dell.com**
- **la-techsupport@dell.com** (Latin America and Caribbean countries only)
- **apsupport@dell.com** (Asian/Pacific countries only)

## Dell Marketing and Sales E-mail Addresses

- **apmarketing@dell.com** (Asian/Pacific countries only)
- **sales\_canada@dell.com** (Canada only)

## Anonymous File Transfer Protocol (FTP)

- **ftp.dell.com**

Log in as user: `anonymous`, and use your e-mail address as your password.

## Automated Order-Status Service

To check on the status of any Dell products that you have ordered, you can go to **support.dell.com**, or you can call the automated order-status service. A recording prompts you for the information needed to locate and report on your order.

If you have a problem with your order, such as missing parts, wrong parts, or incorrect billing, contact Dell for customer assistance. Have your invoice or packing slip handy when you call.

For the telephone number to call for your region, see "Contacting Dell" on page 91.

## Product Information

If you need information about additional products available from Dell, or if you would like to place an order, go to the Dell website at **dell.com**. For the telephone number to call for your region or to speak to a sales specialist, see "Contacting Dell" on page 91.

## Returning Items for Repair Under Warranty or for Credit

Prepare all items being returned, whether for repair or credit, as follows:

 **NOTE:** Before you return the product to Dell, ensure that you back up any data on the hard drive(s) and on any other storage device in the product. Remove any and all confidential, proprietary and personal information, as well as removable media, such as CDs and media cards. Dell is not responsible for any of your confidential, proprietary or personal information; lost or corrupted data; or damaged or lost removable media that may be included with your return.

1. Call Dell to obtain a Return Material Authorization Number, and write it clearly and prominently on the outside of the box. For the telephone number to call for your region, see "Contacting Dell" on page 91.

2. Include a copy of the invoice and a letter describing the reason for the return.
3. Include a copy of the Diagnostics Checklist (see "Diagnostic Checklist" on page 90), indicating the tests that you have run and any error messages reported by Dell Diagnostics (see "Dell Diagnostics" on page 72).
4. Include any accessories that belong with the item(s) being returned (AC adapter cable, software, guides, and so on) if the return is for credit.
5. Pack the equipment to be returned in the original (or equivalent) packing materials.

 **NOTE:** You are responsible for paying shipping expenses. You are also responsible for insuring any product returned, and you assume the risk of loss during shipment to Dell. Collect On Delivery (C.O.D.) packages are not accepted.

 **NOTE:** Returns that are missing any of the preceding requirements will be refused at Dell's receiving dock and returned to you.

## Before You Call

**NOTE:** Have your Express Service Code ready when you call. The code helps Dell's automated-support telephone system direct your call more efficiently. You may also be asked for your Service Tag.

### Locating Your Service Tag

The Service Tag for your computer can be found on a label at the bottom of your computer.

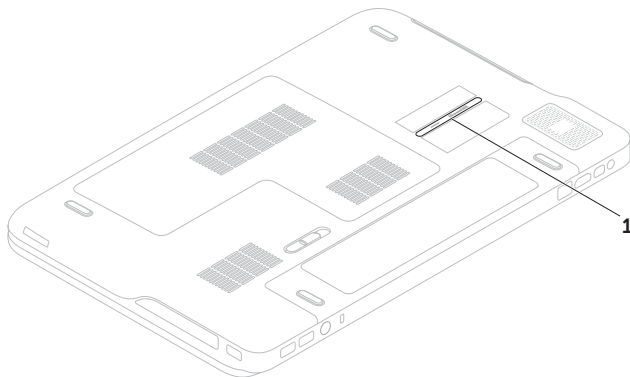

---

1 Service Tag

---

## Getting Help

Remember to fill out the following Diagnostic Checklist. If possible, turn on your computer before you call Dell for assistance and call from a telephone at or near the computer. You may be asked to type some commands at the keyboard, relay detailed information during operations, or try other troubleshooting steps possible only at the computer itself. Ensure that the computer documentation is available.

### Diagnostic Checklist

- Name:
- Date:
- Address:
- Phone number:
- Service Tag (bar code on the bottom of the computer):
- Express Service Code:
- Return Material Authorization Number (if provided by Dell support technician):
- Operating system and version:
- Devices:
- Expansion cards:
- Are you connected to a network? Yes/No
- Network, version, and network adapter:
- Programs and versions:

See your operating system documentation to determine the contents of the computer's start-up files. If the computer is connected to a printer, print each file. Otherwise, record the contents of each file before calling Dell.

- Error message, beep code, or diagnostic code:
- Description of problem and troubleshooting procedures you performed:

## Contacting Dell

For customers in the United States, call 800-WWW-DELL (800-999-3355).

 **NOTE:** If you do not have an active Internet connection, you can find contact information on your purchase invoice, packing slip, bill, or Dell product catalog.

Dell provides several online and telephone-based support and service options. Availability varies by country and product, and some services may not be available in your area.

To contact Dell for sales, technical support, or customer service issues:

1. Go to **dell.com/ContactDell**.
2. Select your country or region.
3. Select the appropriate service or support link based on your requirement.
4. Choose the method of contacting Dell that is convenient for you.

# Finding More Information and Resources

## If you need to:

## See:

---

reinstall your operating system

"System Recovery Media" on page 81

---

run a diagnostic program for your computer

"Dell Diagnostics" on page 72

---

reinstall system software

"My Dell Downloads" on page 71

---

for more information about the Microsoft Windows operating system and features

**support.dell.com**

---

find your Service Tag/Express Service Code — You must use the service tag to identify your computer on **support.dell.com** or to contact technical support

the bottom of your computer

"Dell Support Center" on page 70

---

upgrade your computer with new or additional components like a new hard drive  
reinstall or replace a worn or defective part

the *Service Manual* at

**support.dell.com/manuals**



**NOTE:** In some countries, opening and replacing parts of your computer may void your warranty. Check your warranty and return policies before working inside your computer.

### If you need to:

find safety best practices information for your computer

review Warranty information, Terms and Conditions (U.S. only), Safety instructions, Regulatory information, Ergonomics information, and End User License Agreement

find drivers and downloads; readme files

access technical support and product help

check on your order status for new purchases

find solutions and answers to common questions

locate information for last-minute updates about technical changes to your computer or advanced technical-reference material for technicians or experienced users



### See:

the safety and regulatory documents that shipped with your computer and also see the Regulatory Compliance Homepage at **[dell.com/regulatory\\_compliance](http://dell.com/regulatory_compliance)**

**[support.dell.com](http://support.dell.com)**

# Specifications

This section provides information that you may need when setting up, updating drivers for, and upgrading your computer.

 **NOTE:** Offerings may vary by region. For more information regarding the configuration of your computer, see the **Detailed System Information** section in the Dell Support Center. To launch the Dell Support Center, click **Start**  → **All Programs** → **Dell** → **Dell Support Center** → **Launch Dell Support Center**.

## Computer Model

---

Dell XPS L702X

## Computer Information

---

|                |   |
|----------------|---|
| System chipset | Mobile Intel 6 series express chipset HM67      |
| Processor type | Intel Core i3<br>Intel Core i5<br>Intel Core i7 |

## Memory

---

|                          |   |
|--------------------------|---|
| Memory module connector  | two or four user-accessible SODIMM connectors |
| Memory module capacities | 1 GB, 2 GB, and 4 GB                          |
| Minimum memory           | 3 GB  |
| Maximum memory           | 16 GB   |

## Memory

---

Memory type      1066 MHz/1333 MHz  
SODIMM DDR3

**NOTE:** For instructions on upgrading the memory, see the *Service Manual* at [support.dell.com/manuals](http://support.dell.com/manuals).

## Connectors

---

Audio              one microphone-in connector, one stereo headphones/speakers connector

S/PDIF            one headphone/digital S/PDIF combo connector

Mini-Card        one full Mini-Card slot  
one half Mini-Card slot

HDMI connector    one 19-pin connector

## Connectors

---

Network adapter    one RJ45 connector

USB                two 4-pin USB 3.0-compliant connectors  
one 4-pin USB 2.0-compliant connector

Mini-DisplayPort    one 20-pin connector

eSATA              one 7-pin/4-pin eSATA/USB combo connector with PowerShare

Media Card Reader    one 9-in-1 slot

Antenna-in connector (optional)    one MCX connector

## Specifications

### Media Card Reader

---

|                 |   |
|-----------------|---|
| Cards supported | Secure Digital (SD) memory card         |
|                 | Secure Digital Input Output (SDIO)      |
|                 | Secure Digital High Capacity (SDHC)     |
|                 | Secure Digital eXtended Capacity (SDXC) |
|                 | Memory Stick                            |
|                 | Memory Stick PRO                        |
|                 | MSXC Memory Card                        |
|                 | MultiMedia Card (MMC)                   |
|                 | xD-Picture Card                         |

### Camera

---

|                  |                                     |
|------------------|-------------------------------------|
| Type             | 2.0 megapixel HD with H.264 support |
| Video resolution | 1280 x 720                          |

### Communications

---

|                  |  |
|------------------|--|
| Modem (optional) | external V.92 56 K USB modem   |
| Network adapter  | 10/100/1000 Ethernet LAN on system board   |
| Wireless         | WLAN, WWAN (optional), WiMAX/Wi-Fi abgn/agn, and Bluetooth wireless technology (optional)/ WiDi (optional) |
| TV               | TV tuner card (optional)   |

### Audio

---

|                  |  |
|------------------|--|
| Audio controller | Realtek ALC665                               |
| Speakers         | 2 x 5 Watt main speakers + 12 Watt subwoofer |
| Volume controls  | software program menus and media controls    |

## Video

---

### Integrated:

Video controller Intel HD Graphics

Video memory up to 1.6 GB

### Discrete:

Video controller NVIDIA GeForce GT 550M  
NVIDIA GeForce GT 555M

Video memory 1 GB DDR3 (GT 550M)  
3 GB DDR3 (GT 555M)

## Display

---

Type 17.3-inch HD+ WLED, TrueLife  
17.3-inch Full HD WLED, TrueLife 3D  
17.3-inch Full HD WLED, TrueLife

## Display

---

Multi-touch 17.3-inch HD+ WLED, TrueLife (Optional)

### Dimensions:

Height 214.81 mm (8.46 inches)

Width 381.89 mm (15.04 inches)

Diagonal 439.42 mm (17.30 inches)

Maximum resolution HD+: 1600 x 900  
FHD: 1920 x 1080

Refresh rate HD+: 60 Hz  
FHD: 120 Hz

Operating angle 0° (closed) to 135°

Horizontal viewing angle HD+: 40/40  
FHD: 60/60

Vertical viewing angle HD+: 15/30 (H/L)  
FHD: 50/50 (H/L)

## Specifications

### Display

---

|             |  |
|-------------|--|
| Pixel pitch | HD+: 0.2388 mm x 0.2388 mm<br>FHD: 0.1989 mm x 0.1989 mm |
|-------------|--|

### Battery

---

9-cell "smart" lithium ion:

|        |                         |
|--------|-------------------------|
| Height | 221.07 mm (8.70 inches) |
| Width  | 54.35 mm (2.14 inches)  |
| Depth  | 42.53 mm (1.67 inches)  |
| Weight | 0.52 kg (1.14 lb)       |

6-cell "smart" lithium ion:

|        |                         |
|--------|-------------------------|
| Height | 209.19 mm (8.24 inches) |
| Width  | 54.35 mm (2.14 inches)  |
| Depth  | 20.40 mm (0.80 inches)  |
| Weight | 0.34 kg (0.74 lb)       |

### Battery

---

|                           |   |
|---------------------------|---|
| Voltage                   | 11.1 V (6-/9-cell)  |
| Charge time (approximate) | 4 hours (when the computer is turned off)                       |
| Operating time            | battery operating time varies depending on operating conditions |
| Coin-cell battery         | CR-2032   |

### AC Adapter

---

 **NOTE:** Use only AC adapters specified for use with your computer. See the safety information that shipped with your computer.

|                         |               |
|-------------------------|---------------|
| Input voltage           | 100-240 VAC   |
| Input current (maximum) | 2.30 A/2.50 A |

## AC Adapter

---

|                       |                                 |
|-----------------------|---------------------------------|
| Input frequency       | 50-60 Hz                        |
| Output power          | 130 W/150 W                     |
| Output current:       |                                 |
| 130 W                 | 6.70 A (continuous)             |
| 150 W                 | 7.70 A (continuous)             |
| Rated output voltage  | 19.5 VDC                        |
| Operating temperature | 0° to 40°C<br>(32° to 104°F)    |
| Storage temperature   | -40° to 70°C<br>(-40° to 158°F) |

## Keyboard

---

|                |  |
|----------------|--|
| Number of keys | 102 (U.S. and Canada);<br>103 (Europe); 105 (Brazil);<br>106 (Japan) |
|----------------|--|

Layout QWERTY/AZERTY/Kanji

## Touch Pad

---

|   |                      |
|---|----------------------|
| X/Y position resolution (graphics table mode) | 240 cpi              |
| Size:   |                      |
| Width   | 100 mm (3.94 inches) |
| Height  | 56 mm (2.2 inches)   |

## Physical

---

|                              |   |
|------------------------------|---|
| Height                       | 32.9 mm to 38.5 mm<br>(1.29 inches to<br>1.51 inches) |
| Width                        | 414.9 mm (16.33 inches)                               |
| Depth                        | 287.3 mm (11.31 inches)                               |
| Weight (with 6-cell battery) | 3.5 kg (7.7 lb)                                       |

## Specifications

### Computer Environment

---

Temperature range:

Operating      0° to 35°C  
                    (32° to 95°F)

Storage          -40° to 65°C  
                    (-40° to 149°F)

Relative humidity (maximum):

Operating      10% to 90%  
                    (noncondensing)

Storage          5% to 95%  
                    (noncondensing)

Maximum vibration (using a random vibration spectrum that simulates user environment):

Operating      0.66 GRMS

Non-            1.30 GRMS

Operating

### Computer Environment

---

Maximum shock (for operating — measured with Dell Diagnostics running on the hard drive and a 2-ms half-sine pulse; for non-operating — measured with the hard drive in head-parked position and a 2-ms half-sine pulse):

Operating      110 G

Non-            160 G

Operating

Altitude  
(maximum):

Operating      -15.2 to 3048 m  
                    (-50 to 10,000 ft)

Storage          -15.2 to 10,668 m  
                    (-50 to 35,000 ft)

Airborne  
contaminant level      G2 or lower as defined  
                                  by ISA-S71.04-1985

# Appendix

## Information for NOM, or Official Mexican Standard (Only for Mexico)

The following information is provided in the device(s) described in this document in accordance with the requirements of the Official Mexican Standard (NOM):

### Importer:

Dell México S.A. de C.V.

Paseo de la Reforma 2620 – Flat 11°

Col. Lomas Altas

11950 México, D.F.

| Regulatory model number | Voltage     | Frequency | Electricity consumption | Output voltage | Output intensity |
|-------------------------|-------------|-----------|-------------------------|----------------|------------------|
| P09E                    | 100-240 VAC | 50-60 Hz  | 2.30 A/2.50 A           | 19.5 VDC       | 6.70 A/7.70 A    |

For details, read the safety information that shipped with your computer.

For additional safety best practices information, see the Regulatory Compliance Homepage at [dell.com/regulatory\\_compliance](http://dell.com/regulatory_compliance).

# Index

## A

- airflow, allowing **7**
- Audio control panel **45**

## B

- backup and recovery **55**
- battery status light **35**
- B-CAS card **14**

## C

- calling Dell **89**
- Camera **49**
- CDs, playing and creating **55**
- computer capabilities **54**
- computer, setting up **7**
- connect(ing)
  - to the Internet **23**

- Contacting Dell online **91**
- Control strip **35**
- customer service **85**

## D

- DataSafe Local Backup **79**
- DellConnect **85**
- Dell Diagnostics **72**
- Dell Factory Image Restore **82**
- Dell Stage **61**
- Diagnostic Checklist **90**
- drivers and downloads **93**
- DVDs, playing and creating **55**

## E

- email addresses
  - for technical support **86**

**F**

finding more information **92**

flick **50**

FTP login, anonymous **86**

**H**

hard drive activity light **35**

hardware problems

    diagnosing **72**

Hardware Troubleshooter **72**

help

    getting assistance and support **84**

**I**

Internet connection **23**

ISP

    Internet Service Provider **23**

**M**

memory problems

    solving **67**

mini-DisplayPort connector **33**

Multimedia Control Keys **42**

**N**

network connection

    fixing **65**

NVIDIA Optimus Technology **56**

**O**

Optical Drive

    Using **46**

**P**

power problems, solving **66**

power strips, using **8**

problems, solving **63**

## Index

products

information and purchasing **87**

## R

resources, finding more **92**

restoring factory image **82**

## S

setup, before you begin **7**

shipping products

for return or repair **88**

SIM card **14**

software features **54**

software problems **68**

solving problems **63**

specifications **94**

support email addresses **86**

support sites

worldwide **86**

System Recovery Media **81**

system reinstall options **77**

System Restore **78**

System Setup

entering **42**

function key behavior **42**

## T

Touch Pad

Gestures **40**

Touch screen

Gestures **50**

TV tuner **19**

## U

USB PowerShare **29**

## W

warranty returns **88**

Windows

    Program Compatibility Wizard **68**

Windows Mobility Center **42**

wired network

    network cable, connecting **9**

wireless network connection **65**







Printed in the U.S.A.

[www.dell.com](http://www.dell.com) | [support.dell.com](http://support.dell.com)



0C4XC4A01

[Downloaded from LpManual.com](http://LpManual.com) Manuals