



Maintenance & Service Guide

HP Elite 7500 Microtower

HP Elite 7300 Microtower

HP Pro 3300 Microtower

HP Pro 3305 Microtower

HP Pro 3300 Small Form Factor

© Copyright 2011, 2012 Hewlett-Packard Development Company, L.P. The information contained herein is subject to change without notice.

Microsoft and Windows are trademarks of Microsoft Corporation in the U.S. and other countries.

The only warranties for HP products and services are set forth in the express warranty statements accompanying such products and services. Nothing herein should be construed as constituting an additional warranty. HP shall not be liable for technical or editorial errors or omissions contained herein.

This document contains proprietary information that is protected by copyright. No part of this document may be photocopied, reproduced, or translated to another language without the prior written consent of Hewlett-Packard Company.

Maintenance & Service Guide

Fourth Edition (November 2012)

First Edition (June 2011)

Document Part Number: 663321-004

About This Book

 **WARNING!** Text set off in this manner indicates that failure to follow directions could result in bodily harm or loss of life.

 **CAUTION:** Text set off in this manner indicates that failure to follow directions could result in damage to equipment or loss of information.

 **NOTE:** Text set off in this manner provides important supplemental information.

Table of contents

1 Product Features	1
Standard Configuration	1
Serviceability Features	2
Microtower Components	2
Small Form Factor Components	3
2 Activating and Customizing the Software	4
Activating and customizing the software in Windows 7	4
Activating the Windows operating system	4
Downloading Windows 7 updates	5
Installing or upgrading device drivers	5
Customizing the monitor display	5
Activating and customizing the software in Windows 8	5
Activating the Windows Operating System	5
Downloading Windows 8 updates	6
Customizing the monitor display	6
3 Computer Setup (F10) Utility	7
Computer Setup (F10) Utilities	7
Using Computer Setup (F10) Utilities	8
Computer Setup—File	9
Computer Setup—Storage	10
Computer Setup—Security	13
Computer Setup—Power	17
Computer Setup—Advanced	18
Recovering the Configuration Settings	20
4 Illustrated parts catalog	21
Microtower (MT) Chassis Spare Parts	21
Computer Major Components	21
Cables	25

Misc Parts	26
Drives	27
Misc Boards	27
Sequential Part Number Listing	28
Small Form Factor (SFF) Chassis Spare Parts	33
Computer major components	33
Cables	35
Misc Parts	35
Drives	37
Misc Boards	37
Sequential Part Number Listing	37
5 Serial ATA (SATA) Drive Guidelines and Features	40
SATA Hard Drives	40
SATA Hard Drive Cables	40
SATA Data Cable	40
SMART ATA Drives	41
Hard Drive Capacities	41
6 Routine Care, and Disassembly Preparation	42
Electrostatic Discharge Information	42
Generating Static	42
Preventing Electrostatic Damage to Equipment	43
Personal Grounding Methods and Equipment	43
Grounding the Work Area	44
Recommended Materials and Equipment	44
Operating Guidelines	45
Routine Care	46
General Cleaning Safety Precautions	46
Cleaning the Computer Case	46
Cleaning the Keyboard	46
Cleaning the Monitor	47
Cleaning the Mouse	47
Service Considerations	47
Power Supply Fan	47
Tools and Software Requirements	47
Screws	48
Cables and Connectors	48
Hard Drives	48
Lithium Coin Cell Battery	49

7 Removal and Replacement Procedures Microtower (MT) Chassis	50
Preparation for Disassembly	50
Access Panel	51
Front Bezel	53
Memory	55
DDR3-SDRAM DIMMs	55
Populating DIMM Sockets	57
Removing Memory Modules	59
Expansion Cards	61
Cable Management	68
Cable Connections	69
Drives	70
Drive Positions	71
Installing Additional Drives	72
System Board Drive Connections	72
Removing an Optical Drive	74
Removing a Hard Drive	77
Front I/O and USB Panel Housing Assembly	84
Power Switch/LED Assembly	87
System Fan	89
Fan Sink Assembly	91
Processor	93
Power Supply	98
System Board	100
Battery	102
8 Removal and Replacement Procedures Small Form Factor (SFF) Chassis	104
Preparation for Disassembly	104
Access Panel	105
Front Bezel	107
Memory	108
DDR3-SDRAM DIMMs	108
Populating DIMM Sockets	109
Removing DIMMs	110
Expansion Card	113
Cable Management	118
Cable Connections	119
Drives	120
Drive Positions	120
Removing Drives	121
Removing an Optical Drive	121

Removing the Hard Drive	123
Power Switch	127
Front USB Assembly	129
Fan Assembly	132
Fan Sink	134
Processor	136
Power Supply	138
System Board	140
Battery	142
Appendix A Troubleshooting Without Diagnostics	144
Safety and Comfort	144
Before You Call for Technical Support	144
Helpful Hints	145
Solving General Problems	147
Solving Power Problems	151
Solving Hard Drive Problems	153
Solving Media Card Reader Problems	156
Solving Display Problems	158
Solving Audio Problems	163
Solving Printer Problems	165
Solving Keyboard and Mouse Problems	167
Solving Hardware Installation Problems	169
Solving Network Problems	171
Solving Memory Problems	174
Solving Processor Problems	176
Solving CD-ROM and DVD Problems	176
Solving USB Flash Drive Problems	179
Solving Front Panel Component Problems	180
Solving Internet Access Problems	180
Solving Software Problems	182
Contacting Customer Support	184
Appendix B HP PC Hardware Diagnostics	185
Why run HP PC Hardware Diagnostics	185
How to access and run HP PC Hardware Diagnostics	186
Downloading HP PC Hardware Diagnostics to a USB device	187
Appendix C Backup and Recovery	188
Restoring and recovering in Windows 7	188

System Restore	188
System Recovery	188
System Recovery when Windows is responding	189
System Recovery when Windows is not responding	190
System recovery using recovery media	190
Creating recovery media	191
Using recovery media	192
Backup and recovery in Windows 8	193
Backing up your information	193
Performing a system recovery	194
Using the Windows recovery tools	194
Using f11 recovery tools	195
Using Windows 8 operating system media (purchased separately)	195
Appendix D Power Cord Set Requirements	196
General Requirements	196
Japanese Power Cord Requirements	196
Country-Specific Requirements	197
Appendix E POST Error Messages	198
POST Numeric Codes and Text Messages	199
Interpreting POST Diagnostic Front Panel LEDs and Audible Codes	207
Appendix F Password Security and Resetting CMOS	211
Resetting the Password Jumper – Models 3300/3305	212
Resetting the Password Jumper – Model 7300/7500	213
Clearing and Resetting the CMOS – Models 3300/3305	214
Clearing and Resetting the CMOS – Model 7300/7500	215
Appendix G Specifications	216
MT Specifications	216
SFF Specifications	217
Index	218

1 Product Features

Standard Configuration

HP Pro 3300 MT



HP Pro 3300 SFF



HP Elite 7500/7300 MT



 **NOTE:** The drive configuration shown above may be different than your computer model.

Serviceability Features

The computers include features that make them easy to upgrade and service. A Torx T-15 or flat blade screwdriver is needed for many of the installation procedures described in this guide.

Microtower Components



1	(2) external 5.25" drive bays for optional optical drives (1) external 3.5" drive bay for optional media reader	6	(3) PCIe x1 slots, (1) PCIe x16 slot, (1) miniPCI slot
2	Power Supply	7	USB Scroll Mouse
3	Rear I/O includes: (4) USB 2.0 ports, SPDIF out, RJ-45 network interface, DVI-D and VGA video interfaces, microphone jack, audio in/out jacks, 5.1/7.1 channel audio jacks* ¹	8	HP USB Standard Value Keyboard
4	Front I/O includes: (4) USB 2.0 ports, dedicated headphone output, microphone jack	9	Monitor (sold separately)
5	(2) internal 3.5" hard drive bays		

¹ HP Pro 3300 supports 5.1 channel audio, HP Pro 3305 supports 7.1 channel audio

Small Form Factor Components

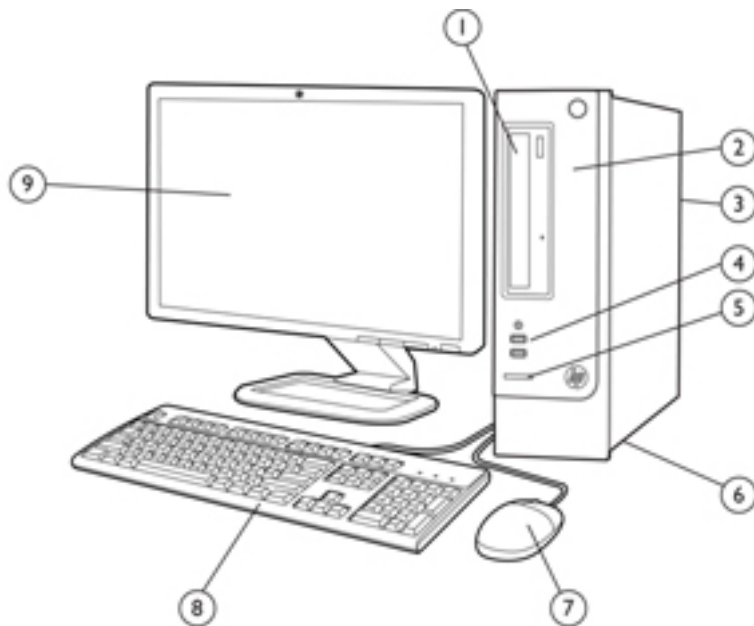

1	External 5.25" drive bay for optical drive	6	Power Supply
2	Internal 3.5" hard drive bay	7	USB Scroll Mouse
3	Rear I/O includes: (3) PCIe x1 slots, (1) PCIe x16 slot, (2) miniPCI slots USB 2.0 ports; network, DVI-D and VGA video ports, and audio	8	HP USB Standard Value Keyboard
4	Front I/O includes: (2) USB 2.0 ports, dedicated headphone output	9	Monitor (sold separately)
5	HP 6-in-1 Media Card Reader		HP Pro 3300 supports 5.1 channel audio, HP Pro 3305 supports 7.1 channel audio

2 Activating and Customizing the Software

 **NOTE:** This chapter provides information for both Windows 7 and Windows 8.

Activating and customizing the software in Windows 7

If your computer was not shipped with a Windows® operating system, some portions of this documentation do not apply. Additional information is available in online help after you activate the operating system.

 **CAUTION:** Do not add optional hardware or third-party devices to the computer until the operating system is successfully activated. Doing so may cause errors and prevent the operating system from installing properly.

 **NOTE:** Be sure there is a 10.2 cm (4 inch) clearance at the back of the unit and above the monitor to permit the required airflow.

Activating the Windows operating system

The first time you turn on the computer, the operating system is set up and activated automatically. This process takes about 5 to 10 minutes. Carefully read and follow the instructions on the screen to complete the activation.

We recommend that you register your computer with HP during operating system setup so you can receive important software updates, facilitate support questions, and sign up for special offers.

 **CAUTION:** After the activation process has begun, **DO NOT TURN OFF THE COMPUTER UNTIL THE PROCESS IS COMPLETE.** Turning off the computer during the activation process may damage the software that runs the computer or prevent its proper installation.

 **NOTE:** If the computer shipped with more than one operating system language on the hard drive, the activation process could take up to 60 minutes.

Downloading Windows 7 updates

Microsoft may release updates to the operating system. To help keep the computer running optimally, HP recommends checking for the latest updates during the initial installation and periodically throughout the life of the computer.

1. To set up your Internet connection, click **Start > Internet Explorer** and follow the instructions on the screen.
2. After an Internet connection has been established, click the **Start > All Programs > Windows Update**.
3. Run Windows Update monthly thereafter.

Installing or upgrading device drivers

When installing optional hardware devices after the operating system installation is complete, you must also install the drivers for each of the devices.

In Windows 7, if prompted for the i386 directory, replace the path specification with `C:\i386`, or use the **Browse** button in the dialog box to locate the i386 folder. This action points the operating system to the appropriate drivers.

Obtain the latest support software, including support software for the operating system, from <http://www.hp.com/support>. Select your country and language, select **Download drivers and software (and firmware)**, enter the model number of the computer, and press **Enter**.

Customizing the monitor display

If you wish, you can select or change the monitor refresh rates, screen resolution, color settings, font sizes, and power management settings.

For more information, refer to the online documentation provided with the graphics controller utility or the documentation that came with your monitor.

Right-click on the Windows desktop, then click **Personalize** to change display settings.

Activating and customizing the software in Windows 8

Additional information is available in online help after you activate the operating system.

 **NOTE:** Be sure there is a 10.2 cm (4 inch) clearance at the back of the unit and above the monitor to permit the required airflow.

Activating the Windows Operating System

The first time you turn on the computer, the operating system is set up and activated automatically. This process takes about 5 to 10 minutes. Carefully read and follow the instructions on the screen to complete the activation.

We recommend that you register your computer with HP during operating system set up so you can receive important software updates, facilitate support questions, and sign up for special offers. You can also register your computer with HP using the **Register with HP** app on the Start screen.

 **CAUTION:** After the activation process has begun, DO NOT TURN OFF THE COMPUTER UNTIL THE PROCESS IS COMPLETE. Turning off the computer during the activation process may damage the software that runs the computer or prevent its proper installation.

Downloading Windows 8 updates

Microsoft may release updates to the operating system. To help keep the computer running optimally, HP recommends checking for the latest updates during the initial installation and periodically throughout the life of the computer.

Run Windows Update as soon as possible after you set up your computer.

1. Point to the upper-right or lower-right corner of the Start screen to display the charms.
2. Click **Settings > Change PC Settings > Windows Update**.
3. Run Windows Update monthly thereafter.

Customizing the monitor display

You can customize display settings for Windows 8 separately for the Start screen and the Desktop.

To customize the Start screen:

1. Point to the upper-right or lower-right corner of the Start screen to display the charms.
2. Click **Settings > Change PC Settings**.
3. Click **Personalize** to change the display settings.

To customize the Desktop:

1. Click the Desktop app on the Start screen.
2. Right-click on the desktop, and then click **Personalize** to change display settings.

3 Computer Setup (F10) Utility

Computer Setup (F10) Utilities

Use Computer Setup (F10) Utility to do the following:

- Change factory default settings.
- Set the system date and time.
- Set, view, change, or verify the system configuration, including settings for processor, graphics, memory, audio, storage, communications, and input devices.
- Modify the boot order of bootable devices such as hard drives, optical drives, or USB flash media devices.
- Enable Quick Boot, which is faster than Full Boot but does not run all of the diagnostic tests run during a Full Boot. You can set the system to:
 - always Quick Boot (default);
 - periodically Full Boot (from every 1 to 30 days); or
 - always Full Boot.
- Select Post Messages Enabled or Disabled to change the display status of Power-On Self-Test (POST) messages. Post Messages Disabled suppresses most POST messages, such as memory count, product name, and other non-error text messages. If a POST error occurs, the error is displayed regardless of the mode selected. To manually switch to Post Messages Enabled during POST, press any key (except **F1** through **F12**).
- Establish an Ownership Tag, the text of which is displayed each time the system is turned on or restarted.
- Enter the Asset Tag or property identification number assigned by the company to this computer.
- Enable the power-on password prompt during system restarts (warm boots) as well as during power-on.
- Establish a setup password that controls access to the Computer Setup (F10) Utility and the settings described in this section.
- Secure integrated I/O functionality, including the serial, USB, or parallel ports, audio, or embedded NIC, so that they cannot be used until they are unsecured.
- Enable or disable removable media boot ability.

- Solve system configuration errors detected but not automatically fixed during the Power-On Self-Test (POST).
- Replicate the system setup by saving system configuration information on a USB device and restoring it on one or more computers.
- Execute self-tests on a specified ATA hard drive (when supported by drive).
- Enable or disable DriveLock security (when supported by drive).

Using Computer Setup (F10) Utilities

Computer Setup can be accessed only by turning the computer on or restarting the system. To access the Computer Setup Utilities menu, complete the following steps:

1. Turn on or restart the computer.
2. Repeatedly press **F10** when the monitor light turns green to access the utility.

You can also press **Esc** to a menu that allows you to access different options available at startup, including the Computer Setup utility.



NOTE: If you do not press **F10** at the appropriate time, you must restart the computer and again repeatedly press **F10** when the monitor light turns green to access the utility.

3. A choice of five headings appears in the Computer Setup Utilities menu: File, Storage, Security, Power, and Advanced.
4. Use the arrow (left and right) keys to select the appropriate heading. Use the arrow (up and down) keys to select the option you want, then press **Enter**. To return to the Computer Setup Utilities menu, press **Esc**.
5. To apply and save changes, select **File > Save Changes and Exit**.
 - If you have made changes that you do not want applied, select **Ignore Changes and Exit**.
 - To reset to factory settings or previously saved default settings (some models), select **Apply Defaults and Exit**. This option will restore the original factory system defaults.



NOTE: Not all settings shown in the following sections are available for all models



CAUTION: Do NOT turn the computer power OFF while the BIOS is saving the Computer Setup (F10) changes because the CMOS could become corrupted. It is safe to turn off the computer only after exiting the F10 Setup screen.

Table 3-1 Computer Setup (F10) Utility

Heading	Table
File	Computer Setup—File on page 9
Storage	Computer Setup—Storage on page 10
Security	Computer Setup—Security on page 13
Power	Computer Setup—Power on page 17
Advanced	Computer Setup—Advanced on page 18

Computer Setup—File



NOTE: Support for specific Computer Setup options may vary depending on the hardware configuration.

Table 3-2 Computer Setup—File

Option	Description
System Information	Lists: <ul style="list-style-type: none">• Product name• SKU number• Processor type/speed/stepping• Cache size (L1/L2/L3) (dual core processors have this listed twice)• Installed memory size/speed, number of channels (single or dual) (if applicable)• Integrated MAC address for embedded, enabled NIC (if applicable)• System BIOS (includes family name and version)• Chassis serial number• Asset tracking number• ME firmware version• ME Management mode
About	Displays copyright notice.
Set Time and Date	Allows you to set system time and date.
Flash System ROM	Allows you to update the system ROM with a BIOS image file located on removable media.
Replicated Setup	Save to Removable Media Saves system configuration to a formatted USB flash media device. Restore from Removable Media Restores system configuration from a USB flash media device.
Default Setup	Save Current Settings as Default Saves the current system configuration settings as the default. Restore Factory Settings as Default Restores the factory system configuration settings as the default.
Apply Defaults and Exit	Applies the currently selected default settings and clears any established passwords.
Ignore Changes and Exit	Exits Computer Setup without applying or saving any changes.
Save Changes and Exit	Saves changes to system configuration or default settings and exits Computer Setup.

Computer Setup—Storage



NOTE: Support for specific Computer Setup options may vary depending on the hardware configuration.

Table 3-3 Computer Setup—Storage

Option	Description
Device Configuration	<p>Lists all installed BIOS-controlled storage devices.</p> <p>When a device is selected, detailed information and options are displayed. The following options may be presented:</p> <ul style="list-style-type: none">• Hard Disk: Size, model, firmware version, serial number, connector color. <p>Translation mode (ATA disks only)</p> <p>Lets you select the translation mode to be used for the device. This enables the BIOS to access disks partitioned and formatted on other systems and may be necessary for users of older versions of UNIX (e.g., SCO UNIX version 3.2). Options are Automatic, Bit-Shift, LBA Assisted, User, and Off.</p> <p>Available only when the drive translation mode is set to User, allows you to specify the parameters (logical cylinders, heads, and sectors per track) used by the BIOS to translate disk I/O requests (from the operating system or an application) into terms the hard drive can accept. Logical cylinders may not exceed 1024. The number of heads may not exceed 256. The number of sectors per track may not exceed 63.</p> <p>CAUTION: Ordinarily, the translation mode selected automatically by the BIOS should not be changed. If the selected translation mode is not compatible with the translation mode that was active when the disk was partitioned and formatted, the data on the disk will be inaccessible.</p> <ul style="list-style-type: none">• CD-ROM: Model, firmware version, serial number, connector color (not included for USB CD-ROM).• SSD Life Used <p>NOTE: Displays for solid-state drives.</p> <ul style="list-style-type: none">• SMART (ATA disks only)• Diskette: Model and firmware version. <p>NOTE: Displays for USB diskette drives.</p> <ul style="list-style-type: none">• Default Values (ATA disks only) <p>See Translation Mode above for details.</p> <p>SATA Defaults</p>

Table 3-3 Computer Setup—Storage (continued)

Storage Options	eSATA Port
	<p>Allows you to set a SATA port as an eSATA port for use with an external drive. Default is enabled.</p>
	<p>This setting affects only the port with the black connector, labeled as eSATA on the system board. This port should have the eSATA back panel connector attached to use eSATA drives. For more information, see the eSATA white paper at www.hp.com.</p>
	<p>SATA Emulation</p>
	<p>Allows you to choose how the SATA controller and devices are accessed by the operating system. There are three supported options: IDE, RAID, and AHCI (default).</p>
	<p>CAUTION: SATA emulation changes may prevent access to existing hard drive data and degrade or corrupt established volumes.</p>
	<p>IDE - This is the most backwards-compatible setting of the three options. Operating systems usually do not require additional driver support in IDE mode.</p>
	<p>RAID - Allows DOS and boot access to RAID volumes. Use this mode with the RAID device driver loaded in the operating system to take advantage of RAID features.</p>
	<p>AHCI (default option) - Allows operating systems with AHCI device drivers loaded to take advantage of more advanced features of the SATA controller.</p>
	<p>NOTE: The RAID/AHCI device driver must be installed prior to attempting to boot from a RAID/AHCI volume. If you attempt to boot from a RAID/AHCI volume without the required device driver installed, the system will crash (blue screen). RAID volumes may become corrupted if they are booted to after disabling RAID.</p>
	<p>Removable Media Boot</p>
	<p>Enables/disables ability to boot the system from removable media. Default is enabled.</p>
	<p>Max eSATA Speed</p>
	<p>Allows you to choose 1.5 Gbps or 3.0 Gbps as the maximum eSATA speed. By default, the speed is limited to 1.5 Gbps for maximum reliability.</p>
	<p>CAUTION: Consult your eSATA drive and cable manufacturer before enabling 3.0 Gbps speed. Some drive and cable combinations may not run reliably at 3.0 Gbps.</p>

Table 3-3 Computer Setup—Storage (continued)

DPS Self-Test	<p>Allows you to execute self-tests on ATA hard drives capable of performing the Drive Protection System (DPS) self-tests.</p> <p>NOTE: This selection will only appear when at least one drive capable of performing the DPS self-tests is attached to the system.</p>
Boot Order	<p>Allows you to:</p> <ul style="list-style-type: none">• EFI Boot Sources: Specify the order in which EFI boot sources (such as a internal hard drive, USB hard drive, USB optical drive, or internal optical drive) are checked for a bootable operating system image. Each device on the list may be individually excluded from or included for consideration as a bootable operating system source. <p>EFI boot sources always have precedence over legacy boot sources.</p> <ul style="list-style-type: none">• Legacy Boot Sources: Specify the order in which legacy boot sources (such as a network interface card, internal hard drive, USB optical drive, or internal optical drive) are checked for a bootable operating system image. Each device on the list may be individually excluded from or included for consideration as a bootable operating system source. <p>Specify the order of attached hard drives. The first hard drive in the order will have priority in the boot sequence and will be recognized as drive C (if any devices are attached).</p> <p>NOTE: To drag a device to a preferred place, press Enter. To remove the device from consideration as a bootable device, press F5.</p> <p>You can use F5 to disable individual boot items, as well as disable EFI boot and/or legacy boot.</p> <p>NOTE: MS-DOS drive lettering assignments may not apply after a non-MS-DOS operating system has started.</p> <p>Shortcut to Temporarily Override Boot Order</p> <p>To boot one time from a device other than the default device specified in Boot Order, restart the computer and press Esc (to access the boot menu) and then F9 (Boot Order), or only F9 (skipping the boot menu) when the monitor light turns green. After POST is completed, a list of bootable devices is displayed. Use the arrow keys to select the preferred bootable device and press Enter. The computer then boots from the selected non-default device for this one time.</p>

Computer Setup—Security

 **NOTE:** Support for specific Computer Setup options may vary depending on the hardware configuration.

Table 3-4 Computer Setup—Security

Option	Description
Setup Password	<p>Allows you to set and enable a setup (administrator) password.</p> <p>NOTE: If the setup password is set, it is required to change Computer Setup options, flash the ROM, and make changes to certain plug and play settings under Windows.</p>
Power-On Password	<p>Allows you to set and enable a power-on password. The power-on password prompt appears after a power cycle or reboot. If the user does not enter the correct power-on password, the unit will not boot.</p>
Password Options (This selection appears only if a power-on password or setup password is set.)	<p>Allows you to enable/disable:</p> <ul style="list-style-type: none">• Lock Legacy Resources (determines whether or not Windows Device Manager is allowed to change resource settings for serial and parallel ports).• Setup Browse Mode (appears if a setup password is set) (allows viewing, but not changing, the F10 Setup Options without entering setup password). Default is enabled.• Password prompt on F9 & F12 (requires setup password to use these boot functions). Default is enabled.• Network Server Mode. Default is disabled.
Smart Cover	<p>Allows you to:</p> <ul style="list-style-type: none">• Lock/unlock the Cover Lock.• Set the Cover Removal Sensor to Disable/Notify User/Setup Password. <p>NOTE: <i>Notify User</i> alerts the user that the sensor has detected that the cover has been removed. <i>Setup Password</i> requires that the setup password be entered to boot the computer if the sensor detects that the cover has been removed.</p>
Device Security	<p>Allows you to set Device Available/Device Hidden (default is Device Available) for:</p> <ul style="list-style-type: none">• Embedded security device• System audio• USB controller (varies by model)• Network controller <p>NOTE: You must disable AMT before trying to hide the network controller.</p> <ul style="list-style-type: none">• Serial port• Parallel port• SATA ports (varies by model)
USB Security	<p>Allows you to set Enabled/Disabled (default is Enabled) for:</p> <ul style="list-style-type: none">• Front USB Ports• Rear USB Ports• Accessory USB Ports

Table 3-4 Computer Setup—Security (continued)

Slot Security	Allows you to disable any PCI or PCI Express slot. Default is enabled.
Network Boot	Enables/disables the computer's ability to boot from an operating system installed on a network server. (Feature available on NIC models only; the network controller must be either a PCI expansion card or embedded on the system board.) Default is enabled.
System IDs	<p>Allows you to set:</p> <ul style="list-style-type: none">• Asset tag (18-byte identifier), a property identification number assigned by the company to the computer.• Ownership tag (80-byte identifier) displayed during POST.• Universal Unique Identifier (UUID) number. The UUID can only be updated if the current chassis serial number is invalid. (These ID numbers are normally set in the factory and are used to uniquely identify the system.)• Keyboard locale setting for System ID entry.
Master Boot Record Security	<p>Enables/disables Master Boot Record (MBR) security.</p> <p>The MBR contains information needed to successfully boot from a disk and to access the data stored on the disk. Master Boot Record Security may prevent unintentional or malicious changes to the MBR, such as those caused by some viruses or by the incorrect use of certain disk utilities. It also allows you to recover the "last known good" MBR, should changes to the MBR be detected when the system is restarted.</p> <p>When MBR Security is enabled, the BIOS prevents any changes being made to the MBR of the current bootable disk while in MS-DOS or Windows Safe Mode.</p> <p>NOTE: Most operating systems control access to the MBR of the current bootable disk; the BIOS cannot prevent changes that may occur while the operating system is running.</p> <p>Restores the backup Master Boot Record to the current bootable disk. Default is disabled.</p> <p>Only appears if all of the following conditions are true:</p> <ul style="list-style-type: none">• MBR security is enabled• A backup copy of the MBR has been previously saved• The current bootable disk is the same disk from which the backup copy was saved <p>CAUTION: Restoring a previously saved MBR after a disk utility or operating system has modified the MBR, may cause the data on the disk to become inaccessible. Only restore a previously saved MBR if you are confident that the current bootable disk's MBR has been corrupted or infected with a virus.</p>

Table 3-4 Computer Setup—Security (continued)

System Security (these options are hardware dependent)	<p>Data Execution Prevention (enable/disable) - Helps prevent operating system security breaches. Default is enabled.</p> <p>SVM CPU Virtualization (enable/disable). Controls the virtualization features of the processor. Changing this setting requires turning the computer off and then back on. Default is disabled.</p> <p>Virtualization Technology (VTx) (enable/disable) - Controls the virtualization features of the processor. Changing this setting requires turning the computer off and then back on. Default is disabled.</p> <p>Virtualization Technology Directed I/O (VTd) (enable/disable) - Controls virtualization DMA remapping features of the chipset. Changing this setting requires turning the computer off and then back on. Default is disabled.</p> <p>Trusted Execution Technology (enable/disable) - Controls the underlying processor and chipset features needed to support a virtual appliance. Changing this setting requires turning the computer off and then back on. Default is disabled. To enable this feature you must enable the following features:</p> <ul style="list-style-type: none">• Embedded Security Device Support• Virtualization Technology• Virtualization Technology Directed I/O <p>Embedded Security Device (enable/disable) - Permits activation and deactivation of the Embedded Security Device.</p> <p>NOTE: To configure the Embedded Security Device, a Setup password must be set.</p> <ul style="list-style-type: none">• Reset to Factory Settings (Do not reset/Reset) - Resetting to factory defaults will erase all security keys and leave the device in a disabled state. Changing this setting requires that you restart the computer. Default is Do not reset. <p>CAUTION: The embedded security device is a critical component of many security schemes. Erasing the security keys will prevent access to data protected by the Embedded Security Device. Choosing Reset to Factory Settings may result in significant data loss.</p> <ul style="list-style-type: none">• Measure boot variables/devices to PCR1 - Typically, the computer measures the boot path and saves collected metrics to PCR5 (a register in the Embedded Security Device). Bitlocker tracks changes to any of these metrics, and forces the user to re-authenticate if it detects any changes. Enabling this feature lets you set Bitlocker to ignore detected changes to boot path metrics, thereby avoiding re-authentication issues associated with USB keys inserted in a port. Default is enabled.
System Security (continued)	<p>OS management of Embedded Security Device (enable/disable) - This option allows the user to limit OS control of the Embedded Security Device. Default is enabled. This option is automatically disabled if Trusted Execution Technology is enabled.</p> <ul style="list-style-type: none">• Reset of Embedded Security Device through OS (enable/disable) - This option allows the user to limit the operating system ability to request a Reset to Factory Settings of the Embedded Security Device. Default is disabled. <p>NOTE: To enable this option, a Setup password must be set.</p> <ul style="list-style-type: none">• No PPI provisioning (Windows 8 only) - This option lets you set Windows 8 to bypass the PPI (Physical Presence Interface) requirement and directly enable and take ownership of the TPM on first boot. You cannot change this setting after TPM is owned/initialized, unless the TPM is reset. Default is disabled for non-Windows 8 systems, and enabled for Windows 8.• Allow PPI policy to be changed by OS. Enabling this option allows the operating system to execute TPM operations without Physical Presence Interface. Default is disabled. <p>NOTE: To enable this option, a Setup password must be set.</p>

Table 3-4 Computer Setup—Security (continued)

DriveLock Security	Allows you to assign or modify a master or user password for hard drives. When this feature is enabled, the user is prompted to provide one of the DriveLock passwords during POST. If neither is successfully entered, the hard drive will remain inaccessible until one of the passwords is successfully provided during a subsequent cold-boot sequence.
	NOTE: This selection will only appear when at least one drive that supports the DriveLock feature is attached to the system.
Secure Boot Configuration	This is a feature of Windows 8. <ul data-bbox="507 470 1430 1115" style="list-style-type: none"><li data-bbox="507 470 1430 575">• Legacy Support—Enable/Disable. Allows you to turn off all legacy support on the computer, including booting to DOS, running legacy graphics cards, booting to legacy devices, and so on. If set to disable, legacy boot options in Storage > Boot Order are not displayed. Default is enabled.<li data-bbox="507 600 1430 758">• Secure Boot—Enable/Disable. Allows you to make sure an operating system is legitimate before booting to it, making Windows resistant to malicious modification from preboot to full OS booting, preventing firmware attacks. UEFI and Windows Secure Boot only allow code signed by pre-approved digital certificates to run during the firmware and OS boot process. Default is disabled, except for Windows 8 systems which have this setting enabled. Secure Boot enabled also sets Legacy Support to disabled.<li data-bbox="507 783 1430 1115">• Key Management—This option lets you manage the custom key settings.<ul data-bbox="555 831 1430 1041" style="list-style-type: none"><li data-bbox="555 831 1430 884">◦ Clear Secure Boot Keys—Don't Clear/Clear. Allows you to delete any previously loaded custom boot keys. Default is Don't Clear.<li data-bbox="555 909 1430 1041">◦ Key Ownership—HP Keys/Custom Keys. Selecting Custom Mode allows you to modify the contents of the secure boot signature databases and the platform key (PK) that verifies kernels during system start up, allowing you to use alternative operating systems. Selecting HP Keys causes the computer boot using the preloaded HP-specific boot keys. Default is HP Keys.<li data-bbox="507 1066 1430 1115">• Fast Boot—Enable/Disable. Fast boot disables the ability to interrupt boot, such as pressing f keys to access items before the operating system loads. Default is disabled. <p data-bbox="555 1140 1430 1192">NOTE: If Windows 8 detects a serious error, it will interrupt the boot process automatically and display advanced boot options.</p> <p data-bbox="555 1218 1430 1268">From Windows 8, you can press Shift and select Restart to access the screen that lets you boot to a device or troubleshoot your computer.</p>

Computer Setup—Power



NOTE: Support for specific Computer Setup options may vary depending on the hardware configuration.

Table 3-5 Computer Setup—Power

Option	Description
OS Power Management	<ul style="list-style-type: none"> Idle Power Savings—Extended/Normal. Allows certain operating systems to decrease the processors power consumption when the processor is idle. Default is extended. Runtime Power Management— Enable/Disable. Allows certain operating systems to reduce processor voltage and frequency when the current software load does not require the full capabilities of the processor. Default is enabled. Unique Sleep State Blink Rates—Enable/Disable. This feature is designed to provide a visual indication of what sleep state the system is in. Each sleep state has a unique blink pattern. Default is disabled. <p>NOTE: For Windows 8 systems with Fast Boot support, a normal shutdown goes to the S4 state, not the S5 state.</p> <ul style="list-style-type: none"> S0 (On) = Solid green LED. S3 (Stand By)= 3 blinks at 1Hz (50% duty cycle) followed by a pause of 2 seconds (green LED) — repeated cycles of 3 blinks and a pause. S4 (Hibernation)= 4 blinks at 1Hz (50% duty cycle) followed by a pause of 2 seconds (green LED) — repeated cycles of 4 blinks and a pause. S5 (Soft Off) = LED is off.
Hardware Power Management	<p>SATA Power Management – Enables or disables SATA bus and/or device power management. Default is enabled.</p> <p>S5 Maximum Power Savings – Turns off power to all nonessential hardware when system is off to meet EUP Lot 6 requirement of less than 0.5 Watt power usage. Default is disabled.</p> <p>PCI Express x16 Slot 1 – Sets Active State Power Management (ASPM) of the bus. ASPM lets you set lower power modes that activate when the bus is not being used. Options are Disabled, LOs, L1, LOs and L1. Default is ASPM Disabled.</p> <p>PCI Express x1 Slot 1 – Sets Active State Power Management (ASPM) of the bus. ASPM lets you set lower power modes that activate when the bus is not being used. Options are Disabled, LOs, L1, LOs and L1. Default is ASPM Disabled.</p> <p>Network Controller – Sets ASPM of the bus. ASPM lets you set lower power modes that activate when the bus is not being used. Options are Disabled, LOs, L1, LOs and L1. Default is ASPM Disabled.</p> <p>USB 3.0 Controller – Sets ASPM of the bus. ASPM lets you set lower power modes that activate when the bus is not being used. Options are Disabled, LOs, L1, LOs and L1. Default is ASPM Disabled.</p>
Thermal	<p>Fan idle mode—This bar graph controls the minimum permitted fan speed.</p> <p>NOTE: This setting only changes the minimum fan speed. The fans are still automatically controlled.</p>

Computer Setup—Advanced



NOTE: Support for specific Computer Setup options may vary depending on the hardware configuration.

Table 3-6 Computer Setup—Advanced (for advanced users)

Option	Heading
Power-On Options	<p>Allows you to set:</p> <ul style="list-style-type: none">• POST mode (QuickBoot, Clear Memory, FullBoot, or FullBoot Every x Days).<ul style="list-style-type: none">◦ QuickBoot (default) = Do not clear memory or perform a memory test.◦ FullBoot = Memory test (count) on cold boot. Clears memory on all boots.◦ Clear Memory = No memory count on cold boot. Clears memory on all boots.◦ FullBoot Every x Days = Memory count on 1st cold boot on or after the xth day. No more memory counts until 1st cold boot on or after x days. Clears memory on all boots.• POST messages (enable/disable). Enabling this feature will cause the system to display POST error messages, which are error messages displayed on the monitor during the Power On Self Test if the BIOS encounters some kind of problem while starting the PC. A POST error message will only display on screen if the computer is capable of booting this far. If the POST detects an error before this point, a beep code is generated instead. Default is disabled.• Press the ESC key for Startup Menu (Enable/Disable). This feature controls the display of the text "Press the ESC key for Startup Menu" during POST. This text does not display on Windows 8 systems with Fast Boot support. Other text also will not display (for example, Ownership Tag). Default is enabled.• Option ROM Prompt (enable/disable). Enabling this feature will cause the system to display a message before loading option ROMs. Default is enabled.• After Power Loss (off/on/previous state). Default is Power off. Setting this option to:<ul style="list-style-type: none">◦ Power off—causes the computer to remain powered off when power is restored.◦ Power on—causes the computer to power on automatically as soon as power is restored.◦ Previous state—causes the computer to power on automatically as soon as power is restored, if it was on when power was lost. <p>NOTE: If you turn off power to the computer using the switch on a power strip, you will not be able to use the suspend/sleep feature or the Remote Management features.</p> <ul style="list-style-type: none">• POST Delay (in seconds). Enabling this feature will add a user-specified delay to the POST process. This delay is sometimes needed for hard disks on some PCI cards that spin up very slowly, so slowly that they are not ready to boot by the time POST is finished. The POST delay also gives you more time to select F10 to enter Computer (F10) Setup. Default is None.• Remote Wakeup Boot Source (remote server/local hard drive). Default is Local hard drive.• Factory Recovery Boot Support (Enable/Disable). Provides the ability for the BIOS to redirect the boot to the recovery partition on the user hard drive, if present. Some versions of the recovery software honor the F11 key press even when this feature is disabled by the BIOS. Default is disabled.• Bypass F1 Prompt on Configuration Changes (Enable/Disable). Allows you to set the computer not to confirm when changes were made. Default is disabled.

Table 3-6 Computer Setup—Advanced (for advanced users) (continued)

BIOS Power-On	Allows you to set the computer to turn on automatically at a time you specify.
Onboard Devices	<p>Allows you to set resources for or disable Legacy devices.</p> <p>Select the Legacy device's IRQ, DMA, and I/O Range. The settings may not take effect for all operating systems. To hide a device from the operating system, see Security > Device Security.</p>
Bus Options	<p>Allows you to enable or disable:</p> <ul style="list-style-type: none">• PCI SERR# Generation. Default is enabled.• PCI VGA Palette Snooping, which sets the VGA palette snooping bit in PCI configuration space; only needed when more than one graphics controller is installed. Default is disabled.
Device Options	<p>Allows you to set:</p> <ul style="list-style-type: none">• Printer mode (Bi-Directional, EPP + ECP, Output Only). ECP = Enhanced Capabilities Port, EPP = Enhanced Parallel Port. Default is EPP+ECP.• Num Lock State at Power-On (off/on). Default is off.• Integrated Video (enable/disable). Use this option to disable the integrated video controller when another video controller is present in the system. Default is enabled.• Integrated Graphics (Auto/Disable/Force) Use this option to manage integrated (UMA) graphics memory allocation. The value you choose is allocated permanently to graphics and is unavailable to the operating system. For example, if you set this value to 512M on a system with 2 GB of RAM, the system always allocates 512 MB for graphics and the other 1.5 GB for use by the BIOS and operating system. Default is Auto which sets memory allocation to 512 MB. <p>If you select Force, the UMA Frame Buffer Size option displays, which lets you set the UMA memory size allocation between 32 MB and 1 GB.</p> <ul style="list-style-type: none">• Internal Speaker (does not affect external speakers). Default is enabled.• NIC PXE Option ROM Download (PXE, iSCSI, disabled). The BIOS contains an embedded NIC option ROM to allow the unit to boot through the network to a PXE server. This is typically used to download a corporate image to a hard drive. The NIC option ROM takes up memory space below 1MB commonly referred to as DOS Compatibility Hole (DCH) space. This space is limited. This F10 option will allow users to disable the downloading of this embedded NIC option ROM thus giving more DCH space for additional PCI cards which may need option ROM space. The default will be to have the NIC option-ROM-enabled. Default is PXE.• SATA RAID Option ROM Download (enable/disable). The BIOS contains an embedded SATA RAID option ROM for RAID support. This can be temporarily disabled to save DCH space. Note that with the option ROM disabled, users will be unable to boot to hard drives in the system while running in RAID mode. Default is disabled.• Multi-Processor (enable/disable). Use this option to disable multi-processor support under the OS. Default is enabled.• Hyper threading (enable/disable). Use this option to disable processor hyper-threading.• Turbo Mode (enable/disable). Allows you to enable and disable the Intel Turbo Mode feature, which allows one core of the system to run at a higher than standard frequency and power if other cores are idle. Default is enabled.

Table 3-6 Computer Setup—Advanced (for advanced users) (continued)

VGA Configuration	Displayed only if there is an add-in video card in the system. Allows you to specify which VGA controller will be the “boot” or primary VGA controller.
AMT Configuration	Allows you to set: <ul style="list-style-type: none">• AMT (enable/disable). Allows you to enable or disable functions of the embedded Management Engine (ME) such as Active Management Technology (AMT). If set to disable, the Management Engine is set to a temporarily disabled state and will not provide functions beyond necessary system configuration. Default is enabled.• Unconfigure AMT/ME (enable/disable). Allows you to unconfigure any provisioned management settings for AMT. The AMT settings are restored to factory defaults. This feature should be used with caution as AMT will not be able to provide any set AMT management functions once unconfigured. Default is disabled.• Hide Unconfigure ME Confirmation Prompt (enable/disable). Allows you to set the system to not display the confirmation to unconfigure ME.• Watchdog Timer (enable/disable). Allows you to set amount of time for a operating system and BIOS watchdog alert to be sent if the timers are not deactivated. BIOS watchdog is deactivated by BIOS and would indicate that a halt occurred during execution if the alert is sent to the management console. An operating system alert is deactivated by the operating system image and would indicate that a hang occurred during its initialization. Default is enabled.

Recovering the Configuration Settings

This method of recovery requires that you first perform the **Save to Removable Media** command with the Computer Setup (F10) Utility before **Restore** is needed. (See [Computer Setup—File on page 9](#) in the Computer Setup—File table.)



NOTE: It is recommended that you save any modified computer configuration settings to a USB flash media device and save the device for possible future use.

To restore the configuration, insert the USB flash media device with the saved configuration and perform the **Restore from Removable Media** command with the Computer Setup (F10) Utility. (See [Computer Setup—File on page 9](#) in the Computer Setup—File table.)

4 Illustrated parts catalog

This chapter provides spare part information for all chassis.

Microtower (MT) Chassis Spare Parts

Computer Major Components

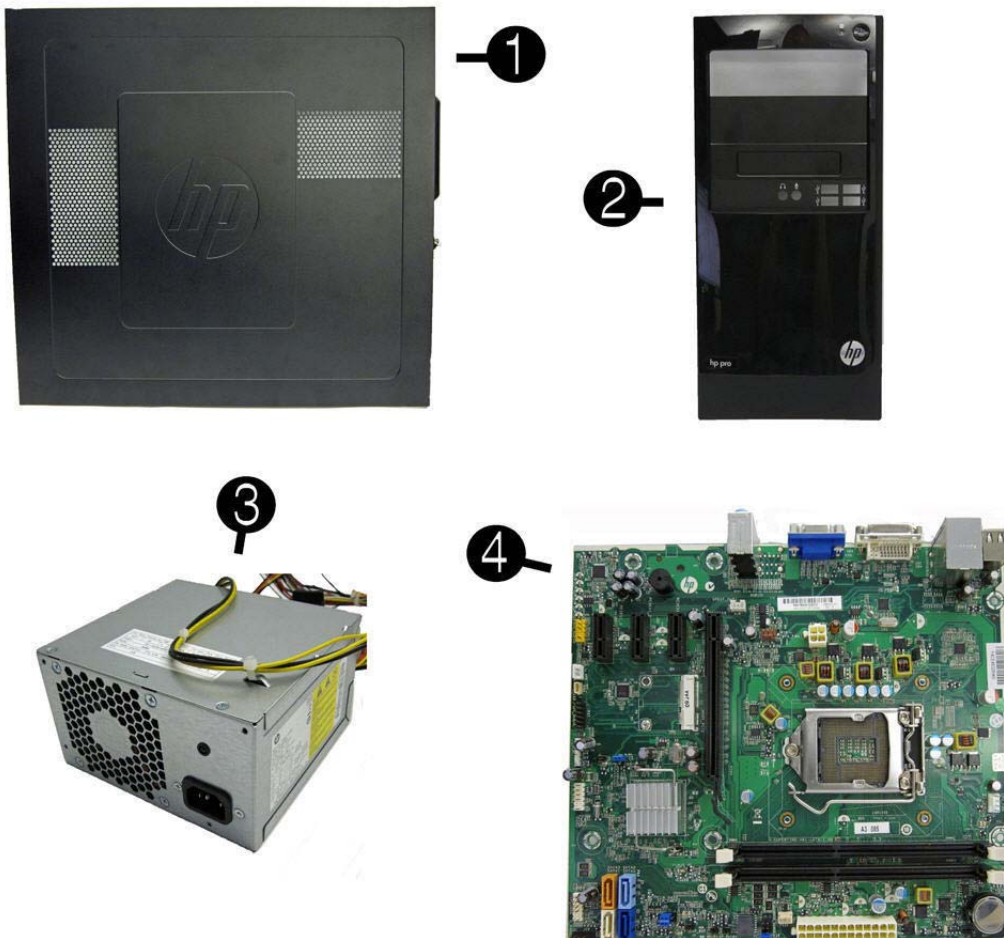

Item	Description	Spare part number
(1)	Access panel	657104-001
(2)	Front bezel	
	For use on 3300/3305 models	657109-001
	For use on 7500/7300 models (not illustrated; bezel is identical except for branding)	657112-001
(3)	Power supply, 300W	656721-001
(4)	System board (includes replacement thermal material)	
	For use in models with AMD processors on 3305 models	638404-001
	For use in models with 65W Intel processors on 3300 models	656598-001
	For use in models with 95W Intel processors on 3300 models	660281-001
	For use in models with Intel processors on 7300 models	656599-001
	For use in models with Intel processors on 7500 models without Windows 8	687940-001
	For use in 7500 models with Windows 8 with no Digital Product Key (DPK)	696887-001
	For use in 7500 models with Windows 8 Standard	696887-501
	For use in 7500 models with Windows 8 Professional	696887-601
	Memory modules (not illustrated)	
	PC3-10600, 1333-MHz for use in 7300 and 3300 series models	
	<ul style="list-style-type: none"> 4-GB 	585157-001
	<ul style="list-style-type: none"> 2-GB 	635803-001
	<ul style="list-style-type: none"> 1-GB 	635802-001
	PC3-12800, 1666-MHz for use in 7500 models	
	<ul style="list-style-type: none"> 4-GB 	671613-001
	<ul style="list-style-type: none"> 2-GB 	671612-001
	Processors (include replacement thermal material; not illustrated)	
	Intel processors	
	Intel Core i7:	
	<ul style="list-style-type: none"> 3770K (3.5-GHz, 8-MB L3 cache, 77W) for use only on 7500 models 	688165-001
	<ul style="list-style-type: none"> 3770 (3.4-GHz, 8-MB L3 cache, 77W) for use only on 7500 models 	688164-001
	<ul style="list-style-type: none"> 2600S (2.8-GHz, 8-MB L3 cache, 65W) 	638419-001
	Intel Core i5:	
	<ul style="list-style-type: none"> 3570K (3.4-GHz, 6-MB L3 cache, 77W) for use only on 7500 models 	688163-001
	<ul style="list-style-type: none"> 3570 (3.4-GHz, 6-MB L3 cache, 77W) for use only on 7500 models 	688162-001
	<ul style="list-style-type: none"> 3550 (3.3-GHz, 6-MB L3 cache, 77W) for use only on 7500 models 	687944-001
	<ul style="list-style-type: none"> 3470 (3.2-GHz, 6-MB L3 cache, 77W) for use only on 7500 models 	687943-001
	<ul style="list-style-type: none"> 3450 (3.1-GHz, 6-MB L3 cache, 77W) for use only on 7500 models 	687942-001

Item	Description	Spare part number
	• 3330 (3.0-GHz, 6-MB L3 cache, 77W) for use only on 7500 models	687941-001
	• 2500S (2.7-GHz, 6-MB L3 cache, 65W)	638420-001
	• 2500 (3.3-GHz, 6-MB L3 cache, 65W) for use in 7500/7300 models	638631-001
	• 2405S (2.5-GHz, 6-MB L3 cache, 65W)	656790-001
	• 2400S (2.5-GHz, 6-MB L3 cache, 65W)	640953-001
	• 2400 (3.1-GHz, 6-MB L3 cache, 65W) for use in 7500/7300 models	638630-001
	• 2320 (3.0 GHz, 6-MB L3 cache, 95W) for use in 3300 series models	665121-001
	• 2310 (2.9-GHz, 6-MB L3 cache, 65W) for use in 7500/7300 models	657111-001
	• 2300 (2.8-GHz, 6-MB L3 cache, 65W) for use in 7500/7300 models	654601-001
	Intel Core i3:	
	• 3240 (3.4 GHz, 3-MB L3 cache, 65W) for use in 7500 series models	688951-001
	• 3220 (3.3 GHz, 3-MB L3 cache, 65W) for use in 7500 series models	688950-001
	• 2125 (3.3 GHz, 3-MB L3 cache, 65W) for use in 3300 series models	677427-001
	• 2120 (3.3-GHz, 3-MB L3 cache, 65W)	638629-001
	• 2105 (3.1-GHz, 3-MB L3 cache, 65W)	655970-001
	• 2100 (3.1-GHz, 3-MB L3 cache, 65W)	638628-001
	Intel Pentium Dual-Core:	
	• G870 (3.1 GHz, 3-MB L3 cache, 65W)	691936-001
	• G860 (3.0 GHz, 3-MB L3 cache, 65W)	665122-001
	• G850 (2.9-GHz, 3-MB L3 cache, 65W)	655973-001
	• G840 (2.8-GHz, 3-MB L3 cache, 65W)	655972-001
	• G640 (2.8 GHz, 3-MB L3 cache, 65W)	691935-001
	• G630 (2.7 GHz, 3-MB L3 cache, 65W)	665123-001
	• G620 (2.6-GHz, 3-MB L3 cache, 65W)	655971-001
	Intel Celeron:	
	• G55 (3.3 GHz, 2-MB L3 cache, 65W)	691934-001
	AMD processors (for use in model 3305)	
	Phenom II	
	• X6 1065T, quad core, 2-MB L2 cache, 2.9 GHz, E0	666426-001
	• X6 1055T, quad core, 2-MB L2 cache, 2.8 GHz, C3	617838-001
	• X6 1035T, quad core, 2-MB L2 cache, 2.6 GHz, C3	617837-001
	• X4 z960T, dual core, 1-MB cache, 3.0 GHz, E0	632923-001
	• X4 z840T, dual core, 1-MB cache, 2.9 GHz, E0	638410-001
	• X2 565, dual core, 1-MB cache, 3.4 GHz, C3	657101-001

Item	Description	Spare part number
	<ul style="list-style-type: none"> • X2 560, dual core, 1-MB cache, 3.3 GHz, C3 	657100-001
	<ul style="list-style-type: none"> • X2 550, dual core, 1-MB cache, 3.1 GHz, C3 	614518-001
	Athlon II X4	
	<ul style="list-style-type: none"> • 650, dual core, 2-MB cache, 3.2 GHz, C3 	638004-001
	<ul style="list-style-type: none"> • X4 645, dual core, 2-MB cache, 3.1 GHz, C3 	628883-001
	<ul style="list-style-type: none"> • X4 635, dual core, 2-MB cache, 2.9 GHz, C3 	617834-001
	<ul style="list-style-type: none"> • X3 455, dual core, 1.5-MB cache, 3.3 GHz, C3 	638003-001
	<ul style="list-style-type: none"> • X3 450, dual core, 1.5-MB cache, 3.2 GHz, C3 	628882-001
	<ul style="list-style-type: none"> • X2 270, dual core, 1-MB cache, 3.4 GHz, C3 	632922-001
	<ul style="list-style-type: none"> • X2 265, dual core, 1-MB cache, 3.3 GHz, C3 	632921-001
		628881-001
	<ul style="list-style-type: none"> • X2 260, dual core, 1-MB cache, 3.2 GHz, C3 	614513-001
	<ul style="list-style-type: none"> • X2 220, dual core, 1-MB cache, 2.8 GHz, C2 	611192-001
	Sempron	
	<ul style="list-style-type: none"> • 145, single core, 1-MB cache, 2.9 GHz, C3 	638005-001

Cables

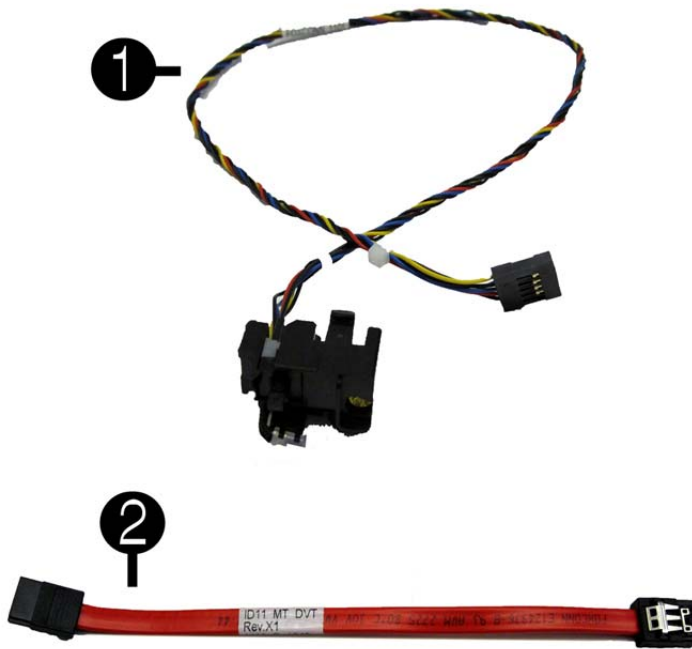

Item	Description	Spare part number
(1)	Power switch/LED assembly	657105-001
(2)	SATA cable, 165 mm	657102-001
	Adapter, DVI to VGA, HF	657401-001
	Adapter, DVI to VGA, 29-pin, HF	657851-001
	Antenna, for use with 2x2 WLAN modules	593890-001
	Antenna, for use with 1x1 WLAN modules	701397-001

Misc Parts

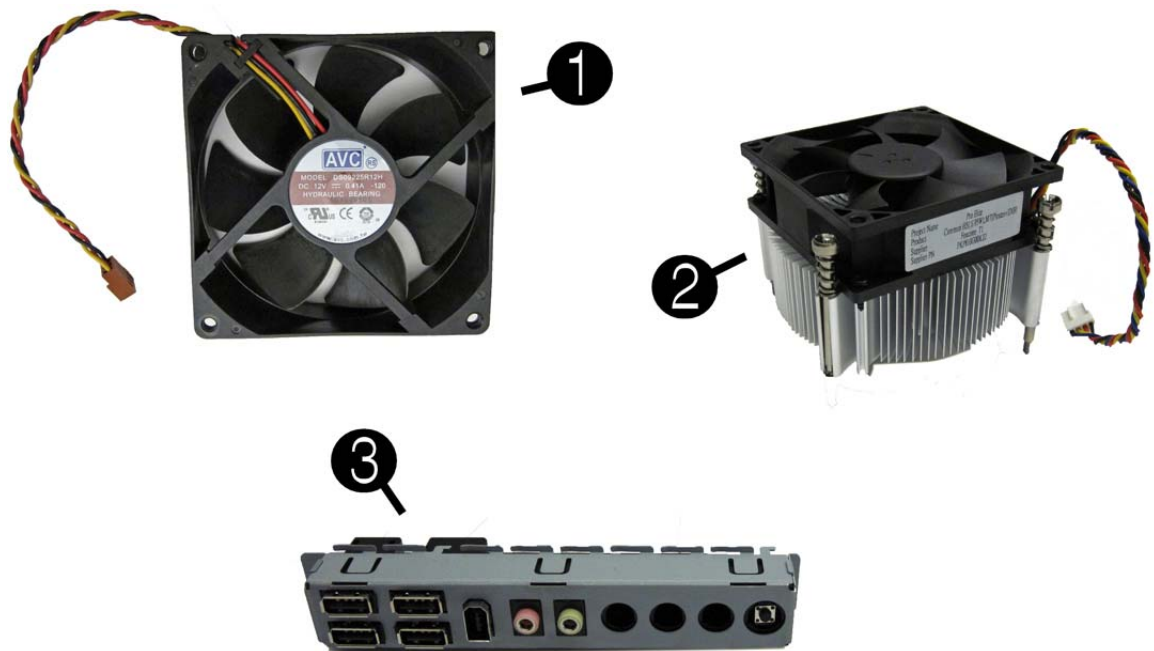

Item	Description	Spare part number
(1)	Chassis fan	657103-001
(2)	Fan sink (includes replacement thermal material)	
	For use in models with Intel processors	657402-001
	For use in models with AMD processors	656985-001
(3)	Front I/O and USB assembly	
	For use on 3300/3305 models	657110-001
	For use on 7500/7300 models	657113-001
	Card reader (not illustrated)	
	15-in-1 card reader assembly	657099-001
	Card reader bezel blank	657853-001
	Card reader bezel	657854-001
	RTC battery (not illustrated)	319603-001
	Mouse (optical, USB; not illustrated)	596410-001
	RTC battery	319603-001
	Rubber feet (not illustrated)	530593-001

Drives

Description	Spare part number
Hard drive	
3-TB, 7200-rpm	696961-001
3-TB, 5400-rpm	668149-001
2-TB, 7200-rpm	616608-001
2-TB, 5400-rpm	613210-001
1.5-TB, 7200-rpm	613209-001
1.5-TB, 5400-rpm	652272-001
1-TB, 7200-rpm, 3G	621418-001
750-GB, 7200-rpm, 6G	639363-001
750-GB, 7200-rpm, 3G	632938-001
500-GB, 7200-rpm, 3G	621421-001
320-GB, 7200-rpm, 6G	636928-001
256-GB solid-state drive (SSD)	661842-001
128-GB solid-state drive (SSD)	665961-001
120-GB solid-state drive (SSD)	661841-001
Optical drive	
Blu-ray BD-RW SuperMulti DL Drive with LightScribe for use in 7500/7300 models	617030-001
16X SATA DVD±RW drive	581600-001
Bezel, optical drive	657852-001

Misc Boards

Description	Spare part number
Graphics adapters for use in models without Windows 8:	
ATI Radeon HD 7570 2-GB graphics adapter for use only on 7500 models	679219-001
ATI Radeon HD 7450 1-GB graphics adapter for use only on 7500 models	679218-001
ATI Radeon HD 6450 1-GB graphics adapter	638132-001
ATI Radeon HD 6570 2-GB graphics adapter, full height	638405-001
ATI Radeon HD 6570 1-GB graphics adapter	659355-001
ATI Radeon HD 6450 512-MB graphics adapter	647449-001
nVidia GeForce GT405 2-GB graphics adapter, full height	638406-001
nVidia GeForce GT405 512-MB graphics adapter	657108-001
nVidia GeForce GT520 1-GB graphics adapter, full height	657399-001

Description	Spare part number
nVidia GeForce GT530 2-GB graphics adapter, full height	657106-001
nVidia GeForce GT545 3-GB graphics adapter, full height	657107-001
nVidia GeForce GT620 1-GB graphics adapter, full height for use only on 7500 models	687579-001
nVidia GeForce GT630 2-GB graphics adapter, full height for use only on 7500 models	687580-001
nVidia GeForce GT640 3-GB graphics adapter, full height for use only on 7500 models	687226-001
Graphics adapters for use in models with Windows 8:	
ATI Radeon HD 7570 2-GB graphics adapter for use only on 7500 models with Windows 8	701403-001
ATI Radeon HD 7450 1-GB graphics adapter for use only on 7500 models with Windows 8	701402-001
nVidia GeForce GT640 3-GB graphics adapter for use only on 7500 models with Windows 8	701828-001
nVidia GeForce GT630 2-GB graphics adapter for use only on 7500 models with Windows 8	701405-001
nVidia GeForce GT620 1-GB graphics adapter for use only on 7500 models with Windows 8	701404-001
WLAN modules:	
Ralink RT5390R 802.11bgn 1x1 Wi-Fi Adapter for use in models with Windows 8	634906-001
Ralink RT5390R 802.11bgn 1x1 Wi-Fi Adapter	701396-001
Atheros AR9462 802.11b/g/n WiFi Adapter	701398-001
Ralink RT3290LE 802.11bgn 1x1 Wi-Fi and Bluetooth 4.0 Combo	701399-001

Sequential Part Number Listing

Spare part number	Description
319603-001	RTC battery (not illustrated)
530593-001	Rubber feet
581600-001	16X SATA DVD±RW drive
585157-001	Memory module, 4-GB, PC3 10600, 1333-MH
593890-001	Antenna, for use with 2x2 WLAN modules
596410-001	Mouse, USB, optical
611192-001	AMD Athlon II X2 220 processor, dual core, 1-MB cache, 2.8 GHz, C2
613209-001	1.5-TB hard drive
613210-001	2-TB, 5400-rpm hard drive
614513-001	AMD Athlon II X2 260 processor, dual core, 1-MB cache, 3.2 GHz, C3
614518-001	AMD Phenom II X2 550 processor, dual core, 1-MB cache, 3.1 GHz, C3
616608-001	2-TB, 7200-rpm hard drive
617030-001	Blu-ray BD-RW SuperMulti DL Drive with LightScribe for use in 7300/7500 models
617834-001	AMD Athlon II X4 635 processor, dual core, 2-MB cache, 2.9 GHz, C3

Spare part number	Description
617837-001	AMD Phenom II X6 1035T processor, quad core, 2-MB L2 cache, 2.6 GHz, C3
617838-001	AMD Phenom II X6 1055T processor, quad core, 2-MB L2 cache, 2.8 GHz, C3
621418-001	1-TB hard drive, 7200-rpm, 3G
621421-001	500-GB, 7200 RPM hard drive, 3G
628881-001	AMD Athlon II X2 265 processor, dual core, 1-MB cache, 3.3 GHz, C3
628882-001	AMD Athlon II X3 450 processor, dual core, 1.5-MB cache, 3.2 GHz, C3
628883-001	AMD Athlon II X4 645 processor, dual core, 2-MB cache, 3.1 GHz, C3
632921-001	AMD Athlon II X2 265, dual core, 1-MB cache, 3.3 GHz, C3
632922-001	AMD Athlon II X2 270 processor, dual core, 1-MB cache, 3.4 GHz, C3
632923-001	AMD Phenom II X4 z960T processor, dual core, 1-MB cache, 3.0 GHz, E0
632938-001	750-GB, 7200 RPM hard drive, 3G
634906-001	Ralink RT5390R 802.11bgn 1x1 Wi-Fi Adapter for use in models with Windows 8
635802-001	Memory module, 1-GB, PC3 10600, 1333-MHz for use in only 7300 models
635803-001	Memory module, 2-GB, PC3 10600, 1333-MHz for use in only 7300 models
636928-001	320-GB, 7200 RPM hard drive, 6G
638003-001	AMD Athlon II X3 455 processor, dual core, 1.5-MB cache, 3.3 GHz, C3
638004-001	AMD Athlon II X4 650 processor, dual core, 2-MB cache, 3.2 GHz, C3
638005-001	AMD Sempron 145 processor, single core, 1-MB cache, 2.9 GHz, C3
638132-001	ATI Radeon HD 6450 1-GB graphics adapter
638404-001	System board for use in models with AMD processors on 3305 models (includes replacement thermal material)
638405-001	ATI Radeon HD 6570 2-GB graphics adapter, full height
638406-001	nVidia GeForce GT405 2-GB graphics adapter, full height
638410-001	AMD Phenom II X4 z840T processor, dual core, 1-MB cache, 2.9 GHz, E0
638419-001	Intel Core i7 2600S processor (2.7-GHz, 8-MB L3 cache, 65W)
638420-001	Intel Core i5 2500S processor (2.7-GHz, 6-MB L3 cache, 65W)
638628-001	Intel Core i3 2100 processor (3.1-GHz, 3-MB L3 cache, 65W)
638629-001	Intel Core i3 2120 processor (3.3-GHz, 3-MB L3 cache, 65W)
638630-001	Intel Core i5 2400 processor (3.1-GHz, 6-MB L3 cache, 65W) for use in 7500/7300 models
638631-001	Intel Core i5 2500 processor (3.3-GHz, 6-MB L3 cache, 65W) for use in 7500/7300 models
640953-001	Intel Core i5 2400S processor (2.5-GHz, 6-MB L3 cache, 65W)
647449-001	ATI Radeon HD 6450 512-MB graphics adapter
652272-001	1.5-TB, 5400-rpm hard drive
654601-001	Intel Core i5 2300 processor (2.8-GHz, 6-MB L3 cache, 65W) for use in 7500/7300 models

Spare part number	Description
655970-001	Intel Core i3 2105 processor (3.1-GHz, 3-MB L3 cache, 65W)
655971-001	Intel Pentium Dual-Core, G620 (2.6-GHz, 3-MB L3 cache, 65W)
655972-001	Intel Pentium Dual-Core, G840 (2.8-GHz, 3-MB L3 cache, 65W)
655973-001	Intel Pentium Dual-Core, G850 (2.9-GHz, 3-MB L3 cache, 65W)
656598-001	System board for use in models with 65W Intel processors on 3300 models (includes replacement thermal material)
656599-001	System board for use in 7300 models with Intel processors (includes thermal material)
656721-001	Power supply, 300W
656790-001	Intel Core i5 2405S (2.5-GHz, 6-MB L3 cache, 65W)
656985-001	Fan sink for use in models with AMD processors (includes replacement thermal material)
657100-001	AMD Phenom II X2 560 processor, dual core, 1-MB cache, 3.3 GHz, C3
657101-001	AMD Phenom II X2 565 processor, dual core, 1-MB cache, 3.4 GHz, C3
657102-001	SATA cable, 165 mm
657103-001	Chassis fan
657104-001	Access panel
657105-001	Power switch/LED assembly
657106-001	nVidia GeForce GT530 2-GB graphics adapter, full height
657107-001	nVidia GeForce GT545 3-GB graphics adapter, full height
657108-001	nVidia GeForce GT405 512-MB graphics adapter
657109-001	Front bezel for use on 3300/3305 models
657110-001	Front I/O and USB assembly for use on 3300/3305 models
657111-001	Intel Core i5 2310 processor (2.9-GHz, 6-MB L3 cache, 65W) for use in 7500/7300 models
657112-001	Front bezel for use on 7500/7300 models
657113-001	Front I/O and USB assembly for use on 7500/7300 models
657399-001	nVidia GeForce GT520 1-GB graphics adapter, full height
657401-001	DVI to VGA adapter, HF
657402-001	Fan sink for use in models with Intel processors (includes replacement thermal material)
657851-001	DVI to VGA adapter, 29-pin HF
657852-001	Bezel, optical drive
657853-001	Card reader bezel blank
657854-001	Card reader bezel
659355-001	ATI Radeon HD 6570 1-GB graphics adapter
660281-001	System board for use in 3300 models with 95W Intel processors
661841-001	120-GB solid-state drive

Spare part number	Description
661842-001	256-GB solid-state drive
665120-001	Intel Core i3 2130 processor (3.4 GHz, 3-MB L3 cache, 65W)
665121-001	Intel Core i5 2320 processor (3.0 GHz, 6-MB L3 cache, 95W)
665122-001	Intel Pentium Dual-Core G630 processor (2.7 GHz, 3-MB L3 cache, 65W)
665123-001	Intel Pentium Dual-Core G860 processor (3.0 GHz, 3-MB L3 cache, 65W)
665961-001	128-GB solid-state drive
666426-001	AMD Phenom II X6 1065T, quad core processor (2-MB L2 cache, 2.9 GHz, E0)
668149-001	3.0-TB, 5400-rpm hard drive
671612-001	Memory module, 2-GB, PC3 12800, 1666-MHz for use in only 7500 models
671613-001	Memory module, 4-GB, PC3 12800, 1666-MHz for use in only 7500 models
677427-001	Intel Core i3 2125 processor (3.3 GHz, 3-MB L3 cache, 65W)
679218-001	ATI Radeon HD 7450 1-GB graphics adapter for use only on 7500 models
679219-001	ATI Radeon HD 7570 1-GB graphics adapter for use only on 7500 models
687226-001	nVidia GeForce GT640 3-GB graphics adapter, full height for use only on 7500 models
687579-001	nVidia GeForce GT620 1-GB graphics adapter, full height for use only on 7500 models
687580-001	nVidia GeForce GT630 2-GB graphics adapter, full height for use only on 7500 models
687940-001	System board for use in 7500 models with Intel processors without Windows 8 (includes thermal material)
687941-001	Intel Core i5 3330 processor (3.0 GHz, 6-MB L3 cache, 77W) for use only on 7500 models
687942-001	Intel Core i5 3450 processor (3.1 GHz, 6-MB L3 cache, 77W) for use only on 7500 models
687943-001	Intel Core i5 3470 processor (3.1 GHz, 6-MB L3 cache, 77W) for use only on 7500 models
687944-001	Intel Core i5 3550 processor (3.2 GHz, 6-MB L3 cache, 77W) for use only on 7500 models
688162-001	Intel Core i5 3570 processor (3.3 GHz, 6-MB L3 cache, 77W) for use only on 7500 models
688163-001	Intel Core i5 3570K processor (3.3 GHz, 6-MB L3 cache, 77W) for use only on 7500 models
688164-001	Intel Core i7 3770 processor (3.4 GHz, 8-MB L3 cache, 77W) for use only on 7500 models
688165-001	Intel Core i7 3770K processor (3.5 GHz, 8-MB L3 cache, 77W) for use only on 7500 models
688950-001	Intel Core i3 3220 processor, 3.3 GHz, 3-MB L3 cache
688951-001	Intel Core i3 3240 processor, 3.4 GHz, 3-MB L3 cache
691934-001	Intel Celeron G55 processor, 3.3 GHz, 2-MB L3 cache
691935-001	Intel Pentium Dual-Core G870 processor, 3.1 GHz, 3-MB L3 cache
691936-001	Intel Pentium Dual-Core G640 processor, 2.8 GHz, 3-MB L3 cache
696887-001	System board for use in 7500 models with Windows 8 with no Digital Product Key (DPK)
696887-501	System board for use in 7500 models with Windows 8 Standard
696887-601	System board for use in 7500 models with Windows 8 Professional
696961-001	3 TB, 7200 rpm SATA hard drive

Spare part number	Description
701396-001	Ralink RT5390R 802.11bgn 1x1 Wi-Fi Adapter
701397-001	Antenna, for use with 1x1 WLAN modules
701398-001	Atheros AR9462 802.11b/g/n WiFi Adapter
701399-001	Ralink RT3290LE 802.11bgn 1x1 Wi-Fi and Bluetooth 4.0 Combo
701402-001	ATI Radeon HD 7450 1-GB graphics adapter for use only on 7500 models with Windows 8
701403-001	ATI Radeon HD 7570 2-GB graphics adapter for use only on 7500 models with Windows 8
701404-001	nVidia GeForce GT620 1-GB graphics adapter for use only on 7500 models with Windows 8
701405-001	nVidia GeForce GT630 2-GB graphics adapter for use only on 7500 models with Windows 8

Small Form Factor (SFF) Chassis Spare Parts

Computer major components

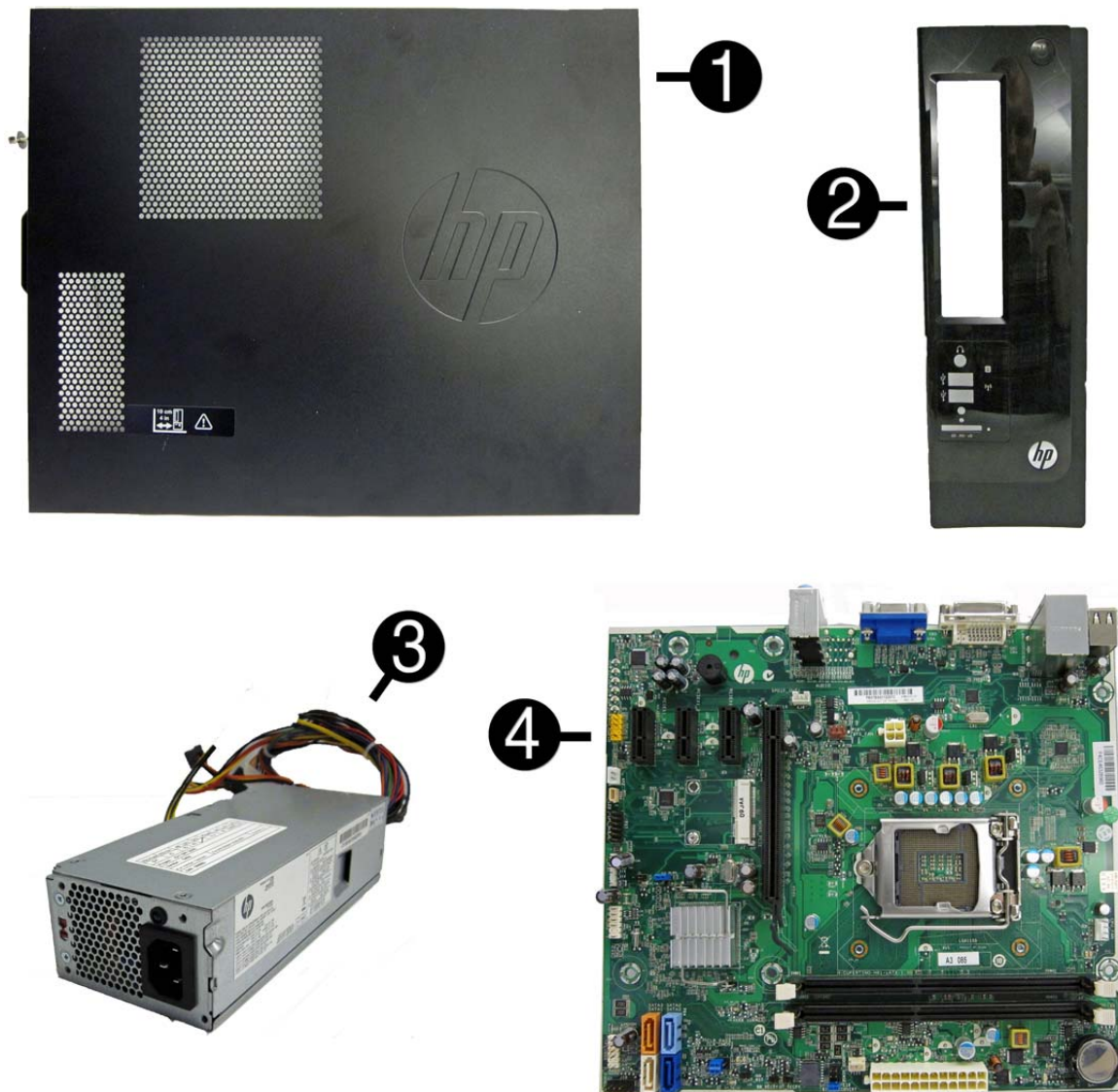

Item	Description	Spare part number
(1)	Access panel	656832-001
(2)	Front bezel	656835-001
(3)	Power supply	
	220W	656722-001
	270W	665224-001
(4)	System board (includes replacement thermal material)	
	For use in models with 65W processors	656598-001
	For use in models with 95W processors	660281-001

Item	Description	Spare part number
	For use in Brazil	665223-001
	Memory modules (PC3-10600, 1333-MHz; not illustrated)	
	4-GB	585157-001
	2-GB	635803-001
	1-GB	635802-001
	Processors (include replacement thermal material; not illustrated)	
	Intel Core i7 processor:	
	2600S (2.8-GHz, 8-MB L3 cache, 65W)	638419-001
	Intel Core i5 processors:	
	2500S (2.7-GHz, 6-MB L3 cache, 65W)	638420-001
	2500 (3.3 GHz, 6-MB L3 cache, 95W)	638631-001
	2405S (2.5-GHz, 6-MB L3 cache, 65W)	656790-001
	2400S (2.5-GHz, 6-MB L3 cache, 65W)	640953-001
	2400 (3.1 GHz, 6-MB L3 cache, 95W)	638630-001
	2320 (3.0 GHz, 6-MB L3 cache, 95W)	665121-001
	2310 (2.9 GHz, 6-MB L3 cache, 95W)	657111-001
	2300 (2.8 GHz, 6-MB L3 cache, 95W)	654601-001
	Intel Core i3 processors:	
	2130 (3.4 GHz, 3-MB L3 cache, 65W)	665120-001
	2120 (3.3-GHz, 3-MB L3 cache, 65W)	638629-001
	2105 (3.1-GHz, 3-MB L3 cache, 65W)	655970-001
	2100 (3.1-GHz, 3-MB L3 cache, 65W)	638628-001
	Intel Pentium Dual-Core processors:	
	G850 (2.9-GHz, 3-MB L3 cache, 65W)	655973-001
	G840 (2.8-GHz, 3-MB L3 cache, 65W)	655972-001
	G630 (2.7 GHz, 3-MB L3 cache, 65W)	665122-001
	G620 (2.6-GHz, 3-MB L3 cache, 65W)	655971-001
	G540 (2.5 GHz, 2-MB L3 cache, 65W)	665119-001
	G530 (2.4 GHz, 2-MB L3 cache, 65W)	665117-001
	G530T (2.0 GHz, 2-MB L3 cache, 35W)	665118-001

Cables

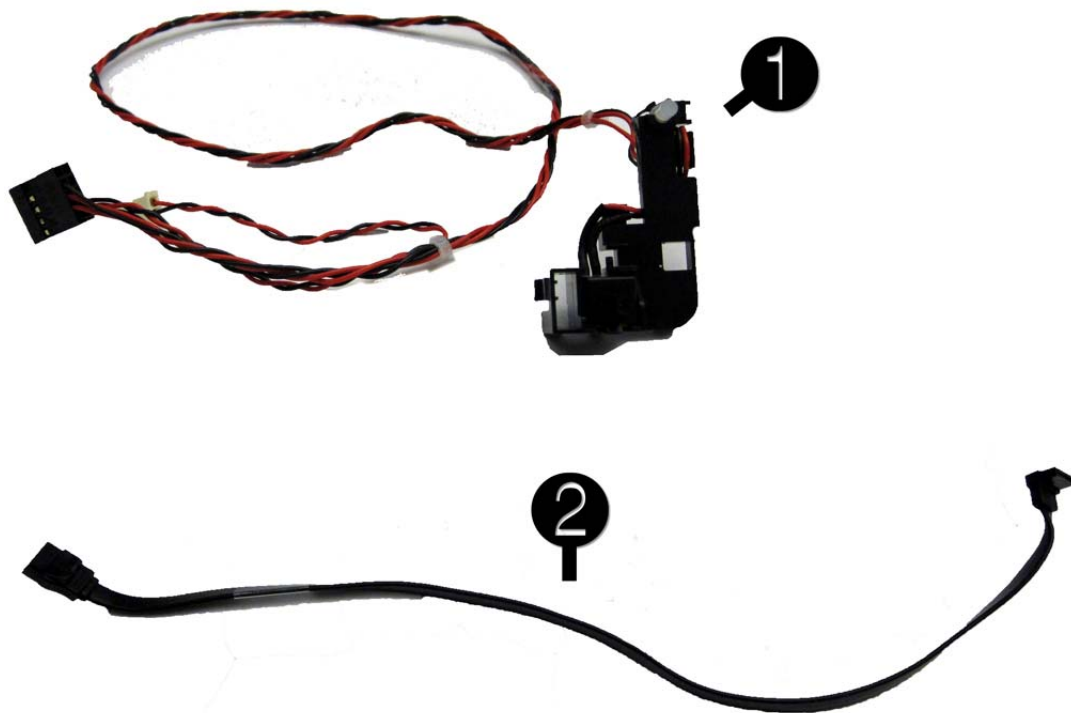

Item	Description	Spare part number
(1)	Power switch/LED assembly	656984-001
(2)	SATA cable, 370 mm	656833-001

Misc Parts



Item	Description	Spare part number
(1)	Chassis fan	656834-001
(2)	Fan sink (includes replacement thermal material)	657402-001
(3)	Front I/O and card reader (6-in-1)	656983-001
	Fan duct (not illustrated)	657403-001
	DVI to VGA adapter (not illustrated)	202997-001
	DVI to VGA adapter, HF (not illustrated)	657401-001
	DVI to VGA adapter, HF, 29-pin (not illustrated)	657851-001
	RTC battery (not illustrated)	319603-001
	Mouse (optical, USB; not illustrated)	596410-001
	Keyboard for use in Brazil	537924-201
	Feet	660261-001
	HP business digital headset	642738-001
	Printer port kit	638817-001
	Webcam, HD-2200	671734-001
	USB webcam	609252-001
	Mouse, wireless	625685-001

Drives

Description	Spare part number
Hard drive	
2-TB, 7200-rpm	616608-001
1.5-TB, 7200-rpm	613209-001
1-TB, 7200-rpm	621418-001
750-GB, 7200-rpm	632938-001
500-GB, 7200-rpm	621421-001
320-GB, 7200-rpm	621420-001
Optical drive	
DVD-ROM drive	581599-001
16X SATA DVD±RW drive	581600-001

Misc Boards

Description	Spare part number
nVidia GeForce GT530 2-GB graphics adapter	659354-001
nVidia GeForce GT520 1-GB graphics adapter	657400-001
nVidia GeForce 405 PCIe x16 graphics card, 1 GB	656789-001
ATI Radeon HD7350 512-MB graphics adapter	676356-001
ATI Radeon HD6570 1-GB graphics adapter	659355-001
ATI Radeon HD6450 PCIe x16 graphics card, 1 GB	647451-001
ATI Radeon HD6450 PCIe x16 graphics card, 512 MB	647450-001
802.11b/g/n (1x1) WLAN module	634906-001

Sequential Part Number Listing

Spare part number	Description
202997-001	DVI to VGA adapter (not illustrated)
319603-001	RTC battery (not illustrated)
537924-201	Keyboard for use in Brazil
581599-001	DVD-ROM drive
581600-001	16X SATA DVD±RW drive
585157-001	Memory module, 4-GB, PC3 10600, 1333-MH
596410-001	Mouse, USB, optical

Spare part number	Description
609252-001	USB webcam
613209-001	1.5-TB hard drive
616608-001	2-TB hard drive
621418-001	1-TB hard drive
621420-001	320-GB, 7200-rpm hard drive
621421-001	500-GB, 7200-rpm hard drive
625685-001	Mouse, wireless
632938-001	750-GB, 7200-rpm hard drive
634906-001	802.11b/g/n (1x1) WLAN module
635802-001	Memory module, 1-GB, PC3 10600, 1333-MHz
635803-001	Memory module, 2-GB, PC3 10600, 1333-MHz
638419-001	Intel Core i7 2600S processor (2.7-GHz, 8-MB L3 cache, 65W)
638420-001	Intel Core i5 2500S processor (2.7-GHz, 6-MB L3 cache, 65W)
638628-001	Intel Core i3 2100 processor (3.1-GHz, 3-MB L3 cache, 65W)
638629-001	Intel Core i3 2120 processor (3.3-GHz, 3-MB L3 cache, 65W)
638630-001	Intel Core i5 2400 processor (3.1 GHz, 6-MB L3 cache, 95W)
638631-001	Intel Core i5 2500 processor (3.3 GHz, 6-MB L3 cache, 95W)
638806-001	Hood sensor
638817-001	
640953-001	Intel Core i5 2400S processor (2.5-GHz, 6-MB L3 cache, 65W)
647450-001	ATI Radeon HD6450 PCIe x16 graphics card, 512 MB
647451-001	ATI Radeon HD6450 PCIe x16 graphics card, 1 GB
654601-001	Intel Core i5 2300 processor (2.8 GHz, 6-MB L3 cache, 95W)
655971-001	Intel Pentium Dual-Core G620 processor (2.6-GHz, 3-MB L3 cache, 65W)
655972-001	Intel Pentium Dual-Core G840 processor (2.8-GHz, 3-MB L3 cache, 65W)
655973-001	Intel Pentium Dual-Core G850 processor (2.9-GHz, 3-MB L3 cache, 65W)
656598-001	System board for use in models with 65W processors (includes replacement thermal material)
656722-001	Power supply, 220W
656789-001	nVidia GeForce 405 PCIe x16 graphics card, 1 GB
656790-001	Intel Core i5 2405S processor (2.5-GHz, 6-MB L3 cache, 65W)
656833-001	SATA cable, 370 mm
656789-001	nVidia GeForce 405 PCIe x16 graphics card, 1 GB
656832-001	Access panel
656834-001	Chassis fan

Spare part number	Description
656835-001	Front bezel
656983-001	Front I/O and card reader (6-in-1)
656984-001	Power switch/LED assembly
657111-001	Intel Core i5 2310 processor (2.9 GHz, 6-MB L3 cache, 95W)
657400-001	nVidia GeForce GT520 1-GB graphics adapter
657401-001	DVI to VGA adapter, HF
657402-001	Fan sink (includes replacement thermal material)
657403-001	Fan duct
657851-001	DVI to VGA adapter, 29-pin HF
659354-001	nVidia GeForce GT530 2-GB graphics adapter
659355-001	ATI Radeon HD6570 1-GB graphics adapter
660261-001	Feet
660281-001	System board for use in models with 95W processors
665117-001	Intel Pentium Dual-Core G530 processor (2.4 GHz, 2-MB L3 cache, 65W)
665118-001	Intel Pentium Dual-Core G530T processor (2.0 GHz, 2-MB L3 cache, 35W)
665119-001	Intel Pentium Dual-Core G540 processor (2.5 GHz, 2-MB L3 cache, 65W)
665120-001	Intel Core i3 2130 processor (3.4 GHz, 3-MB L3 cache, 65W)
665121-001	Intel Core i5 2320 processor (3.0 GHz, 6-MB L3 cache, 95W)
665122-001	Intel Pentium Dual-Core G630 processor (2.7 GHz, 3-MB L3 cache, 65W)
665123-001	Intel Pentium Dual-Core G860 processor (3.0 GHz, 3-MB L3 cache, 65W)
665223-001	System board for use in Brazil
665224-001	Power supply, 270W
671734-001	Webcam, HD-2200
676356-001	ATI Radeon HD7350 512-MB graphics adapter
677427-001	Intel Core i3 2125 processor (3.3 GHz, 3-MB L3 cache, 65W)

5 Serial ATA (SATA) Drive Guidelines and Features



NOTE: HP only supports the use of SATA hard drives on these models of computer. No Parallel ATA (PATA) drives are supported.

SATA Hard Drives

Serial ATA Hard Drive Characteristics	
Number of pins/conductors in data cable	7/7
Number of pins in power cable	15
Maximum data cable length	39.37 in (100 cm)
Data interface voltage differential	400-700 mV
Drive voltages	3.3 V, 5 V, 12 V
Jumpers for configuring drive	N/A
Data transfer rate	3.0 Gb/s

SATA Hard Drive Cables

SATA Data Cable

Always use an HP approved SATA 3.0 Gb/s cable as it is fully backwards compatible with the SATA 1.5 Gb/s drives.

Current HP desktop products ship with SATA 3.0 Gb/s hard drives.

SATA data cables are susceptible to damage if overflexed. Never crease a SATA data cable and never bend it tighter than a 30 mm (1.18 in) radius.

The SATA data cable is a thin, 7-pin cable designed to transmit data for only a single drive.

SMART ATA Drives

The Self Monitoring Analysis and Recording Technology (SMART) ATA drives for the HP Personal Computers have built-in drive failure prediction that warns the user or network administrator of an impending failure or crash of the hard drive. The SMART drive tracks fault prediction and failure indication parameters such as reallocated sector count, spin retry count, and calibration retry count. If the drive determines that a failure is imminent, it generates a fault alert.

Hard Drive Capacities

The combination of the file system and the operating system used in the computer determines the maximum usable size of a drive partition. A drive partition is the largest segment of a drive that may be properly accessed by the operating system. A single hard drive may therefore be subdivided into a number of unique drive partitions in order to make use of all of its space.

Because of the differences in the way that drive sizes are calculated, the size reported by the operating system may differ from that marked on the hard drive or listed in the computer specification. Drive size calculations by drive manufacturers are bytes to the base 10 while calculations by Microsoft are bytes to the base 2.

Drive/Partition Capacity Limits				
			Maximum Size	
File System	Controller Type	Operating System	Partition	Drive
FAT 32	ATA	Windows 7	32 GB	2 TB
NTFS	ATA	Windows 7	2 TB	2 TB

6 Routine Care, and Disassembly Preparation

This chapter provides general service information for the computer. Adherence to the procedures and precautions described in this chapter is essential for proper service.

CAUTION: When the computer is plugged into an AC power source, voltage is always applied to the system board. You must disconnect the power cord from the power source before opening the computer to prevent system board or component damage.

Electrostatic Discharge Information

A sudden discharge of static electricity from your finger or other conductor can destroy static-sensitive devices or microcircuitry. Often the spark is neither felt nor heard, but damage occurs. An electronic device exposed to electrostatic discharge (ESD) may not appear to be affected at all and can work perfectly throughout a normal cycle. The device may function normally for a while, but it has been degraded in the internal layers, reducing its life expectancy.

Networks built into many integrated circuits provide some protection, but in many cases, the discharge contains enough power to alter device parameters or melt silicon junctions.

Generating Static

The following table shows that:

- Different activities generate different amounts of static electricity.
- Static electricity increases as humidity decreases.

Event	Relative Humidity		
	55%	40%	10%
Walking across carpet	7,500 V	15,000 V	35,000 V
Walking across vinyl floor	3,000 V	5,000 V	12,000 V
Motions of bench worker	400 V	800 V	6,000 V
Removing DIPs* from plastic tube	400 V	700 V	2,000 V

Removing DIPs* from vinyl tray	2,000 V	4,000 V	11,500 V
Removing DIPs* from Styrofoam	3,500 V	5,000 V	14,500 V
Removing bubble pack from PCB	7,000 V	20,000 V	26,500 V
Packing PCBs in foam-lined box	5,000 V	11,000 V	21,000 V

*These are then multi-packaged inside plastic tubes, trays, or Styrofoam.

 **NOTE:** 700 volts can degrade a product.

Preventing Electrostatic Damage to Equipment

Many electronic components are sensitive to ESD. Circuitry design and structure determine the degree of sensitivity. The following packaging and grounding precautions are necessary to prevent damage to electric components and accessories.

- To avoid hand contact, transport products in static-safe containers such as tubes, bags, or boxes.
- Protect all electrostatic parts and assemblies with conductive or approved containers or packaging.
- Keep electrostatic sensitive parts in their containers until they arrive at static-free stations.
- Place items on a grounded surface before removing them from their container.
- Always be properly grounded when touching a sensitive component or assembly.
- Avoid contact with pins, leads, or circuitry.
- Place reusable electrostatic-sensitive parts from assemblies in protective packaging or conductive foam.

Personal Grounding Methods and Equipment

Use the following equipment to prevent static electricity damage to equipment:

- **Wrist straps** are flexible straps with a maximum of one-megohm \pm 10% resistance in the ground cords. To provide proper ground, a strap must be worn snug against bare skin. The ground cord must be connected and fit snugly into the banana plug connector on the grounding mat or workstation.
- **Heel straps/Toe straps/Boot straps** can be used at standing workstations and are compatible with most types of shoes or boots. On conductive floors or dissipative floor mats, use them on both feet with a maximum of one-megohm \pm 10% resistance between the operator and ground.

Static Shielding Protection Levels	
Method	Voltage
Antistatic plastic	1,500
Carbon-loaded plastic	7,500
Metallized laminate	15,000

Grounding the Work Area

To prevent static damage at the work area, use the following precautions:

- Cover the work surface with approved static-dissipative material. Provide a wrist strap connected to the work surface and properly grounded tools and equipment.
- Use static-dissipative mats, foot straps, or air ionizers to give added protection.
- Handle electrostatic sensitive components, parts, and assemblies by the case or PCB laminate. Handle them only at static-free work areas.
- Turn off power and input signals before inserting and removing connectors or test equipment.
- Use fixtures made of static-safe materials when fixtures must directly contact dissipative surfaces.
- Keep work area free of nonconductive materials such as ordinary plastic assembly aids and Styrofoam.
- Use field service tools, such as cutters, screwdrivers, and vacuums, that are conductive.

Recommended Materials and Equipment

Materials and equipment that are recommended for use in preventing static electricity include:

- Antistatic tape
- Antistatic smocks, aprons, or sleeve protectors
- Conductive bins and other assembly or soldering aids
- Conductive foam
- Conductive tabletop workstations with ground cord of one-megohm +/- 10% resistance
- Static-dissipative table or floor mats with hard tie to ground
- Field service kits
- Static awareness labels
- Wrist straps and footwear straps providing one-megohm +/- 10% resistance
- Material handling packages
- Conductive plastic bags
- Conductive plastic tubes
- Conductive tote boxes
- Opaque shielding bags
- Transparent metallized shielding bags
- Transparent shielding tubes

Operating Guidelines

To prevent overheating and to help prolong the life of the computer:

- Keep the computer away from excessive moisture, direct sunlight, and extremes of heat and cold.
- Operate the computer on a sturdy, level surface. Leave a 10.2-cm (4-inch) clearance on all vented sides of the computer and above the monitor to permit the required airflow.
- Never restrict the airflow into the computer by blocking any vents or air intakes. Do not place the keyboard, with the keyboard feet down, directly against the front of the desktop unit as this also restricts airflow.
- Occasionally clean the air vents on all vented sides of the computer. Lint, dust, and other foreign matter can block the vents and limit the airflow. Be sure to unplug the computer before cleaning the air vents.
- Never operate the computer with the cover or side panel removed.
- Do not stack computers on top of each other or place computers so near each other that they are subject to each other's re-circulated or preheated air.
- If the computer is to be operated within a separate enclosure, intake and exhaust ventilation must be provided on the enclosure, and the same operating guidelines listed above will still apply.
- Keep liquids away from the computer and keyboard.
- Never cover the ventilation slots on the monitor with any type of material.
- Install or enable power management functions of the operating system or other software, including sleep states.

Routine Care

General Cleaning Safety Precautions

1. Never use solvents or flammable solutions to clean the computer.
2. Never immerse any parts in water or cleaning solutions; apply any liquids to a clean cloth and then use the cloth on the component.
3. Always unplug the computer when cleaning with liquids or damp cloths.
4. Always unplug the computer before cleaning the keyboard, mouse, or air vents.
5. Disconnect the keyboard before cleaning it.
6. Wear safety glasses equipped with side shields when cleaning the keyboard.

Cleaning the Computer Case

Follow all safety precautions in [General Cleaning Safety Precautions on page 46](#) before cleaning the computer.

To clean the computer case, follow the procedures described below:

- To remove light stains or dirt, use plain water with a clean, lint-free cloth or swab.
- For stronger stains, use a mild dishwashing liquid diluted with water. Rinse well by wiping it with a cloth or swab dampened with clear water.
- For stubborn stains, use isopropyl (rubbing) alcohol. No rinsing is needed as the alcohol will evaporate quickly and not leave a residue.
- After cleaning, always wipe the unit with a clean, lint-free cloth.
- Occasionally clean the air vents on the computer. Lint and other foreign matter can block the vents and limit the airflow.

Cleaning the Keyboard

Follow all safety precautions in [General Cleaning Safety Precautions on page 46](#) before cleaning the keyboard.

To clean the tops of the keys or the keyboard body, follow the procedures described in [Cleaning the Computer Case on page 46](#).

When cleaning debris from under the keys, review all rules in [General Cleaning Safety Precautions on page 46](#) before following these procedures:

⚠ CAUTION: Use safety glasses equipped with side shields before attempting to clean debris from under the keys.

- Visible debris underneath or between the keys may be removed by vacuuming or shaking.
- Canned, pressurized air may be used to clean debris from under the keys. Caution should be used as too much air pressure can dislodge lubricants applied under the wide keys.

- If you remove a key, use a specially designed key puller to prevent damage to the keys. This tool is available through many electronic supply outlets.

⚠ CAUTION: Never remove a wide leveled key (like the space bar) from the keyboard. If these keys are improperly removed or installed, the keyboard may not function properly.

- Cleaning under a key may be done with a swab moistened with isopropyl alcohol and squeezed out. Be careful not to wipe away lubricants necessary for proper key functions. Use tweezers to remove any fibers or dirt in confined areas. Allow the parts to air dry before reassembly.

Cleaning the Monitor

- Wipe the monitor screen with a clean cloth moistened with water or with a towelette designed for cleaning monitors. Do not use sprays or aerosols directly on the screen; the liquid may seep into the housing and damage a component. Never use solvents or flammable liquids on the monitor.
- To clean the monitor body follow the procedures in [Cleaning the Computer Case on page 46](#).

Cleaning the Mouse

Before cleaning the mouse, ensure that the power to the computer is turned off.

- Clean the mouse ball by first removing the retaining plate and the ball from the housing. Pull out any debris from the ball socket and wipe the ball with a clean, dry cloth before reassembly.
- To clean the mouse body, follow the procedures in [Cleaning the Computer Case on page 46](#).

Service Considerations

Listed below are some of the considerations that you should keep in mind during the disassembly and assembly of the computer.

Power Supply Fan

The power supply fan is a variable-speed fan based on the temperature in the power supply.

⚠ CAUTION: The cooling fan is always on when the computer is in the “On” mode. The cooling fan is off when the computer is in “Standby,” “Suspend,” or “Off” modes.

You must disconnect the power cord from the power source before opening the computer to prevent system board or component damage.

Tools and Software Requirements

To service the computer, you need the following:

- Torx T-15 screwdriver (HP screwdriver with bits, PN 161946-001)
- Torx T-15 screwdriver with small diameter shank (for certain front bezel removal)
- Flat-bladed screwdriver (may sometimes be used in place of the Torx screwdriver)
- Phillips #2 screwdriver

- Diagnostics software
- HP tamper-resistant T-15 wrench (Smart Cover FailSafe Key, PN 166527-001) or HP tamper-resistant bits (Smart Cover FailSafe Key, PN 166527-002)

Screws

The screws used in the computer are not interchangeable. They may have standard or metric threads and may be of different lengths. If an incorrect screw is used during the reassembly process, it can damage the unit. HP strongly recommends that all screws removed during disassembly be kept with the part that was removed, then returned to their proper locations.

⚠ CAUTION: Metric screws have a black finish. U.S. screws have a silver finish and are used on hard drives only.

CAUTION: As each subassembly is removed from the computer, it should be placed away from the work area to prevent damage.

Cables and Connectors

Most cables used throughout the unit are flat, flexible cables. These cables must be handled with care to avoid damage. Apply only the tension required to seat or unseat the cables during insertion or removal from the connector. Handle cables by the connector whenever possible. In all cases, avoid bending or twisting the cables, and ensure that the cables are routed in such a way that they cannot be caught or snagged by parts being removed or replaced.

⚠ CAUTION: When servicing this computer, ensure that cables are placed in their proper location during the reassembly process. Improper cable placement can damage the computer.

Hard Drives

Handle hard drives as delicate, precision components, avoiding all physical shock and vibration. This applies to failed drives as well as replacement spares.

- If a drive must be mailed, place the drive in a bubble-pack mailer or other suitable protective packaging and label the package “Fragile: Handle With Care.”
- Do not remove hard drives from the shipping package for storage. Keep hard drives in their protective packaging until they are actually mounted in the CPU.
- Avoid dropping drives from any height onto any surface.
- If you are inserting or removing a hard drive, turn off the computer. Do not remove a hard drive while the computer is on or in standby mode.
- Before handling a drive, ensure that you are discharged of static electricity. While handling a drive, avoid touching the connector. For more information about preventing electrostatic damage, refer to [Electrostatic Discharge Information on page 42](#)
- Do not use excessive force when inserting a drive.
- Avoid exposing a hard drive to liquids, temperature extremes, or products that have magnetic fields such as monitors or speakers.

Lithium Coin Cell Battery

The battery that comes with the computer provides power to the real-time clock and has a minimum lifetime of about three years.

See the appropriate removal and replacement chapter for the chassis you are working on in this guide for instructions on the replacement procedures.

 **WARNING!** This computer contains a lithium battery. There is a risk of fire and chemical burn if the battery is handled improperly. Do not disassemble, crush, puncture, short external contacts, dispose in water or fire, or expose it to temperatures higher than 140°F (60°C). Do not attempt to recharge the battery.

 **NOTE:** Batteries, battery packs, and accumulators should not be disposed of together with the general household waste. In order to forward them to recycling or proper disposal, please use the public collection system or return them to HP, their authorized partners, or their agents.

7 Removal and Replacement Procedures Microtower (MT) Chassis

Adherence to the procedures and precautions described in this chapter is essential for proper service. After completing all necessary removal and replacement procedures, run the Diagnostics utility to verify that all components operate properly.

 **NOTE:** Not all features listed in this guide are available on all computers.

Preparation for Disassembly

1. Close any open software applications.
2. Exit the operating system.
3. Remove any diskette or compact disc from the computer.
4. Turn off the computer and any peripheral devices that are connected to it.

 **CAUTION:** Turn off the computer before disconnecting any cables.

CAUTION: Regardless of the power-on state, voltage is always present on the system board as long as the system is plugged into an active AC outlet. In some systems the cooling fan is on even when the computer is in the “Standby,” or “Suspend” modes. The power cord should always be disconnected before servicing a unit.

5. Disconnect the power cord from the electrical outlet and then from the computer.
6. Disconnect all peripheral device cables from the computer.

 **NOTE:** During disassembly, label each cable as you remove it, noting its position and routing. Keep all screws with the units removed.

 **CAUTION:** The screws used in the computer are of different thread sizes and lengths; using the wrong screw in an application may damage the unit.

Access Panel

Description	Spare part number
Access panel	657104-001

1. Prepare the computer for disassembly ([Preparation for Disassembly on page 50](#)).
2. Using a flathead or Torx screwdriver, remove the screw on the back panel that secures the panel to the computer.



3. Slide the side panel toward the back, and then pull it away from the computer.

 **NOTE:** You may want to lay the computer on its side to install internal parts. Be sure the side with the access panel is facing up.



To replace the access panel, reverse the removal steps.

Front Bezel

Description	Spare part number
Front bezel for use on 3300/3305 models	657109-001
Front bezel for use on 7300/7500 models	657112-001

1. Prepare the computer for disassembly ([Preparation for Disassembly on page 50](#)).
2. Remove the access panel ([Access Panel on page 51](#)).
3. Press outward on the three latches on the right side of the bezel.



4. Remove the access panel ([Access Panel on page 51](#)).

5. Rotate the right side of the bezel off the chassis followed by the left side.



 **NOTE:** The appearance of the front bezel may vary.

To reinstall the front bezel, reverse the removal procedure.

Memory



NOTE: HP Elite 7500 models use PC3-12800 memory. HP Elite 7300 and HP Pro 3300/3305 models use PC3-10800 memory.

Description	Spare part number
PC3-10600, 1333-MHz for use in only 7300 and 3300 models	
4-GB	585157-001
2-GB	635803-001
1-GB	635802-001
PC3-12800, 1666-MHz for use in only 7500 models	
4-GB	671613-001
2-GB	671612-001

The computer comes with double data rate 3 synchronous dynamic random access memory (DDR3-SDRAM) dual inline memory modules (DIMMs).

DDR3-SDRAM DIMMs

The memory sockets on the system board are as follows:

- Four DIMM slots for HP Pro 3305, HP Elite 7300, and HP Elite 7500
- Two DIMM slots for HP Pro 3300

These memory sockets are populated with at least one preinstalled DIMM. To achieve the maximum memory support, you can populate the system board with up to:

- 16 GB for HP Pro 3305
- 8 GB for HP Pro 3300, HP Elite 7300, and HP Elite 7500

HP Pro 3300, HP Elite 7300 Memory

For proper system operation, the DDR3-SDRAM DIMMs must be:

- industry-standard 240-pin
- unbuffered non-ECC PC3-10600 DDR3-1333 MHz-compliant
- 1.5 volt DDR3-SDRAM DIMMs

The DDR3-SDRAM DIMMs must also:

- support CAS latency 9 DDR3 1333 MHz (9-9-9 timing)
- contain the mandatory JEDEC SPD information

In addition, the computer supports:

- 512-Mbit, 1-Gbit, and 2-Gbit non-ECC memory technologies
- single-sided and double-sided DIMMs
- DIMMs constructed with x8 and x16 DDR devices; DIMMs constructed with x4 SDRAM are not supported

HP Elite 7500 Memory

For proper system operation, the DDR3-SDRAM DIMMs must be:

- industry-standard 240-pin
- unbuffered non-ECC PC3-12800 DDR3-1600 MHz-compliant
- 1.5 volt DDR3-SDRAM DIMMs

The DDR3-SDRAM DIMMs must also:

- support CAS latency 11 DDR3 1600 MHz (11-11-11 timing)
- contain the mandatory JEDEC SPD information

In addition, the computer supports:

- 512-Mbit, 1-Gbit, and 2-Gbit non-ECC memory technologies
- single-sided and double-sided DIMMs
- DIMMs constructed with x8 and x16 DDR devices; DIMMs constructed with x4 SDRAM are not supported



NOTE: The system will not operate properly if you install unsupported DIMMs.

Populating DIMM Sockets

Populate the DIMM sockets in the following order:

- Model 3305: DIMM1, DIMM3, DIMM2, DIMM4
- Model 3300, 7300, 7500: DIMM1, DIMM2

DIMM Socket Locations (model 3300 shown)

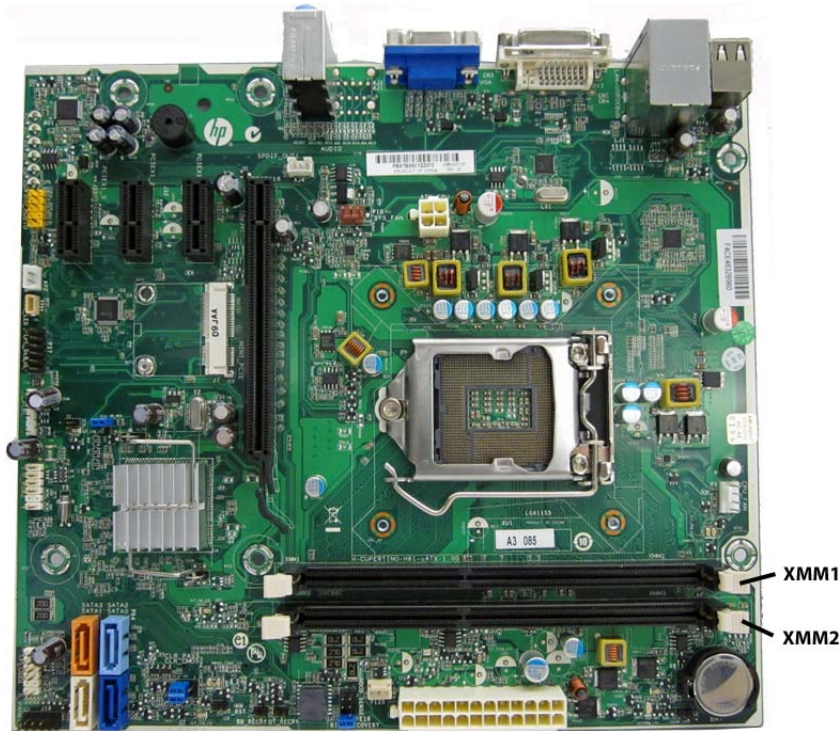
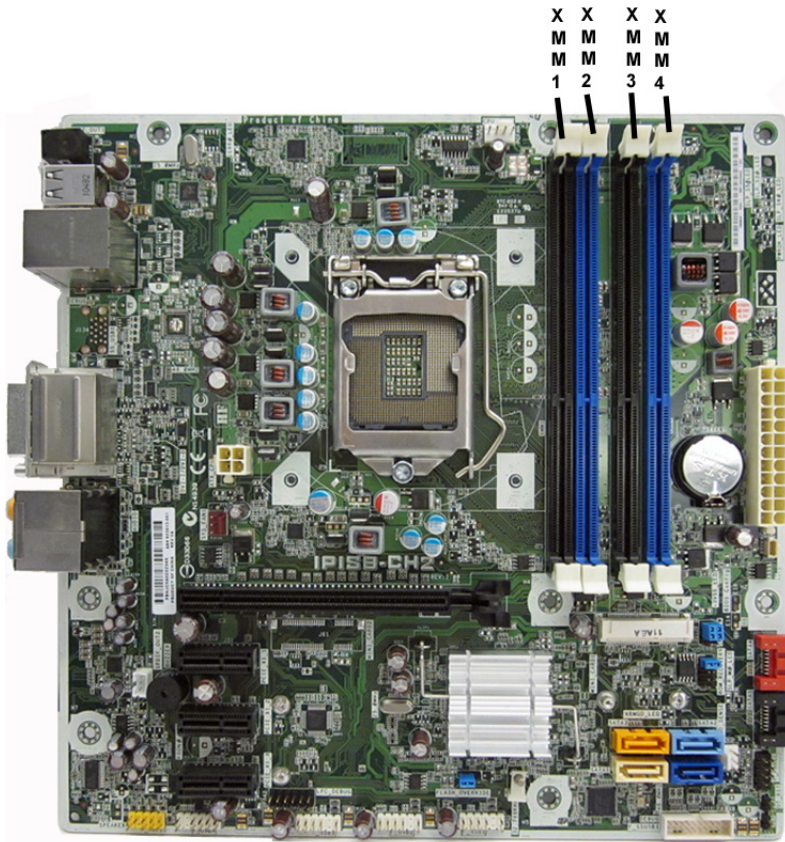

Table 7-1 DIMM Socket Locations

Item	Description	Socket Color	Insertion Order
1	XMM1 socket, Channel A (populate first)	Black	1
2	XMM2 socket, Channel A	Black	2

NOTE: A DIMM must occupy the DIMM1 socket.

DIMM Socket Locations (model 7300 shown)



Item	Description	Socket Color	Insertion Order
1	XMM1 socket, Channel A (populate first)	Black	1
2	XMM2 socket, Channel B	Blue	3
3	XMM3 socket, Channel A	Black	2
4	XMM4 socket, Channel B	Blue	4

NOTE: A DIMM must occupy the XMM1 socket.

The system will automatically operate in single channel mode, dual channel mode, or flex mode, depending on how the DIMMs are installed.

- The system will operate in single channel mode if the DIMM sockets are populated in one channel only.
- The system will operate in a higher-performing dual channel mode if the total memory capacity of the DIMMs in Channel A is equal to the total memory capacity of the DIMMs in Channel B. The technology and device width can vary between the channels. For example, if Channel A is populated with two 1-GB DIMMs and Channel B is populated with one 2-GB DIMM, the system will operate in dual channel mode.
- The system will operate in flex mode if the total memory capacity of the DIMMs in Channel A is not equal to the total memory capacity of the DIMMs in Channel B. In flex mode, the channel populated with the least amount of memory describes the total amount of memory assigned to dual channel and the remainder is assigned to single channel. For optimal speed, the channels

should be balanced so that the largest amount of memory is spread between the two channels. If one channel will have more memory than the other, the larger amount should be assigned to Channel A. For example, if you are populating the sockets with one 2-GB DIMM, and three 1-GB DIMMs, Channel A should be populated with the 2-GB DIMM and one 1-GB DIMM, and Channel B should be populated with the other two 1-GB DIMMs. With this configuration, 4-GB will run as dual channel and 1-GB will run as single channel.

- In any mode, the maximum operational speed is determined by the slowest DIMM in the system.

The system will automatically operate in single channel mode, dual channel mode, or flex mode, depending on how the DIMMs are installed.

Removing Memory Modules

⚠ CAUTION: You must disconnect the power cord and wait approximately 30 seconds for the power to drain before adding or removing memory modules. Regardless of the power-on state, voltage is always supplied to the memory modules as long as the computer is plugged into an active AC outlet. Adding or removing memory modules while voltage is present may cause irreparable damage to the memory modules or system board.

The memory module sockets have gold-plated metal contacts. When upgrading the memory, it is important to use memory modules with gold-plated metal contacts to prevent corrosion and/or oxidation resulting from having incompatible metals in contact with each other.

Static electricity can damage the electronic components of the computer or optional cards. Before beginning these procedures, ensure that you are discharged of static electricity by briefly touching a grounded metal object.

When handling a memory module, be careful not to touch any of the contacts. Doing so may damage the module.

-
1. Prepare the computer for disassembly ([Preparation for Disassembly on page 50](#)).
 2. Remove the access panel ([Access Panel on page 51](#)).
 3. Locate the memory module sockets on the system board.

⚠ WARNING! To reduce risk of personal injury from hot surfaces, allow the internal system components to cool before touching.

4. Open both latches of the memory module socket.

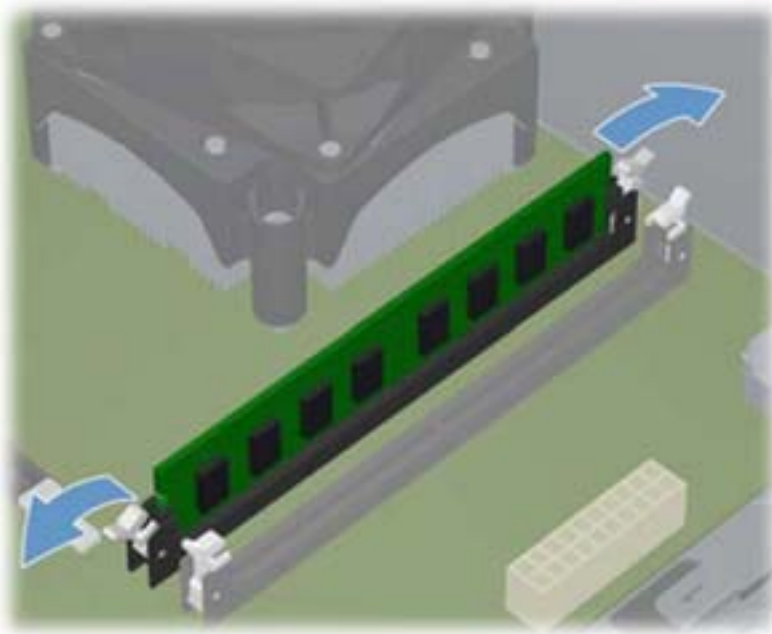

5. Remove the memory module from the socket.

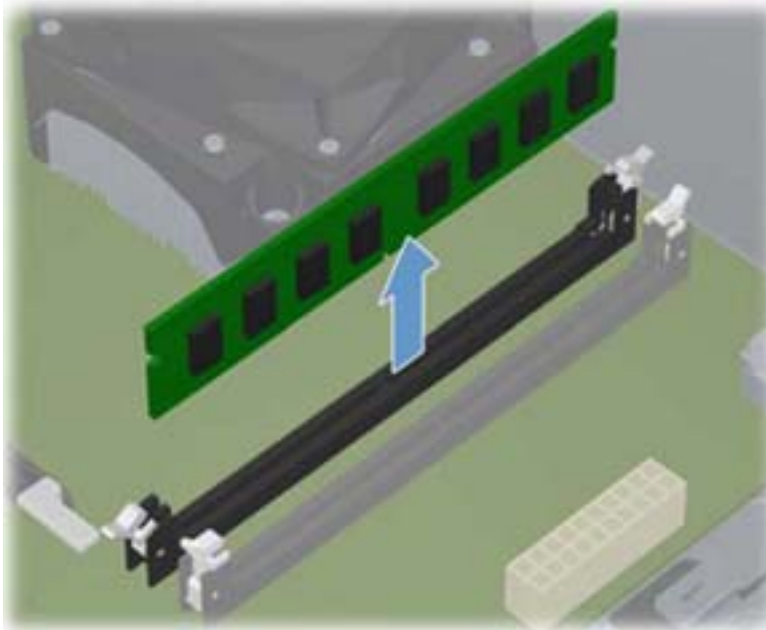

 **NOTE:** A memory module can be installed in only one way. Match the notch on the module with the tab on the memory socket.

A DIMM must occupy the DIMM1 socket. Always populate the blue sockets before the black sockets in each channel.

To create a dual-channel memory configuration, the memory capacity of Channel A must equal the memory capacity of Channel B.

To install a memory module, reverse the removal procedures.

Expansion Cards

Description	Spare part number
Graphics cards for use in models without Windows 8:	
ATI Radeon HD 7570 1-GB graphics adapter for use only on 7500 models	679219-001
ATI Radeon HD 7450 1-GB graphics adapter for use only on 7500 models	679218-001
ATI Radeon HD 6450 512-MB graphics adapter	647449-001
ATI Radeon HD 6450 1-GB graphics adapter	638132-001
ATI Radeon HD 6570 2-GB graphics adapter, full height	638405-001
ATI Radeon HD 6570 1-GB graphics adapter	659355-001
nVidia GeForce GT405 2-GB graphics adapter, full height	638406-001
nVidia GeForce GT405 1-GB graphics adapter, includes bracket	638407-001
nVidia GeForce GT405 512-MB graphics adapter	657108-001
nVidia GeForce GT420 2-GB graphics adapter, includes bracket	632920-001
nVidia GeForce GT440 1.5-GB graphics adapter, full height	638408-001
nVidia GeForce GT440 3-GB graphics adapter, full height	638409-001
nVidia GeForce GT520 1-GB graphics adapter, full height	657399-001
nVidia GeForce GT530 2-GB graphics adapter, full height	657106-001
nVidia GeForce GT545 3-GB graphics adapter, full height	657107-001
nVidia GeForce GT620 1-GB graphics adapter, full height for use only on 7500 models	687579-001
nVidia GeForce GT630 2-GB graphics adapter, full height for use only on 7500 models	687580-001
nVidia GeForce GT640 3-GB graphics adapter, full height for use only on 7500 models	687226-001
Graphics cards for use in models with Windows 8:	
ATI Radeon HD 7570 2-GB graphics adapter for use only on 7500 models	701403-001
ATI Radeon HD 7450 1-GB graphics adapter for use only on 7500 models	701402-001
nVidia GeForce GT640 3-GB graphics adapter for use only on 7500 models	701828-001
nVidia GeForce GT630 2-GB graphics adapter for use only on 7500 models	701405-001
nVidia GeForce GT620 1-GB graphics adapter for use only on 7500 models	701404-001

The HP Pro 3300/3305 has three PCI Express x1 expansion slots, one PCI Express x16 expansion slot, and one MiniPCI expansion slot. The expansion slots accommodate full-height or half-height expansion cards.

Expansion Slot Locations (Model 3300 shown)

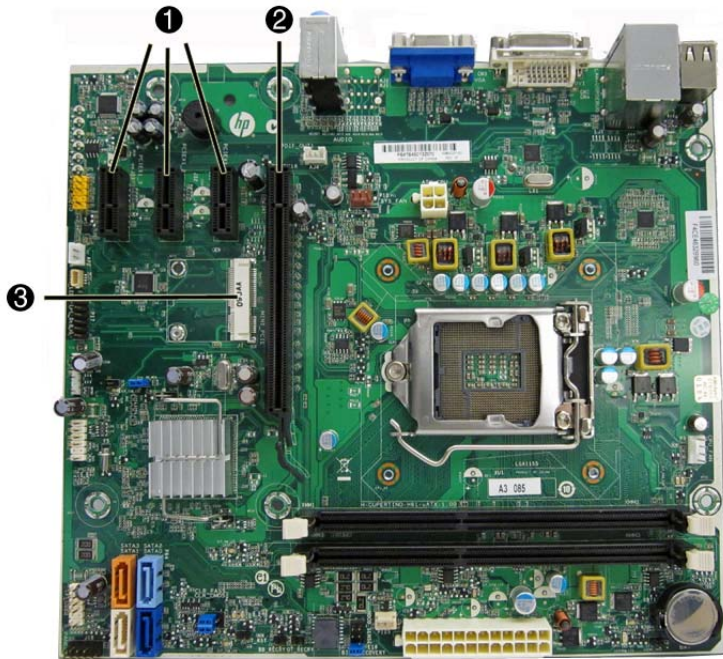

Item	Description
1	PCI Express x1 expansion slots (3)
2	PCI Express x16 expansion slot
3	MiniPCI slot

 **NOTE:** You can install a PCI Express x1, x4, x8, or x16 expansion card in the PCI Express x16 expansion slot.

To remove, replace, or add an expansion card:

1. Prepare the computer for disassembly ([Preparation for Disassembly on page 50](#)).
2. Remove the access panel ([Access Panel on page 51](#)).
3. Locate the correct vacant expansion socket on the system board and the corresponding expansion slot on the back of the computer chassis.

4. On the rear of the computer, a slot cover lock secures the expansion card brackets in place. Remove the screw from the slot cover lock then slide the slot cover lock up to remove it from the chassis.

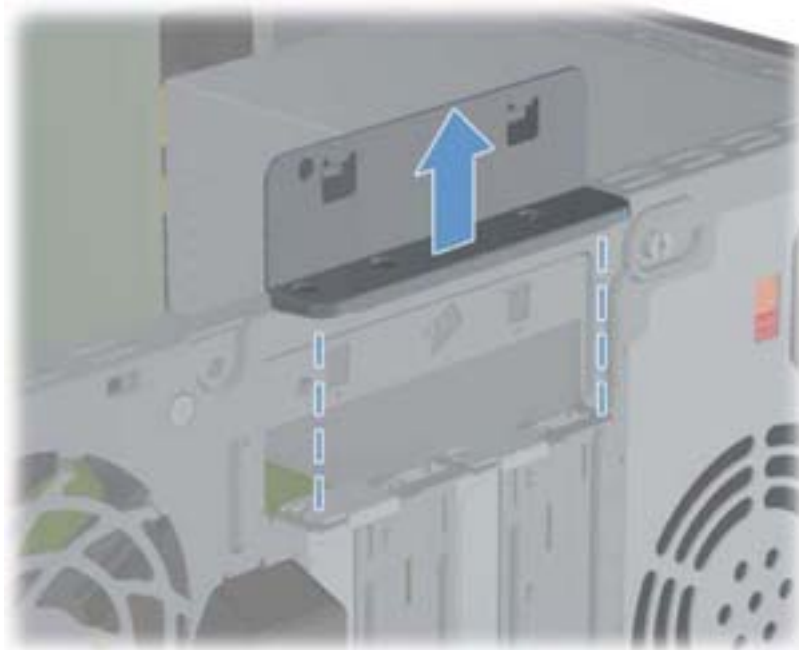

5. Before installing an expansion card, remove the expansion slot cover or the existing expansion card.

 **NOTE:** Before removing an installed expansion card, disconnect any cables that may be attached to the expansion card.

- a. If you are installing an expansion card in a vacant socket, you must remove the metal slot cover on the rear panel that covers the expansion slot. Be sure to remove the appropriate slot cover for the expansion card you are installing.
- b. If you are removing a standard PCI card, hold the card at each end, and carefully rock it back and forth until the connectors pull free from the socket. Pull the expansion card straight up from the socket then away from the inside of the chassis to release it from the chassis frame. Be sure not to scrape the card against the other components.

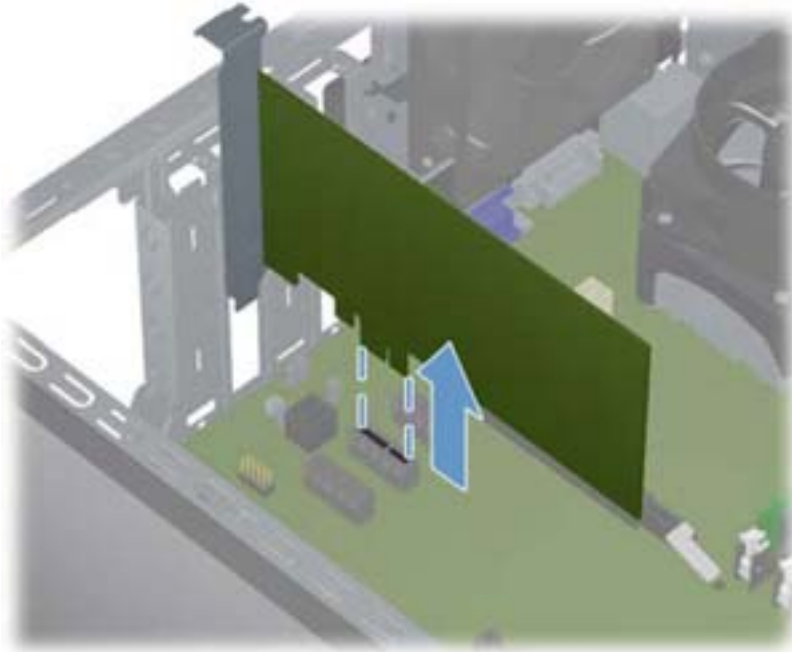

- c. If you are removing a PCI Express x16 card, pull the retention arm on the back of the expansion socket away from the card and carefully rock the card back and forth until the connectors pull free from the socket. Be sure not to scrape the card against the other components.

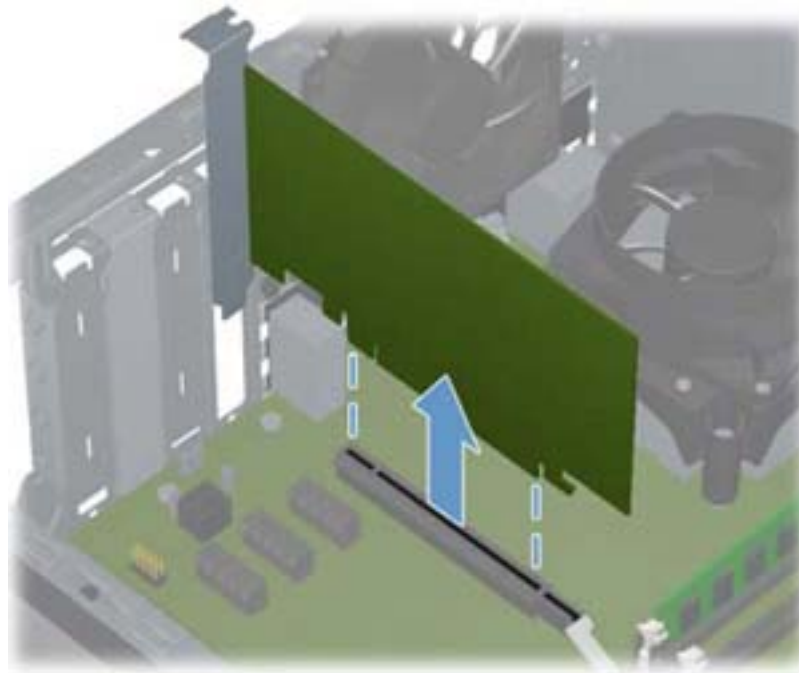
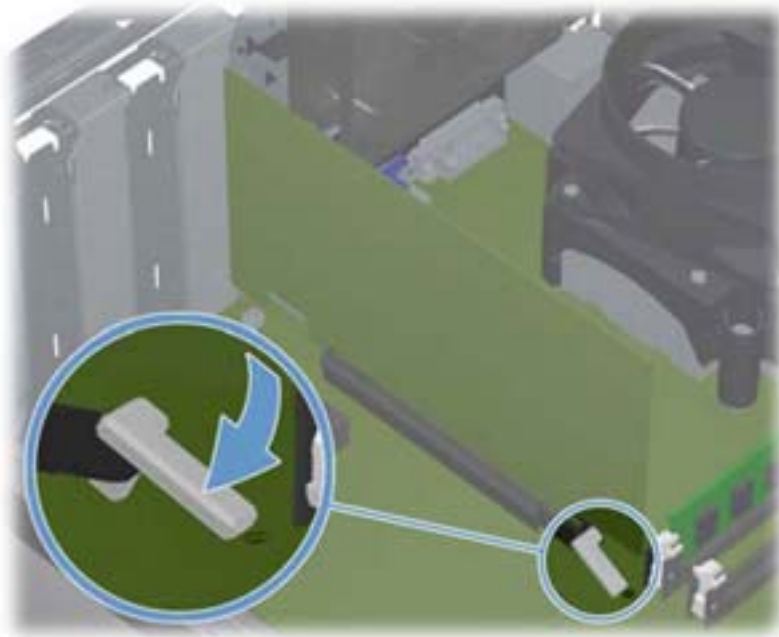

- 6. Store the removed card in anti-static packaging.

7. If you are not installing a new expansion card, install an expansion slot cover to close the open slot.

⚠ CAUTION: After removing an expansion card, you must replace it with a new card or expansion slot cover for proper cooling of internal components during operation.

8. To install an expansion card, locate where the card will be seated inside the computer.

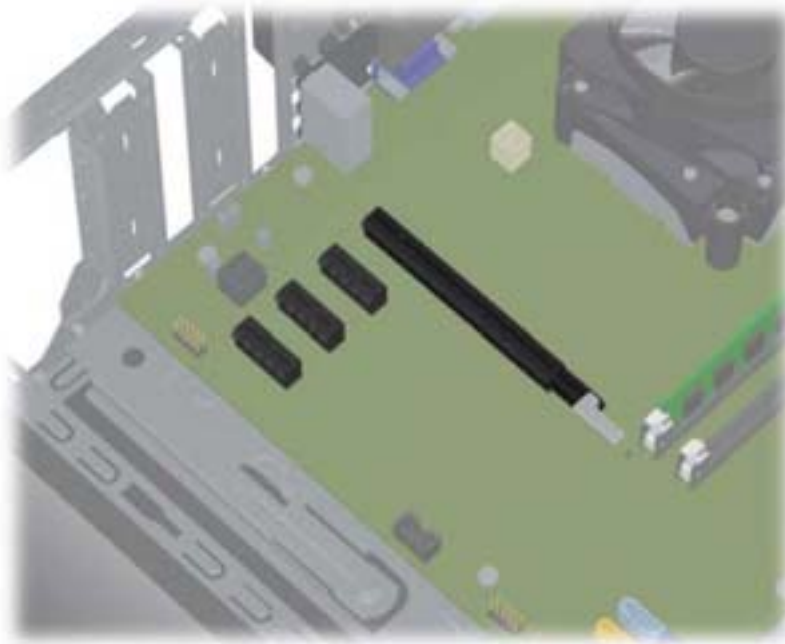

9. To install an expansion card, locate where the card will be seated inside the computer.

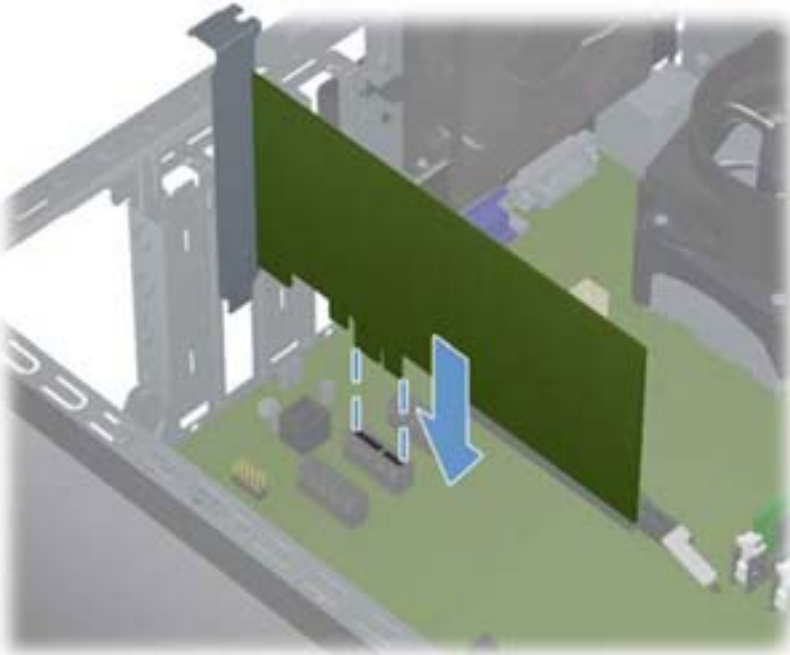
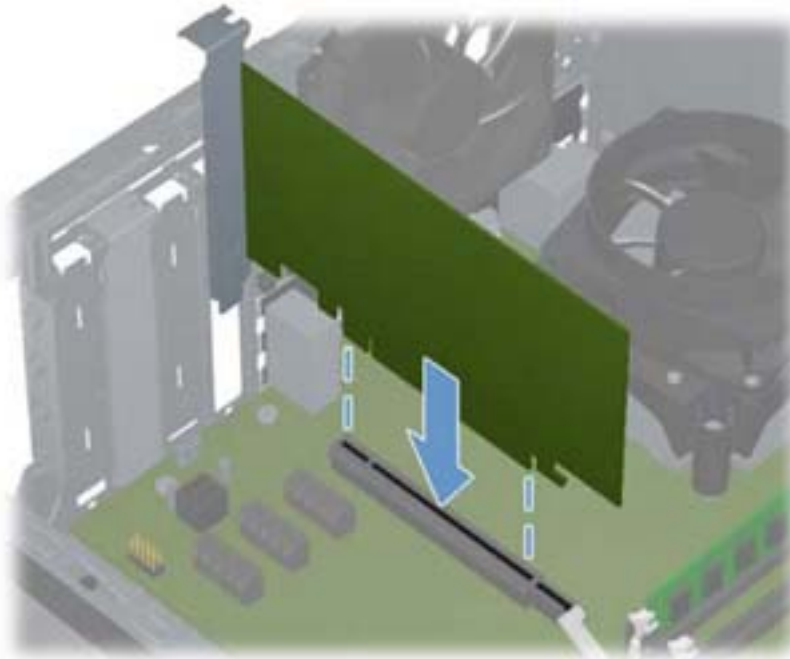

10. Connect external cables to the installed card, if needed. Connect internal cables to the system board, if needed.
11. Reconfigure the computer, if necessary. Refer to [Computer Setup \(F10\) Utility on page 7](#) for instructions on using Computer Setup.

Cable Management

Always follow good cable management practices when working inside the computer.

- Keep cables away from major heat sources like the heat sink.
- Do not jam cables on top of expansion cards or memory modules. Printed circuit cards like these are not designed to take excessive pressure on them.
- Some flat ribbon cables come prefolded. Never change the folds on these cables.
- Never bend a SATA data cable tighter than a 30 mm (1.18 in) radius.
- Never crease a SATA data cable.
- Do not rely on components like the drive cage, power supply, or computer cover to push cables down into the chassis. Always position the cables to lay properly by themselves.

When removing the power supply power cable from the P1 connector on the system board, always follow these steps:

1. Squeeze on the top of the retaining latch attached to the cable end of the connector **(1)**.
2. Grasp the cable end of the connector and pull it straight up **(2)**.

⚠ CAUTION: Always pull the connector - NEVER pull on the cable. Pulling on the cable could damage the cable and result in a failed power supply.

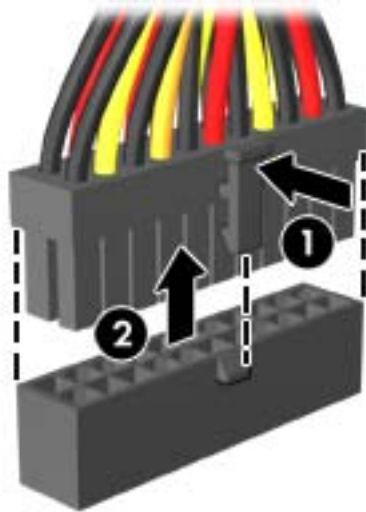

Cable Connections

System board connectors are color-coded to make it easier to find the proper connection.

Connector Name	Connector Color	Description
ATX_POWER	white	Power supply, 24-pin
ATX_CPU	white	Power supply, 4-pin
SYS_FAN	brown	Chassis fan
CPU_FAN	white	Heat sink fan
INT_SPKR	white	Speaker
F_PANEL	black	Power switch
F_AUDIO	yellow	Front I/O audio
MINI_LED	white	Front I/O
F_USB1	white	Media card reader
F_USB2	white	Front I/O USB
F_USB3	white	Front I/O USB
SATA1	dark blue	Primary hard drive
SATA2	white	Primary optical drive
SATA3	light blue	Second hard drive
SATA4	orange	Second optical drive

Drives

Description	Spare part number
16X SATA DVD±RW drive	581600-001
Blu-ray BD-RW SuperMulti DL Drive with LightScribe for use in 7300/7500 models	617030-001
Bezel, optical drive	657852-001
3 TB, 7200 rpm SATA hard drive	696961-001
3-TB, 5400-rpm SATA hard drive	668149-001
2 TB, 7200 rpm SATA hard drive	616608-001
2-TB, 5400-rpm SATA hard drive	613210-001
1.5 TB, 7200 rpm SATA hard drive	613209-001
1.5-TB, 5400-rpm SATA hard drive	652272-001
1 TB, 7200 rpm SATA hard drive, 3G	621418-001
750 GB, 7200 rpm SATA hard drive, 3G	632938-001
500 GB, 7200 rpm SATA hard drive, 3G	621421-001
320 GB, 7200 rpm SATA hard drive, 2.5-inch, 6G	636928-001
256-GB solid-state drive	661842-001
128-GB solid-state drive	665961-001
120-GB solid-state drive	661841-001

The computer supports up to five drives that may be installed in various configurations.

This section describes the procedure for replacing or upgrading the storage drives. A Torx T-15 screwdriver is needed to remove and install the guide screws on a drive.

Drive Positions

 **NOTE:** Front bezel appearance may vary.

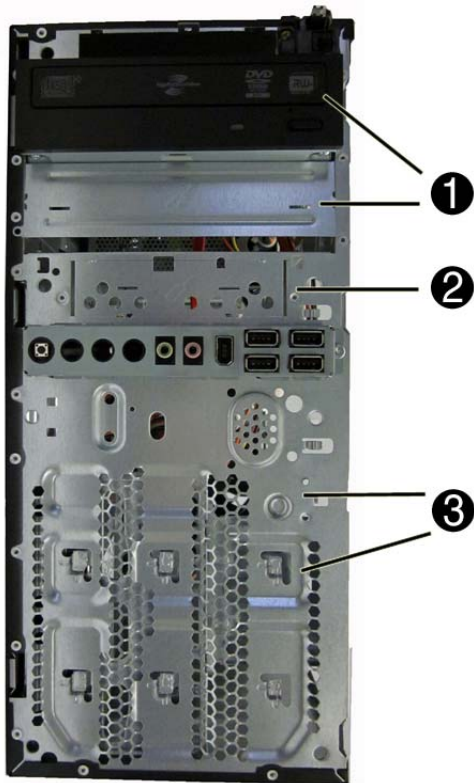

- 1 Two 5.25-inch external drive bays for optical drives
- 2 One 3.5-inch external drive bay for media card reader
- 3 Two 3.5-inch internal hard drive bays

To verify the type, size, and capacity of the storage devices installed in the computer, run Computer Setup. Refer to [Computer Setup \(F10\) Utility on page 7](#) for more information.

Installing Additional Drives

When installing drives, follow these guidelines:

- The primary Serial ATA (SATA) hard drive must be connected to the dark blue primary SATA connector on the system board labeled SATA0.
- Connect an optical drive to the light blue SATA connector on the system board labeled SATA2.
- The power cables for the SATA drives connect directly to the power supply. The primary hard drive connects to the power connector labeled P3. the primary optical drive connects to the power connector labeled P5.
- The system does not support Parallel ATA (PATA) optical drives or PATA hard drives.

⚠ CAUTION: To prevent loss of work and damage to the computer or drive:

If you are inserting or removing a drive, shut down the operating system properly, turn off the computer, and unplug the power cord. Do not remove a drive while the computer is on or in standby mode.

Before handling a drive, ensure that you are discharged of static electricity. While handling a drive, avoid touching the connector. For more information about preventing electrostatic damage, refer to [Electrostatic Discharge Information on page 42](#).

Handle a drive carefully; do not drop it.

Do not use excessive force when inserting a drive.

Avoid exposing a hard drive to liquids, temperature extremes, or products that have magnetic fields such as monitors or speakers.

If a drive must be mailed, place the drive in a bubble-pack mailer or other protective packaging and label the package “Fragile: Handle With Care.”

System Board Drive Connections

Refer to the following illustration and table to identify the system board drive connectors.

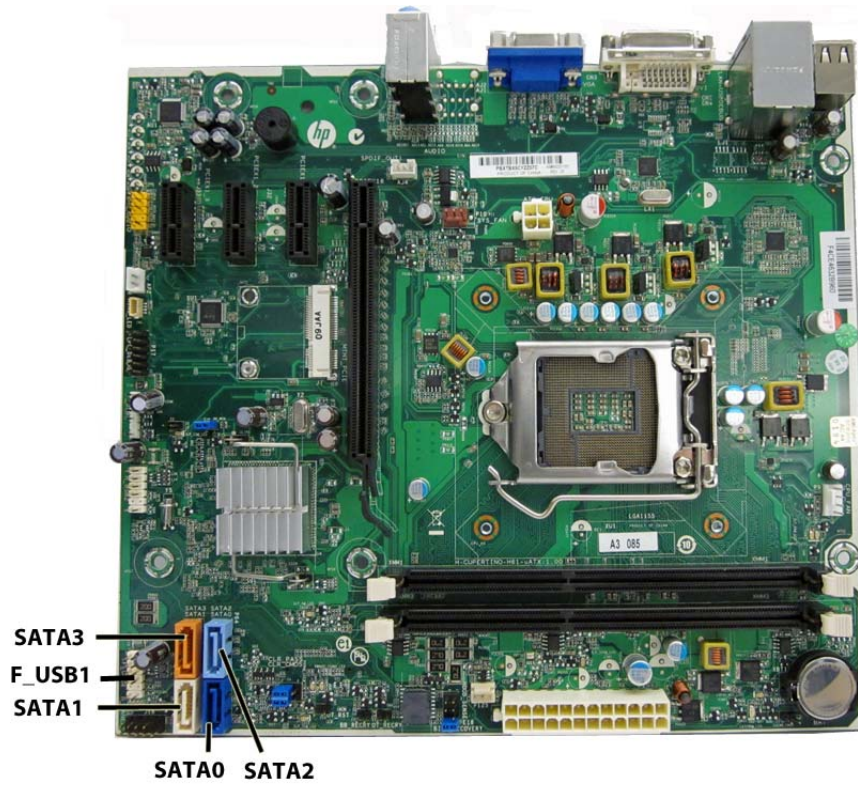

System Board Connector	System Board Label	Color
SATA1	SATA1	dark blue
SATA2	SATA2	white
SATA3	SATA3	light blue
SATA4	SATA4	orange
Media Card Reader	F_USB1	white

Removing an Optical Drive

CAUTION: All removable media should be taken out of a drive before removing the drive from the computer.

To remove an optical drive:

1. Prepare the computer for disassembly ([Preparation for Disassembly on page 50](#)).
2. Remove the access panel ([Access Panel on page 51](#)).
3. Remove the front bezel ([Front Bezel on page 53](#)).
4. Locate the optical drives.

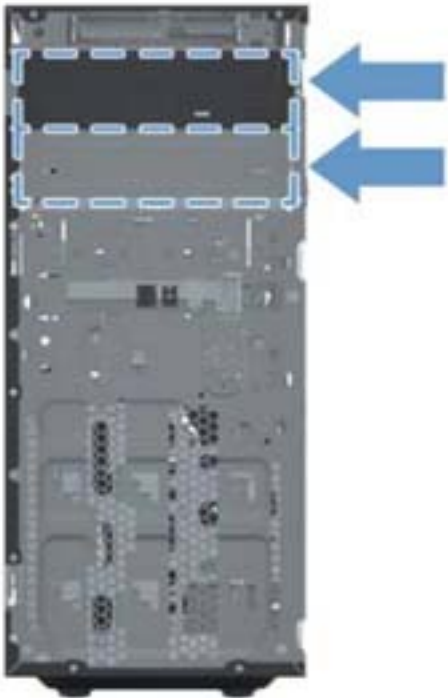

5. Unlock the drive by pulling the release lever slightly away from the computer and placing in an upright position.



6. Push the optical drive slightly forward.

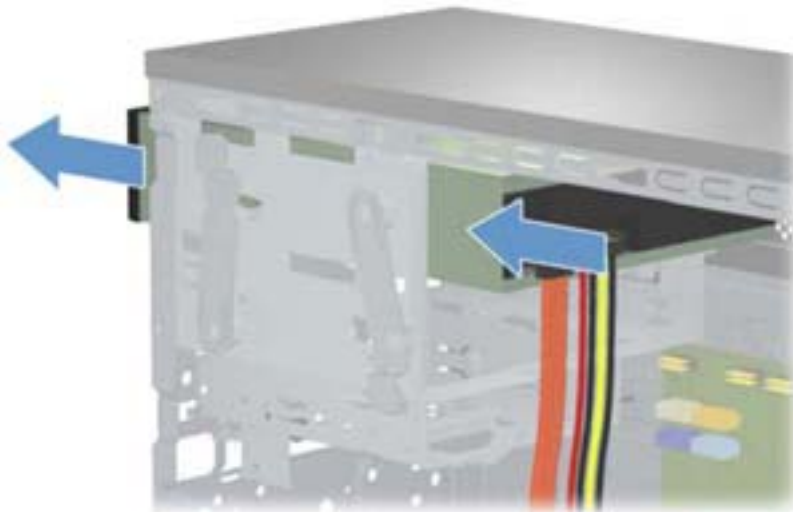

7. Disconnect the power cable and data cable from the rear of the optical drive.

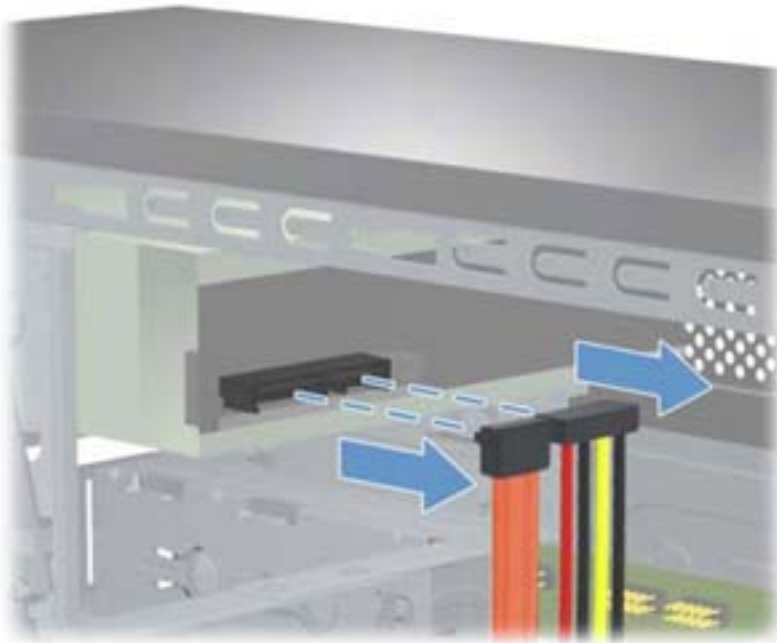

8. Slide the drive out of the computer.



To install an optical drive, reverse the removal procedures.

When installing an optical drive, slide the drive back until the hole on the drive aligns with the alignment hole on the computer.



Removing a Hard Drive

 **NOTE:** Before you remove the old hard drive, be sure to back up the data from the old hard drive so that you can transfer the data to the new hard drive. Also, if you are replacing the primary hard drive, make sure you have created a Recovery Disc Set to restore the operating system, software drivers, and any software applications that were preinstalled on the computer.

1. Prepare the computer for disassembly ([Preparation for Disassembly on page 50](#)).
2. Remove the access panel ([Access Panel on page 51](#)).

3. Locate hard disk drive in the computer.



4. Remove the two screws that secure the hard drive cage to the computer.

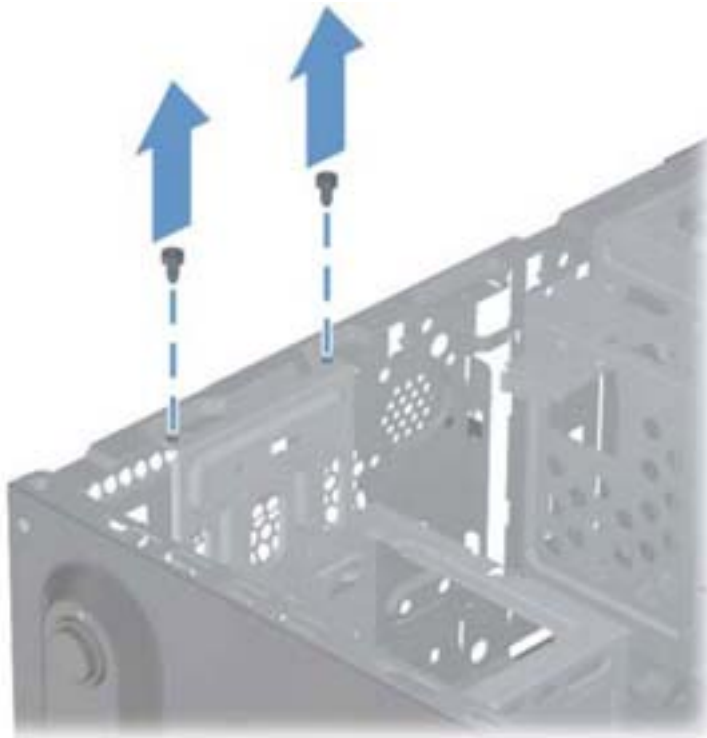

5. Press the latch at the side of the hard drive cage to release it.

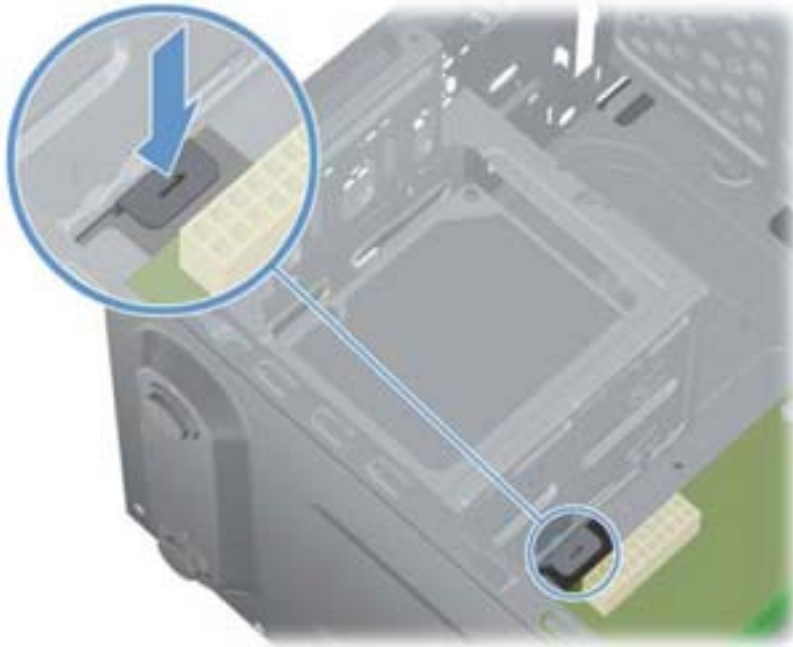

6. Lift the cage partially out of the computer.

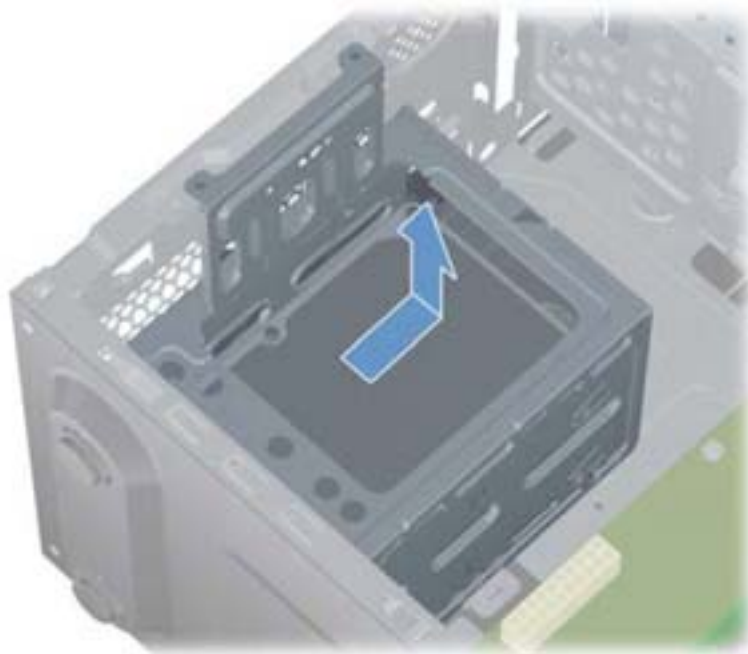

7. Disconnect the cables from the of the hard drive.

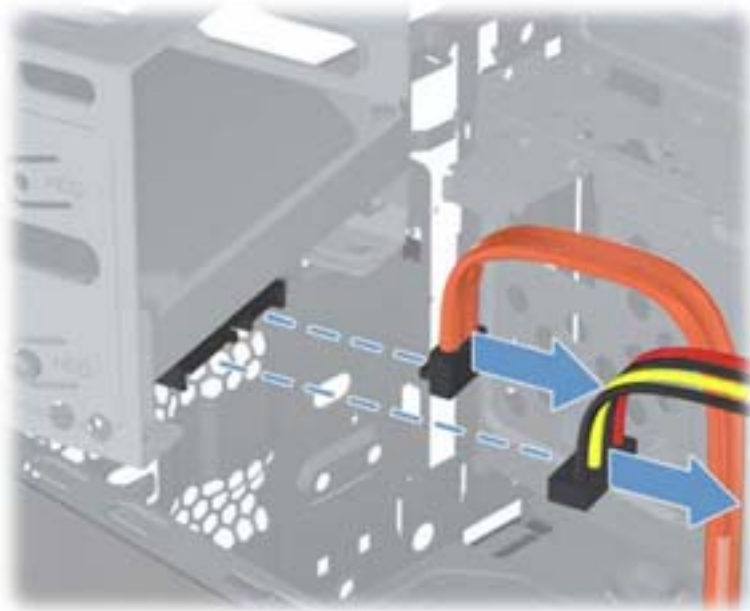

8. The cage may contain one or two hard disk drives. Each drive has two screws on each side of the cage. Remove the screws for the drive to remove from the cage.

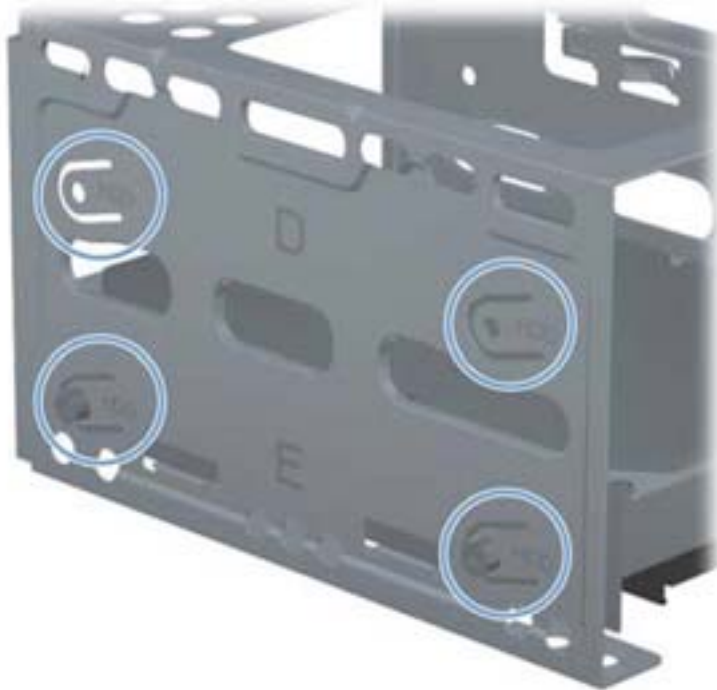
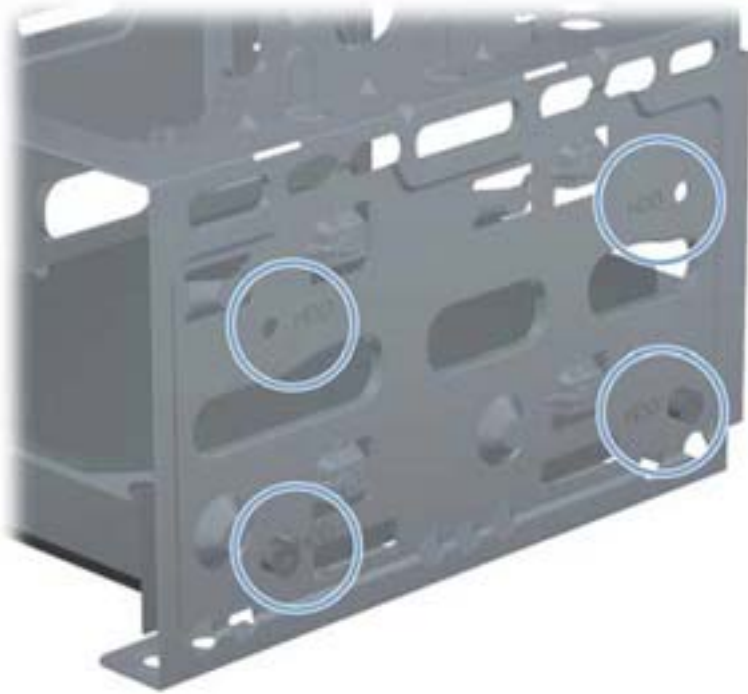

9. Slide the hard drive out of the cage.

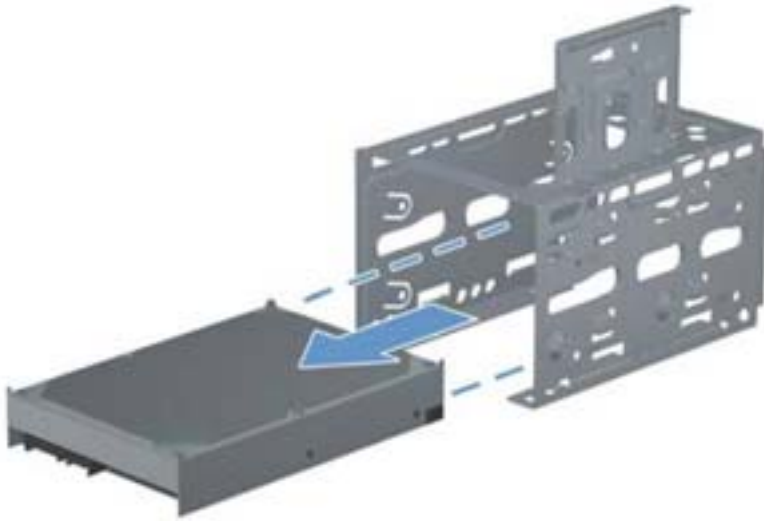

To install a hard drive, reverse the removal procedures.

When installing a hard drive, align the screw holes on the hard disk drive with the screw holes on the cage.



When installing a hard drive cage, set the hard drive cage down into the bay, aligning the tabs on the bottom of the cage with the tabs on the chassis.

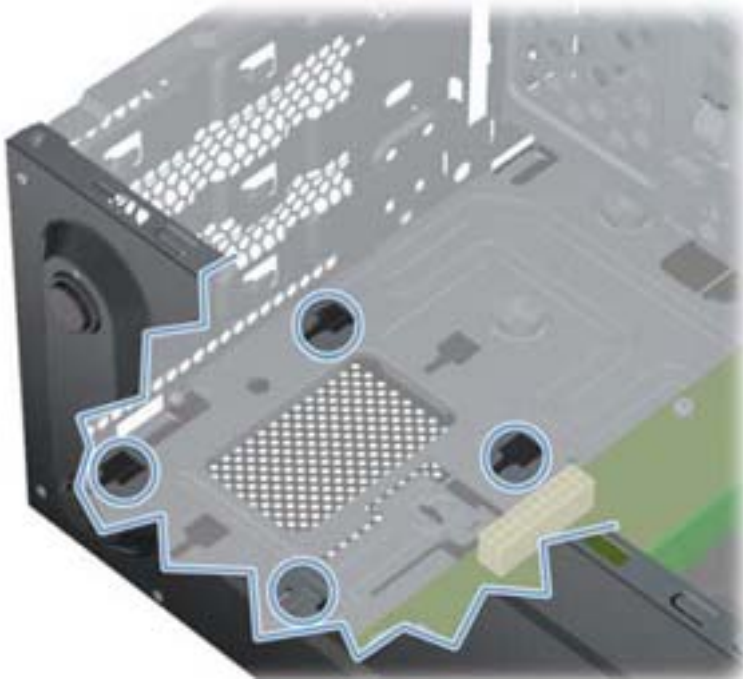

Front I/O and USB Panel Housing Assembly

Description	Spare part number
Front I/O and USB assembly for use on 3300/3305 models	657110-001
Front I/O and USB assembly for use on 7500/7300 models	657113-001

1. Prepare the computer for disassembly ([Preparation for Disassembly on page 50](#)).
2. Remove the access panel ([Access Panel on page 51](#)).
3. Lay the computer on its side with the front facing toward you.
4. Remove the front bezel ([Front Bezel on page 53](#)).
5. Unplug the three cables that connect the assembly to the system board. The assembly cables connect to the following system board connectors:
 - F_AUDIO – yellow connector
 - F_USB1 – white connector (blue cable)
 - F_USB2 – white connector (black cable)

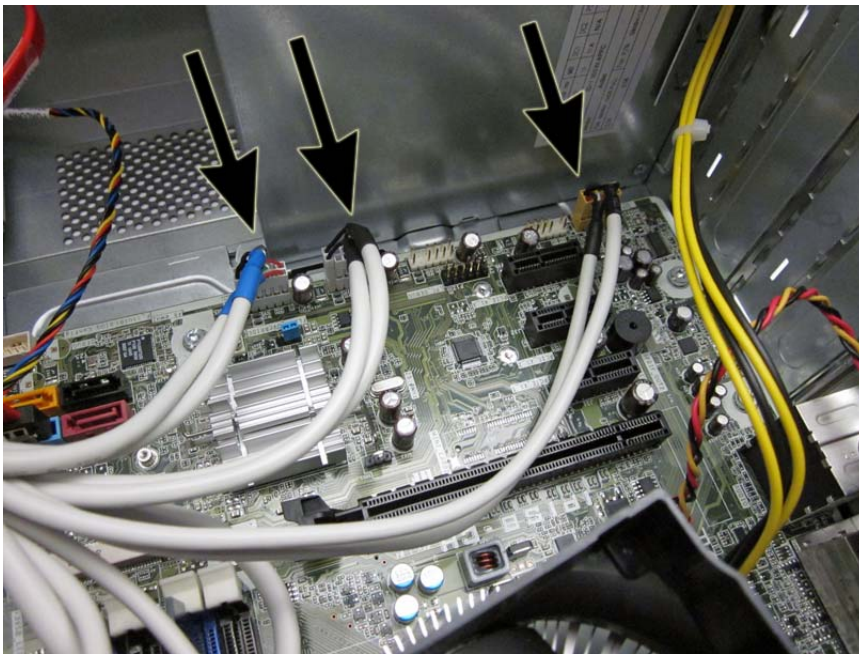

6. Remove the screw (1) that secures the housing to the chassis, and then slide the housing up (2).

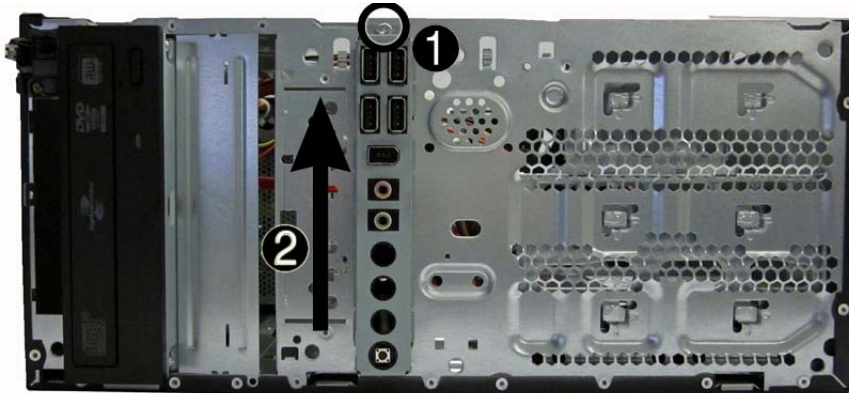

7. Rotate the top of the assembly outward (1), and then pull the assembly away from the chassis (2) while guiding the cables through the hole in the chassis.

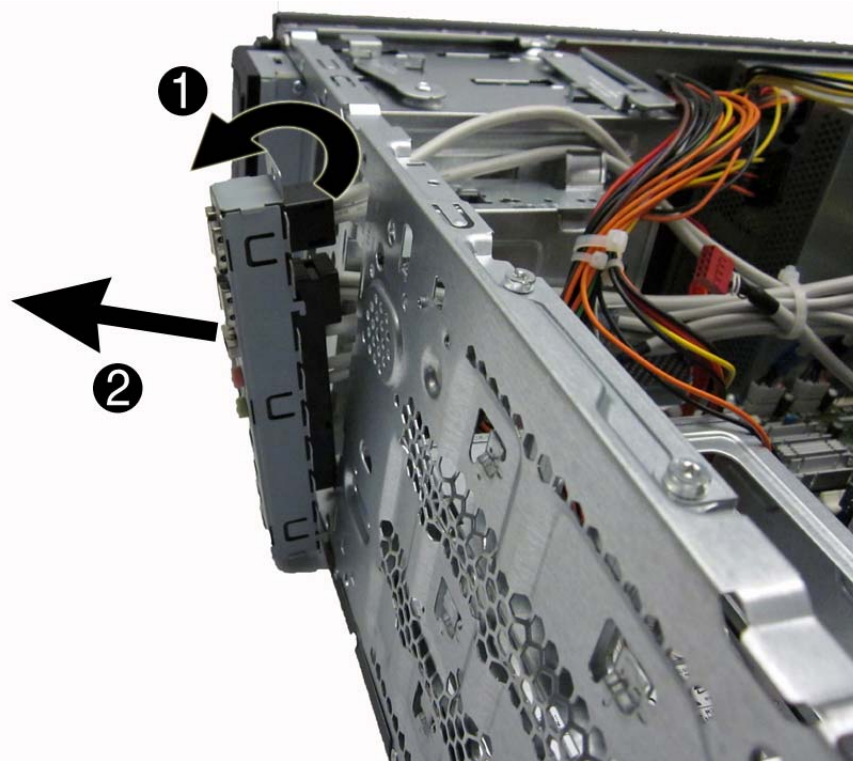

To install the housing assembly, reverse the removal procedures.

Note that the red connector and the small white connector is not used.

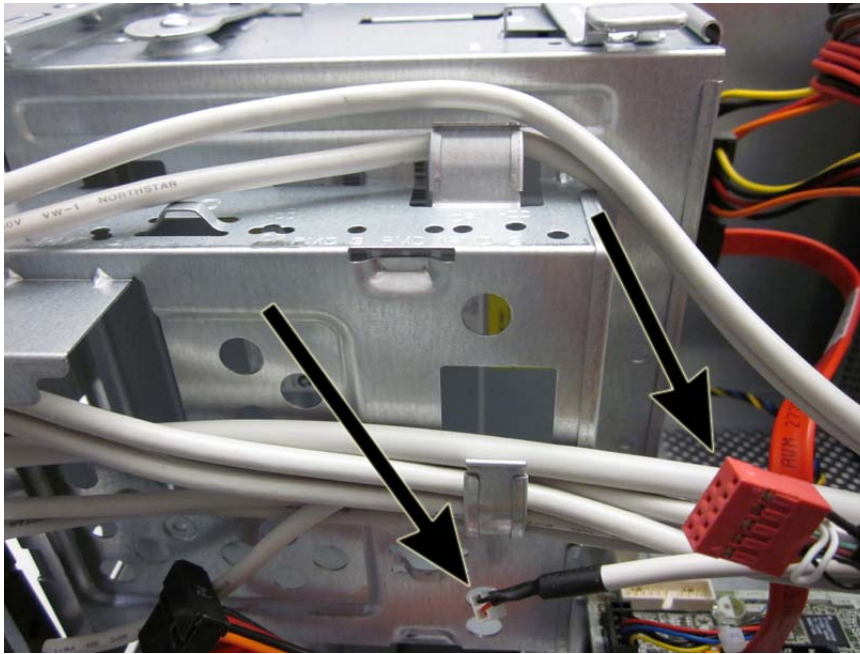

Note that dual cables connect to some system board connectors as shown in the following image.

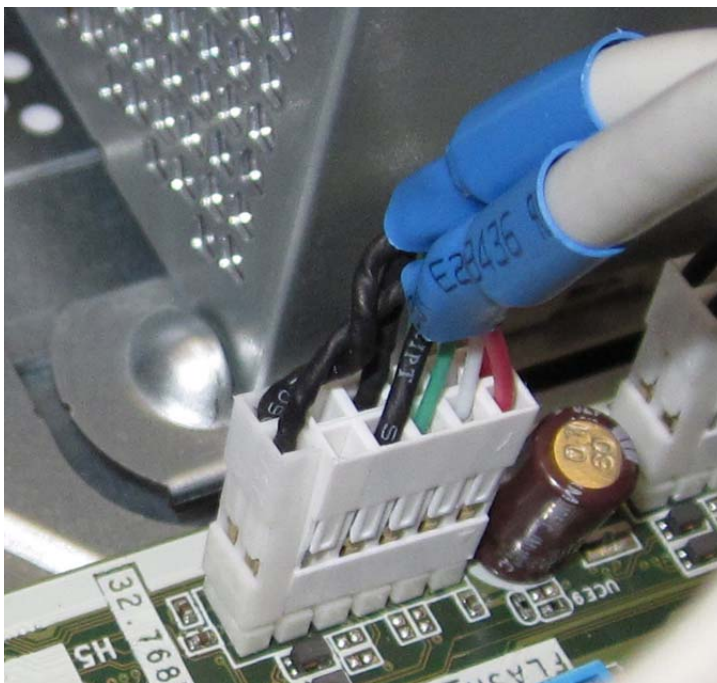

Power Switch/LED Assembly

Description	Spare part number
Power switch/LED assembly	657105-001

1. Prepare the computer for disassembly ([Preparation for Disassembly on page 50](#)).
2. Remove the access panel ([Access Panel on page 51](#)).
3. Lay the computer on its side with the front facing toward you.
4. Remove the front bezel ([Front Bezel on page 53](#)).
5. Remove the optical drive ([Removing an Optical Drive on page 74](#)).
6. Disconnect the braided cables from the black system board connector labeled JFP1.
7. Remove the cable from the clips in the optical drive cage.



8. Press the tab on the top of the switch holder (1) to disengage it from the chassis, lift the switch upward to disengage the tab at the bottom of the switch (2) from the chassis, and then pull the power switch away from the chassis while guiding the wires through the hole in the chassis.



To install the power switch/LED assembly, reverse the removal procedures.

System Fan

Description	Spare part number
Fan	657103-001

1. Prepare the computer for disassembly ([Preparation for Disassembly on page 50](#)).
2. Remove the access panel ([Access Panel on page 51](#)).
3. Lay the computer on its side with the rear facing toward you.
4. Remove the four Phillips screws that secure the fan to the chassis, rotate the top of the fan forward, and then remove the fan from the chassis.



 **NOTE:** System board appearance may vary.

5. Disconnect the cable from the red/brown system board connector labeled SYS_FAN1 (1), pull the fan into the chassis until it clears the chassis lip, and then lift it out of the chassis (2).

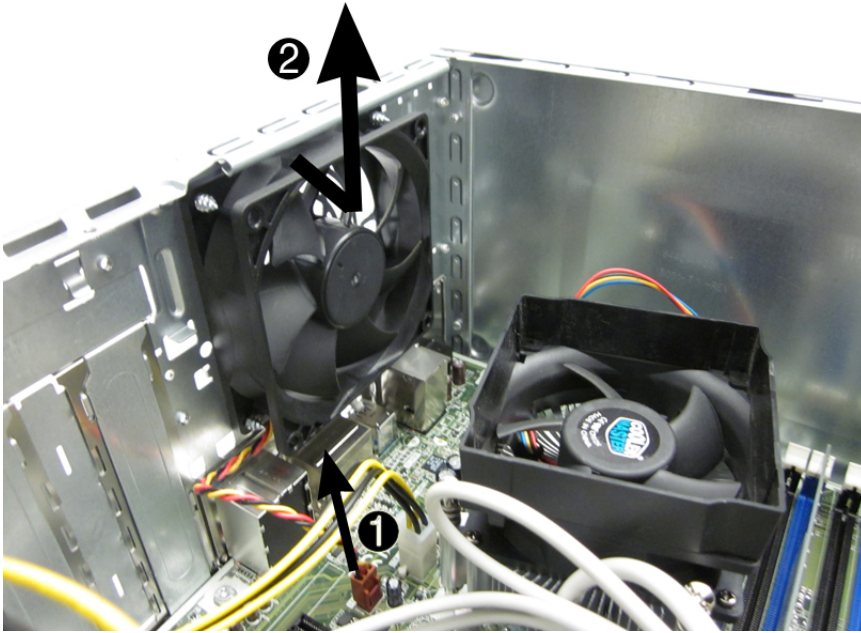

To install the fan, reverse the removal procedures.

Fan Sink Assembly

Description	Spare part number
Fan sink for use in models with Intel processors	657402-001
Fan sink for use in models with AMD processors	656985-001

1. Prepare the computer for disassembly ([Preparation for Disassembly on page 50](#)).
2. Remove the access panel ([Access Panel on page 51](#)).
3. Lay the computer on its side with the rear facing toward you.
4. Loosen the four captive Torx screws that secure the fan sink to the system board.
5. Disconnect the fan sink cable from the white system board connector labeled CPU FAN1.

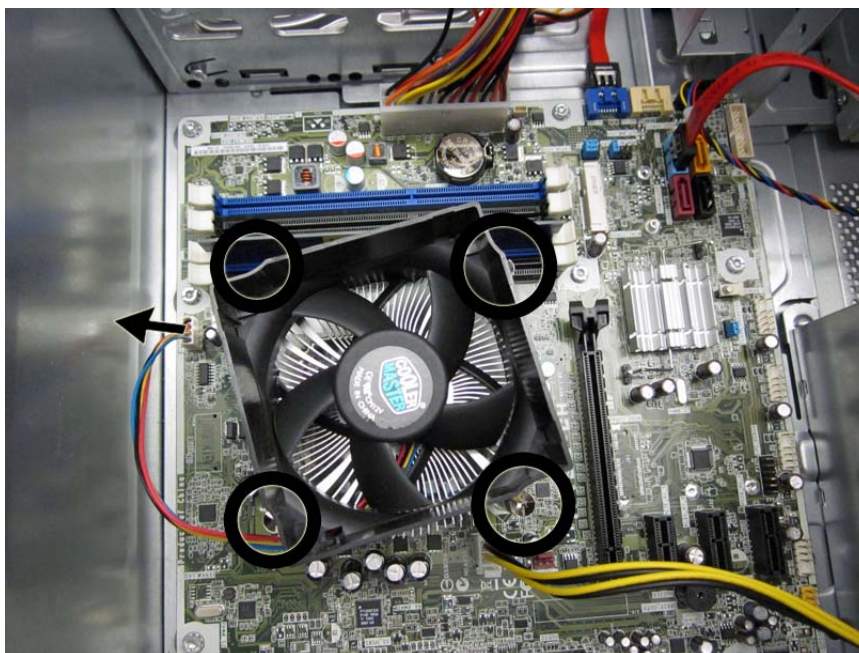

6. Lift the heat sink from the processor and set it on its side to keep from contaminating the work area with thermal grease.

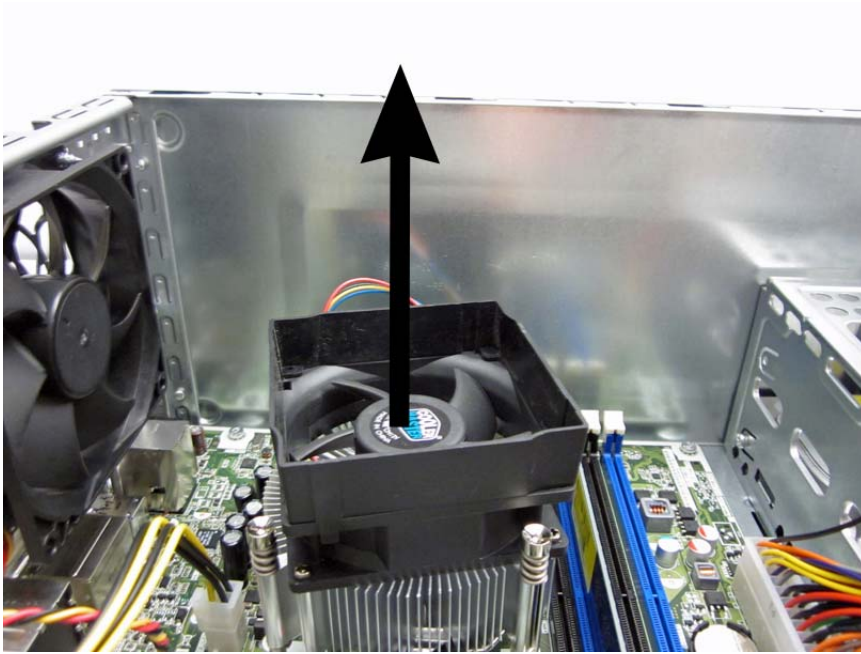

⚠ CAUTION: Heat sink retaining screws should be tightened in diagonally opposite pairs (as in an X) to evenly seat the heat sink to the processor. This is especially important as the pins on the socket are very fragile and any damage to them may require replacing the system board.

When reinstalling an existing heat sink, make sure that its bottom has been cleaned with an alcohol wipe and fresh thermal grease has been applied to the top of the processor. New heat sinks come from the factory with fresh thermal grease already applied.

Processor

Model 7500/7300/3300 uses Intel processors. Model 3305 uses AMD processors.

Description	Spare part number
Intel Core i7 processors	
3770 (3.4 GHz, 8-MB L3 cache, 77W) for use only on 7500 models	688164-001
3770K (3.5 GHz, 8-MB L3 cache, 77W) for use only on 7500 models	688165-001
2600S (2.7 GHz, 8-MB L3 cache, 65W)	638419-001
Intel Core i5 processors	
3570 (3.3 GHz, 6-MB L3 cache, 77W) for use only on 7500 models	688162-001
3570K (3.3 GHz, 6-MB L3 cache, 77W) for use only on 7500 models	688163-001
3550 (3.2 GHz, 6-MB L3 cache, 77W) for use only on 7500 models	687944-001
3470 (3.1 GHz, 6-MB L3 cache, 77W) for use only on 7500 models	687943-001
3450 (3.1 GHz, 6-MB L3 cache, 77W) for use only on 7500 models	687942-001
3330 (3.0 GHz, 6-MB L3 cache, 77W) for use only on 7500 models	687941-001
2500S (2.7 GHz, 6-MB L3 cache, 65W)	638420-001
2500 (3.3-GHz, 6-MB L3 cache, 65W) for use in 7300 models	638631-001
2405S (2.5-GHz, 6-MB L3 cache, 65W)	656790-001
2400S (2.5 GHz, 6-MB L3 cache, 65W)	640953-001
2400 (3.1-GHz, 6-MB L3 cache, 65W) for use in 7300 models	638630-001
2320 (3.0 GHz, 6-MB L3 cache, 95W) for use in 3300 series models	665121-001
2310 (2.9-GHz, 6-MB L3 cache, 65W) for use in 7300 models	657111-001
2300 (2.8-GHz, 6-MB L3 cache, 65W) for use in 7300 models	654601-001
Intel Core i3 processors	
3240 (3.4 GHz, 3-MB L3 cache, 65W)	688951-001
3220 (3.3 GHz, 3-MB L3 cache, 65W)	688950-001
2125 (.3 GHz, 3-MB L3 cache, 65W)	677427-001
2120 (3.3 GHz, 3-MB L3 cache, 65W)	638629-001
2105 (3.1 GHz, 3-MB L3 cache, 65W)	655970-001
2100 (3.1 GHz, 3-MB L3 cache, 65W)	638628-001
Intel Pentium Dual-Core processors	
G870 (3.1 GHz, 3-MB L3 cache, 65W)	691936-001
G860 (3.0 GHz, 3-MB L3 cache, 65W)	665123-001
G850 (2.9-GHz, 3-MB L3 cache, 65W)	655973-001
G840 (2.8-GHz, 3-MB L3 cache, 65W)	655972-001

Description	Spare part number
G860 (3.0 GHz, 3-MB L3 cache, 65W)	665122-001
G640 (2.8 GHz, 3-MB L3 cache, 65W)	691935-001
G630 (2.7 GHz, 3-MB L3 cache, 65W)	655971-001
AMD Phenom II processors:	
X6 1065T, quad core, 2-MB L2 cache, 2.9 GHz, E0	666426-001
X6 1055T, quad core, 2-MB L2 cache, 2.8 GHz, C3	617838-001
X6 1035T, quad core, 2-MB L2 cache, 2.6 GHz, C3	617837-001
X4 z960T, dual core, 1-MB cache, 3.0 GHz, E0	632923-001
X4 z840T, dual core, 1-MB cache, 2.9 GHz, E0	638410-001
X2 565, dual core, 1-MB cache, 3.4 GHz, C3	657101-001
X2 560, dual core, 1-MB cache, 3.3 GHz, C3	657100-001
X2 550, dual core, 1-MB cache, 3.1 GHz, C3	614518-001
AMD Athlon II processors:	
X4 650, dual core, 2-MB cache, 3.2 GHz, C3	638004-001
X4 645, dual core, 2-MB cache, 3.1 GHz, C3	628883-001
X4 635, dual core, 2-MB cache, 2.9 GHz, C3	617834-001
X3 455, dual core, 1.5-MB cache, 3.3 GHz, C3	638003-001
X3 450, dual core, 1.5-MB cache, 3.2 GHz, C3	628882-001
X2 270, dual core, 1-MB cache, 3.4 GHz, C3	632922-001
X2 265, dual core, 1-MB cache, 3.3 GHz, C3	632921-001
	628881-001
X2 260, dual core, 1-MB cache, 3.2 GHz, C3	614513-001
X2 220, dual core, 1-MB cache, 2.8 GHz, C2	611192-001
AMD Sempron processor:	
145, single core, 1-MB cache, 2.9 GHz, C3	638005-001

1. Prepare the computer for disassembly ([Preparation for Disassembly on page 50](#)).
2. Remove the access panel ([Access Panel on page 51](#)).
3. Lay the computer on its side with the rear facing toward you.
4. Remove the fan sink ([Fan Sink Assembly on page 91](#)).

5. If you are removing an Intel processor, rotate the locking lever to its full open position (1), raise and rotate the microprocessor retainer to its full open position (2), and then carefully lift the processor from the socket (3).

CAUTION: Do NOT handle the pins in the processor socket. These pins are very fragile and handling them could cause irreparable damage. Once pins are damaged it may be necessary to replace the system board.

CAUTION: The heat sink must be installed within 24 hours of installing the processor to prevent damage to the processor's solder connections.

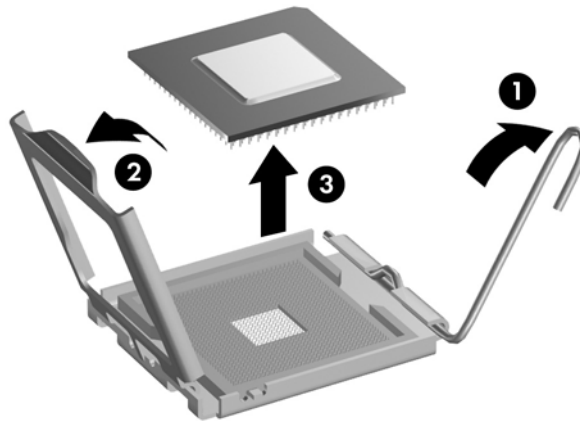

6. If you are removing an AMD processor, rotate the locking lever to its full open position **(1)**, and then carefully lift the processor from the socket **(2)**.

⚠ CAUTION: Do NOT handle the pins in the processor socket. These pins are very fragile and handling them could cause irreparable damage. Once pins are damaged it may be necessary to replace the system board.

CAUTION: The heat sink must be installed within 24 hours of installing the processor to prevent damage to the processor's solder connections.

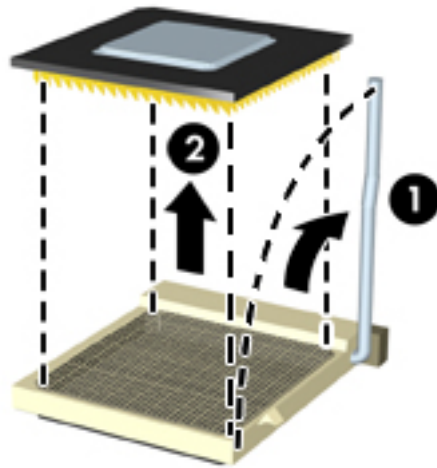

To install a new processor:

1. Place the processor in its socket.
2. If installing an Intel processor, close the retainer.
3. Secure the locking lever.

If reusing the existing heat sink, go to step 4.

If using a new heat sink, go to step 7.

4. If reusing the existing heat sink, clean the bottom of the heat sink with the alcohol pad provided in the spares kit.
5. Apply the thermal grease provided in the spares kit to the top of the processor and install the heat sink atop the processor.
6. Go to step 8.
7. If using a new fan sink, remove the protective covering from the bottom of the fan sink and place it in position atop the processor.
8. Secure the fan sink to the system board and system board tray with the 4 captive screws and attach the fan sink control cable to the system board.

⚠ CAUTION: Heat sink retaining screws should be tightened in diagonally opposite pairs (as in an X) to evenly seat the heat sink on the processor. This is especially important as the pins on the socket are very fragile and any damage to them may require replacing the system board.

 **NOTE:** After installing a new processor onto the system board, always update the system ROM to ensure that the latest version of the BIOS is being used on the computer. The latest system ROM BIOS can be found on the Web at: <http://h18000.www1.hp.com/support/files>.

Power Supply

Description	Spare part number
Power supply, 300W	656721-001

⚠ WARNING! Voltage is always present on the system board when the computer is plugged into an active AC outlet. To avoid possible personal injury and damage to the equipment the power cord should be disconnected from the computer and/or the AC outlet before opening the computer.

📝 NOTE: When installing a new power supply, be sure to set the red switch to the setting (230 V or 115 V) appropriate for the country in which the computer is used. Spare power supplies normally arrive set for 230 V.

1. Prepare the computer for disassembly ([Preparation for Disassembly on page 50](#)).
2. Remove the access panel ([Access Panel on page 51](#)).
3. Lay the computer on its side with the rear facing toward you.
4. Disconnect all power cables from the mass storage devices and from the system board. The following image points out power connectors in a system with one hard drive and one optical drive. System configuration may vary.

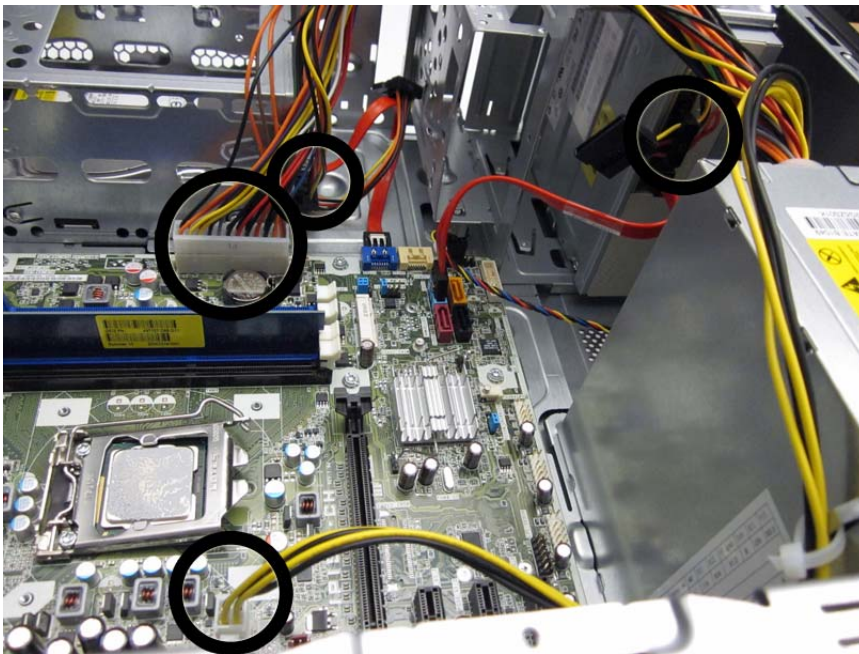

5. Remove the four screws that secure the power supply to the rear chassis.

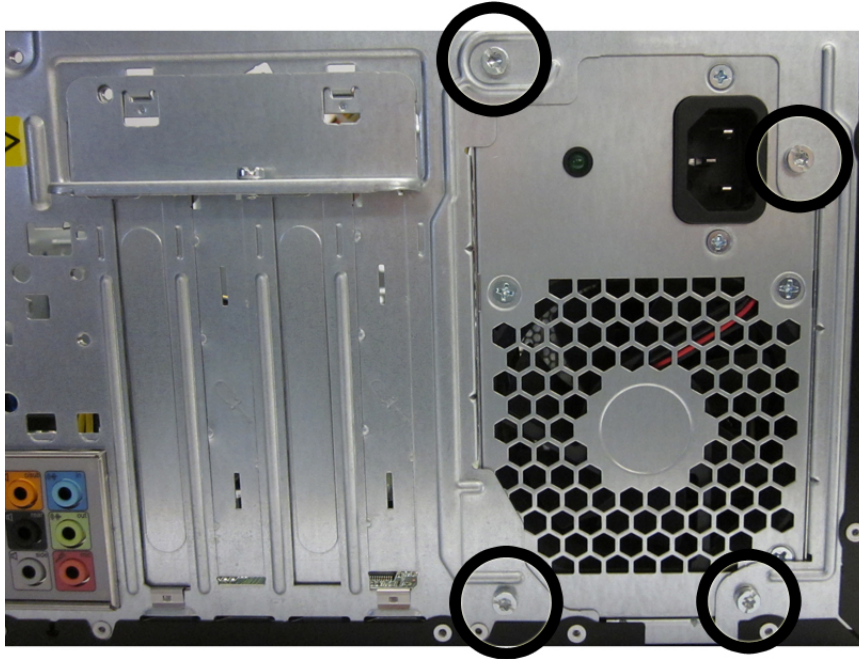

6. Inside of the unit, press the power supply release latch on the chassis base (1).
7. Slide the power supply toward the front of the computer (2), then lift the power supply out of the computer (3).

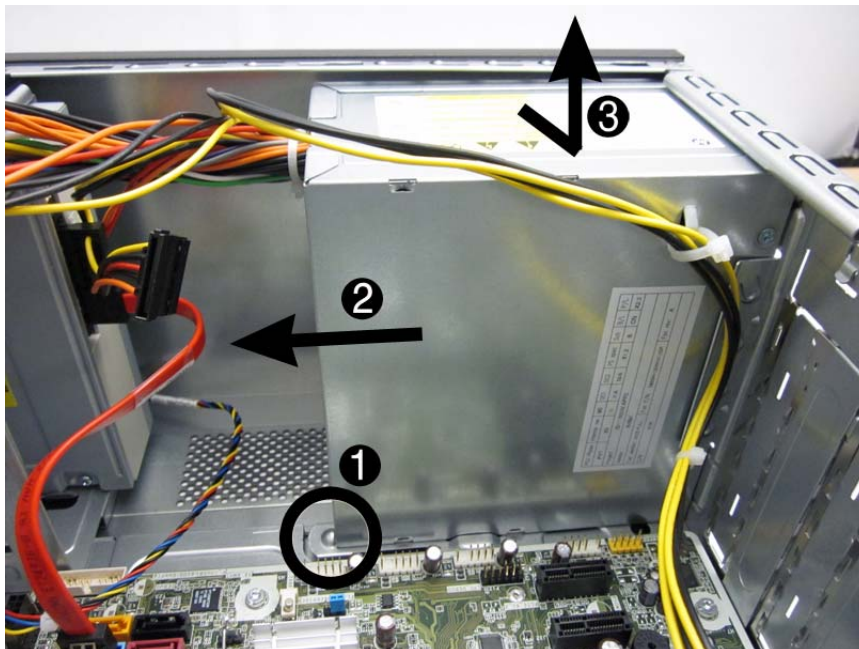

To install the power supply, reverse the removal procedure.

System Board

Description	Spare part number
System board for use in 3300 models with 65W Intel processors (includes thermal material)	656598-001
System board for use in 3300 models with 95W Intel processors (includes thermal material)	660281-001
System board for use in models with AMD processors on 3305 models (includes thermal material)	638404-001
System board for use in 7300 models with Intel processors (includes thermal material)	656599-001
System board for use in models with Intel processors on 7500 models without Windows 8 (includes thermal material)	687940-001
System board for use in 7500 models with Windows 8 with no Digital Product Key (DPK) (includes thermal material)	696887-001
System board for use in 7500 models with Windows 8 Standard (includes thermal material)	696887-501
System board for use in 7500 models with Windows 8 Professional (includes thermal material)	696887-601

When replacing the system board, be sure that the following components are removed from the defective system board and installed on the replacement system board:

- Memory modules
- Processor
- Expansion cards

To remove the system board:

1. Prepare the computer for disassembly ([Preparation for Disassembly on page 50](#)).
2. Remove the access panel ([Access Panel on page 51](#)).
3. Lay the computer on its side with the rear facing toward you.
4. Remove the front bezel ([Front Bezel on page 53](#)).
5. Remove an expansion cards ([Expansion Cards on page 61](#)).
6. Disconnect the power, and data cables from the back of all installed drives.
7. Disconnect all cables from the system board.

8. Remove the eight screws that secure the system board to the chassis.

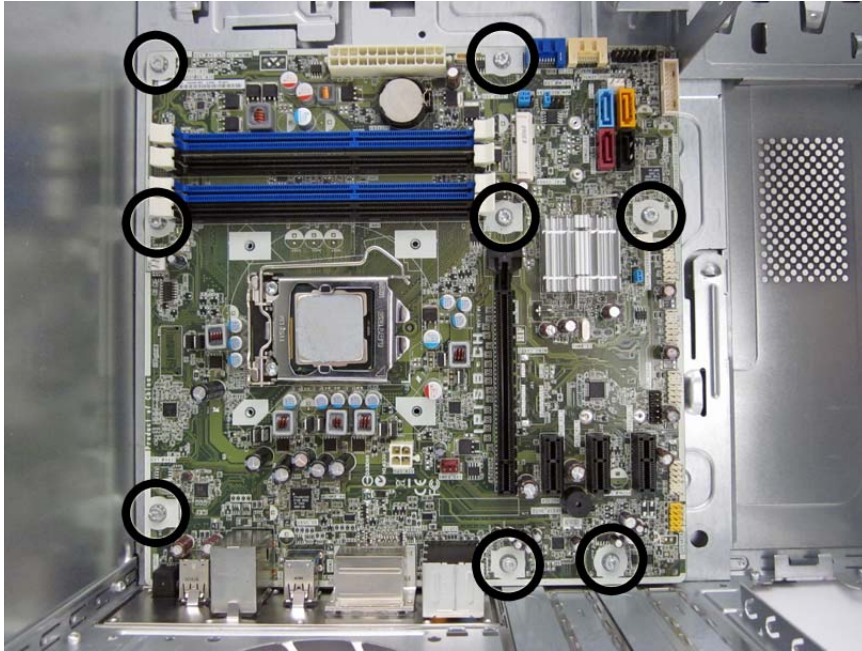

9. Slide the system board toward the front of the chassis, and then lift it up and out of the chassis.

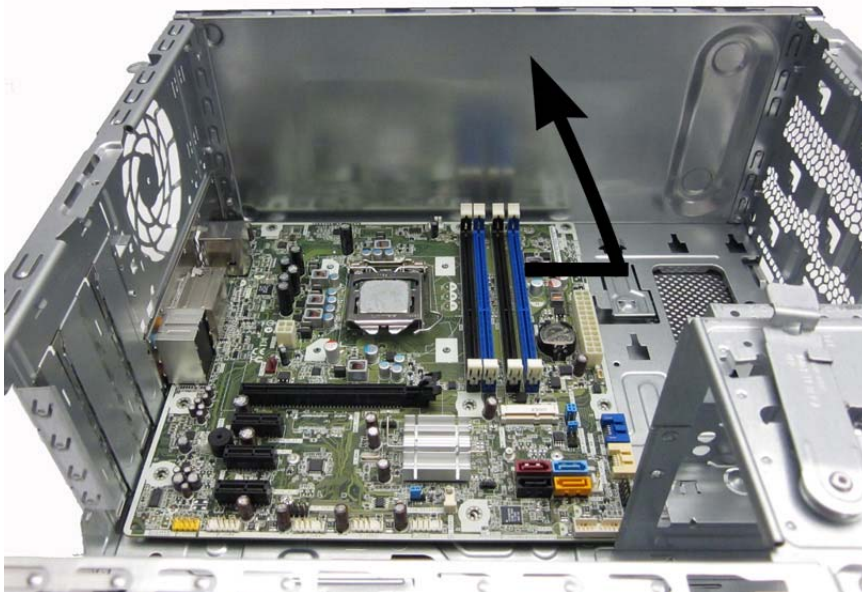

To install the system board, reverse the removal procedure.

 **NOTE:** When replacing the system board, you must also change the chassis serial number in the BIOS.

 **NOTE:** After installing a new system board, always update the system ROM to ensure that the latest version of the BIOS is being used on the computer. The latest system ROM BIOS can be found at: <http://h18000.www1.hp.com/support/files>.

Battery

The battery that comes with your computer provides power to the real-time clock and has a lifetime of about three years. When replacing the battery, use a battery equivalent to the battery originally installed on the computer. The computer comes with a 3-volt lithium coin cell battery.

 **NOTE:** The lifetime of the lithium battery can be extended by plugging the computer into a live AC wall socket. The lithium battery is only used when the computer is NOT connected to AC power.

 **WARNING!** This computer contains an internal lithium manganese dioxide battery. There is a risk of fire and burns if the battery is not handled properly. To reduce the risk of personal injury:

- Do not attempt to recharge the battery.
- Do not expose to temperatures higher than 60°C (140°F)
- Do not disassemble, crush, puncture, short external contacts, or dispose of in fire or water.
- Replace the battery only with the HP/Compaq spare designated for this product.

 **CAUTION:** Before replacing the battery, it is important to back up the computer CMOS settings. When the battery is removed or replaced, the CMOS settings will be cleared. Refer to the [Troubleshooting Without Diagnostics on page 144](#) chapter for information on backing up the CMOS settings.

 **NOTE:** Batteries, battery packs, and accumulators should not be disposed of together with the general household waste. In order to forward them to recycling or proper disposal, please use the public collection system or return them to HP, its authorized partners, or its agents.

 **CAUTION:** Static electricity can damage the electronic components of the computer or optional equipment. Before beginning these procedures, ensure that you are discharged of static electricity by briefly touching a grounded metal object.

1. Prepare the computer for disassembly ([Preparation for Disassembly on page 50](#)).
2. Remove the access panel ([Access Panel on page 51](#)).

 **NOTE:** It may be necessary to remove an expansion card to gain access to the battery.

3. Locate the battery and battery holder on the system board.
4. To release the battery from its holder, squeeze the metal clamp that extends above one edge of the battery. When the battery pops up, lift it out (1).

5. To insert the new battery, slide one edge of the replacement battery under the holder's lip with the positive side up (2). Push the other edge down until the clamp snaps over the other edge of the battery.

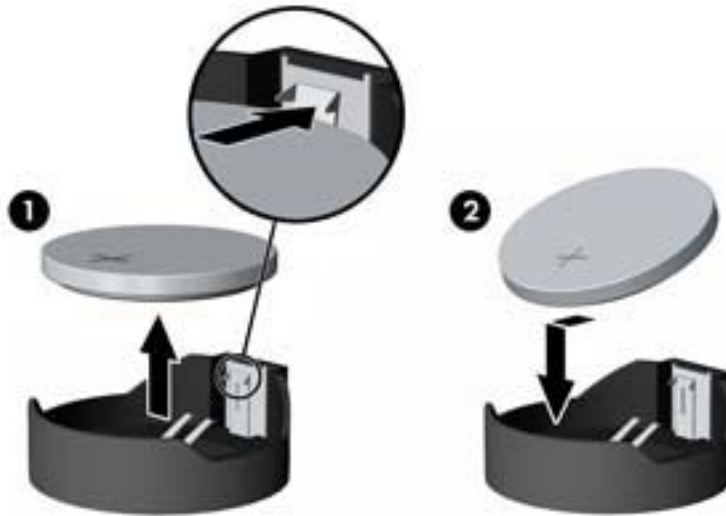

6. Replace the computer access panel.
7. Plug in the computer and turn on power to the computer.
8. Reset the date and time, your passwords, and any special system setups, using Computer Setup. Refer to [Computer Setup \(F10\) Utility on page 7](#).

8 Removal and Replacement Procedures Small Form Factor (SFF) Chassis

Adherence to the procedures and precautions described in this chapter is essential for proper service. After completing all necessary removal and replacement procedures, run the Diagnostics utility to verify that all components operate properly.

 **NOTE:** Not all features listed in this guide are available on all computers.

Preparation for Disassembly

See [Routine Care, and Disassembly Preparation on page 42](#) for initial safety procedures.

1. Remove/disengage any security devices that prohibit opening the computer.
2. Close any open software applications.
3. Exit the operating system.
4. Remove any compact disc or media card from the computer.
5. Turn off the computer and any peripheral devices that are connected to it.

 **CAUTION:** Turn off the computer before disconnecting any cables.

Regardless of the power-on state, voltage is always present on the system board as long as the system is plugged into an active AC outlet. In some systems the cooling fan is on even when the computer is in the “Standby,” or “Suspend” modes. The power cord should always be disconnected before servicing a unit.

6. Disconnect the power cord from the electrical outlet and then from the computer.
7. Disconnect all peripheral device cables from the computer.

 **NOTE:** During disassembly, label each cable as you remove it, noting its position and routing. Keep all screws with the units removed.

 **CAUTION:** The screws used in the computer are of different thread sizes and lengths; using the wrong screw in an application may damage the unit.

Access Panel

Description	Spare part number
Access panel	656832-001

1. Prepare the computer for disassembly ([Preparation for Disassembly on page 104](#)).
2. If the computer is on a stand, remove the computer from the stand.
3. Remove the Torx screw that secures the access panel to the computer.



4. Slide the access panel toward the back of the computer, and then pull it away from the computer.



To install the access panel, reverse the removal procedure.

Front Bezel

Description	Spare part number
Front bezel	656835-001

1. Prepare the computer for disassembly ([Preparation for Disassembly on page 104](#)).
2. Remove the access panel ([Access Panel on page 105](#)).
3. Lift up the three tabs on the top of the bezel.

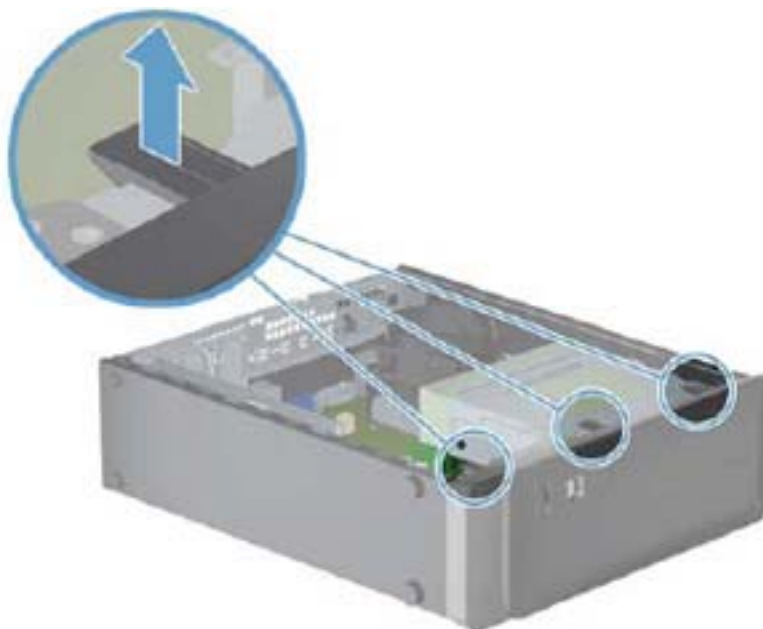

4. Rotate the bezel off the chassis.

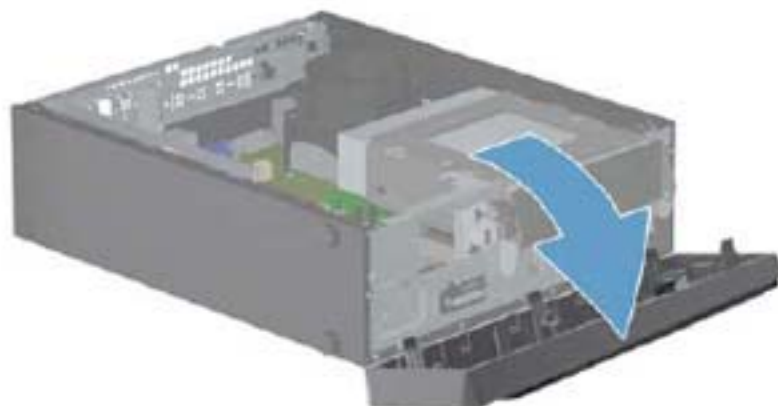

To install the front bezel, reverse the removal procedure.

Memory

Description	Spare part number
4-GB, PC3-10600	585157-001
2-GB, PC3-10600	635803-001
1-GB, PC3-10600	635802-001

The computer comes with double data rate 3 synchronous dynamic random access memory (DDR3-SDRAM) dual inline memory modules (DIMMs).

DDR3-SDRAM DIMMs

The memory sockets on the system board can be populated with up to two DIMMs.

These memory sockets are populated with at least one preinstalled DIMM. To achieve the maximum memory support, you can populate the system board with up to 8 GB of memory:

For proper system operation, the DDR3-SDRAM DIMMs must be:

- industry-standard 240-pin
- unbuffered non-ECC PC3-10600 DDR3-1333 MHz-compliant
- 1.5 volt DDR3-SDRAM DIMMs

The DDR3-SDRAM DIMMs must also:

- support CAS latency 9 DDR3 1333 MHz (9-9-9 timing)
- contain the mandatory JEDEC SPD information

In addition, the computer supports:

- 512-Mbit, 1-Gbit, and 2-Gbit non-ECC memory technologies
- single-sided and double-sided DIMMs
- DIMMs constructed with x8 and x16 DDR devices; DIMMs constructed with x4 SDRAM are not supported



NOTE: The system will not operate properly if you install unsupported DIMMs.

Populating DIMM Sockets

There are two DIMM sockets on the system board, with one socket per channel.

Populate the DIMM sockets in the following order: DIMM1, DIMM2

 **NOTE:** System board appearance may vary.

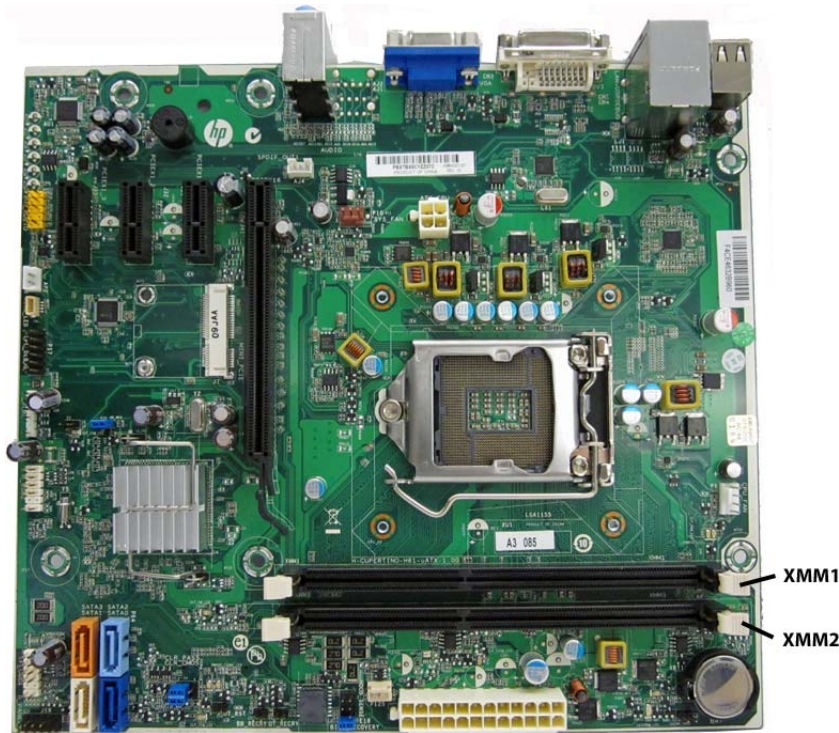

Item	Description	Socket Color	Insertion Order
1	XMM1 socket, Channel A (populate first)	Black	1
2	XMM2 socket, Channel A	Black	2

NOTE: A DIMM must occupy the DIMM1 socket.

- The system will operate in single channel mode if the DIMM sockets are populated in one channel only.
- The system will operate in a higher-performing dual channel mode if the total memory capacity of the DIMM in Channel A is equal to the total memory capacity of the DIMM in Channel B. The technology and device width can vary between the channels. For example, if Channel A is populated with one 2-GB DIMMs and Channel B is populated with one 2-GB DIMM, the system will operate in dual channel mode.
- The system will operate in flex mode if the total memory capacity of the DIMM in Channel A is not equal to the total memory capacity of the DIMM in Channel B. In flex mode, the channel populated with the least amount of memory describes the total amount of memory assigned to dual channel and the remainder is assigned to single channel. For optimal speed, the channels should be balanced so that the largest amount of memory is spread between the two channels.

If one channel will have more memory than the other, the larger amount should be assigned to Channel A. For example, if you are populating the sockets with one 2-GB DIMM, and one 1-GB DIMMs, Channel A should be populated with the 2-GB DIMM, and Channel B should be populated with the 1-GB DIMM. With this configuration, 2 GB will run as dual channel and 1 GB will run as single channel.

- In any mode, the maximum operational speed is determined by the slowest DIMM in the system.

The system will automatically operate in single channel mode, dual channel mode, or flex mode, depending on how the DIMMs are installed.

Removing DIMMs

⚠ CAUTION: You must disconnect the power cord and wait approximately 30 seconds for the power to drain before adding or removing memory modules. Regardless of the power-on state, voltage is always supplied to the memory modules as long as the computer is plugged into an active AC outlet. Adding or removing memory modules while voltage is present may cause irreparable damage to the memory modules or system board.

The memory module sockets have gold-plated metal contacts. When upgrading the memory, it is important to use memory modules with gold-plated metal contacts to prevent corrosion and/or oxidation resulting from having incompatible metals in contact with each other.

Static electricity can damage the electronic components of the computer or optional cards. Before beginning these procedures, ensure that you are discharged of static electricity by briefly touching a grounded metal object. For more information, refer to [Electrostatic Discharge Information on page 42](#).

When handling a memory module, be careful not to touch any of the contacts. Doing so may damage the module.

1. Prepare the computer for disassembly ([Preparation for Disassembly on page 104](#)).
2. Remove the access panel ([Access Panel on page 105](#)).
3. Remove the front bezel ([Front Bezel on page 107](#)).
4. Rotate the optical drive to its upright position.

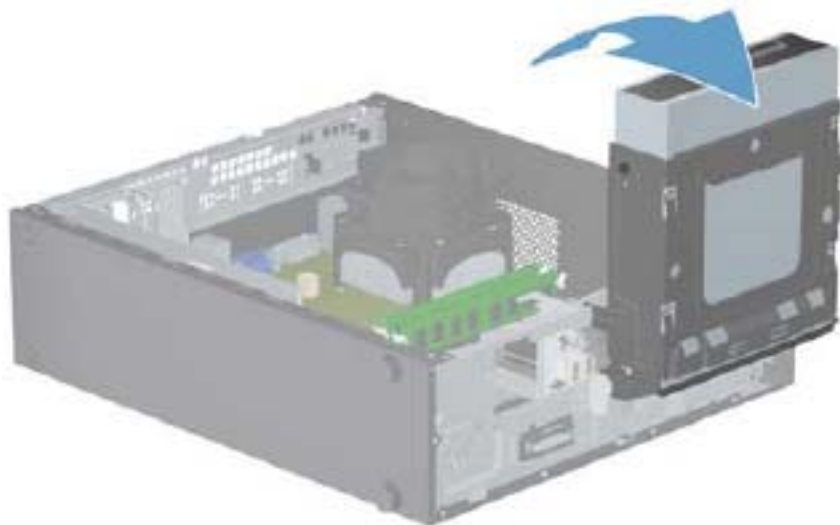

5. Open both latches of the memory module socket (1), and remove the memory module from the socket (2).

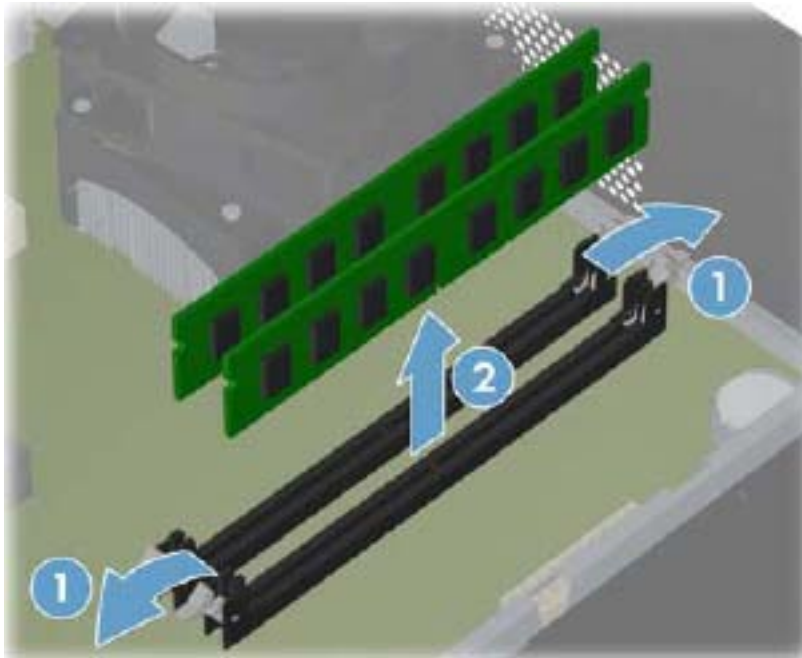

 **NOTE:** A memory module can be installed in only one way. Match the notch on the module with the tab on the memory socket.

For maximum performance, populate the sockets so that the memory capacity is spread as equally as possible between Channel A and Channel B.

6. To install a memory module, holding the module by the edges, completely slide it into the slot. Make sure the module is pressed completely into the socket, and then gently push down on the module until it snaps in place.

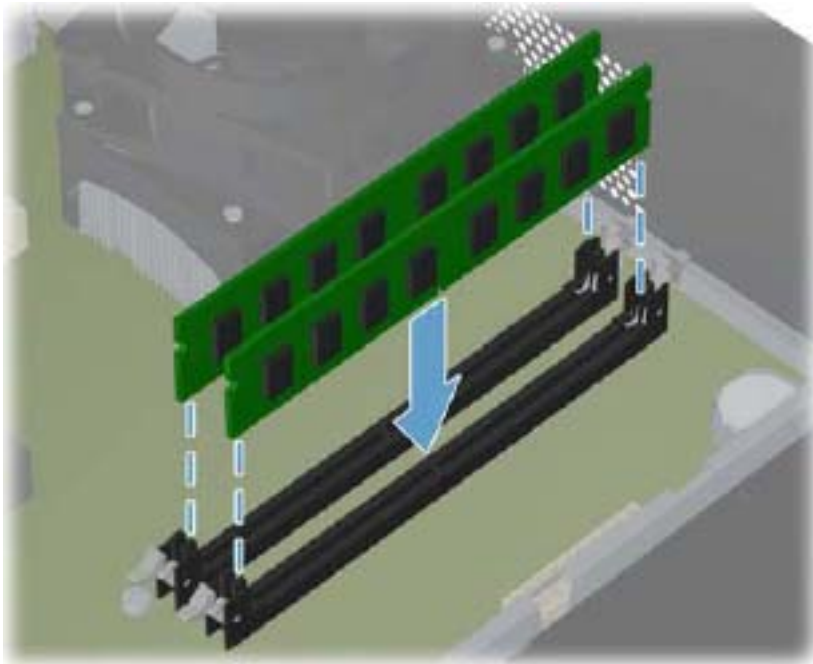

 **NOTE:** A memory module can be installed in only one way. Match the notch on the module with the tab on the memory socket.

For maximum performance, populate the sockets so that the memory capacity is spread as equally as possible between Channel A and Channel B.

The computer should automatically recognize the additional memory the next time you turn on the computer.

Expansion Card

Description	Spare part number
Graphics cards	
nVidia GeForce GT530 2-GB graphics adapter	659354-001
nVidia GeForce GT520 1-GB graphics adapter	657400-001
nVidia GeForce 405 PCIe x16 graphics card, 1 GB	656789-001
ATI Radeon HD7350 512-MB graphics adapter	676356-001
ATI Radeon HD6570 1-GB graphics adapter	659355-001
ATI Radeon HD6450 PCIe x16 graphics card, 1 GB	647451-001
ATI Radeon HD6450 PCIe x16 graphics card, 512 MB	647450-001

The HP Pro 3300 SFF has one PCIe x16 expansion slot, three PCIe x1 expansion slots, and one MiniPCI slot.

Expansion Slot Locations (Model 3300 shown)

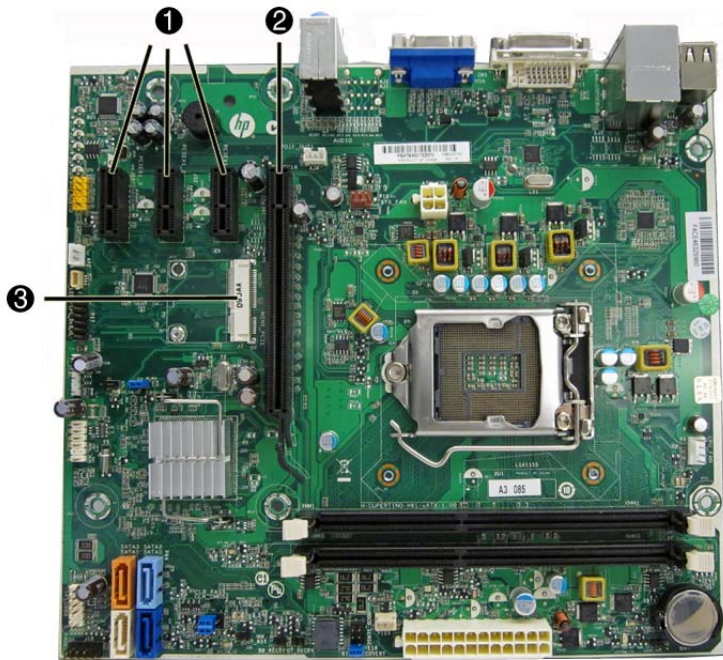

Item	Description
1	PCI Express x1 expansion slots (3)
2	PCI Express x16 expansion slot
3	MiniPCI slot

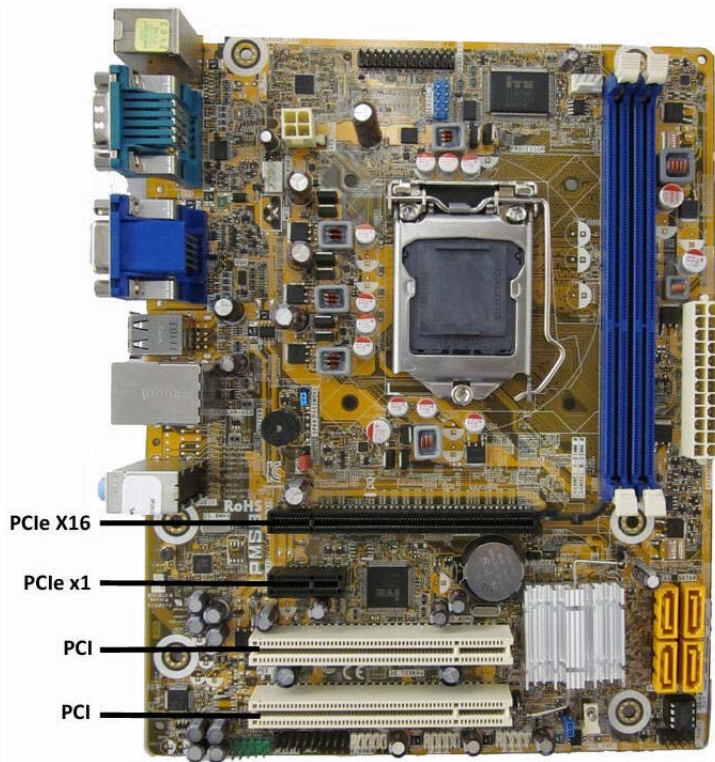

 **NOTE:** Board appearance and color may vary.

 **NOTE:** You can install a PCI Express x1, x4, x8, or x16 expansion card in the PCI Express x16 expansion slot.

Item	Description
PCIe X16	PCI Express x16 expansion slot
PCIe x1	PCIe x1 expansion slot
PCI	PCI expansion slot
PCI	PCI expansion slot

To remove, replace, or add an expansion card:

1. Prepare the computer for disassembly ([Preparation for Disassembly on page 104](#)).
2. Remove the access panel ([Access Panel on page 105](#)).
3. Locate the correct vacant expansion socket on the system board and the corresponding expansion slot on the back of the computer chassis.

4. Release the slot cover bracket by removing the screw that secures the bracket, and then lifting the bracket off the computer.



5. Before installing an expansion card, remove the expansion slot cover or the existing expansion card.

 **NOTE:** Before removing an installed expansion card, disconnect any cables that may be attached to the expansion card.

- a. If you are installing an expansion card in a vacant socket, remove the appropriate expansion slot cover on the back of the chassis. Pull the slot cover straight up then away from the inside of the chassis.

- b. If you are removing a PCI Express x16 card, pull the retention arm on the back of the expansion socket away from the card and carefully rock the card back and forth until the connectors pull free from the socket. Pull the expansion card straight up from the socket then away from the inside of the chassis to release it from the chassis frame. Be sure not to scrape the card against the other components.

 **NOTE:** PCI cards and PCI Express x1 cards do not have the retention arm. PCI Express X16 card is shown below.

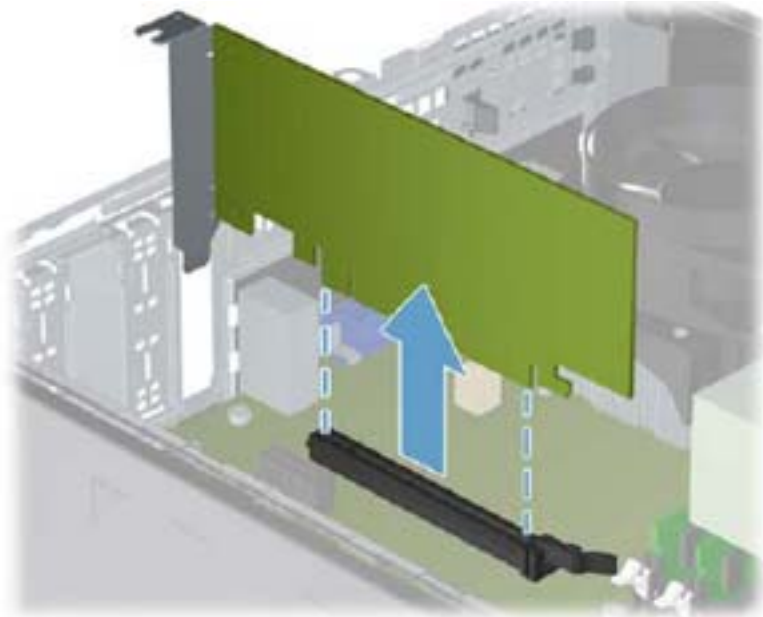

6. Store the removed card in anti-static packaging.
7. If you are not installing a new expansion card, install an expansion slot cover to close the open slot.

 **CAUTION:** After removing an expansion card, you must replace it with a new card or expansion slot cover for proper cooling of internal components during operation.

8. To install a new expansion card, hold the card just above the expansion socket on the system board then move the card toward the rear of the chassis so that the bracket on the card is aligned with the open slot on the rear of the chassis. Press the card straight down into the expansion socket on the system board.

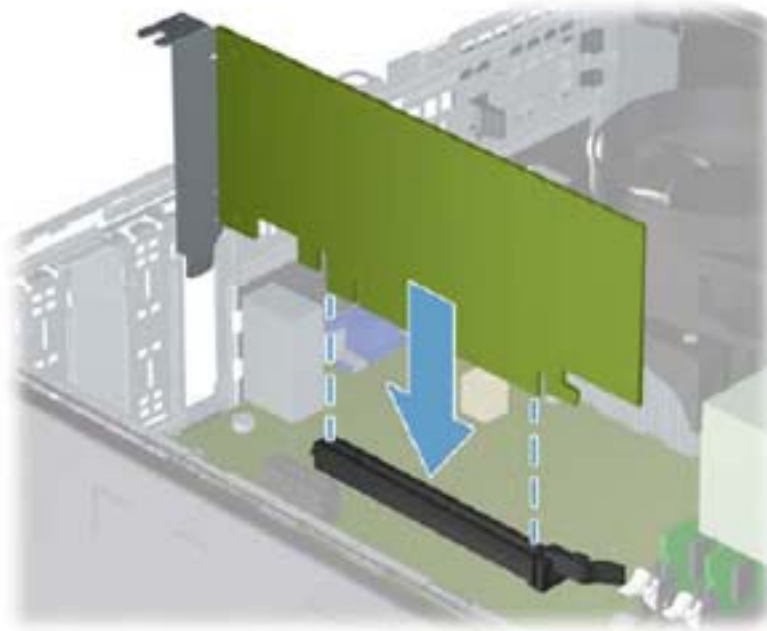

 **NOTE:** When installing an expansion card, press firmly on the card so that the whole connector seats properly in the expansion card slot.

9. Reattach the bracket to the back of the computer



10. Connect external cables to the installed card, if needed. Connect internal cables to the system board, if needed.
11. Reconfigure the computer, if necessary.

Cable Management

Always follow good cable management practices when working inside the computer.

- Keep cables away from major heat sources like the heat sink.
- Do not jam cables on top of expansion cards or memory modules. Printed circuit cards like these are not designed to take excessive pressure on them.
- Some flat ribbon cables come prefolded. Never change the folds on these cables.
- Never bend a SATA data cable tighter than a 30 mm (1.18 in) radius.
- Never crease a SATA data cable.
- Do not rely on components like the drive cage, power supply, or computer cover to push cables down into the chassis. Always position the cables to lay properly by themselves.

When removing the power supply power cable from the P1 connector on the system board, always follow these steps:

1. Squeeze on the top of the retaining latch attached to the cable end of the connector **(1)**.
2. Grasp the cable end of the connector and pull it straight up **(2)**.

⚠ CAUTION: Always pull the connector - NEVER pull on the cable. Pulling on the cable could damage the cable and result in a failed power supply.

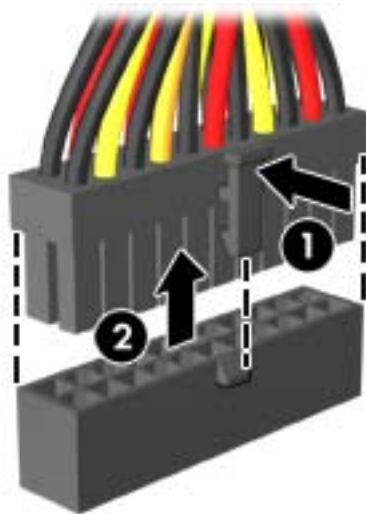

Cable Connections

System board connectors are color-coded to make it easier to find the proper connection.

Connector Name	Connector Color	Description
ATX_POWER	white	Power supply, 24-pin
ATX_CPU	white	Power supply, 4-pin
SYS_FAN	brown	Chassis fan
CPU_FAN	white	Heat sink fan
INT_SPKR	white	Speaker
F_PANEL	black	Power switch
F_AUDIO	yellow	Front I/O audio
MINI_LED	white	Front I/O
F_USB1	white	Media card reader
F_USB2	white	Front I/O USB
F_USB3	white	Front I/O USB
SATA1	dark blue	Primary hard drive
SATA2	white	Primary optical drive
SATA3	light blue	Second hard drive
SATA4	orange	Second optical drive

Drives

Description	Spare part number
16X SATA DVD±RW drive	581600-001
DVD-ROM drive	581599-001
2 TB, 7200 rpm SATA hard drive	616608-001
1.5 TB, 7200 rpm SATA hard drive	613209-001
1 TB, 7200 rpm SATA hard drive	621418-001
750 GB, 7200 rpm SATA hard drive	632938-001
500 GB, 7200 rpm SATA hard drive	621421-001
320 GB, 7200 rpm SATA hard drive, 2.5-inch	621420-001

Drive Positions



- 1 5.25-inch external drive bay for an optical drive
- 2 3.5-inch internal drive bay for a hard drive

To verify the type and size of the storage devices installed in the computer, run Computer Setup.

Removing Drives

When installing drives, follow these guidelines:

- The primary Serial ATA (SATA) hard drive must be connected to the dark blue primary SATA connector on the system board labeled SATA0.
- Connect an optical drive to the light blue SATA connector on the system board labeled SATA2.
- The power cables for the SATA drives connect directly to the power supply. The primary hard drive connects to the power connector labeled P4. the primary optical drive connects to the power connector labeled P3.
- The system does not support Parallel ATA (PATA) optical drives or PATA hard drives.

 **CAUTION:** To prevent loss of work and damage to the computer or drive:

If you are inserting or removing a drive, shut down the operating system properly, turn off the computer, and unplug the power cord. Do not remove a drive while the computer is on or in standby mode.

Before handling a drive, ensure that you are discharged of static electricity. While handling a drive, avoid touching the connector. For more information about preventing electrostatic damage, refer to [Electrostatic Discharge Information on page 42](#).

Handle a drive carefully; do not drop it.

Do not use excessive force when inserting a drive.

Avoid exposing a hard drive to liquids, temperature extremes, or products that have magnetic fields such as monitors or speakers.

If a drive must be mailed, place the drive in a bubble-pack mailer or other protective packaging and label the package "Fragile: Handle With Care."

Removing an Optical Drive

 **CAUTION:** All removable media should be taken out of a drive before removing the drive from the computer.

1. Prepare the computer for disassembly ([Preparation for Disassembly on page 104](#)).
2. Remove the access panel ([Access Panel on page 105](#)).
3. Remove the front bezel ([Front Bezel on page 107](#)).
4. Rotate the drive cage to its upright position.

5. If removing an optical drive, disconnect the cables from the rear of the drive.

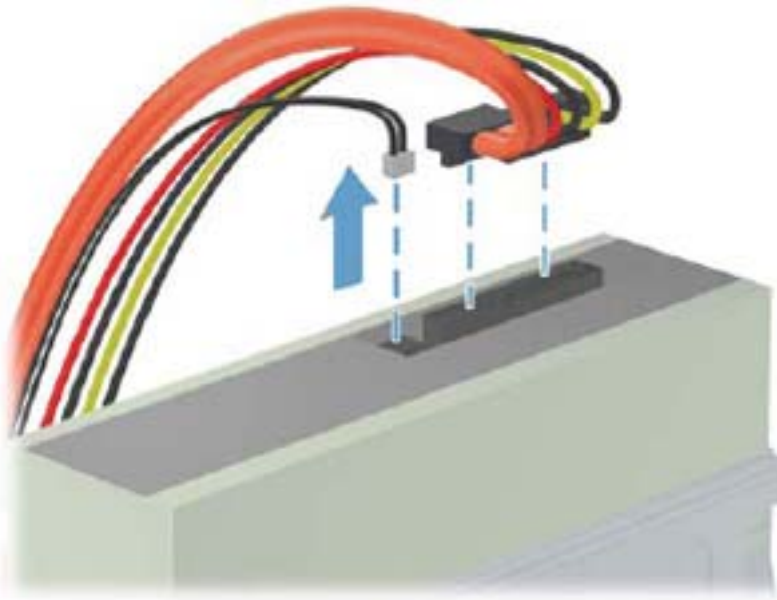

6. Remove the Torx screw from the cage.

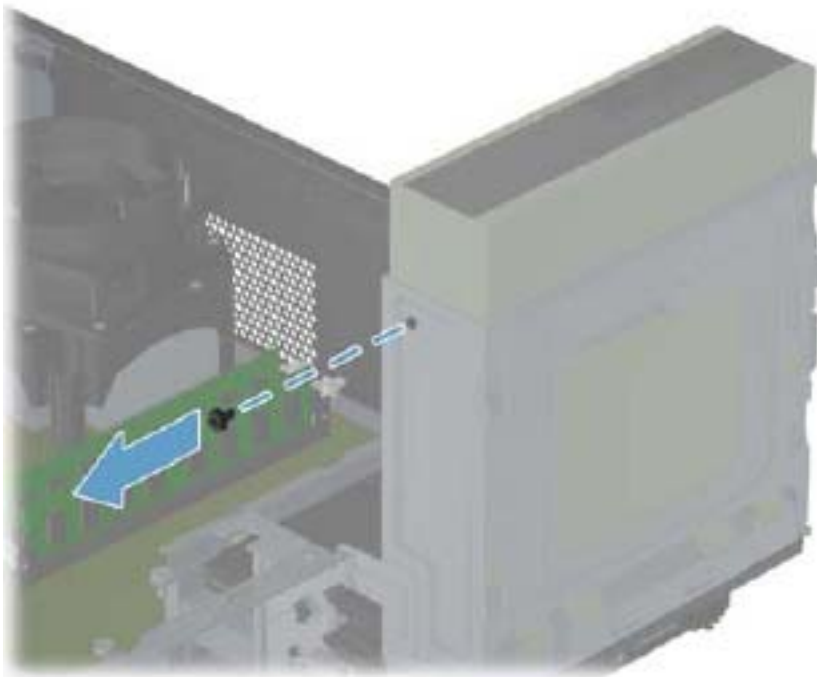

7. Return the drive to its normal position.

8. Push the optical drive from behind, and then remove it from the front of the computer.



Removing the Hard Drive

 **NOTE:** Before you remove the old hard drive, be sure to back up the data from the old hard drive so that you can transfer the data to the new hard drive.

The preinstalled 3.5-inch hard drive is located under the power supply. To remove and replace the hard drive:

1. Prepare the computer for disassembly ([Preparation for Disassembly on page 104](#)).
2. Remove the access panel ([Access Panel on page 105](#)).
3. Remove the front bezel ([Front Bezel on page 107](#)).
4. Rotate the drive cage to its upright position.

5. On the front of the computer, pull and hold the hard drive release latch to unlock the hard drive.

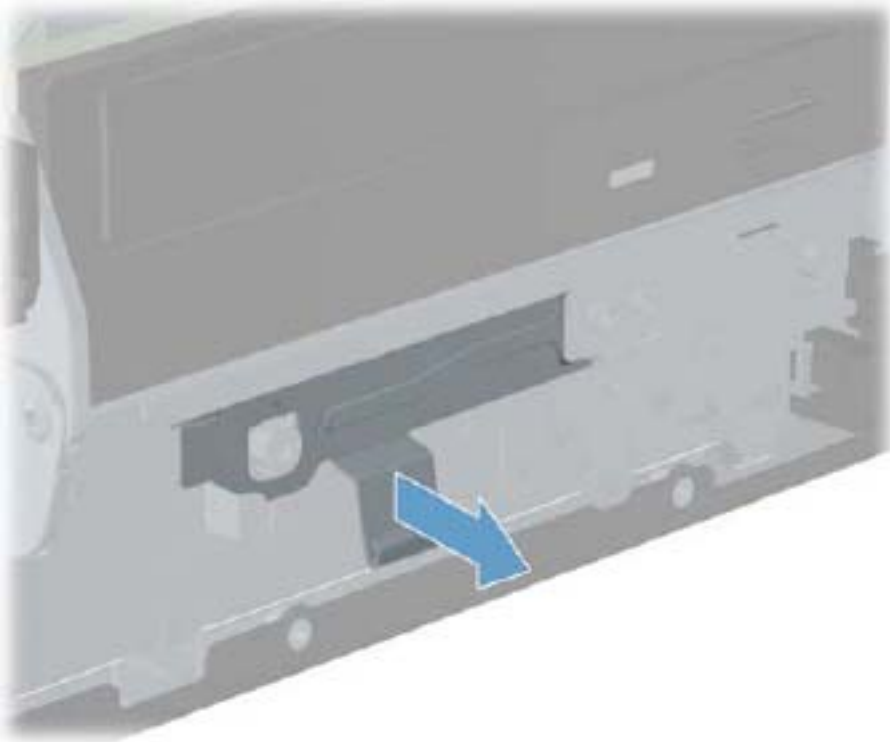

6. With the release latch pulled out, lift the rear of the hard drive.

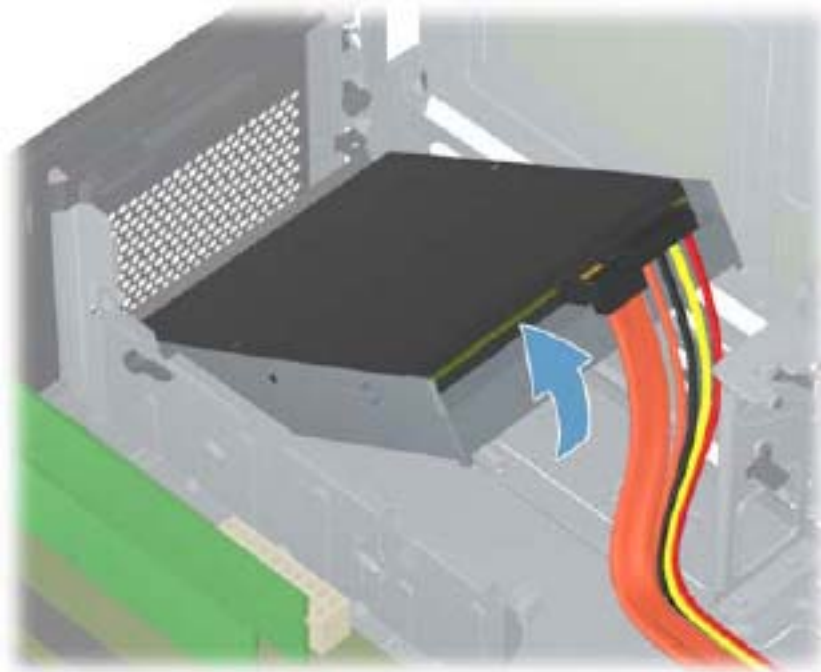

7. Disconnect the cables from the rear of the hard drive.

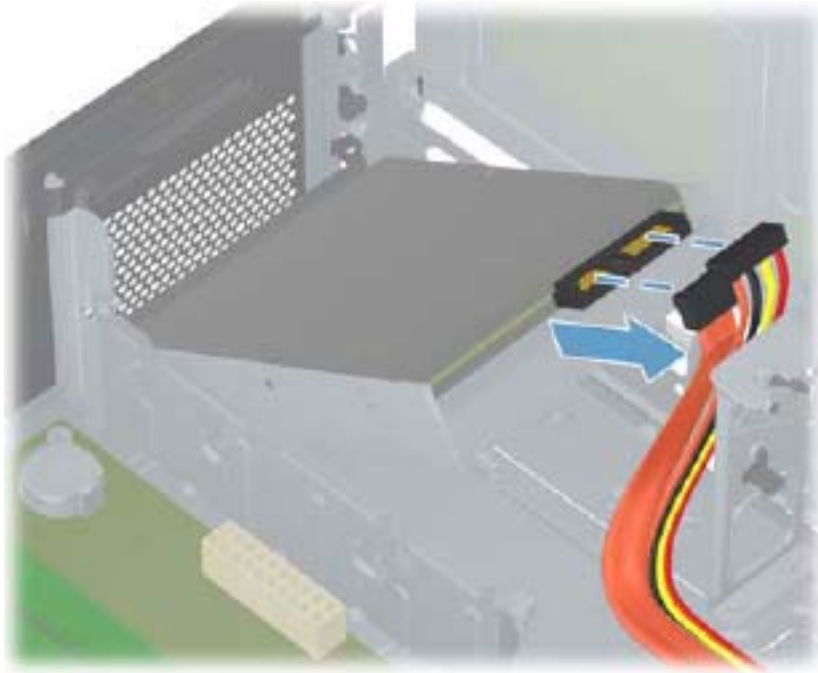

8. Remove the hard drive from the computer.

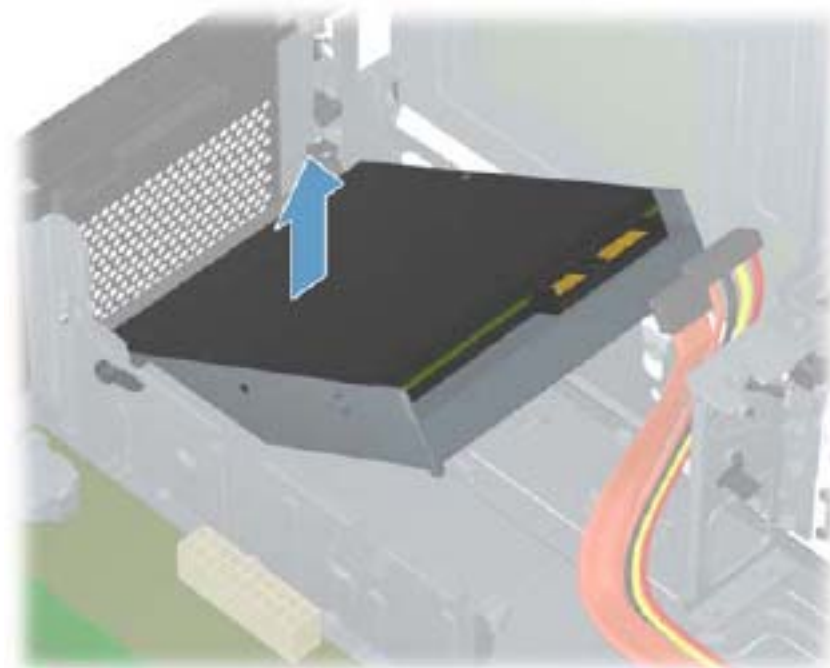

9. Remove the four guide screws from the hard drive for use in the replacement hard drive.



To replace the hard drive, reverse the removal procedures.

Power Switch

Description	Spare part number
Power switch/LED assembly	656984-001

The power switch is attached to the front of the chassis using tabs (no screws). Its cable routes through metal tabs in the chassis floor. The power switch cable connects to the front USB assembly cable.

1. Prepare the computer for disassembly ([Preparation for Disassembly on page 104](#)).
2. Remove the access panel ([Access Panel on page 105](#)).
3. Remove the front bezel ([Front Bezel on page 107](#)).
4. From the inside of the computer, remove the power switch cable from the tabs on the computer floor.



5. Disconnect the power switch cable from the front USB assembly cable.

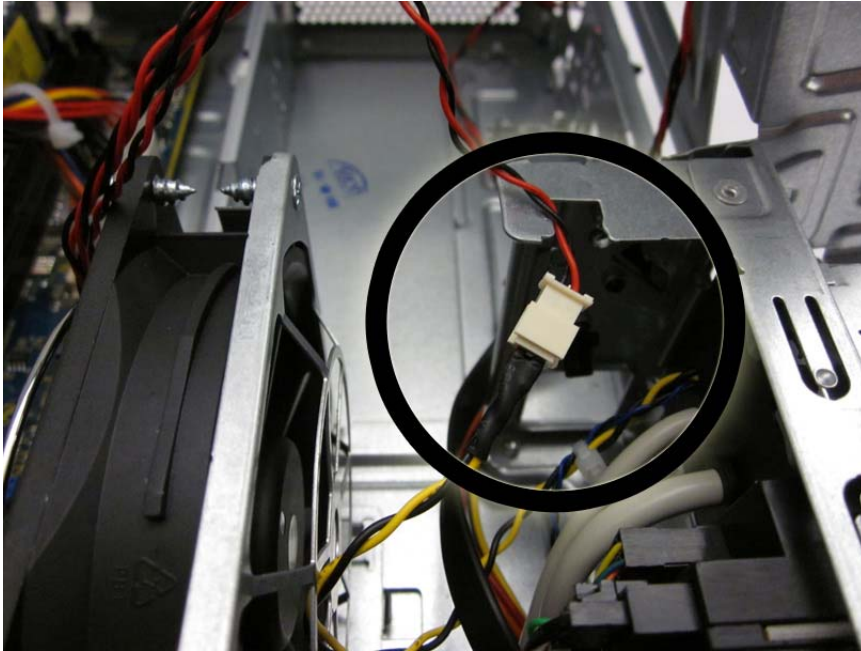

6. From the outside, front of the computer, press the tab on the right side of the power switch (1) to disengage it from the chassis.
7. Rotate the power switch right to left (2), and then remove it from the computer (3) while routing the cable through the hole in the front of the chassis.

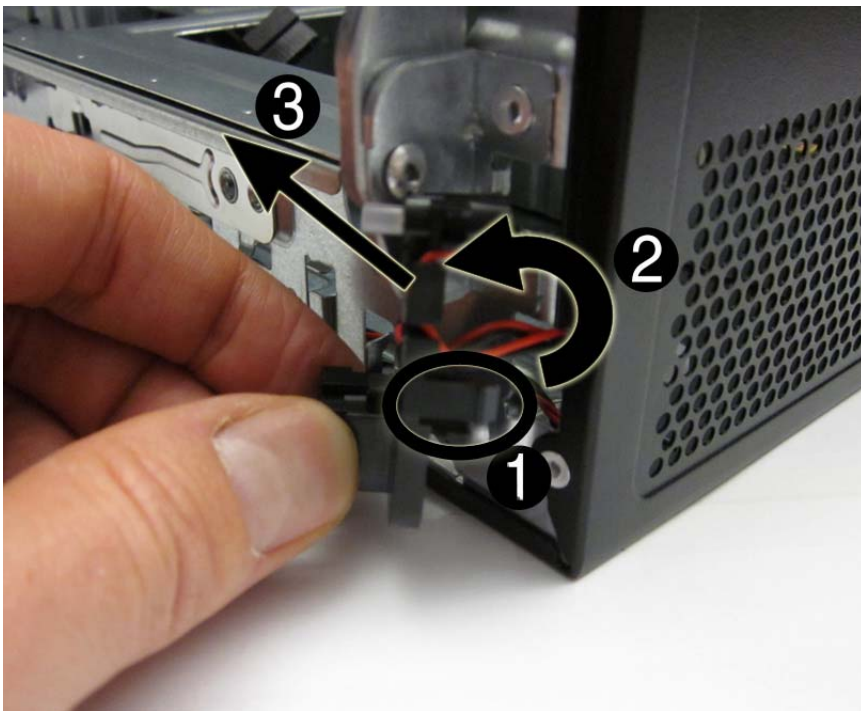

To install the power switch, reverse the removal procedure.

Front USB Assembly

Description	Spare part number
Front I/O and card reader (6-in-1)	656983-001

The front USB assembly is secured to the front of the chassis with one screw. Push the assembly into the chassis to remove it.

1. Prepare the computer for disassembly ([Preparation for Disassembly on page 104](#)).
2. Remove the access panel ([Access Panel on page 105](#)).
3. Remove the front bezel ([Front Bezel on page 107](#)).
4. Disconnect the four cables from the system board as follows:
 - Yellow connector labeled F_AUDIO
 - White connector labeled MINI_LED
 - White connector labeled F_USB3
 - Black connector labeled F_USB2

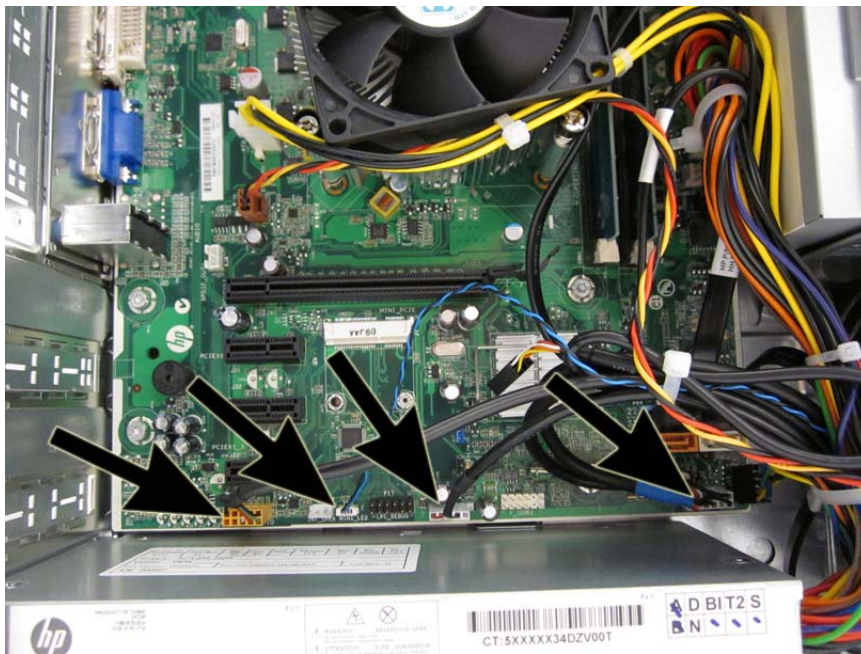

5. Remove the cables from the clip on the base pan of the computer.



6. From the front of the computer, remove the screw that secures the assembly to the front of the chassis.



7. Push the left side of the assembly down slightly (1), and then push the assembly into the computer (2).

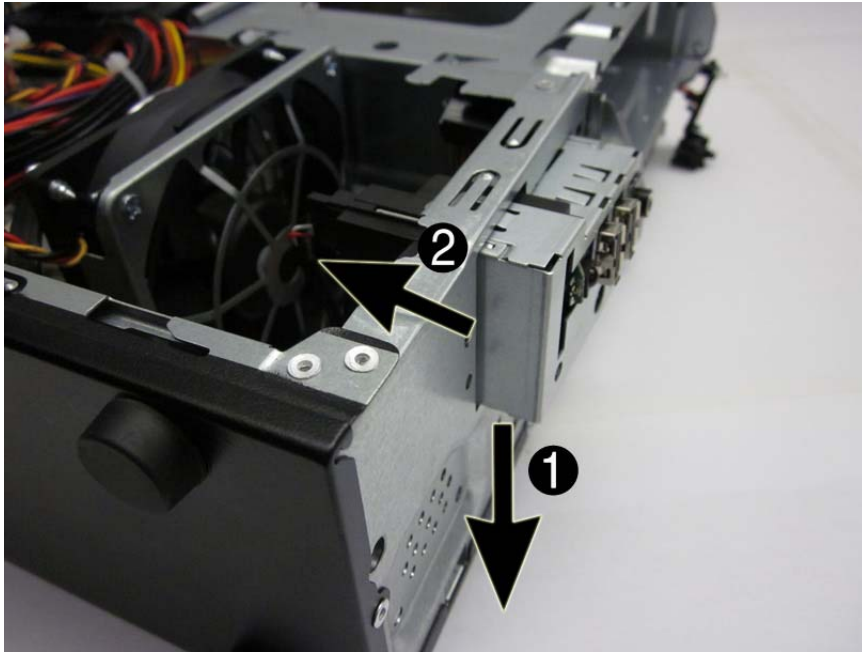

8. Remove the assembly from the computer.

To install the front USB assembly, reverse the removal procedure.

Fan Assembly

Description	Spare part number
Fan	656834-001

The fan assembly is attached to the inside floor of the chassis using two screws. The fan is inside of a removal metal cage.

1. Prepare the computer for disassembly ([Preparation for Disassembly on page 104](#)).
2. Remove the access panel ([Access Panel on page 105](#)).
3. Remove the front bezel ([Front Bezel on page 107](#)).
4. Disconnect the fan cable from the system board connector labeled SYS_FAN.
5. Remove the Torx screw that secures the left side of the fan to the computer.
6. Cut the plastic tie (1) that secures the fan cable to the power supply power cables.
7. Remove the two screws (2) that secure the fan to the computer. The screw near the computer side is not shown in the following image.
8. Lift the fan assembly up and out of the computer (3).

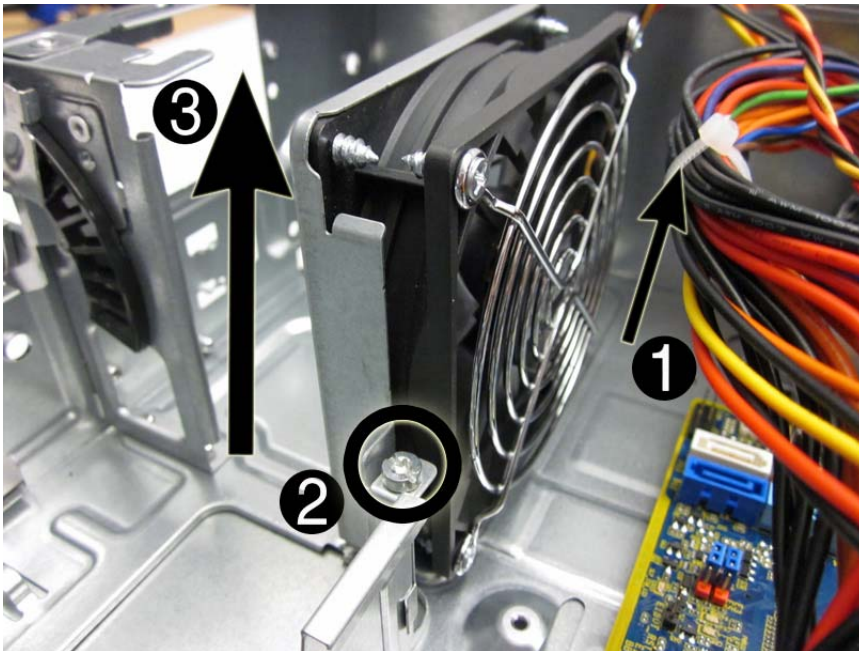

9. if you need to remove the fan from the metal case, remove the four screws that secure the fan to the case, and remove the fan from the case.

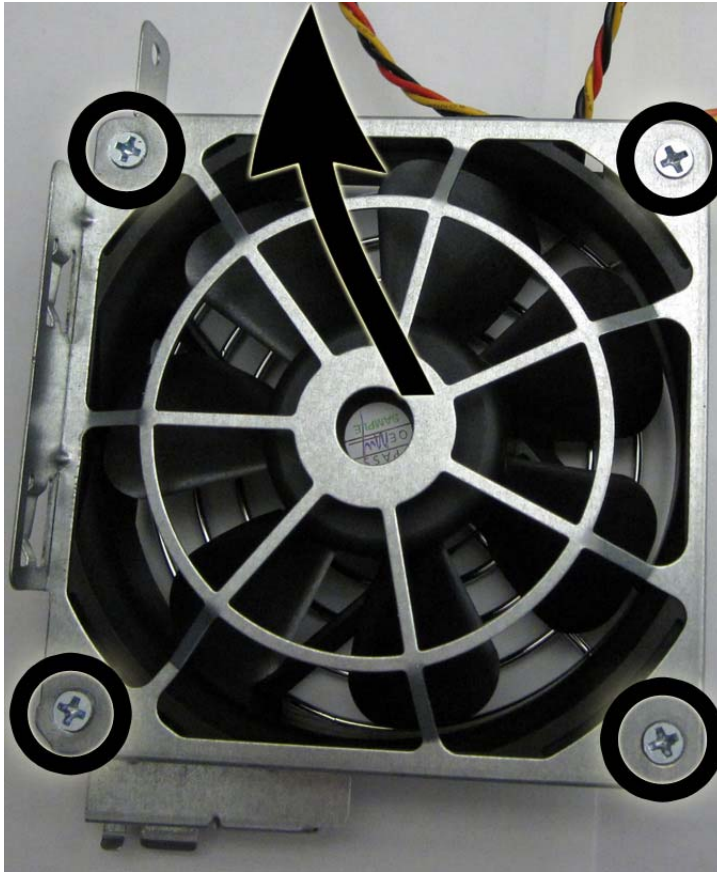

To install the fan, reverse the removal procedure.

Fan Sink

Description	Spare part number
Fan sink	657402-001

The fan sink is secured atop the processor with four captive Torx screws. A fan cable connects to the system board.

1. Prepare the computer for disassembly ([Preparation for Disassembly on page 104](#)).
2. Remove the access panel ([Access Panel on page 105](#)).
3. Loosen the four captive screws that secure the fan sink to the system board tray.

⚠ CAUTION: Fan sink retaining screws should be removed in diagonally opposite pairs (as in an X) to even the downward forces on the processor. This is especially important as the pins on the socket are very fragile and any damage to them may require replacing the system board.



4. Disconnect the cable from the system board (1), lift the fan sink from atop the processor (2) and set it on its side to keep from contaminating the work area with thermal grease.

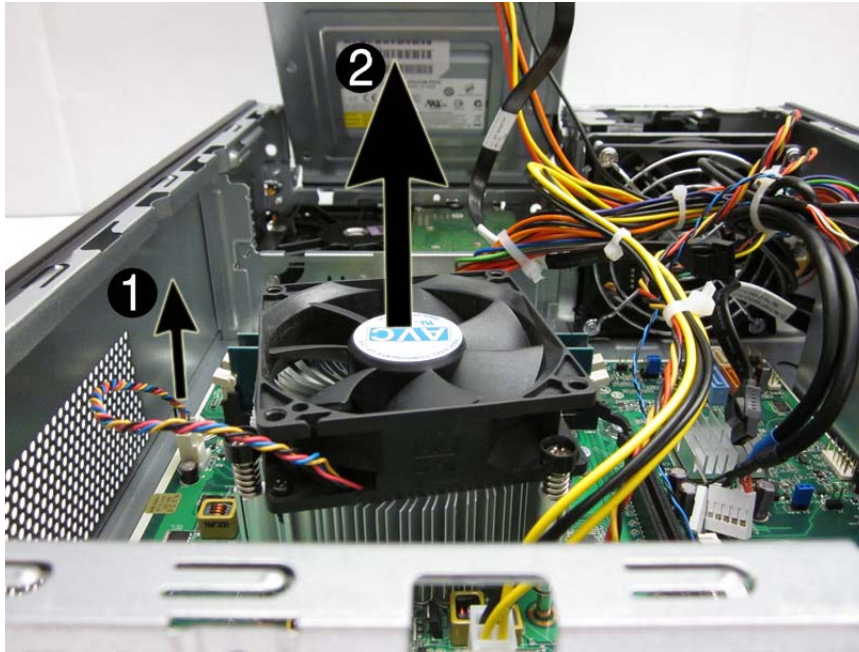

When reinstalling the fan sink, make sure that its bottom has been cleaned with an alcohol wipe and fresh thermal grease has been applied to the top of the processor.

CAUTION: Fan sink retaining screws should be tightened in diagonally opposite pairs (as in an X) to evenly seat the heat sink on the processor to avoid damage that could require replacing the system board.

Failure to install the fan duct may cause the computer to overheat.

Processor

Description	Spare part number
Intel Core i7 processors	
2600S (2.7 GHz, 8-MB L3 cache, 65W)	638419-001
Intel Core i5 processors	
2500S (2.7 GHz, 6-MB L3 cache, 65W)	638420-001
2500 (3.3 GHz, 6-MB L3 cache, 95W)	638631-001
2405S (2.5-GHz, 6-MB L3 cache, 65W)	656790-001
2400S (2.5 GHz, 6-MB L3 cache, 65W)	640953-001
2400 (3.1 GHz, 6-MB L3 cache, 95W)	638630-001
2320 (3.0 GHz, 6-MB L3 cache, 95W)	665121-001-001
2310 (2.9 GHz, 6-MB L3 cache, 95W)	657111-001
2300 (2.8 GHz, 6-MB L3 cache, 95W)	654601-001
Intel Core i3 processors	
2130 (3.4 GHz, 3-MB L3 cache, 65W)	665120-001
2125 (3.3 GHz, 3-MB L3 cache, 65W)	677427-001
2120 (3.3 GHz, 3-MB L3 cache, 65W)	638629-001
2105 (3.1 GHz, 3-MB L3 cache, 65W)	655970-001
2100 (3.1 GHz, 3-MB L3 cache, 65W)	638628-001
Intel Pentium Dual-Core processors	
G860 (3.0 GHz, 3-MB L3 cache, 65W)	665123-001
G850 (2.9-GHz, 3-MB L3 cache, 65W)	655973-001
G840 (2.8-GHz, 3-MB L3 cache, 65W)	655972-001
G630 (2.7 GHz, 3-MB L3 cache, 65W)	665122-001
G620 (2.6-GHz, 3-MB L3 cache, 65W)	655971-001
G540 (2.5 GHz, 2-MB L3 cache, 65W)	665119-001
G530 (2.4 GHz, 2-MB L3 cache, 65W)	665117-001
G530T (2.0 GHz, 2-MB L3 cache, 35W)	665118-001

1. Prepare the computer for disassembly ([Preparation for Disassembly on page 104](#)).
2. Remove the access panel ([Access Panel on page 105](#)).
3. Remove the fan sink ([Fan Sink on page 134](#)).
4. Rotate the locking lever to its full open position **(1)**.
5. Raise and rotate the microprocessor retainer to its fully open position **(2)**.

- Carefully lift the processor from the socket (3).

CAUTION: Do NOT handle the pins in the processor socket. These pins are very fragile and handling them could cause irreparable damage. Once pins are damaged it may be necessary to replace the system board.

The heat sink must be installed within 24 hours of installing the processor to prevent damage to the processor's solder connections.

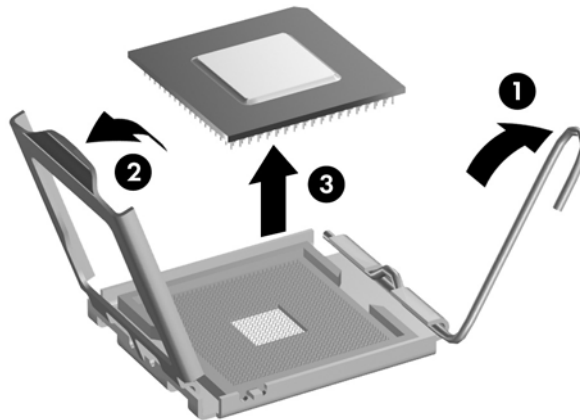

To install a new processor:

- Place the processor in its socket and close the retainer. Make sure the slot in the processor fits into the post on the socket.
- Secure the locking lever. If reusing the existing heat sink, go to step 3. If using a new heat sink, go to step 6.
- If reusing the existing fan sink, clean the bottom of the fan sink with the alcohol pad provided in the spares kit.

CAUTION: Before reinstalling the fan sink you must clean the top of the processor and the bottom of the fan sink with an alcohol pad supplied in the spares kit. After the alcohol has evaporated, apply thermal grease to the top of the processor from the syringe supplied in the spares kit.

- Apply the thermal grease provided in the spares kit to the top of the processor and install the fan sink atop the processor.
- Go to step 7.
- If using a new fan sink, remove the protective covering from the bottom of the fan sink and place it in position atop the processor.
- Secure the fan sink to the system board and system board tray.

CAUTION: Fan sink retaining screws should be tightened in diagonally opposite pairs (as in an X) to evenly seat the fan sink on the processor. This is especially important as the pins on the socket are very fragile and any damage to them may require replacing the system board.



NOTE: After installing a new processor onto the system board, always update the system ROM to ensure that the latest version of the BIOS is being used on the computer. The latest system BIOS can be found on the Web at: <http://h18000.www1.hp.com/support/files>.

Power Supply

Description	Spare part number
Power supply, 220W	656722-001
Power supply, 270W	665224-001



WARNING! To reduce potential safety issues, only the power supply provided with the computer, a replacement power supply provided by HP, or a power supply purchased as an accessory from HP should be used with the computer.

The rotating power supply is located at the rear of the chassis. It is held in place by a bracket – no screws are used.



WARNING! Voltage is always present on the system board when the computer is plugged into an active AC outlet. To avoid possible personal injury and damage to the equipment the power cord should be disconnected from the computer and/or the AC outlet before opening the computer.

The power supply is secured to the rear of the computer with four Torx screws. On the inside of the computer, a tab secures the power supply to the base pan.

1. Prepare the computer for disassembly ([Preparation for Disassembly on page 104](#)).
2. Remove the access panel ([Access Panel on page 105](#)).
3. Rotate the drive cage up and disconnect the power cables from all of the drives.
4. Disconnect the power cables from the system board as follows:
 - white 24-pin labeled P1 from ATX_POWER system board connector
 - white 4-pin labeled P2 from ATX_CPU system board connector

5. From the rear of the computer, remove the four screws that secure the power supply to the computer.



6. On the inside of the computer, press the tab at the front of the power supply (1), pull the power supply forward, slide it back and toward the side of the computer so it can sit lower on the bottom of the computer, and then rotate it and lift it out of the computer (2).

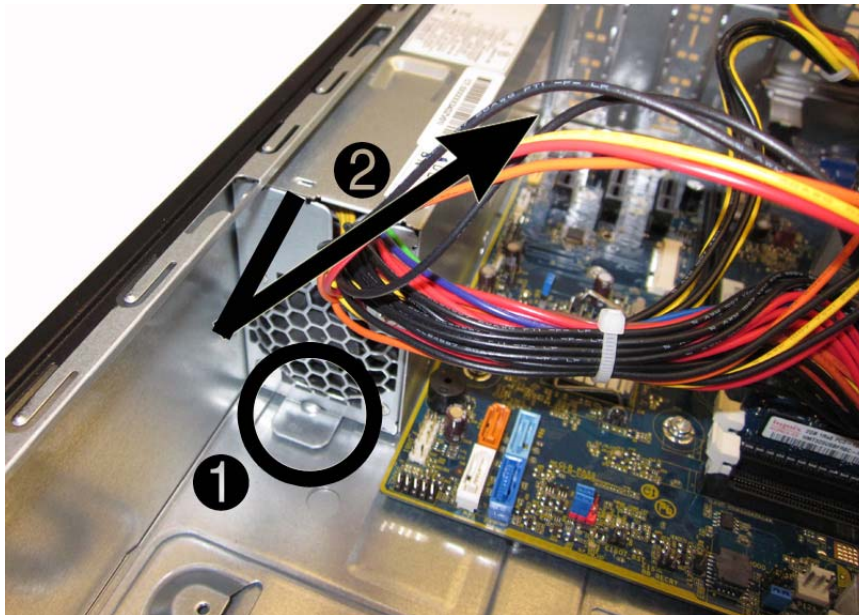

To install the power supply, reverse the removal procedure.

CAUTION: When installing the power supply cables, make sure they are properly positioned so they are not cut by the drive cage and are not pinched by the rotating power supply.

System Board

Description	Spare part number
System board for use in models with 65W processors (includes thermal material)	656598-001
System board for use in models with 95W processors (includes thermal material)	660281-001
System board for use in Brazil (includes thermal material)	665223-001

The system board is secured to the computer with six screws.

1. Prepare the computer for disassembly ([Preparation for Disassembly on page 104](#)).
2. Remove the access panel ([Access Panel on page 105](#)).
3. When replacing the system board, make sure the following components are removed from the defective system board and installed on the replacement system board:
 - Memory modules (see [Memory on page 108](#))
 - Expansion cards ([Expansion Card on page 113](#))
 - Heat sink ([Fan Sink on page 134](#))
 - Processor ([Processor on page 136](#))
4. Remove the fan from the chassis ([Fan Assembly on page 132](#)).
5. Rotate the drive cage to its upright position.
6. Rotate the power supply to its full upright position.
7. Disconnect all data and power cables from the system board.
8. Disconnect the balance of the cables from the system board.

9. Remove the six screws that secure the system board to the chassis.

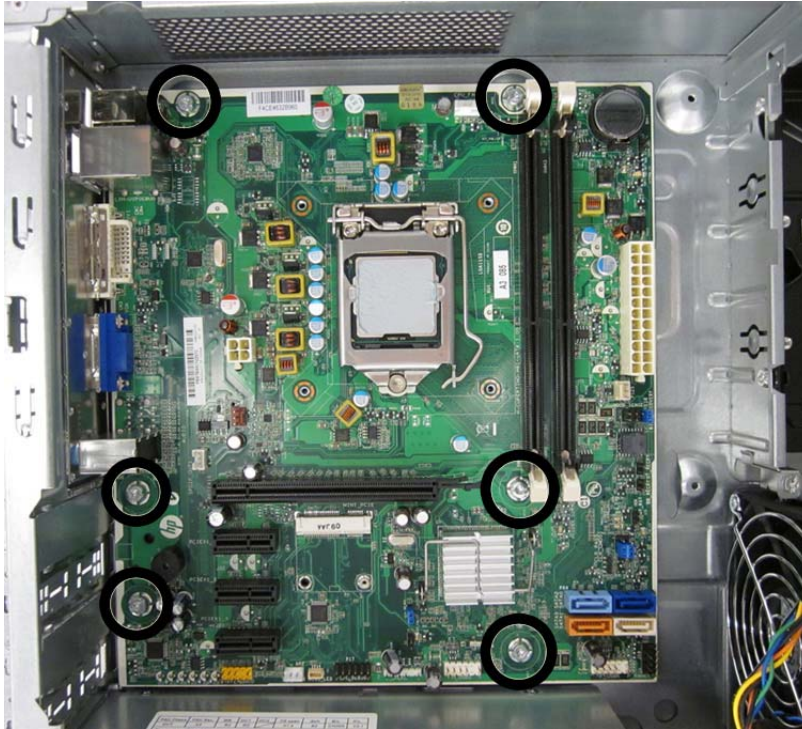

10. Slide the system board away from the rear of the computer to disengage the ports, and then lift the board up and out of the chassis.



To install the system board, reverse the removal procedure.

 **NOTE:** When replacing the system board, you must also change the chassis serial number in the BIOS.

 **CAUTION:** Before reinstalling the heat sink you must clean the top of the processor and the bottom of the heat sink with an alcohol pad supplied in the spares kit. After the alcohol has evaporated, apply thermal grease to the top of the processor from the syringe supplied in the spares kit.

CAUTION: When reconnecting the cables it is important that they be positioned so they do not interfere with the rotation of the drive cage or power supply.

Battery

The battery that comes with your computer provides power to the real-time clock and has a lifetime of about three years. When replacing the battery, use a battery equivalent to the battery originally installed on the computer. The computer comes with a 3-volt lithium coin cell battery.

 **NOTE:** The lifetime of the lithium battery can be extended by plugging the computer into a live AC wall socket. The lithium battery is only used when the computer is NOT connected to AC power.

 **WARNING!** This computer contains an internal lithium manganese dioxide battery. There is a risk of fire and burns if the battery is not handled properly. To reduce the risk of personal injury:

- Do not attempt to recharge the battery.
- Do not expose to temperatures higher than 60°C (140°F)
- Do not disassemble, crush, puncture, short external contacts, or dispose of in fire or water.
- Replace the battery only with the HP/Compaq spare designated for this product.

 **CAUTION:** Before replacing the battery, it is important to back up the computer CMOS settings. When the battery is removed or replaced, the CMOS settings will be cleared. Refer to the [Troubleshooting Without Diagnostics on page 144](#) chapter for information on backing up the CMOS settings.

 **NOTE:** Batteries, battery packs, and accumulators should not be disposed of together with the general household waste. In order to forward them to recycling or proper disposal, please use the public collection system or return them to HP, its authorized partners, or its agents.

 **CAUTION:** Static electricity can damage the electronic components of the computer or optional equipment. Before beginning these procedures, ensure that you are discharged of static electricity by briefly touching a grounded metal object.

1. Prepare the computer for disassembly ([Preparation for Disassembly on page 50](#)).
2. Remove the access panel ([Access Panel on page 51](#)).

 **NOTE:** It may be necessary to remove an expansion card to gain access to the battery.

3. Locate the battery and battery holder on the system board.
4. To release the battery from its holder, squeeze the metal clamp that extends above one edge of the battery. When the battery pops up, lift it out (1).

5. To insert the new battery, slide one edge of the replacement battery under the holder's lip with the positive side up (2). Push the other edge down until the clamp snaps over the other edge of the battery.

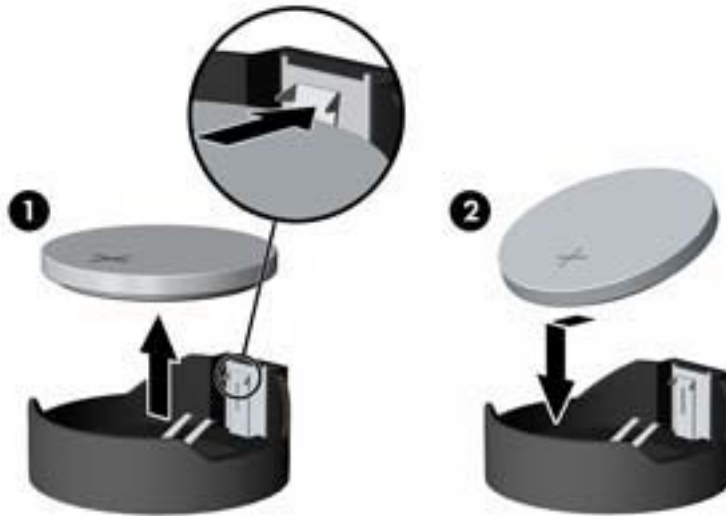

6. Replace the computer access panel.
7. Plug in the computer and turn on power to the computer.
8. Reset the date and time, your passwords, and any special system setups, using Computer Setup. Refer to [Computer Setup \(F10\) Utility on page 7](#).

A Troubleshooting Without Diagnostics

This chapter provides information on how to identify and correct minor problems, such as USB devices, hard drive, optical drive, graphics, audio, memory, and software problems. If you encounter problems with the computer, refer to the tables in this chapter for probable causes and recommended solutions.

 **NOTE:** For information on specific error messages that may appear on the screen during Power-On Self-Test (POST) at startup, refer to Appendix A, [POST Error Messages on page 198](#).

Safety and Comfort

 **WARNING!** Misuse of the computer or failure to establish a safe and comfortable work environment may result in discomfort or serious injury. Refer to the *Safety & Comfort Guide* at <http://www.hp.com/ergo> for more information on choosing a workspace and creating a safe and comfortable work environment. For more information, refer to the *Safety & Regulatory Information* guide.

Before You Call for Technical Support

If you are having problems with the computer, try the appropriate solutions below to try to isolate the exact problem before calling for technical support.

- Run the HP diagnostic tool.
- Run the hard drive self-test in Computer Setup. Refer to [Computer Setup \(F10\) Utility on page 7](#) for more information.
- Check the Power LED on the front of the computer to see if it is flashing red. The flashing lights are error codes that will help you diagnose the problem. Refer to Appendix A, [POST Error Messages on page 198](#) for more information.
- If the screen is blank, plug the monitor into a different video port on the computer if one is available. Or, replace the monitor with a monitor that you know is functioning properly.
- If you are working on a network, plug another computer with a different cable into the network connection. There may be a problem with the network plug or cable.
- If you recently added new hardware, remove the hardware and see if the computer functions properly.
- If you recently installed new software, uninstall the software and see if the computer functions properly.
- Boot the computer to the Safe Mode to see if it will boot without all of the drivers loaded. When booting the operating system, use “Last Known Configuration.”

- Refer to the comprehensive online technical support at <http://www.hp.com/support>.
- Refer to [Helpful Hints on page 145](#) in this guide.

To assist you in resolving problems online, HP Instant Support Professional Edition provides you with self-solve diagnostics. If you need to contact HP support, use HP Instant Support Professional Edition's online chat feature. Access HP Instant Support Professional Edition at: <http://www.hp.com/go/ispe>.

Access the Business Support Center (BSC) at <http://www.hp.com/go/bizsupport> for the latest online support information, software and drivers, proactive notification, and worldwide community of peers and HP experts.

If it becomes necessary to call for technical assistance, be prepared to do the following to ensure that your service call is handled properly:

- Be in front of your computer when you call.
- Write down the computer serial number, product ID number, and monitor serial number before calling.
- Spend time troubleshooting the problem with the service technician.
- Remove any hardware that was recently added to your system.
- Remove any software that was recently installed.
- Restore the system from the Recovery Disc Set that you created or restore the system to its original factory condition in System Software Requirement Disks (SSRD).

 **CAUTION:** Restoring the system will erase all data on the hard drive. Be sure to back up all data files before running the restore process.

 **NOTE:** For sales information and warranty upgrades (Care Packs), call your local authorized service provider or dealer.

Helpful Hints

If you encounter problems with the computer, monitor, or software, see the following list of general suggestions before taking further action:

- Check that the computer and monitor are plugged into a working electrical outlet.
- Check that the voltage select switch (some models) is set to the appropriate voltage for your region (115V or 230V).
- Check that the computer is turned on and the green power light is on.
- Check that the monitor is turned on and the green monitor light is on.
- Check the Power LED on the front of the computer to see if it is flashing red. The flashing lights are error codes that will help you diagnose the problem. Refer to Appendix A, [POST Error Messages on page 198](#) for more information.
- Turn up the brightness and contrast controls of the monitor if the monitor is dim.
- Press and hold any key. If the system beeps, then the keyboard should be operating correctly.
- Check all cable connections for loose connections or incorrect connections.

- Wake the computer by pressing any key on the keyboard or pressing the power button. If the system remains in suspend mode, shut down the computer by pressing and holding the power button for at least four seconds then press the power button again to restart the computer. If the system will not shut down, unplug the power cord, wait a few seconds, then plug it in again. The computer will restart if it is set to power on automatically as soon as power is restored in Computer Setup. If it does not restart, press the power button to start the computer.
- Reconfigure the computer after installing a non-plug and play expansion board or other option. See [Solving Hardware Installation Problems on page 169](#) for instructions.
- Be sure that all the needed device drivers have been installed. For example, if you are using a printer, you need a driver for that model printer.
- Remove all bootable media (CD/DVD or USB device) from the system before turning it on.
- If you have installed an operating system other than the factory-installed operating system, check to be sure that it is supported on the system.
- If the system has multiple video sources (embedded, PCI, or PCI-Express adapters) installed (embedded video on some models only) and a single monitor, the monitor must be plugged into the monitor connector on the source selected as the primary VGA adapter. During boot, the other monitor connectors are disabled and if the monitor is connected into these ports, the monitor will not function. You can select which source will be the default VGA source in Computer Setup.

 **CAUTION:** When the computer is plugged into an AC power source, there is always voltage applied to the system board. You must disconnect the power cord from the power source before opening the computer to prevent system board or component damage.

Solving General Problems

You may be able to easily resolve the general problems described in this section. If a problem persists and you are unable to resolve it yourself or if you feel uncomfortable about performing the operation, contact an authorized dealer or reseller.

⚠ WARNING! When the computer is plugged into an AC power source, voltage is always applied to the system board. To reduce the risk of personal injury from electrical shock and/or hot surfaces, be sure to disconnect the power cord from the wall outlet and allow the internal system components to cool before touching.

Table A-1 Solving General Problems

Computer appears locked up and will not turn off when the power button is pressed.	
Cause	Solution
Software control of the power switch is not functional.	<ol style="list-style-type: none">1. Press and hold the power button for at least four seconds until the computer turns off.2. Disconnect the power cord from the electrical outlet.
Computer will not respond to keyboard or mouse.	
Cause	Solution
Computer is in Sleep state.	To resume from Sleep state, press the power button. CAUTION: When attempting to resume from Sleep state, do not hold down the power button for more than four seconds. Otherwise, the computer will shut down and you will lose any unsaved data.
System has locked up.	Restart computer.
Computer date and time display is incorrect.	
Cause	Solution
RTC (real-time clock) battery may need to be replaced. NOTE: Connecting the computer to a live AC outlet prolongs the life of the RTC battery.	Reset the date and time under Control Panel (Computer Setup can also be used to update the RTC date and time). If the problem persists, replace the RTC battery. See the Removal and Replacement section for instructions on installing a new battery, or contact an authorized dealer or reseller for RTC battery replacement. To access Control Panel in Windows 7, select Start , and then select Control Panel . To access Control Panel in Windows 8, from the Start screen, type c , and then select Control Panel from the list of applications.

Cursor will not move using the [arrow](#) keys on the keypad.

Cause	Solution
The Num Lock key is turned on.	Press the Num Lock key. The Num Lock light must be off if you want to use the arrow keys on the keypad. You can also disable or enable the Num Lock key in Computer Setup at Advanced > Device Options .

There is no sound or sound volume is too low.

Cause	Solution
System volume may be set low or muted.	<ol style="list-style-type: none">1. Check the Computer Setup settings to make sure the internal system speaker is not muted (this setting does not affect the external speakers).2. Make sure the external speakers are properly connected and powered on and that the speakers' volume control is set correctly.3. Use the system volume control available in the operating system to make sure the speakers are not muted or to increase the volume.

Cannot remove computer cover or access panel.

Cause	Solution
Smart Cover Lock, featured on some computers, is locked.	Unlock the Smart Cover Lock using Computer Setup. In case of forgotten password, power loss, or computer malfunction, you must manually disable the Smart Cover lock . A key to unlock the Smart Cover Lock is not available from HP. Keys are typically available from a hardware store.

Poor performance.

Cause	Solution
Processor is too hot.	<ol style="list-style-type: none">1. Make sure airflow to the computer is not blocked. Leave a 10.2-cm (4-inch) clearance on all vented sides of the computer and above the monitor to permit the required airflow.2. Make sure fans are connected and working properly (some fans only operate when needed).3. Make sure the processor heat sink is installed properly.
Hard drive is full.	Transfer data from the hard drive to create more space on the hard drive.
Low on memory.	Add more memory.
Hard drive fragmented.	Defragment hard drive.
Program previously accessed did not release reserved memory back to the system.	Restart the computer.

Table A-1 Solving General Problems (continued)

Cause	Solution
Poor performance.	
Virus resident on the hard drive.	Run virus protection program.
Too many applications running.	Windows 7: <ol style="list-style-type: none"><li data-bbox="879 411 1417 432">1. Close unnecessary applications to free up memory.<li data-bbox="879 464 1110 485">2. Add more memory.<li data-bbox="879 516 1445 611">3. Some applications run in the background and can be closed by right-clicking on their corresponding icons in the task tray. To prevent these applications from launching at startup: In Windows 7: <ol style="list-style-type: none"><li data-bbox="927 684 1461 705">a. Go to Start > All Programs > Accessories > Run<li data-bbox="927 737 1350 758">b. Type <code>msconfig</code>, and then press Enter.<li data-bbox="927 789 1430 863">c. On the Startup tab of the System Configuration Utility, clear applications that you do not want to launch automatically, and the click OK. In Windows 8: <ol style="list-style-type: none"><li data-bbox="927 947 1461 989">a. On the Start screen, right-click, and then select the All apps icon.<li data-bbox="927 1020 1326 1041">b. Under Windows System, click Run.<li data-bbox="927 1073 1350 1094">c. Type <code>msconfig</code>, and then press Enter.<li data-bbox="927 1125 1430 1199">d. On the Startup tab of the System Configuration Utility, clear applications that you do not want to launch automatically, and the click OK.
Some software applications, especially games, are stressful on the graphics subsystem.	<ol style="list-style-type: none"><li data-bbox="879 1230 1461 1325">1. Lower the display resolution for the current application or consult the documentation that came with the application for suggestions on how to improve performance by adjusting parameters in the application.<li data-bbox="879 1356 1110 1377">2. Add more memory.<li data-bbox="879 1409 1222 1430">3. Upgrade the graphics solution.
Cause unknown.	Restart the computer.

Computer powered off automatically and the Power LED flashes Red two times, once every second, followed by a two second pause, and the computer beeps two times. (Beeps stop after fifth iteration but LEDs continue flashing).

Cause	Solution
Processor thermal protection activated: A fan may be blocked or not turning. OR The heat sink is not properly attached to the processor.	<ol style="list-style-type: none">1. Ensure that the computer air vents are not blocked and the processor cooling fan is running.2. Open the access panel, press the power button, and see if the processor fan (or other system fan) spins. If the fan does not spin, make sure the fan cable is plugged onto the system board header.3. If fan a plugged in and not spinning, replace it.

System does not power on and the LEDs on the front of the computer are not flashing.

Cause	Solution
System unable to power on.	<p>Press and hold the power button for less than 4 seconds. If the hard drive LED turns green, then:</p> <ol style="list-style-type: none">1. If equipped with a voltage selector, check that the voltage selector (located on the rear of the power supply) is set to the appropriate voltage. Proper voltage setting depends on your region.2. Remove the expansion cards one at a time until the 5V_aux light on the system board turns on.3. Replace the system board. <p>OR</p> <p>Press and hold the power button for less than 4 seconds. If the hard drive LED does not turn on green then:</p> <ol style="list-style-type: none">1. Check that the unit is plugged into a working AC outlet.2. Open the access panel and check that the power button cable is properly connected to the system board.3. Check that the power supply cables are properly connected to the system board.4. Check to see if the 5V_aux light on the system board is turned on. If it is turned on, then replace the power button assembly.5. If the 5V_aux light on the system board is off, then replace the power supply.6. Replace the system board.

Solving Power Problems

Common causes and solutions for power problems are listed in the following table.

Table A-2 Solving Power Problems

Power supply shuts down intermittently.

Cause	Solution
If equipped with a voltage selector, voltage selector switch on rear of computer chassis (some models) not switched to correct line voltage (115V or 230V).	Select the proper AC voltage using the selector switch.
Power supply will not turn on because of internal power supply fault.	Replace the power supply.

Computer powered off automatically and the Power LED flashes Red two times, once every second, followed by a two second pause, and the computer beeps two times. (Beeps stop after fifth iteration but LEDs continue flashing.)

Cause	Solution
Processor thermal protection activated: A fan may be blocked or not turning. OR The heat sink is not properly attached to the processor.	<ol style="list-style-type: none">1. Ensure that the computer air vents are not blocked and the processor cooling fan is running.2. Open the access panel, press the power button, and see if the processor fan (or other system fan) spins. If the fan does not spin, make sure the fan cable is plugged onto the system board header.3. If fan a plugged in and not spinning, replace it.

Power LED flashes Red four times, once every second, followed by a two second pause, and the computer beeps four times. (Beeps stop after fifth iteration but LEDs continue flashing.)

Cause	Solution
Power failure (power supply is overloaded).	<ol style="list-style-type: none"><li data-bbox="853 300 1450 415">1. If equipped with a voltage selector, check that the voltage selector, located on the rear of the power supply (some models), is set to the appropriate voltage. Proper voltage setting depends on your region.<li data-bbox="853 426 1450 489">2. Open the access panel and ensure the power supply cable is seated into the connector on the system board.<li data-bbox="853 499 1450 730">3. Check if a device is causing the problem by removing ALL attached devices (such as hard drives or optical drives and expansion cards). Power on the system. If the system enters POST, then power off and replace one device at a time and repeat this procedure until failure occurs. Replace the device that is causing the failure. Continue adding devices one at a time to ensure all devices are functioning properly.<li data-bbox="853 741 1450 783">4. Replace the power supply.<li data-bbox="853 793 1450 835">5. Replace the system board.
The incorrect external power supply adapter is being used on the All-in One or USDT.	The power supply adapter must be at the correct power rating and use the Smart ID technology before the system will power up. Replace the power supply adapter with the HP-supplied power supply adapter.

Solving Hard Drive Problems

Table A-3 Solving Hard Drive Problems

Hard drive error occurs.	
Cause	Solution
Hard disk has bad sectors or has failed.	<ol style="list-style-type: none">1. In Windows 7, click Start, click Computer, and right-click on a drive. Select Properties, and then select the Tools tab. Under Error-checking click Check Now. In Windows 8, on the Start screen type e, and then select File Explorer from the list of applications. In the left column, expand Computer, right-click on a drive, select Properties, and then select the Tools tab. Under Error checking click Check.2. Use a utility to locate and block usage of bad sectors. If necessary, reformat the hard disk.
Disk transaction problem.	
Cause	Solution
Either the directory structure is bad or there is a problem with a file.	<p>In Windows 7, click Start, expand Computer, and right-click on a drive. Select Properties, and then select the Tools tab. Under Error-checking click Check Now.</p> <p>In Windows 8, on the Start screen type e, and then click File Explorer from the list of applications. In the left column, expand Computer, right-click on a drive, select Properties, and then select the Tools tab. Under Error checking click Check.</p>
Drive not found (identified).	
Cause	Solution
Cable could be loose.	Check cable connections.
The system may not have automatically recognized a newly installed device.	<p>See reconfiguration directions in the Solving Hardware Installation Problems on page 169 section. If the system still does not recognize the new device, check to see if the device is listed within Computer Setup. If it is listed, the probable cause is a driver problem. If it is not listed, the probable cause is a hardware problem.</p> <p>If this is a newly installed drive, run the Computer Setup utility and try adding a POST delay under Advanced > Power-On Options.</p>
The device is attached to a SATA port that has been hidden in Computer Setup.	Run the Computer Setup utility and ensure Device Available is selected for the device's SATA port in Security > Device Security .
Drive responds slowly immediately after power-up.	Run Computer Setup and increase the POST Delay in Advanced > Power-On Options .

Nonsystem disk/NTLDR missing message.

Cause	Solution
The system is trying to start from the hard drive but the hard drive may have been damaged.	<ol style="list-style-type: none">1. Perform Drive Protection System (DPS) testing in system ROM.
System files missing or not properly installed.	<ol style="list-style-type: none">1. Insert bootable media and restart the computer.2. Boot to the windows installation media and select the recovery option. If only a restore kit is available, then select the File Backup Program option, and then restore the system.3. Install system files for the appropriate operating system.
Hard drive boot has been disabled in Computer Setup.	Run the Computer Setup utility and enable the hard drive entry in the Storage > Boot Order list.
Bootable hard drive is not attached as first in a multi-hard drive configuration.	If attempting to boot from a hard drive, ensure it is attached to the system board dark blue SATA connector.
Bootable hard drive is not listed first in the Boot Order.	Run the Computer Setup utility and select Storage > Boot Order and ensure the bootable hard drive is listed immediately under the Hard Drive entry.

Computer will not boot from hard drive.

Cause	Solution
The device is attached to a SATA port that has been hidden in Computer Setup.	<ol style="list-style-type: none">1. Check SATA cable connections.2. Run the Computer Setup utility and ensure Device Available is selected for the device's SATA port in Security > Device Security.
Boot order is not correct.	Run the Computer Setup utility and change boot sequence in Storage > Boot Order .
Hard Drive's "Emulation Type" is set to "None." (some models)	Run the Computer Setup utility and change the "Emulation Type" to "Hard Disk" in the device's details under Storage > Device Configuration .
Hard drive is damaged.	Observe if the front panel Power LED is blinking RED and if any beeps are heard. See Appendix A, POST Error Messages on page 198 to determine possible causes for the blinking red and beep codes. See the Worldwide Limited Warranty for terms and conditions.

Computer seems to be locked up.

Cause	Solution
Program in use has stopped responding to commands.	<ol style="list-style-type: none"><li data-bbox="879 279 1426 327">1. Use the task manager to close programs that do not respond.<li data-bbox="879 359 1458 457">2. Attempt the normal Windows "Shut Down" procedure. If this fails, press the power button for four or more seconds to turn off the power. To restart the computer, press the power button again.

Solving Media Card Reader Problems

Table A-4 Solving Media Card Reader Problems

Media card will not work in a digital camera after formatting it in Windows.

Cause	Solution
By default, Windows will format any media card with a capacity greater than 32MB with the FAT32 format. Some digital cameras use the FAT (FAT16 & FAT12) format and can not operate with a FAT32 formatted card.	Either format the media card in the digital camera or select FAT file system to format the media card in a computer with Windows.

A write-protected or locked error occurs when attempting to write to the media card.

Cause	Solution
Media card is locked. Locking the media card is a safety feature that prevents writing to and deleting from an SD/Memory Stick/PRO card.	If using an SD card, make sure that the lock tab located on the right of the SD card is not in the locked position. If using a Memory Stick/PRO card, make sure that the lock tab located on the bottom of the Memory Stick/PRO card is not in the locked position.

Can not write to the media card.

Cause	Solution
The media card is a read-only memory (ROM) card.	Check the manufacturer's documentation included with your card to see if it is writable. Refer to the previous section for a list of compatible cards.
Media card is locked. Locking the media card is a safety feature that prevents writing to and deleting from an SD/Memory Stick/PRO card.	If using an SD card, make sure that the lock tab located on the right of the SD card is not in the locked position. If using a Memory Stick/PRO card, make sure that the lock tab located on the bottom of the Memory Stick/PRO card is not in the locked position.

Unable to access data on the media card after inserting it into a slot.

Cause	Solution
The media card is not inserted properly, is inserted in the wrong slot, or is not supported.	Ensure that the card is inserted properly with the gold contact on the correct side. The green LED will light if inserted properly.

Do not know how to remove a media card correctly.

Cause	Solution
The computer's software is used to safely eject the card.	<p>In Windows 7, click Start, select Computer, right-click on the corresponding drive icon, and then select Eject. Pull the card out of the slot.</p> <p>In Windows 8, on the Start screen, type e, and then click File Explorer from the list of applications. Expand Computer, right-click on the corresponding drive icon, and then select Eject. Pull the card out of the slot.</p> <p>NOTE: Never remove the card when the green LED is flashing</p>

After installing the media card reader and booting to Windows, the reader and the inserted cards are not recognized by the computer.

Cause	Solution
The operating system needs time to recognize the device if the reader was just installed into the computer and you are turning the PC on for the first time.	Wait a few seconds so that the operating system can recognize the reader and the available ports, and then recognize the media inserted in the reader.

After inserting a media card in the reader, the computer attempts to boot from the media card.

Cause	Solution
The inserted media card has boot capability.	<ol style="list-style-type: none">1. If you do not want to boot from the media card, remove it during boot or do not select the option to boot from the inserted media card during the boot process.2. During POST (Power On Self-Test), press F9 to modify the boot menu.3. Change the boot sequence in F10 Computer Setup.

Solving Display Problems

If you encounter display problems, see the documentation that came with the monitor and to the common causes and solutions listed in the following table.

Table A-5 Solving Display Problems

Blank screen (no video).	
Cause	Solution
Monitor is not turned on and the monitor light is not on.	Turn on the monitor and check that the monitor light is on.
Bad monitor.	Try a different monitor.
The cable connections are not correct.	Check the cable connection from the monitor to the computer and to the electrical outlet.
You may have a screen blanking utility installed or energy saver features are enabled.	Press any key or click the mouse button and type your password (if set).
System ROM is corrupted; system is running in Boot Block Emergency Recovery Mode (indicated by eight beeps).	Reflash the system ROM with the latest BIOS image.
You are using a fixed-sync monitor and it will not sync at the resolution chosen.	Be sure that the monitor can accept the same horizontal scan rate as the resolution chosen.
Computer is in Sleep state.	Press the power button to resume from Sleep state. CAUTION: When attempting to resume from Sleep state, do not hold down the power button for more than four seconds. Otherwise, the computer will shut down and you will lose any unsaved data.
Monitor cable is plugged into the wrong connector.	Systems may have a monitor connection on both the motherboard or an add-in card. Try moving the monitor connection to a different connector on the back of the computer
Monitor settings in the computer are not compatible with the monitor.	<ol style="list-style-type: none">1. In Control Panel, select Category from the View by list, then under Appearance and Personalization, select Adjust screen resolution. To access Control Panel in Windows 7, click Start, and then select Control Panel. To access Control Panel in Windows 8, from the Start screen, type c, and then select Control Panel from the list of applications.2. Expand the Resolution box, and then use the sliding control to reset the resolution.
Monitor is configured to use an input that is not active.	Use the monitor's on-screen menu controls to select the input that is being driven by the system. Refer to the monitor's user documentation for more information on the on-screen controls and settings.

Blank screen and the power LED flashes Red five times, once every second, followed by a two second pause, and the computer beeps five times. (Beeps stop after fifth iteration but LEDs continue flashing.)

Cause	Solution
Pre-video memory error.	<ol style="list-style-type: none">1. Reseat DIMMs. Power on the system.2. Replace DIMMs one at a time to isolate the faulty module.3. Replace third-party memory with HP memory.4. Replace the system board.

Blank screen and the power LED flashes Red six times, once every second, followed by a two second pause, and the computer beeps six times. (Beeps stop after fifth iteration but LEDs continue flashing.)

Cause	Solution
Pre-video graphics error.	<p>For systems with a graphics card:</p> <ol style="list-style-type: none">1. Reseat the graphics card (if applicable). Power on the system.2. Replace the graphics card (if applicable).3. Replace the system board. <p>For systems with integrated graphics, replace the system board.</p>

Blank screen and the power LED flashes Red seven times, once every second, followed by a two second pause, and the computer beeps seven times. (Beeps stop after fifth iteration but LEDs continue flashing.)

Cause	Solution
System board failure (ROM detected failure prior to video).	Replace the system board.

Monitor does not function properly when used with energy saver features.

Cause	Solution
Monitor without energy saver capabilities is being used with energy saver features enabled.	Disable monitor energy saver feature.

Dim characters.

Cause	Solution
The brightness and contrast controls are not set properly.	Adjust the monitor brightness and contrast controls.
Cables are not properly connected.	Check that the graphics cable is securely connected to the graphics card (if applicable) or video connector and the monitor.

Blurry video or requested resolution cannot be set.

Cause	Solution
If the graphics controller was upgraded, the correct graphics drivers may not be loaded.	Install the video drivers included in the upgrade kit.
Monitor is not capable of displaying requested resolution.	Change requested resolution.
Graphics card is bad.	Replace the graphics card.

The picture is broken up, rolls, jitters, or flashes.

Cause	Solution
The monitor connections may be incomplete or the monitor may be incorrectly adjusted.	<ol style="list-style-type: none">1. Be sure the monitor cable is securely connected to the computer.2. In a two-monitor system or if another monitor is in close proximity, be sure the monitors are not interfering with each other's electromagnetic field by moving them apart.3. Fluorescent lights or fans may be too close to the monitor.
Monitor needs to be degaussed.	Degauss the monitor. Refer to the documentation that came with the monitor for instructions.

Image is not centered.

Cause	Solution
Position may need adjustment.	Press the monitor's Menu button to access the OSD menu. Select ImageControl/ Horizontal Position or Vertical Position to adjust the horizontal or vertical position of the image.

"No Connection, Check Signal Cable" displays on screen.

Cause	Solution
Monitor video cable is disconnected.	Connect the video cable between the monitor and computer. CAUTION: Ensure that the computer power is off while connecting the video cable.

“Out of Range” displays on screen.

Cause	Solution
Video resolution and refresh rate are set higher than what the monitor supports.	<p>Restart the computer and enter Safe Mode. Change the settings to a supported setting then restart the computer so that the new settings take effect.</p> <p>To enter Safe Mode in Windows 7:</p> <ol style="list-style-type: none">1. Restart the computer.2. Press and hold the F8 key as your computer restarts, before the Windows logo appears. If the Windows logo appears, you must restart the computer and try again.3. On the Advanced Boot Options screen, use the arrow keys to highlight the safe mode option you want, and then press Enter.4. Log on to your computer with a user account that has administrator rights. <p>When your computer is in safe mode, Safe Mode displays in the corners of your monitor. To exit safe mode, restart your computer and let Windows start normally.</p> <p>To enter Safe Mode in Windows 8:</p> <ol style="list-style-type: none">1. Press the Windows logo + I to open the Settings charm.2. Select Change PC Settings, select General, and then under Advanced startup, click Restart now.3. Select Troubleshoot, select Advanced options, select Startup Settings, and then click Restart.4. Use the function keys or number keys to select the safe mode option you want. <p>When your computer is in safe mode, Safe Mode displays in the corners of your monitor. To exit safe mode, restart your computer and let Windows start normally.</p>

High pitched noise coming from inside a flat panel monitor.

Cause	Solution
Brightness and/or contrast settings are too high.	Lower brightness and/or contrast settings.

Fuzzy focus; streaking, ghosting, or shadowing effects; horizontal scrolling lines; faint vertical bars; or unable to center the picture on the screen (flat panel monitors using an analog VGA input connection only).

Cause	Solution
Flat panel monitor's internal digital conversion circuits may be unable to correctly interpret the output synchronization of the graphics card.	<ol style="list-style-type: none">1. Select the monitor's Auto-Adjustment option in the monitor's on-screen display menu.2. Manually synchronize the Clock and Clock Phase on-screen display functions. To download a SoftPaq that will assist you with the synchronization, go to the following Web site, select the appropriate monitor, and download either SP32347 or SP32202: http://www.hp.com/support
Graphics card is not seated properly or is bad (some models).	<ol style="list-style-type: none">1. Reseat the graphics card.2. Replace the graphics card.

Certain typed symbols do not appear correct.

Cause	Solution
The font you are using does not support that particular symbol.	<p>Use the Character Map to locate and select the appropriate symbol. You can copy the symbol from the Character Map into a document.</p> <p>In Windows 7, click Start, select All Programs, select Accessories, select System Tools, and then select Character Map.</p> <p>In Windows 8, on the Start screen, type <code>ch</code>, and then select Character Map from the list of applications.</p>

Solving Audio Problems

If the computer has audio features and you encounter audio problems, see the common causes and solutions listed in the following table.

Table A-6 Solving Audio Problems

Sound cuts in and out.	
Cause	Solution
Processor resources are being used by other open applications.	Shut down all open processor-intensive applications.
Sound does not come out of the speaker or headphones.	
Cause	Solution
Software volume control is turned down or muted.	Double-click the Speaker icon on the taskbar, then make sure that Mute is not selected and use the volume slider to adjust the volume. NOTE: In Windows 8, the taskbar is available at the bottom of the Desktop screen.
Audio is hidden in Computer Setup.	Enable the audio in Computer Setup: Security > Device Security > System Audio .
The external speakers are not turned on.	Turn on the external speakers.
The audio device may be connected to the wrong jack.	Ensure that the device is connected to the correct jack on the computer. The rear audio jack output is the green receptacle. The speakers should be plugged into the line-out jack and the headphones should be plugged into the headphone jack.
External speakers plugged into the wrong audio jack on a recently installed sound card.	See the sound card documentation for proper speaker connection. The rear audio jack output is the green receptacle.
Headphones or devices connected to the line-out connector mute the internal speaker.	Turn on and use headphones or external speakers, if connected, or disconnect headphones or external speakers.
Computer is in Sleep state.	Press the power button to resume from Sleep state. CAUTION: When attempting to resume from Sleep state, do not hold down the power button for more than four seconds. Otherwise, the computer will shut down and you will lose any unsaved data.
Internal speaker is disabled in Computer Setup.	Enable the internal speaker in Computer Setup. Select Advanced > Device Options > Internal Speaker .
The application is set to use a different audio device than speakers.	Some graphics cards support audio over the DisplayPort connection (if applicable), so multiple audio devices may be listed in Device Manager. Make sure the correct device is being used. To access Device Manager in Windows 7, click Start , select Control Panel , and then select Device Manager . To access Device Manager in Windows 8, from the Start screen, type c , select Control Panel from the list of applications, and then select Device Manager .

Table A-6 Solving Audio Problems (continued)

Sound does not come out of the speaker or headphones.

Cause	Solution
Some applications can select which audio output device is used.	Make sure the application has selected the correct audio device.
The operating system controls may be set to use a different audio device as the default output device than what is expected.	Set the operating system to use the correct audio device.

Sound from headphones is not clear or muffled.

Cause	Solution
Headphones are plugged into the rear audio output connector. The rear audio output connector is for powered audio devices and is not designed for headphone use.	Plug the headphones into the headphone connector on the front of the computer.

Computer appears to be locked up while recording audio.

Cause	Solution
The hard disk may be full.	Before recording, make sure there is enough free space on the hard disk. You can also try recording the audio file in a compressed format.

Line-in jack is not functioning properly.

Cause	Solution
Jack has been reconfigured in the audio driver or application software.	In the audio driver or application software, reconfigure the jack or set the jack to its default value.

There is no sound or sound volume is too low.

Cause	Solution
The application is set to use a different audio device than speakers.	Some graphics cards support audio over the DisplayPort connection (if applicable), so multiple audio devices may be listed in Device Manager. Make sure the correct device is being used. To access Device Manager in Windows 7, click Start , select Control Panel , and then select Device Manager . To access Device Manager in Windows 8, from the Start screen, type c , select Control Panel from the list of applications, and then select Device Manager .

Table A-6 Solving Audio Problems (continued)

There is no sound or sound volume is too low.

Cause	Solution
Some applications can select which audio output device is used.	Make sure the application has selected the correct audio device.
The operating system controls may be set to use a different audio device as the default output device than what is expected.	Set the operating system to use the correct audio device.

Solving Printer Problems

If you encounter printer problems, see the documentation that came with the printer and to the common causes and solutions listed in the following table.

Table A-7 Solving Printer Problems

Printer will not print.

Cause	Solution
Printer is not turned on and online.	Turn the printer on and make sure it is online.
The correct printer drivers for the application are not installed.	<ol style="list-style-type: none">1. Install the correct printer driver for the application.2. Try printing using the MS-DOS command: <pre>DIR C:\ > [printer port]</pre>where [printer port] is the address of the printer being used. If the printer works, reload the printer driver. To run MS-DOS commands, press the Windows key + r, type cmd in the Open box, and then click OK.
If you are on a network, you may not have made the connection to the printer.	Make the proper network connections to the printer.
Printer may have failed.	Run printer self-test.

Printer will not turn on.

Cause	Solution
The cables may not be connected properly.	Reconnect all cables and check the power cord and electrical outlet.

Printer prints garbled information.

Cause	Solution
The correct printer driver for the application is not installed.	Install the correct printer driver for the application.

Table A-7 Solving Printer Problems (continued)

Printer prints garbled information.

Cause	Solution
The cables may not be connected properly.	Reconnect all cables.
Printer memory may be overloaded.	Reset the printer by turning it off for one minute, then turn it back on.

Printer will not print.

Cause	Solution
The printer may be out of paper.	Check the paper tray and refill it if it is empty.

Solving Keyboard and Mouse Problems

If you encounter keyboard or mouse problems, see the documentation that came with the equipment and to the common causes and solutions listed in the following table.

Table A-8 Solving Keyboard Problems

A wireless keyboard/mouse is not working correctly. Symptoms include lagging mouse movement, jumpy mouse/keyboard, or no function of mouse/keyboard and external drive.

Cause	Solution
If your computer is equipped with USB 3.0 ports, connected USB 3.0 devices can interfere with the wireless keyboard USB receiver.	Connect the wireless keyboard USB receiver to a USB 2.0 port that is separated from ports with USB 3.0 devices. If you still experience interference, you may have to place the connectors farther apart using an external USB hub.

Keyboard commands and typing are not recognized by the computer.

Cause	Solution
Keyboard connector is not properly connected.	Shut down the computer, reconnect the keyboard to the back of the computer, and then restart the computer.
Program in use has stopped responding to commands.	Shut down your computer using the mouse and then restart the computer.
Keyboard needs repairs.	See the Worldwide Limited Warranty for terms and conditions.
Computer is in Sleep state.	Press the power button to resume from Sleep state. CAUTION: When attempting to resume from Sleep state, do not hold down the power button for more than four seconds. Otherwise, the computer will shut down and you will lose any unsaved data.

Cursor will not move using the [arrow](#) keys on the keypad.

Cause	Solution
The Num Lock key is on.	Press the Num Lock key. The Num Lock light should be off if you want to use the arrow keys on the keypad. You can disable or enable the Num Lock key in Computer Setup at Advanced > Device Options .

Table A-9 Solving Mouse Problems

Mouse does not respond to movement or is too slow.

Cause	Solution
Mouse connector is not properly plugged into the back of the computer.	Shut down the computer using the keyboard. Windows 7: <ol style="list-style-type: none">1. Press the Ctrl and Esc keys at the same time (or press the Windows logo key) to display the Start menu.2. Use the arrow keys to select Shut Down and then press Enter.3. After the shutdown is complete, plug the mouse connector into the back of the computer (or the keyboard) and restart. Windows 8: <ol style="list-style-type: none">1. Press the Windows logo + I to open the Settings charm.2. Use the arrow keys to select Power, and then press Enter.3. Use the arrow keys to select Shut Down, and then press Enter.4. After the shutdown is complete, plug the mouse connector into the back of the computer (or the keyboard) and restart.
Program in use has stopped responding to commands.	Shut down the computer using the keyboard then restart the computer.
Mouse may need cleaning.	Remove the roller ball cover on the mouse and clean the internal components.
Mouse may need repair.	See the Worldwide Limited Warranty for terms and conditions.
Computer is in Sleep state.	Press the power button to resume from Sleep state. CAUTION: When attempting to resume from Sleep state, do not hold down the power button for more than four seconds. Otherwise, the computer will shut down and you will lose any unsaved data.

Mouse will only move vertically, horizontally, or movement is jerky.

Cause	Solution
Mouse roller ball or the rotating encoder shafts that make contact with the ball are dirty.	Remove roller ball cover from the bottom of the mouse and clean the internal components with a mouse cleaning kit available from most computer stores.

Solving Hardware Installation Problems

You may need to reconfigure the computer when you add or remove hardware, such as an additional drive or expansion card. If you install a plug and play device, Windows automatically recognizes the device and configures the computer. If you install a non-plug and play device, you must reconfigure the computer after completing installation of the new hardware. In Windows, use the **Add Hardware Wizard** and follow the instructions that appear on the screen.

To open the Add Hardware Wizard, open a Command Prompt and open hdlwiz.exe.

⚠ WARNING! When the computer is plugged into an AC power source, voltage is always applied to the system board. To reduce the risk of personal injury from electrical shock and/or hot surfaces, be sure to disconnect the power cord from the wall outlet and allow the internal system components to cool before touching.

Table A-10 Solving Hardware Installation Problems

A new device is not recognized as part of the system.

Cause	Solution
Device is not seated or connected properly.	Ensure that the device is properly and securely connected and that pins in the connector are not bent down.
Cable(s) of new external device are loose or power cables are unplugged.	Ensure that all cables are properly and securely connected and that pins in the cable or connector are not bent down.
Power switch of new external device is not turned on.	Turn off the computer, turn on the external device, then turn on the computer to integrate the device with the computer system.
When the system advised you of changes to the configuration, you did not accept them.	Reboot the computer and follow the instructions for accepting the changes.
A plug and play board may not automatically configure when added if the default configuration conflicts with other devices.	Use Windows Device Manager to deselect the automatic settings for the board and choose a basic configuration that does not cause a resource conflict. You can also use Computer Setup to reconfigure or disable devices to resolve the resource conflict. To access Device Manager in Windows 7, click Start , select Control Panel , and then select Device Manager . To access Device Manager in Windows 8, from the Start screen, type c , select Control Panel from the list of applications, and then select Device Manager .
USB ports on the computer are disabled in Computer Setup.	Run the Computer Setup utility and ensure that Device available is selected for appropriate USB ports under Security > USB Security .

Computer will not start.

Cause	Solution
Wrong memory modules were used in the upgrade or memory modules were installed in the wrong location.	<ol style="list-style-type: none">1. Review the documentation that came with the system to determine if you are using the correct memory modules and to verify the proper installation. NOTE: DIMM1 or XMM1 must always be installed. On all computers except the USDT, DIMM1 must be installed before DIMM2, and DIMM3 must be installed before DIMM4.2. Observe the beeps and LED lights on the front of the computer. Beeps and flashing LEDs are codes for specific problems.3. If you still cannot resolve the issue, contact Customer Support.

Power LED flashes Red five times, once every second, followed by a two second pause, and the computer beeps five times. (Beeps stop after fifth iteration but LEDs continue flashing.)

Cause	Solution
Memory is installed incorrectly or is bad.	<p>CAUTION: To avoid damage to the DIMMs or the system board, you must unplug the computer power cord before attempting to reseat, install, or remove a DIMM module.</p> <ol style="list-style-type: none">1. Reseat DIMMs. Power on the system.2. Replace DIMMs one at a time to isolate the faulty module. NOTE: DIMM1 or XMM1 must always be installed. On all computers except the USDT, DIMM1 must be installed before DIMM2, and DIMM3 must be installed before DIMM43. Replace third-party memory with HP memory.4. Replace the system board.

Power LED flashes Red six times, once every second, followed by a two second pause, and the computer beeps six times. (Beeps stop after fifth iteration but LEDs continue flashing.)

Cause	Solution
Graphics card (some models) is not seated properly or is bad, or system board is bad.	<p>For systems with a graphics card:</p> <ol style="list-style-type: none">1. Reseat the graphics card. Power on the system.2. Replace the graphics card.3. Replace the system board. <p>For systems with integrated graphics, replace the system board.</p>

Power LED flashes Red ten times, once every second, followed by a two second pause, and the computer beeps ten times. (Beeps stop after fifth iteration but LEDs continue flashing.)

Cause	Solution
Bad option card.	<ol style="list-style-type: none">1. Check each option card by removing the cards one at time (if multiple cards), then power on the system to see if fault goes away.2. Once bad card is identified, remove and replace bad option card.3. Replace the system board.

Solving Network Problems

Some common causes and solutions for network problems are listed in the following table. These guidelines do not discuss the process of debugging the network cabling.

Table A-11 Solving Network Problems

Wake-on-LAN feature is not functioning.

Cause	Solution
S5 Maximum Power Saving feature is enabled.	Disable the S5 Maximum Power Saving option in Computer Setup. Select Power > Hardware Power Management > S5 Maximum Power Savings .
S5 Wake on LAN is disabled (some models).	Enable the S5 Wake on LAN option in Computer Setup. Select Advanced > Device Options > S5 Wake on LAN .
Wake-on-LAN is not enabled.	<p>To enable Wake-on-LAN in Windows 7:</p> <ol style="list-style-type: none">1. Select Start > Control Panel > Network and Sharing Center.2. Under Tasks, select Manage network connections.3. Click Local Area Connection.4. Click the Properties button.5. Click the Configure button.6. Click the Power Management tab, then select Allow this device to wake the computer. <p>To enable Wake-on-LAN in Windows 8:</p> <ol style="list-style-type: none">1. From the Start screen, type c, and then select Control Panel from the list of applications.2. Select Network and Sharing Center, and then click the Ethernet link next to the connection.3. Click the Properties button.4. Click the Configure button.5. Click the Power Management tab, then enable the appropriate Wake-on LAN option.

Network driver does not detect network controller.

Cause	Solution
Network controller is disabled.	<ol style="list-style-type: none">1. Run Computer Setup and enable network controller.2. Enable the network controller in the operating system using Device Manager. To access Device Manager in Windows 7, click Start, select Control Panel, and then select Device Manager. To access Device Manager in Windows 8, from the Start screen, type c, select Control Panel from the list of applications, and then select Device Manager.
Incorrect network driver.	Check the network controller documentation for the correct driver or obtain the latest driver from the manufacturer's Web site.

Network status link light never flashes.

NOTE: The network status light is supposed to flash when there is network activity.

Cause	Solution
No active network is detected.	Check cabling and network equipment for proper connection.
Network controller is not set up properly.	Check for the device status within Windows, such as Device Manager for driver load and the Network Connections applet within Windows for link status. To access Device Manager in Windows 7, click Start , select Control Panel , and then select Device Manager . To access Device Manager in Windows 8, from the Start screen, type c , select Control Panel from the list of applications, and then select Device Manager .
Network controller is disabled.	<ol style="list-style-type: none">1. Run Computer Setup and enable network controller.2. Enable the network controller in the operating system using Device Manager. To access Device Manager in Windows 7, click Start, select Control Panel, and then select Device Manager. To access Device Manager in Windows 8, from the Start screen, type c, select Control Panel from the list of applications, and then select Device Manager.
Network driver is not properly loaded.	Reinstall network drivers.
System cannot autosense the network.	Disable auto-sensing capabilities and force the system into the correct operating mode.

Diagnostics reports a failure.

Cause	Solution
The cable is not securely connected.	Ensure that the cable is securely attached to the network connector and that the other end of the cable is securely attached to the correct device.
The cable is attached to the incorrect connector.	Ensure that the cable is attached to the correct connector.
There is a problem with the cable or a device at the other end of the cable.	Ensure that the cable and device at the other end are operating correctly.
Network controller interrupt is shared with an expansion board.	Under the Computer Setup Advanced menu, change the resource settings for the board.
The network controller is defective.	Contact an authorized service provider.

Diagnostics passes, but the computer does not communicate with the network.

Cause	Solution
Network drivers are not loaded, or driver parameters do not match current configuration.	Make sure the network drivers are loaded and that the driver parameters match the configuration of the network controller. Make sure the correct network client and protocol is installed.
The network controller is not configured for this computer.	Select the Network and Sharing Center icon in the Control Panel and configure the network controller. To access Control Panel in Windows 7, click Start , and then select Control Panel . To access Control Panel in Windows 8, from the Start screen, type c , and then select Control Panel .

Network controller stopped working when an expansion board was added to the computer.

Cause	Solution
Network controller interrupt is shared with an expansion board.	Under the Computer Setup Advanced menu, change the resource settings for the board.
The network controller requires drivers.	Verify that the drivers were not accidentally deleted when the drivers for a new expansion board were installed.
The expansion board installed is a network card (NIC) and conflicts with the embedded NIC.	Under the Computer Setup Advanced menu, change the resource settings for the board.

Network controller stops working without apparent cause.

Cause	Solution
The files containing the network drivers are corrupted.	Reinstall the network drivers using the Recovery Disc Set in Windows 7 or Windows recovery tools in Windows 8. If necessary, download the softpaq from the web (from a different computer).

Table A-11 Solving Network Problems (continued)

Network controller stops working without apparent cause.

Cause	Solution
The cable is not securely connected.	Ensure that the cable is securely attached to the network connector and that the other end of the cable is securely attached to the correct device.
The network controller is defective.	Contact an authorized service provider.

New network card will not boot.

Cause	Solution
New network card may be defective or may not meet industry-standard specifications.	Install a working, industry-standard NIC, or change the boot sequence to boot from another source.

Cannot connect to network server when attempting Remote System Installation.

Cause	Solution
The network controller is not configured properly.	Verify Network Connectivity, that a DHCP Server is present, and that the Remote System Installation Server contains the NIC drivers for your NIC.

System setup utility reports unprogrammed EEPROM.

Cause	Solution
Unprogrammed EEPROM.	Contact an authorized service provider.

Solving Memory Problems

If you encounter memory problems, some common causes and solutions are listed in the following table.

 **CAUTION:** Power may still be supplied to the DIMMs when the computer is turned off (depending on the Management Engine (ME) settings). To avoid damage to the DIMMs or the system board, you must unplug the computer power cord before attempting to reseat, install, or remove a memory module.

For those systems that support ECC memory, HP does not support mixing ECC and non-ECC memory. Otherwise, the computer will not boot the operating system.

 **NOTE:** The memory count will be affected by configurations with the Management Engine (ME) enabled. The ME uses 8MB of system memory in single channel mode or 16MB of memory in dual-channel mode to download, decompress, and execute the ME firmware for Out-of-Band (OOB), third-party data storage, and other management functions.

Table A-12 Solving Memory Problems

System will not boot or does not function properly after installing additional memory modules.

Cause	Solution
A memory module is not installed in the DIMM1 or XMM1 socket.	Ensure that a memory module is installed in the DIMM1 or XMM1 socket on the system board. This socket must be populated with a memory module.
Memory module is not the correct type or speed grade for the system or the new memory module is not seated properly.	Replace module with the correct industry-standard device for the computer. On some models, ECC and non-ECC memory modules cannot be mixed.

Out of memory error.

Cause	Solution
You have run out of memory to run the application.	Check the application documentation to determine the memory requirements.

Memory count during POST is wrong.

Cause	Solution
The memory modules may not be installed correctly.	Check that the memory modules have been installed correctly and that proper modules are used.
Integrated graphics may use system memory.	No action required.

Insufficient memory error during operation.

Cause	Solution
Too many Terminate and Stay Resident programs (TSRs) are installed.	Delete any TSRs that you do not need.
You have run out of memory for the application.	Check the memory requirements for the application or add more memory to the computer.

Power LED flashes Red five times, once every second, followed by a two second pause, and the computer beeps five times. (Beeps stop after fifth iteration but LEDs continue flashing.)

Cause	Solution
Memory is installed incorrectly or is bad.	<ol style="list-style-type: none">1. Reseat DIMMs. Power on the system.2. Replace DIMMs one at a time to isolate the faulty module.3. Replace third-party memory with HP memory.4. Replace the system board.

Solving Processor Problems

If you encounter processor problems, common causes and solutions are listed in the following table.

Table A-13 Solving Processor Problems

Poor performance is experienced.

Cause	Solution
Processor is hot.	<ol style="list-style-type: none">1. Make sure the airflow to the computer is not blocked.2. Make sure the fans are connected and working properly (some fans only operate when needed).3. Make sure the processor heat sink is installed properly.

Power LED flashes Red three times, once every second, followed by a two second pause.

Cause	Solution
Processor is not seated properly or not installed.	<ol style="list-style-type: none">1. Check to see that the processor is present.2. Reseat the processor.

Power LED flashes Red eleven times, once every second, followed by a two second pause.

Cause	Solution
The current processor does not support a feature previously enabled on this system.	<ol style="list-style-type: none">1. Install a TXT (Trusted Execution Technology) capable processor.2. Disable TXT in the Computer Setup (F10) utility.3. Reinstall the original processor.

Solving CD-ROM and DVD Problems

If you encounter CD-ROM or DVD problems, see the common causes and solutions listed in the following table or to the documentation that came with the optional device.

Table A-14 Solving CD-ROM and DVD Problems

System will not boot from CD-ROM or DVD drive.

Cause	Solution
The device is attached to a SATA port that has been hidden in the Computer Setup utility.	Run the Computer Setup utility and ensure Device Available is selected for the device's SATA port in Security > Device Security .
Removable Media Boot is disabled in the Computer Setup utility.	Run the Computer Setup utility and enable booting to removable media in Storage > Storage Options . Ensure CD-ROM is enabled in Storage > Boot Order .

Table A-14 Solving CD-ROM and DVD Problems (continued)

System will not boot from CD-ROM or DVD drive.	
Cause	Solution
Network Boot is enabled in Computer Setup.	Run the Computer Setup utility and disable Network Boot in Security > Network Boot .
Non-bootable CD in drive.	Try a bootable CD in the drive.
Boot order not correct.	Run the Computer Setup utility and change boot sequence in Storage > Boot Order .
Drive not found (identified).	
Cause	Solution
Cable could be loose.	Check cable connections.
The system may not have automatically recognized a newly installed device.	See reconfiguration directions in the Solving Hardware Installation Problems on page 169 section. If the system still does not recognize the new device, check to see if the device is listed within Computer Setup. If it is listed, the probable cause is a driver problem. If it is not listed, the probable cause is a hardware problem. If this is a newly installed drive, run the Computer Setup utility and try adding a POST delay under Advanced > Power-On Options .
The device is attached to a SATA port that has been hidden in Computer Setup.	Run the Computer Setup utility and ensure Device Available is selected for the device's SATA port in Security > Device Security .
Drive responds slowly immediately after power-up.	Run Computer Setup and increase the POST Delay in Advanced > Power-On Options .
CD-ROM or DVD devices are not detected or driver is not loaded.	
Cause	Solution
Drive is not connected properly or not properly configured.	See the documentation that came with the optional device.
Movie will not play in the DVD drive.	
Cause	Solution
Movie may be regionalized for a different country.	See the documentation that came with the DVD drive.
Decoder software is not installed.	Install decoder software.
Damaged media.	Replace media.
Movie rating locked out by parental lock.	Use DVD software to remove parental lock.
Media installed upside down.	Reinstall media.

Cannot eject compact disc (tray-load unit).

Cause	Solution
Disc not properly seated in the drive.	Turn off the computer and insert a thin metal rod into the emergency eject hole and push firmly. Slowly pull the tray out from the drive until the tray is fully extended, then remove the disc.

CD-ROM, CD-RW, DVD-ROM, or DVD-R/RW drive cannot read a disc or takes too long to start.

Cause	Solution
Media is corrupt.	Try different media to confirm whether media is valid.
Media has been inserted upside down.	Re-insert the media with the label facing up.
The DVD-ROM drive takes longer to start because it has to determine the type of media played, such as audio or video.	Wait at least 30 seconds to let the DVD-ROM drive determine the type of media being played. If the disc still does not start, read the other solutions listed for this topic.
CD or DVD disc is dirty.	Clean CD or DVD with a CD cleaning kit, available from most computer stores.
Windows does not detect the CD-ROM or DVD-ROM drive.	<ol style="list-style-type: none">1. Use Device Manager to remove or uninstall the device. To access Device Manager in Windows 7, click Start, select Control Panel, and then select Device Manager. To access Device Manager in Windows 8, from the Start screen, type c, select Control Panel from the list of applications, and then select Device Manager.2. Restart the computer and let Windows detect the CD or DVD driver.

Recording or copying CDs is difficult or impossible.

Cause	Solution
Wrong or poor quality media type.	<ol style="list-style-type: none">1. Try using a slower speed when recording.2. Verify that you are using the correct media for the drive.3. Try a different brand of media. Quality varies widely between manufacturers.

Solving USB Flash Drive Problems

If you encounter USB flash drive problems, common causes and solutions are listed in the following table.

Table A-15 Solving USB Flash Drive Problems

USB flash drive is not seen as a drive letter in Windows.	
Cause	Solution
The drive letter after the last physical drive is not available.	Change the default drive letter for the flash drive in Windows.

USB flash drive not found (identified).	
Cause	Solution
The device is attached to a USB port that has been hidden in Computer Setup.	Run the Computer Setup utility and enable USB ports in Security > USB Security .
The device was not properly seated before power-up.	Ensure the device is fully inserted into the USB port before applying power to the system

System will not boot from USB flash drive.	
Cause	Solution
Boot order is not correct.	Run the Computer Setup utility and change boot sequence in Storage > Boot Order .
Removable Media Boot is disabled in the Computer Setup utility.	Run the Computer Setup utility and enable booting to removable media in Storage > Storage Options . Ensure USB is enabled in Storage > Boot Order .

The computer boots to DOS after making a bootable flash drive.	
Cause	Solution
Flash drive is bootable.	Install the flash drive only after the operating system boots.
Flash drive is defective.	Try a different flash drive.

Solving Front Panel Component Problems

If you encounter problems with devices connected to the front panel, refer to the common causes and solutions listed in the following table.

A USB device, headphone, or microphone is not recognized by the computer.

Cause	Solution
Device is not properly connected.	<ol style="list-style-type: none">1. Turn off the computer.2. Reconnect the device to the front of the computer and restart the computer.
The device does not have power.	If the USB device requires AC power, be sure one end is connected to the device and one end is connected to a live outlet.
The correct device driver is not installed.	<ol style="list-style-type: none">1. Install the correct driver for the device.2. You might need to reboot the computer.
The cable from the device to the computer does not work.	<ol style="list-style-type: none">1. If possible, replace the cable.2. Restart the computer.
The device is not working.	<ol style="list-style-type: none">1. Replace the device.2. Restart the computer.
USB ports on the computer are disabled in Computer Setup.	Run the Computer Setup utility and ensure that the USB ports are set to Enabled in Security > USB Security .

Solving Internet Access Problems

If you encounter Internet access problems, consult your Internet Service Provider (ISP) or refer to the common causes and solutions listed in the following table.

Unable to connect to the Internet.

Cause	Solution
Internet Service Provider (ISP) account is not set up properly.	Verify Internet settings or contact your ISP for assistance.
Web browser is not set up properly.	Verify that the Web browser is installed and set up to work with your ISP.
Cable/DSL modem is not plugged in.	Plug in cable/DSL modem. You should see a "power" LED light on the front of the cable/DSL modem.
Cable/DSL service is not available or has been interrupted due to bad weather.	Try connecting to the Internet at a later time or contact your ISP. (If the cable/DSL service is connected, the "cable" LED light on the front of the cable/DSL modem will be on.)
The CAT5 UTP cable is disconnected.	Connect the CAT5 UTP cable between the cable modem and the computer's RJ-45 connector. (If the connection is good, the "PC" LED light on the front of the cable/DSL modem will be on.)

Unable to connect to the Internet.

Cause	Solution
IP address is not configured properly.	Contact your ISP for the correct IP address.
Cookies are corrupted. (A “cookie” is a small piece of information that a Web server can store temporarily with the Web browser. This is useful for having the browser remember some specific information that the Web server can later retrieve.)	Windows 7: <ol style="list-style-type: none">1. Select Start > Control Panel.2. Click Internet Options.3. In the Browsing history section on the General tab, click the Delete button.4. Select the Cookies check box and click the Delete button. Windows 8: <ol style="list-style-type: none">1. From the Start screen, type c, and then select Control Panel from the list of applications..2. Click Internet Options.3. In the Browsing history section on the General tab, click the Delete button.4. Select the Cookies check box and click the Delete button.

Cannot automatically launch Internet programs.

Cause	Solution
You must log on to your ISP before some programs will start.	Log on to your ISP and launch the desired program.

Solving Software Problems

Most software problems occur as a result of the following:

- The application was not installed or configured correctly.
- There is insufficient memory available to run the application.
- There is a conflict between applications.
- Be sure that all the needed device drivers have been installed.
- If you have installed an operating system other than the factory-installed operating system, check to be sure it is supported on the system.

If you encounter software problems, see the applicable solutions listed in the following table.

Computer will not continue and the HP logo does not display.

Cause	Solution
ROM issue - POST error has occurred.	Observe the beeps and LED lights on the front of the computer. See Appendix A, POST Error Messages on page 198 to determine possible causes. See the Worldwide Limited Warranty for terms and conditions.

Computer will not continue after HP logo screen displays.

Cause	Solution
System files may be damaged.	<p>In Windows 7, use recovery media to scan hard drive for errors, or use Windows Startup Repair to fix problems that might prevent Windows from starting correctly. Windows Startup Repair is one of the recovery tools in the System Recovery Options menu. You can also create a system repair disc that contains the System Recovery Options menu. If the problem is severe enough that Startup Repair doesn't start on its own and you can't access the System Recovery Options menu on your computer's hard disk, you can get to the menu and start Startup Repair by using the Windows installation disc or a system repair disc that you created earlier.</p> <p>In Windows 8, use Automatic Repair to fix problems that might prevent Windows from starting correctly.</p> <p>To access Automatic Repair:</p> <ol style="list-style-type: none">1. Press the Windows logo + I to open the Settings charm.2. Select Change PC Settings, select General, and then under Advanced startup, click Restart now.3. Select Troubleshoot, select Advanced options, and then select Automatic Repair. <p>Windows starts Automatic Repair.</p> <ol style="list-style-type: none">4. Select the account to use to begin Automatic Repair, and type the password for the account. <p>Windows diagnoses the computer and attempts the repair it.</p>

"Illegal Operation has Occurred" error message is displayed.

Cause	Solution
Software being used is not Microsoft-certified for your version of Windows.	Verify that the software is certified by Microsoft for your version of Windows (see program packaging for this information).
Configuration files are corrupt.	If possible, save all data, close all programs, and restart the computer.

Contacting Customer Support

For help and service, contact an authorized reseller or dealer. To locate a reseller or dealer near you, visit <http://www.hp.com>.



NOTE: If you take the computer to an authorized reseller, dealer, or service provider for service, remember to provide the setup and power-on passwords if they are set.

Refer to the number listed in the warranty or in the *Support Telephone Numbers* guide for technical assistance.

B HP PC Hardware Diagnostics

Use the UEFI-based hardware diagnostic solution that HP includes on all products to diagnose hardware issues. You can use this tool even if the computer will not boot to the operating system. This tool also works with components not diagnosed in HPSA.

Why run HP PC Hardware Diagnostics

The HP PC Hardware Diagnostic tools simplify the process of diagnosing hardware issues and expedite the support process when issues are found. The tools save time by pinpointing the component that needs to be replaced.

- **Isolate true hardware failures:** The diagnostics run outside of the operating system so they effectively isolate hardware failures from issues that may be caused by the operating system or other software components.
- **Failure ID:** When a failure is detected that requires hardware replacement, a 24-digit Failure ID is generated. This ID can then be provided to the call agent, who will either schedule support or provide replacement parts.

How to access and run HP PC Hardware Diagnostics

You can run the diagnostics from one of three places, depending on your preference and the health of the computer.

1. Turn on the computer and press **Esc** repeatedly until the BIOS Boot Menu appears.
2. Press **F2** or select **Diagnostics (F2)**.

Pressing **F2** signals the system to search for the diagnostics in the following locations:

- a. A connected USB drive (to download the diagnostics tools to a USB drive, see the instructions in [Downloading HP PC Hardware Diagnostics to a USB device on page 187](#))
- b. The hard disk drive
- c. A core set of diagnostics in the BIOS (for memory and hard disk drive) that are accessible only if the USB or hard disk drive versions are not detected

Downloading HP PC Hardware Diagnostics to a USB device

1. Go to <http://www.hp.com>.
2. Click the **Support & Drivers** link.
3. Select the **Drivers & Software** tab.
4. Enter the product name in the text box and click **Search**.
5. Select your specific computer model.
6. Select your operating system.
7. In the Diagnostic section, click the **HP UEFI Support Environment** link. This link provides additional information.

- or -

Click the **Download** button and select **Run**. The download includes instructions (in English) on how to install the tools on the USB device.



NOTE: HP diagnostic solutions are developed to test components typically included on HP products. They may not diagnose all third-party accessories that can be added to the system.

C Backup and Recovery

Restoring and recovering in Windows 7

To protect from loss or damage, back up your personal data files. Refer to the operating system or backup utility documentation for instructions on making backup copies of your data files.

To protect the software from loss or damage, keep a backup copy of all system software, applications, and related files stored on the hard drive.

If you cannot create system recovery CDs or DVDs, you can order a recovery disk set from support. To obtain the support telephone number for your region, see <http://www.hp.com/support/contactHP>.

System Restore

If you have a problem that might be due to software that you installed on your computer, use System Restore to return the computer to a previous restore point. You can also set restore points manually.

 **NOTE:** Always use this System Restore procedure before you use the System Recovery feature.

 **NOTE:** Some features might not be available on systems that are shipped without a Windows operating system.

To start System Restore:

1. Close all open programs.
2. Click the **Start** button, right-click **Computer**, and then click **Properties**.
3. Click **System protection**, **System Restore**, click **Next**, and then follow the on-screen instructions.

To add restore points manually:

1. Close all open programs.
2. Click the **Start** button, right-click **Computer**, click **Properties**, and then click **System protection**.
3. Under **Protection Settings**, select the disk for which you want to create a restore point.
4. Click **Create**, and then follow the on-screen instructions.

System Recovery

 **WARNING!** This procedure will delete all user information. To prevent loss of information, be sure to back up all user information so you can restore it after recovery.

System Recovery completely erases and reformats the hard disk drive, deleting all data files that you have created, and then reinstalls the operating system, programs, and drivers. However, you must reinstall any software that was not installed on the computer at the factory. This includes software that came on media included in the computer accessory box, and any software programs you installed after purchase.

 **NOTE:** Always use the System Restore procedure before you use the System Recovery program. See [System Restore on page 188](#).

 **NOTE:** Some features might not be available on systems that are shipped without a Windows operating system.

You must choose one of the following methods to perform a System Recovery:

- Recovery image — Run System Recovery from a recovery image stored on your hard disk drive. The recovery image is a file that contains a copy of the original factory-shipped software. To perform a System Recovery from a recovery image, see [System Recovery when Windows is responding on page 189](#) or [System Recovery when Windows is not responding on page 190](#).
- Recovery media — Run System Recovery from recovery media that you have created from files stored on your hard disk drive or purchased separately. To create recovery media, see [System recovery using recovery media on page 190](#).

System Recovery when Windows is responding

 **CAUTION:** System Recovery deletes all data and programs you created or installed. Before you begin, back up any important data to a CD or DVD or to a USB flash drive.

 **NOTE:** In some cases, you must use recovery media for this procedure. To create this media, follow the instructions in [Creating recovery media on page 191](#).

If the computer is working and Windows 7 is responding, use these steps to perform a System Recovery.

1. Turn off the computer.
2. Disconnect all peripheral devices from the computer except the monitor, keyboard, and mouse.
3. Turn on the computer.
4. When Windows has loaded, click the **Start** button, click **All Programs**, click **Security and Protection**, click **Recovery Manager**, and then click **Recovery Manager**. If prompted, click **Yes** to allow the program to continue.
5. Under **I need help immediately**, click **System Recovery**.
6. Select **Yes**, and then click **Next**. Your computer restarts.

 **NOTE:** If your system does not detect a recovery partition, it prompts you to insert recovery media that you have created. Insert the first disc or the USB flash drive, select **Yes**, and then click **Next** to restart the computer. If you are using discs, insert the next disc when prompted.

7. When the computer restarts, you will see the Recovery Manager welcome screen again. Under **I need help immediately**, click **System Recovery**. If you are prompted to back up your files, and you have not done so, select **Back up your files first (recommended)**, and then click **Next**. Otherwise, select **Recover without backing up your files**, and then click **Next**.

8. System Recovery begins. After System Recovery is complete, click **Finish** to restart the computer.
9. When Windows has loaded, shut down the computer, reconnect all peripheral devices, and then turn the computer back on.

System Recovery when Windows is not responding

 **CAUTION:** System Recovery deletes all data and programs you created or installed.

If Windows is not responding, but the computer is working, follow these steps to perform a System Recovery.

1. Turn off the computer. If necessary, press and hold the power button until the computer turns off.
2. Disconnect all peripheral devices from the computer, except the monitor, keyboard, and mouse.
3. Press the power button to turn on the computer.
4. As soon as you see the HP logo screen, repeatedly press the **F11** key on your keyboard until the *Windows is Loading Files...* message appears on the screen.
5. Under **I need help immediately**, click **System Recovery**.
6. If you are prompted to back up your files, and you have not done so, select **Back up your files first (recommended)**, and then click **Next**. Otherwise, select **Recover without backing up your files**, and then click **Next**.
7. System Recovery begins. After System Recovery is complete, click **Finish** to restart the computer.
8. When Windows has loaded, shut down the computer, reconnect all peripheral devices, and then turn the computer back on.

System recovery using recovery media

You should create a set of recovery media, either a set of DVDs or a USB flash drive, from the recovery image stored on your hard disk drive. This image contains the operating system and software program files that were originally installed on your computer at the factory. You can create only one set of recovery media for your computer, and the media can be used *only* with this computer. Store the recovery media in a safe place.

 **NOTE:** Some features might not be available on systems that are shipped without a Windows operating system.

- To create recovery discs, your computer must have a DVD writer, and you must use only high-quality blank DVD+R or DVD-R discs.

 **NOTE:** You *cannot* use DVD+RW, DVD-RW, DVD+RW DL, DVD-RW DL, DVD+R DL, or DVD-R DL discs to create recovery discs.

- You have the option of creating a recovery USB flash drive instead, using a high-quality USB drive.

- If you are creating recovery discs, be sure to use high-quality discs. It is normal for the system to reject defective discs. You will be prompted to insert a new blank disc to try again.
- The number of discs in the recovery-disc set depends on your computer model (typically 3 to 6 DVDs). The Recovery Media Creation program tells you the specific number of blank discs needed to make the set. If you are using a USB flash drive, the program will tell you the size of the drive required to store all the data (minimum of 8 GB).

 **NOTE:** The process of creating recovery media is lengthy. You can quit the process at any time. The next time you initiate the process, it resumes where it left off.

Creating recovery media

To create recovery discs:

1. Close all open programs.
2. Click the **Start** button, click **All Programs**, click **Security and Protection**, and then click **HP Recovery Media Creation**. If prompted, click **Yes** to allow the program to continue.
3. Click **Create recovery media using blank DVD(s)**, and then click **Next**.
4. Follow the on-screen instructions. Label each disc as you make it (for example, Recovery 1, Recovery 2), and then store the discs in a secure place.

To create a recovery USB flash drive:

 **NOTE:** You must use a flash drive with a capacity of at least 8 GB.

1. Close all open programs.
2. Insert the USB flash drive into a USB port on the computer.
3. Click the **Start** button, click **All Programs**, click **Security and Protection**, and then click **Recovery Media Creation**.
4. Click **Create recovery media with a USB flash drive**, and then click **Next**.
5. Select the USB flash drive from the list of media. The program will let you know how much storage is required to create the recovery drive. If the USB flash drive does not have enough storage capacity, it will appear grayed out, and you must replace it with a larger USB flash drive. Click **Next**.

 **NOTE:** Recovery Media Creation formats the flash drive, deleting any files on it.

6. Follow the on-screen instructions. When the process is complete, label the USB flash drive and store it in a secure place.

 **NOTE:** Do not use media cards for creating recovery media. The system may not be able to boot up from a media card and you may not be able to run system recovery.

Using recovery media

 **CAUTION:** System Recovery deletes all data and programs you have created or installed. Back up any important data to a CD or DVD or to a USB flash drive.

To create recovery media, see [System recovery using recovery media on page 190](#).

To perform a System Recovery using recovery media:

1. If using a set of DVDs, insert the first recovery disc into the DVD drive tray, and close the tray. If you are using a recovery USB flash drive, insert it into a USB port.
2. If the computer is not responding, press and hold the power button for approximately 5 seconds or until the computer turns off.

or

Click the **Start** button, and then click **Shut Down**.

3. Disconnect all peripheral devices from the computer except the monitor, keyboard, and mouse.
4. Press the power button to turn on the computer.
5. Press **Esc** as the computer is powering on to see the startup menu. Use the arrow keys to select the boot menu and press **Enter**. Use the arrow keys to select the location where the recovery media is inserted (USB or DVD). Press **Enter** to boot from that device.
6. If Recovery Manager asks if you want to run System Recovery from Media or Hard Drive, select **Media**. On the Welcome screen, under **I need help immediately**, click **Factory Reset**.
7. If you are prompted to back up your files, and you have not done so, select **Back up your files first (recommended)**, and then click **Next**. Otherwise, select **Recover without backing up your files**, and then click **Next**.
8. If you are prompted to insert the next recovery disc, do so.
9. When Recovery Manager is finished, remove the recovery disc or the recovery USB flash drive from the system.
10. Click **Finish** to restart the computer.

Backup and recovery in Windows 8

To protect your information, use Windows Backup and Restore to back up individual files and folders, back up your entire hard drive, create system repair media, or create system restore points. In case of system failure, you can use the backup files to restore the contents of your computer.

From the Start screen, type `restore`, click **Settings**, and then select from the list of displayed options.

 **NOTE:** For detailed instructions on various backup and restore options, perform a search for these topics in Help and Support. From the Start screen, type `h`, and then select **Help and Support**.

In case of system instability, HP recommends that you print the recovery procedures and save them for later use.

 **NOTE:** Windows includes the User Account Control feature to improve the security of your computer. You may be prompted for your permission or password for tasks such as installing software, running utilities, or changing Windows settings. Refer to Help and Support for more information. From the Start screen, type `h`, and then select **Help and Support**.

Backing up your information

Recovery after a system failure is as good as your most recent backup. You should create system repair media and your initial backup immediately after initial system setup. As you add new software and data files, you should continue to back up your system on a regular basis to maintain a reasonably current backup. The system repair media is used to start up (boot) the computer and repair the operating system in case of system instability or failure. Your initial and subsequent backups allow you to restore your data and settings if a failure occurs.

Type `backup` on the Start screen, click **Settings**, and then select **Save backup copies of your files with File History**.

You can back up your information to an optional external hard drive, or a network drive.

Note the following when backing up:

- Store personal files in the Documents library, and back it up regularly.
- Back up templates that are stored in their associated programs.
- Save customized settings that appear in a window, toolbar, or menu bar by taking a screen shot of your settings. The screen shot can be a time-saver if you have to reset your preferences.

To create a backup using Backup and Restore:

 **NOTE:** Be sure that the computer is connected to AC power before you start the backup process.

 **NOTE:** The backup process may take over an hour, depending on file size and the speed of the computer.

1. From the Start screen, type `backup`, click **Settings**, and then select from the list of displayed options.
2. Follow the on-screen instructions to set up your backup, create a system image, or create system repair media.

Performing a system recovery

In case of system failure or instability, the computer provides the following tools to recover your files:

- Windows recovery tools: You can use Windows Backup and Restore to recover information you have previously backed up. You can also use Windows Automatic Repair to fix problems that might prevent Windows from starting correctly.
- **f11** recovery tools: You can use the **f11** recovery tools to recover your original hard drive image. The image includes the Windows operating system and software programs installed at the factory.

 **NOTE:** If you are unable to boot (start up) your computer and you cannot use the system repair media you previously created, you must purchase Windows 8 operating system media to reboot the computer and repair the operating system. For additional information, see [Using Windows 8 operating system media \(purchased separately\) on page 195](#).

Using the Windows recovery tools

To recover information you previously backed up:

- ▲ From the Start screen, type **h**, and then select **Help and Support**.

To recover your information using Automatic Repair, follow these steps:

 **CAUTION:** Some Automatic Repair options will completely erase and reformat the hard drive. For additional information go to Help and Support. From the Start screen, type **h**, and then select **Help and Support**.

1. If possible, back up all personal files.
2. If possible, check for the presence of the HP Recovery partition and the Windows partition:

From the Start screen, type **e**, and then click **Windows Explorer**.

– or –

From the Start screen, type **c**, and then select **Computer**.

 **NOTE:** If the Windows partition and the HP Recovery partition are not listed, you must recover your operating system and programs using the Windows 8 operating system media and the *Driver Recovery* media (both purchased separately). For additional information, see [Using Windows 8 operating system media \(purchased separately\) on page 195](#).

3. If the Windows partition and the HP Recovery partition are listed, restart the computer after Windows has loaded, and then press and hold **Shift** while clicking **Restart**.

 **NOTE:** If the computer fails to boot to Windows after several attempts, the system will boot to the Windows Recovery Environment by default.

4. Select **Troubleshoot**, select **Advanced Options**, and then select **Automatic Repair**.
5. Follow the on-screen instructions.

 **NOTE:** For additional information on recovering information using the Windows tools, perform a search for these topics in Help and Support. From the Start screen, type **h**, and then select **Help and Support**.

Using f11 recovery tools

 **CAUTION:** Using **f11** completely erases hard drive contents and reformats the hard drive. All files that you have created and any software that you have installed on the computer are permanently removed. The **f11** recovery tool reinstalls the operating system and HP programs and drivers that were installed at the factory. Software not installed at the factory must be reinstalled.

To recover the original hard drive image using **f11**:

1. If possible, back up all personal files.
2. If possible, check for the presence of the HP Recovery partition: From the Start screen, type **C**, and then select **Computer**.

 **NOTE:** If the HP Recovery partition is not listed, you must recover your operating system and programs using the Windows 8 operating system media, and the *Driver Recovery* media (both purchased separately). For additional information, see [Using Windows 8 operating system media \(purchased separately\) on page 195](#).

3. If the HP Recovery partition is listed, restart the computer, and then press **esc** while the company logo is displayed. The computer Startup Menu displays.
4. Press **f11** to select the System Recovery option.
5. Follow the on-screen instructions.

Using Windows 8 operating system media (purchased separately)

To order Windows 8 operating system media, go to <http://www.hp.com/support>, select your country or region, and follow the on-screen instructions. You can also order the media by calling support.

 **CAUTION:** Using Windows 8 operating system media completely erases hard drive contents and reformats the hard drive. All files that you have created and any software that you have installed on the computer are permanently removed. When reformatting is complete, the recovery process helps you restore the operating system, as well as drivers, software, and utilities.

To initiate recovery using Windows 8 operating system media:

 **NOTE:** This process takes several minutes.

1. If possible, back up all personal files.
2. Restart the computer, and then follow the instructions provided with the Windows 8 operating system media to install the operating system.
3. When prompted, press any keyboard key.
4. Follow the on-screen instructions.

After the repair is completed:

1. Remove the Windows 8 operating system media, and then insert the *Driver Recovery* media.
2. Install the Hardware Enabling Drivers first, and then install Recommended Applications.

D Power Cord Set Requirements

The power supplies on some computers have external power switches. The voltage select switch feature on the computer permits it to operate from any line voltage between 100-120 or 220-240 volts AC. Power supplies on those computers that do not have external power switches are equipped with internal switches that sense the incoming voltage and automatically switch to the proper voltage.

The power cord set received with the computer meets the requirements for use in the country where you purchased the equipment.

Power cord sets for use in other countries must meet the requirements of the country where you use the computer.

General Requirements

The requirements listed below are applicable to all countries:

1. The power cord must be approved by an acceptable accredited agency responsible for evaluation in the country where the power cord set will be installed.
2. The power cord set must have a minimum current capacity of 10A (7A Japan only) and a nominal voltage rating of 125 or 250 volts AC, as required by each country's power system.
3. The diameter of the wire must be a minimum of 0.75 mm₂ or 18AWG, and the length of the cord must be between 1.8 m (6 feet) and 3.6 m (12 feet).

The power cord should be routed so that it is not likely to be walked on or pinched by items placed upon it or against it. Particular attention should be paid to the plug, electrical outlet, and the point where the cord exits from the product.

 **WARNING!** Do not operate this product with a damaged power cord set. If the power cord set is damaged in any manner, replace it immediately.

Japanese Power Cord Requirements

For use in Japan, use only the power cord received with this product.

 **CAUTION:** Do not use the power cord received with this product on any other products.

Country-Specific Requirements

Additional requirements specific to a country are shown in parentheses and explained below.

Country	Accrediting Agency	Country	Accrediting Agency
Australia (1)	EANSW	Italy (1)	IMQ
Austria (1)	OVE	Japan (3)	METI
Belgium (1)	CEBC	Norway (1)	NEMKO
Canada (2)	CSA	Sweden (1)	SEMKO
Denmark (1)	DEMKO	Switzerland (1)	SEV
Finland (1)	SETI	United Kingdom (1)	BSI
France (1)	UTE	United States (2)	UL
Germany (1)	VDE		

1. The flexible cord must be Type HO5VV-F, 3-conductor, 0.75mm² conductor size. Power cord set fittings (appliance coupler and wall plug) must bear the certification mark of the agency responsible for evaluation in the country where it will be used.
2. The flexible cord must be Type SVT or equivalent, No. 18 AWG, 3-conductor. The wall plug must be a two-pole grounding type with a NEMA 5-15P (15A, 125V) or NEMA 6-15P (15A, 250V) configuration.
3. Appliance coupler, flexible cord, and wall plug must bear a "T" mark and registration number in accordance with the Japanese Dentori Law. Flexible cord must be Type VCT or VCTF, 3-conductor, 0.75 mm² conductor size. Wall plug must be a two-pole grounding type with a Japanese Industrial Standard C8303 (7A, 125V) configuration.

E POST Error Messages

This appendix lists the error codes, error messages, and the various indicator light and audible sequences that you may encounter during Power-On Self-Test (POST) or computer restart, the probable source of the problem, and steps you can take to resolve the error condition.

POST Message Disabled suppresses most system messages during POST, such as memory count and non-error text messages. If a POST error occurs, the screen will display the error message. To manually switch to the POST Messages Enabled mode during POST, press any key (except [F10](#), [F11](#), or [F12](#)). The default mode is POST Message Disabled.

The speed at which the computer loads the operating system and the extent to which it is tested are determined by the POST mode selection.

Quick Boot is a fast startup process that does not run all of the system level tests, such as the memory test. Full Boot runs all of the ROM-based system tests and takes longer to complete.

Full Boot may also be enabled to run every 1 to 30 days on a regularly scheduled basis. To establish the schedule, reconfigure the computer to the Full Boot Every x Days mode, using Computer Setup.



NOTE: For more information on Computer Setup, see [Computer Setup \(F10\) Utility on page 7](#).

POST Numeric Codes and Text Messages

This section covers those POST errors that have numeric codes associated with them. The section also includes some text messages that may be encountered during POST.



NOTE: The computer will beep once after a POST text message is displayed on the screen.

Table E-1 Numeric Codes and Text Messages

Control panel message	Description	Recommended action
101-Option ROM Checksum Error	System ROM or expansion board option ROM checksum.	<ol style="list-style-type: none">1. Verify the correct ROM.2. Flash the ROM if needed.3. If an expansion board was recently added, remove it to see if the problem remains.4. Clear CMOS. (See Appendix B, Password Security and Resetting CMOS on page 211.)5. If the message disappears, there may be a problem with the expansion card.6. Replace the system board.
103-System Board Failure	DMA or timers.	<ol style="list-style-type: none">1. Clear CMOS. (See Appendix B, Password Security and Resetting CMOS on page 211.)2. Remove expansion boards.3. Replace the system board.
110-Out of Memory Space for Option ROMs	Recently added PCI expansion card contains an option ROM too large to download during POST.	<ol style="list-style-type: none">1. If a PCI expansion card was recently added, remove it to see if the problem remains.2. In Computer Setup, set Advanced > Device Options > NIC PXE Option ROM Download to DISABLE to prevent PXE option ROM for the internal NIC from being downloaded during POST to free more memory for an expansion card's option ROM. Internal PXE option ROM is used for booting from the NIC to a PXE server.
162-System Options Not Set	Configuration incorrect. RTC (real-time clock) battery may need to be replaced.	Run Computer Setup and check the configuration in Advanced > Onboard Devices . Reset the date and time under Control Panel . If the problem persists, replace the RTC battery. See the Removal and Replacement section for instructions on installing a new battery, or contact an authorized dealer or reseller for RTC battery replacement.

Table E-1 Numeric Codes and Text Messages (continued)

Control panel message	Description	Recommended action
163-Time & Date Not Set	Invalid time or date in configuration memory. RTC (real-time clock) battery may need to be replaced.	Reset the date and time under Control Panel (Computer Setup can also be used). If the problem persists, replace the RTC battery. See the Removal and Replacement section for instructions on installing a new battery, or contact an authorized dealer or reseller for RTC battery replacement.
163-Time & Date Not Set	CMOS jumper may not be properly installed.	Check for proper placement of the CMOS jumper if applicable.
164-MemorySize Error	Memory amount has changed since the last boot (memory added or removed).	Press the F1 key to save the memory changes.
164-MemorySize Error	Memory configuration incorrect.	<ol style="list-style-type: none"> 1. Run Computer Setup or Windows utilities. 2. Make sure the memory module(s) are installed properly. 3. If third-party memory has been added, test using HP-only memory. 4. Verify proper memory module type.
201-Memory Error	RAM failure.	<ol style="list-style-type: none"> 1. Ensure memory modules are correctly installed. 2. Verify proper memory module type. 3. Remove and replace the identified faulty memory module(s). 4. If the error persists after replacing memory modules, replace the system board.
213-Incompatible Memory Module in Memory Socket(s) X, X, ...	A memory module in memory socket identified in the error message is missing critical SPD information, or is incompatible with the chipset.	<ol style="list-style-type: none"> 1. Verify proper memory module type. 2. Try another memory socket. 3. Replace DIMM with a module conforming to the SPD standard.
214-DIMM Configuration Warning	Populated DIMM Configuration is not optimized.	Rearrange the DIMMs so that each channel has the same amount of memory.
219-ECC Memory Module Detected ECC Modules not supported on this Platform	Recently added memory module(s) support ECC memory error correction.	<ol style="list-style-type: none"> 1. If additional memory was recently added, remove it to see if the problem remains. 2. Check product documentation for memory support information.
301-Keyboard Error	Keyboard failure.	<ol style="list-style-type: none"> 1. Reconnect keyboard with computer turned off. 2. Check connector for bent or missing pins. 3. Ensure that none of the keys are depressed. 4. Replace keyboard.

Table E-1 Numeric Codes and Text Messages (continued)

Control panel message	Description	Recommended action
303-Keyboard Controller Error	I/O board keyboard controller.	<ol style="list-style-type: none">1. Reconnect keyboard with computer turned off.2. Replace the system board.
304-Keyboard or System Unit Error	Keyboard failure.	<ol style="list-style-type: none">1. Reconnect the keyboard with computer turned off.2. Ensure that none of the keys are depressed.3. Replace the keyboard.4. Replace the system board.
501-Display Adapter Failure	Graphics display controller.	<ol style="list-style-type: none">1. Reseat the graphics card (if applicable).2. Clear CMOS. (See Appendix B, Password Security and Resetting CMOS on page 211.)3. Verify monitor is attached and turned on.4. Replace the graphics card (if possible).
510-Flash Screen Image Corrupted	Flash Screen image has errors.	Reflash the system ROM with the latest BIOS image.
511-CPU, CPUA, or CPUB Fan not Detected	CPU fan is not connected or may have malfunctioned.	<ol style="list-style-type: none">1. Reseat CPU fan.2. Reseat fan cable.3. Replace CPU fan.
512-Chassis, Rear Chassis, or Front Chassis Fan not Detected	Chassis, rear chassis, or front chassis fan is not connected or may have malfunctioned.	<ol style="list-style-type: none">1. Reseat chassis, rear chassis, or front chassis fan.2. Reseat fan cable.3. Replace chassis, rear chassis, or front chassis fan.
513-Front Chassis fan not detected	Front chassis fan is not connected or may have malfunctioned.	<ol style="list-style-type: none">1. Reseat front chassis fan.2. Reseat fan cable.3. Replace front chassis fan.
514-CPU or Chassis Fan not Detected	CPU or chassis fan is not connected or may have malfunctioned.	<ol style="list-style-type: none">1. Reseat CPU or chassis fan.2. Reseat fan cable.3. Replace CPU or chassis fan.
515-Power Supply fan not detected	Power supply fan is not connected or may have malfunctioned.	<ol style="list-style-type: none">1. Reseat power supply fan.2. Reseat fan cable.3. Replace power supply fan.

Table E-1 Numeric Codes and Text Messages (continued)

Control panel message	Description	Recommended action
601-Diskette Controller Error	Diskette controller circuitry or floppy drive circuitry incorrect.	<ol style="list-style-type: none"> 1. Check and/or replace cables. 2. Clear CMOS. (See Appendix B, Password Security and Resetting CMOS on page 211.) 3. Replace diskette drive. 4. Replace the system board.
605-Diskette Drive Type Error	Mismatch in drive type.	<ol style="list-style-type: none"> 1. Disconnect any other diskette controller devices (tape drives). 2. Clear CMOS. (See Appendix B, Password Security and Resetting CMOS on page 211.)
660-Display cache is detected unreliable	Integrated graphics controller display cache is not working properly and will be disabled.	Replace system board if minimal graphics degrading is an issue.
912-Computer Cover Has Been Removed Since Last System Startup	Computer cover was removed since last system startup.	No action required.
917-Front Audio Not Connected	Front audio harness has been detached or unseated from motherboard.	Reconnect or replace front audio harness.
918-Front USB Not Connected	Front USB harness has been detached or unseated from motherboard.	Reconnect or replace front USB harness.
921-Device in PCI Express slot failed to initialize	There is an incompatibility/problem with this device and the system or PCI Express Link could not be retrained to an x1.	Try rebooting the system. If the error reoccurs, the device may not work with this system
1151-Serial Port A Address Conflict Detected	Both external and internal serial ports are assigned to COM1.	<ol style="list-style-type: none"> 1. Remove any serial port expansion cards. 2. Clear CMOS. (See Appendix B, Password Security and Resetting CMOS on page 211.) 3. Reconfigure card resources and/or run Computer Setup or Windows utilities.
1152-Serial Port B Address Conflict Detected	Both external and internal serial ports are assigned to COM2.	<ol style="list-style-type: none"> 1. Remove any serial port expansion cards. 2. Clear CMOS. (See Appendix B, Password Security and Resetting CMOS on page 211.) 3. Reconfigure card resources and/or run Computer Setup or Windows utilities.
1155-Serial Port Address Conflict Detected	Both external and internal serial ports are assigned to same IRQ.	<ol style="list-style-type: none"> 1. Remove any serial port expansion cards. 2. Clear CMOS. (See Appendix B, Password Security and Resetting CMOS on page 211.) 3. Reconfigure card resources and/or run Computer Setup or Windows utilities.

Table E-1 Numeric Codes and Text Messages (continued)

Control panel message	Description	Recommended action
1720-SMART Hard Drive Detects Imminent Failure	Hard drive is about to fail. (Some hard drives have a hard drive firmware patch that will fix an erroneous error message.)	<ol style="list-style-type: none">1. Determine if hard drive is giving correct error message. Enter Computer Setup and run the Drive Protection System test under Storage > DPS Self-test.2. Apply hard drive firmware patch if applicable. (Available at http://www.hp.com/support.)3. Back up contents and replace hard drive.
1796-SATA Cabling Error	One or more SATA devices are improperly attached. For optimal performance, the SATA 0 and SATA 1 connectors must be used before SATA 2 and SATA 3.	Ensure SATA connectors are used in ascending order. For one device, use SATA 0. For two devices, use SATA 0 and SATA 1. For three devices, use SATA 0, SATA 1, and SATA 2.
1797-SATA Drivelock is not supported in RAID mode.	Drivelock is enabled on one or more SATA hard drives, and they cannot be accessed while the system is configured for RAID mode.	Either remove the Drivelocked SATA device or disable the Drivelock feature. To disable the Drivelock feature, enter Computer Setup, change Storage > Storage Options > SATA Emulation to IDE , and select File > Save Changes and Exit . Reenter Computer Setup and select Security > Drivelock Security . For each listed Drivelock-capable SATA device, ensure Drivelock is Disabled . Lastly, change Storage > Storage Options > SATA Emulation back to RAID and select File > Save Changes and Exit .
1801-Microcode Patch Error	Processor is not supported by ROM BIOS.	<ol style="list-style-type: none">1. Upgrade BIOS to proper version.2. Change the processor.
2200-PMM Allocation Error during MEBx Download	Memory error during POST execution of the Management Engine (ME) BIOS Extensions option ROM.	<ol style="list-style-type: none">1. Reboot the computer.2. Unplug the power cord, re-seat the memory modules, and reboot the computer.3. If the memory configuration was recently changed, unplug the computer, restore the original memory configuration, and reboot the computer.4. If the error persists, replace the system board.

Table E-1 Numeric Codes and Text Messages (continued)

Control panel message	Description	Recommended action
2201-MEBx Module did not checksum correctly	Memory error during POST execution of the Management Engine (ME) BIOS Extensions option ROM.	<ol style="list-style-type: none">1. Reboot the computer.2. Unplug the power cord, re-seat the memory modules, and reboot the computer.3. If the memory configuration was recently changed, unplug the power cord, restore the original memory configuration, and reboot the computer.4. If the error persists, replace the system board.
2202-PMM Deallocation Error during MEBx cleanup	Memory error during POST execution of the Management Engine (ME) BIOS Extensions option ROM.	<ol style="list-style-type: none">1. Reboot the computer.2. Unplug the power cord, re-seat the memory modules, and reboot the computer.3. If the memory configuration was recently changed, unplug the power cord, restore the original memory configuration, and reboot the computer.4. If the error persists, replace the system board.
2203-Setup error during MEBx execution	MEBx selection or exit resulted in a setup failure.	<ol style="list-style-type: none">1. Reboot the computer.2. Unplug the power cord, re-seat the memory modules, and reboot the computer.3. If the memory configuration was recently changed, unplug the power cord, restore the original memory configuration, and reboot the computer.4. If the error persists, replace the system board.
2204-Inventory error during MEBx execution	BIOS information passed to the MEBx resulted in a failure.	<ol style="list-style-type: none">1. Reboot the computer.2. If the error persists, update to the latest BIOS version.3. If the error still persists, replace the system board.
2205-Interface error during MEBx execution	MEBx operation experienced a hardware error during communication with ME.	<ol style="list-style-type: none">1. Reboot the computer.2. If the error persists, update to the latest BIOS version.3. If the error still persists, replace the system board.

Table E-1 Numeric Codes and Text Messages (continued)

Control panel message	Description	Recommended action
2211-Memory not configured correctly for proper MEBx execution.	DIMM1 or XMM1 is not installed.	Make sure there is a memory module in the black DIMM1 socket and that it is properly seated.
2212-USB Key Provisioning failure writing to device	USB device used for USB key provisioning will not allow BIOS to update provision file properly.	<ol style="list-style-type: none">1. Try a different USB key device for provisioning.2. If the error persists, update to the latest BIOS version and ME firmware version.3. If the error still persists, replace the system board.
2217-ME Firmware Version request failure	ME firmware is not properly responding to BIOS query for version information.	<ol style="list-style-type: none">1. Reboot the computer.2. If the error persists, update to the latest BIOS version and ME firmware version.3. If the error still persists, replace the system board.
2218-ME Firmware Version should be updated	ME firmware must be updated to match current functionality contained in the system BIOS.	<ol style="list-style-type: none">1. Update to the latest ME firmware version.2. If the error persists and system BIOS has been recently updated, restore previous system BIOS version.3. If the error still persists, replace the system board.
2219-USB Key Provisioning file has invalid header identifier	Provisioning file contained on the USB key has been corrupted or is not a valid version for the current ME firmware.	<ol style="list-style-type: none">1. Recreate the provisioning file using third party management console software.2. If the error persists and system BIOS has been recently updated, restore previous system BIOS version. Otherwise, update the ME firmware version.3. If the error still persists, replace the system board.
2220-USB Key Provisioning file has mismatch version	Provisioning file contained on the USB key is not a valid version for the current ME firmware.	<ol style="list-style-type: none">1. Reboot the computer.2. If the error persists and system BIOS has been recently updated, restore previous system BIOS version. Otherwise, update the ME firmware version.3. If the error still persists, replace the system board.

Table E-1 Numeric Codes and Text Messages (continued)

Control panel message	Description	Recommended action
2230-General error during MEBx execution	Error occurred during MEBx execution which fails into the "General" grouping. Status information displayed along with the error provides further clarity into the failure. MEBx handles transference of information between the system BIOS and ME firmware.	<ol style="list-style-type: none">1. Reboot the computer.2. If the error persists, update to the latest BIOS version and ME firmware version.3. If the error still persists, replace the system board.
2231-ME error during MEBx execution	Error occurred during MEBx execution which fails into "ME" grouping.	<ol style="list-style-type: none">1. Reboot the computer.2. If the error persists, update to the latest BIOS version and ME firmware version.3. If the error still persists, replace the system board.
2232-AMT error during MEBx execution	Error occurred during MEBx execution which fails into "AMT" grouping.	<ol style="list-style-type: none">1. Reboot the computer.2. If the error persists, update to the latest BIOS version and ME firmware version.3. If the error still persists, replace the system board.
2233-HECI error during MEBx execution	Error occurred during MEBx execution which fails into "MEI or HECI" grouping.	<ol style="list-style-type: none">1. Reboot the computer.2. If the error persists, update to the latest BIOS version and ME firmware version.3. If the error still persists, replace the system board.
2239-ME image lock failure	Special system configurations with reduced ME firmware image require BIOS control of ME firmware upgrading. A failure has occurred after the ME firmware update process in which the BIOS could not relock the ME firmware region.	<ol style="list-style-type: none">1. Reboot the computer.2. If the error persists, update to the latest BIOS version and ME firmware version.3. If the error still persists, replace the system board.
2240-ME image unlock failure	Special system configurations with reduced ME firmware image require BIOS control of ME firmware upgrading. A failure has occurred prior to the ME firmware update process in which the BIOS could not unlock the ME firmware region.	<ol style="list-style-type: none">1. Reboot the computer.2. If the error persists, update to the latest BIOS version and ME firmware version.3. If the error still persists, replace the system board.
Invalid Electronic Serial Number	Electronic serial number is missing.	Enter the correct serial number in Computer Setup.

Table E-1 Numeric Codes and Text Messages (continued)

Control panel message	Description	Recommended action
Network Server Mode Active and No Keyboard Attached	Keyboard failure while Network Server Mode enabled.	<ol style="list-style-type: none"> 1. Reconnect keyboard with computer turned off. 2. Check connector for bent or missing pins. 3. Ensure that none of the keys are depressed. 4. Replace keyboard.
Parity Check 2	Parity RAM failure.	Run Computer Setup and Diagnostic utilities.

Interpreting POST Diagnostic Front Panel LEDs and Audible Codes

This section covers the front panel LED codes as well as the audible codes that may occur before or during POST that do not necessarily have an error code or text message associated with them.

 **WARNING!** When the computer is plugged into an AC power source, voltage is always applied to the system board. To reduce the risk of personal injury from electrical shock and/or hot surfaces, be sure to disconnect the power cord from the wall outlet and allow the internal system components to cool before touching.

 **NOTE:** If you see flashing LEDs on a PS/2 keyboard, look for flashing LEDs on the front panel of the computer and refer to the following table to determine the front panel LED codes.

Recommended actions in the following table are listed in the order in which they should be performed.

Not all diagnostic lights and audible codes are available on all models.

Table E-2 Diagnostic Front Panel LEDs and Audible Codes

Activity	Beeps	Possible Cause	Recommended Action
Green Power LED On.	None	Computer on.	None
Green Power LED flashes every two seconds.	None	Computer in Suspend to RAM mode (some models only) or normal Suspend mode.	None required. Press any key or move the mouse to wake the computer.

Table E-2 Diagnostic Front Panel LEDs and Audible Codes (continued)

Activity	Beeps	Possible Cause	Recommended Action
Red Power LED flashes two times, once every second, followed by a two second pause. Beeps stop after fifth iteration but LEDs continue until problem is solved.	2	Processor thermal protection activated: A fan may be blocked or not turning. OR The heat sink/fan assembly is not properly attached to the processor.	<ol style="list-style-type: none"> 1. Ensure that the computer air vents are not blocked and the processor cooling fan is running. 2. Open hood, press power button, and see if the processor fan spins. If the processor fan is not spinning, make sure the fan's cable is plugged onto the system board header. 3. If fan is plugged in, but is not spinning, then replace heat sink/fan assembly. 4. Contact an authorized reseller or service provider.
Red Power LED flashes three times, once every second, followed by a two second pause. Beeps stop after fifth iteration but LEDs continue until problem is solved.	3	Processor not installed (not an indicator of bad processor).	<ol style="list-style-type: none"> 1. Check to see that the processor is present. 2. Reseat the processor.
Red Power LED flashes four times, once every second, followed by a two second pause. Beeps stop after fifth iteration but LEDs continue until problem is solved.	4	Power failure (power supply is overloaded). OR The incorrect external power supply adapter is being used on the USDT.	<ol style="list-style-type: none"> 1. Open the hood and ensure the 4 or 6-wire power supply cable is seated into the connector on the system board. 2. Check if a device is causing the problem by removing ALL attached devices (such as hard, diskette, or optical drives, and expansion cards). Power on the system. If the system enters the POST, then power off and replace one device at a time and repeat this procedure until failure occurs. Replace the device that is causing the failure. Continue adding devices one at a time to ensure all devices are functioning properly. 3. Replace the power supply. 4. Replace the system board. <p>OR</p> <p>The USDT power supply adapter must be at 135W and use the Smart ID technology before the system will power up. Replace the power supply adapter with the HP-supplied USDT power supply adapter.</p>

Table E-2 Diagnostic Front Panel LEDs and Audible Codes (continued)

Activity	Beeps	Possible Cause	Recommended Action
Red Power LED flashes five times, once every second, followed by a two second pause. Beeps stop after fifth iteration but LEDs continue until problem is solved.	5	Pre-video memory error.	CAUTION: To avoid damage to the DIMMs or the system board, you must unplug the computer power cord before attempting to reseat, install, or remove a DIMM module. <ol style="list-style-type: none">1. Reseat DIMMs.2. Replace DIMMs one at a time to isolate the faulty module.3. Replace third-party memory with HP memory.4. Replace the system board.
Red Power LED flashes six times, once every second, followed by a two second pause. Beeps stop after fifth iteration but LEDs continue until problem is solved.	6	Pre-video graphics error.	For systems with a graphics card: <ol style="list-style-type: none">1. Reseat the graphics card.2. Replace the graphics card.3. Replace the system board. For systems with integrated graphics, replace the system board.
Red Power LED flashes seven times, once every second, followed by a two second pause. Beeps stop after fifth iteration but LEDs continue until problem is solved.	7	System board failure (ROM detected failure prior to video).	Replace the system board.
Red Power LED flashes eight times, once every second, followed by a two second pause. Beeps stop after fifth iteration but LEDs continue until problem is solved.	8	Invalid ROM based on bad checksum.	<ol style="list-style-type: none">1. Reflash the system ROM with the latest BIOS image. See the “Boot Block Emergency Recovery Mode” section of the <i>Desktop Management Guide</i> for more information.2. Replace the system board.
Red Power LED flashes nine times, once every second, followed by a two second pause. Beeps stop after fifth iteration but LEDs continue until problem is solved.	9	System powers on but is unable to boot.	<ol style="list-style-type: none">1. Check that the voltage selector, located on the rear of the power supply (some models), is set to the appropriate voltage. Proper voltage setting depends on your region.2. Unplug the AC power cord from the computer, wait 30 seconds, then plug the power cord back in to the computer.3. Replace the system board.4. Replace the processor.

Table E-2 Diagnostic Front Panel LEDs and Audible Codes (continued)

Activity	Beeps	Possible Cause	Recommended Action
Red Power LED flashes ten times, once every second, followed by a two second pause. Beeps stop after fifth iteration but LEDs continue until problem is solved.	10	Bad option card.	<ol style="list-style-type: none">1. Check each option card by removing the card (one at a time if multiple cards), then power on the system to see if fault goes away.2. Once a bad card is identified, remove and replace the bad option card.3. Replace the system board.
Red Power LED flashes eleven times, once every second, followed by a two second pause. Beeps stop after fifth iteration but LEDs continue until problem is solved.	11	The current processor does not support a feature previously enabled on this system.	<ol style="list-style-type: none">1. Install a TXT capable processor.2. Disable TXT in the Computer Setup (F10) utility.3. Reinstall the original processor.
System does not power on and LEDs are not flashing.	None	System unable to power on.	<p>Press and hold the power button for less than 4 seconds. If the hard drive LED turns green, the power button is working correctly. Try the following:</p> <ol style="list-style-type: none">1. Check that the voltage selector (some models), located on the rear of the power supply, is set to the appropriate voltage. Proper voltage setting depends on your region.2. Replace the system board. <p>OR</p> <p>Press and hold the power button for less than 4 seconds. If the hard drive LED does not turn on green then:</p> <ol style="list-style-type: none">1. Check that the unit is plugged into a working AC outlet.2. Open hood and check that the power button harness is properly connected to the system board.3. Check that both power supply cables are properly connected to the system board.4. Check to see if the 5V_aux light on the system board is turned on. If it is turned on, then replace the power button harness. If the problem persists, replace the system board.5. If the 5V_aux light on the system board is not turned on, remove the expansion cards one at a time until the 5V_aux light on the system board turns on. If the problem persists, replace the power supply.

F Password Security and Resetting CMOS

This computer supports security password features, which can be established through the Computer Setup Utilities menu.

This computer supports two security password features that are established through the Computer Setup Utilities menu: setup password and power-on password. When you establish only a setup password, any user can access all the information on the computer except Computer Setup. When you establish only a power-on password, the power-on password is required to access Computer Setup and any other information on the computer. When you establish both passwords, only the setup password will give you access to Computer Setup.

When both passwords are set, the setup password can also be used in place of the power-on password as an override to log in to the computer. This is a useful feature for a network administrator.

If you forget the password for the computer, you can clear that password so you can gain access to the information on the computer by resetting the password jumper.

 **CAUTION:** Pushing the CMOS button will reset CMOS values to factory defaults. It is important to back up the computer CMOS settings before resetting them in case they are needed later. Back up is easily done through Computer Setup. See [Computer Setup \(F10\) Utility on page 7](#) for information on backing up the CMOS settings.

Resetting the Password Jumper – Models 3300/3305

To disable the power-on or setup password features, or to clear the power-on or setup passwords, complete the following steps:

1. Shut down the operating system properly, then turn off the computer and any external devices, and disconnect the power cord from the power outlet.
2. With the power cord disconnected, press the power button again to drain the system of any residual power.

 **WARNING!** To reduce the risk of personal injury from electrical shock and/or hot surfaces, be sure to disconnect the power cord from the wall outlet, and allow the internal system components to cool before touching.

 **CAUTION:** When the computer is plugged in, the power supply always has voltage applied to the system board even when the unit is turned off. Failure to disconnect the power cord can result in damage to the system.

Static electricity can damage the electronic components of the computer or optional equipment. Before beginning these procedures, ensure that you are discharged of static electricity by briefly touching a grounded metal object. See the *Safety & Regulatory Information* guide for more information.

3. Remove the access panel.
4. Locate the header and jumper labeled CLR_PASS.

 **NOTE:** The password jumper is blue so that it can be easily identified. For assistance locating the password jumper and other system board components, see the Illustrated Parts & Service Map (IPSM). The IPSM can be downloaded from <http://www.hp.com/support>.

5. Remove the jumper from pins 2 and 3.
6. Place the jumper on pins 1 or 2.
7. Put the jumper back on pins 2 or 3.
8. Replace the access panel.
9. Reconnect the external equipment.
10. Plug in the computer and turn on power. Allow the operating system to start. This clears the current passwords and disables the password features.
11. To establish new passwords, use Computer Setup.

Resetting the Password Jumper – Model 7300/7500

To disable the power-on or setup password features, or to clear the power-on or setup passwords, complete the following steps:

1. Shut down the operating system properly, then turn off the computer and any external devices, and disconnect the power cord from the power outlet.
2. With the power cord disconnected, press the power button again to drain the system of any residual power.

⚠ WARNING! To reduce the risk of personal injury from electrical shock and/or hot surfaces, be sure to disconnect the power cord from the wall outlet, and allow the internal system components to cool before touching.

⚠ CAUTION: When the computer is plugged in, the power supply always has voltage applied to the system board even when the unit is turned off. Failure to disconnect the power cord can result in damage to the system.

Static electricity can damage the electronic components of the computer or optional equipment. Before beginning these procedures, ensure that you are discharged of static electricity by briefly touching a grounded metal object. See the *Safety & Regulatory Information* guide for more information.

3. Remove the access panel.
4. Locate the CMOS/password header.

📄 NOTE: The password jumper is blue so that it can be easily identified. For assistance locating the password jumper and other system board components, see the Illustrated Parts & Service Map (IPSM). The IPSM can be downloaded from <http://www.hp.com/support>.

5. Remove the jumper from pins 5 and 3.
6. Place the jumper on pins 3 or 1 for 10-15 seconds.
7. Put the jumper back on pins 5 or 3.

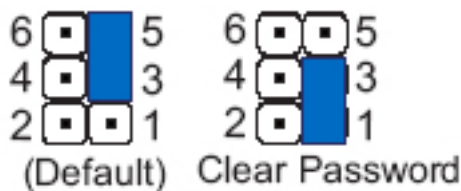

8. Replace the access panel.
9. Reconnect the external equipment.
10. Plug in the computer and turn on power. Allow the operating system to start.
11. To establish new passwords, use Computer Setup.

Clearing and Resetting the CMOS – Models 3300/3305

The computer's configuration memory (CMOS) stores information about the computer's configuration.

The CMOS button resets CMOS but does not clear the power-on and setup passwords.

Clearing CMOS will clear the Active Management Technology (AMT) settings in the Management Engine BIOS Extension (MEBx), including the password. The password will default to "admin" and will need to be reset. The AMT settings will also need to be reset. To access the MEBx, press **Ctrl+P** during POST.

1. Shut down the operating system properly, then turn off the computer and any external devices, and disconnect the power cord from the power outlet.
2. With the power cord disconnected, press the power button again to drain the system of any residual power.

 **WARNING!** To reduce the risk of personal injury from electrical shock and/or hot surfaces, be sure to disconnect the power cord from the wall outlet, and allow the internal system components to cool before touching.

 **CAUTION:** When the computer is plugged in, the power supply always has voltage applied to the system board even when the unit is turned off. Failure to disconnect the power cord can result in damage to the system.

Static electricity can damage the electronic components of the computer or optional equipment. Before beginning these procedures, ensure that you are discharged of static electricity by briefly touching a grounded metal object. See the *Safety & Regulatory Information* guide for more information.

3. Remove the access panel.
4. Locate the header and jumper labeled CLR_CMOS

 **NOTE:** The password jumper is blue so that it can be easily identified. For assistance locating the password jumper and other system board components, see the Illustrated Parts & Service Map (IPSM). The IPSM can be downloaded from <http://www.hp.com/support>.

5. Remove the jumper from pins 2 and 3.
6. Place the jumper on pins 1 or 2.
7. Put the jumper back on pins 2 or 3.
8. Replace the access panel.
9. Reconnect the external equipment.
10. Plug in the computer and turn on power. Allow the operating system to start. This clears the current passwords and disables the password features.

 **NOTE:** You will receive POST error messages after clearing CMOS and rebooting advising you that configuration changes have occurred. Use Computer Setup to reset any special system setups along with the date and time.

For instructions on Computer Setup, see [Computer Setup \(F10\) Utility on page 7](#).

Clearing and Resetting the CMOS – Model 7300/7500

The computer's configuration memory (CMOS) stores information about the computer's configuration.

The CMOS button resets CMOS but does not clear the power-on and setup passwords.

Clearing CMOS will clear the Active Management Technology (AMT) settings in the Management Engine BIOS Extension (MEBx), including the password. The password will default to "admin" and will need to be reset. The AMT settings will also need to be reset. To access the MEBx, press **Ctrl+P** during POST.

1. Shut down the operating system properly, then turn off the computer and any external devices, and disconnect the power cord from the power outlet.
2. With the power cord disconnected, press the power button again to drain the system of any residual power.

⚠ WARNING! To reduce the risk of personal injury from electrical shock and/or hot surfaces, be sure to disconnect the power cord from the wall outlet, and allow the internal system components to cool before touching.

⚠ CAUTION: When the computer is plugged in, the power supply always has voltage applied to the system board even when the unit is turned off. Failure to disconnect the power cord can result in damage to the system.

Static electricity can damage the electronic components of the computer or optional equipment. Before beginning these procedures, ensure that you are discharged of static electricity by briefly touching a grounded metal object. See the *Safety & Regulatory Information* guide for more information.

3. Remove the access panel.
4. Locate the CMOS/password header.

📄 NOTE: The password jumper is blue so that it can be easily identified. For assistance locating the password jumper and other system board components, see the Illustrated Parts & Service Map (IPSM). The IPSM can be downloaded from <http://www.hp.com/support>.

5. Remove the jumper from pins 6 and 4.
6. Place the jumper on pins 4 or 2 for 10-15 seconds.
7. Put the jumper back on pins 6 or 4.

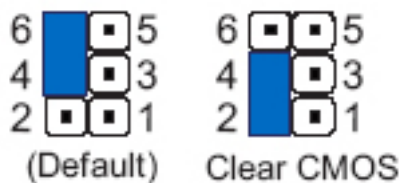

8. Replace the access panel.
9. Reconnect the external equipment.
10. Plug in the computer and turn on power. Allow the operating system to start.

G Specifications

MT Specifications

Table G-1 Specifications

Chassis		
Height	15.08 in	38.2 cm
Width	6.82 in	17.3 cm
Depth	16.58 in	42.1 cm
Approximate Weight		
	22.0 lb	10.0 kg
Temperature Range		
Operating	41° to 95°F	5° to 35°C
Nonoperating	-22° to 149°F	-30° to 65°C
Relative Humidity (noncondensing)		
Operating	15-90%	15-90%
	15-90%	15-90%
Maximum Altitude (unpressurized)		
Operating	10,000 ft	3048 m
Nonoperating	30,000 ft	9144 m
Power Supply		
Energy Consumption		
Normal Operation	70.8 W	
Sleep (Energy Star Low Power Mode)	1.77 W	
Off	0.72 W	
	230 VAC	
Heat Dissipation*		
Normal Operation	57.2 W or 195.2BTU/Hr	
Sleep (Energy Star Low Power Mode)	1.30 W or 4.44BTU/Hr	
Off	0.54 W or 1.84BTU/Hr	

Table G-1 Specifications (continued)

Model	300W
Rated Voltage Range	100-240 VAC

¹ *Heat dissipation is calculated based on the measured watts, assuming the service level is attained for one hour.

SFF Specifications

Table G-2 Specifications

Chassis		
Height	12.77 in	32.5 cm
Width	4.98 in	10.4 cm
Depth	15.61 in	39.7 cm
Approximate Weight	13.9 lb	6.3 kg
Temperature Range		
Operating	41° to 95°F	5° to 35°C
Nonoperating	-22° to 149°F	-30° to 65°C
Relative Humidity (noncondensing)		
Operating	10-90%	10-90%
	5-95%	5-95%
Maximum Altitude (unpressurized)		
Operating	10,000 ft	3048 m
Nonoperating	30,000 ft	9144 m
Power Supply		
Energy Consumption	142.7 kWh	
Normal Operation	39.61 W	
Sleep (Energy Star Low Power Mode)	1.55 W	
Off	0.67 W	
Model	220W	
Rated Voltage Range	100-240 VAC	

Index

- A**
 - access panel
 - MT spare part number 51
 - removal and replacement 51
 - SFF removal and replacement 105
 - SFF spare part number 105
 - access panel, locked 148
 - access panel, MT
 - spare part number 22, 30
 - access panel, SFF
 - spare part number 33, 38
 - audible codes 207
 - audio problems 163
 - B**
 - Backup and Restore 193
 - battery
 - disposal 49
 - removal and replacement 102, 142
 - beep codes 207
 - booting options
 - Full Boot 198
 - Quick Boot 198
 - C**
 - cable connections 69, 119
 - cable management 68, 118
 - cable pinouts
 - SATA data 40
 - cautions
 - AC power 42
 - cables 48
 - cooling fan 47
 - electrostatic discharge 42
 - keyboard cleaning 46
 - keyboard keys 47
 - CD-ROM or DVD problems 176
 - Cleaning**
 - computer 46
 - mouse 47
 - safety precautions 46
 - CMOS**
 - backing up 211
 - clearing and resetting 214
 - computer cleaning 46
 - connecting drive cables 72
 - connections
 - system board 69, 119
 - country power cord set requirements 197
 - Customer Support 144, 184
- D**
 - disassembly preparation 50
 - SFF 104
 - drive connectors 72
 - drives
 - connecting cables 72
 - installing 72
 - locations 71
 - removal and replacement 70
 - SFF cable connections 121
 - SFF installation 121
 - SFF locations 120
 - E**
 - electrostatic discharge (ESD) 42
 - preventing damage 43
 - error
 - codes 198, 207
 - messages 199
 - expansion card
 - SFF installation 113
 - SFF removal 113
 - expansion card sockets 114
 - F**
 - f11 recovery 195
 - fan
 - MT spare part number 89
 - power supply 47
 - removal and replacement 89
 - SFF spare part number 132
 - fan duct
 - spare part number 39
 - fan duct, SFF
 - spare part number 36
 - fan sink
 - MT spare part number 91
 - removal and replacement 91
 - SFF spare part number 134
 - fan sink, MT
 - spare part number 26, 30
 - fan sink, SFF
 - spare part number 36, 39
 - fan, MT
 - spare part number 26, 30
 - fan, SFF
 - spare part number 36, 38
 - flash drive problems 179
 - flashing LEDs 207
 - front bezel
 - MT spare part number 53
 - removal and replacement 53
 - SFF removal and replacement 107
 - SFF spare part number 107
 - front bezel, MT
 - spare part number 22, 30
 - front bezel, SFF
 - spare part number 33, 39
 - expansion slot cover
 - replacing 66

- front fan
 - SFF removal and replacement 132
 - front I/O and card reader assembly
 - SFF spare part number 129
 - spare part number 36, 39
 - Front I/O and USB assembly
 - MT spare part number 84
 - spare part number 26, 30
 - front I/O device
 - removal and replacement 84
 - front I/O, power switch assembly
 - SFF removal and replacement 129
 - front panel problems 180
- G**
- general problems 147
 - graphics card, spare part number 37, 38, 113
 - grounding methods 43
- H**
- hard drive
 - proper handling 48
 - removing 77
 - SATA characteristics 40
 - SFF installation 123
 - SFF removal 123
 - spare part number 38
 - spare part numbers 27, 28, 29, 37, 38
 - hard drive problems 153
 - hard drive recovery 195
 - hardware installation problems 169
 - heat sink
 - removal and replacement 91
 - SFF removal and replacement 134
 - helpful hints 145
 - hood sensor
 - SFF removal and replacement 127
 - spare part number 38
- I**
- installing
 - drive cables 72
 - PCI card 66
 - SFF drive cables 121
 - SFF expansion card 113
 - SFF hard drive 123
 - SFF memory 108
 - Internet access problems 180
- K**
- keyboard
 - cleaning 46
 - keyboard problems 167
- L**
- LEDs
 - blinking power 207
 - blinking PS/2 keyboard 207
- M**
- Media Card Reader problems 156
 - memory
 - populating sockets 57, 109
 - removal and replacement 55
 - SFF installation 108
 - specifications 55, 108
 - memory module
 - spare part number 55, 108
 - memory modules
 - spare part number 22, 28, 29, 31, 34, 37, 38
 - memory problems 174
 - microtower components 2
 - monitor problems 158
 - mouse
 - cleaning 47
 - spare part number 26, 36
 - mouse problems 167
 - MT
 - access panel, spare part number 22, 30
 - fan sink, spare part number 26, 30
 - fan, spare part number 26, 30
 - front bezel, spare part number 22, 30
 - power supply, spare part number 22, 30
 - power switch/LED assembly, spare part number 30
 - SATA cable, spare part number 25
 - system board, spare part number 22, 29, 30
- N**
- network problems 171
 - numeric error codes 199
- O**
- operating guidelines 45
 - optical drive
 - removing 74
 - SFF removal 121
 - spare part numbers 27, 28, 37
 - optical drive problems 176
 - overheating, prevention 45
- P**
- password
 - clearing 211
 - power-on 211
 - setup 211
 - PCI card 64, 65, 66, 114
 - PCI Express card 65, 114
 - POST error messages 198
 - power cord set requirements
 - country specific 197
 - power problems 151
 - power supply
 - fan 47
 - operating voltage range 216, 217
 - removal and replacement 98
 - SFF removal and replacement 138
 - power supply, MT
 - spare part number 22, 30
 - power supply, SFF
 - spare part number 33, 38
 - power switch/LED
 - removal and replacement 87
 - power switch/LED assembly
 - MT spare part number 87
 - SFF spare part number 127
 - power switch/LED assembly, MT
 - spare part number 25, 30
 - power switch/LED assembly, SFF
 - spare part number 35, 39
 - power-on password 211
 - preparation for disassembly 50
 - printer problems 165
 - problems
 - audio 163

- CD-ROM or DVD 176
- flash drive 179
- front panel 180
- general 147
- hard drive 153
- hardware installation 169
- Internet access 180
- keyboard 167
- Media Card Reader 156
- memory 174
- monitor 158
- mouse 167
- network 171
- power 151
- printer 165
- processor 176
- software 182
- processor
 - removal and replacement 94
 - SFF removal and replacement 136
 - spare part number 22, 29, 34, 38
- processor problems 176
- R**
- recovery partition 195
- removal and replacement
 - access panel 51
 - battery 102, 142
 - drives 70
 - fan 89
 - fan sink 91
 - front bezel 53
 - front I/O device 84
 - heat sink 91
 - memory 55
 - power supply 98
 - power switch 87
 - processor 94
 - SFF front bezel 105, 107
 - SFF front fan 132
 - SFF front I/O, power switch assembly 129
 - SFF heat sink 134
 - SFF hood sensor 127
 - SFF power supply 138
 - SFF processor 136
 - SFF system board 140
 - system board 100
- removing
 - hard drive 77
 - optical drive 74
 - PCI card 64, 65
 - PCI Express card 65
 - SFF expansion card 113
 - SFF hard drive 123
 - SFF optical drive 121
- resetting
 - CMOS 211
 - password jumper 211
- restoring the hard drive 195
- S**
- safety and comfort 144
- safety precautions
 - cleaning 46
- SATA
 - connectors on system board 40
 - data cable pinouts 40
 - hard drive characteristics 40
- SATA cable, MT
 - spare part number 25
- SATA cable, SFF
 - spare part number 35
- screws, correct size 48
- SDRAM (synchronous dynamic random access memory 55
- service considerations 47
- serviceability features 2
- setup password 211
- SFF
 - access panel, spare part number 33, 38
 - disassembly preparation 104
 - fan duct, spare part number 36
 - fan sink, spare part number 36, 39
 - fan, spare part number 36, 38
 - front bezel removal and replacement 105, 107
 - front bezel, spare part number 33, 39
 - front fan removal and replacement 132
 - front I/O, power switch assembly removal and replacement 129
- heat sink removal and replacement 134
- hood sensor removal and replacement 127
- power supply removal and replacement 138
- power supply, spare part number 33, 38
- power switch/LED assembly, spare part number 25, 35, 39
- preparation for disassembly 104
- processor removal and replacement 136
- SATA cable, spare part number 35
- system board removal and replacement 140
- system board, spare part number 33, 38
- small form factor components 3
- software
 - problems 182
 - servicing computer 47
- spare part number
 - tamper-resistant wrench 48
 - Torx T-15 screwdriver 47
- specifications
 - computer 216
 - memory 55, 108
- static electricity 42
- system board
 - MT spare part number 100
 - removal and replacement 100
 - SATA connectors 40
 - SFF removal and replacement 140
 - SFF spare part number 140
- system board drive connections 72
- system board, MT
 - spare part number 22, 29, 30
- system board, SFF
 - spare part number 33, 38
- T**
- tamper-proof screws
 - tool 48
- temperature control 45

tools, servicing 47
Torx T15 screwdriver 47

V

ventilation, proper 45

W

Wake-on-LAN feature 171
Windows 8 operating system
DVD 195