

**Acer**

**Aspire X3950/X5950  
Service Guide**

PRINTED IN TAIWAN

---

## Revision History

Please refer to the table below for the updates made on this service guide.

Date	Chapter	Updates

---

## Copyright

Copyright © 2010 by Acer Incorporated. All rights reserved. No part of this publication may be reproduced, transmitted, transcribed, stored in a retrieval system, or translated into any language or computer language, in any form or by any means, electronic, mechanical, magnetic, optical, chemical, manual or otherwise, without the prior written permission of Acer Incorporated.

---

## Disclaimer

The information in this guide is subject to change without notice.

Acer Incorporated makes no representations or warranties, either expressed or implied, with respect to the contents hereof and specifically disclaims any warranties of merchantability or fitness for any particular purpose. Any Acer Incorporated software described in this manual is sold or licensed "as is". Should the programs prove defective following their purchase, the buyer (and not Acer Incorporated, its distributor, or its dealer) assumes the entire cost of all necessary servicing, repair, and any incidental or consequential damages resulting from any defect in the software.

Acer is a registered trademark of Acer Corporation.

Intel is a registered trademark of Intel Corporation.

Pentium Dual-Core, Celeron Dual-Core, Core 2 Duo, Core 2 Quad, Celeron, and combinations thereof, are trademarks of Intel Corporation.

Other brand and product names are trademarks and/or registered trademarks of their respective holders.

---

## Conventions

The following conventions are used in this manual:

<b>SCREEN MESSAGES</b>	Denotes actual messages that appear on screen.
<b>NOTE</b>	Gives additional information related to the current topic.
<b>WARNING</b>	Alerts you to any physical risk or system damage that might result from doing or not doing specific actions.
<b>CAUTION</b>	Gives precautionary measures to avoid possible hardware or software problems.
<b>IMPORTANT</b>	Reminds you to do specific actions relevant to the accomplishment of procedures.

---

## Service Guide Coverage

This Service Guide provides you with all technical information relating to the BASIC CONFIGURATION decided for Acer's "global" product offering. To better fit local market requirements and enhance product competitiveness, your regional office MAY have decided to extend the functionality of a machine (e.g. add-on card, modem, or extra memory capability). These LOCALIZED FEATURES will NOT be covered in this generic service guide. In such cases, please contact your regional offices or the responsible personnel/channel to provide you with further technical details.

## FRU Information

Please note WHEN ORDERING FRU PARTS, that you should check the most up-to-date information available on your regional web or channel. If, for whatever reason, a part number change is made, it will not be noted in the printed Service Guide. For ACER-AUTHORIZED SERVICE PROVIDERS, your Acer office may have a DIFFERENT part number code to those given in the FRU list of this printed Service Guide. You MUST use the list provided by your regional Acer office to order FRU parts for repair and service of customer machines.

# Table of Contents

<b>System Tour</b>	<b>1</b>
Features	1
System Components	3
Front Panel	3
Rear Panel	5
Internal Components	6
System LED Indicators	7
<b>System Utilities</b>	<b>9</b>
CMOS Setup Utility	9
Entering CMOS setup	10
Navigating Through the Setup Utility	10
Setup Utility Menus	11
<b>System Disassembly</b>	<b>25</b>
Disassembly Requirements	25
Pre-disassembly Procedure	26
Main Unit Disassembly	27
Removing the Side Panel	29
Removing the Front Bezel	30
Removing the Heatsink Fan Assembly	32
Removing the Processor	34
Removing the Optical Drive	36
Removing the Hard Disk Drive	39
Removing the Power Supply	40
Removing the Memory Modules	42
Removing an Expansion Card	43
Removing the Front I/O and Card Reader Boards	46
Removing the Mainboard	49
Removing the Top Bezel	51
<b>System Troubleshooting</b>	<b>53</b>
Hardware Diagnostic Procedure	53
System Check Procedures	54
Power System Check	54
System External Inspection	54
System Internal Inspection	54
Checkpoints	55
Viewing BIOS checkpoints	55
Bootblock Initialization Code Checkpoints	55
Bootblock Recovery Code Checkpoints	56
POST Code Checkpoints	57
DIM Code Checkpoints	59
ACPI Runtime Checkpoints	59
Error Messages	60
Memory	60
Boot	60
Storage Device	61
Virus Related	62
System Configuration	63
CMOS	64
Miscellaneous	64

---

USB eModule Error Messages	65
SMBIOS eModule Error Messages	65
CPU eModule Error Messages	65
MPS Table (Multi-processor) eModule Error Messages	65
Beep Codes	66
Index of Symptom-to-FRU Error Message	67
BIOS Recovery	72
Undetermined Problems	74
<b>System Block Diagram and Board Layout</b>	<b>75</b>
System Block Diagram	75
Mainboard Layout	76
<b>FRU (Field Replaceable Unit) List</b>	<b>79</b>
Exploded Diagram	80
X3950 FRU List	82
X5950 FRU List	90
<b>Technical Specifications</b>	<b>93</b>



# System Tour

---

## Features

Below is a brief summary of the computer's many features:

**NOTE:** The features listed in this section is for your reference only. The exact configuration of the system depends on the model purchased.

### Processor

- One LGA 1156 socket
- Intel® Core™ i3-530/540 processor
- Intel Core i5-650/660/661/670/750 processor
- Intel Core i7-860/870 processor
- Intel Pentium G6950 processor

### Chipset

- Intel P55 Express chipset

### Memory subsystem

- Four DDR3-800/1066/1333 MHz DIMM sockets
- Supports single channel or dual-channel memory mode
- Maximum of 8GB supported

### Media storage

- Super-Multi DVD drive
- BD Combo, BD-ROM, BD-RW drive
- SATA hard disk drive

### Serial ATA controller

- Embedded SATA controllers
- Two SATA ports

### Audio

- Realtek ALC888S-VC HD Audio Codec 7.1
- Three audio jacks

### Networking

- Intel PCI-E Gbe LAN controller PHY
- One Gigabit Ethernet LAN port (RJ-45)

### PCI I/O

- PCI Express x16 bus slot
- PCI Express x1 bus slot

---

## I/O ports

- ❑ Front
  - Five USB 2.0 ports
  - Headphone/speaker-out/line-out jack
  - Microphone-in jack
  - 9-in-1 media card reader — CompactFlash® (Type I and II), CF+™ Microdrive, MultiMediaCard (MMC), Reduced-Size MultiMediaCard (RS-MMC), Secure Digital™ (SD) Card, xD-Picture Card™, Memory Stick™, Memory Stick PRO™
- ❑ Rear
  - PS/2 keyboard port
  - PS/2 mouse port
  - Three audio jacks
  - HDMI port
  - Six USB 2.0 ports
  - Gigabit LAN port
  - VGA/monitor port

## Operating system and software

- ❑ Operating system
  - Windows 7 Home Premium x64
  - Windows 7 Home Premium X86
  - Windows 7 Home Basic X86,
  - FreeDOS
  - Linux LL95
- ❑ Applications
  - Acer eRecovery Management
  - Acrobat Reader
  - Acrobat Flash Player
  - Arcade Deluxe
  - Cyberlink Power Director
  - McAfee Internet Security
  - MyWinLocker
  - Microsoft Works
  - Nero 9 Essentials

## Power supply

- ❑ 220-watts (115/230V AC) PFC or non-PFC power supply

## Dimension and weight

- ❑ Dimension (DxWxH)
  - X3950: 367.8 x 100 x 281.5 mm (with bezel)
  - X5950: 367.8 x 100 x 281.5 mm (with bezel)
- ❑ Weight (estimate)
  - X3950: ≥ 8 kg
  - X5950: ≥ 8 kg





# System Components

This section is a virtual tour of the system's interior and exterior components.

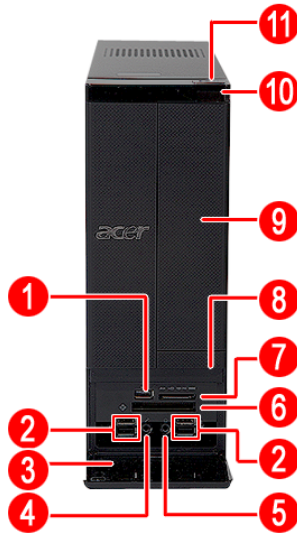



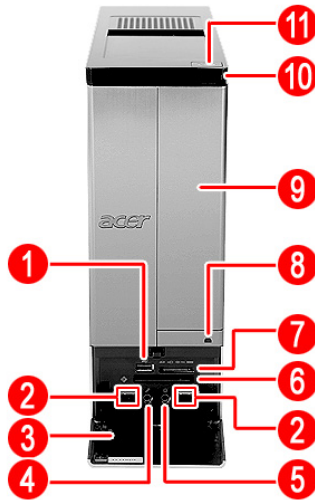

## Front Panel

X3950









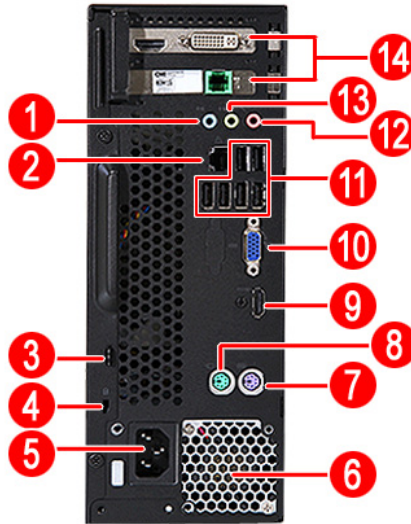

No.	Icon	Component
1		USB 2.0 ports
2		
3		Front I/O cover
4		Microphone-in jack
5		Headphone/Speaker-out/line-out jack
6		CF I/II (CompactFlash Type I/II) slot
7		Media card reader
8		Drive bay door eject button Press to open drive bay door and access the optical drive.
9		Optical drive bay door
10		HDD activity indicator
11		Power button/power indicator



No.	Icon	Component
1		USB 2.0 ports
2		
3		Front I/O cover
4		Microphone-in jack
5		Headphone/Speaker-out/line-out jack
6		CF I/II (CompactFlash Type I/II) slot
7		Media card reader
8		Drive bay door eject button Press to open drive bay door and access the optical drive.
9		Optical drive bay door
10		HDD activity indicator
11		Power button/power indicator

# Rear Panel



No.	Icon	Component
1		Audio in or side speaker jack
2		Gigabit LAN port (10/100/1000 Mbps)
3		Key hole
4		Lock slot
5		Power connector
6		Power supply (Photo shows PFC power supply)
7		PS2 keyboard port
8		PS2 mouse port
9	HDMI	HDMI port
10		VGA/monitor port
11		USB 2.0 ports
12		Microphone/speaker-out/line-in jack
13		Line-out jack
14		Expansion slot (Photo shows graphics card and network card)

# Internal Components

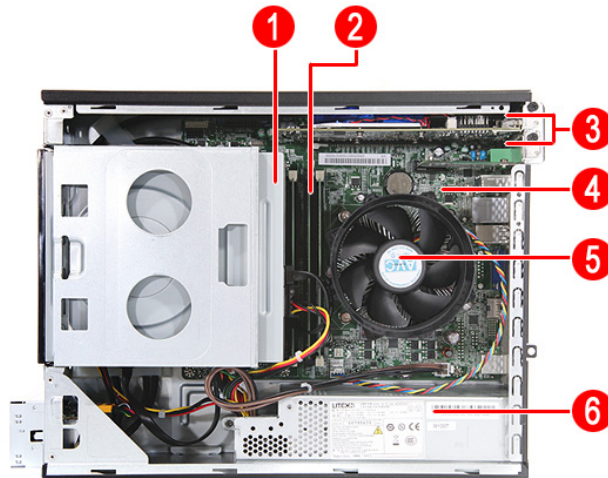

No.	Component
1	Optical drive
2	Memory
3	Expansion cards
4	Mainboard
5	Heatsink fan assembly
6	Power supply

---

## System LED Indicators

This section describes the different system LED indicators.

LED indicator	Color	LED status	Description
Power	Blue	On	S0/S1 state
	Blue	Blinking	S3 state
	—	Off	S4/S5 state
HDD activity	Blue	Blinking	S0/S1 state
LAN activity	Blue	Blinking	S0/S1 state
LAN port network speed LED (left)	Amber	On	1000 Mbps link network access
	Green	On	100 Mbps link network access
	—	Off	10 Mbps link network access
LAN port network connection LED (right)	Green	On	Active network link
		Blinking	Ongoing network data activity
		Off	Off-line network





# System Utilities

---

## CMOS Setup Utility

CMOS setup is a hardware configuration program built into the system ROM, called the complementary metal-oxide semiconductor (CMOS) Setup Utility. Since most systems are already properly configured and optimized, there is no need to run this utility. You will need to run this utility under the following conditions.

- When changing the system configuration settings
- When redefining the communication ports to prevent any conflicts
- When modifying the power management configuration
- When changing the password or making other changes to the security setup
- When a configuration error is detected by the system and you are prompted ("Run Setup" message) to make changes to the CMOS setup

**NOTE:** If you repeatedly receive Run Setup messages, the battery may be bad. In this case, the system cannot retain configuration values in CMOS. Ask a qualified technician for assistance.

CMOS setup loads the configuration values in a battery-backed nonvolatile memory called CMOS RAM. This memory area is not part of the system RAM which allows configuration data to be retained when power is turned off.

Before you run the *CMOS Setup Utility*, make sure that you have saved all open files. The system reboots immediately after you close the Setup.

**NOTE:** *CMOS Setup Utility* will be simply referred to as "BIOS", "Setup", or "Setup utility" in this guide.

The screenshots used in this guide display default system values. These values may not be the same those found in your system.

---

## Entering CMOS setup

1. Turn on the computer and the monitor.

If the computer is already turned on, close all open applications, then restart the computer.

2. During POST, press **Delete**.

If you fail to press **Delete** before POST is completed, you will need to restart the computer.

The Setup Main menu will be displayed showing the Setup's menu bar. Use the left and right arrow keys to move between selections on the menu bar.

## Navigating Through the Setup Utility

Use the following keys to move around the Setup utility.

- Left** and **Right** arrow keys – Move between selections on the menu bar.
- Up** and **Down** arrow keys – Move the cursor to the field you want.
- PgUp** and **PgDn** keys – Move the cursor to the previous and next page of a multiple page menu.
- Home** – Move the cursor to the first page of a multiple page menu.
- End** – Move the cursor to the last page of a multiple page menu.
- +** and **-** keys – Select a value for the currently selected field (only if it is user-configurable). Press these keys repeatedly to display each possible entry, or the **Enter** key to choose from a pop-up menu.

**NOTE:** Grayed-out fields are not user-configurable.

- Enter** key – Display a submenu screen.

**NOTE:** Availability of submenu screen is indicated by a (>).

- Esc** – If you press this key:
  - On one of the primary menu screens, the Exit menu displays.
  - On a submenu screen, the previous screen displays.
  - When you are making selections from a pop-up menu, closes the pop-up without making a selection.
- F1** – Display the General Help panel.
- F9** – Press to load optimized default system values.
- F10** – Save changes made the Setup and close the utility.

# Setup Utility Menus

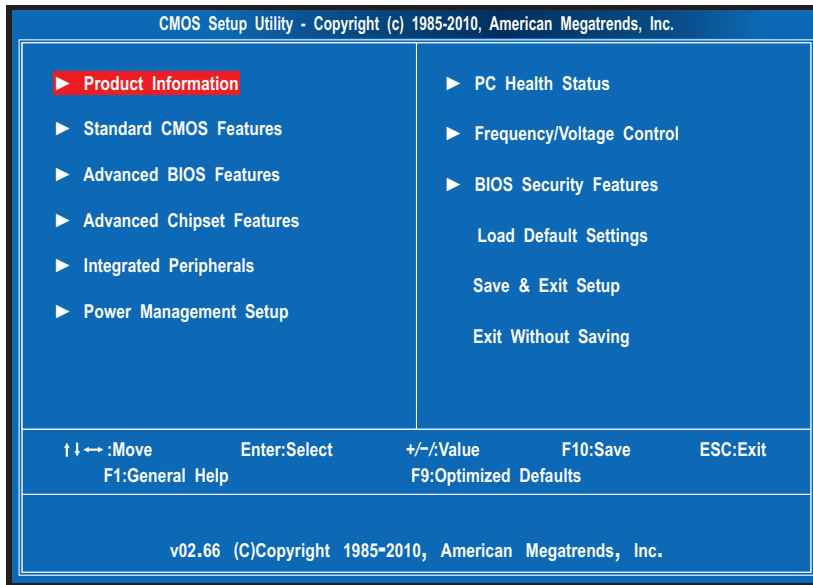

The Setup Main menu includes the following main setup categories.

- Product Information
- Standard CMOS Features
- Advanced BIOS Features
- Advanced Chipset Features
- Integrated Peripherals
- Power Management Setup
- PC Health Status
- Frequency/Voltage Control
- BIOS Security Features
- Load Default Settings
- Save & Exit Setup
- Exit Without Saving

In the descriptive table following each of the menu screenshots, settings in **boldface** are the default and suggested settings.

## Product Information

The Product Information menu displays basic information about the system. These entries are for your reference only and are not user-configurable.

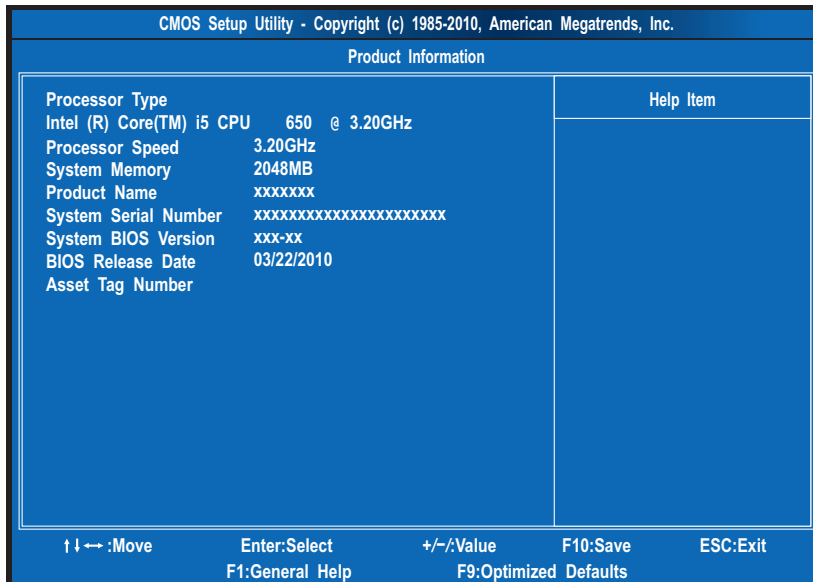

Parameter	Description
Processor Type	Type of CPU installed on the system.
Processor Speed	Speed of the CPU installed on the system.
System Memory	Total size of system memory installed on the system.
Product Name	Product name of the system.
System Serial Number	Serial number of the system.
System BIOS Version	Version number of the BIOS setup utility.
BIOS Release Date	Date when the BIOS setup utility was released
Asset Tag Number	Asset tag number of this system.

## Standard CMOS Features

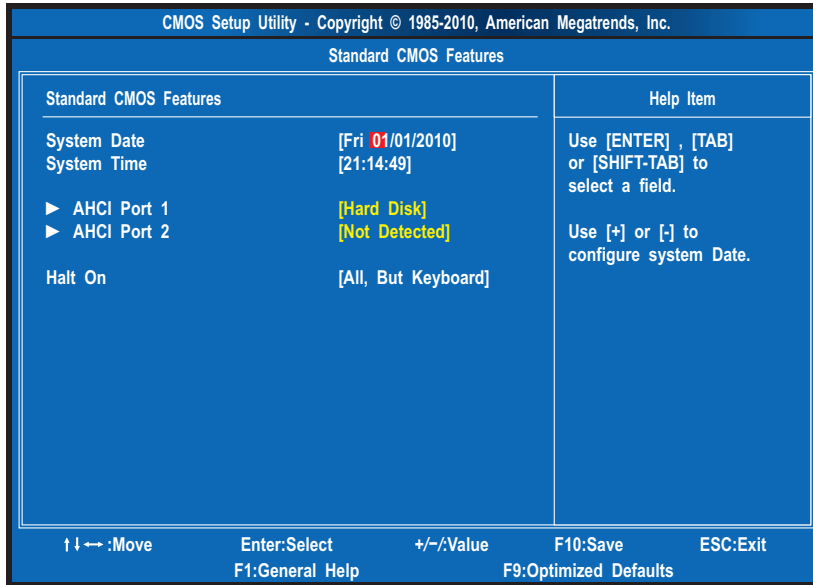

Parameter	Description	Option
System Date	Set the date following the weekday-month-day-year format.	
System Time (hh:mm:ss)	Set the system time following the hour-minute-second format.	
AHCI Port 1/2	Displays the status of auto detection of the AHCI device.	
Halt On	Determines whether the system will stop for an error during the POST.	<b>All, But Keyboard</b> No Errors All Errors

# Advanced BIOS Features

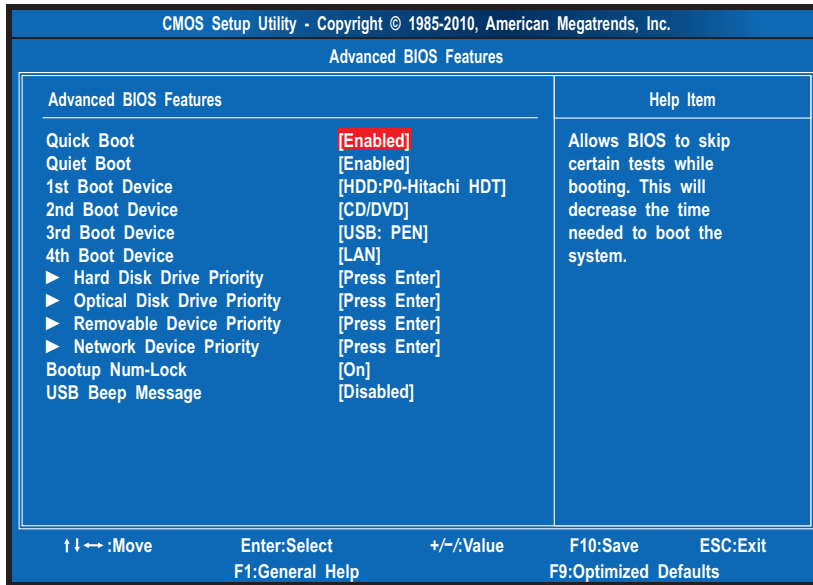

Parameter	Description	Option
Quick Boot	Allows you to decrease the time it takes to boot the computer by shortening or skipping certain standard booting process.	Enabled Disabled
Quiet Boot	When enabled, the BIOS splash screen displays during startup. When disabled, the diagnostic screen displays during startup.	Enabled Disabled
1st/2nd/3rd/4th Boot Device	Specifies the boot order from the available devices.	Hard Disk CD/DVD Removable Device LAN
Hard Disk Drive Priority	Press <b>Enter</b> to access the Hard Disk Drive Priority submenu and specify the boot device priority sequence from available hard drives.	
Optical Disk Drive Priority	Press <b>Enter</b> to access the Optical Disk Drive Priority submenu and specify the boot device priority sequence from available CD/DVD drives.	
Removable Device Priority	Press <b>Enter</b> to access the Removable Device Priority submenu and specify the boot device priority sequence from available removable drives.	
Network Device Priority	Press <b>Enter</b> to access the Network Device Priority submenu and specify the boot sequence from available network devices.	
Bootup Num-Lock	Selects power on state for Num Lock.	On Off
USB Beep Message	Enables or disables BIOS to display error beeps or messages during USB device enumeration.	Enabled Disabled

# Advanced Chipset Features

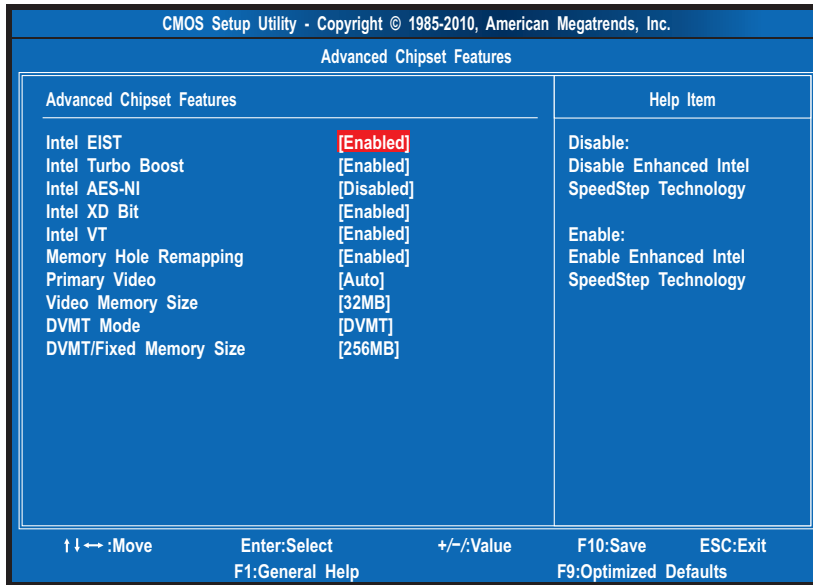

Parameter	Description	Option
Intel EIST	When enabled, this feature allows the OS to reduce power consumption. When disabled, the system operates at maximum CPU speed.	<b>Enabled</b> Disabled
Intel Turbo Boost	Enables or disables Intel Turbo Boost Technology.	<b>Enabled</b> Disabled
Intel AES-NI	Enables or disables Advanced Encryption Standard New Instructions (AES-NI).	<b>Enabled</b> Disabled
Intel XD Bit	When enabled, the processor disables code execution when a worm attempts to insert a code in the buffer preventing damage and worm propagation. When disabled, the processor forces the Execute Disable (XD) Bit feature flag to always return to 0.	<b>Enabled</b> Disabled
Intel VT	Enables or disables the Virtualization Technology (VT) availability. If enabled, a virtual machine manager (VMM) can utilize the additional hardware virtualization capabilities provided by this technology. <b>Note:</b> A full reset is required to change the setting.	<b>Enabled</b> Disabled
Memory Hole Remapping	Enables or disables remapping of overlapped PCI memory above the total physical memory.	<b>Enabled</b> Disabled
Primary Video	Select a graphic controller as a primary boot device.	<b>Auto</b> PCIe Onboard VGA
Video Memory Size	Select the amount of system memory used by the Intel graphics device.	<b>32MB</b> 64 MB 128 MB Disabled
DVMT Mode	Select a video memory mode.	<b>DVMT</b> Fixed
DVMT/Fixed Memory Size	Select a video memory size.	<b>256MB</b> 128 MB Maximum

# Integrated Peripherals

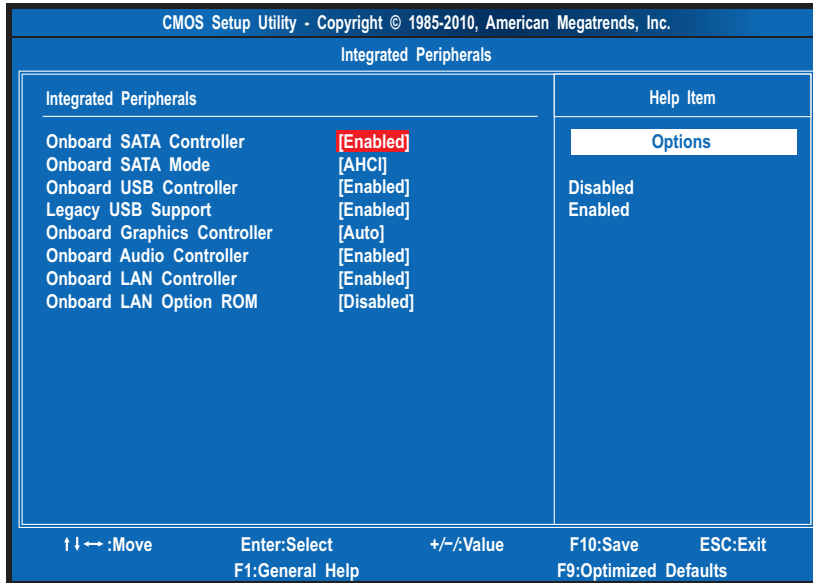

Parameter	Description	Option
Onboard SATA Controller	Select an operating mode for the onboard SATA.	<b>Enabled</b> Disabled
Onboard SATA Mode	Select an operating mode for the onboard SATA.	<b>AHCI</b> Native IDE
Onboard USB Controller	Enables or disables support for legacy USB devices	<b>Enabled</b> Disabled
Legacy USB Support	Enables or disables support for legacy USB devices.	<b>Enabled</b> Disabled
Onboard Graphics Controller	Enables or disables the onboard graphics controller.	<b>Auto</b> Onboard
Onboard Audio Controller	Enables or disables the onboard audio controller.	<b>Enabled</b> Disabled
Onboard LAN Controller	Enables or disables the onboard LAN controller.	<b>Enabled</b> Disabled
Onboard LAN Option ROM	Enables or disables the load of embedded option ROM for onboard network controller.	Enabled <b>Disabled</b>



# Power Management Setup

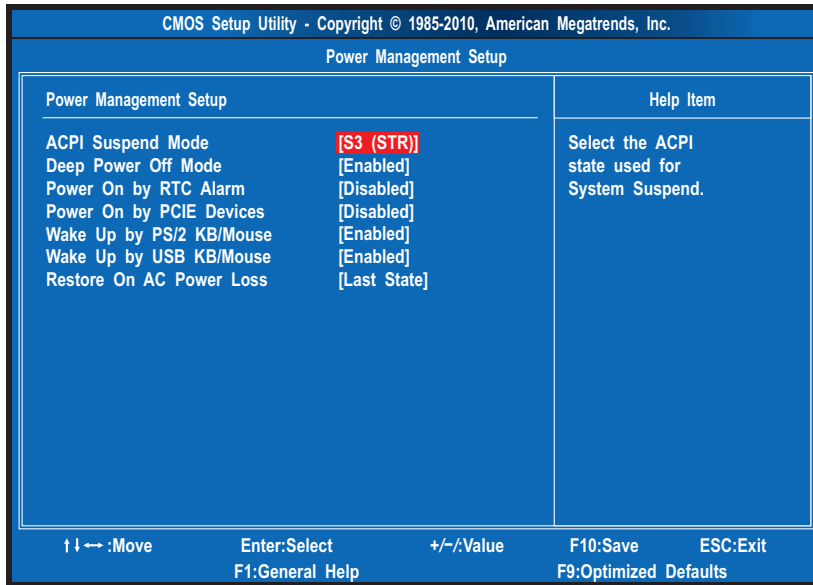

Parameter	Description	Option
ACPI Suspend Mode	Select an ACPI state.	<b>S3 (STR)</b> S1 (POS)
Deep Power Off Mode	Enables or disables the deep power off mode.	<b>Enabled</b> Disabled
Power On by RTC Alarm	Enables or disables real time clock (RTC) to generate a wake event.	Enabled <b>Disabled</b>
Power On by PCIE Devices	Enables or disables to wake up the system from a power saving mode through an event on PCI Express device.	Enabled <b>Disabled</b>
Wake Up by PS/2 KB/Mouse	Enables or disables to wake up the system from a power saving mode using a PS2 keyboard or mouse.	<b>Enabled</b> Disabled
Wake Up by USB KB/Mouse	Enables or disables to wake up the system from a power saving mode using a USB keyboard or mouse.	<b>Enabled</b> Disabled
Restore On AC Power Loss	Enables or disables the system to reboot after a power failure or interrupt occurs.	Power Off Power On <b>Last State</b>

## PC Health Status

CMOS Setup Utility - Copyright © 1985-2010, American Megatrends, Inc.		
PC Health Status		
PC Health Status		Help Item
CPU Temperature (PECI Mode)	:23	Disabled
System Temperature	:44°C/111°F	Enabled
CPU Fan Speed	:1015 RPM	
System Fan Speed	:N/A	
CPU Core	:1.176 V	
+1.1V	:1.116 V	
+3.30V	:3.346 V	
+5.00V	:5.040 V	
+12.0V	:11.808 V	
5VSB	:5.040 V	
VBAT	:3.336 V	
Smart Fan	<b>[Enabled]</b>	

↑↓↔:Move      Enter:Select      +/-:Value      F10:Save      ESC:Exit  
 F1:General Help      F9:Optimized Defaults

Parameter	Description	Option
Smart Fan	Enables or disables the smart system fan control function.	<b>Enabled</b> Disabled

# Frequency/Voltage Control

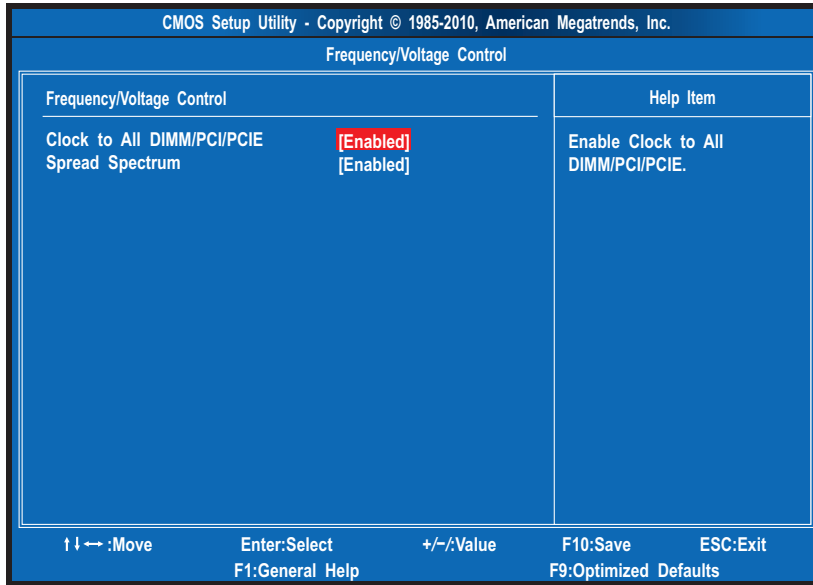

Parameter	Description	Option
Clock to All DIMM/PCI/PCIE	Enables or disables the system to detect the DIMM/PCI/PCIE clock automatically during bootup.	<b>Enabled</b> Disabled
Spread Spectrum	Enables or disables the reduction of the mainboard's EMI. <b>Note:</b> Remember to disable the Spread Spectrum feature if you are overclocking. A slight jitter can introduce a temporary boost in clock speed causing the overclocked processor to lock up.	<b>Enabled</b> Disabled

# BIOS Security Features

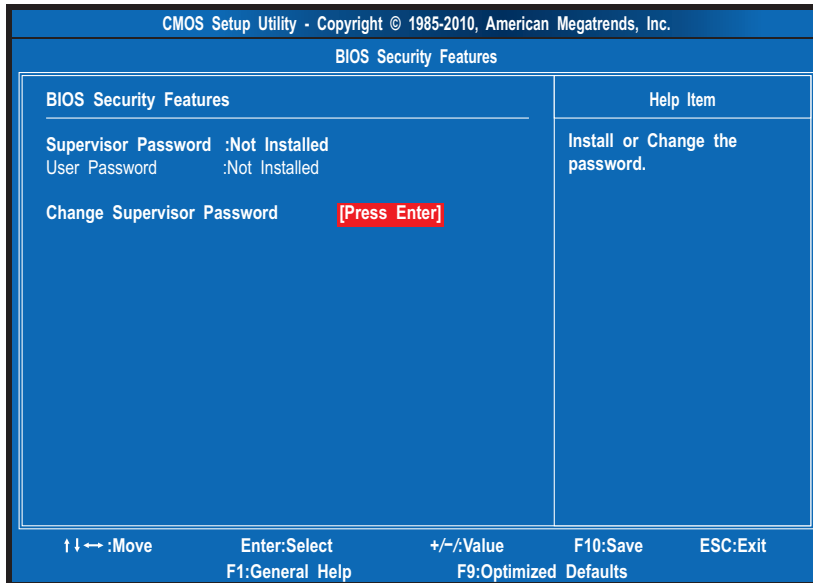

Parameter	Description
Supervisor Password	Indicates the status of the supervisor password.
User Password	Indicates the status of the user password.
Change Supervisor Password	Supervisor password prevents unauthorized access to the BIOS Setup Utility. Press <b>Enter</b> to change the Supervisor password.

## Setting a system password

1. Use the up/down arrow keys to select a password parameter (Change Supervisor Password) menu then press **Enter**.  
A password box will appear.
2. Type a password then press **Enter**.  
The password may consist up to six alphanumeric characters (A-Z, a-z, 0-9)
3. Retype the password to verify the first entry then press **Enter** again.
4. Press **F10**.
5. Select **Yes** to save the new password and close the Setup Utility.

## Changing the system password

1. Use the up/down arrow keys to select password parameter (Change Supervisor Password) menu then press **Enter**.
2. Type the original password then press **Enter**.
3. Type a new password then press **Enter**.
4. Retype the password to verify the first entry then press **Enter** again.
5. Press **F10**.
6. Select **Yes** to save the new password and close the Setup Utility.

---

## Removing a system password

1. Use the up/down arrow keys to select password parameter (Change Supervisor Password) menu then press **Enter**.
2. Enter the current password then press **Enter**.
3. Press **Enter** twice without entering anything in the password fields.

## Load Default Settings

The Load Default Settings menu allows you to load the default settings for all BIOS setup parameters. Setup defaults are quite demanding in terms of resources consumption. If you are using low-speed memory chips or other kinds of low-performance components and you choose to load these settings, the system might not function properly.

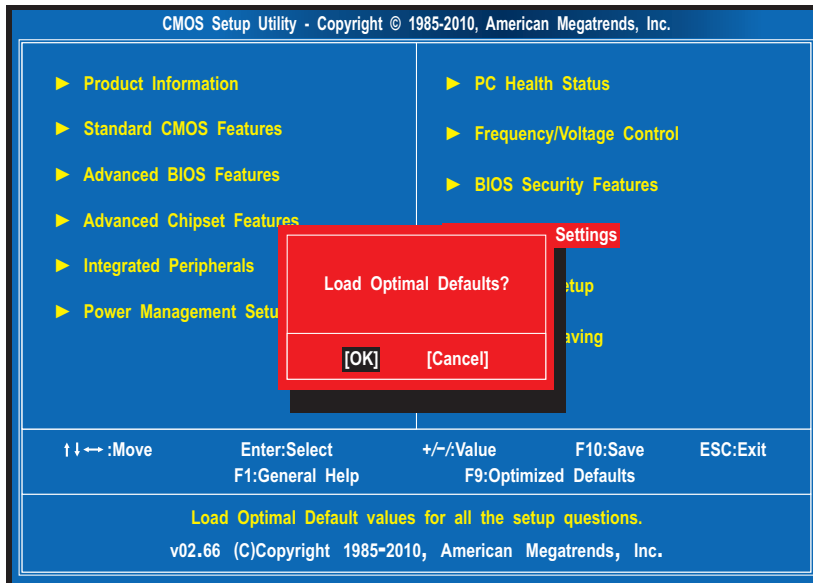

## Save & Exit Setup

The Save & Exit Setup menu allows you to save changes made and close the Setup Utility.

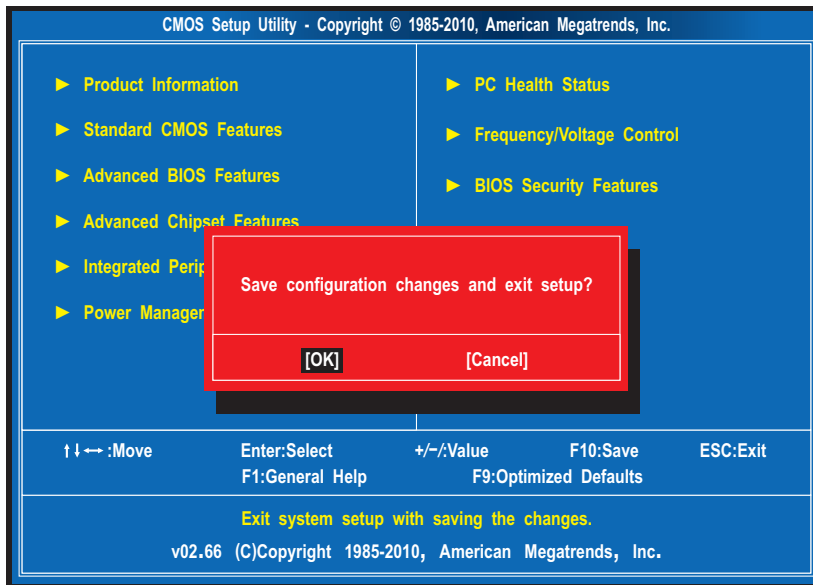

## Exit Without Saving

The Exit Without Saving menu allows you to discard changes made and close the Setup Utility.

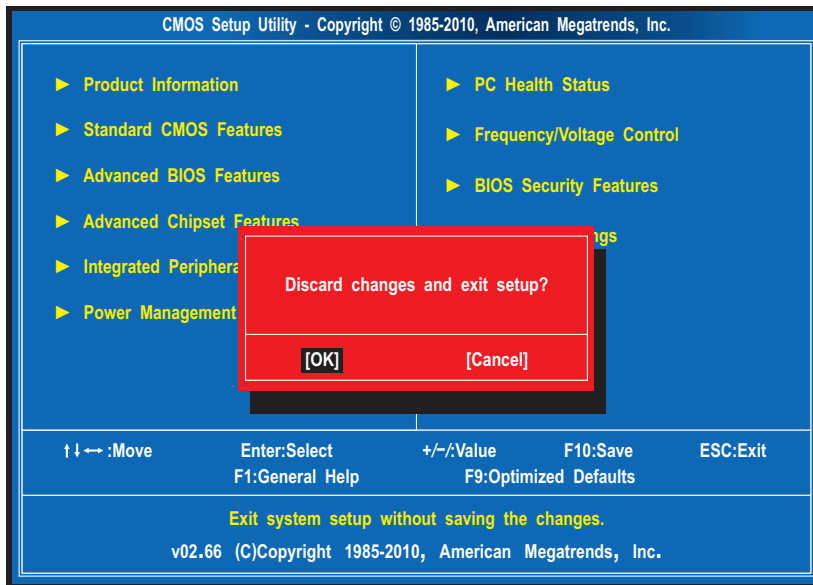



# System Disassembly

---

This chapter contains step-by-step procedures on how to disassemble the desktop computer for maintenance and troubleshooting.

## Disassembly Requirements

To disassemble the computer, you need the following tools:

- Wrist grounding strap and conductive mat for preventing electrostatic discharge
- Flat-blade screwdriver
- Philips screwdriver
- Hex screwdriver
- Plastic flat-blade screwdriver
- Plastic tweezers

**NOTE:** The screws for the different components vary in size. During the disassembly process, group the screws with the corresponding components to avoid mismatch when putting back the components.

---

# Pre-disassembly Procedure

Before proceeding with the disassembly procedure, perform the steps listed below:

1. Turn off the system and all the peripherals connected to it.
2. Unplug the power cord from the power outlets.
3. Unplug the power cord from the system.
4. Unplug all peripheral cables from the system.
5. Place the system unit on a flat, stable surface.

# Main Unit Disassembly

X3950 model

## MAIN UNIT DISASSEMBLY

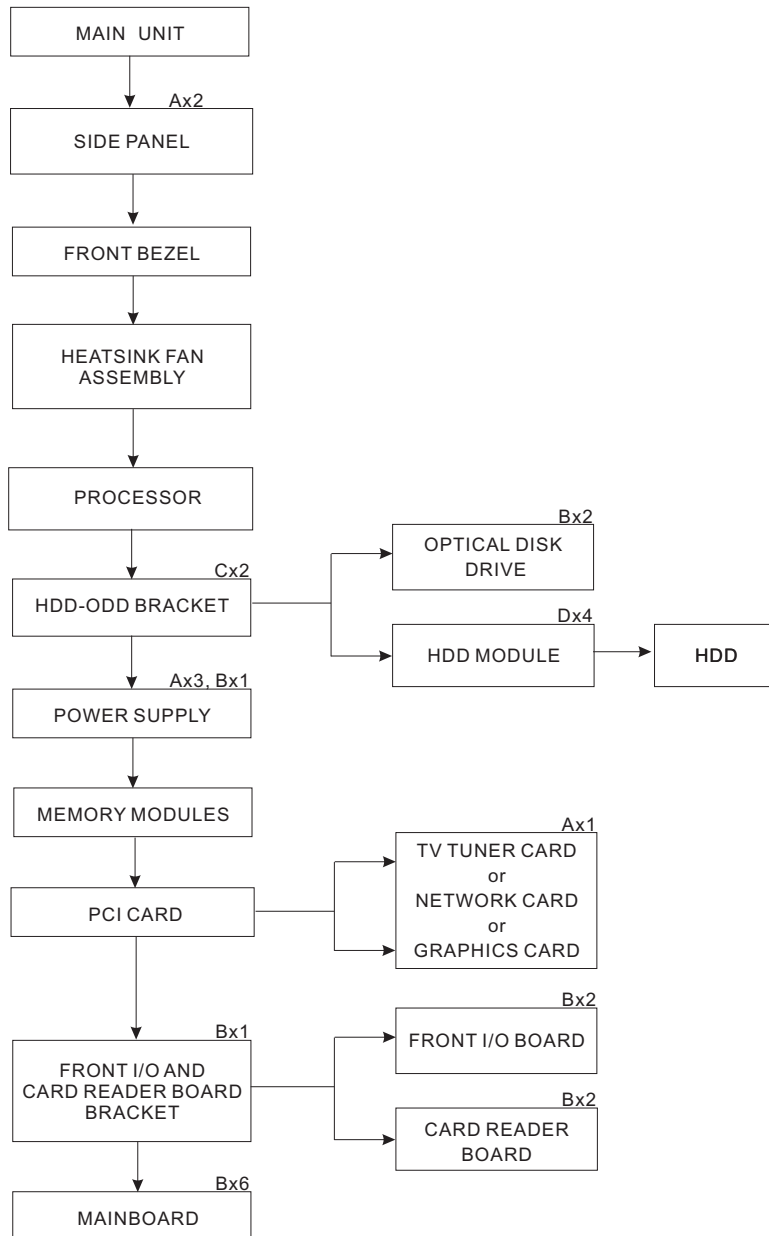

# X5950 model

## MAIN UNIT DISASSEMBLY

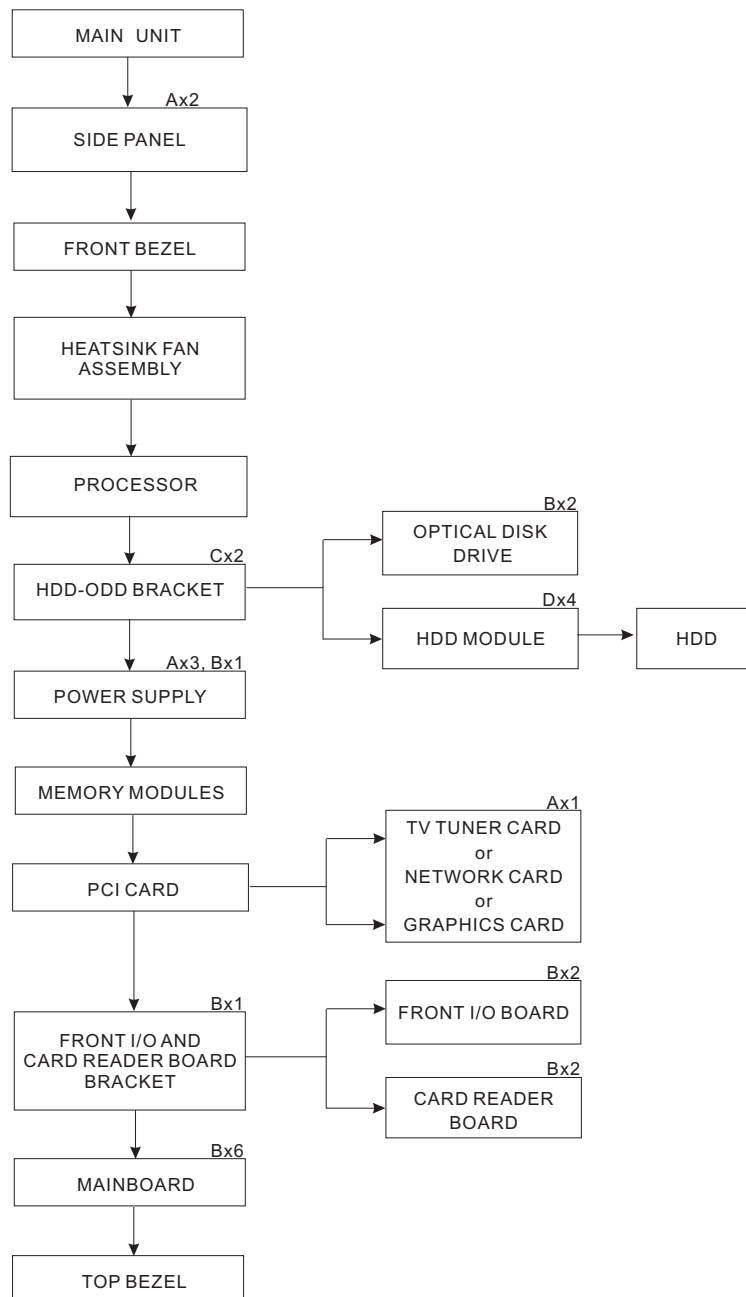

## Screw List

Code	Screw	Part No.
A	#6-32 L5 BZN	86.00J07.B60
B	#6-32 L6 NI	86.00J44.C60
C	M3xL5 BZN	86.1A324.5R0
D	#6-32*3/16 NI	86.5A5B6.012

# Removing the Side Panel

1. Perform the pre-disassembly procedure described on page 26.
2. Remove the two screws (A) located on the rear edge of the side panel.



X3950

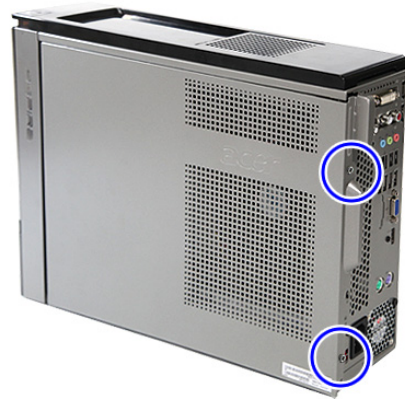

X5950

Screw (Quantity)	Color	Torque	Part No.
#6-32 L5 BZN (2)	Black	5.5 to 6.5 kgf-cm	86.00J07.B60

3. Slide the panel toward the back of the unit until the tabs on the cover disengage with the slots on the unit.
4. Lift the panel away from the unit and put it aside for reinstallation later.



X3950



X5950

## Removing the Front Bezel

1. Remove the side panel. Refer to the previous section for instructions.
2. Remove the front bezel according to machine model.

**NOTE:** To remove the X3950 model's front bezel, you must first release the tabs securing the front bezel and disconnect the LED cable, located under the front bezel, from the mainboard.

If the LED cable is secured in the retaining clip, you must remove the HDD-ODD bracket prior to removing the front bezel. To remove the HDD-ODD bracket, see page 36.

- (1). Release the front bezel retention tabs from the unit interior.
- (2). For the X3950 model, rotate the bezel, then proceed to the next step to remove the front bezel.  
For the X5950 model, pull the bezel off the unit.



X3950



X5950

(3). Disconnect the LED cable from the mainboard, then remove the bezel.

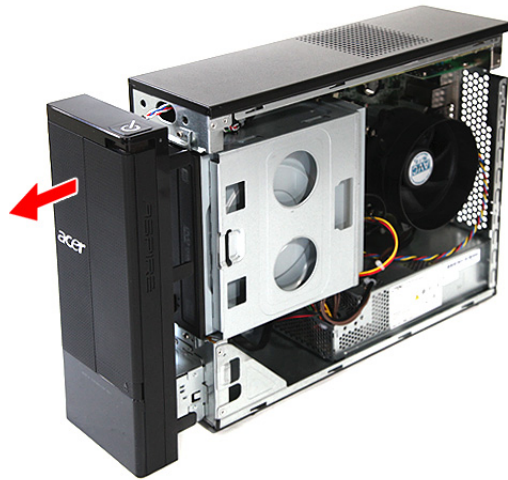

X3950

## Removing the Heatsink Fan Assembly

**WARNING:** The heatsink becomes very hot when the system is on. NEVER touch the heatsink with any metal or with your hands.

1. See “Removing the Side Panel” on page 29.
2. Use a long-nosed screwdriver to loosen the four screws on the heatsink fan assembly.

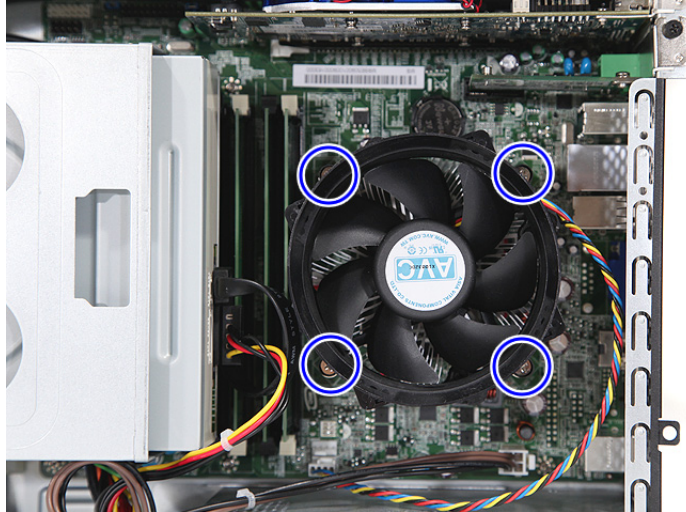

3. Lift the heatsink fan assembly off the mainboard.



X3950

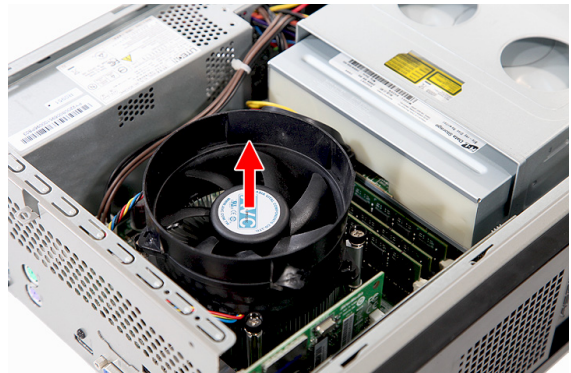

X5950



- 
4. Lay it down in an upright position—with the thermal patch facing upward, on top of the optical drive then disconnect the heatsink fan cable from its mainboard connector. Do not let the thermal patch on the heatsink fan assembly touch the work surface.

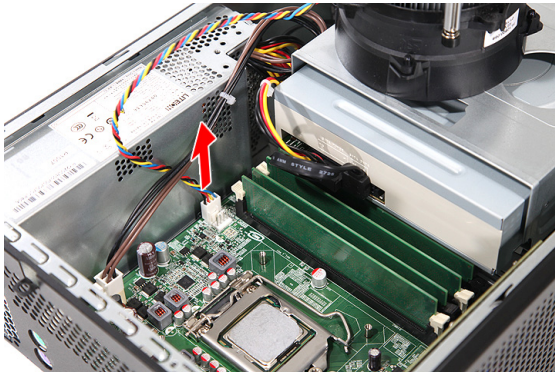

X3950

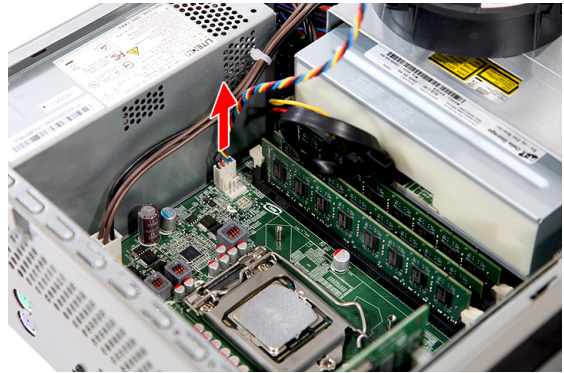

X5950

5. Use an alcohol pad to wipe off the thermal grease from both the heatsink and the processor.

---

## Removing the Processor

**IMPORTANT:** Before removing a processor from the mainboard, make sure to create a backup file of all important data.

**WARNING:** The processor becomes very hot when the system is on. Allow it to cool off first before handling.

1. See “Removing the Side Panel” on page 29.
2. See “Removing the Heatsink Fan Assembly” on page 32.
3. Press the load lever, then move it to the right to release the load lever from the retention tab.

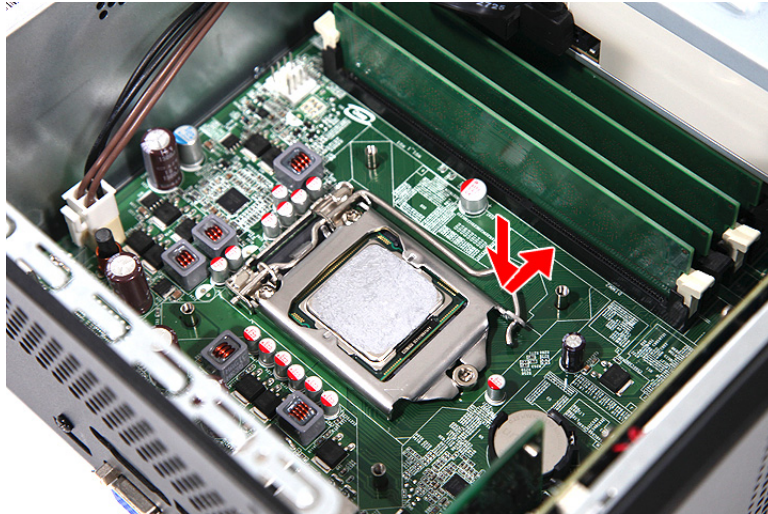

4. Pull the load lever to the fully open, upright position.

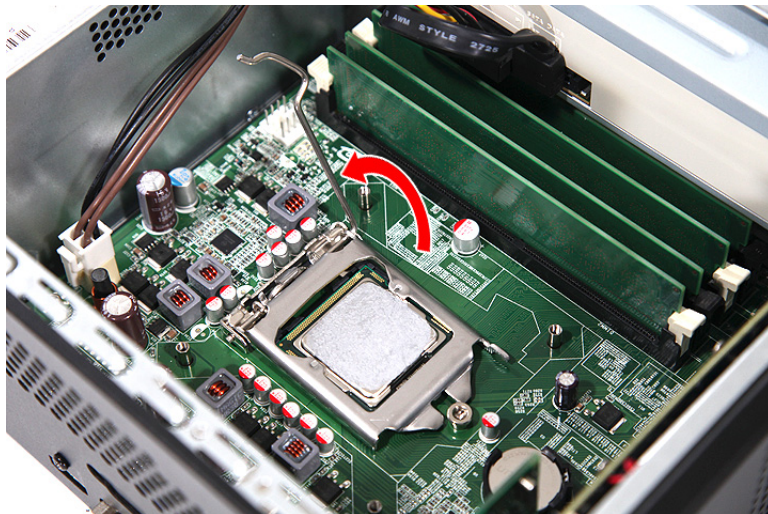

- 
5. Open the load plate, then pull out the processor from the socket.

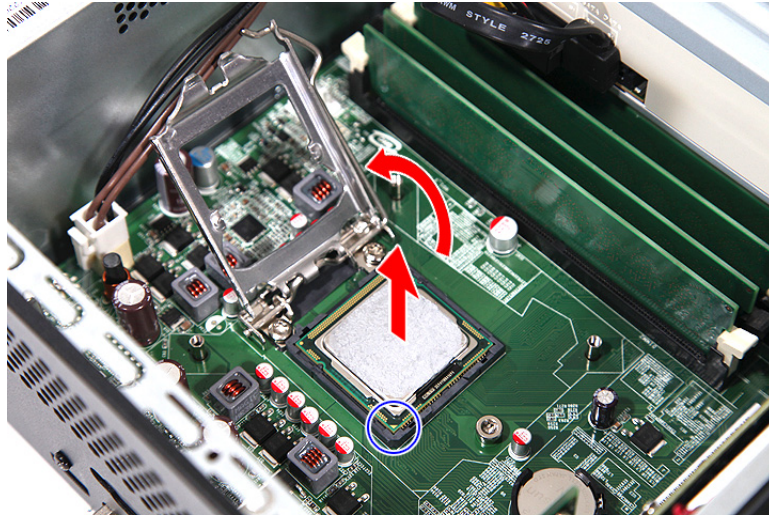

**IMPORTANT:** If you are going to install a new processor, note the arrow on the corner, highlighted with a circle in the photo above, to make sure the processor is properly oriented over the socket.

# Removing the Optical Drive

1. See “Removing the Side Panel” on page 29.
2. See “Removing the Front Bezel” on page 30.
3. Remove the HDD-ODD bracket.
  - (1). Disconnect the data and power cables from their optical drive connectors.

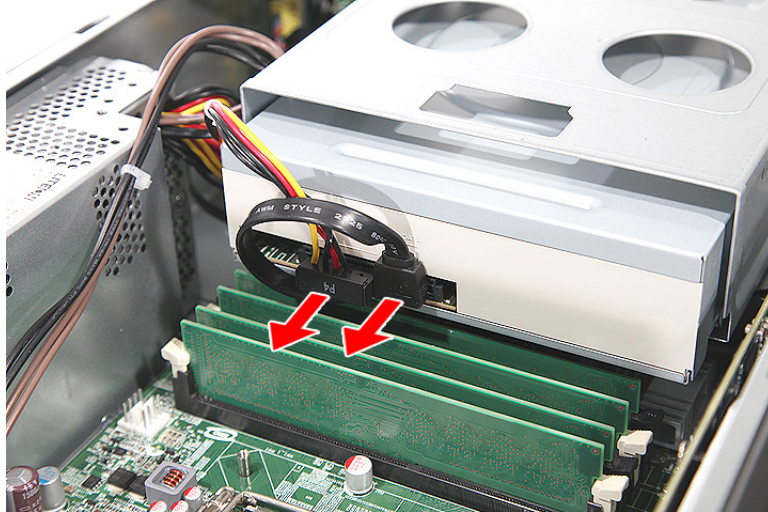

- (2). Remove the two screws (B) that secure the HDD-ODD bracket.



X3950

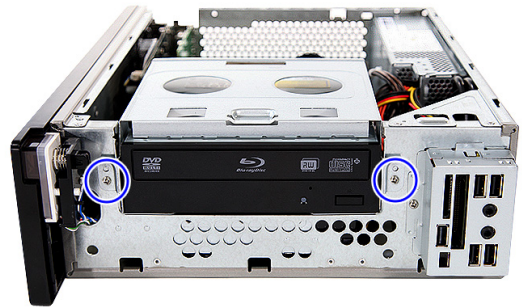

X5950

Screw (Quantity)	Color	Torque	Part No.
6-32 xL6 (2)	Silver	5.7 to 6.3 kgf-cm	86.00J44.C60

(3). Lift the HDD-ODD bracket, then disconnect the data and power cables from their HDD connector.

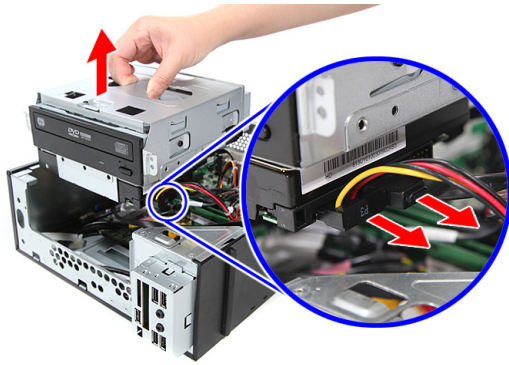

X3950

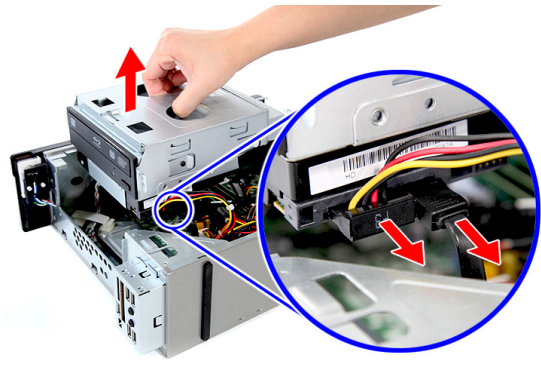

X5950

(4). If necessary, open the cable retention clips that secure the data cable, then disconnect the cables from their mainboard connectors.

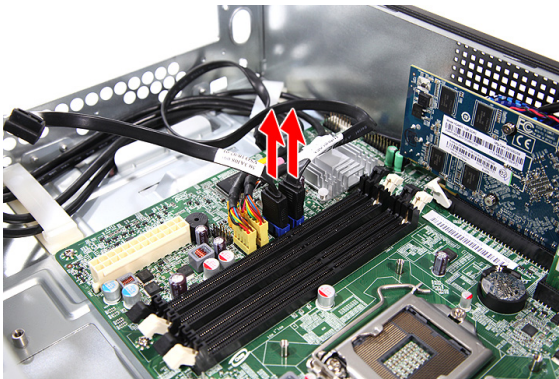

X3950

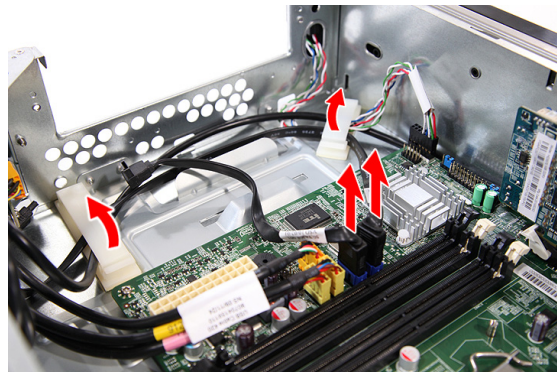

X5950

4. Remove the two screws (C) that secure the optical drive.



Screw (Quantity)	Color	Torque	Part No.
M3xL5 BZN (2)	Black	5.5 to 6.5 kgf-cm	86.1A324.5R0

- 
5. Slide the optical drive out of the bracket.



## Removing the Hard Disk Drive

1. See “Removing the Side Panel” on page 29.
2. See “Removing the Front Bezel” on page 30.
3. Remove the HDD-ODD bracket. See page 36.
  - (1). Place the bracket on a clean, static-free work surface.
  - (2). Remove the four screws (D) that secure the HDD module.

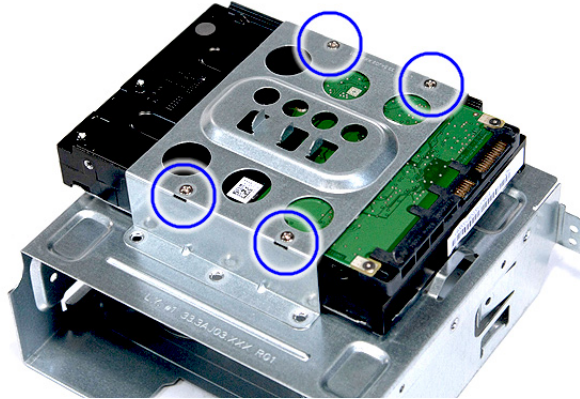

Screw (Quantity)	Color	Torque	Part No.
#6-32*3/16 NI (4)	Silver	5.7 to 6.3 kgf-cm	86.5A5B6.012

- (3). Slide the HDD out of the bracket.

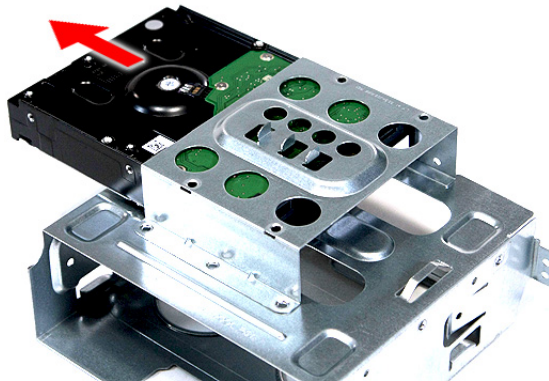

# Removing the Power Supply

1. See “Removing the Side Panel” on page 29.
2. See “Removing the Heatsink Fan Assembly” on page 32.
3. See “Removing the Processor” on page 34.
4. See “Remove the HDD-ODD bracket” on page 36.
5. Disconnect the power cables from their mainboard connectors.



6. Remove the screw (B) that secures the power supply .

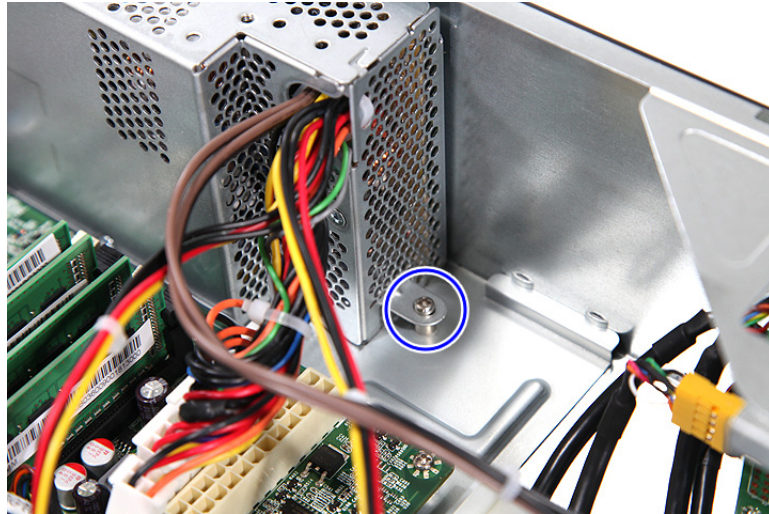

Screw (Quantity)	Color	Torque	Part No.
#6-32 L6 NI (1)	Silver	5.7 to 6.3 kgf-cm	86.00J44.C60



7. Remove the three screws (A) that secure the power supply module.

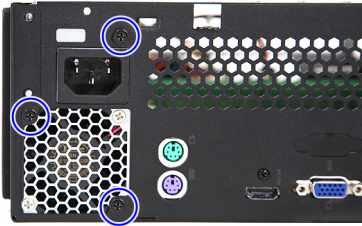

X3950

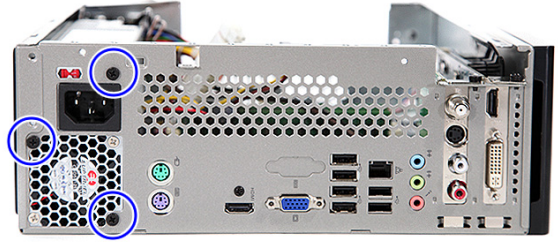

X5950

Screw (Quantity)	Color	Torque	Part No.
#6-32 L5 BZN (3)	Black	5.5 to 6.5 kgf-cm	86.00J07.B60

8. Lift the power supply module off the unit.



X3950

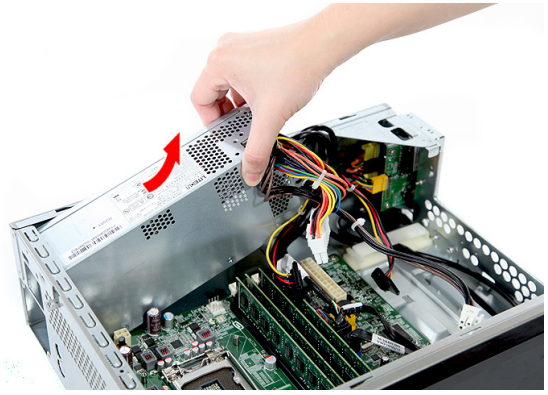

X5950

---

## Removing the Memory Modules

**IMPORTANT:** Before removing any DIMM, make sure to create a backup file of all important data.

1. See “Removing the Side Panel” on page 29.
2. See “Removing the Front Bezel” on page 30.
3. See “Remove the HDD-ODD bracket” on page 36.
4. Press the holding clips on both sides of the DIMM slot outward to release the DIMM.
5. Gently pull the DIMM upward to remove it from its slot.

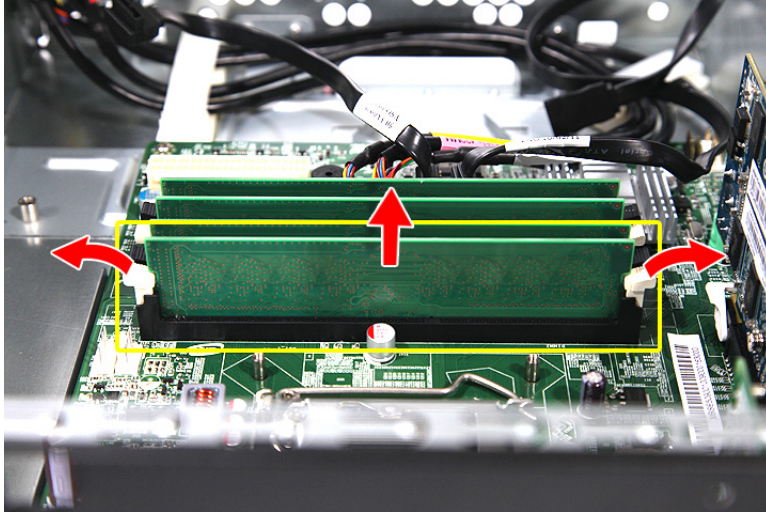

**NOTE:** The DIMM has been highlighted with a yellow rectangle as above image shows. Please detach the DIMM and follow local regulations for disposal.

- (4). Do the same to remove the other modules.

# Removing an Expansion Card

This section includes instruction on how to remove a network card, VGA card, and a TV tuner card.

## To remove a network card:

1. See “Removing the Side Panel” on page 29.
2. Remove the screw (A) that secures the card to the unit.

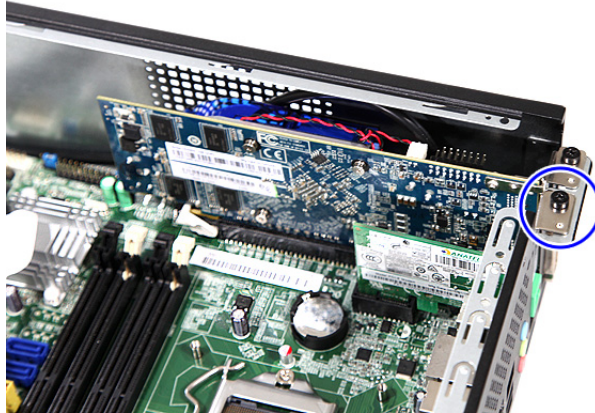

Screw (Quantity)	Color	Torque	Part No.
#6-32 L5 BZN (1)	Black	5.7 to 6.3 kgf-cm	86.00J07.B60

3. Pull the card out of its mainboard connector.

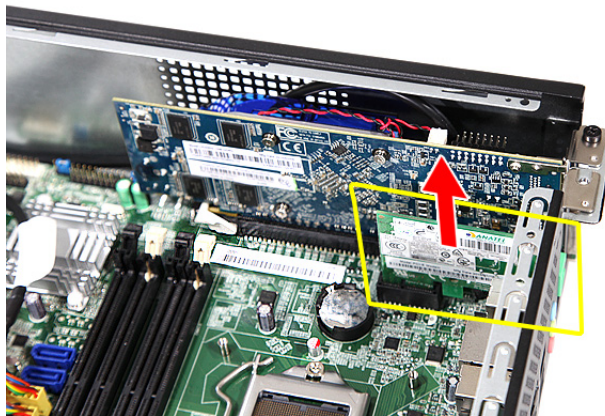

**NOTE:** The card has been highlighted with a yellow rectangle as above image shows. Please detach the card and follow local regulations for disposal.

## To remove a VGA card:

1. See “Removing the Side Panel” on page 29.
2. Remove the screw (A) that secures the card to the unit, then press down the securing tab on the slot.

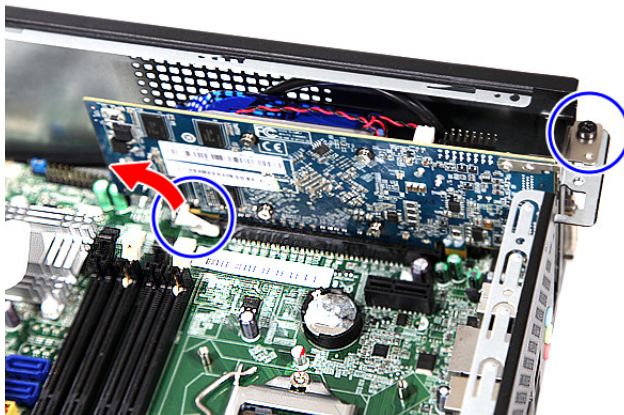

Screw (Quantity)	Color	Torque	Part No.
#6-32 L5 BZN (1)	Black	5.7 to 6.3 kgf-cm	86.00J07.B60

3. Pull the card out of its mainboard connector.

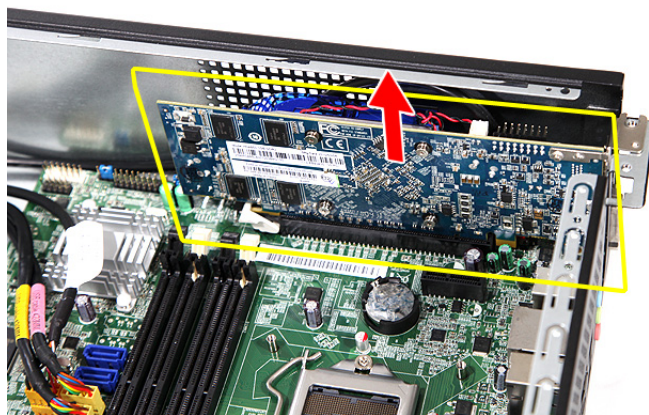

**NOTE:** The card has been highlighted with a yellow rectangle as above image shows. Please detach the card and follow local regulations for disposal.

## To remove a TV tuner card:

1. See "Removing the Side Panel" on page 29.
2. Remove the screw (A) that secures the card to the unit.



Screw (Quantity)	Color	Torque	Part No.
#6-32 L5 BZN (1)	Black	5.7 to 6.3 kgf-cm	86.00J07.B60

3. Pull the card out of its mainboard connector.

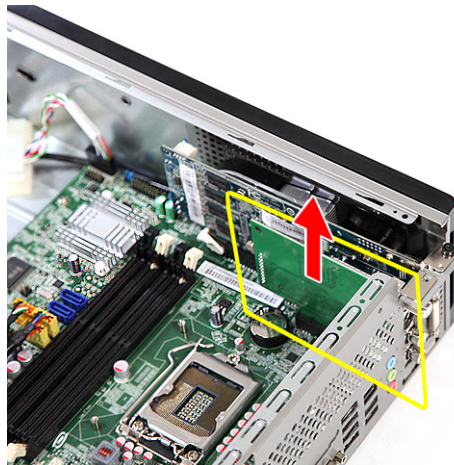

**NOTE:** The card has been highlighted with a yellow rectangle as above image shows. Please detach the card and follow local regulations for disposal.

## Removing the Front I/O and Card Reader Boards

1. See “Removing the Side Panel” on page 29.
2. See “Removing the Front Bezel” on page 30.
3. See “Remove the HDD-ODD bracket” on page 36.
4. Open the cable retention clips and disconnect the USB, 1394, and audio cables from their mainboard connectors.

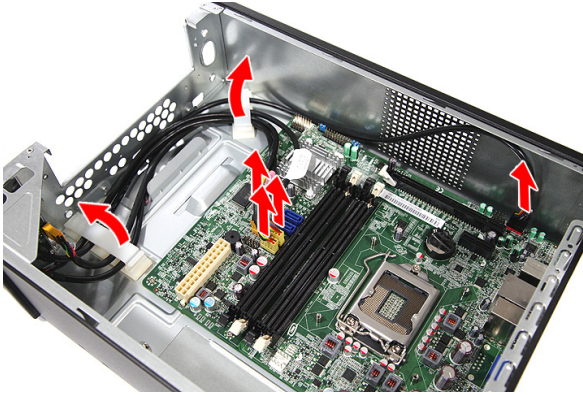

X3950

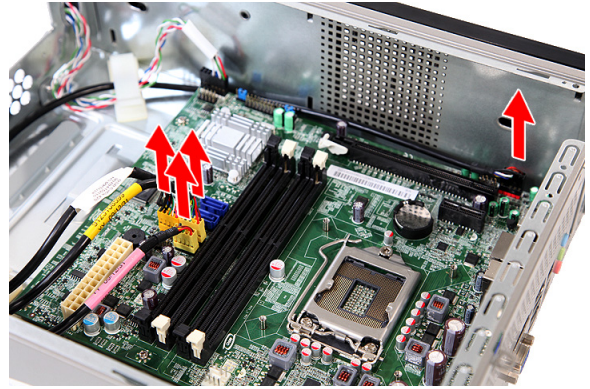

X5950

5. Remove the front I/O and card reader bracket.
  - (1). Remove the screw (B) that secures the bracket to the unit.



Screw (Quantity)	Color	Torque	Part No.
#6-32 L6 NI (1)	Silver	4.75 to 5.2 kgf-cm	86.00J44.C60

(2). Pull the bracket with the cables out of the unit, as shown.



6. Remove the card reader board.

(1). Remove the two screws (B) that secure the card reader board to the bracket.



Screw (Quantity)	Color	Torque	Part No.
#6-32 L6 NI (2)	Silver	3.5 to 4.5 kgf-cm	86.00J44.C60

(2). Pull the board out of the bracket.

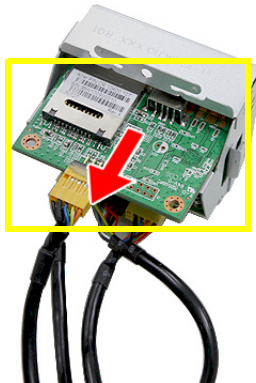

**NOTE:** The card has been highlighted with a yellow rectangle as above image shows. Please detach the card and follow local regulations for disposal.

7. Remove the front I/O board.

(1). Remove the two screws (B) that secure the I/O board to the bracket.



Screw (Quantity)	Color	Torque	Part No.
#6-32 L6 NI (2)	Silver	3.8 to 4.2 kgf-cm	86.00J44.C60

(2). Pull the I/O board out of the bracket.

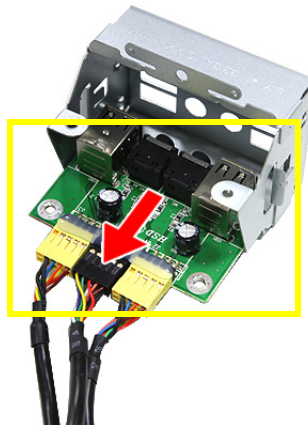

**NOTE:** The card has been highlighted with a yellow rectangle as above image shows. Please detach the card and follow local regulations for disposal.



# Removing the Mainboard

1. See “Removing the Side Panel” on page 29.
2. See “Removing the Front Bezel” on page 30.
3. See “Removing the Heatsink Fan Assembly” on page 32.
4. See “Removing the Processor” on page 34.
5. See “Remove the HDD-ODD bracket” on page 36.
6. See “Removing the Memory Modules” on page 42.
7. See “Removing an Expansion Card” on page 43.
8. See “Removing the Front I/O and Card Reader Boards” on page 46.
9. For the X5950 model, disconnect the LED cable from its mainboard connector before proceeding.
10. Remove the screw (C) on the rear panel.



X3950

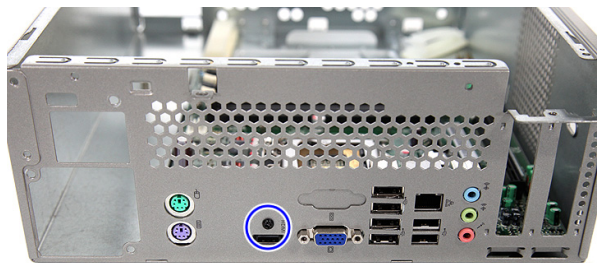

X5950

Screw (Quantity)	Color	Torque	Part No.
M3xL5 BZN (1)	Black	5.5 to 6.5 kgf-cm	86.1A324.5R0

11. Remove the six screws (B) that secure the mainboard to the housing.

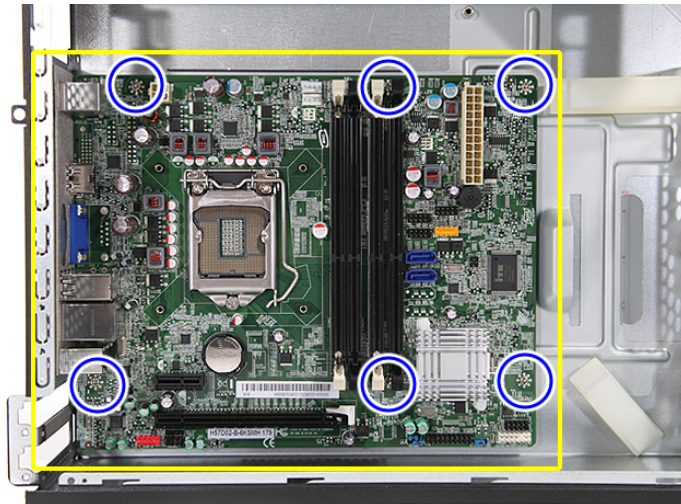

Screw (Quantity)	Color	Torque	Part No.
#6-32 L6 NI (6)	Silver	5.7 to 6.3 kgf-cm	86.00J44.C60



**NOTE:** The mainboard has been highlighted with a yellow rectangle as above image shows. Please detach the mainboard and follow local regulations for disposal.

---

12. Lift the board off the housing.



---

## Removing the Top Bezel

**NOTE:** The following instruction is applicable only to the X5950 model.

1. See “Removing the Side Panel” on page 29.
2. See “Removing the Front Bezel” on page 30.
3. Detach the LED cable from its mainboard connector.

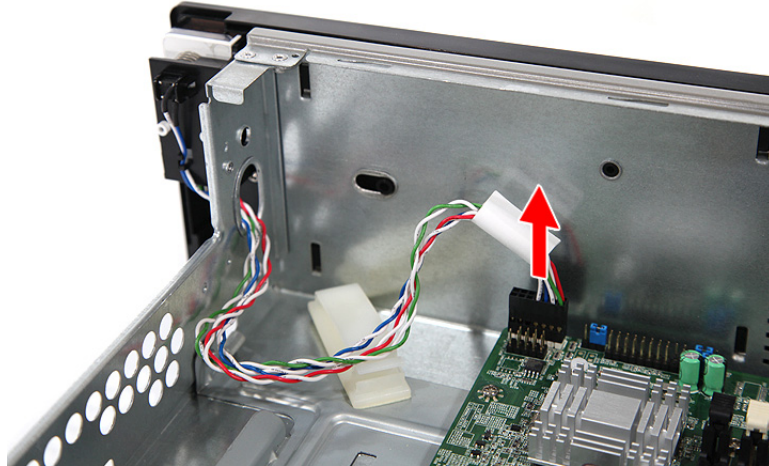

4. Insert the cable into the hole on the housing, as shown.



5. Slide the bezel toward the front, then lift the bezel off the housing.





# System Troubleshooting

---

This chapter provides instructions on how to troubleshoot system hardware problems.

## Hardware Diagnostic Procedure

**IMPORTANT:** The diagnostic tests described in this chapter are only intended to test Acer products. Non-Acer products, prototype cards, or modified options can give false errors and invalid system responses.

1. Obtain the failing symptoms in as much detail as possible.
2. Verify the symptoms by attempting to recreate the failure by running the diagnostic tests or repeating the same operation.
3. Refer to the following sections to determine which corrective action to perform.
  - System Check Procedures
  - Checkpoints
  - Error Messages
  - Undetermined Problems

---

# System Check Procedures

## Power System Check

If the system will power on, skip this section. Refer to System External Inspection.

If the system will not power on, do the following:

- Check if the power cable is properly connected to the system and AC source.
- Check if the voltage selector switch is set to the correct voltage setting.

## System External Inspection

1. Inspect the LED indicators on the front panel, which can indicate the malfunction. For the LED locations and description of their behaviour, see “System LED Indicators” on page 7.
2. Make sure that air flow is not blocked.
3. Make sure nothing in the system is making contact that could short out power.
4. If the problem is not evident, continue with System Internal Inspection.

## System Internal Inspection

1. Turn off the system and all the peripherals connected to it.
2. Unplug the power cord from the power outlets.
3. Unplug the power cord from the system.
4. Unplug all peripheral cables from the system.
5. Place the system unit on a flat, stable surface.
6. Remove the system covers. For instructions on removing system covers, refer to “System Disassembly” on page 25.
7. Verify that components are properly seated.
8. Verify that all cable connectors inside the system are firmly and correctly attached to their appropriate connectors.
9. Verify that all components are Acer-qualified and supported.
10. Replace the system covers.
11. Power on the system.
12. If the problem with the system is not evident, you can try viewing the POST messages and BIOS event logs during the system startup.

---

# Checkpoints

A checkpoint is either a byte or word value output to I/O port 80h. The BIOS outputs checkpoints throughout bootblock and Power-On Self Test (POST) to indicate the task the system is currently executing. Checkpoints are very useful in aiding software developers or technicians in debugging problems that occur during the pre-boot process.

## Viewing BIOS checkpoints

Viewing all checkpoints generated by the BIOS requires a checkpoint card, also referred to as a POST card or POST diagnostic card. These are ISA or PCI add-in cards that show the value of I/O port 80h on a LED display. Checkpoints may appear on the bottom right corner of the screen during POST. This display method is limited, since it only displays checkpoints that occur after the video card has been activated.

## Bootblock Initialization Code Checkpoints

The Bootblock initialization code sets up the chipset, memory, and other components before system memory is available. The following table describes the type of checkpoints that may occur during the bootblock initialization portion of the BIOS.

**NOTE:** Please note that checkpoints may differ between different platforms based on system configuration. Checkpoints may change due to vendor requirements, system chipset or option ROMs from add-in PCI devices.

Checkpoint	Description
Before D1	Early chipset initialization is done. Early super I/O initialization is done including RTC and keyboard controller. NMI is disabled.
D1	Perform keyboard controller BAT test. Check if waking up from power management suspend state. Save power-on CPUID value in scratch CMOS.
D0	Go to flat mode with 4GB limit and GA20 enabled. Verify the bootblock checksum.
D2	Disable CACHE before memory detection. Execute full memory sizing module. Verify that flat mode is enabled.
D3	If memory sizing module not executed, start memory refresh and do memory sizing in Bootblock code. Do additional chipset initialization. Re-enable CACHE. Verify that flat mode is enabled.
D4	Test base 512KB memory. Adjust policies and cache first 8MB. Set stack.
D5	Bootblock code is copied from ROM to lower system memory and control is given to it. BIOS now executes out of RAM.
D6	Both key sequence and OEM specific method is checked to determine if "BIOS Recovery" is forced. Main BIOS checksum is tested. If "BIOS Recovery" is necessary, control flows to checkpoint E0. See Bootblock Recovery Code Checkpoints section for more information.
D7	Restore CPUID value back into register. The Bootblock-Runtime interface module is moved to system memory and control is given to it. Determine whether to execute serial flash.
D8	The Runtime module is uncompressed into memory. CPUID information is stored in memory.
D9	Store the Uncompressed pointer for future use in PMM. Copying Main BIOS into memory. Leaves all RAM below 1MB Read-Write including E000 and F000 shadow areas but closing SMRAM.
DA	Restore CPUID value back into register. Give control to BIOS POST (ExecutePOSTKernel). See POST Code Checkpoints section for more information.
E1-E8 EC-EE	OEM memory detection/configuration error. This range is reserved for chipset vendors and system manufacturers. The error associated with this value may be different from one platform to the next.

---

## Bootblock Recovery Code Checkpoints

The Bootblock recovery code gets control when the BIOS determines that a “BIOS Recovery” needs to occur because the user has forced the update or the BIOS checksum is corrupt. Refer to “BIOS Recovery” on page 72 for more information about performing a “BIOS Recovery” .

The following table describes the type of checkpoints that may occur during the Bootblock recovery portion of the BIOS.

**NOTE:** Checkpoints may differ between different platforms based on system configuration. Checkpoints may change due to vendor requirements, system chipset or option ROMs from add-in PCI devices.

Checkpoint	Description
E0	Initialize the floppy controller in the super I/O. Some interrupt vectors are initialized. DMA controller is initialized. 8259 interrupt controller is initialized. L1 cache is enabled.
E9	Set up floppy controller and data. Attempt to read from floppy.
EA	Enable ATAPI hardware. Attempt to read from ARMD and ATAPI CDROM.
EB	Disable ATAPI hardware. Jump back to checkpoint E9.
EF	Read error occurred on media. Jump back to checkpoint EB.
F0	Search for pre-defined recovery file name in root directory.
F1	Recovery file not found.
F2	Start reading FAT table and analyze FAT to find the clusters occupied by the recovery file.
F3	Start reading the recovery file cluster by cluster.
F5	Disable L1 cache.
FA	Check the validity of the recovery file configuration to the current configuration of the flash part.
FB	Make flash write enabled through chipset and OEM specific method. Detect proper flash part. Verify that the found flash part size equals the recovery file size.
F4	The recovery file size does not equal the found flash part size.
FC	Erase the flash part.
FD	Program the flash part.
FF	The flash has been updated successfully. Make flash write disabled. Disable ATAPI hardware. Restore CPUID value back into register. Give control to F000 ROM at F000:FFF0h.



# POST Code Checkpoints

The POST code checkpoints are the largest set of checkpoints during the BIOS preboot process. The following table describes the type of checkpoints that may occur during the POST portion of the BIOS.

**NOTE:** Please note that checkpoints may differ between different platforms based on system configuration. Checkpoints may change due to vendor requirements, system chipset or option ROMs from add-in PCI devices.

Checkpoint	Description
03	Disable NMI, Parity, video for EGA, and DMA controllers. Initialize BIOS, POST, Runtime data area. Also initialize BIOS modules on POST entry and GPNV area. Initialized CMOS as mentioned in the Kernel Variable "wCMOSFlags."
04	Check CMOS diagnostic byte to determine if battery power is OK and CMOS checksum is OK. Verify CMOS checksum manually by reading storage area. If the CMOS checksum is bad, update CMOS with power-on default values and clear passwords. Initialize status register A. Initializes data variables that are based on CMOS setup questions. Initializes both the 8259 compatible PICs in the system
05	Initializes the interrupt controlling hardware (generally PIC) and interrupt vector table.
06	Do R/W test to CH-2 count reg. Initialize CH-0 as system timer. Install the POSTINT1Ch handler. Enable IRQ-0 in PIC for system timer interrupt. Traps INT1Ch vector to "POSTINT1ChHandlerBlock."
07	Fixes CPU POST interface calling pointer.
08	Initializes the CPU. The BAT test is being done on KBC. Program the keyboard controller command byte is being done after Auto detection of KB/MS using AMI KB-5.
C0	Early CPU Init Start -- Disable Cache – Init Local APIC
C1	Set up boot strap processor Information
C2	Set up boot strap processor for POST
C5	Enumerate and set up application processors
C6	Re-enable cache for boot strap processor
C7	Early CPU Init Exit
0A	Initializes the 8042 compatible Key Board Controller.
0B	Detects the presence of PS/2 mouse.
0C	Detects the presence of Keyboard in KBC port.
0E	Testing and initialization of different Input Devices. Also, update the Kernel Variables. Traps the INT09h vector, so that the POST INT09h handler gets control for IRQ1. Uncompress all available language, BIOS logo, and Silent logo modules.
13	Early POST initialization of chipset registers.
24	Uncompress and initialize any platform specific BIOS modules. GPNV is initialized at this checkpoint.
30	Initialize System Management Interrupt.
2A	Initializes different devices through DIM. See DIM Code Checkpoints section for more information.
2C	Initializes different devices. Detects and initializes the video adapter installed in the system that have optional ROMs.
2E	Initializes all the output devices.

Checkpoint	Description
31	Allocate memory for ADM module and uncompress it. Give control to ADM module for initialization. Initialize language and font modules for ADM. Activate ADM module.
33	Initializes the silent boot module. Set the window for displaying text information.
37	Displaying sign-on message, CPU information, setup key message, and any OEM specific information.
38	Initializes different devices through DIM. See DIM Code Checkpoints section for more information. USB controllers are initialized at this point.
39	Initializes DMAC-1 & DMAC-2.
3A	Initialize RTC date/time.
3B	Test for total memory installed in the system. Also, Check for DEL or ESC keys to limit memory test. Display total memory in the system.
3C	Mid POST initialization of chipset registers.
40	Detect different devices (Parallel ports, serial ports, and coprocessor in CPU, ... etc.) successfully installed in the system and update the BDA, EBDA...etc.
50	Programming the memory hole or any kind of implementation that needs an adjustment in system RAM size if needed.
52	Updates CMOS memory size from memory found in memory test. Allocates memory for Extended BIOS Data Area from base memory. Programming the memory hole or any kind of implementation that needs an adjustment in system RAM size if needed.
60	Initializes NUM-LOCK status and programs the KBD typematic rate.
75	Initialize Int-13 and prepare for IPL detection.
78	Initializes IPL devices controlled by BIOS and option ROMs.
7A	Initializes remaining option ROMs.
7C	Generate and write contents of ESCD in NVRam.
84	Log errors encountered during POST.
85	Display errors to the user and gets the user response for error.
87	Execute BIOS setup if needed / requested. Check boot password if installed.
8C	Late POST initialization of chipset registers.
8D	Build ACPI tables (if ACPI is supported)
8E	Program the peripheral parameters. Enable/Disable NMI as selected.
90	Late POST initialization of system management interrupt.
A0	Check boot password if installed.
A1	Clean-up work needed before booting to OS.
A2	Takes care of runtime image preparation for different BIOS modules. Fill the free area in F000h segment with 0FFh. Initializes the Microsoft IRQ Routing Table. Prepares the runtime language module. Disables the system configuration display if needed.
A4	Initialize runtime language module. Display boot option popup menu.
A7	Displays the system configuration screen if enabled. Initialize the CPU's before boot, which includes the programming of the MTRR's.
A8	Prepare CPU for OS boot including final MTRR values.
A9	Wait for user input at config display if needed.
AA	Uninstall POST INT1Ch vector and INT09h vector. Deinitializes the ADM module.
AB	Prepare BBS for Int 19 boot.
AC	End of POST initialization of chipset registers.

Checkpoint	Description
B1	Save system context for ACPI.
00	Passes control to OS Loader (typically INT19h).
61-70	OEM POST Error. This range is reserved for chipset vendors and system manufacturers. The error associated with this value may be different from one platform to the next.

## DIM Code Checkpoints

The Device Initialization Manager (DIM) gets control at various times during BIOS POST to initialize different system busses. The following table describes the main checkpoints where the DIM module is accessed.

**NOTE:** Checkpoints may differ between different platforms based on system configuration. Checkpoints may change due to vendor requirements, system chipset or option ROMs from add-in PCI devices.

Checkpoint	Description
2A	Initialize different buses and perform the following functions: Reset, Detect, and Disable (function 0); Static Device Initialization (function 1); Boot Output Device Initialization (function 2). Function 0 disables all device nodes, PCI devices, and PnP ISA cards. It also assigns PCI bus numbers. Function 1 initializes all static devices that include manual configured onboard peripherals, memory and I/O decode windows in PCI-PCI bridges, and noncompliant PCI devices. Static resources are also reserved. Function 2 searches for and initializes any PnP, PCI, or AGP video devices.
38	Initialize different buses and perform the following functions: Boot Input Device Initialization (function 3); IPL Device Initialization (function 4); General Device Initialization (function 5). Function 3 searches for and configures PCI input devices and detects if system has standard keyboard controller. Function 4 searches for and configures all PnP and PCI boot devices. Function 5 configures all onboard peripherals that are set to an automatic configuration and configures all remaining PnP and PCI devices.

## ACPI Runtime Checkpoints

Checkpoint	Description
AC	First ASL check point. Indicates the system is running in ACPI mode.
AA	System is running in APIC mode
01, 02, 03, 04, 05	Entering sleep state S1, S2, S3, S4, or S5.
10, 20, 30, 40, 50	Waking from sleep state S1, S2, S3, S4, or S5

# Error Messages

The following tables describes the error messages that may appear during POST. Each message is listed with a detailed description of the error.

## Memory

Message Displayed	Description
Gate20 Error	The BIOS is unable to properly control the mainboard's Gate A20 function, which controls access of memory over 1 MB. This may indicate a problem with the mainboard.
Multi-Bit ECC Error	This message will only occur on systems using ECC enabled memory modules. ECC memory has the ability to correct single-bit errors that may occur from faulty memory modules. A multiple bit corruption of memory has occurred, and the ECC memory algorithm cannot correct it. This may indicate a defective memory module.
Parity Error	Fatal Memory Parity Error. System halts after displaying this message.
RAM R/W test failed	This message is displayed by the AMIBIOS8 when the RAM read/write test fails.
CMOS Memory Size Wrong	The base memory (memory below 1MB) size that is reported in the CMOS (offset 15h) mismatches with the actual size detected. This condition may occur when the hole is set at 512K base memory or when CMOS is corrupted.

## Boot

Message Displayed	Description
Boot Failure ...	This is a generic message indicating the BIOS could not boot from a particular device. This message is usually followed by other information concerning the device.
Invalid Boot Diskette	A diskette was found in the drive, but it is not configured as a bootable diskette.
Drive Not Ready	The BIOS was unable to access the drive because it indicated it was not ready for data transfer. This is often reported by drives when no media is present.
A: Drive Error	The BIOS attempted to configure the A: drive during POST, but was unable to properly configure the device. This may be due to a bad cable or faulty diskette drive.
B: Drive Error	The BIOS attempted to configure the B: drive during POST, but was unable to properly configure the device. This may be due to a bad cable or faulty diskette drive.
Insert BOOT diskette in A:	The BIOS attempted to boot from the A: drive, but could not find a proper boot diskette. Reboot and Select proper Boot device or Insert Boot Media in selected Boot device BIOS could not find a bootable device in the system and/or removable media drive does not contain media.
Reboot and Select proper Boot device or Insert Boot Media in selected Boot device	BIOS could not find a bootable device in the system and/or removable media drive does not contain media.
NO ROM BASIC	This message occurs on some systems when no bootable device can be detected.

## Storage Device

Message Displayed	Description
Primary Master Hard Disk Error	The IDE/ATAPI device configured as Primary Master could not be properly initialized by the BIOS. This message is typically displayed when the BIOS is trying to detect and configure IDE/ATAPI devices in POST.
Primary Slave Hard Disk Error	The IDE/ATAPI device configured as Primary Slave could not be properly initialized by the BIOS. This message is typically displayed when the BIOS is trying to detect and configure IDE/ATAPI devices in POST.
Secondary Master Hard Disk Error	The IDE/ATAPI device configured as Secondary Master could not be properly initialized by the BIOS. This message is typically displayed when the BIOS is trying to detect and configure IDE/ATAPI devices in POST.
Secondary Slave Hard Disk Error	The IDE/ATAPI device configured as Secondary Slave could not be properly initialized by the BIOS. This message is typically displayed when the BIOS is trying to detect and configure IDE/ATAPI devices in POST.
3rd Master Hard Disk Error	The IDE/ATAPI device configured as Master in the 3rd IDE controller could not be properly initialized by the BIOS. This message is typically displayed when the BIOS is trying to detect and configure IDE/ATAPI devices in POST.
3rd Slave Hard Disk Error	The IDE/ATAPI device configured as Slave in the 3rd IDE controller could not be properly initialized by the BIOS. This message is typically displayed when the BIOS is trying to detect and configure IDE/ATAPI devices in POST.
4th Master Hard Disk Error	The IDE/ATAPI device configured as Master in the 4th IDE controller could not be properly initialized by the BIOS. This message is typically displayed when the BIOS is trying to detect and configure IDE/ATAPI devices in POST.
4th Slave Hard Disk Error	The IDE/ATAPI device configured as Slave in the 4th IDE controller could not be properly initialized by the BIOS. This message is typically displayed when the BIOS is trying to detect and configure IDE/ATAPI devices in POST.
5th Master Hard Disk Error	The IDE/ATAPI device configured as Master in the 5th IDE controller could not be properly initialized by the BIOS. This message is typically displayed when the BIOS is trying to detect and configure IDE/ATAPI devices in POST.
5th Slave Hard Disk Error	The IDE/ATAPI device configured as Slave in the 5th IDE controller could not be properly initialized by the BIOS. This message is typically displayed when the BIOS is trying to detect and configure IDE/ATAPI devices in POST.
6th Master Hard Disk Error	The IDE/ATAPI device configured as Master in the 6th IDE controller could not be properly initialized by the BIOS. This message is typically displayed when the BIOS is trying to detect and configure IDE/ATAPI devices in POST.
6th Slave Hard Disk Error	The IDE/ATAPI device configured as Slave in the 6th IDE controller could not be properly initialized by the BIOS. This message is typically displayed when the BIOS is trying to detect and configure IDE/ATAPI devices in POST.
Primary Master Drive - ATAPI Incompatible	The IDE/ATAPI device configured as Primary Master failed an ATAPI compatibility test. This message is typically displayed when the BIOS is trying to detect and configure IDE/ATAPI devices in POST.
Primary Slave Drive - ATAPI Incompatible	The IDE/ATAPI device configured as Primary Slave failed an ATAPI compatibility test. This message is typically displayed when the BIOS is trying to detect and configure IDE/ATAPI devices in POST.
Secondary Master Drive - ATAPI Incompatible	The IDE/ATAPI device configured as Secondary Master failed an ATAPI compatibility test. This message is typically displayed when the BIOS is trying to detect and configure IDE/ATAPI devices in POST.
Secondary Slave Drive - ATAPI Incompatible	The IDE/ATAPI device configured as Secondary Slave failed an ATAPI compatibility test. This message is typically displayed when the BIOS is trying to detect and configure IDE/ATAPI devices in POST.
3rd Master Drive - ATAPI Incompatible	The IDE/ATAPI device configured as Master in the 3rd IDE controller failed an ATAPI compatibility test. This message is typically displayed when the BIOS is trying to detect and configure IDE/ATAPI devices in POST.

Message Displayed	Description
3rd Slave Drive - ATAPI Incompatible	The IDE/ATAPI device configured as Slave in the 3rd IDE controller failed an ATAPI compatibility test. This message is typically displayed when the BIOS is trying to detect and configure IDE/ATAPI devices in POST.
4th Master Drive - ATAPI Incompatible	The IDE/ATAPI device configured as Master in the 4th IDE controller failed an ATAPI compatibility test. This message is typically displayed when the BIOS is trying to detect and configure IDE/ATAPI devices in POST.
4th Slave Drive - ATAPI Incompatible	The IDE/ATAPI device configured as Slave in the 4th IDE controller failed an ATAPI compatibility test. This message is typically displayed when the BIOS is trying to detect and configure IDE/ATAPI devices in POST.
5th Master Drive - ATAPI Incompatible	The IDE/ATAPI device configured as Master in the 5th IDE controller failed an ATAPI compatibility test. This message is typically displayed when the BIOS is trying to detect and configure IDE/ATAPI devices in POST.
5th Slave Drive - ATAPI Incompatible	The IDE/ATAPI device configured as Slave in the 5th IDE controller failed an ATAPI compatibility test. This message is typically displayed when the BIOS is trying to detect and configure IDE/ATAPI devices in POST.
6th Master Drive - ATAPI Incompatible	The IDE/ATAPI device configured as Master in the 6th IDE controller failed an ATAPI compatibility test. This message is typically displayed when the BIOS is trying to detect and configure IDE/ATAPI devices in POST.
6th Slave Drive - ATAPI Incompatible	The IDE/ATAPI device configured as Slave in the 6th IDE controller failed an ATAPI compatibility test. This message is typically displayed when the BIOS is trying to detect and configure IDE/ATAPI devices in POST.
S.M.A.R.T. Capable but Command Failed	The BIOS tried to send a S.M.A.R.T. message to a hard disk, but the command transaction failed. This message can be reported by an ATAPI device using the S.M.A.R.T. error reporting standard. S.M.A.R.T. failure messages may indicate the need to replace the hard disk.
S.M.A.R.T. Command Failed	The BIOS tried to send a S.M.A.R.T. message to a hard disk, but the command transaction failed. This message can be reported by an ATAPI device using the S.M.A.R.T. error reporting standard. S.M.A.R.T. failure messages may indicate the need to replace the hard disk.
S.M.A.R.T. Status BAD, Backup and Replace	A S.M.A.R.T. capable hard disk sends this message when it detects an imminent failure. This message can be reported by an ATAPI device using the S.M.A.R.T. error reporting standard. S.M.A.R.T. failure messages may indicate the need to replace the hard disk.
S.M.A.R.T. Capable and Status BAD	A S.M.A.R.T. capable hard disk sends this message when it detects an imminent failure. This message can be reported by an ATAPI device using the S.M.A.R.T. error reporting standard. S.M.A.R.T. failure messages may indicate the need to replace the hard disk.

## Virus Related

Message Displayed	Description
BootSector Write !!	The BIOS has detected software attempting to write to a drive's boot sector. This is flagged as possible virus activity. This message will only be displayed if Virus Detection is enabled in AMIBIOS setup.
VIRUS: Continue (Y/N)?	If the BIOS detects possible virus activity, it will prompt the user. This message will only be displayed if Virus Detection is enabled in AMIBIOS setup.

# System Configuration

Message Displayed	Description
DMA-1 Error	Error initializing primary DMA controller. This is a fatal error, often indication a problem with system hardware.
DMA-2 Error	Error initializing secondary DMA controller. This is a fatal error, often indication a problem with system hardware.
DMA Controller Error	POST error while trying to initialize the DMA controller. This is a fatal error, often indication a problem with system hardware.
Checking NVRAM..Update Failed	BIOS could not write to the NVRAM block. This message appears when the FLASH part is write-protected or if there is no FLASH part (System uses a PROM or EPROM).
Microcode Error	BIOS could not find or load the CPU Microcode Update to the CPU. This message only applies to INTEL CPUs. The message is most likely to appear when a brand new CPU is installed in a mainboard with an outdated BIOS. In this case, the BIOS must be updated to include the Microcode Update for the new CPU.
NVRAM Checksum Bad, NVRAM Cleared	There was an error in while validating the NVRAM data. This causes POST to clear the NVRAM data.
Resource Conflict	More than one system device is trying to use the same non-shareable resources (Memory or I/O).
NVRAM Ignored	The NVRAM data used to store Plug'n'Play (PnP) data was not used for system configuration in POST.
NVRAM Bad	The NVRAM data used to store Plug'n'Play (PnP) data was not used for system configuration in POST due to a data error.
Static Resource Conflict	Two or more Static Devices are trying to use the same resource space (usually Memory or I/O).
PCI I/O conflict	A PCI adapter generated an I/O resource conflict when configured by BIOS POST.
PCI ROM conflict	A PCI adapter generated an I/O resource conflict when configured by BIOS POST.
PCI IRQ conflict	A PCI adapter generated an I/O resource conflict when configured by BIOS POST.
PCI IRQ routing table error	BIOS POST (DIM code) found a PCI device in the system but was unable to figure out how to route an IRQ to the device. Usually this error is causing by an incomplete description of the PCI Interrupt Routing of the system.
Timer Error	Indicates an error while programming the count register of channel 2 of the 8254 timer. This may indicate a problem with system hardware.
Refresh timer test failed	BIOS POST found that the refresh timer hardware failed to pass the Refresh Retrace Test.
Interrupt Controller-1 error	BIOS POST could not initialize the Master Interrupt Controller. This may indicate a problem with system hardware.
Interrupt Controller-2 error	BIOS POST could not initialize the Slave Interrupt Controller. This may indicate a problem with system hardware.

---

## CMOS

Message Displayed	Description
CMOS Date/Time Not Set	The CMOS Date and/or Time are invalid. This error can be resolved by readjusting the system time in AMIBIOS Setup.
CMOS Battery Low	CMOS Battery is low. This message usually indicates that the CMOS battery needs to be replaced. It could also appear when the user intentionally discharges the CMOS battery.
CMOS Settings Wrong	CMOS settings are invalid. This error can be resolved by using AMIBIOS Setup.
CMOS Checksum Bad	CMOS contents failed the Checksum check. Indicates that the CMOS data has been changed by a program other than the BIOS or that the CMOS is not retaining its data due to malfunction. This error can typically be resolved by using AMIBIOS Setup.

## Miscellaneous

Message Displayed	Description
KBC BAT Test failed	Keyboard controller BAT test failed. This may indicate a problem with keyboard controller initialization.
Keyboard Error	Keyboard is not present or the hardware is not responding when the keyboard controller is initialized.
PS2 Keyboard not found	PS2 Keyboard support is enabled in the BIOS setup but the device is not detected.
PS2 Mouse not found	PS2 Mouse support is enabled in the BIOS setup but the device is not detected.
Keyboard/Interface Error	Keyboard Controller failure. This may indicate a problem with system hardware.
Unlock Keyboard	PS2 keyboard is locked. User needs to unlock the keyboard to continue the BIOS POST.
System Halted	The system has been halted. A reset or power cycle is required to reboot the machine. This message appears after a fatal error has been detected.
<INS> Pressed	Indicates that <INS> key is pressed during the BIOS POST. The POST will load and use default CMOS settings.
Password check failed	The password entered does not match the password set in the setup. This condition may occur for both Supervisor and User password verification.
Unknown BIOS error. Error code = 004Ah	This message is displayed when ADM module is not present in the AMIBIOS8 ROM.
Unknown BIOS error. Error code = 004Bh	This message is displayed when language module is not present in the AMIBIOS8 ROM.
Floppy Controller Failure	Error in initializing legacy Floppy Controller.



## USB eModule Error Messages

Message Displayed	Description
Warning! Unsupported USB device found and disabled!	This message is displayed when a non-bootable USB device is enumerated and disabled by the BIOS.
Warning! Port 60h/64h emulation is not supported by this USB Host Controller!	This message is displayed to indicate that port 60h/64h emulation mode cannot be enabled for this USB host controller. This condition occurs if USB KBC emulation option is set for non-SMI mode.
Warning! EHCI controller disabled. It requires 64bit data support in the BIOS.	This message is displayed to indicate that EHCI controller is disabled because of incorrect data structure. This condition occur if the USB host controller needs 64-bit data structure while the USB is ported with 32-bit data structure.

## SMBIOS eModule Error Messages

Message Displayed	Description
Not enough space in Runtime area!! SMBIOS data will not be available.	This message is displayed when the size of the SMBIOS data exceeds the available SMBIOS runtime storage size.

## CPU eModule Error Messages

Message Displayed	Description
Warning! This system board does not support the power requirements of the installed processor. The processor will be run at a reduced frequency, which will impact system performance. area!! SMBIOS data will not be available.	This message is displayed when the power requirements of the board do not match the power requirement of the CPU.

## MPS Table (Multi-processor) eModule Error Messages

Message Displayed	Description
Insufficient Runtime space for MPS data! System may operate in PIC or Non-MPS mode.	This message is displayed when there is not enough space in the 0F000h runtime area for creating MPS table.

---

# Beep Codes

Beep codes are used by the BIOS to indicate a serious or fatal error to the end user. Beep codes are used when an error occurs before the system video has been initialized. Beep codes will be generated by the system board speaker, commonly referred to as the PC speaker.

AMIBIOS displays the checkpoints in the bottom right corner of the screen during POST. This display method is limited, since it only displays checkpoints that occur after the video card has been activated.

Not all computers using AMIBIOS enable this feature. In most cases, a checkpoint card is the best tool for viewing AMIBIOS checkpoints.

<b>Beep Symptom</b>	<b>Cause and Description</b>
One short beep	System is ready. System is OK.
Continuous one long beep	Memory not installed or memory error.
One long beep and two short beeps then repeat.	VGA not installed or VGA error. Graphics card error/not installed, graphics card memory error or graphics card BIOS checksum error.
One long beep then two short beep	BIOS damaged. BIOS is damaged, BIOS POST jumps to Boot Block to execute the default procedures.
Two short beeps	CMOS damaged. CMOS checksum error or CMOS battery loss occurs.

# Index of Symptom-to-FRU Error Message

**NOTE:** To diagnose a problem, first find the error symptom in the left column. If directed to a check procedure, replace the FRU indicated in the check procedure. If no check procedure is indicated, the first Action/FRU listed in the right column is the most likely cause.

## Processor/Processor Fan-Related Symptoms

Symptom / Error	Action/FRU
Processor fan does not run but power supply fan runs.	<input type="checkbox"/> Ensure the system is not in power saving mode. <input type="checkbox"/> With the system power on, measure the voltage of processor fan connector. Its reading should be +12Vdc. Its reading should be +12Vdc. If the reading shows normal, but the fan still does not work, then replace a good fan. <input type="checkbox"/> Mainboard
Processor test failed.	<input type="checkbox"/> Processor <input type="checkbox"/> Mainboard

**NOTE:** Normally, the processor fan should be operative, and the processor clock setting should be exactly set to match its speed requirement before diagnosing any processor problems.

## Mainboard and memory-Related Symptoms

Symptom / Error	Action/FRU
Memory test failed.	<input type="checkbox"/> Memory module <input type="checkbox"/> Mainboard
Incorrect memory size shown or repeated during POST.	<input type="checkbox"/> Insert the memory modules in the DIMM sockets properly, then reboot the system. <input type="checkbox"/> Memory module <input type="checkbox"/> Mainboard
System works but fails to enter power saving mode when the Power Management Mode is set to Enabled.	<input type="checkbox"/> Enter BIOS Setup and load default settings. In Windows Systems, check settings in Power Management Property of Control Panel. <input type="checkbox"/> Reload software from Recovery CD.
Blinking cursor only; system does not work.	<input type="checkbox"/> Diskette/IDE drive connection/cables <input type="checkbox"/> Diskette/IDE disk drives <input type="checkbox"/> See "Undetermined Problems". <input type="checkbox"/> Mainboard

**NOTE:** Ensure the memory modules are installed properly and the contact leads are clean before diagnosing any system problems.

## Diskette Drive-Related Symptoms

Symptom / Error	Action/FRU
Media and drive are mismatched.	<input type="checkbox"/> Ensure the diskette drive is configured correctly in the Disk Drives of BIOS Setup. <input type="checkbox"/> Ensure the diskette drive is correctly formatted. <input type="checkbox"/> Diskette drive connection/cable <input type="checkbox"/> Diskette drive <input type="checkbox"/> Mainboard
Diskette drive does not work.	<input type="checkbox"/> Ensure the diskette drive is not set to None in the Disk Drives of BIOS Setup. <input type="checkbox"/> Diskette drive power <input type="checkbox"/> Diskette drive connection/cable <input type="checkbox"/> Diskette drive <input type="checkbox"/> Mainboard
Diskette drive read/write error.	<input type="checkbox"/> Diskette <input type="checkbox"/> Diskette drive cable <input type="checkbox"/> Diskette drive <input type="checkbox"/> Mainboard
Diskette drive LED comes on for more than 2 minutes when reading data.	<input type="checkbox"/> Diskette <input type="checkbox"/> Diskette drive cable <input type="checkbox"/> Diskette drive <input type="checkbox"/> Mainboard
Diskette drive LED fails to light, and the drive is unable to access for more than 2 minutes.	<input type="checkbox"/> Diskette <input type="checkbox"/> Diskette drive power <input type="checkbox"/> Diskette drive connection/cable <input type="checkbox"/> Diskette drive <input type="checkbox"/> Mainboard
Diskette drive test failed.	<input type="checkbox"/> Diskette <input type="checkbox"/> Diskette drive cable <input type="checkbox"/> Diskette drive <input type="checkbox"/> Mainboard

**NOTE:** Ensure the diskette drive is auto-setting in BIOS Setup and its read/write head is clean before diagnosing any diskette drive problems. (If only one drive is installed, please make sure the drive is connected to master connector or the drive is set to master.)

### Hard Disk Drive-Related Symptoms

Symptom / Error	Action/FRU
Hard disk drive test failed.	<input type="checkbox"/> Enter BIOS Setup and Load default settings <input type="checkbox"/> Hard disk drive cable <input type="checkbox"/> Hard disk drive <input type="checkbox"/> Mainboard
Hard disk drive cannot format completely.	<input type="checkbox"/> Enter BIOS Setup and Load default settings <input type="checkbox"/> Hard disk drive cable <input type="checkbox"/> Hard disk drive <input type="checkbox"/> Mainboard
Hard disk drive has write error.	<input type="checkbox"/> Enter BIOS Setup and Load default settings <input type="checkbox"/> Hard disk drive
Hard disk drive LED fails to light, but system operates normally.	<input type="checkbox"/> With the system power on, measure the voltage of hard disk LED connector. <input type="checkbox"/> Hard drive LED cable

**NOTE:** Ensure hard disk drive is configured correctly in BIOS Setup, cable/jumper are set correctly before diagnosing any hard disk drive problems. (If only one drive is installed, please make sure the drive is connected to master connector or the drive is set to master.)

### CD/DVD-ROM Drive-Related Symptoms

Symptom / Error	Action/FRU
CD/DVD-ROM drive LED doesn't come on but works normally.	<input type="checkbox"/> Run "Load Setup Defaults" in BIOS Setup Utility, then reboot system. <input type="checkbox"/> DIMM <input type="checkbox"/> Mainboard
CD/DVD-ROM drive LED flashes for more than 30 seconds before LED shutting off. Software asks to reinstall disc. Software displays a reading CD/DVD error.	<input type="checkbox"/> CD/DVD-ROM may have dirt or foreign material on it. Check with a known good disc. <input type="checkbox"/> CD/DVD-ROM is not inserted properly. <input type="checkbox"/> CD/DVD-ROM is damaged.
CD/DVD-ROM drive cannot load or eject when the system is turned on and its eject button is pressed and held.	<input type="checkbox"/> Disconnect all cables from CD/DVD-ROM drive except power cable, then press eject button to try to unload the disk. <input type="checkbox"/> CD/DVD-ROM drive power. <input type="checkbox"/> CD/DVD-ROM drive
CD/DVD-ROM drive does not read and there are no messages are displayed.	<input type="checkbox"/> CD may have dirt or foreign material on it. Check with a known good disc. <input type="checkbox"/> Ensure the CD/DVD-ROM driver is installed properly. <input type="checkbox"/> CD/DVD-ROM drive.
CD/DVD-ROM drive can play audio CD but no sound output.	<input type="checkbox"/> Ensure the headphone jack of the CD/DVD-ROM has an output. <input type="checkbox"/> Turn up the sound volume. <input type="checkbox"/> Speaker power/connection/cable. <input type="checkbox"/> CD/DVD-ROM drive.

**NOTE:** Ensure CD/DVD-ROM drive is configured correctly in BIOS Setup, cable/jumper are set correctly and its laser beam is clean before diagnosing any CD/DVD-ROM drive problems.

### Real-Time Clock-Related Symptoms

Symptom / Error	Action/FRU
Real-time clock is inaccurate.	<input type="checkbox"/> Ensure the information in the Standard CMOS Feature of BIOS Setup is set correctly. <input type="checkbox"/> RTC battery <input type="checkbox"/> Mainboard

### Audio-Related Symptoms

Symptom / Error	Action/FRU
Audio software program invokes but no sound comes from speakers.	<input type="checkbox"/> Speaker power/connection/cable.

### Modem-Related Symptoms

Symptom / Error	Action/FRU
Modem ring cannot wake up system from suspend mode.	<input type="checkbox"/> For the External Modem, make sure Power on By Ring in BIOS Setup or Power Management is set to Enabled. For the PCI modem, make sure Wake up by PCI card is set to Enabled. <input type="checkbox"/> If PCI modem card is used, reinsert the modem card to PCI slot firmly or replace the modem card. <input type="checkbox"/> In Win 98, ensure the telephone application is configured correctly for your modem and set to receive messages and/or fax.
Data/fax modem software program invokes but cannot receive/send data/fax	<input type="checkbox"/> Ensure the modem card is installed properly.
Fax/voice modem software program invokes but has no sound output. (Data files are received normally; voice from modem cannot be produced, but system sound feature works normally.)	<input type="checkbox"/> Ensure the modem voice-in cable from modem adapter card to mainboard

### Video and Monitor-Related Symptoms

Symptom / Error	Action/FRU
Video memory test failed.Video adapter failed.	<input type="checkbox"/> Remove all non-factory-installed cards. <input type="checkbox"/> Load default settings (if screen is readable). <input type="checkbox"/> Mainboard
Display problem: - Incorrect colors - No high intensity - Missing, broken, or incorrect characters - Blank monitor (dark) - Blank monitor (bright) - Distorted image - Unreadable monitor	<input type="checkbox"/> Monitor signal connection/cable. <input type="checkbox"/> Monitor <input type="checkbox"/> Video adapter card <input type="checkbox"/> Mainboard
Display changing colors.	<input type="checkbox"/> Monitor signal connection/cable. <input type="checkbox"/> Video adapter card <input type="checkbox"/> Mainboard

### Video and Monitor-Related Symptoms

Symptom / Error	Action/FRU
Serial or parallel port loop-back test failed.	<input type="checkbox"/> Make sure that the LPT# or COM# you test is the same as the setting in BIOS Setup. <input type="checkbox"/> Loop-back. <input type="checkbox"/> Mainboard
Printing failed.	<input type="checkbox"/> Ensure the printer driver is properly installed. Refer to the printer service manual. <input type="checkbox"/> Printer. <input type="checkbox"/> Printer cable. <input type="checkbox"/> Mainboard.
Printer problems.	<input type="checkbox"/> Refer to the service manual for the printer.

### Keyboard-Related Symptoms

Symptom / Error	Check or do the following in sequence
Some or all keys on keyboard do not work.	<input type="checkbox"/> Keyboard

### Power Supply-Related Symptoms

Symptom / Error	Check or do the following in sequence
Pressing power switch does not turn off system. (Only unplugging the power cord from electrical outlet can turn off the system.)	<input type="checkbox"/> Ensure the Soft-off by PWR-BTTN. in BIOS Setup of Power Management is not set to Instant-off. <input type="checkbox"/> Power switch cable assembly
Pressing power switch does not turn on the system	<input type="checkbox"/> Ensure the power override switch (situated at the back of the machine, just above the connector for the power cable) is not set to OFF. <input type="checkbox"/> Power switch cable assembly.
Executing software shutdown from Windows98 Start menu does not turn off the system. (Only pressing power switch can turn off the system).	<input type="checkbox"/> Load default settings. <input type="checkbox"/> Reload software from Recovery CD.
No system power, or power supply fan is not running.	<input type="checkbox"/> Power Supply <input type="checkbox"/> Mainboard

**NOTE:** If you cannot find a symptom or an error in this list and the problem remains, see “Undetermined Problems” on page 74.

# BIOS Recovery

1. Prepare a USB storage device and keep it ready in hand.
  - (1). Connect the USB storage device to a USB port on your computer.
  - (2). Copy the target BIOS ROM file to a USB storage device.
  - (3). Rename the target BIOS to “**amiboot.rom**”.
  - (4). Unplug the USB storage device.
2. Connect the USB storage device on the USB port on the system.
3. Power on the system. The system initializes the BIOS recovery process. Wait for about 3 minutes and the system will reboot automatically after the flash update is completed.

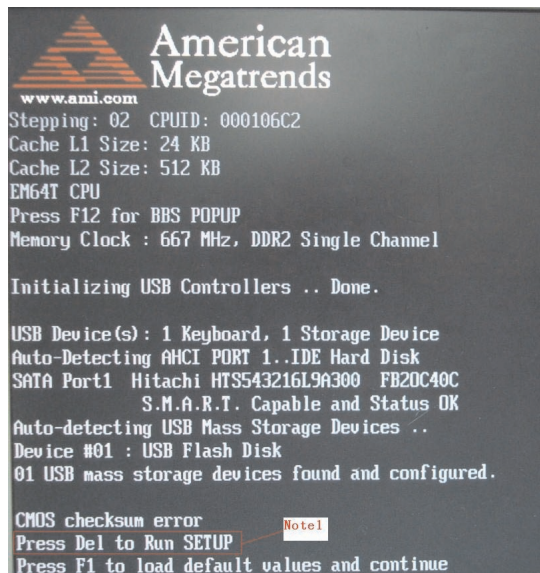



4. Press **Delete** to run the Setup Utility.

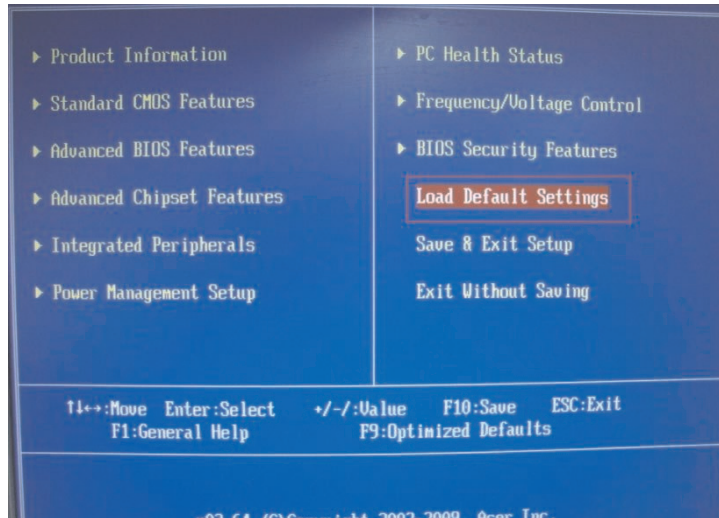

5. In the Setup Utility, select **Load Default Settings**, then press **Enter**.

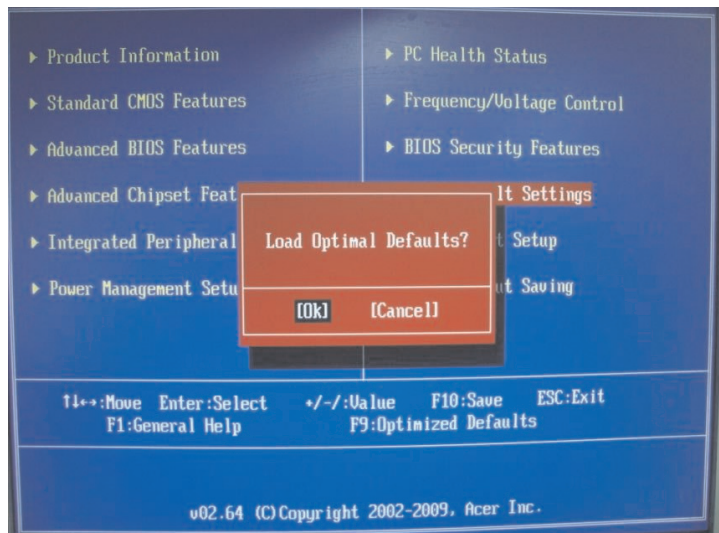

6. Select **Ok**, then press **Enter**.
7. Select **Save & Exit Setup**, then press **Enter**.
8. Select **Ok**, then press **Enter**.

---

# Undetermined Problems

The diagnostic problems does not identify which adapter or device failed, which installed devices are incorrect, whether a short circuit is suspected, or whether the system is inoperative.

**NOTE:** Verify that all attached devices are supported by the computer.

**NOTE:** Verify that the power supply being used at the time of the failure is operating correctly. (See “Power System Check” on page 54.)

Follow procedures below to isolate the failing FRU. Do not isolate non-defective FRU.

1. Power off the computer.
2. Visually check them for damage. If any problems are found, replace the FRU.
3. Remove or disconnect all of the following devices:
  - Non-Acer devices
  - Printer, mouse, and other external devices
  - Hard disk drive
  - DIMM
  - CD/DVD-ROM drive
  - Adapter cards
4. Power on the computer.
5. Determine if the problem has been resolved.
6. If the problem does not recur, reconnect the removed devices one at a time until you find the failed FRU.
7. If the problem persists, replace the FRU one at a time. Do not replace a non-defective FRU.

# System Block Diagram and Board Layout

## System Block Diagram

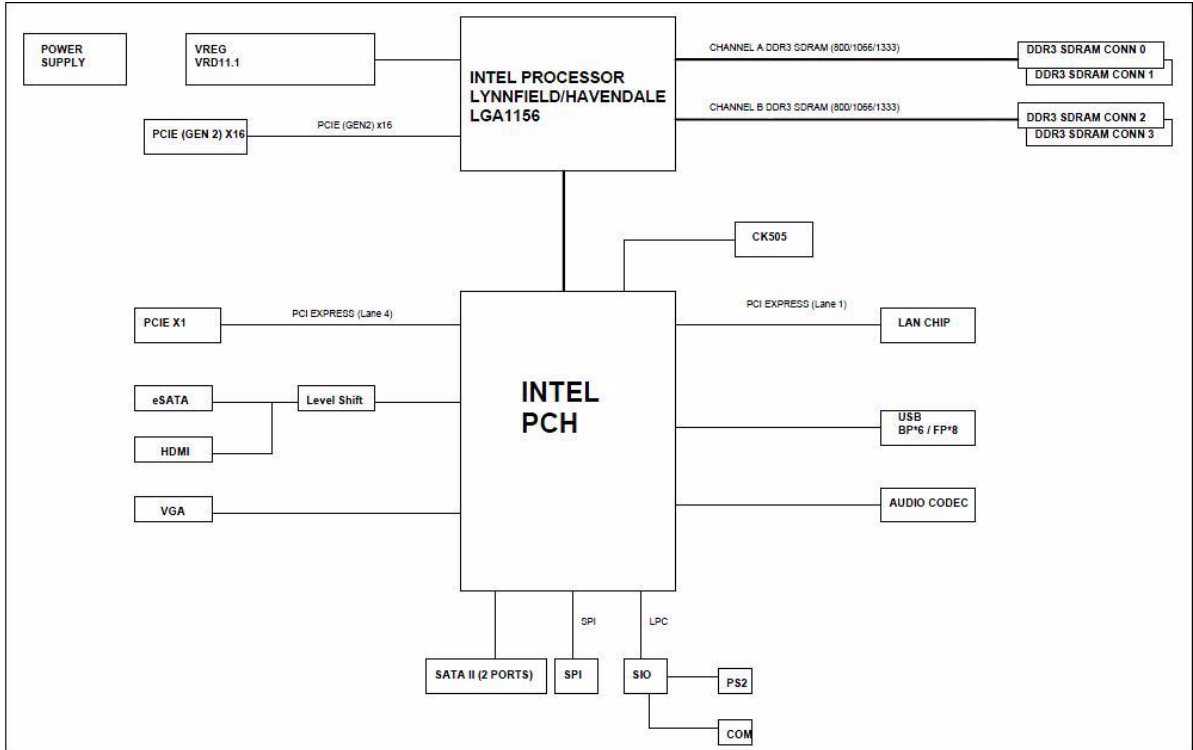

# Mainboard Layout

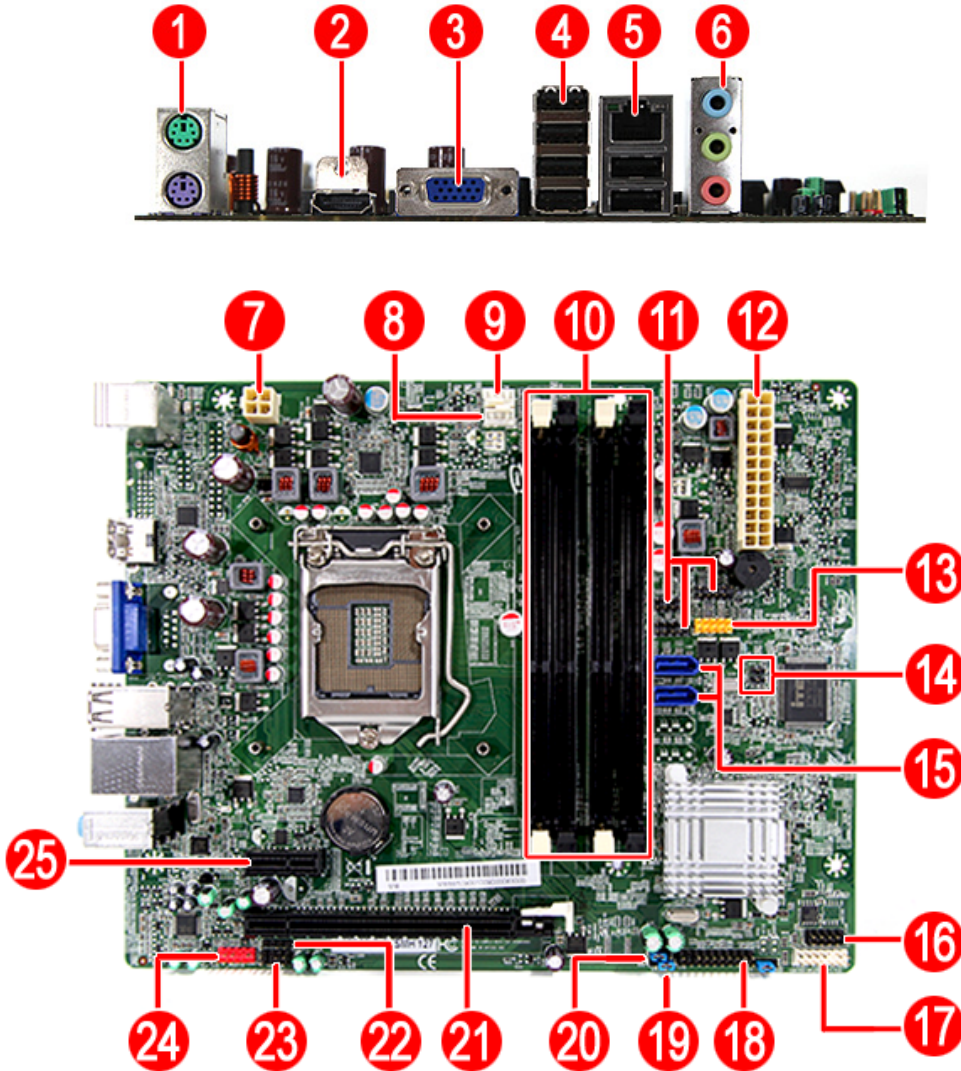

No	Code	Description
1	KB/MS	Top: PS2 Mouse port Bottom: PS2 Keyboard port
2	HDMI1	HDMI port
3	VGA1	VGA (D-sub) port
4	USBESATA1	USB ports
5	USBLAN1	Top: Network port Bottom: USB ports
6	AUDJACK	Line-in/Side surround jack Line-Out Line-out jack Microphone/line-in jack
7	PWR2	Processor power connector
8	REAR_FAN	System fan connector
9	CPU_FAN	Processor fan connector

No	Code	Description
10	DIMM 1-4	DIMM slots
11	F_USB1, 2 and 4	Card reader USB cable connectors
12	PWR1	Main power connector
13	F_USB3	Front panel USB connector
14	GPIO1-2	GPIO1~2 Reserve headers
15	SATA 1-2	SATA connectors
16	BIOS_FLASH	BIOS flash connector
17	FRONT_PANEL1	Front panel connector
18	TPM	Trusted platform module connector
19	CLR_CMOS	Clear CMOS jumper
20	PCH_ME_ENABLE	PCH_ME_ENABLE jumpers
21	PCI-E1_16X	PCI Express x16 slot
22	SPDIFI_OUT	S/PDIF port
23	SPEAKER1	Internal speaker connector
24	F_AUDIO	Front panel audio connector
25	PCI_E1_1x2	PCI Express x2 slot



# FRU (Field Replaceable Unit) List

---

This chapter offers the FRU (Field Replaceable Unit) list in global configuration of the X3950 or X5950 desktop computer. Refer to this chapter whenever ordering the parts to repair or for RMA (Return Merchandise Authorization).

## NOTES:

- ❑ When ordering FRU parts, check the most up-to-date information available on your regional web or channel. For whatever reasons a part number is changed, it will NOT be noted on the printed Service Guide. For Acer authorized service providers, your Acer office may have a different part number code from those given in the FRU list of this printed Service Guide. You MUST use the local FRU list provided by your regional Acer office to order FRU parts for service.
- ❑ To scrap or to return the defective parts, follow the local government ordinance or regulations on how to dispose it properly, or follow the rules set by your regional Acer office on how to return it.
- ❑ This document will be updated as more information about the FRU list becomes available.

# Exploded Diagram

X3950 model

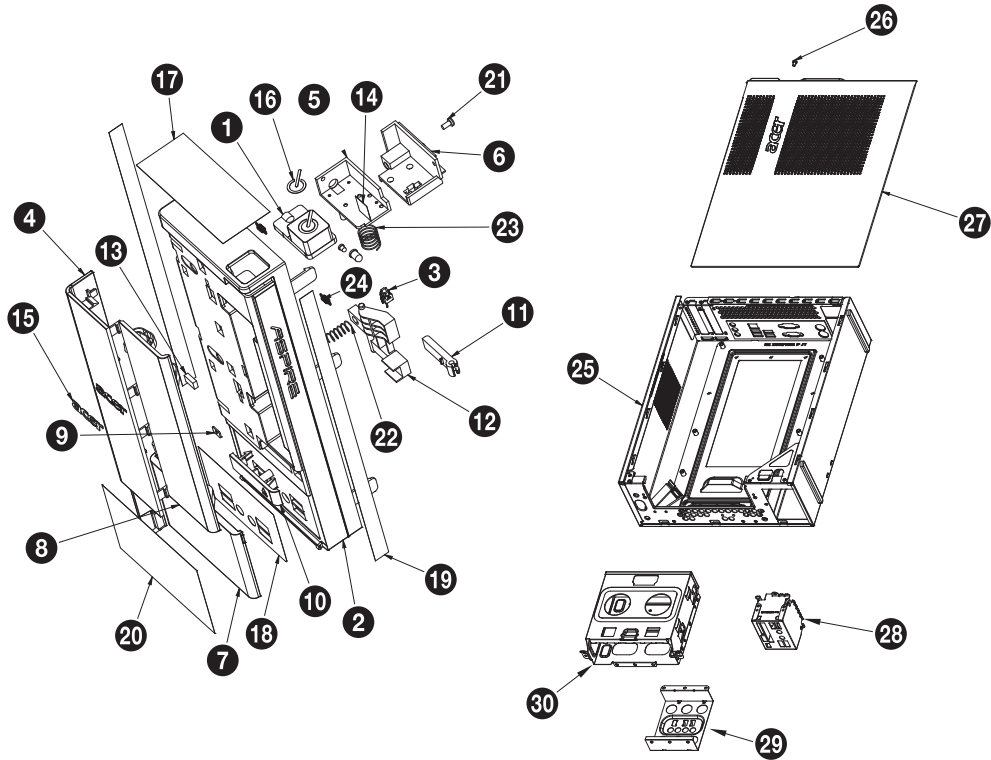

No.	Part Name	No.	Part Name
1	ASSY POWER BUTTON BOXER X350	16	PLT POWER LOGO BOXER X350
2	BEZEL FRONT BOXER X351	17	PROTECT FILM F-BEZEL BOXER X350
3	C.A. LED SWITCH BOXER X350	18	PROTECT FILM F-BEZEL-R-BOXER X350
4	CVR FRONT BOXER X350	19	PROTECT FILM F-IO BOXER X351
5	CVR LIGHT BOXER X350	20	PROTECT FILM IO-DOOR-BOXER X350
6	CVR P[OWER BOXER X350	21	SCRW TAP PAN M3*L8 2 LEAD
7	DOOR IO BOXER X350	22	SPG ODD LINK BOXER X310
8	DOOR ODD BOXER X350	23	SPG POWER BOXER X310
9	IO DOOR BKT	24	SPRING ODD DOOR HD206A
10	KNOB ODD BOXER X350	25	ASSY L CASE - ASM BOXER X550
11	KNOB ODD LINK A BOXER X350	26	SCRW #6-32 L5 PAN NI
12	KNOB ODD LINK B BOXER X350	27	CAS UP BOXER X550
13	MAGNET 10*6*3	28	FRONT IO BRACKET
14	MYLAR LIGHT COVER BOXER X350	29	ODD BRACKET
15	PLT ACER-LOGO-BOXER-X5	30	HDD BRACKET





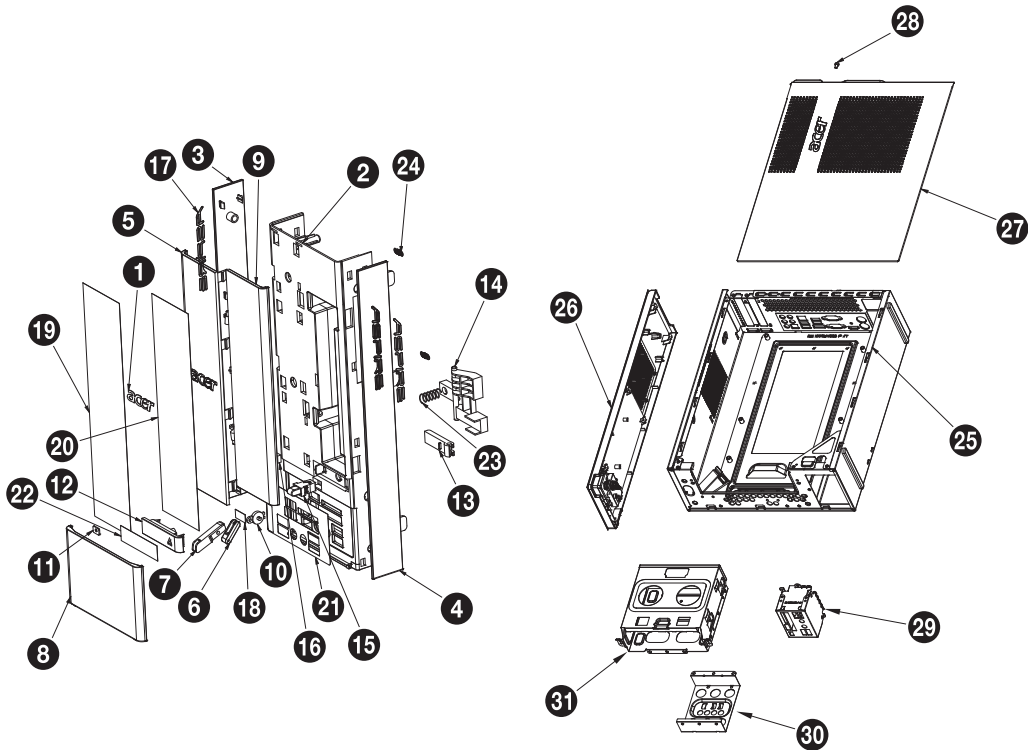



X5950 model



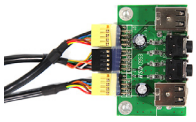



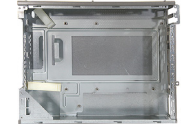
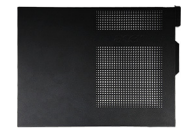
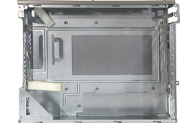





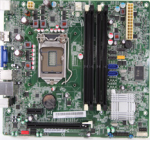

No.	Part Name	No.	Part Name
1	PLT ACER LOGO BOXER X5	17	PLT ASPIRE LOGO BOXER X550
2	BEZEL FRONT B BOXER X550	18	PLT ODD KNOB LOGO BOXER X550
3	CVR COSMETIC ART WORK BOXER X550	19	PROTECT FILM CVR FRONT BOXER X550
4	CVR COSMETIC BOXER X550	20	PROTECT FILM DOOR ODD BOXER X550
5	CVR FRONT BOXER X550	21	PROTECT FILM F-IO BOXER X550
6	DOOR FIO LINK A BOXER X550	22	PROTECT FILM KNOB ODD BOXER X550
7	DOOR FIO LINK B BOXER X550	23	SPG ODD LINK BOXER X310
8	DOOR IO BOXER X550	24	SPRING ODD DOOR HD206A
9	DOOR ODD BOXER X550	25	ASSY L CASE - ASM BOXER X550
10	GEAR PG-07A 7G	26	ASSY TOP-COVER BOXER X550
11	IO DOOR BKT	27	CAS UP BOXER X550
12	KNOB ODD BOXER X550	28	SCRW #6-32 L5 PAN NI
13	KNOB ODD LINK A BOXER X350	29	FRONT IO BRACKET
14	KNOB ODD LINK B BOXER X350	30	ODD BRACKET
15	LATCH DOOR BOXER X5	31	HDD BRACKET
16	MAGNET 10*6*3		



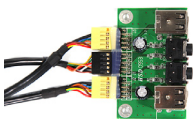

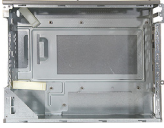
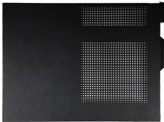
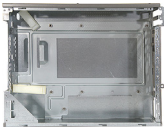

# X3950 FRU List

System model: PV.SE602.004 AX3950 AAP AJC PV.SE602.004









Category	Part Name	Acer Part No.
<b>BOARDS</b>		
	FRONT IO BOARD CENTURY W/AUDIO CABLE*1&USB CABLE*2	55.SC101.001
	CARD READER 9 IN 1 8.5L AU6476 W/USB2.0 & USB CABLE W/O 1394	CR.10400.107
<b>CABLES</b>		
	POWER CORD 125V 7A 3G JAPAN	27.01518.181
	ODD SATA CABLE	50.SD101.001
	HDD SATA CABLE	50.SD101.002
	LED SWITCH CABLE	TBD
<b>CASE/COVER/BRACKET ASSEMBLY</b>		
	FRONT IO BRACKET	TBD
	ASSEMBLY MAIN CHASSIS W/UCASE & LCASE FOR BOXER X350	TBD
	UPPER CASE BOXER X350	TBD
	ASSEMBLY LOWER CASE FOR BOXER X350	TBD
	HDD&ODD COVER BRACKET	33.SC101.002
	FRONT BEZEL W/LED SWITCH CABLE FOR X350	TBD





CPU/PROCESSOR		
	CPU INTEL CORE I3-530 LGA 2.93G 4M 1333FSB 1156 73W CLARKDALE C-2 DUAL CORE	KC.53001.CI3
DVD-RW DRIVE		
	ODD PLDS SUPER-MULTI DRIVE HH 16X DH-16AASH BLACK BEZEL SATA FOR HF+WINDOWS7	KU.0160F.009
HDD/HARD DISK DRIVE		
	HDD 3.5" 500GB 7200RPM SATA SEAGATE PHARAOH ST3500418AS	KH.50007.012
HEATSINK		
	CPU HEATSINK AIR COOLER LGA1156 95W WITH DUCT	HI.10800.071
KEYBOARD		
	KEYBOARD USB 109 KEY BLACK JAPANESE W/O EKEY	KB.USB0B.199
MAINBOARD		
	MAINBOARD AX1900 INTEL G41 ICH7 GMA X4500 W/RTC BATTERY W/O CPU&MEMORY	MB.SE509.001
MEMORY		
	MEMORY SAMSUNG DDR3 1333MHZ 2G UNB-UFFERED DIMM W/O ECC F DIE (46NM)	KN.2GB0H.009
POINTING DEVICE		
	LOGITECH 0810_USB OPTICAL MOUSE USB M-UAY-ACR2	MS.11200.018
POWER SUPPLY		
	POWER SUPPLY 220W NPFC 115V/230V LITEON PS-5221-06A1-ROHS EUP	PY.2200F.006
SCREWS		
	SCREW I NO6-32 L5 BZN	86.00J07.B60
	SCREW PAN #6-32 L6 NI BOXER WZS	86.00J44.C60
	SCREW #6-32 L5 PAN NI	86.00J90.B60
	SCREW NO4-40 L6.5 PAN NI	86.00N03.B40
	SCRW PAN M3 L5 BZN	86.1A324.5R0
	SCREW FLAT #6-32*3/16 NI	86.5A5B6.012

Category	Part Name	OEM Part No.
<b>BOARDS</b>		
	FRONT IO BOARD CENTURY W/AUDIO CABLE*1&USB CABLE*2	55.SC101.001
	CARD READER 9 IN 1 8.5L AU6476 W/USB2.0 & USB CABLE W/O 1394	CR.10400.107
	WIRELESS LAN BOARD 802.11BGN LITEON WN7600R	NI.10200.009
<b>CABLES</b>		
	POWER CORD 250V 3PIN 1800MM UK	27.01518.181
	ODD SATA CABLE	50.SD101.001
	HDD SATA CABLE	50.SD101.002
	LED SWITCH CABLE	TBD
<b>CASE/COVER/BRACKET ASSEMBLY</b>		
	FRONT IO BRACKET	TBD
	ASSEMBLY MAIN CHASSIS W/UCASE & LCASE FOR BOXER X350	TBD
	UPPER CASE BOXER X350	TBD
	ASSEMBLY LOWER CASE FOR BOXER X350	TBD
	HDD&ODD COVER BRACKET	33.SC101.002
	FRONT BEZEL W/LED SWITCH CABLE FOR X350	TBD





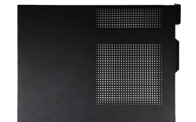



CPU/PROCESSOR		
	CPU INTEL CORE I3-530 LGA 2.93G 4M 1333FSB 1156 73W CLARKDALE C-2 DUAL CORE	KC.53001.CI3
DVD-RW DRIVE		
	ODD PLDS SUPER-MULTI DRIVE HH 16X DH-16AASH BLACK BEZEL SATA FOR HF+WINDOWS7	KU.0160F.009
HDD/HARD DISK DRIVE		
	HDD 320GB 3.5" 7200RPM SATA II SEAGATE PHARAOH 8MB NCQ	KH.32007.011
HEATSINK		
	CPU HEATSINK AIR COOLER LGA1156 95W WITH DUCT	HI.10800.071
KEYBOARD		
	KEYBOARD USB 104 KEY CHICONY KU-07603US25522V BLACK US W/O EKEY	KB.USB0B.158
MAINBOARD		
	MAINBOARD AX1900 INTEL G41 ICH7 GMA X4500 W/RTC BATTERY W/O CPU&MEMORY	MB.SE509.001
MEMORY		
	MEMORY SAMSUNG DDR3 1333MHZ 2G UNB-UFFERED DIMM W/O ECC F DIE (46NM)	KN.2GB0H.009
POINTING DEVICE		
	LOGITECH 0810_USB OPTICAL MOUSE USB M-UAY-ACR2	MS.11200.018
POWER SUPPLY		
	POWER SUPPLY 220W NPFC 115V/230V LITEON PS-5221-06A1-ROHS EUP	PY.2200F.006
SCREWS		
	SCREW I NO6-32 L5 BZN	86.00J07.B60
	SCREW PAN #6-32 L6 NI BOXER WZS	86.00J44.C60
	SCREW #6-32 L5 PAN NI	86.00J90.B60
	SCRW PAN M3 L5 BZN	86.1A324.5R0
	SCREW FLAT #6-32*3/16 NI	86.5A5B6.012
SPEAKER		
	SPEAKER CHIAMA W 9M-20A200-000 ACER LOGO LF 0810	SP.10600.011

Category	Part Name	Acer Part No.
<b>BOARDS</b>		
	FRONT IO BOARD CENTURY W/AUDIO CABLE*1&USB CABLE*2	55.SC101.001
	CARD READER 9 IN 1 8.5L AU6476 W/USB2.0 & USB CABLE W/O 1394	CR.10400.107
	WIRELESS LAN BOARD 802.11BGN LITEON WN7600R	NI.10200.009
	VGA CARD PCPARTNER 288-1N141-A00AC NVIDIA GT315 512MB SDDR3 DVI+HDMI ATX (SAMSUNG)	VG.PCPT3.154
<b>CABLES</b>		
	POWER CORD 250V 3PIN 1800MM UK	27.01518.181
	ODD SATA CABLE	50.SD101.001
	HDD SATA CABLE	50.SD101.002
	DVI TO VGA DONGLE CONNECTOR	D0.VGA26.P01
	LED SWITCH CABLE	TBD
<b>CASE/COVER/BRACKET ASSEMBLY</b>		
	FRONT IO BRACKET	TBD
	ASSEMBLY MAIN CHASSIS W/UCASE & LCASE FOR BOXER X350	TBD
	UPPER CASE BOXER X350	TBD
	ASSEMBLY LOWER CASE FOR BOXER X350	TBD
	HDD&ODD COVER BRACKET	33.SC101.002

	FRONT BEZEL W/LED SWITCH CABLE FOR X350	TBD
CPU/PROCESSOR		
	CPU INTEL CORE I3-530 LGA 2.93G 4M 1333FSB 1156 73W CLARKDALE C-2 DUAL CORE	KC.53001.CI3
DVD-RW DRIVE		
	ODD PLDS SUPER-MULTI DRIVE HH 16X DH-16AASH BLACK BEZEL SATA FOR HF+WINDOWS7	KU.0160F.009
HDD/HARD DISK DRIVE		
	HDD 3.5" 500GB 7200RPM SATA SEAGATE PHARAOH ST3500418AS	KH.50007.012
HEATSINK		
	CPU HEATSINK AIR COOLER LGA1156 95W WITH DUCT	HI.10800.071
KEYBOARD		
	KEYBOARD RF2.4 104KEY CHYCONY KG-0766 104K BLACK US	KB.RF403.362
MAINBOARD		
	MAINBOARD AX1900 INTEL G41 ICH7 GMA X4500 W/RTC BATTERY W/O CPU&MEMORY	MB.SE509.001
MEMORY		
	MEMORY SAMSUNG DDR3 1333MHZ 2G UNB-UFFERED DIMM W/O ECC F DIE (46NM)	KN.2GB0H.009
POWER SUPPLY		
	POWER SUPPLY 220W NPFC 115V/230V LITEON PS-5221-06A1-ROHS EUP	PY.2200F.006
SCREWS		
	SCREW I NO6-32 L5 BZN	86.00J07.B60
	SCREW PAN #6-32 L6 NI BOXER WZS	86.00J44.C60
	SCREW #6-32 L5 PAN NI	86.00J90.B60
	SCREW NO4-40 L6.5 PAN NI	86.00N03.B40
	SCRW PAN M3 L5 BZN	86.1A324.5R0
	SCREW FLAT #6-32*3/16 NI	86.5A5B6.012
SPEAKER		
	SPEAKER CHIAMA W 9M-20A200-000 ACER LOGO LF 0810	SP.10600.011









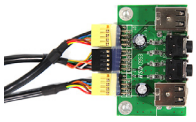

Category	Part Name	OEM Part No.
<b>BOARDS</b>		
	FRONT IO BOARD CENTURY W/AUDIO CABLE*1&USB CABLE*2	55.SC101.001
	CARD READER 9 IN 1 8.5L AU6476 W/USB2.0 & USB CABLE W/O 1394	CR.10400.107
	WIRELESS LAN BOARD 802.11BGN LITEON WN7600R	NI.10200.009
	VGA CARD PCPARTNER 288-5N118-A10AC NVIDIA GT320 1GB SDDR3 DVI+HDMI LP (SAMSUNG)	VG.PCPT3.212
<b>CABLES</b>		
	POWER CORD 250V 3PIN 1800MM UK	27.01518.181
	ODD SATA CABLE	50.SD101.001
	HDD SATA CABLE	50.SD101.002
	DVI TO VGA DONGLE CONNECTOR	D0.VGA26.P01
	LED SWITCH CABLE	TBD
<b>CASE/COVER/BRACKET ASSEMBLY</b>		
	FRONT IO BRACKET	TBD
	ASSEMBLY MAIN CHASSIS W/UCASE & LCASE FOR BOXER X350	TBD
	UPPER CASE BOXER X350	TBD
	ASSEMBLY LOWER CASE FOR BOXER X350	TBD
	HDD&ODD COVER BRACKET	33.SC101.002





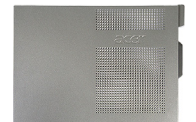





	FRONT BEZEL W/LED SWITCH CABLE FOR X350	TBD
CPU/PROCESSOR		
	CPU INTEL CORE I5-650 LGA 3.2G 4M 1333FSB 1156 C-2 73W CLARKDALE DUAL CORE	KC.65001.CI5
DVD-RW DRIVE		
	ODD PLDS SUPER-MULTI DRIVE HH 16X DH-16AASH BLACK BEZEL SATA FOR HF+WINDOWS7	KU.0160F.009
HDD/HARD DISK DRIVE		
	HDD 1TB 3.5" 7200RPM SATA HGST SATURN HDT721010SLA360	KH.01K01.007
HEATSINK		
	CPU HEATSINK AIR COOLER LGA1156 95W WITH DUCT	HI.10800.071
KEYBOARD		
	KEYBOARD RF2.4 104KEY CHYCONY KG-0766 104K BLACK US	KB.RF403.362
MAINBOARD		
	MAINBOARD AX1900 INTEL G41 ICH7 GMA X4500 W/RTC BATTERY W/O CPU&MEMORY	MB.SE509.001
MEMORY		
	MEMORY SAMSUNG DDR3 1333MHZ 2G UNB-UFFERED DIMM W/O ECC F DIE (46NM)	KN.2GB0H.009
POWER SUPPLY		
	POWER SUPPLY 220W NPFC 115V/230V LITEON PS-5221-06A1-ROHS EUP	PY.2200F.006
SCREWS		
	SCREW I NO6-32 L5 BZN	86.00J07.B60
	SCREW PAN #6-32 L6 NI BOXER WZS	86.00J44.C60
	SCREW #6-32 L5 PAN NI	86.00J90.B60
	SCREW NO4-40 L6.5 PAN NI	86.00N03.B40
	SCRW PAN M3 L5 BZN	86.1A324.5R0
	SCREW FLAT #6-32*3/16 NI	86.5A5B6.012
SPEAKER		
	SPEAKER CHIAMA W 9M-20A200-000 ACER LOGO LF 0810	SP.10600.011

# X5950 FRU List

System model: 91.3CY01.002G AAGASSI PVT/MVB SKU AX5950

Category	Part Name	Acer Part No.
<b>BOARDS</b>		
	FRONT IO BOARD CENTURY W/AUDIO CABLE*1&USB CABLE*2	55.SC101.001
	CARD READER 9 IN 1 8.5L AU6476 W/USB2.0 & USB CABLE W/O 1394	CR.10400.107
	VGA CARD PCPARTNER 288-5N118-A10AC NVIDIA GT320 1GB SDDR3 DVI+HDMI LP (SAMSUNG)	VG.PCPT3.212
<b>CABLES</b>		
	POWER CORD 250V 3PIN 1800MM UK	27.01518.181
	ODD SATA CABLE	50.SD101.001
	HDD SATA CABLE	50.SD101.002
	DVI TO VGA DONGLE CONNECTOR	D0.VGA26.P01
	LED SWITCH CABLE	50.SE301.002
<b>CASE/COVER/BRACKET ASSEMBLY</b>		
	FRONT IO BRACKET	33.SE301.001
	ASSY MAIN-CHASSIS H57 BOXER X550	60.SE501.001
	UPPER CASE BOXER X550	60.SE301.002
	ASSEMBLY TOP COVER W/LED SWITCH CABLE FOR BOXER X550	60.SE301.004
	LOWER CASE	60.SE501.002
	HDD&ODD COVER BRACKET	33.SC101.002

	FRONT BEZEL FOR X550	60.SE301.005
CPU/PROCESSOR		
	CPU INTEL CORE I5-650 LGA 3.2G 4M 1333FSB 1156 C-2 73W CLARKDALE DUAL CORE	KC.65001.CI5
DVD-RW DRIVE		
	ODD PLDS SUPER-MULTI DRIVE HH 16X DH-16AASH BLACK BEZEL SATA FOR HF+WINDOWS7	KU.0160F.009
HDD/HARD DISK DRIVE		
	HDD 640GB 3.5" 7200RPM SATA II WD WD6400AAKS-22A7B2 XL320-M	KH.64007.001
HEATSINK		
	CPU HEATSINK AIR COOLER LGA1156 95W WITH DUCT	HI.10800.071
KEYBOARD		
	KEYBOARD USB 104KEY LITEON SK-9625S SILVER US NEW SILVER COLOR AC-MT-	KB.USB0B.203
MAINBOARD		
	MAINBOARD AX1900 INTEL G41 ICH7 GMA X4500 W/RTC BATTERY W/O CPU&MEMORY	MB.SE509.001
MEMORY		
	MEMORY SAMSUNG DDR3 1333MHZ 2G UNB-UFFERED DIMM W/O ECC F DIE (46NM)	KN.2GB0H.009
POINTING DEVICE		
	MOUSE USB OPT SM-9625S LITEON NEW SILVER COLOR AC-MT-113	MS.11200.068
POWER SUPPLY		
	POWER SUPPLY 220W NPFC 115V/230V LITEON PS-5221-06A1-ROHS EUP	PY.2200F.006
SCREWS		
	SCREW I NO6-32 L5 BZN	86.00J07.B60
	SCREW PAN #6-32 L6 NI BOXER WZS	86.00J44.C60
	SCREW #6-32 L5 PAN NI	86.00J90.B60
	SCREW NO4-40 L6.5 PAN NI	86.00N03.B40
	SCRW PAN M3 L5 BZN	86.1A324.5R0
	SCREW FLAT #6-32*3/16 NI	86.5A5B6.012

---

SPEAKER		
	SPEAKER USB NEOSONICA NEW SILVER COLOR AC-MT-113	SP.10600.035

# Technical Specifications

This section provides technical specifications for the system.

## Processor

Item	Specification				
Type	Intel Core processor family				Intel Pentium
Processor Number	i7-860/870	i5-750	i5-650/660/ 661/670	i3-540	G6950
Number of Cores	Quad (45 nm)	Quad (45 nm)	Dual (32 nm)	Dual (32 nm)	Dual (32 nm)
Clock Speed (GHz)	2.8/2.933	2.66	3.2/3.33/3.33/ 3.46	3.06	2.8
Bus Speed (GT/s DMI)	2.5	2.5	2.5	2.5	2.5
Cache Size (MB)	8	8	4	4	3
Voltage (V)	0.65 - 1.4 V	0.65 - 1.4 V	0.65 - 1.4 V	0.65 - 1.4 V	0.65 - 1.4 V
Socket	LGA 1156				
Thermal Design Power (W)	95	95	73/87	73	73

## System Board Major Chips

Item	Specification
System Core Logic	Intel P55 Express chipset
Memory Controller	Intel P55 Express chipset
Storage Controller	Intel P55 Express chipset
PCIE Controller	Intel P55 Express chipset
LAN Controller	Intel PCI-E Gbe LAN controller PHY
Audio Controller	Realtek ALC888S-VC HD Audio Codec 7.1
Input Devices Controller	Super I/O IT8721F

## System Memory

Item	Specification		
DIMM Sockets	Four		
Memory Type	DDR3-800/1066/1333 unbuffered DIMM		
Module Name	PC3-8500/10600		
Organization	ECC		
Maximum Memory	8 GB		
Vendor	Samsung	Unifosa	Apacer
Model Name	- M378B2873EH1-CH9 - M378B2873FHS-CH9 - M378B5673EH1-CH9 - M378B5673FH0-CH9	- GU502203EP0201 - GU512303EP0202	- 75.073C1.G02 - 75.A73C1.G02
DIMM Size (GB)	1, 2	1, 2	1, 2
Pin	240	240	240

## System BIOS

Item	Specification
BIOS Vendor	American Megatrends Inc.
BIOS Version	P01-A0

## PCI Interface

Item	Specification
Number of Slots	PCI Express x 1 slot PCI Express x16 slot

## Hard Disk Drive

Item	Specification		
Vendor	WD	Seagate	HGST
Model No.	WD1600AAJS-22L7A0 WD3200AAJS-22L7A0 WD6400AAKS-22A7B2 WD10EAVS-00D7B1	ST3160815AS ST3320813AS ST3640623AS	HDT721016SLA380 HDT721032SLA380 HDT721064SLA360
Interface	SATA II	SATA II	SATA II
Size	3.5-inch	3.5-inch	3.5-inch
Transfer Rate (Gb/s)	3	3	3
Spindle Speed (RPM)	7200	7200	7200
Capacity (GB)	160, 320, 640, 1000	160, 320, 640	160, 320, 640
Cache (MB)	160/320/1000 GB: 8 640 GB: 16	160/320 GB: 8 340 GB: 16	160/320 GB: 8 640 GB: 16

---

## VGA Interface

Item	Specification
Connector	VGA/monitor port

## Network Interface

Item	Specification
LAN Controller	Intel PCI-E Gbe LAN controller PHY
Supports LAN Protocol	10/100/1000 Mbps
LAN Connector Type	RJ45

## SATA Interface

Item	Specification
SATA Controller	Embedded SATA controller
Connectors	Two onboard SATA ports

## Audio Interface

Item	Specification
Audio Controller	Realtek ALC888S-VC HD Audio Codec 7.1
Connectors	Three audio jacks

## Keyboard and Input Devices

Item	Specification
Controller	Super I/O IT8721F
Connectors	<ul style="list-style-type: none"> <li>• PS2 keyboard and mouse connector</li> <li>• Eleven USB ports (five on front and six on rear)</li> </ul>

## Optical Drive

### BD Combo Module

Item	Specification		
Vendor	HLDS		PLDS
Model name	CH20N	BH-30N/BH-20F	DH-403S/DH-6E2S
Drive type	BD-Combo	BD-Rewriter	BD-Combo
Write Speed	DVD-R2x, 4x CLV, 8x ZCLV, 8x PCAV, 12x PCAV, 16x CAV DVD-R DL 2x, 4x CLV DVD-RW2x, 4x, 6x CLV DVD-RAM2x, 3x CLV, 5x PCAV DVD+R2.4x, 4x CLV, 8x ZCLV, 8x PCAV, 12x PCAV, 16x CAV DVD+R DL2.4x, 4x CLV DVD+RW2.4x, 4x, 6x CLV, 8x ZCLV CD-R8x, 16x CLV, 24x, 32x PCAV, 40x CAV CD-RW4x, 10x, 16x CLV, 24x ZCLV	BD-R (SL/DL) 2x, 4x CLV, 6x PCAV / 2x, 4xCLV, 6xPCAV BD-R (SL L to H) 2x CLV BD-RE (SL/DL) 2x/ 2xCLV DVD-R 2x, 4x CLV, 8x ZCLV, 8x, 12x PCAV, 16xCAV DVD-R DL 2x, 4x CLV DVD-RW (SL/DL) 1x, 2x, 4x, 6x CLV / Not support DVD-RAM 2x, 3x CLV, 3-5x PCAV DVD+R 2.4x, 4x CLV, 8x ZCLV, 8x, 12x PCAV, 16x CAV DVD+R DL 2.4x, 4x CLV DVD+RW (SL/DL) 2.4x, 4x, 6x CLV, 8x ZCLV/Not support CD-R 8x, 16x CLV, 24x, 32x PCAV, 40x CAV CD-RW 4x, 10x, 16x CLV, 24x ZCLV	12X Zone CLV at DVD-R / +R 6X CLV at DVD-RW / +RW 5X CLV at DVD-RAM 4X CLV at DVD--R DL / +R DL 24X Zone CLV at CD-R / RW



**BD Combo Module**

Item	Specification		
Read Speed	BD-ROM (SL/DL)6x / 4.8x CAV BD-R (SL/DL)6x / 4.8x CAV BD-RE (SL/DL)4.8x / 4.8x CAV BDMV (AACs Compliant Disc) 4.8x CAV DVD-ROM (SL/DL)16x / 8x CAV DVD-R (SL/DL)16x / 8x CAV DVD-RW (SL/DL)10x CAV / Not support DVD+R (SL/DL)16x / 8x CAV DVD+RW (SL/DL)10x CAV / Not support DVD-RAM 2x, 3x ZCLV, 5x PCAV DVD-Video (CSS Compliant Disc) (SL/DL) 8x CAV CD-R/ROM40x CAV CD-RW 40x CAV CD-DA (DAE) 32x CAV Video CD 10x CAV 80 mm CD 10x CAV	BD-ROM (SL/DL)6x CAV/6xCAV BD-R (SL L to H) 4x CAV BD-R (SL/DL)6x CAV/6xCAV BD-RE (SL/DL)4.8x CAV / 4.8x CAV BDMV (AACs Compliant Disc) 4.8x CAV DVD-ROM (SL/DL) 16x CAV / 8x CAV DVD-R (SL/DL)16x CAV/8xCAV DVD-RW (SL/DL) 10x CAV / Not support DVD+R (SL/DL)16x CAV / 8x CAV DVD+RW (SL/DL) 10x CAV / Not support DVD-RAM 2x, 3x CLV, 3-5x PCAV DVD-Video (CSS Compliant Disc)8x CAV (SL/DL) CD-R/RW/ROM40x / 40x / 40x CAV CD-DA (DAE) 40x CAV 80 mm CD 16x CAV	12X CAV at DVD-ROM and DVD-R / +R 8X CAV at DVD-ROM DL and DVD -RW / +RW / -R DL / +R DL 5X CAV at BD-ROM / R / RE 5X CLV at DVD-RAM 2X CLV at BD-ROM DL / R DL / RE DL 32X CAV at CD-ROM and CD-R 24X CAV at CD-RW
Data Transfer Rate	BD-ROM 215.79 Mbits/s (6x) max. DVD-ROM 22.16 Mbytes/s (16x) max. CD-ROM 6,000 kB/s (40x) max.	BD-ROM 35.965 Mbits/s DVD-ROM 1.85Mbytes/s CD-ROM 150KB/s	—
Access Time	BD-ROM 180 ms typ. DVD-ROM 150 ms typ. DVD-RAM 180 ms typ. CD-ROM 150 ms typ.	BD-ROM 180 ms typ. DVD-ROM 160 ms typ. DVD-RAM 180 ms typ. CD-ROM 150 ms typ.	BD-ROM 250 ms typ. DVD-ROM 150 ms typ. DVD-RAM 180 ms typ. CD-ROM 150 ms typ.
Buffer Size	4 MB	4 MB	2 MB
Interface Type	Serial ATA	Serial ATA	Serial ATA

### Super Multi

Item	Specification	
Vendor	HLDS	PLDS
Model Name	GH-41N, GH-41F	DH-16AASH
Drive Type	Super Multi	Super Multi
Write Speed	CD-R: 4x, 8x, 16x CLV, 24x, 32x, 40x PCAV CD-RW: 4x, 10x, 16x CLV, 24x, 32x ZCLV (High Speed: 10x, Ultra Speed: 16x, 24x, US Plus: 16x, 24x, 32x) DVD+R: 2.4x, 4x, 6x CLV, 8x, 12x ZCLV, 8x, 12x PCAV, 16x CAV DVD+R DL: 2.4x, 4x, 6x CLV, 8x ZCLV DVD+RW: 2.4x, 4x, 6x CLV, 8x ZCLV (High Speed DVD+RW: 6x CLV, 8x ZCLV) DVD-R: 2x, 4x, 6x CLV, 8x ZCLV, 8x PCAV, 16x CAV DVD-R DL: 2x, 4x, 6x CLV, 8x ZCLV DVD-RW: 1x, 2x, 4x, 6x CLV DVD-RAM: 2x, 3x ZCLV, 3x-5x PCAV (Ver.2.2)	CD-R: 16x CLV, 24x 17x ~ 24x PCAV, 32x 17x ~ 32x PCAV, 40x 17x ~ 40x CAV CD-RW: 4x CLV, 10x CLV, 16x CLV, 24x 16x-24x Zone-CLV1, 16x CLV, 24x / 32x 16x-24x-32x Zone CLV2 DVD+R: 24x / 32x 16x-24x-32x Zone CLV2, 4x / 6x CLV, 8x PCAV DVD+R9: 12x / 16x CAV, 2.4x / 4x CLV, 6x / 8x Zone CLV, 12x CAV DVD+RW: 2.4x / 4x / 6x CLV 8x Zone CLV DVD-R: 4x / 6x CLV, 8x PCAV DVD-R9: 12x / 16x CAV, 4x CLV 6x / 8x Zone CLV 12x CAV DVD-RW 2x / 4x CLV, 6x Zone CLV DVD-RAM 2x / 3x / 5x / 6x CLV, 8x / 12x PCAV

## Super Multi

Item	Specification	
Read Speed	CD-R/RW/ROM:40x/40x/40x max. CD-DA (DAE):40x max. 80 mm CD:10x max DVD+R/+RW:10x / 8x max. DVD+R DL:8x max. DVD-R/RW/ROM(SL/DL):10x / 8x / 16x / 12x max. DVD-R DL:8x max. DVD-RAM (Ver.1.0/2.2):2x/ 3x-5x PCAV	CD-ROM: 4x / 8x CLV, 4x~10x / 6.4x~16x / 9.6x~24x / 12.8x~32x / 16x~40x / 19.2x~48x CAV CD-RW: 4x / 8x CLV, 4x~10x / 6.4x~16x / 9.6x~24x / 12.8x~32x / 16x~40x CAV CD-R/RW: 8x CLV DVD-ROM (single layer): 1.6x~4x / 2.4x~6x / 3.2x~8x / 4.8x~12x / 6.4x~16x CAV DVD-ROM (dual layer): 1.6x~4x / 2.4x~6x / 3.2x~8x / 4.8x~12x DVD+R: 2.4x / 4x CLV, 2.4x~6x / 3.2x~8x / 4.8x~12x / 6.4x~16x CAV DVD-R: 2x / 4x CLV, 2.4x~6x / 3.2x~8x / 4.8x~12x / 6.4x~16x DVD+RW: 2.4x / 4x CLV, 2.4x~6x / 3.2x~8x / 4.8x~12x CAV DVD-RW: 2x / 4x CLV, 2.4x~6x / 3.2x~8x / 4.8x~12x CAV DVD+R9: 4x / 8x CLV, 2.4x~6x / 3.2x~8x / 4.8x~12x CAV DVD-R9: 2x / 4x CLV, 2x / 3x / 5x / 6x CAV DVD-RAM: 2x / 3x / 5x / 6x CLV, 8x / 12x PCAV
Data Transfer Rate	CD-ROM:6,000 kB/s (40x) max. DVD-ROM:22.16 MB/s (16x) max.	CD-ROM: 7150 KB/s DVD-ROM: 20.85 MB/s
Access Time	CD-ROM: 125 ms DVD-ROM: 145 ms	CD-ROM: 140 ms DVD-ROM: 160/180 ms
Buffer Size	2 MB	2 MB
Interface Type	Serial ATA	Serial ATA

