

**TOSHIBA**

Leading Innovation >>>

# User's Manual

**Satellite C650/C655/C665**  
**Satellite Pro C650/C665**  
**Series**

## Table of Contents

Copyright.....	v
Disclaimer .....	v
Trademarks .....	v
FCC information .....	vi
EU Declaration of Conformity .....	vii
Video Standard Notice .....	viii
Canadian regulatory information (Canada only) .....	viii
Following information is only valid for EU-member States: .....	ix
Disposing of the computer and the computer's batteries .....	ix
REACH - Compliance Statement .....	x
Following information is only for Turkey: .....	x
Optical disc drive safety instructions .....	x
Precautions .....	xii
<b>Preface</b>	
Conventions .....	xiii
<b>General Precautions</b>	
Provide adequate ventilation.....	xv
Creating a computer-friendly environment .....	xv
Stress injury .....	xvi
Heat injury .....	xvi
Pressure or impact damage .....	xvi
Mobile phones .....	xvii
Instruction Manual for Safety and Comfort .....	xvii
<i>Chapter 1</i> <b>Getting Started</b>	
Equipment checklist.....	1-1
Getting Started .....	1-2
System Recovery Options .....	1-11
System Recovery .....	1-12
<i>Chapter 2</i> <b>The Grand Tour</b>	
Front with the display closed .....	2-1
Left side.....	2-2

	Right side . . . . .	2-4
	Back . . . . .	2-5
	Underside . . . . .	2-6
	Front with the display open . . . . .	2-7
	Indicators . . . . .	2-9
	Optical disc drives . . . . .	2-10
	AC adaptor . . . . .	2-11
<i>Chapter 3</i>	<b>Hardware, Utilities and Options</b>	
	Hardware . . . . .	3-1
	Special features . . . . .	3-6
	Utilities and Applications . . . . .	3-8
	Optional devices . . . . .	3-11
	Optional accessories . . . . .	3-24
<i>Chapter 4</i>	<b>Operating Basics</b>	
	Using the Touch Pad . . . . .	4-1
	Web Camera . . . . .	4-2
	Using the TOSHIBA Face Recognition . . . . .	4-3
	Using optical disc drives . . . . .	4-6
	Writing CD/DVDs . . . . .	4-10
	TOSHIBA VIDEO PLAYER . . . . .	4-16
	Media care . . . . .	4-18
	Sound System . . . . .	4-18
	Wireless communications . . . . .	4-20
	LAN . . . . .	4-23
	Computer Handling . . . . .	4-25
	Heat dispersal . . . . .	4-26
<i>Chapter 5</i>	<b>The Keyboard</b>	
	Typewriter keys . . . . .	5-1
	Function keys: F1 ... F9 . . . . .	5-2
	Soft keys: FN key combinations . . . . .	5-2
	Hot keys . . . . .	5-2
	Windows special keys . . . . .	5-4
	Generating ASCII characters . . . . .	5-5
<i>Chapter 6</i>	<b>Power and Power-Up Modes</b>	
	Power conditions . . . . .	6-1
	Monitoring of power condition . . . . .	6-2
	Battery . . . . .	6-3
	Password Utility . . . . .	6-9
	Starting the computer by password . . . . .	6-10
	Power-up modes . . . . .	6-10
	Panel power on/off . . . . .	6-11

	System automatic Sleep/Hibernation .....	6-11
<i>Chapter 7</i>	<b>HW Setup</b>	
	Accessing HW Setup .....	7-1
	HW Setup window .....	7-1
<i>Chapter 8</i>	<b>Troubleshooting</b>	
	Problem solving process .....	8-1
	Hardware and system checklist .....	8-3
	TOSHIBA support .....	8-17
<i>Appendix A</i>	<b>Specifications</b>	
	Physical Dimensions .....	A-1
	Environmental Requirements .....	A-1
	External RGB monitor port pin assignment .....	A-2
<i>Appendix B</i>	<b>Display Controller and Video mode</b>	
	Display controller .....	B-1
	Video mode .....	B-1
<i>Appendix C</i>	<b>Information for Wireless Devices</b>	
	Wireless LAN Interoperability .....	C-1
	Bluetooth wireless technology Interoperability .....	C-1
	CAUTION about Wireless Devices .....	C-2
	Wireless Devices and your health .....	C-2
	Radio Regulatory Information .....	C-3
	Radio approvals for wireless devices .....	C-8
<i>Appendix D</i>	<b>AC Power Cord and Connectors</b>	
	Certification agencies .....	D-1
<i>Appendix E</i>	<b>Legal Footnotes</b>	
	Non-applicable Icons .....	E-1
	CPU .....	E-1
	Memory (Main System) .....	E-2
	Battery Life .....	E-3
	Hard Disk Drive (HDD) Capacity .....	E-3
	LCD .....	E-3
	Graphics Processing Unit ("GPU") .....	E-3
	Wireless LAN .....	E-4
	Copy Protection .....	E-4
	<b>Glossary</b>	
	<b>Index</b>	

---

## Copyright

© 2011 by TOSHIBA Corporation. All rights reserved. Under the copyright laws, this manual cannot be reproduced in any form without the prior written permission of TOSHIBA. No patent liability is assumed, with respect to the use of the information contained herein.

First edition February 2011

Copyright authority for music, movies, computer programs, databases and other intellectual property covered by copyright laws belongs to the author or to the copyright owner. Copyrighted material can be reproduced only for personal use or use within the home. Any other use beyond that stipulated above (including conversion to digital format, alteration, transfer of copied material and distribution on a network) without the permission of the copyright owner is a violation of copyright or author's rights and is subject to civil damages or criminal action. Please comply with copyright laws in making any reproduction from this manual.

## Disclaimer

This manual has been validated and reviewed for accuracy. The instructions and descriptions it contains are accurate for your computer at the time of this manual's production. However, succeeding computers and manuals are subject to change without notice. TOSHIBA assumes no liability for damages incurred directly or indirectly from errors, omissions or discrepancies between the computer and the manual.

## Trademarks

Intel, Intel SpeedStep, Intel Core and Centrino are trademarks or registered trademarks of Intel Corporation.

Windows, Microsoft and Windows logo are registered trademarks of Microsoft Corporation.

Bluetooth is a trademark owned by its proprietor and used by TOSHIBA under license.

HDMI, the HDMI logo and High-Definition Multimedia Interface are trademarks or registered trademarks of HDMI Licensing LLC.

ConfigFree is a trademark of Toshiba Corporation.

Wi-Fi is a registered trademark of the Wi-Fi Alliance.

Secure Digital and SD are trademarks of SD Card Association.

MultiMediaCard and MMC are trademarks of MultiMediaCard Association.

Labelflash is a trademark of YAMAHA CORPORATION.

Atheros is a registered trademark of Atheros Communication, Inc.

Realtek is a registered trademark of Realtek Semiconductor Corporation.

Other trademarks and registered trademarks not listed above may be used in this manual.

---

## FCC information

### FCC notice "Declaration of Conformity Information"

This equipment has been tested and found to comply with the limits for a Class B digital device, pursuant to part 15 of the FCC rules. These limits are designed to provide reasonable protection against harmful interference in a residential installation. This equipment generates, uses and can radiate radio frequency energy and, if not installed and used in accordance with the instructions, may cause harmful interference to radio communications. However, there is no guarantee that interference will not occur in a particular installation. If this equipment does cause harmful interference to radio or television reception, which can be determined by turning the equipment off and on, the user is encouraged to try to correct the interference by one or more of the following measures:

- Reorient or relocate the receiving antenna.
- Increase the separation between the equipment and receiver.
- Connect the equipment into an outlet on a circuit different from that to which the receiver is connected.
- Consult the dealer or an experienced radio/TV technician for help.



*Only peripherals complying with the FCC class B limits may be attached to this equipment. Operation with non-compliant peripherals or peripherals not recommended by TOSHIBA is likely to result in interference to radio and TV reception. Shielded cables must be used between the external devices and the computer's external monitor port, Universal Serial Bus (USB 2.0) ports, HDMI port and microphone jack. Changes or modifications made to this equipment, not expressly approved by TOSHIBA or parties authorized by TOSHIBA could void the user's authority to operate the equipment.*

### FCC conditions

This device complies with part 15 of the FCC Rules. Operation is subject to the following two conditions:

1. This device may not cause harmful interference.
2. This device must accept any interference received, including interference that may cause undesired operation.

### Contact

**Address:** TOSHIBA America Information Systems, Inc.  
9740 Irvine Boulevard  
Irvine, California 92618-1697

**Telephone:** (949) 583-3000

---

## EU Declaration of Conformity



This product is carrying the CE-Mark in accordance with the related European Directives. Responsible for CE-Marking is TOSHIBA Europe GmbH, Hammfelddamm 8, 41460 Neuss, Germany. The complete and official EU Declaration of Conformity can be found on TOSHIBA's web site <http://epps.toshiba-teg.com> on the Internet.

### CE compliance

This product is labelled with the CE Mark in accordance with the related European Directives, notably Electromagnetic Compatibility Directive 2004/108/EC for the notebook and the electronic accessories including the supplied power adapter, the Radio Equipment and Telecommunications Terminal Equipment Directive 1999/5/EC in case of implemented telecommunication accessories and the Low Voltage Directive 2006/95/EC for the supplied power adapter. Furthermore the product complies with the Ecodesign Directive 2009/125/EC (ErP) and its related implementing measures.

This product and the original options are designed to observe the related EMC (Electromagnetic Compatibility) and safety standards. However, TOSHIBA cannot guarantee that this product still observes these EMC standards if options or cables not produced by TOSHIBA are connected or implemented. In this case the persons who have connected/implemented those options/cables have to provide assurance that the system (PC plus options/cables) still fulfils the required standards. To avoid general EMC problems, the following guidance should be noted:

- Only CE marked options should be connected/implemented
- Only best shielded cables should be connected

### Working environment

This product was designed to fulfil the EMC (Electromagnetic Compatibility) requirements to be observed for so-called "Residential, commercial and light industry environments". TOSHIBA do not approve the use of this product in working environments other than the above mentioned "Residential, commercial and light industry environments".

For example, the following environments are not approved:

- Industrial Environments (e.g. environments where a mains voltage of 380 V three-phase is used)
- Medical Environments
- Automotive Environments
- Aircraft Environments

Any consequences resulting from the use of this product in working environments that are not approved are not the responsibility of TOSHIBA.

---

The consequences of the use of this product in non-approved working environments may be:

- Interference with other devices or machines in the near surrounding area.
- Malfunction of, or data loss from, this product caused by disturbances generated by other devices or machines in the near surrounding area.

Therefore TOSHIBA strongly recommend that the electromagnetic compatibility of this product should be suitably tested in all non-approved working environments before use. In the case of automobiles or aircraft, the manufacturer or airline respectively should be asked for permission before use of this product.

Furthermore, for general safety reasons, the use of this product in environments with explosive atmospheres is not permitted.

## Video Standard Notice

THIS PRODUCT IS LICENSED UNDER THE AVC, THE VC-1 AND MPEG-4 VISUAL PATENT PORTFOLIO LICENSE FOR THE PERSONAL AND NON-COMMERCIAL USE OF A CONSUMER FOR (I) ENCODING VIDEO IN COMPLIANCE WITH THE ABOVE STANDARDS ("VIDEO") AND/OR (II) DECODING AVC, VC-1 AND MPEG-4 VIDEO THAT WAS ENCODED BY A CONSUMER ENGAGED IN A PERSONAL AND NONCOMMERCIAL ACTIVITY AND/OR WAS OBTAINED FROM A VIDEO PROVIDER LICENSED BY MPEG LA TO PROVIDE SUCH VIDEO. NO LICENSE IS GRANTED OR SHALL BE IMPLIED FOR ANY OTHER USE. ADDITIONAL INFORMATION INCLUDING THAT RELATING TO PROMOTIONAL, INTERNAL AND COMMERCIAL USES AND LICENSING MAY BE OBTAINED FROM MPEG LA, L.L.C. SEE [HTTP://WWW.MPEGLA.COM](http://www.mpegla.com).

## Canadian regulatory information (Canada only)

This digital apparatus does not exceed the Class B limits for radio noise emissions from digital apparatus as set out in the Radio Interference Regulation of the Canadian Department of Communications.

Note that Canadian Department of Communications (DOC) regulations provide, that changes or modifications not expressly approved by TOSHIBA Corporation could void your authority to operate this equipment.

This Class B digital apparatus meets all requirements of the Canadian Interference-Causing Equipment Regulations.

Cet appareil numérique de la class B respecte toutes les exigences du Règlement sur le matériel brouilleur du Canada.



---

## Following information is only valid for EU-member States:

### Disposal of products

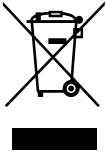

The crossed out wheeled dust bin symbol indicates that products must be collected and disposed of separately from household waste. Integrated batteries and accumulators can be disposed of with the product. They will be separated at the recycling centres.

The black bar indicates that the product was placed on the market after August 13, 2005.

By participating in separate collection of products and batteries, you will help to assure the proper disposal of products and batteries and thus help to prevent potential negative consequences for the environment and human health.

For more detailed information about the collection and recycling programmes available in your country, please visit our website (<http://eu.computers.toshiba-europe.com>) or contact your local city office or the shop where you purchased the product.

### Disposal of batteries and/or accumulators



Pb, Hg, Cd

The crossed out wheeled dust bin symbol indicates that batteries and/or accumulators must be collected and disposed of separately from household waste.

If the battery or accumulator contains more than the specified values of lead (Pb), mercury (Hg), and/or cadmium (Cd) defined in the Battery Directive (2006/66/EC), then the chemical symbols for lead (Pb), mercury (Hg) and/or cadmium (Cd) will appear below the crossed out wheeled dust bin symbol.

By participating in separate collection of batteries, you will help to assure the proper disposal of products and batteries and thus help to prevent potential negative consequences for the environment and human health.

For more detailed information about the collection and recycling programmes available in your country, please visit our website (<http://eu.computers.toshiba-europe.com>) or contact your local city office or the shop where you purchased the product.



*These symbols may not stick depending on the country and region where you purchased.*

## Disposing of the computer and the computer's batteries

- Discard this computer in accordance with applicable laws and regulations. For further information, contact your local government.
- This computer contains rechargeable batteries. After repeated use, the batteries will finally lose their ability to hold a charge and you will need to replace them. Under certain applicable laws and regulation, it may be illegal to dispose of old batteries by placing them in the trash.
- Please be kind to our shared environment. Check with your local government authority for details regarding where to recycle old batteries or how to dispose of them properly.

---

## REACH - Compliance Statement

The new European Union (EU) chemical regulation, REACH (Registration, Evaluation, Authorization and Restriction of Chemicals), entered into force on 1 June 2007. TOSHIBA will meet all REACH requirements and is committed to provide our customers with information about the chemical substances in our products according to REACH regulation.

Please consult the following website

[www.toshiba-europe.com/computers/info/reach](http://www.toshiba-europe.com/computers/info/reach) for information about the presence in our articles of substances included on the candidate list according to article 59(1) of Regulation (EC) No 1907/2006 („REACH“) in a concentration above 0.1% weight by weight.

## Following information is only for Turkey:

- **Compliant with EEE Regulations:** TOSHIBA meets all requirements of Turkish regulation 26891 "Restriction of the use of certain hazardous substances in electrical and electronic equipment".
- The number of possible pixel failures of your display is defined according to ISO 13406-2 standards. If the number of pixel failures is less than this standard, they will not be counted as defect or failure.
- Battery is a consumption product, since the battery time depends on the usage of your computer. If the battery can not be charged at all, then it is a defect or failure. The changes in battery time is not a defect or failure.

## Optical disc drive safety instructions



*Be sure to check the precautions at the end of this section.*



- *The DVD Super Multi drive model employs a laser system. To ensure proper use of this product, please read this instruction manual carefully and retain for future reference. Should the unit ever require maintenance, contact an authorized service location.*
- *Use of controls, adjustments or the performance of procedures other than those specified may result in hazardous radiation exposure.*
- *To prevent direct exposure to the laser beam, do not try to open the enclosure.*

## Panasonic System Networks

### ■ UJ8A0

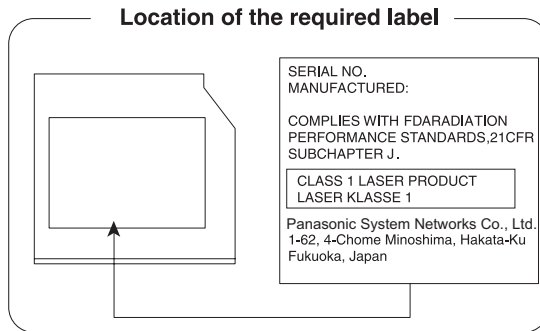

## TOSHIBA Samsung Storage Technology

### ■ TS-L633

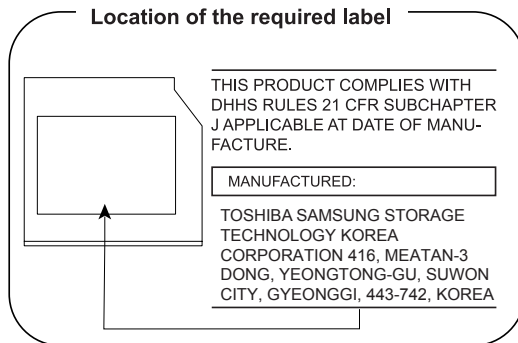

## TEAC

### ■ DV-W28S

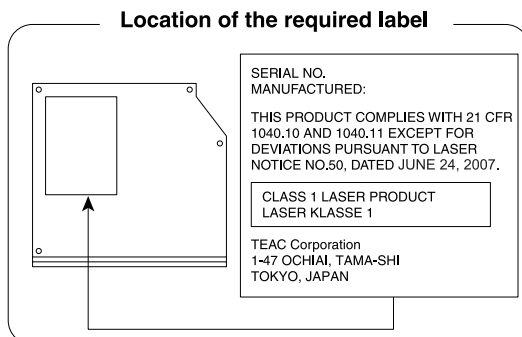

---

## HITACHI-LG Data Storage, Inc.

### ■ GT30F/30N

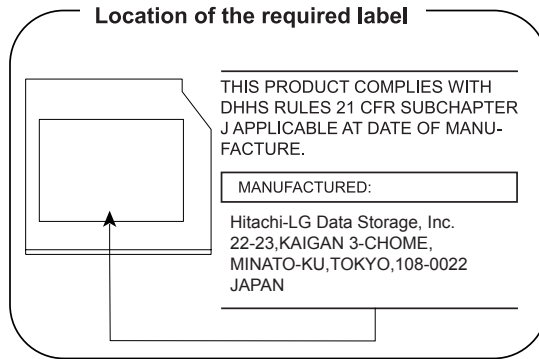

## Precautions

CLASS 1 LASER PRODUCT  
LASER KLASSE 1 PRODUKT  
TO EN 60825-1  
クラス1 レーザ 製品

**CAUTION:** *This appliance contains a laser system and is classified as a "CLASS 1 LASER PRODUCT." To use this model properly, read the instruction manual carefully and keep this manual for your future reference. In case of any trouble with this model, please contact your nearest "AUTHORIZED service station." To prevent direct exposure to the laser beam, do not try to open the enclosure.*

## Preface

Congratulations on your purchase of this computer. This powerful notebook computer provides excellent expansion capability, includes multimedia functionality, and is designed to provide years of reliable, high-performance computing.

This manual tells how to set up and begin using your computer. It also provides detailed information on configuring your computer, basic operations and care, using optional devices and troubleshooting.

If you are a new user of computers or if you're new to portable computing, first read over the Chapter 1, *Getting Started* and Chapter 3, *Hardware, Utilities and Options* chapters to familiarize yourself with the computer's features, components and accessory devices. Then read Chapter 1, *Getting Started* for step-by-step instructions on setting up your computer.

If you are an experienced computer user, please continue reading the preface to learn how this manual is organized, then become acquainted with this manual by browsing through its pages. Be sure to read the *Special features* section in Chapter 3, *Hardware, Utilities and Options* to learn about features that are uncommon or unique to this computer, as well as the section on Chapter 7, *HW Setup*, to understand how to setup and configure these features.

Read Chapter 3, *Hardware, Utilities and Options* if connecting optional products or external devices.

## Conventions

This manual uses the following formats to describe, identify, and highlight terms and operating procedures.

### Abbreviations

On first appearance, and whenever necessary for clarity, abbreviations are enclosed in parentheses following their definition. For example: Read Only Memory (ROM). Acronyms are also defined in the Glossary.

### Icons

Icons identify ports, dials, and other parts of your computer. The indicator panel also uses icons to identify the components it is providing information on.

---

## Keys

The keyboard keys are used in the text to describe many computer operations. A distinctive typeface identifies the key top symbols as they appear on the keyboard. For example, **ENTER** identifies the **ENTER** key.

## Key operation

Some operations require you to simultaneously use two or more keys. We identify such operations by the key top symbols separated by a plus sign (+). For example, **CTRL + C** means you must hold down **CTRL** and at the same time press **C**. If three keys are used, hold down the first two and at the same time press the third.

**ABC**

When procedures require an action such as clicking an icon or entering text, the icon's name or the text you are to type in is represented in the typeface you see to the left.

## Display



**ABC**

Names of windows or icons or text generated by the computer that appear on its display screen are presented in the type face you see to the left.

## Messages

Messages are used in this manual to bring important information to your attention. Each type of message is identified as shown below.



*Indicates a potentially hazardous situation, which could result in death or serious injury, if you do not follow instructions.*



*Pay attention! A caution informs you that improper use of equipment or failure to follow instructions may cause data loss or damage your equipment.*



*Please read. A note is a hint or advice that helps you make best use of your equipment.*

## Terminology

This term is defined in this document as follows:

**Start**

The word "**Start**" refers to the "" button in Windows 7.

## General Precautions

TOSHIBA computers are designed to optimize safety, minimize strain and withstand the rigors of portability. However, certain precautions should be observed to further reduce the risk of personal injury or damage to the computer.

Be certain to read the general precautions below and to note the cautions included in the text of the manual.

### Provide adequate ventilation

- Always make sure your computer and AC adaptor have adequate ventilation and are protected from overheating when the power is turned on or when an AC adaptor is connected to a power outlet (even if your computer is in Sleep Mode). In this condition, observe the following:
  - Never cover your computer or AC adaptor with any object.
  - Never place your computer or AC adaptor near a heat source, such as an electric blanket or heater.
  - Never cover or block the air vents including those located at the base of the computer.
  - Always operate your computer on a hard flat surface. Using your computer on a carpet or other soft material can block the vents.
- Always provide sufficient space around the computer.
- Overheating your computer or AC adaptor could cause system failure, computer or AC adaptor damage or a fire, possibly resulting in serious injury.

### Creating a computer-friendly environment

Place the computer on a flat surface that is large enough for the computer and any other items you are using, such as a printer.

Leave enough space around the computer and other equipment to provide adequate ventilation. Otherwise, they may overheat.

---

To keep your computer in prime operating condition, protect your work area from:

- Dust, moisture, and direct sunlight.
- Equipment that generates a strong electromagnetic field, such as stereo speakers (other than speakers that are connected to the computer) or speakerphones.
- Rapid changes in temperature or humidity and sources of temperature change such as air conditioner vents or heaters.
- Extreme heat, cold, or humidity.
- Liquids and corrosive chemicals.

## Stress injury

Carefully read the *Instruction Manual for Safety and Comfort*. It contains information on the prevention of stress injuries to your hands and wrists that can be caused by extensive keyboard use. *Instruction Manual for Safety and Comfort* also includes information on work space design, posture and lighting that can help reduce physical stress.

## Heat injury

- Avoid prolonged physical contact with the computer. If the computer is used for long periods, its surface can become very warm. While the temperature will not feel hot to the touch, if you maintain physical contact with the computer for a long time, for example if you rest the computer on your lap or if you keep your hands on the palm rest, your skin might suffer a low-heat injury.
- If the computer has been used for a long time, avoid direct contact with the metal plate supporting the various interface ports as this can become hot.
- The surface of the AC adaptor can become hot when in use but this condition does not indicate a malfunction. If you need to transport the AC adaptor, you should disconnect it and let it cool before moving it.
- Do not lay the AC adaptor on a material that is sensitive to heat as the material could become damaged.

## Pressure or impact damage

Do not apply heavy pressure to the computer or subject it to any form of strong impact as this can damage the computer's components or otherwise cause it to malfunction.



---

## **Mobile phones**

Please be aware that the use of mobile phones can interfere with the audio system. The operation of the computer will not be impaired in any way, but it is recommended that a minimum distance of 30cm is maintained between the computer and a mobile phone that is in use.

## **Instruction Manual for Safety and Comfort**

All important information on the safe and proper use of this computer is described in the enclosed Instruction Manual for Safety and Comfort. Be sure to read it before using the computer.

## Chapter 1

### Getting Started

This chapter provides an equipment checklist, and basic information to start using your computer.



*Some of the features described in this manual may not function properly if you use an operating system that was not pre-installed by TOSHIBA.*

### Equipment checklist

Carefully unpack your computer, taking care to save the box and packaging materials for future use.

#### Hardware

Check to make sure you have all the following items:

- TOSHIBA Portable Personal Computer
- AC adaptor and power cord (2-pin plug or 3-pin plug)
- Battery pack (installed in the computer)

#### Documentation

- User Information Guide
- Instruction Manual for Safety and Comfort

If any of the items are missing or damaged, contact your dealer immediately.

#### Software

The following Windows® operating system and utility software are pre-installed.

- Windows 7
- TOSHIBA Value Added Package
- TOSHIBA Recovery Media Creator

- TOSHIBA VIDEO PLAYER
- TOSHIBA Assist
- TOSHIBA ConfigFree™
- TOSHIBA Disc Creator
- TOSHIBA Face Recognition
- TOSHIBA Bulletin Board
- TOSHIBA ReelTime
- TOSHIBA Speech System
- TOSHIBA Media Controller
- Online Manual
  - Satellite C650/C655/C665/Satellite Pro C650/C665 Series User's Manual (This manual)

\* You may not have all the softwares listed above depending on the model you purchased.

## Getting Started



- *All users should be sure to read the section [Starting up for the first time](#).*
- *Be sure to read the enclosed [Instruction Manual for Safety and Comfort](#) for information on the safe and proper use of this computer. It is intended to help you be more comfortable and productive while using a notebook computer. By following the recommendations in it you may reduce your chance of developing a painful or disabling injury to your hand, arms, shoulders or neck.*

This section provides basic information to start using your computer. It covers the following topics:

- Connecting the AC adaptor
- Opening the display
- Turning on the power
- Starting up for the first time
- Turning off the power
- Restarting the computer
- System Recovery Options
- Creating Recovery Media
- Restoring the pre-installed software from the Recovery hard disk drive
- Restoring the pre-installed software from your created Recovery Media



- *Use a virus-check program and make sure it is updated regularly.*
- *Never format storage media without checking its content - formatting destroys all stored data.*
- *It is a good idea to periodically back up the internal hard disk drive or other main storage device to external media. General storage media is not durable or stable over long periods of time and under certain conditions may result in data loss.*
- *Before you install a device or application, save any data in memory to the hard disk drive or other storage media. Failure to do so may result in the loss of data.*

## Connecting the AC adaptor

Attach the AC adaptor when you need to charge the battery or you want to operate from AC power. It is also the fastest way to get started, because the battery pack will need to be charged before you can operate from battery power.

The AC adaptor can be connected to any power source supplying from 100 to 240 volts and 50 or 60 hertz. For details on using the AC adaptor to charge the battery pack, refer to Chapter 6, [Power and Power-Up Modes](#).



- *Always use the TOSHIBA AC adaptor that was included with your computer, or use AC adaptors specified by TOSHIBA to avoid any risk of fire or other damage to the computer. Use of an incompatible AC adaptor could cause fire or damage to the computer possibly resulting in serious injury. TOSHIBA assumes no liability for any damage caused by use of an incompatible adaptor.*
- *Never plug the AC adaptor into a power source that does not correspond to both the voltage and the frequency specified on the regulatory label of the unit. Failure to do so could result in a fire or electric shock, possibly resulting in serious injury.*
- *Always use or purchase power cables that comply with the legal voltage and frequency specifications and requirements in the country of use. Failure to do so could result in a fire or electric shock, possibly resulting in serious injury.*
- *The supplied power cord conforms to safety rules and regulations in the region the product is bought and should not be used outside this region. For use in other regions, please buy power cords that conform to safety rules and regulations in the particular region.*
- *Do not use a 3-pin to 2-pin conversion plug.*
- *When you connect the AC adaptor to the computer, always follow the steps in the exact order as described in the User's Manual. Connecting the power cable to a live electrical outlet should be the last step otherwise the adaptor DC output plug could hold an electrical charge and cause an electrical shock or minor bodily injury when touched. As a general safety precaution, avoid touching any metal parts.*
- *Never place your computer or AC adaptor on a wooden surface, furniture, or any other surface that could be marred by exposure to heat since the computer base and AC adaptor's surface increase in temperature during normal use.*
- *Always place your computer or AC adaptor on a flat and hard surface that is resistant to heat damage.*

*Refer to the enclosed Instruction Manual for Safety and Comfort for detailed precautions and handling instructions.*

1. Connect the power cord to the AC adaptor.

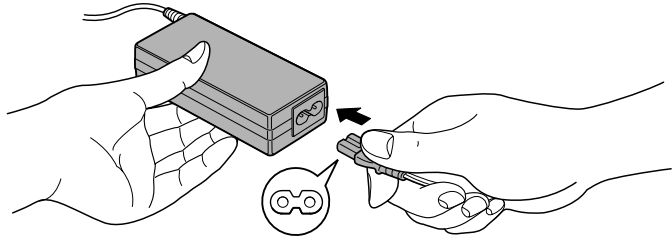

*Figure 1-1 Connecting the power cord to the AC adaptor (2-pin plug)*

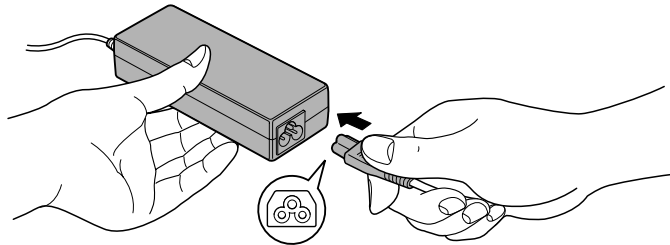
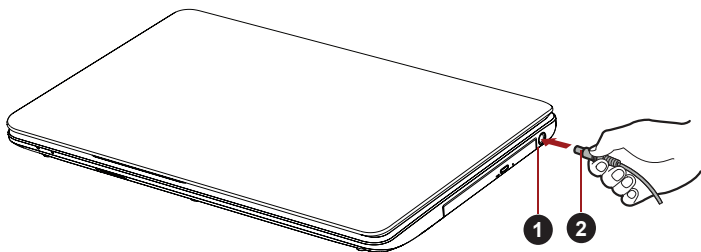

*Figure 1-2 Connecting the power cord to the AC adaptor (3-pin plug)*



*Either a 2-pin or 3-pin adaptor/cord will be included with the computer depending on the model.*

2. Connect the AC adaptor's DC output plug to the DC IN 19V jack on the right side of the computer.



1. DC IN 19V jack
2. DC output plug

*Figure 1-3 Connecting the DC output plug to the computer*

3. Plug the power cord into a live wall outlet - the **DC IN/Battery** indicator on the front of the computer should glow.

## Opening the display

The display panel can be opened to a wide range of angles for optimal viewing.

While holding down the palm rest with one hand so that the main body of the computer is not raised, slowly lift the display panel - this will allow the angle of the display panel to be adjusted to provide optimum clarity.

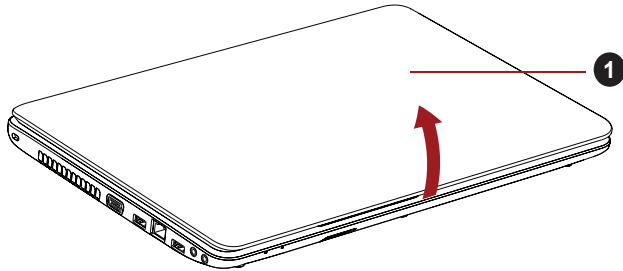

### 1. Display panel

*Figure 1-4 Opening the display panel*



*Use reasonable care when opening and closing the display panel. Opening it vigorously or slamming it shut could damage the computer.*



- *Be careful not to open the display panel too far as this could put stress on the display panel's hinges and cause damage.*
- *Do not press or push on the display panel.*
- *Do not lift the computer by the display panel.*
- *Do not close the display panel with pens or any other objects left in between the display panel and the keyboard.*
- *When opening or closing the display panel, place one hand on the palm rest to hold the computer in place and use the other hand to slowly open or close the display panel (Do not use excessive force when opening or closing the display panel).*

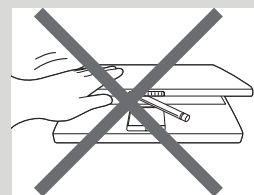
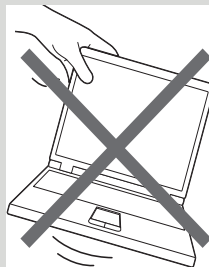
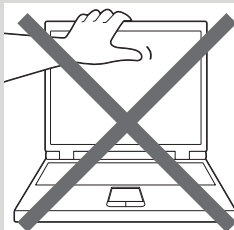

## Turning on the power

This section describes how to turn on the power - the **Power** indicator will then indicate the status. Please refer to the [Monitoring of power condition](#) section in Chapter 6, Power and Power-Up Modes for more information.



- After you turn on the power for the first time, do not turn it off until you have set up the operating system. Please refer to the section [Starting up for the first time](#) for more information.
- Volume cannot be adjusted during Windows Setup.

1. Open the display panel.
2. Press and hold the computer's power button for two or three seconds.

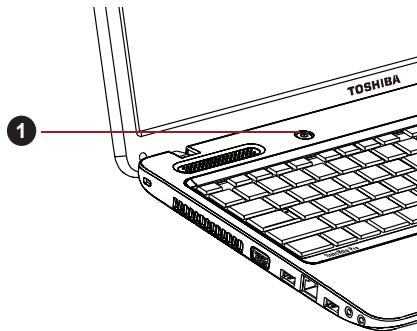

1. Power button

Figure 1-5 Turning on the power

## Starting up for the first time

The Windows 7 Startup Screen will be the first screen displayed when you turn on the power. Follow the on-screen instructions on each screen in order to properly install the operating system.



When it is displayed, be sure to read the **Software License Terms** carefully.

## Turning off the power

The power can be turned off in one of three modes, either Shut Down Mode, Hibernation Mode or Sleep Mode.

### Shut Down Mode

When you turn off the power in Shut Down Mode no data will be saved and the computer will boot to the operating system's main screen the next time it is turned on.

1. If you have entered data, either save it to the hard disk drive or to other storage media.



2. Make sure all disk/disc activity has stopped before removing the CD/DVD.



- *Make sure the **Optical Disc Drive** indicator is off. If you turn off the power while a disk (disc) is being accessed, you may lose data or damage the disk.*
- *Never turn off the power while an application is running. Doing so could cause loss of data.*
- *Never turn off the power, disconnect an external storage device or remove storage media during data read/write. Doing so can cause data loss.*

3. Click **Start**.
4. Click the **Shut down** button (  ).
5. Turn off any peripheral devices connected to your computer.



*Do not turn the computer or peripheral devices back on immediately - wait a short period to avoid any potential damage.*

### **Sleep Mode**

If you have to interrupt your work, you are able to turn off the power without exiting from your software by placing the computer into Sleep Mode. In this mode data is maintained in the computer's main memory so that when you turn on the power again, you can continue working right where you left off.



*When you have to turn off your computer aboard an aircraft or in places where electronic devices are regulated or controlled, always completely shut down the computer. This includes turning off any wireless communication functionalities, and cancelling settings that reactivate the computer automatically, such as a timer recording function. Failure to completely shut down the computer in this way could allow the operating system to reactivate and run pre-programmed tasks or preserve unsaved data, which could interfere with aviation or other systems, possibly causing serious injury.*



- *Before entering Sleep Mode, be sure to save your data.*
- *Do not install or remove a memory module while the computer is in Sleep Mode. The computer or the memory module could be damaged.*
- *Do not remove the battery pack while the computer is in Sleep Mode (unless the computer is connected to an AC power source). Data in memory could be lost.*



- *When the AC adaptor is connected, the computer will go into Sleep Mode according to the settings in the Power Options (to access it, click **Start** -> **Control Panel** -> **System and Security** -> **Power Options**).*
- *To restore the operation of the computer from Sleep Mode, press and hold the power button or any key on the keyboard for a short amount of time. Please note that keyboard keys can only be used if the Wake-up on Keyboard option is enabled within the HW Setup utility.*
- *If the computer enters Sleep Mode while a network application is active, the application might not be restored when the computer is next turned on and the system returns from Sleep Mode.*
- *To prevent the computer from automatically entering Sleep Mode, disable Sleep Mode within the Power Options (to access it, click **Start** -> **Control Panel** -> **System and Security** -> **Power Options**).*
- *To use the Hybrid Sleep function, configure it in the Power Options.*

### *Benefits of Sleep Mode*

The Sleep Mode feature provides the following benefits:

- Restores the previous working environment more rapidly than does the Hibernation Mode feature.
- Saves power by shutting down the system when the computer receives no input or hardware access for the time period set by the System Sleep Mode feature.
- Allows the use of the panel power off feature.

### *Executing Sleep Mode*



*You can also enable Sleep Mode by pressing **FN + F3** - please refer to Chapter 5, [The Keyboard](#), for further details.*

You can enter Sleep Mode in one of the following ways:

- Click **Start**, point to the arrow icon (  ) and then select **Sleep** from the menu.
- Close the display panel. Please note that this feature must be enabled within the Power Options (to access it, click **Start** -> **Control Panel** -> **System and Security** -> **Power Options**).
- Press the power button. Please note that this feature must be enabled within the Power Options (to access it, click **Start** -> **Control Panel** -> **System and Security** -> **Power Options**).

When you turn the power back on, you can continue where you left when you shut down the computer.



- *When the computer is in Sleep Mode, the power indicator will blink green.*
- *If you are operating the computer on battery power, you can lengthen the overall operating time by turning it off into Hibernation Mode - Sleep Mode will consume more power while the computer is off.*

### *Sleep Mode limitations*

Sleep Mode will not function under the following conditions:

- Power is turned back on immediately after shutting down.
- Memory circuits are exposed to static electricity or electrical noise.

### *Hibernation Mode*

The Hibernation Mode feature saves the contents of memory to the hard disk drive when the computer is turned off so that, the next time it is turned on, the previous state is restored. Please note that the Hibernation Mode feature does not save the status of any peripheral devices connected to the computer.



- *Save your data. While entering Hibernation Mode, the computer saves the contents of memory to the hard disk drive. However, for safety sake, it is best to save your data manually.*
- *Data will be lost if you remove the battery or disconnect the AC adaptor before the save is completed.*
- *Do not install or remove a memory module while the computer is in Hibernation Mode. Data will be lost.*

### *Benefits of Hibernation Mode*

The Hibernation Mode feature provides the following benefits:

- Saves data to the hard disk drive when the computer automatically shuts down because of a low battery condition.
- You can return to your previous working environment immediately when you turn on the computer.
- Saves power by shutting down the system when the computer receives no input or hardware access for the time period set by the System Hibernate feature.
- Allows the use of the panel power off feature.

### *Starting Hibernation Mode*



*You can also enable Hibernation Mode by pressing **FN + F4** - please refer to Chapter 5, [The Keyboard](#), for further details.*

To enter Hibernation Mode, follow the steps below.

1. Click **Start**.
2. Point to the arrow icon (  ) and then select **Hibernate** from the menu.

### *Automatic Hibernation Mode*

The computer can be configured to enter Hibernation Mode automatically when you press the power button or close the lid. In order to define these settings, you can follow the steps as described below:

1. Click **Start** and click the **Control Panel**.
2. Click **System and Security** and click **Power Options**.

3. Click **Choose what the power button does** or **Choose what closing the lid does**.
4. Enable the desired Hibernation Mode settings for **When I press the power button** and **When I close the lid**.
5. Click the **Save changes** button.

### *Data save in Hibernation Mode*

When you turn off the power in Hibernation Mode, the computer will take a moment to save the current data in memory to the hard disk drive.

After you turn off the computer, and the content of memory has been saved to the hard disk drive, turn off the power to any peripheral devices.



*Do not turn the computer or devices back on immediately. Wait a moment to let all capacitors fully discharge.*

## Restarting the computer

Certain conditions require that you reset the computer, for example if:

- You change certain computer settings.
- An error occurs and the computer does not respond to your keyboard commands.

If you need to restart the computer, there are three ways this can be achieved:

- Click **Start**, point to the arrow icon (  ) and then select **Restart** from the menu.
- Press **CTRL**, **ALT** and **DEL** simultaneously (once) to display the menu window, then select **Restart** from the **Shut down options**.
- Press the power button and hold it down for five seconds. Once the computer has turned itself off, wait between ten and fifteen seconds before turning the power on again by pressing the power button.

## System Recovery Options

There is a hidden partition allocated on the hard disk drive for the System Recovery Options.

This partition stores files which can be used to repair the system in the event of a problem.



*The System Recovery Options feature will be unusable if this partition is deleted.*

## System Recovery Options

The System Recovery Options feature is installed on the hard disk when shipped from the factory. The System Recovery Options menu includes tools to repair startup problems, run diagnostics or restore the system.

See the **Windows Help and Support** content for more information about **Startup Repair**.

The System Recovery Options can also be run manually to repair problems.

The procedure is as follows. Follow the instructions shown on the on-screen menu.

1. Turn off the computer.
2. While holding the **F8** key, turn on the computer.
3. The **Advanced Boot Options** menu will be displayed. Use the arrow keys to select **Repair Your Computer** and press **ENTER**.
4. Follow the on-screen instructions.



*Check your Windows® manual for more information on backing up your system (including the system image backup feature).*

## System Recovery

This section describes the creation of Recovery Media and their use.

### Creating Recovery Media

This section describes how to create Recovery Media.



- *Be sure to connect the AC adaptor when you create Recovery Media.*
- *Be sure to close all other software programs except the Recovery Media Creator.*
- *Do not run software such as screen savers which can put a heavy load on the CPU.*
- *Operate the computer at full power.*
- *Do not use power-saving features.*
- *Do not write to the media when the virus check software is running. Wait for it to finish, then disable virus detection programs including any software that checks files automatically in the background.*
- *Do not use utilities, including those intended to enhance hard disk drive access speed. They may cause unstable operation and damage data.*
- *Do not shut down/log off or Sleep/Hibernate while writing or rewriting the media.*
- *Set the computer on a level surface and avoid places subjected to vibrations such as airplanes, trains, or cars.*
- *Do not use on an unstable surface such as a stand.*

A recovery image of the software on your computer is stored on the hard disk drive, and can be copied to either DVD or USB Flash Memory by using the following steps:

1. Select either blank DVD or USB Flash Memory.

The application will allow you to choose from a variety of different media onto which the recovery image can be copied including DVD-R, DVD-R DL, DVD-RW, DVD+R, DVD+R DL, DVD+RW and USB Flash Memory.



- *Please note that some of the above media may not be compatible with the optical disc drive installed into your computer. You should therefore verify the optical disc drive supports the blank media you have chosen before proceeding.*
- *USB Flash Memory will be formatted and all the data in the USB Flash Memory will be lost when proceeding.*

2. Turn on your computer and allow it to load the Windows 7 operating system from the hard disk drive as normal.
3. Insert the media into the computer.
  - Insert the first blank disc into the optical disc drive tray, or Insert the USB Flash Memory into one available USB port
4. Double click the **Recovery Media Creator** icon on the Windows 7 desktop, or select the application from **Start** Menu.
5. After Recovery Media Creator starts, select the type of media and the title you wish to copy, and then click the **Create** button.

## Restoring the pre-installed software from the Recovery hard disk drive

A portion of the total hard disk drive space is configured as a hidden recovery partition. This partition stores files which can be used to restore pre-installed software in the event of a problem.

If you subsequently set up your hard disk drive again, do not change, delete or add partitions in a manner other than specified in the manual, otherwise you may find that space for the required software is not available.

In addition, if you use a third-party partitioning program to reconfigure the partitions on your hard disk drive, you may find that it becomes impossible to setup your computer.



*When the sound mute feature has been activated by pressing the **FN + ESC** key, be sure to disable this to allow sounds to be heard before starting the restore process. Please refer to Chapter 5, [The Keyboard](#), for further details.*

*You can not use System Recovery Options if restoring the pre-installed software without System Recovery Options.*



*When you reinstall the Windows operating system, the hard disk will be reformatted and all data will be lost.*

1. Turn off your computer.
2. While holding down **0** (zero) key on the keyboard, turn on your computer.
3. A menu will be displayed from which you should follow the on-screen instructions.

## Restoring the pre-installed software from your created Recovery Media

If the pre-installed files are damaged, you are able to either use the Recovery Media you have created or the hard disk drive recovery process to restore the computer to the state it was in when you originally received it. To perform this restoration, follow the steps below:



*When the sound mute feature has been activated by pressing the **FN + ESC** key, be sure to disable this to allow sounds to be heard before starting the restore process. Please refer to Chapter 5, [The Keyboard](#), for further details.*

*You can not use System Recovery Options if restoring the pre-installed software without System Recovery Options.*



*When you reinstall the Windows operating system, the hard disk will be reformatted and all data will be lost.*

1. Load the Recovery Media into the computer and turn off the computer's power.
2. While holding down **F12** key on the keyboard, turn on your computer - when the **TOSHIBA Leading Innovation >>>** logo screen appears, release the **F12** key.
3. Use the up and down cursor key to select the appropriate option from the menu according to your actual recovery media. Please refer to the [Boot Setting](#) section in Chapter 7, HW Setup for further information.
4. A menu will be displayed from which you should follow the on-screen instructions.



*When drivers/utilities are installed, you can setup the respective drivers/utilities from the following place. To open the setup files, Click **Start -> All Programs -> TOSHIBA -> Applications and Drivers**.*

## Chapter 2

### The Grand Tour

This chapter identifies the various components of the computer - it is recommended that you become familiar with each before you operate the computer.

#### **Legal Footnote (Non-applicable Icons)**

For more information regarding Non-applicable Icons, please refer to the Legal Footnotes section in Appendix E.



*Please handle your computer carefully to avoid scratching or damaging the surface.*

### Front with the display closed

The following figure shows the computer's front with its display panel in the closed position.

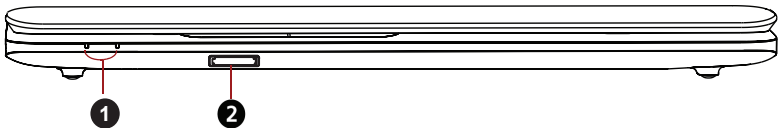

1. System indicators

2. Memory media slot

*Figure 2-1 Front of the computer with display panel closed*

---

#### **System indicators**

These LED indicators allow you to monitor the status of various computer functions and are described in more detail within the [System indicators](#) section.

---



**Memory media slot**

This slot lets you insert an SD™/SDXC™ memory card, miniSD™/microSD™ Card and MultiMediaCard™. Refer to the [Optional devices](#) section in Chapter 3, Hardware, Utilities and Options.

## Left side

The following figured show the computer's left side.

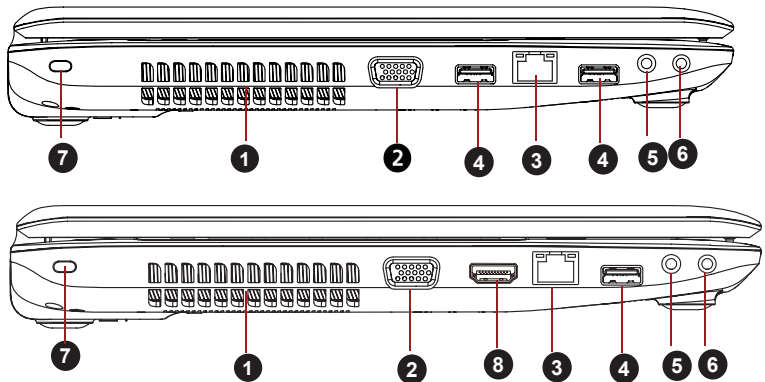

- |   |                       |
|---|-----------------------|
| 1. Cooling vents                          | 6. Headphone jack     |
| 2. External monitor port                  | 7. Security lock slot |
| 3. LAN jack                               | 8. HDMI out port*     |
| 4. Universal Serial Bus (USB 2.0) port(s) |                       |
| 5. Microphone jack                        |                       |

\* Provided with some models.

Product appearance depends on the model you purchased.

*Figure 2-2 The left side of the computer*

**Universal Serial Bus (USB 2.0) port(s)**

Universal Serial Bus ports, which comply to the USB 2.0 standard.



*Keep foreign metal objects, such as screws, staples and paper clips, out of the USB connectors. Foreign metal objects can create a short circuit, which can cause damage and fire, possibly resulting in serious injury.*



*Please note that it is not possible to confirm the operation of all functions of all USB devices that are available. In view of this it may be noted that some functions associated with a specific device might not operate properly.*

**Headphone jack**

A 3.5 mm mini headphone jack enables connection of stereo headphones.

**Microphone jack**

A 3.5 mm mini microphone jack enables connection of a three-conductor mini jack for monaural microphone input.



*Keep foreign metal objects, such as screws, staples and paper clips, out of the Memory media slot. Foreign metal objects can create a short circuit, which can cause damage and fire, possibly resulting in serious injury.*

**LAN jack**

This jack lets you connect to a LAN. The adaptor has built-in support for Ethernet LAN (10 megabits per second, 10BASE-T), Fast Ethernet LAN (100 megabits per second, 100BASE-TX). Some models are equipped with a Gigabit Ethernet LAN (1000 megabits per second, 1000BASE-T). Refer to Chapter 4, [Operating Basics](#), for details.



- *Do not connect any cable other than a LAN cable to the LAN jack. It could cause damage or malfunction.*
- *Do not connect the LAN cable to a power supply. It could cause damage or malfunction.*

**External monitor port**

This port provides 15-pin, analog VGA port. This port allows you to connect an external monitor to the computer.

**Cooling vents**

The cooling vents help the processor to avoid overheating.



*Do not block the cooling vents. Keep foreign metal objects, such as screws, staples and paper clips, out of the cooling vents. Foreign metal objects can create a short circuit, which can cause damage and fire, possibly resulting in serious injury.*



### Security lock slot

A security cable can be attached to this slot and then connected to a desk or other large object in order to deter theft of the computer.



### HDMI out port

HDMI out port can connect with Type A connector HDMI cable.

HDMI cable can send video and audio signals. In addition to this, it can send and receive control signals.

Some models are equipped with an HDMI out port.

## Right side

The following figures show the computer's right side.

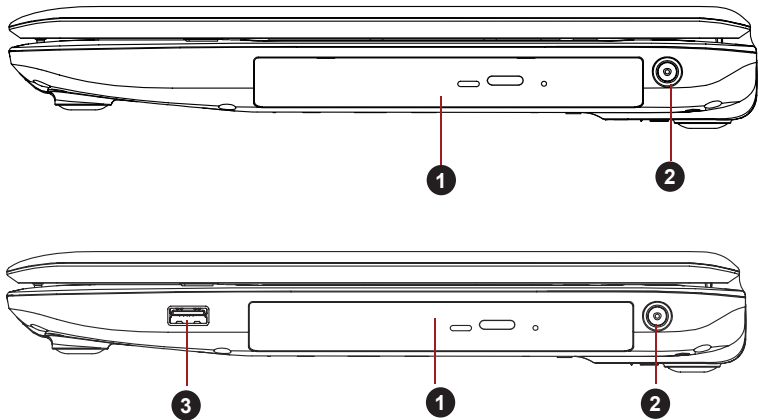

- 1. Optical disc drive
- 2. DC IN 19V jack

- 3. Universal Serial Bus (USB 2.0) port\*

\* Provided with some models.

Product appearance depends on the model you purchased.

*Figure 2-3 The right side of the computer*

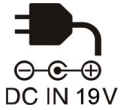
**DC IN 19V jack**

The AC adaptor connects to this jack in order to power the computer and charge its internal batteries. Please note that you should only use the model of AC adaptor supplied with the computer at the time of purchase - using the wrong AC adaptor can cause damage to the computer.

**Optical disc drive**

The computer is configured with a DVD Super Multi drive.

**Universal Serial Bus (USB 2.0) port**

One USB port, which complies to the USB 2.0 standard, might be provided on the right side of the computer.

## Back

The following figure shows the computer's back.

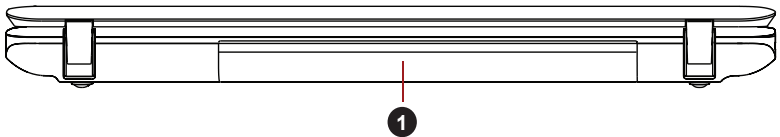
**1. Battery pack**

*Figure 2-4 The back of the computer*

**Battery pack**

The battery pack provides power to the computer when the AC adaptor is not connected. For more detailed information on the use and operation of the battery pack please refer to Chapter 6, [Power and Power-Up Modes](#).

## Underside

The following figure shows the underside of the computer. You should ensure that the display is closed before the computer is turned over to avoid causing any damage.

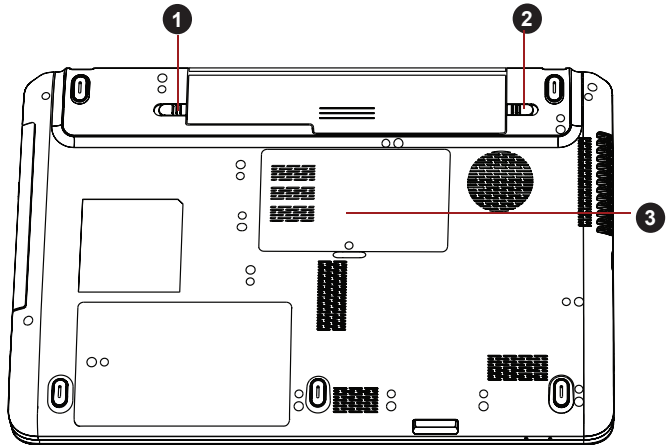

1. Battery lock  
 2. Battery release latch  
 3. Memory module slot

*Figure 2-5 The underside of the computer*

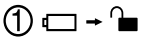

### Battery lock

Slide the battery lock to release the battery pack ready for removal.

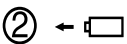

### Battery release latch

Slide and hold this latch into its Unlocked position in order to release the battery pack for removal. For more detailed information on removing the battery pack please refer to Chapter 6, *Power and Power-Up Modes*.



### Memory module slot

The memory module slot allows for the installation, replacement and removal of additional memory module.

Refer to the *Additional memory module* section in Chapter 3, Hardware, Utilities and Options.

## Front with the display open

This section shows the computer with the display panel open. In order to open the display, lift the display panel up and position it at a comfortable viewing angle for you.

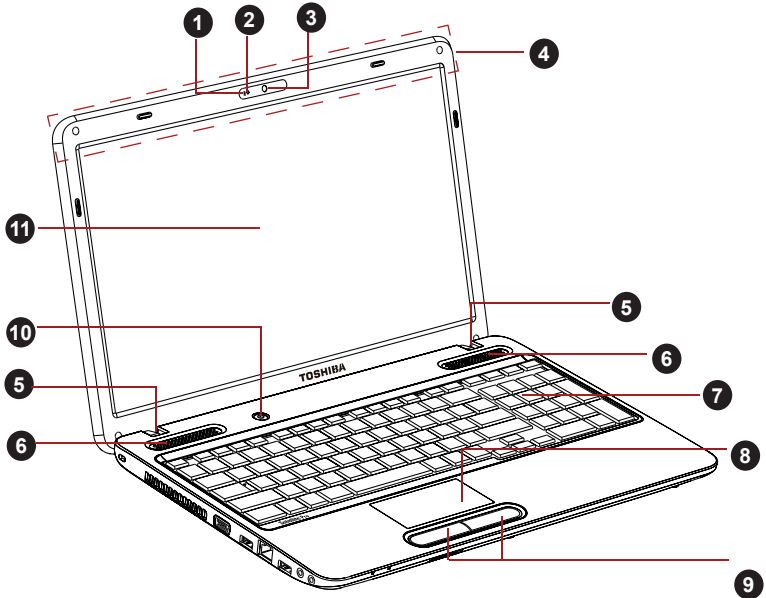

Figure 2-6 The front of the computer with the display panel open

- |   |                              |
|---|------------------------------|
| 1. Microphone*  | 7. Keyboard                  |
| 2. Web Camera LED*  | 8. Touch Pad                 |
| 3. Web Camera*  | 9. Touch Pad control buttons |
| 4. Wireless LAN, Wireless WAN and Bluetooth antennas (Not shown)* | 10. Power button             |
| 5. Display hinges   | 11. Display screen           |
| 6. Stereo speakers  |                              |

\* Provided with some models.

Product appearance depends on the model you purchased.

### Microphone



A built-in microphone allows you to import and record sounds for your application - please refer to the [Sound System](#) section in Chapter 4, Operating Basics for more information.

Some models are equipped with a built-in microphone.

### Web Camera LED

The Web Camera LED glows when the Web Camera is operating.

---

<b>Web Camera</b>	<p><b>Web Camera</b> is a device that allows you to record video or take photographs with your computer. You can use it for video chatting or video conferences using a communication tool such as <b>Windows Live Messenger</b>. <b>TOSHIBA Web Camera Application</b> will help you to add various video effects to your video or photograph. Enables the transmission of video and use of video chat via the internet using specialized applications.</p> <p>Some models are equipped with a Web Camera. Please refer to the <a href="#">Web Camera</a> section in Chapter 4, Operating Basics.</p>
<b>Wireless LAN antennas</b>	Some computers in this series are equipped with the Wireless LAN antennas.
<b>Wireless WAN antennas</b>	Some computers in this series are equipped with the Wireless WAN antennas.
<b>Bluetooth antenna</b>	Some computers in this series are equipped with a Bluetooth antenna.
<b>Display hinges</b>	The display hinges allow the display panel to be positioned at a variety of easy-to-view angles.
<b>Stereo speakers</b>	The speakers emit sound generated by your software as well as audio alarms, such as low battery condition, generated by the system.
<b>Keyboard</b>	The internal keyboard provides dedicated numeric keys, dedicated cursor control keys,  and  Keys. Refer to Chapter 5, <a href="#">The Keyboard</a> , for details.
<b>Touch Pad</b>	The Touch Pad located in the palm rest is used to control the movement of the on-screen pointer. For more information, please refer to the <a href="#">Using the Touch Pad</a> section in Chapter 4, Operating Basics.
<b>Touch Pad control buttons</b>	The control buttons located below the Touch Pad allow you to select menu items or manipulate text and graphics as designated by the on-screen pointer.

---



---

**Power button**

Press this button to turn the computer's power on and off.

---

**Display screen**

Please be aware that, when the computer is operating on the AC adaptor, the image displayed on the internal screen will be somewhat brighter than when it operates on battery power. This difference in brightness levels is intended to save power when operating on batteries. For more information on the computer's display, please refer to the [Display Controller and Video mode](#) section in Appendix B.

---

## Indicators

This section explains indicator functions.

### System indicators

LED system indicators next to their respective icons, glow when specific computer operations are in progress.



*Figure 2-7 System indicators*



---

**DC IN/Battery**

The **DC IN/Battery** indicator shows the status of the DC IN and the battery's charge. Green indicates the battery is fully charged while the power is being correctly supplied from the AC power adaptor. Please refer to Chapter 6, [Power and Power-Up Modes](#) for more information on this feature.



---

**Power**

The **Power** indicator normally glows green when the computer is turned on. However, if you turn the computer off into Sleep Mode, this indicator will blink green.

---



## Keyboard indicators

The following figures show the positions of the CAPS LOCK indicator and the NUM LOCK indicator which show the following conditions:

- When the CAPS LOCK indicator glows, the keyboard will produce capitals when any letter is typed.
- When the NUM LOCK indicator glows, the ten key allows you to enter numbers.

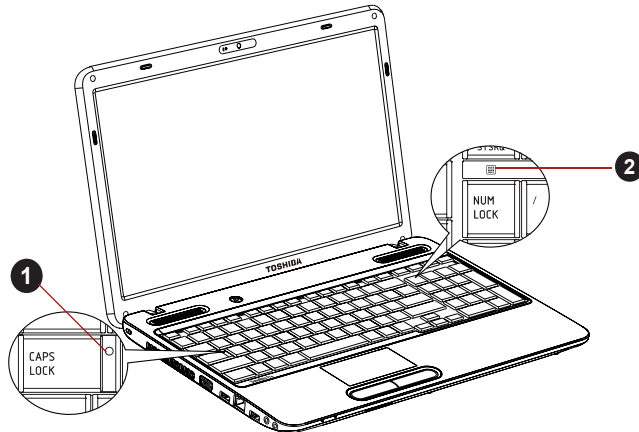

1. CAPS LOCK indicator

2. NUM LOCK indicator

Figure 2-8 Keyboard indicators

---

### CAPS LOCK

This indicator glows green when letter keys are locked into their uppercase format.

---

### NUM LOCK

When the **NUM LOCK** indicator glows, you can use the number keys on the keyboard for number entry.

---



## Optical disc drives

The computer is configured with a DVD Super Multi drive.

### Writable discs

This section describes the types of writable CD/DVD discs. Check the specifications of your drive to see the types of discs it can write. Use TOSHIBA Disc Creator to write compact discs. Refer to Chapter 4, *Operating Basics*.

## CDs

- CD-R discs can be written only once. The recorded data cannot be erased or changed.
- CD-RW discs including multi speed CD-RW discs, high-speed CD-RW discs and ultra-speed CD-RW discs can be recorded more than once.

## DVDs

- DVD-R, DVD+R, DVD-R (Dual Layer) and DVD+R (Double Layer) discs can be written only once. The recorded data cannot be erased or changed.
- DVD-RW, DVD+RW and DVD-RAM discs can be recorded more than once.

## AC adaptor

The AC adaptor can automatically adjust to any voltage ranging from 100 to 240 volts and to a frequency of either 50 or 60 hertz, enabling you to use this computer in almost all country/region. The adaptor converts AC power to DC power and reduces the voltage supplied to this computer.

To recharge the battery, simply connect the AC adaptor to a power source and to the computer. Please refer to Chapter 6, [Power and Power-Up Modes](#) for further information.

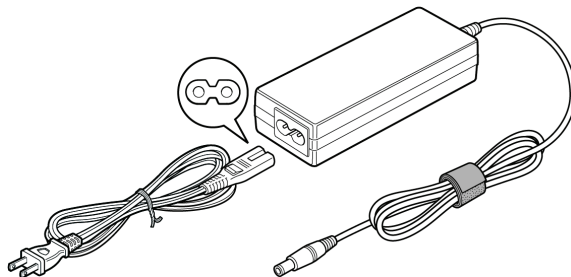

Figure 2-9 The AC adaptor (2-pin plug)

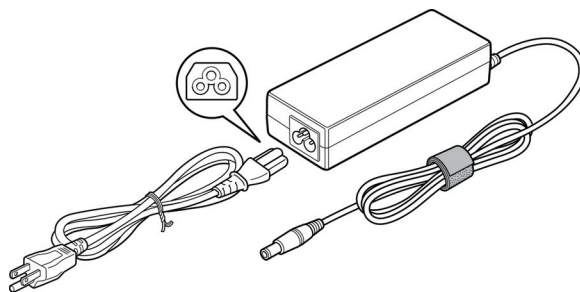

Figure 2-10 The AC adaptor (3-pin plug)



- *Depending on the model in question, either a 2-pin or 3-pin adaptor/power lead will be bundled with the computer.*
- *Do not use a 3-pin to 2-pin conversion plug.*
- *The supplied power cord conforms to safety rules and regulations in the region the product is bought and should not be used outside of this region. In order to use the adaptor/computer in other regions, you should please buy a power cord that conforms to the safety rules and regulations in that particular region.*



*Always use the TOSHIBA AC adaptor that was included with your computer, or use AC adaptors specified by TOSHIBA to avoid any risk of fire or other damage to the computer. Use of an incompatible AC adaptor could cause fire or damage to the computer possibly resulting in serious injury. TOSHIBA assumes no liability for any damage caused by use of an incompatible adaptor.*

## Chapter 4

### Operating Basics

This chapter describes the basic operations of your computer, highlights the precautions that should be taken when using it.

#### Using the Touch Pad

To use the Touch Pad, simply touch and move your fingertip across it in the direction you want the on-screen pointer to go.

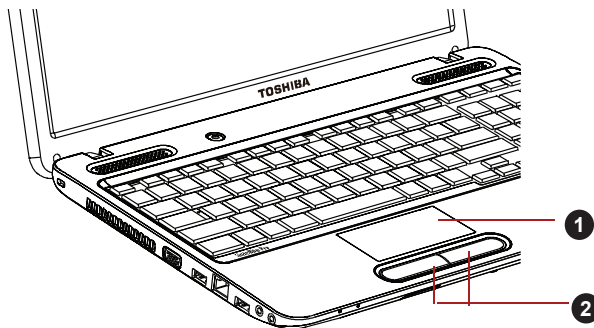

1. Touch Pad

2. Touch Pad control buttons

*Figure 4-1 Touch Pad and Touch Pad control buttons*

The two buttons below the Touch Pad are used like the buttons on a standard mouse - press the left button to select a menu item or to manipulate text or graphics designated by the pointer, and press the right button to display a menu or other function depending on the software you are using.



You can also tap the Touch Pad to perform functions similar to those of the left button on a standard mouse.

**Click:** Tap once

**Double-click:** Tap twice

**Drag and drop:** Tap to select the item(s) you want to move, leave your finger on the Touch Pad after the second tap and then move the item(s) to their new destination.

## Web Camera

Some models are equipped with a Web Camera.

**Web Camera** is a device that allows you to record video or take photographs with your computer. You can use it for video chatting or video conferences using a communication tool such as **Windows Live Messenger**. **TOSHIBA Web Camera Application** will help you to add various video effects to your video or photograph.

Enables the transmission of video and use of video chat via the internet using specialized applications.

Please refer to the Web Camera Application Online Help for details.

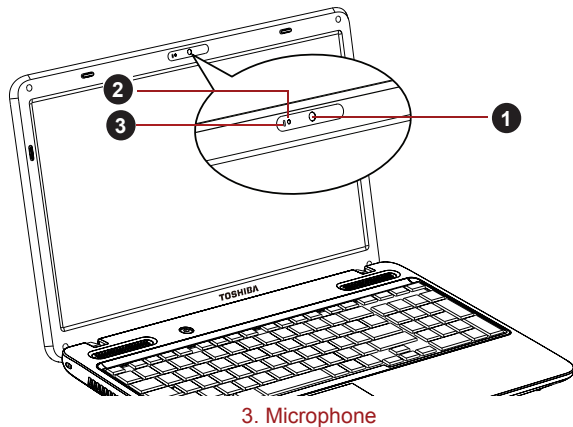

1. Web Camera

2. Web Camera LED

3. Microphone

Figure 4-2 Web Camera



- Do not point the web camera directly at the sun.
- Do not touch or press strongly on the web camera lens. Doing so may reduce image quality. Use an eyeglass cleaner (cleaner cloth) or other soft cloth to clean the lens if it becomes dirty.
- When recording in dimly lit environments, select "Night Mode" which allows for brighter images with less noise.

## Using the TOSHIBA Face Recognition

TOSHIBA Face Recognition uses a face verification library to verify the face data of users when they log in to Windows. The user can thus avoid having to enter a password or the like, which makes the login process easier.



- *TOSHIBA Face Recognition does not guarantee the correct identification of a user. Changes to the likeness of a registrant, such as hair style changes, wearing a cap, or wearing glasses may effect the recognition rates when such changes occur after the registrant had registered.*
- *TOSHIBA Face Recognition may incorrectly recognize faces that are similar to a registrant.*
- *For high security purposes, TOSHIBA Face Recognition is not a suitable substitute for Windows passwords. When security is a high priority, use your established Windows passwords to log in.*
- *Bright background light and/or shadows may prevent a registrant from being recognized correctly. In that case, log in using your Windows password. If recognition of a registrant fails repeatedly, refer to your computer documentation to learn ways to improve recognition performance.*
- *TOSHIBA Face Recognition records face data in a log when face recognition fails. When transferring ownership or disposing of your computer, please uninstall the application or delete all the logs created by the application. For details on how to do this, see help file.*
- *TOSHIBA Face Recognition can be used only in Windows 7.*

### Disclaimer

TOSHIBA does not guarantee that the face recognition utility technology will be completely secure or error-free. TOSHIBA does not guarantee that the face recognition utility will accurately screen out unauthorized users at all times. TOSHIBA is not liable for any failure or damage that might arise out of the use of the face recognition software or utility.

TOSHIBA, ITS AFFILIATES AND SUPPLIERS SHALL HAVE NO RESPONSIBILITY FOR DAMAGE TO OR LOSS OF ANY BUSINESS, PROFITS, PROGRAMS, DATA, NETWORK SYSTEMS OR REMOVABLE STORAGE MEDIA ARISING OUT OF OR RESULTING FROM THE USE OF THE PRODUCT, EVEN IF ADVISED OF THE POSSIBILITY THEREOF.

### How to register the Face Recognition Data

Take a picture for facial verification purposes, and register the data needed when you log in. To register the data needed when you log in, follow the steps as described below:

1. To launch this utility, click **Start -> All Programs -> TOSHIBA -> Utilities -> Face Recognition**.

- The **Registration** screen is displayed for a logged-in user whose face has not been registered.
- The **Management** screen is displayed for a logged-in user whose face has already been registered.
2. Click **Run as administrator** in lower left of the **Management** screen, and then click the **Register** button. The **Registration** screen is displayed.
  - If you wish to practice, click on the **Next** button in the **Registration** screen.
  - If you do not wish to practice, click on the **Skip** button in the **Registration** screen.
3. Click the **Next** button to start the guide. Please follow the guide to practice.
  - Click the **Back** button to practice the guide once more.
4. Click the **Next** button to start image-capturing process. Adjust the position of your face so that it fits within the face-shaped frame.
5. Once your face has been positioned properly, the recording will commence.

Start moving your neck very slightly to the left and right, and then move your neck up and down.
6. Registration will end after you have repeatedly moved your neck left, right, up and down.

When the register succeeds, below message will be displayed on the screen:  
"Registration successful. Now we'll do the verification test. Click the Next button."  
Click the **Next** button to perform the verification test.
7. Perform the verification test. Face the screen as you do when you register.
  - If verification fails, click the **Back** button and re-register. Please refer to step 6 from step 4.
8. If verification is successful, click the **Next** button and register an account.
9. Register the account.

Fill in all the fields.
10. The **Management** screen is displayed.

The registered account name will be displayed. Clicking on it will cause the captured image of your face to be displayed on the left.

## How to Delete the Face Recognition Data

Delete image data, account information, and personal record data created during registration. To delete the Face Recognition Data, follow the steps as described below:

1. To launch this utility, click **Start -> All Programs -> TOSHIBA -> Utilities -> Face Recognition**.  
The **Management** screen is displayed.
2. Select a user which is displayed in the **Management** screen.
3. Click the **Delete** button. "You are about to delete the user data. Would you like to continue?" will be displayed on the screen.
  - If you do not want the data to be deleted, click the **No** button and you will then be returned to the **Management** screen.
  - Clicking on the **Yes** button will remove the selected user from the **Management** screen.

## How to launch the help file

For further information on this utility, please refer to help file.

1. To launch the help file, click the **Help** button in the **Management** screen.

## Windows Logon via TOSHIBA Face Recognition

This section explains how to login to Windows with TOSHIBA Face Recognition. Two authentication modes are provided.

- **1:N Mode Login screen:** If the face authentication tile is selected by default, you can log in without using the keyboard or mouse.
- **1:1 Mode Login screen:** This mode is essentially the same as AUTO mode, but the **Select Account** screen will appear before the **Display Captured Image** screen, and you will need to select the user account to be authenticated in order to start the authentication process.

### *1:N Mode Login screen*

1. Turn on the computer.
2. The **Select Tiles** screen will be displayed.
3. Select **Start face recognition** (  ).
4. "Please face the camera" will be displayed.
5. Verification will be performed. If the authentication is successful, the image data taken in step 4 will be faded in and placed over one another.
  - If an error occurs during authentication, you will be returned to the **Select Tiles** screen.
6. The Windows **Welcome** screen will be displayed, and will be logged in automatically to Windows.



## 1:1 Mode Login screen

1. Turn on the computer.
2. The **Select Tiles** screen will be displayed.
3. Select **Start face recognition** ()
4. The **Select Account** screen will be displayed.
5. Select the account, and click the **arrow** button.
6. "Please face the camera" will be displayed.
7. Verification will be performed. If the authentication is successful, the image data taken in step 6 will be faded in and placed over one another.
  - If an error occurs during authentication, you will be returned to the **Select Tiles** screen.
8. The Windows **Welcome** screen will be displayed, and will be logged in automatically to Windows.
  - If authentication was successful, but an authentication error subsequently occurred during the login to Windows, you will be asked to provide your account information.

## Using optical disc drives

The full-size drive provides high-performance execution of CD/DVD-based programs. You can run either 12 cm (4.72") or 8 cm (3.15") CD/DVDs without an adaptor. When the computer is accessing a CD/DVD, an indicator on the drive glows.



*Use the DVD playback application to view DVD-Video discs.*

For precautions on writing to CD/DVDs, refer to the [Important message](#) section.

## Loading discs

To load a disc, follow the steps as detailed below:

1. When the computer's power is on, press the eject button to open the disc tray slightly.

2. Grasp the disc tray gently and pull until it is fully opened.

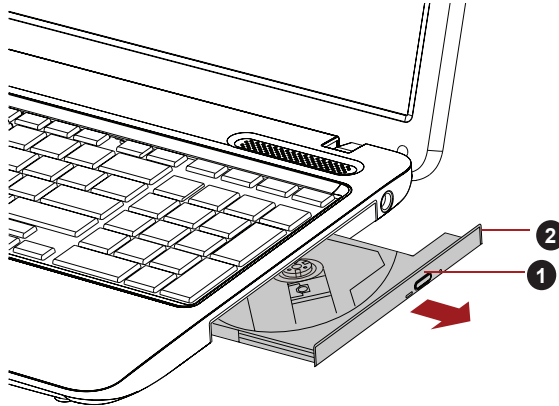

1. Eject button

2. Disc tray

*Figure 4-3 Pressing the eject button and pulling the disc tray open*

3. Lay the disc, label side up, in the disc tray.

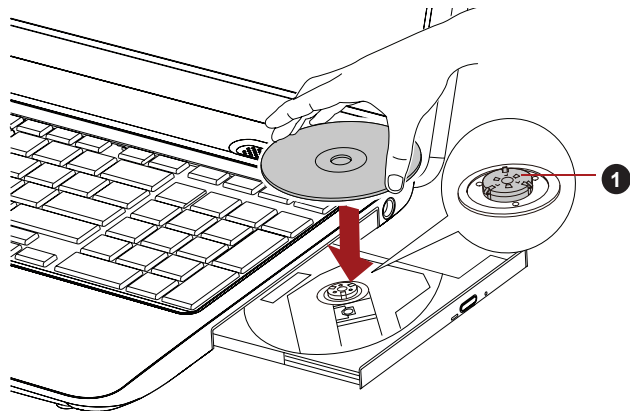

1. Laser lens

*Figure 4-4 Inserting a disc*



When the disc tray is fully opened, the edge of the computer will cover the disc tray slightly. Therefore, you will need to turn the disc at an angle when you place it in the disc tray. After seating the disc, however, make sure it lies flat.



- *Do not touch the laser lens or any portion of its surrounding casing as this could cause misalignment.*
- *Prevent foreign objects from entering the drive. Check the surface of the disc tray, especially the area behind the front edge of the disc tray, to make sure there are no such objects before closing the drive.*

4. Press gently at the center of the disc until you feel it click into place. The disc should lie below the top of the spindle, flush with the spindle base.
5. Push the center of the disc tray to close it. Press gently until it locks into place.



*If the disc is not seated properly when the disc tray is closed, the disc might be damaged. Also, the disc tray might not open fully when you press the eject button.*

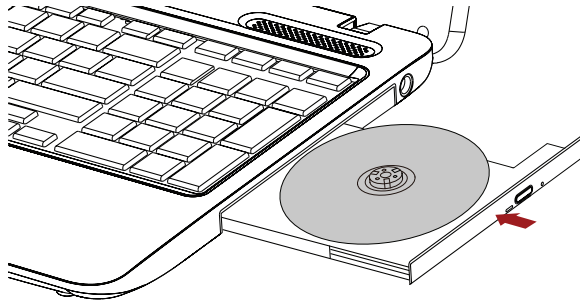

*Figure 4-5 Closing the disc tray*

## Removing discs

To remove the disc, follow the steps as detailed below:



*Do not press the eject button while the computer is accessing the media drive. Wait for the optical disc drive indicator to go out before you open the disc tray. Also, if the disc is spinning when you open the disc tray, wait for it to stop before you remove it.*

1. To pop the disc tray partially open, press the eject button. Gently pull the disc tray out until it is fully opened.



*When the disc tray pops open slightly, wait a moment to make sure the disc has stopped spinning before pulling the disc tray fully open.*

2. The disc extends slightly over the sides of the disc tray so you can grasp it. Gently lift out the disc.

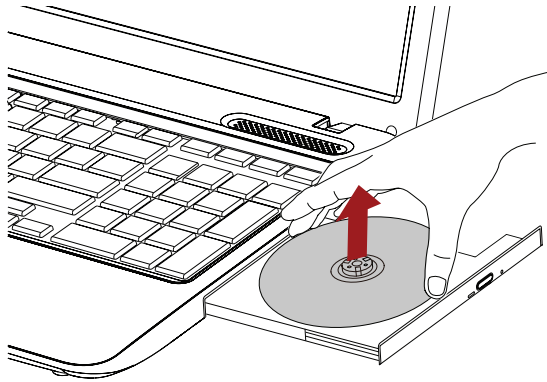
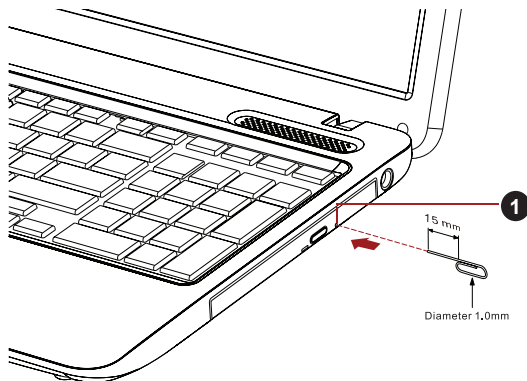

Figure 4-6 Removing a disc

3. Push the center of the disc tray to close it. Press gently until it locks into place.

### How to remove discs when the disc tray will not open

Pressing the eject button will not open the disc tray when the computer power is off. If the power is off, you can open the disc tray by inserting a slender object (about 15 mm) such as a straightened paper clip into the eject hole near the eject button.



1. Eject hole

Figure 4-7 Manual release with the eject hole



Turn off the power before you use the eject hole. If the disc is spinning when you open the disc tray, the disc could fly off the spindle and cause injury.

## Writing CD/DVDs

You can use the DVD Super Multi drive to write data to either CD-R, CD-RW, DVD-R, DVD-R (Dual Layer), DVD-RW, DVD+R, DVD+R (Double Layer), DVD+RW or DVD-RAM discs.

TOSHIBA Disc Creator is provided as writing software with this computer.



- Please refer to the [Writable discs](#), Chapter 2 for details about the types of writable CD/DVD discs that can be supported by this computer.
- CD-R/RW media cannot be accessed using the **burn cd/dvd** option in Media Center.
- To write data to CD-R/RW media, use the **TOSHIBA Disc Creator** feature that is installed on your computer.



*When writing information to media using an optical drive, you should always ensure that you connect the AC adaptor to a live power socket. It is possible that, if data is written while powered by the battery pack, the write process may sometimes fail due to low battery power - in these instances data loss may occur.*

### Important message

Before you write or rewrite to any of the media supported by the DVD Super Multi drive, please read and follow all of the setup and operating instructions in this section. If you fail to do so, you may find that the DVD Super Multi drive may not function properly, and you may fail to write or rewrite information successfully - this may cause you to either lose data or incur other damage to the drive or media.

### Disclaimer

TOSHIBA does not bear responsibility for the following:

- Damage to any CD-R, CD-RW, DVD-R, DVD-R (Dual Layer), DVD-RW, DVD+R, DVD+R (Double Layer), DVD+RW or DVD-RAM disc that may be caused by writing or rewriting with this product.
- Any change or loss of the recorded contents of CD-R, CD-RW, DVD-R, DVD-R (Dual Layer), DVD-RW, DVD+R, DVD+R (Double Layer), DVD+RW or DVD-RAM media that may be caused by writing or rewriting with this product, or for any business profit loss or business interruption that may be caused by the change or loss of the recorded contents.
- Damage that may be caused by using third party equipment or software.

Given the technological limitations of current optical disc writing drives, you may experience unexpected writing or rewriting errors due to disc quality or problems with hardware devices. In view of this, it is good practice to make two or more copies of important data, in case of any undesired change or loss of the recorded contents.

---

## Before writing or rewriting with the DVD Super Multi drive

- Based on TOSHIBA's limited compatibility testing, we suggest the following manufacturers of CD-R, CD-RW, DVD-R, DVD-R (Dual Layer), DVD-RW, DVD+R, DVD+R (Double Layer), DVD+RW or DVD-RAM, media, however, it must be noted that disc quality can affect write or rewrite success rates. Please also be aware that in no event does TOSHIBA guarantee the operation, quality or performance of any disc.
- 

### **CD-R:**

TAIYO YUDEN CO., Ltd.  
MITSUBISHI KAGAKU MEDIA CO., LTD.  
Hitachi Maxell, Ltd.

---

### **CD-RW: (Multi-Speed and High-Speed)**

MITSUBISHI KAGAKU MEDIA CO., LTD.

---

### **CD-RW: (Ultra-Speed)**

MITSUBISHI KAGAKU MEDIA CO., LTD.

---

### **DVD-R:**

#### **DVD Specifications for Recordable Disc for General Version 2.0**

TAIYO YUDEN Co.,Ltd. (for 8x and 16x speed media)

MITSUBISHI KAGAKU MEDIA CO.,LTD. (for 8x and 16x speed media)

Hitachi Maxell, Ltd. (for 8x and 16x speed media)

---

### **DVD-R (Dual Layer):**

MITSUBISHI KAGAKU MEDIA CO., LTD. (for 4x and 8x speed media)

---

### **DVD-R for Labelflash:**

FUJIFILM CORPORATION (for 16x speed media)

---

### **DVD+R:**

MITSUBISHI KAGAKU MEDIA CO., LTD. (for 8x and 16x speed media)

TAIYO YUDEN Co., Ltd. (for 8x and 16x speed media)

---

### **DVD+R (Double Layer):**

MITSUBISHI KAGAKU MEDIA CO., LTD. (for 2.4x and 8x speed media)

---

### **DVD+R for Labelflash:**

FUJIFILM CORPORATION (for 16x speed media)

---

**DVD-RW:****DVD Specifications for Recordable Disc for Version 1.1 or version 1.2**

Victor Company of Japan, Ltd. (JVC) (for 4x and 6x speed media)

MITSUBISHI KAGAKU MEDIA CO.,LTD. (for 4x and 6x speed media)

**DVD+RW:**

MITSUBISHI KAGAKU MEDIA CO., LTD. (for 4x and 8x speed media)

**DVD-RAM:****DVD Specifications for DVD-RAM Disc for Version 2.0, Version 2.1 or Version 2.2**

Panasonic Corporation (for 3x and 5x speed media)

Hitachi Maxell, Ltd. (for 3x and 5x speed media)



- *Some types and formats of DVD-R (Dual Layer) and DVD+R (Double Layer) discs may be unreadable.*
- *2.6GB and 5.2GB DVD-RAM media cannot be read from or written to.*
- *Disc created in DVD-R (Dual Layer) format4 (Layer Jump Recording) cannot be read.*
- If the disc is poor in quality, or is dirty or damaged, writing or rewriting errors may be noted - ensure that you check all discs for dirt or damage before you use them.
- The actual number of rewrites to CD-RW, DVD-RW, DVD+RW or DVD-RAM media will be affected by the quality of the disc itself and the way in which it is used.
- There are two types of DVD-R media available, authoring discs and general use discs. Do not attempt to use authoring discs as only general use discs can be written to by a computer drive.
- You can use both DVD-RAM discs that can be removed from a cartridge and DVD-RAM discs designed without a cartridge.
- You may find that other computer DVD-ROM drives or other DVD players may not be able to read DVD-R, DVD-R (Dual Layer), DVD-RW, DVD+R, DVD+R (Double Layer) or DVD+RW discs.
- Data written to a CD-R, DVD-R, DVD-R (Dual Layer), DVD+R or DVD+R (Double Layer) discs cannot be deleted either in whole or in part.
- Data deleted/erased from a CD-RW, DVD-RW, DVD+RW or DVD-RAM disc cannot be recovered. You must check the content of the disc carefully before you delete it, taking care that, if multiple drives that can write data to discs are connected, you do not delete data from the wrong one.
- In writing to DVD-R, DVD-R (Dual Layer), DVD-RW, DVD+R, DVD+R (Double Layer), DVD+RW or DVD-RAM media, some space is required for file management, so you may not be able to write to the full capacity of the disc.

- Since the disc is based on the DVD standard, it might be filled with dummy data if the written data is less than about 1GB. Therefore, in these circumstances, even if you write only a small amount of data, it might take additional time to fill in the dummy data.
- When multiple drives that can write data to discs are connected, be sure that you do not write to or delete data from the wrong drive.
- Be sure to connect the AC adaptor to the computer before you write or rewrite any information.
- Before you enter either Sleep Mode or Hibernation Mode, take care to ensure that any DVD-RAM writing has been completed. In this instance, writing is finished if you can eject the DVD-RAM media.
- Be sure to close all other software programs except for the writing software itself.
- Do not run software such as a screen saver which can put a heavy load on the processor.
- Operate the computer at its full power settings - do not use any power-saving features.
- Do not write information while virus checking software is running, instead wait for it to finish, then disable the virus protection applications, including any software that checks files automatically in the background.
- Do not use any hard disk utilities, including those that are intended to enhance hard disk drive access speeds, as they may cause unstable operation and damage data.
- CD-RW (Ultra Speed +) media should not be used as data may be lost or damaged.
- You should always write from the computer's hard disk drive onto the CD/DVD - do not try to write from shared devices such as a server or any other network device.
- Writing with software other than TOSHIBA Disc Creator has not been confirmed, therefore operation with other software applications cannot be guaranteed.

## When writing or rewriting

Please observe the following points while you write or rewrite data to CD-R, CD-RW, DVD-R, DVD-R (Dual Layer), DVD-RW, DVD+R, DVD+R (Double Layer), DVD+RW or DVD-RAM media:

- Always copy data from the hard disk drive to the optical media - do not use the cut-and-paste function as the original data will be lost if there is a write error.
- Do not perform any of the following actions:
  - Change users in the Operating System.
  - Operate the computer for any other function, including such tasks as using a mouse or Touch Pad, or closing/opening the display panel.
  - Start a communication application.
  - Apply impact or vibration to the computer.



- Install, remove or connect external devices, including such items as a SD/SDXC memory card, miniSD/microSD Card, MultiMediaCard, USB device, external monitor, or an optical digital device.
- Use the audio/video control button to reproduce music or voice.
- Open the optical disc drive.
- Do not use shut down, log off, Sleep Mode or Hibernation Mode functions while writing or rewriting.
- Make sure that the write/rewrite operation is completed before going into either Sleep Mode or Hibernation Mode (writing is completed if you can remove an optical media on the DVD Super Multi drive).
- If the media is of poor quality, or is dirty or damaged, writing or rewriting errors may occur.
- Set the computer on a level surface and avoid places subject to vibration such as airplanes, trains or cars. In addition, do not use the computer on an unstable surface such as a stand.
- Keep mobile phones and other wireless communication devices away from the computer.

## TOSHIBA Disc Creator

Please be aware of the following limitations when you use the TOSHIBA Disc Creator:

- DVD-Video cannot be created using TOSHIBA Disc Creator.
- DVD Audio cannot be created using TOSHIBA Disc Creator.
- You cannot use TOSHIBA Disc Creator's "Audio CD" function to record music to DVD-R, DVD-R (Dual Layer), DVD-RW, DVD+R, DVD+R (Double Layer) or DVD+RW media.
- Do not use the "Disc Backup" function of TOSHIBA Disc Creator in order to copy DVD-Video or DVD-ROM material that has copyright protection.
- DVD-RAM discs cannot be backed up using the "Disc Backup" function of TOSHIBA Disc Creator.
- You cannot back up CD-ROM, CD-R or CD-RW media to DVD-R, DVD-R (Dual Layer) or DVD-RW media using the "Disc Backup" function of TOSHIBA Disc Creator.
- You cannot back up CD-ROM, CD-R or CD-RW media to DVD+R, DVD+R (Double Layer) or DVD+RW media using the "Disc Backup" function of TOSHIBA Disc Creator.
- You cannot back up DVD-ROM, DVD-Video, DVD-R, DVD-R (Dual Layer), DVD-RW, DVD+R, DVD+R (Double Layer) or DVD+RW to CD-R or CD-RW media using the "Disc Backup" function of TOSHIBA Disc Creator.
- TOSHIBA Disc Creator cannot record in packet format.
- You might not be able to use the "Disc Backup" function of TOSHIBA Disc Creator to back up a DVD-R, DVD-R (Dual Layer), DVD-RW, DVD+R, DVD+R (Double Layer) or DVD+RW disc that was made with other software on a different optical media recorder.

- If you add data to a DVD-R, DVD-R (Dual Layer), DVD+R or DVD+R (Double Layer) disc that you have already recorded to, you might not be able to read the added data under some circumstances. For example, it cannot be read under 16-bit operating systems, such as Windows 98SE and Windows Me, while in Windows NT4 you will need Service Pack 6 or later, and in Windows 2000, you will need Service Pack 2. In addition to this, some DVD-ROM and DVD-ROM / CD-R/RW drives cannot read this added data regardless of the operating system.
- TOSHIBA Disc Creator does not support recording to DVD-RAM discs - to achieve this you should use Windows Explorer or another similar utility.
- When you back up a DVD disc, be sure that the source drive supports recording to DVD-R, DVD-R (Dual Layer), DVD-RW, DVD+R, DVD+R (Double Layer) or DVD+RW media - if this is not the case then the source disc might not be backed up correctly.
- When you back up a DVD-R, DVD-R (Dual Layer), DVD-RW, DVD+R, DVD+R (Double Layer) or DVD+RW disc, be sure to use the same type of disc.
- You cannot partially delete any data written to a CD-RW, DVD-RW or DVD+RW disc.

### **Data Verification**

To verify that data has been written or rewritten correctly to a data CD/DVD you should follow the steps below before you begin the write/rewrite process:

1. Display the setting dialog box by one of the following two steps:
  - Click the **Recording settings** button () for writing on the main toolbar in the **Data CD/DVD** mode.
  - Select **Settings for Each Mode** -> **Data CD/DVD** in the **Settings** menu.
2. Mark the **Verify Written Data** check box.
3. Select **File Open** or **Full Compare** mode.
4. Click the **OK** button.

### **How to learn more about TOSHIBA Disc Creator**

Please refer to the Help files for additional TOSHIBA Disc Creator information.

## TOSHIBA VIDEO PLAYER

Please be aware of the following limitations when you use the TOSHIBA VIDEO PLAYER:

### Notes on use

- "TOSHIBA VIDEO PLAYER" software is supported for playback of DVD-Video and DVD-VR.
- Frame dropping, audio skipping or out of synch audio and video may occur during playback of some DVD-Video titles.
- Close all other applications when using the "TOSHIBA VIDEO PLAYER". Do not open any other applications or carry out any other operations during DVD-Video playback. Playback may stop or not function properly in some situations.
- Unfinalized DVDs created on home DVD recorders may not be playable on the computer.
- Use DVD-Video discs with a region code which is either "the same as the factory default setting" or "ALL".
- Do not playback DVD discs Video while watching or recording television programs using other applications. Doing so may cause DVD-Video playback or television program recording errors. In addition, if pre-scheduled recording starts during DVD-Video playback it may cause DVD-Video playback or television program recording errors. Please view DVD-Video during times when there is no recording pre-scheduled.
- The resume function cannot be used with some discs on the "TOSHIBA VIDEO PLAYER".
- It is recommended the AC adaptor be connected when playing DVD-Video. Power saving features may interfere with smooth playback. When playing DVD-Video using battery power, set the Power Options to "Balance".
- Screen savers will not display while playing a movie in the "TOSHIBA VIDEO PLAYER". The computer will also not go into Sleep Mode, Hibernation Mode or shutdown while using "TOSHIBA VIDEO PLAYER".
- Do not configure the Display automatic power off function to run while the "TOSHIBA VIDEO PLAYER" is running.
- Do not switch to Hibernation or Sleep Mode when running the "TOSHIBA VIDEO PLAYER".
- Do not lock the computer using the **Windows logo** () + **L** keys or the **FN + F1** keys when running the "TOSHIBA VIDEO PLAYER".
- Do not change Windows Users while "TOSHIBA VIDEO PLAYER" is running.
- The "TOSHIBA VIDEO PLAYER" does not have a parental control function.

- In order to protect copyrights, the Windows Print Screen function is disabled when "TOSHIBA VIDEO PLAYER" is running.
- (Print Screen functions are disabled even when running other applications besides "TOSHIBA VIDEO PLAYER" and when "TOSHIBA VIDEO PLAYER" is minimized.) Please close the "TOSHIBA VIDEO PLAYER" to use the Print Screen function.
- For some DVD-Video discs, using the control window to change the audio track will also change the subtitle track.
- Carry out the installation/uninstallation of the "TOSHIBA VIDEO PLAYER" under a user account with administrator rights.
- If you see the screen blinking while playing DVD with subtitle on at Media Player, please use "TOSHIBA VIDEO PLAYER" or "Media Center" to play DVD.

## Display Devices & Audio

- "TOSHIBA VIDEO PLAYER" will only run when "Colors" is set to "True color (32 bit)". Click **Start -> Control Panel -> Appearance and Personalization -> Display -> Adjust resolution**, click "Advanced settings", select "Monitor" tab, set "colors" to "True color (32 bit)".
- If the DVD-Video image is not displayed on an external display or television, stop the "TOSHIBA VIDEO PLAYER", and change the screen resolution. To change the screen resolution, click **Start -> Control Panel -> Appearance and Personalization -> Display -> Adjust resolution**. However, video cannot be output to some external displays and televisions due to output or playback conditions.
- When viewing DVD-Video on an external display or TV, change the display device before playing. DVD-Video cannot be displayed simultaneously (in clone mode) on both the computer's display panel and an external display.
- Do not change the display device while running the "TOSHIBA VIDEO PLAYER".
- Do not change the screen resolution while running the "TOSHIBA VIDEO PLAYER".

## Starting TOSHIBA VIDEO PLAYER

Use the following procedure to start "TOSHIBA VIDEO PLAYER".

1. Insert a DVD-Video in the drive while Windows 7 is running. When a DVD-Video disc is set in the DVD drive, the application selection screen may appear. If this occurs, select **Play DVD movie (using TOSHIBA VIDEO PLAYER)** to launch the **TOSHIBA VIDEO PLAYER**.
2. Select **Start -> All Programs -> TOSHIBA VIDEO PLAYER -> TOSHIBA VIDEO PLAYER** to start "TOSHIBA VIDEO PLAYER".

## Operating TOSHIBA VIDEO PLAYER

Notes on Using "TOSHIBA VIDEO PLAYER".

- Screen display and available features may vary amongst DVD-Videos and scenes.
- If the menu is opened in the Display Area using the Control window's Top Menu or Menu buttons, touch pad and mouse menu operations may not be able to be used.

## Open TOSHIBA VIDEO PLAYER HELP

TOSHIBA VIDEO PLAYER features and instructions are also explained in detail in *TOSHIBA VIDEO PLAYER Help*.

Use the following procedure to open *TOSHIBA VIDEO PLAYER Help*.

- Click the "Help" button (  ) in the Display Area.

## Media care

This section provides tips on protecting data stored on your CD/DVD. Handle your media with care. Following the simple precautions listed below will increase the lifetime of your media and protect the data stored on it.

1. Store your CD/DVDs in the containers they originally came in to protect them and keep them clean.
2. Do not bend the CD/DVDs.
3. Do not write on, apply a sticker to, or otherwise mar the surface of the CD/DVD that contains the data.
4. Hold the CD/DVD by its outside edge or the edge on the center hole - any fingerprints on the surface of the disc can prevent the drive from properly reading data.
5. Do not expose the CD/DVD to direct sunlight, extreme heat or cold.
6. Do not place heavy objects on your CD/DVDs.
7. If your CD/DVDs become dusty or dirty, wipe them with a clean dry cloth from the center hole outwards - do not wipe in a circular direction. If necessary, you can use a cloth that has been lightly dampened in water or a neutral cleaner but you must not use benzine, thinner or any similar cleaning solution.

## Sound System

This section describes some of the audio control functions.

### Adjusting System Volume

You can control the overall level of sound using Windows Volume Mixer.

To launch Volume Mixer, follow the steps below.

1. Right-click the **Speakers** icon on the Taskbar.
2. Select **Open Volume Mixer** from the menu.

Adjust speaker volume by moving the slider up or down under **Device** to raise or lower the volume of your speakers. Click the **Mute** button to mute the volume.

You may see another control under **Applications** in **Volume Mixer**. It is the control for an application which is currently running. The **System Sounds** is always displayed since it controls the volume of system sounds.

## Changing System Sounds

System sounds are assigned to inform you when certain events happen. This section explains how to select an existing scheme or save one you have modified.

To launch the configuration dialog window for system sounds, follow the steps below.

1. Right-click the **Speakers** icon on the taskbar.
2. Select **Sounds** from the menu.

## SmartAudio

Your computer contains SmartAudio, a powerful program that allows you to configure your audio software to enhance and personalize your listening experience.

The SmartAudio application has the following features:

- Volume Mixer
- Voice Effects
- Audio Director
- Smart EQ/3D Settings

Please refer to the SmartAudio Help file for details.

### *Starting SmartAudio Application*

To launch the **SmartAudio**, click **Start** -> **Control Panel** -> **Hardware and Sound** -> **SmartAudio**.

### *Opening SmartAudio Help*

Clicking "?" in the top right corner of the SmartAudio window will open the **Help** file in your selected language, or in English if your selected language is not supported.

## Adjusting Microphone Level

Follow the steps below to change the microphone recording level.

1. Right-click on the speaker icon on the Taskbar, and select **Recording devices** from the sub menu.
2. Select **Microphone**, and click **Properties**.

3. On the **Levels** tab move the **Microphone** slider to increase or decrease the microphone volume level.

If you feel the microphone volume level is inadequate, move the **Microphone Boost** slider to a higher level.

## Notes on Using the Microphone

You can use the built-in or an external microphone that connects to the microphone jack to record monaural sounds into your applications. It can also be used to issue voice commands to applications that support such functions (built-in microphone is provided with some models).

Since your computer has a microphone and speaker, "feedback" may be heard under certain conditions. Feedback occurs when sound from the speaker is picked up in the microphone and amplified back to the speaker, which amplifies it again to the microphone.

This feedback occurs repeatedly and causes a very loud, high-pitched noise. It is a common phenomenon that occurs in any sound system when the microphone input is output to the speaker (throughput) and the speaker volume is too loud or too close to the microphone. You can control throughput by adjusting the volume of your speaker or through the Mute function in the Master Volume panel. Refer to your Windows documentation for details on using the Master Volume panel.

## Wireless communications

The computer's wireless communication function supports some wireless communication devices.

Only some models are equipped with both Wireless LAN and Bluetooth functions.



- *Do not use the Wireless LAN (Wi-Fi) or Bluetooth functionalities near a microwave oven or in areas subject to radio interference or magnetic fields. Interference from a microwave oven or other source can disrupt Wi-Fi or Bluetooth operation.*
- *Turn all wireless functionalities off when near a person who may have a cardiac pacemaker implant or other medical electric device. Radio waves may affect pacemaker or medical device operation, possibly resulting in serious injury. Follow the instruction of your medical device when using any wireless functionality.*
- *Always turn off wireless functionality if the computer is near automatic control equipment or appliances such as automatic doors or fire detectors. Radio waves can cause malfunction of such equipment, possibly resulting in serious injury.*
- *It may not be possible to make a network connection to a specified network name using the ad hoc network function. If this occurs, the new network(\*) will have to be configured for all computers connected to the same network in order to re-enable network connections.*

*\* Please be sure to use new network name.*

## Wireless LAN

The Wireless LAN is compatible with other LAN systems based on Direct Sequence Spread Spectrum / Orthogonal Frequency Division Multiplexing radio technology that complies with the IEEE802.11 Wireless LAN standard.

- Frequency Channel Selection of 5GHz for IEEE 802.11a or/and IEEE802.11n
- Frequency Channel Selection of 2.4GHz for IEEE 802.11b/g or/and IEEE802.11n
- Roaming over multiple channels
- Card power management
- Wired Equivalent Privacy (WEP) data encryption based on an 128-bit encryption algorithm
- Wi-Fi Protected Access™ (WPA™)



*The transmission speed over the wireless LAN, and the distance over which the wireless LAN can reach, may vary depending on surrounding electromagnetic environment, obstacles, access point design and configuration, client design and software/hardware configurations. The transmission rate described is the theoretical maximum speed as specified under the appropriate standard - the actual transmission speed will be lower than the theoretical maximum speed.*

### Setting

1. Please make sure that the **Wireless Communication Function** is on.
2. Click **Start** -> **Control Panel** -> **Network and Internet** -> **Network and Sharing Center**.
3. Click **Set up a new connection or network**.
4. Follow the wizard. You will need the name of the wireless network together with security settings. Consult the documentation accompanied with your router or ask your wireless network administrator for the settings.

### Security

- TOSHIBA strongly recommend that you enable encryption functionality, otherwise your computer will be open to illegal access by an outsider using a wireless connection. If this occurs, the outsider may illegally access your system, eavesdrop, or cause the loss or destruction of stored data.
- TOSHIBA is not liable for the loss of data due to eavesdropping or illegal access through the wireless LAN and the damage thereof.



## Bluetooth wireless technology

Bluetooth wireless technology eliminates the need for cables, such as desktop computers, between your computer and other electronic devices, example of printers and mobile phones.

You cannot use the computer's built-in Bluetooth functions and an external Bluetooth adaptor simultaneously. For reference, Bluetooth wireless technology has the following features:

### **Worldwide operation**

The Bluetooth radio transmitter and receiver operate in the 2.4GHz band, which is license-free and compatible with radio systems in most countries in the world.

### **Radio links**

You can easily establish links between two or more devices, with these links being maintained even if the devices are not within a line-of-sight of each other.

### **Security**

Two advanced security mechanisms ensure a high level of security:

- Authentication prevents access to critical data and makes it impossible to falsify the origin of a message.
- Encryption prevents eavesdropping and maintains link privacy.

### **Bluetooth Stack for Windows by TOSHIBA**

Please note that this software is specifically designed for the following operating systems:

- Windows 7

Information regarding the use of this software with these operating systems is listed below, with further details being contained with the electronic help files supplied with the software.



*This Bluetooth Stack is based on the Bluetooth Version 1.1/1.2/2.0+EDR/2.1+EDR/3.0/3.0+HS specification. However, TOSHIBA cannot confirm the compatibility between any computing products and/or other electronic devices that use Bluetooth, other than TOSHIBA notebook computers.*

### **Release Notes related to the Bluetooth Stack for Windows by TOSHIBA**

1. Fax application software:  
Please be aware that there is some fax application software that you cannot use on this Bluetooth Stack.
2. Multi-user considerations:  
The use of Bluetooth is not supported in a multi-user environment. This means that, when you use Bluetooth, other users that are logged into the same computer will not be able to use this type of functionality.

### *Product Support:*

The latest information regarding operating system support, language support or available upgrades can be found on our web site <http://www.toshiba-europe.com/computers/tnt/bluetooth.htm> in Europe or [www.pcsupport.toshiba.com](http://www.pcsupport.toshiba.com) in the United States.

## Enable/Disable Wireless communication

You can enable or disable Wireless communication functions by pressing **FN + F8**. No transmissions are sent or received when wireless communication is turned off.

## LAN

The computer has built-in support for Ethernet LAN (10 megabits per second, 10BASE-T), Fast Ethernet LAN (100 megabits per second, 100BASE-TX) or Gigabit Ethernet LAN (1000 megabits per second, 1000BASE-T).

This section describes how to connect/disconnect to a LAN.



*Do not install or remove a memory module while Wake-up on LAN is enabled.*



- *The Wake-up on LAN function consumes power even when the system is off. Leave the AC adaptor connected while using this feature.*
- *The Link speed (10/100/1000 megabits per second) changes automatically depending on the network conditions (connected device, cable or noise and so on).*

## LAN cable types



*The computer must be configured properly before connecting to a LAN. Logging onto a LAN using the computer's default settings could cause a malfunction in LAN operation. Check with your LAN administrator regarding set-up procedures.*

If you are using Gigabit Ethernet LAN (1000 megabits per second, 1000BASE-T), be sure to connect with a CAT5E cable or higher. You cannot use a CAT3 or CAT5 cable.

If you are using Fast Ethernet LAN (100 megabits per second, 100BASE-TX), be sure to connect with a CAT5 cable or higher. You cannot use a CAT3 cable.

If you are using Ethernet LAN (10 megabits per second, 10BASE-T), you can connect with a CAT3 or higher cable.

## Connecting the LAN cable

To connect the LAN cable, follow the steps as detailed below:



- *Connect the AC adaptor before connecting the LAN cable. The AC adaptor must remain connected during LAN use. If you disconnect the AC Adaptor while the computer is accessing a LAN, the system may hang up.*
- *Do not connect any other cable to the LAN jack except the LAN cable. Otherwise, malfunctions or damage may occur.*
- *Do not connect any power supplying device to the LAN cable that is connected to the LAN jack. Otherwise, malfunctions or damage may occur.*

1. Turn off the power to the computer and to all external devices connected to the computer.
2. Plug one end of the cable into the LAN jack. Press gently until you hear the latch click into place.

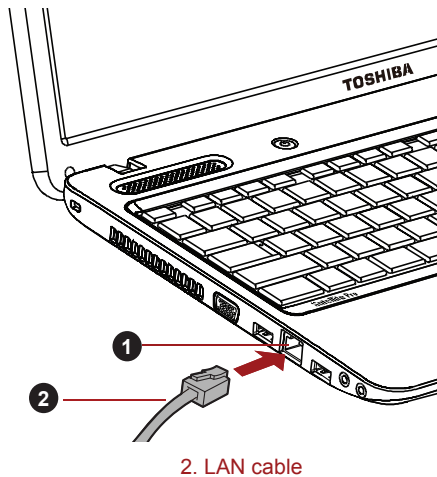

1. LAN jack

2. LAN cable

*Figure 4-8 Connecting the LAN cable*

3. Plug the other end of the cable into a LAN hub connector or router. Check with your LAN administrator and hardware or software vendor before using or configuring a network connection.

## Disconnecting the LAN cable

To disconnect the LAN cable, follow the steps as detailed below:

1. Pinch the lever on the connector in the computer's LAN jack and pull out the connector.
2. Disconnect the cable from the LAN hub or router in the same manner. Check with your LAN administrator and hardware or software vendor before disconnecting from the hub.

## Computer Handling

This section explains computer handling and maintenance.

### Cleaning the computer

To help ensure long, trouble-free operation, keep the computer free of dust and dirt, and use care with all liquids around it.

- Be careful not to spill liquids into the computer. If the computer does get wet, turn the power off immediately and let the computer dry completely - in these circumstance you should get the computer inspected by an authorized service provider in order to assess the scope of any damage.
- Clean the plastics of the computer using a slightly water dampened cloth.
- You can clean the display screen by spraying a small amount of glass cleaner onto a soft, clean cloth and then wiping the screen gently with the cloth.



*Never spray cleaner directly onto the computer or let liquid run into any part of it. Never use harsh or caustic chemical products to clean the computer.*

### Moving the computer

While the computer is designed for flexible day-to-day usage you should exercise a few simple precautions when moving it in order to help ensure trouble-free operation.

- Make sure all disk/disc activity has ended before moving the computer.
- Turn off (shut down) the computer.
- Disconnect the AC adaptor and all peripherals before moving the computer.
- Close the display panel.
- Do not pick up the computer by its display panel.
- Before carrying your computer, shut it down, disconnect the AC adaptor and allow it to cool down - a failure to follow this instruction may result in minor heat injury.
- Be careful not to subject the computer to impact or shock - a failure to follow this instruction could result in damage to computer, computer failure or loss of data.
- Never transport your computer with any cards installed - this may cause damage to either the computer and/or the card resulting in product failure.
- Always use a suitable carry case when transporting the computer.
- When carrying your computer, be sure to hold it securely so that it does not fall or hit anything.
- Do not carry your computer by holding any of its protruding elements.

## Heat dispersal

To protect against overheating, the processor is equipped with an internal temperature sensor which activates a cooling fan or lowers the processing speed if the computer's internal temperature rises to a certain level. You are able to select whether to control this temperature by either turning on the fan first, then if necessary lowering the processor speed, or by lowering the processor speed first, then if necessary turning on the fan. Both of these functions are controlled through the Power Options.

When the processor's temperature falls within normal range, the fan will be turned off and the processor operation returned to its standard speed.



*If the processor's temperature reaches an unacceptably high level with either setting, the computer automatically shuts down to prevent any damage. In this instance all unsaved data in memory will be lost.*

## Chapter 3

### Hardware, Utilities and Options

#### Hardware

This section describes the hardware of your computer. The actual specifications may vary depending on the model you purchased.

#### *Processor*

---

##### **CPU**

Your computer is equipped with one processor and processor type varies depending on model. To check which type of processor is included in your model, open the TOSHIBA PC Diagnostic Tool Utility by clicking **Start -> All Programs -> TOSHIBA -> Utilities -> PC Diagnostic Tool**.

---

#### *Legal Footnote (CPU)*

For more information on the CPU, please refer to the Legal Footnotes section in Appendix E.

## Memory

<b>Memory slots</b>	<p>1 GB, 2 GB or 4 GB memory modules can be installed in the computer's two memory slots for a maximum of 8 GB system memory.</p> <p>This computer can be equipped with memory modules of a maximum size of 8 GB. The actual amount of useable system memory will be less than the installed memory modules.</p>
<b>Video RAM</b>	<p>The memory in a computer's graphics adaptor, used to store the image displayed on a bitmap display.</p> <p>The amount of Video RAM available is dependent on the computer's system memory.</p> <p><b>Start -&gt; Control Panel -&gt; Appearance and Personalization -&gt; Display -&gt; Adjust resolution.</b></p> <p>The amount of Video RAM can be verified by clicking the <b>Advanced Settings</b> button in the Screen Resolution window.</p>



*If your computer is configured with more than 3 GB memory, the memory might be displayed as approximately 3 GB only (depending on the computer's hardware specifications).*

*This is correct because the operating system usually displays the available memory instead of the physical memory (RAM) built into the computer.*

*Various system components (like the video adapter's GPU and PCI devices like Wireless LAN, etc.) require their own memory space. Since a 32-bit operating system cannot address more than 4 GB of memory, these system resources overlap the physical memory. It is a technical limitation that the overlapped memory is not available to the operating system. Even though some tools might display the actual physical memory built into your computer, the memory available to the operating system will still be approximately 3 GB only.*

*Computers configured with a 64-bit operating system can address 4GB or more of system memory.*

### **Legal Footnote (Memory (Main System))**

For more information regarding Memory (Main System), please refer to the Legal Footnotes section in Appendix E.

## Power

<b>Battery pack</b>	The computer is powered by one rechargeable lithium-ion battery pack.
---------------------	---

**Legal Footnote (Battery Life)**

For more information regarding Battery Life, please refer to the Legal Footnotes section in Appendix E.

<b>RTC battery</b>	The internal RTC battery backs up the Real Time Clock (RTC) and calendar.
<b>AC adaptor</b>	<p>The AC adaptor provides power to the system and recharges the batteries when they are low. It comes with a detachable power cord which will either have a 2-pin or 3-pin plug enclosure.</p> <p>As the AC adaptor is universal, it can receive a range of AC voltages from 100 to 240 volts, however you should note that the output current varies among different models. Using the wrong adaptor can damage your computer. Refer to the <a href="#">AC adaptor</a> section in Chapter 2, The Grand Tour.</p>

**Disks**

<b>Hard disk drive</b>	<p>The size of the hard disk drive varies depending on the model.</p> <p>To check which type of HDD is included in your model, open the TOSHIBA PC Diagnostic Tool Utility by clicking <b>Start -&gt; All Programs -&gt; TOSHIBA -&gt; Utilities -&gt; PC Diagnostic Tool</b>.</p> <p>Please note that part of the hard disk's overall capacity is reserved as administration space. Additional HDD drive sizes may be introduced.</p>
------------------------	--

**Legal Footnote (Hard Disk Drive (HDD) Capacity)**

For more information regarding Hard Disk Drive (HDD) Capacity, please refer to the Legal Footnotes section in Appendix E.

**Optical disc drive**

<b>Drive</b>	<p>The following optical disc drive may be pre-installed in this computer.</p> <ul style="list-style-type: none"> <li>■ DVD Super Multi drive</li> </ul>
--------------	--



2.6GB and 5.2GB DVD-RAM media cannot be read from or written to.



## Display

The computer's internal display panel supports high-resolution video graphics and can be set to a wide range of viewing angles for maximum comfort and readability.

### Display panel

39.6cm (15.6") LCD screen, 16 million colors, with the following resolution:

- HD, 1366 horizontal x 768 vertical pixels

### Intel® Display Power Saving Technology

Intel GPU model may include the Display Power Saving Technology feature that can save the computer's power consumption by optimizing picture contrast on the internal LCD.

This feature can be used if the computer is:

- running under battery mode
- using the internal LCD display only

The Display Power Saving Technology feature is enabled at factory default. If you want to disable this feature, you can disable it.

The Display Power Saving Technology feature can be disabled in the Intel® Graphics and Media Control Panel.

You can access this control panel in one of the following ways:

- Click **Start -> Control Panel**. Select **Large icons** or **Small icons** in **View by**, and then click **Intel(R) Graphics and Media**.
- Right-click on the desktop and click **Graphics Properties...**

In this control panel:

1. Select **Basic Mode** and click **OK**.
2. Click **Power**.
3. Select **On battery** from the drop-down menu in **Power Source**.
4. Clear the **Display Power Saving Technology** check box.
5. Click **OK**.

If you want to enable this feature, under the conditions mentioned above, select the **Display Power Saving Technology** check box.

### Legal Footnote (LCD)

For more information regarding the LCD, please refer to the Legal Footnotes section in Appendix E.

### Graphics controller

The graphics controller maximizes display performance. Refer to [Display Controller and Video mode](#) section in Appendix B for more information.

### **Legal Footnote (Graphics Processing Unit ("GPU"))**

For more information regarding the Graphics Processing Unit ("GPU"), please refer to the Legal Footnotes section in Appendix E.

### **Sound**

**Sound system** The integrated sound system provides support for the computer's internal speakers and microphone, as well as allowing an external microphone and headphones to be connected via the appropriate jacks.

### **Multimedia**

**Web Camera** **Web Camera** is a device that allows you to record video or take photographs with your computer. You can use it for video chatting or video conferences using a communication tool such as **Windows Live Messenger**. **TOSHIBA Web Camera Application** will help you to add various video effects to your video or photograph. Some models are equipped with a Web Camera. Please refer to the [Web Camera](#) section in Chapter 4, Operating Basics.

### **Communications**

**LAN** Some computers in this series have built-in support for Ethernet LAN (10 megabits per second, 10BASE-T), Fast Ethernet LAN (100 megabits per second, 100BASE-TX) or Gigabit Ethernet LAN (1000 megabits per second, 1000BASE-T).

**Bluetooth** Some computers in this series have Bluetooth wireless communication function which eliminates the need for cables between electronic devices such as computers, printers and mobile phones. When it is enabled, Bluetooth provides the wireless personal area network environment which is safe and trustworthy, that is quick and easy.

**Wireless LAN** Some computers in this series are equipped with a Wireless LAN module that is compatible with other Wireless LAN systems based on Direct Sequence Spread Spectrum/Orthogonal Frequency Division Multiplexing radio technology that complies with the IEEE 802.11 Standard.

**Legal Footnote (Wireless LAN)**

For more information regarding Wireless LAN, please refer to the Legal Footnotes section in Appendix E.

**Special features**

The following features are either unique to TOSHIBA computers or are advanced features which make the computer more convenient to use.

Access each function using the following procedures.

\*1 To access the Power Options, click **Start -> Control Panel -> System and Security -> Power Options**.

<b>Hot keys</b>	Hot keys are specific key combinations that let you quickly change the system configuration directly from the keyboard without running a system program.
<b>Display automatic power off</b> *1	This feature automatically cuts off power to the computer's display panel when there is no keyboard input for a specified time, with power being restored the next time a key is pressed. This can be specified in the Power Options.
<b>HDD automatic power off</b> *1	This feature automatically cuts off power to the hard disk drive when it is not accessed for a specified time, with power being restored when the hard disk drive is next accessed. This can be specified in the Power Options.
<b>System automatic Sleep/Hibernation Mode</b> *1	This feature automatically shuts down the system into either Sleep Mode or Hibernation Mode when there is no input or hardware access for a specified time. This can be specified in the Power Options.
<b>Power on password</b>	Two levels of password security, supervisor and user, are available to prevent unauthorized access to your computer.
<b>Instant security</b>	A specific hot key function automatically locks the system providing data security.
<b>Intelligent power supply</b> *1	A microprocessor in the computer's intelligent power supply detects the battery's charge, automatically calculates the remaining battery capacity and protects electronic components from abnormal conditions such as a voltage overload from the AC adaptor. This can be specified in the Power Options.

---

<b>Battery save mode</b> *1	This feature lets you configure the computer in order to save battery power. This can be specified in the Power Options.
<b>Panel power on/off</b> *1	This feature automatically turns power to the computer off when the display panel is closed, and turns it back on when the display panel is opened. This can be specified in the Power Options.
<b>Low battery automatic Hibernation Mode</b> *1	When battery power is exhausted to the point that computer operation cannot be continued, the system automatically enters Hibernation Mode and shuts itself down. This can be specified in the Power Options.
<b>Heat dispersal</b> *1	<p>To protect against overheating, the processor has an internal temperature sensor so that, if the computer's internal temperature rises to a certain level, the cooling fan is turned on or the processing speed is lowered. This can be specified in the Power Options.</p> <p><b>Maximum Performance:</b> Turns on fan first, then if necessary lowers CPU processing speed.</p> <p><b>Battery Optimized:</b> Lowers the CPU processing speed first, then if necessary turns on the fan.</p>
<b>Hibernation Mode</b>	This feature lets you turn off the power to the computer without exiting from your software. The contents of main memory are automatically saved to the hard disk drive so that when you next turn the power on again, you can continue working right where you left off. Refer to the <a href="#">Turning off the power</a> section in Chapter 1, Getting Started, for more details.
<b>Sleep Mode</b>	If you have to interrupt your work, you can use this feature to allow you to turn off power to the computer without exiting from your software. Data is maintained in the computer's main memory so that when you next turn on the power, you can continue working right where you left off.

---

## Utilities and Applications

This section describes the pre-installed utilities that come with the computer and details how to start them. For further information on their operation, you may refer to each utility's online manual, help files or README.TXT file (if applicable).

You may not have all the utilities or applications listed below depending on the model you purchased.

<b>TOSHIBA Power Saver</b>	TOSHIBA Power Saver provides you with the features of more various power supply managements.
<b>TOSHIBA PC Diagnostic Tool</b>	The TOSHIBA PC Diagnostic Tool will display basic system configuration information and allow the functionality of some of the computer's built-in hardware devices to be tested.
<b>TOSHIBA Flash Cards</b>	The TOSHIBA Flash Cards provide a quick way to modify selected system functions. ■ Hot key function
<b>HW Setup</b>	This utility allows you to customize your hardware settings according to the way you work with the computer and the peripherals you use.
<b>TOSHIBA Accessibility</b>	The TOSHIBA Accessibility utility provides support to movement impaired users when they need to use the TOSHIBA Hot-key functions. In use, the utility allows you to make the <b>FN</b> key 'sticky', that is you can press it once, release it, and they press one of the " <b>Function</b> " keys in order to access its specific function. When set, the <b>FN</b> key will remain active until another key is pressed.
<b>TOSHIBA Face Recognition</b>	TOSHIBA Face Recognition uses a face verification library to verify the face data of users when they log in to Windows. If the verification is successful, the user will be logged into Windows automatically. The user can thus avoid having to enter a password or the like, which makes the login process easier.  For more information, please refer to the <a href="#">Using the TOSHIBA Face Recognition</a> section in Chapter 4, Operating Basics.

---

**TOSHIBA VIDEO  
PLAYER**

The player lets you view DVD movies, or video content recorded using home video camcorders. You can play DVD-Video, DVD-R and video files. It has an on-screen interface and functions. Click **Start -> All Programs -> TOSHIBA VIDEO PLAYER -> TOSHIBA VIDEO PLAYER**.

For more information, please refer to the [TOSHIBA VIDEO PLAYER](#) section in Chapter 4, Operating Basics.

---

**Bluetooth Stack for  
Windows by  
TOSHIBA**

This software enables communication between the computer and external Bluetooth devices such as printers and mobile phones.



*Bluetooth functions cannot be used in models that do not have a Bluetooth module installed.*

---

**TOSHIBA Assist**

TOSHIBA Assist is a graphical user interface that provides access to specific tools, utilities and applications that make the use and configuration of the computer easier.

---

**TOSHIBA ConfigFree**

TOSHIBA ConfigFree is a suite of utilities that improve the ease and control of communication devices and network connections, help in the identification of communication problems and allow the creation of profiles if you need to switch between different locations and communication networks. To access this utility, click **Start -> All Programs -> TOSHIBA -> ConfigFree**.

---

**TOSHIBA Disc  
Creator**

You can create CDs and DVDs in a number of formats including audio CDs that can be played on a standard CD player, and data CDs/DVDs which can store copies of the files and folders on your computer's hard disk drive.

To start this utility, click **Start -> All Programs -> TOSHIBA -> CD&DVD Applications -> Disc Creator**.

---

**TOSHIBA DVD-RAM  
Utility**

This utility has the function of Physical Format and Write-Protect to DVD-RAM. This utility is contained the setup module of TOSHIBA Disc Creator.

To start this utility, click **Start -> All Programs -> TOSHIBA -> CD&DVD Applications -> DVD-RAM Utility**.

---

---

**TOSHIBA HDD/SSD  
Alert Utility**

This utility includes wizard functions to monitor the Disk Drive operating status and execute the system backup.

To access the utility, click **Start -> All Programs -> TOSHIBA -> Utilities -> HDD SSD Alert**.

---

**TOSHIBA Service  
Station**

This application allows your computer to automatically search for TOSHIBA software updates or other alerts from TOSHIBA that are specific to your computer system and its programs. When enabled, this application periodically transmits to our servers a limited amount of system information, which will be treated in strict accordance with the rules and regulations as well as applicable data protection law.

To access this utility, click **Start -> All Programs -> TOSHIBA -> Utilities -> Service Station**.

---

**TOSHIBA Bulletin  
Board**

Bulletin Board is a convenient place to pin things to visually organize in a fun and creative way.

Simply drag and drop your favorite pictures, files or notes to pin them on the Board. You can use it to create thumbnail shortcuts, reminders, to-do list and so on according to your personal style.

To access this utility, click **Start -> All Programs -> TOSHIBA -> TOSHIBA Bulletin Board**.

---

**TOSHIBA ReelTime**

This application is a graphical history/indexing tool that enables you to view recently accessed files in a fun and easy-to-use format. View and scroll through your history of opened or imported files via thumbnails in an intuitive user interface.

To access this utility, click **Start -> All Programs -> TOSHIBA -> TOSHIBA ReelTime**.

---

**TOSHIBA Wireless  
LAN Indicator**

TOSHIBA Wireless LAN Indicator utility displays the system's Wireless LAN connection status on the logon screen.

You can quickly check the current Wireless LAN connection status before logging into Windows.

To change the settings of this utility, click **Start -> All Programs -> TOSHIBA -> Networking -> Wireless Indicator - Settings**.

---

---

**TOSHIBA Media Controller**

This application allows you to control your music, pictures and videos by streaming content to any compatible device in your home.

To access this utility, click **Start -> All Programs -> TOSHIBA -> TOSHIBA Media Controller -> TOSHIBA Media Controller**.

For more information, please refer to the TOSHIBA Media Controller Help.

---

**TOSHIBA Speech System**

The TOSHIBA Speech System consists of a voice-composition application (text-to-speech) that analyzes documents and reads them aloud, and a speech-recognition application that recognizes the words you speak into a microphone. This allows you to control and operate various Windows programs by voice command rather than using the keyboard or a mouse.

To access this utility, click **Start -> All Programs -> TOSHIBA -> Speech System**.

For more information, please refer to the TOSHIBA Speech System Help.

---

## Optional devices

Optional devices can expand the computer's capabilities and its versatility. This section describes the connection or installation of the following devices:

### *Cards/memory*

- Memory media slot
  - Secure Digital™ (SD) Card (SD memory card, SDXC memory card, miniSD Card, microSD Card)
  - MultiMediaCard
- Additional memory module

### *Peripheral devices*

- External monitor
- HDMI

### *Other*

- Security lock



## Memory media slot

The computer may be equipped with a Memory media slot that can accommodate some kinds of memory media with various memory capacities so that you can easily transfer data from devices, such as digital cameras and Personal Digital Assistants.



*Keep foreign objects out of the Memory media slot. Never allow metal objects, such as screws, staples and paper clips, to enter the computer or Keyboard. Foreign metal objects can create a short circuit, which can cause computer damage and fire, possibly resulting in serious injury.*



- This Memory media slot supports the following memory media.
  - Secure Digital (SD) Card (SD memory card, SDXC memory card, miniSD Card, microSD Card)
  - MultiMediaCard (MMC™)
- Please note that an adaptor is required to use miniSD/microSD Card.
- Please note that not all memory media have been tested and verified to work correctly. Therefore, it is not possible to guarantee that all memory media will operate properly.
- The slot does not support Magic Gate functions.



Figure 3-1 Examples of memory media

## Memory media

This section provides the important safety precautions in order to handle your memory media.

### **Points to note about the SD/SDXC memory card**

SD/SDXC memory cards comply with SDMI (Secure Digital Music Initiative), which is a technology adopted to prevent unlawful copy or playback of digital music. For this reason, you cannot copy or playback protected material on another computer or other device, and you may not reproduce any copyrighted material except for your personal enjoyment.

Below is a simple explanation for distinguishing SD memory cards from SDXC memory cards.

- SD and SDXC memory cards appear the same externally. However, the logo on SD and SDXC memory cards is different, so pay careful attention to the logo when purchasing.



- The SD memory card logo is (  )..
- The SDXC memory card logo is (  ).
- The maximum capacity of SD memory cards is 2GB. The maximum capacity of SDXC memory cards is 64GB.

Card Type	Capacities
SD	8MB, 16MB, 32MB, 64MB, 128MB, 256MB, 512MB, 1GB, 2GB
SDXC	64GB

### **Memory media format**

New media cards are formatted according to specific standards. If you wish to reformat a media card, be sure to do so with a device that uses media cards.

#### **Formatting an SD/SDXC memory card**

SD/SDXC memory cards are sold already formatted in conformity to specific standards. If you reformat an SD/SDXC memory card, be sure to reformat it with a device such as digital camera or digital audio player that uses the SD/SDXC memory cards, not with the format command provided within Windows.



*Should you need to format all areas of the memory card, including the protected area, you will need to obtain an appropriate application that applies the copy protection system.*

### **Media care**

Observe the following precautions when handling the card.

#### **Card care**

- Do not twist or bend cards.
- Do not expose cards to liquids or store in humid areas or lay media close to containers of liquid.
- Do not touch the metal part of a card or expose it to liquids or let it get dirty.
- After using card, return it to its case.
- The card is designed so that it can be inserted only one way. Do not try to force the card into the slot.
- Do not leave a card partially inserted in the slot. Press the card until you hear it click into place.

## Memory card care

- Set the write-protect switch to the lock position, if you do not want to record data.
- Memory cards have a limited lifespan, so it is important to backup important data.
- Do not write to a card if the battery power is low. Low power could affect writing accuracy.
- Do not remove a card while read/write is in progress.



*For more details on using memory cards, see manuals accompanying the cards.*

## About the write-protect

The following memory media have a function for protect.

- SD Card (SD memory card, SDXC memory card)
- MultiMediaCard (MMC)



*Set the write-protect switch to the lock position, if you do not want to record data.*

## Inserting a memory media

The following instructions apply to all types of supported media devices. To insert a memory media, follow the steps as detailed below:

1. Turn the memory media so that the contacts (metal areas) are face down.
2. Insert the memory media into the Memory media slot on the front of the computer.
3. Press the memory media gently to ensure a firm connection is made. The memory media will be partially out of the slot.

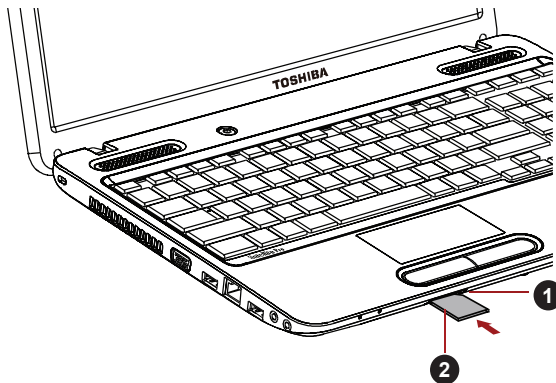

1. Memory media slot

2. Memory media

*Figure 3-2 Inserting a memory media*



- *Make sure memory media is oriented properly before you insert it. If you insert the media in wrong direction, you may not be able to remove it.*
- *When inserting memory media, do not touch the metal contacts. You could expose the storage area to static electricity, which can destroy data.*
- *Do not turn the computer off or switch to Sleep Mode or Hibernation Mode while files are being copied - doing so may cause data to be lost.*

## Removing a memory media

The following instructions apply to all types of supported media devices. To remove a memory media, follow the steps as detailed below:

1. Open the **Safely Remove Hardware and Eject Media** icon on the Windows Taskbar.
2. Point to **memory media** and click the left Touch Pad control button.
3. Grasp the media and pull it out of the computer to remove it.

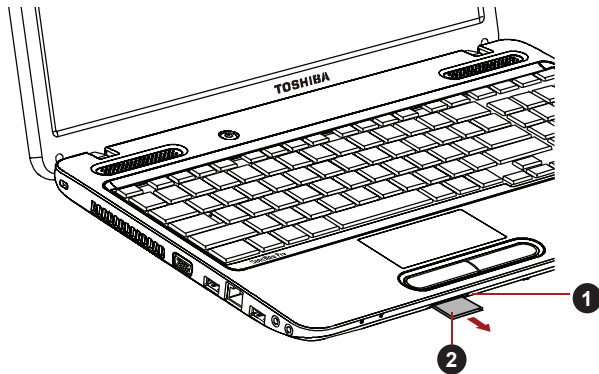

1. Memory media slot

2. Memory media

*Figure 3-3 Removing memory media*



- *If you remove the memory media or turn off the power while the computer is accessing the memory media, you may lose data or damage the media.*
- *Do not remove the memory media while the computer is in Sleep or Hibernation Mode. The computer could become unstable or data in the memory media could be lost.*
- *Do not remove only the miniSD/microSD Card while leaving the adaptor in the Memory media slot.*

## Additional memory module

You can install additional memory into the computer in order to increase the amount of system memory that is available. This section describes how to install and remove optional memory modules.



- You should place a mat beneath the computer in order to prevent the computer's lid from becoming scratched or damaged when you are installing/replacing the memory module. In this instance you should avoid mats that are made of materials that hold or generate static electricity.
- When installing or removing a memory module, you must ensure that you do not touch any other internal areas of the computer.
- Use a point size 0 Phillips screwdriver to remove and fasten the screws - the use of an incorrect screwdriver can damage the screw heads.



- Use only memory modules approved by TOSHIBA.
- Do not try to install or remove a memory module under the following conditions.
  - a. The computer is turned on.
  - b. The computer was shut down in either Sleep or Hibernation Mode.
  - c. Wake-up on LAN is enabled.
  - d. The wireless communication function is on.
- Be careful not to let screws or other foreign matter fall into the computer. It could cause malfunction or electric shock.
- Additional memory module is a precision electronic component that may be fatally damaged by static electricity. Since the human body can carry static electricity, it is important that you discharge yourself before touching or installing any additional memory modules. To discharge your body's static electricity, simply touch any metal close to you with bare hands.

### Installing a memory module

To install a memory module, follow the steps as detailed below:

1. Shut down the computer - make sure the **Power** indicator is off (refer to the [Turning off the power](#) section in Chapter 1, Getting Started if required).
2. Remove the AC adaptor and all cables and peripherals connected to the computer.
3. Close the display panel.
4. Turn the computer upside down and remove the battery pack (refer to [Replacing the battery pack](#) section in Chapter 6, Power and Power-Up Modes, if required).
5. Loosen the screw securing the memory module cover in place - please note that the screws is attached to the cover in order to prevent them from being lost.



Use a point size 0 Phillips screwdriver.

- Slide your fingernail or a thin object under the cover and lift it off.

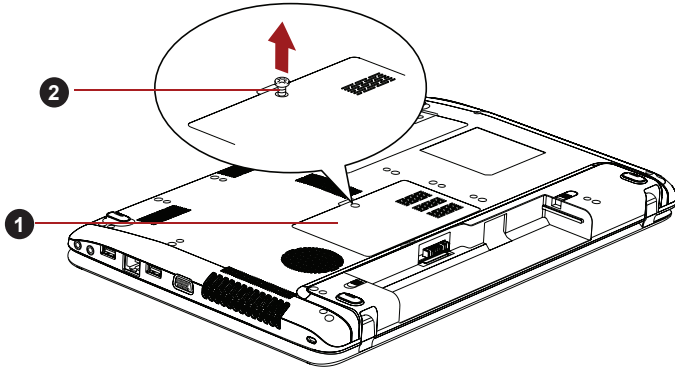

1. Memory module cover

2. Screw

*Figure 3-4 Removing the memory module cover*

- Align the notch of the memory module with that of the memory slot and gently insert the module into the slot at about a 30 degree angle before holding it down until the latches on either side snap into place.

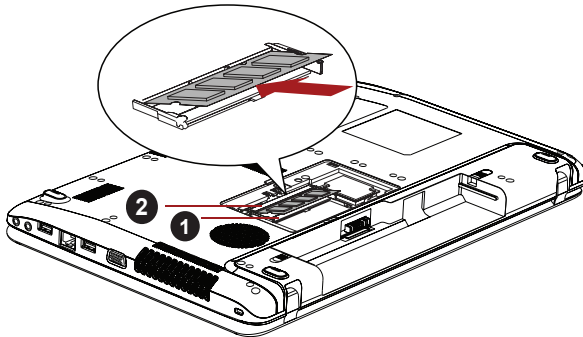

1. Slot A

2. Slot B

*Figure 3-5 Seating the memory module-1*

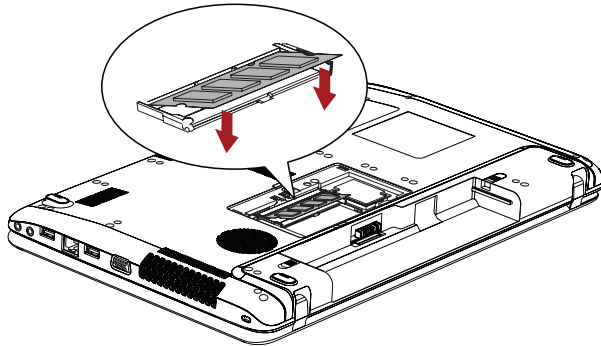

Figure 3-6 Seating the memory module-2



- Never allow metal objects, such as screws, staples and paper clips, to enter the computer. Foreign metal objects can create a short circuit, which can cause computer damage and fire, possibly resulting in serious injury.
- Do not touch the connectors on the memory module or on the computer. Debris on the connectors may cause memory access problems.



- The slot A is reserved for the first memory module. Use the slot B for expanded memory. If only one module is installed, use the slot A.
- Align the grooves along the edges of the memory module with the locking tabs on the connector and insert the module into the connector firmly - if you find it difficult to install the memory module, gently prise the locking tabs outwards using the tip of your finger.  
Please also ensure that you hold the memory module along its left and right hand edges - the edges with the grooves in.

8. Seat the memory module cover in place and secure it with the screw.



Take care to ensure that the memory module cover is firmly closed.

9. Install the battery pack - refer to [Replacing the battery pack](#) section in Chapter 6, Power and Power-Up Modes, if required.
10. Turn your computer over.
11. Turn the computer on and make sure the added memory is recognized - to confirmed it, **Start -> Control Panel -> System and Security -> System** icon.

## Removing a memory module

To remove the memory module, follow the steps as detailed below:

1. Shut down the computer - make sure the **Power** indicator is off (refer to the *Turning off the power* section in Chapter 1, Getting Started if required).
2. Remove the AC adaptor and all cables and peripherals connected to the computer.
3. Close the display panel.
4. Turn the computer upside down and remove the battery pack (refer to *Replacing the battery pack* section in Chapter 6, Power and Power-Up Modes, if required).
5. Loosen the screw securing the memory module cover in place - please note that the screw is attached to the cover in order to prevent them from being lost.
6. Slide your fingernail or a thin object under the cover and lift it off.
7. Push the latches away from the module in order to release it - a spring will force one end of the module up at an angle.
8. Grasp the module by its edges and remove it from the computer.



- *If you use the computer for a long time, the memory modules and the circuits locating close to the memory modules will become hot. In this case, let them cool to room temperature before you replace them. Or you will get burnt if you touch any of them.*
- *Do not touch the connectors on the memory module or on the computer. Debris on the connectors may cause memory access problems.*

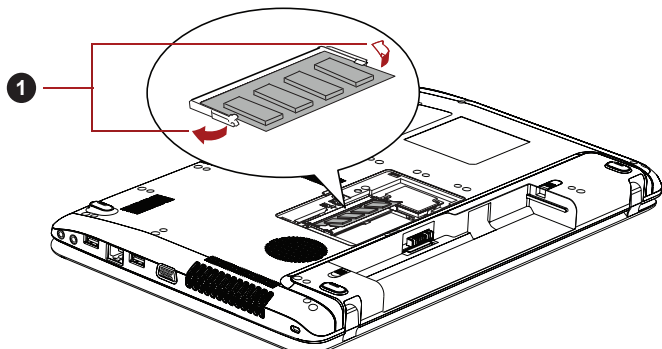

1. Latches

*Figure 3-7 Removing the memory module*

9. Seat the memory module cover in place and secure it with the screw.



*Take care to ensure that the memory module cover is firmly closed.*



10. Install the battery pack - refer to [Replacing the battery pack](#) section in Chapter 6, Power and Power-Up Modes, if required.
11. Turn your computer over.

## External monitor

An external analog monitor can be connected to the external monitor port on the computer. To connect a monitor, follow the steps as detailed below:

### Connecting the monitor cable

1. Turn the computer's power off.
2. Connect the monitor cable to the external monitor port.

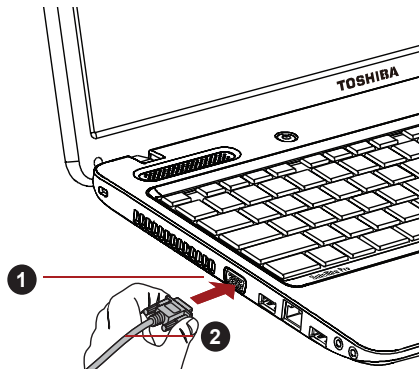

1. External monitor port
2. Monitor cable

*Figure 3-8 Connecting the monitor cable to the external monitor port*

3. Turn the external monitor's power on.
4. Turn the computer's power on.

When you turn on the power, the computer will automatically recognize the monitor and determine whether it is a color or monochrome device. In the event that you find that there are issues getting an image displayed on the correct monitor, you should consider using the **FN + F5** hot key to change the display settings (if you then disconnect the external monitor before you turn the computer's power off, be sure to press **FN + F5** hot key again to switch to the internal display).

Please refer to Chapter 5, [The Keyboard](#), for further details on using hot keys to change the display setting.



*Do not disconnect the external monitor while in Sleep or Hibernation Mode. Turn off the computer before disconnecting the external monitor.*

When displaying desktop at external analog monitor, desktop is sometimes displayed on the center of the monitor with black bars around desktop (with small size).

At that time, please read the manual of the monitor and set the display mode which is supporting at the monitor. Then it will be displayed with suitable size with correct aspect ratio.

## HDMI

Some models are equipped with an HDMI out port.

An HDMI monitor can be connected to the HDMI out port on the computer. To connect monitor, follow the steps as detailed below:



*As the port operation of all HDMI (High-Definition Multimedia Interface) monitors have not been confirmed, some HDMI monitors may not function properly.*

### Connecting the HDMI out port

1. Plug one end of the HDMI cable into the HDMI out port of the HDMI device.
2. Plug the other end of the HDMI cable into the HDMI out port on your computer.

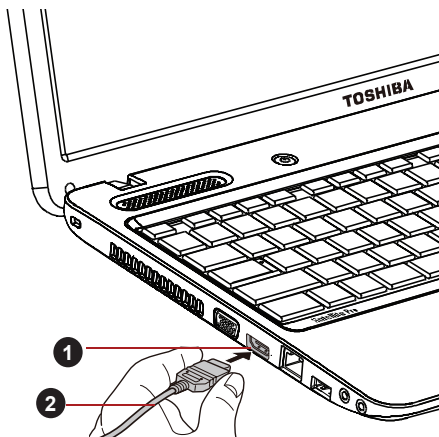

1. HDMI out port

2. HDMI cable

*Figure 3-9 Connecting the HDMI out port*



*Please connect or disconnect an HDMI device to or from the computer under the following conditions:*

- *The computer is turned on.*
- *The computer is completely turned off.*

*Do not do so when the computer is in Sleep Mode or Hibernation Mode.*



- *When you connect a television or external monitor to the HDMI port, the display output device is set to HDMI.*
- *When you unplug the HDMI cable and re-plug it, please wait at least 5 seconds before you re-plug the HDMI cable again.*
- *When you change the display output device by hot key like **FN + F5**, the playback device may not switch automatically. In this case, in order to set the playback device to the same device as the display output device, please adjust the playback device manually by the following steps:*
  - a. Click **Start** -> **Control Panel** -> **Hardware and Sound** -> **Sound**.
  - b. In the **Playback** tab, select the playback device which you want to switch to.
  - c. To use the internal speakers on your computer, select **Speakers**.  
To use the television or the external monitor that you have connected to the computer, select a different playback device.
  - d. Click the **Set Default** button.
  - e. Click **OK** to close the **Sound** dialog.

### **Settings for display video on HDMI**

To view video on the HDMI device, be sure to configure the following settings otherwise you may find that nothing is displayed.



- *Be sure to use the **FN + F5** HotKey to select the display device before starting to play video. Do not change the display device while playing video.*
- *Do not change the display device under the following conditions.*
  - *While data is being read or written.*
  - *While communication is being carried out.*

### **Select HD Format**

To select the display mode, follow the steps as detailed below:

1. Click **Start** and click **Control Panel**.
2. Click **Appearance and Personalization**.
3. Click **Display**.
4. Click **Change display settings**.
5. Click **Advanced settings**.
6. Click **List All Modes**.
7. Select the one of the below selection at "**List All Modes**".

Display mode at "List All Modes"	HD Format
1920 by 1080, True Color (32bit), 60Hertz	1080p
1920 by 1080, True Color (32bit), 30Hertz (Interlaced)	1080i
1280 by 720, True Color (32bit), 60Hertz	720p
720 by 576, True Color (32bit), 50Hertz	576p
720 by 480, True Color (32bit), 60Hertz	480p



*The above display mode is a typical HDMI display mode. The selectable display modes will vary for different HDMI monitors.*

## Security lock

A security lock enables you to anchor your computer to a desk or other heavy object in order to help prevent unauthorized removal or theft. The computer has a security lock slot on its left side into which you can attach one end of the security cable, while the other end attaches to a desk or similar object. The methods used for attaching security cables differ from product to product. Please refer to the instructions for the product you are using for more information.

### Connecting the security lock

In order to connect a security cable to the computer, follow the steps as detailed below:

1. Turn the computer so its left side faces you.
2. Align the security cable with the lock slot and secure it in place.

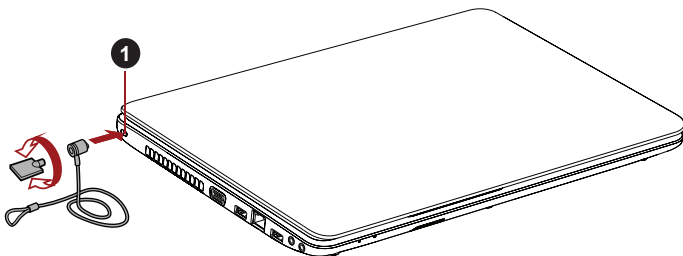

1. Security lock slot

*Figure 3-10 Security lock*

---

## Optional accessories

You are able to add a number of options and accessories in order to make your computer even more powerful and convenient to use. For reference, the following list details some of the items that are available from your reseller or TOSHIBA dealer:

---

<b>DDR3 Memory Kit</b>	A 1 GB, 2 GB or 4 GB memory module (DDR3) can easily be installed in the computer.
<b>Universal AC Adaptor</b>	If you frequently use your computer at more than one site, it may be convenient to purchase an additional AC adaptor to be kept at each site in order to remove the need to always carry the adaptor with you.
<b>Battery Pack</b>	An additional battery pack can be purchased for use as either a spare or replacement. Please refer to Chapter 6, <i>Power and Power-Up Modes</i> for further information.

---

# Chapter 5

## The Keyboard

The computer's keyboard layouts are compatible with a 104/105-key enhanced keyboard - by pressing some keys in combination, all of the 104/105-key enhanced keyboard functions can be performed on the computer.

The number of keys available on your keyboard will depend on which country/region your computer is configured for, with keyboards being available for numerous languages.

In use there are six different types of keys, specifically typewriter keys, function keys, soft keys, Hot keys, Windows special keys and the keypad overlay.

### Typewriter keys

The typewriter keys produce the upper-case and lower-case letters, numbers, punctuation marks, and special symbols that appear on the screen. However, there are some differences between using a typewriter and using a computer keyboard:

- Letters and numbers produced in computer text vary in width. Spaces, which are created by a "space character" may also vary depending on line justification and other factors.
- The lowercase l (el) and the number 1 (one), together with the uppercase O (oh) and the 0 (zero), are not interchangeable on computers as they are on a typewriter.
- The **CAPS LOCK** function key locks only the alphabetic characters into upper-case while the Shift Lock function on a typewriter places all keys in the shifted position.
- The **SHIFT** keys, the **Tab** key, and the **BACK SPACE** key perform the same function as their typewriter counterparts but also have special computer functions.



*Never remove the key caps on your keyboard. Doing so could cause damage to the parts under the key caps.*

## Function keys: F1 ... F9

The function keys (not to be confused with the special **FN** key) are the nine keys at the top of your keyboard - these keys function differently from other keys.



**F1** through **F9** are called function keys because they execute programmed functions when pressed and, when used in combination with the **FN** key, those keys marked with icons also execute specific functions on the computer. Please refer to the section, [Soft keys: FN key combinations](#), in this chapter for further information, taking care to note that the function executed by individual keys will depend on the software you are using.

## Soft keys: FN key combinations

The **FN** (function) is unique to TOSHIBA computers and is used in combination with other keys to form soft keys. Soft keys are key combinations that enable, disable or configure specific features.



*Please note that some software may disable or interfere with soft-key operations, and that the soft-key settings are not restored when the computer returns from Sleep Mode.*

This computer's keyboard is designed to provide all the features of the 104-key enhanced keyboard.

Since the keyboard is smaller and has fewer keys, some of the enhanced keyboard functions must be simulated using two keys instead of one on the larger keyboard.

The **FN** key can be combined with the following keys to simulate functions similar to those of keys on the 104/105 key enhanced keyboard which are not on this computer's keyboard.

## Hot keys

Hot keys (pressing **FN** + a function or **ESC** key) let you enable or disable certain features of the computer.

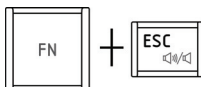

**Mute:** Pressing **FN** + **ESC** turns the sound on and off.

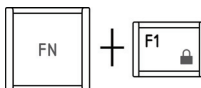

**Lock:** Pressing **FN** + **F1** enters "Lock computer mode". To restore your desktop, you need to log on again.

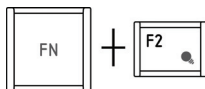

**Power Plan:** Pressing **FN + F2** changes the power settings.

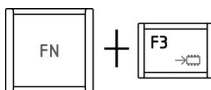

**Sleep:** Pressing **FN + F3** switches the system to Sleep Mode.

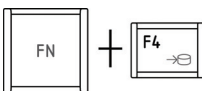

**Hibernate:** Pressing **FN + F4** switches the system to Hibernation Mode.

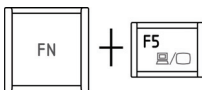

**Output:** Pressing **FN + F5** changes the active display device.



*To use a simultaneous mode, you must set the resolution of the internal display panel to match the resolution of the external display device.*

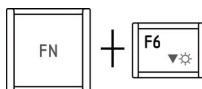

**Brightness Down:** Pressing **FN + F6** decreases the computer's display panel brightness in individual steps.

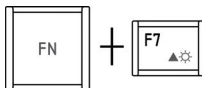

**Brightness Up:** Pressing **FN + F7** increases the computer's display panel brightness in individual steps.

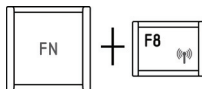

**Wireless:** Pressing **FN + F8** enables/disables the wireless devices.



*If no wireless communication device is installed, no dialog box will appear.*

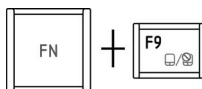

**Touch Pad:** Pressing **FN + F9** enables or disables the Touch Pad function.





**Zoom:** Pressing **FN + Space** changes the display resolution.

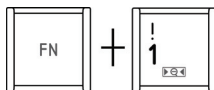

**Reduce:** Pressing **FN + 1** reduces the icon size on the desktop or the font sizes within one of the supported application windows.

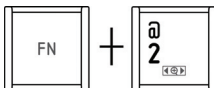

**Enlarge:** Pressing **FN + 2** enlarges the icon size on the desktop or the font sizes within one of the supported application windows.

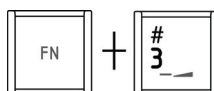

**Volume down:** Pressing **FN + 3** decreases the volume.

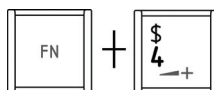

**Volume up:** Pressing **FN + 4** increases the volume in increment.

## FN Sticky key

You can use the TOSHIBA Accessibility Utility to make the **FN** key sticky, that is, you can press it once, release it, and then press an "**F Number**" key. To start the TOSHIBA Accessibility utility, click **Start -> All Programs -> TOSHIBA -> Utilities -> Accessibility**.

## Windows special keys

The keyboard provides two keys that have special functions in Windows, the Windows Start Button key activates the **Start** menu while the application key has the same function as the secondary (right) mouse button.



This key activates the Windows **Start** menu.



This key has the same function as the secondary (right) mouse button.

## Generating ASCII characters

Not all ASCII characters can be generated using normal keyboard operation, but you are able to generate these characters using their specific ASCII codes.

1. Hold down **ALT** key.
2. Using the numeric keypad, type the ASCII code of the character you require.
3. Release **ALT** - the ASCII character will appear on the display screen.

## Chapter 6

### Power and Power-Up Modes

The computer's power resources include the AC adaptor, battery pack and any internal batteries. This chapter provides details on making the most effective use of these resources, and includes information on charging and changing batteries, tips for saving battery power, and information on the different power-up modes.

#### Power conditions

The computer's operating capability and battery charge status are affected by different power conditions, including whether an AC adaptor is connected, whether a battery pack is installed and what the charge level is for that battery.

*Table 6-1 Power conditions*

		<b>Power on</b>	<b>Power off (no operation)</b>
<b>AC adaptor connected</b>	Battery fully charged	<ul style="list-style-type: none"> <li>• Operates</li> <li>• <b>DC IN/Battery LED:</b> green</li> </ul>	<ul style="list-style-type: none"> <li>• <b>DC IN/Battery LED:</b> green</li> </ul>
	Battery partially charged or no charge	<ul style="list-style-type: none"> <li>• Operates</li> <li>• Charge</li> <li>• <b>DC IN/Battery LED:</b> amber</li> </ul>	<ul style="list-style-type: none"> <li>• Quick charge</li> <li>• <b>DC IN/Battery LED:</b> amber</li> </ul>
	No battery installed	<ul style="list-style-type: none"> <li>• Operates</li> <li>• No charge</li> <li>• <b>DC IN/Battery LED:</b> green</li> </ul>	<ul style="list-style-type: none"> <li>• No charge</li> <li>• <b>DC IN/Battery LED:</b> green</li> </ul>

Table 6-1 Power conditions continued

		Power on	Power off (no operation)
<b>AC adaptor not connected</b>	Remaining battery capacity is above low battery trigger point	<ul style="list-style-type: none"> <li>Operates</li> <li><b>DC IN/Battery LED:</b> amber</li> </ul>	
	Remaining battery capacity is below low battery trigger point	<ul style="list-style-type: none"> <li>Operates</li> <li><b>DC IN/Battery LED:</b> blink amber</li> </ul>	
	Remaining battery capacity is exhausted	Computer shuts down	
	No battery installed	<ul style="list-style-type: none"> <li>No operation</li> <li><b>DC IN/Battery LED:</b> off</li> </ul>	

## Monitoring of power condition

As shown in the below table, the **DC IN/Battery** and **Power** indicators on the system indicator panel alert you to the computer's operating capability and battery charge status.

### DC IN/Battery indicator

Check the **DC IN/Battery** indicator to determine the status of the battery pack. The following indicator lights indicate the battery status:

<b>Blinking amber</b>	<p>The battery charge is low, the AC adaptor must be connected in order to recharge the battery.</p> <p>Or, Indicates a problem with the power supply. You should initially try plugging the AC adaptor into another power outlet - if it still does not operate properly, you should contact your reseller or dealer.</p>
<b>Amber</b>	Indicates the AC adaptor is connected and the battery is charging.

<b>Green</b>	Indicates the AC adaptor is connected and the battery is fully charged. Or, Indicates the AC adaptor is connected and there is no battery pack installed.
<b>No light</b>	Under any other conditions, the indicator does not light.



*If the battery pack becomes too hot while it is being charged, the charge will stop and the **DC IN/Battery** indicator will go out. When the battery pack's temperature falls to a normal range, charging will resume - this process will occur regardless of whether the computer's power is on or off.*

## Power indicator

Check the **Power** indicator to determine the power status of the computer - the following indicator conditions should be noted:

<b>Green</b>	Indicates power is being supplied to the computer and the computer is turned on.
<b>Blinking green</b>	Indicates that the computer is in Sleep Mode and that there is sufficient power available (AC adaptor or battery) to maintain this condition.
<b>No light</b>	Under any other conditions, the indicator does not light.

## Battery

This section explains battery types, use, recharging methods and handling.

### Battery types

The computer has different types of batteries.

#### **Battery pack**

When the AC adaptor is not connected, the computer's main power source is a removable lithium ion battery pack, also referred to in this manual as the main battery. You can purchase additional battery packs for extended use of the computer away from an AC power source although you should not change the battery pack while the AC adaptor is connected.

Before you remove the battery pack, save your data and shut down the computer, or place the computer into Hibernation Mode. Please be aware that, when placing the computer into Hibernation Mode, the contents of memory will be saved to the hard disk drive, although for safety sake, it is best to also save your data manually.

## Real Time Clock (RTC) battery

The Real Time Clock (RTC) battery provides power for the internal real time clock and calendar function and also maintains the system configuration while the computer is turned off. If the RTC battery becomes completely discharged, the system will lose this information and the real time clock and calendar will stop working.

You can change the Real Time Clock settings by turning the computer on while pressing the **F2** key and then release the **F2** key when the **TOSHIBA Leading Innovation >>>** screen appears. Please refer to Chapter 8 [Troubleshooting](#) for further information.

## Care and use of the battery pack

This section provides the important safety precautions in order to handle your battery pack properly.

Refer to the enclosed **Instruction Manual for Safety and Comfort** for detailed precautions and handling instructions.



- *Make sure the battery is securely installed in the computer before attempting to charge the battery pack. Improper installation could generate smoke or fire, or cause the battery pack to rupture.*
- *Keep the battery pack out of reach of infants and children. It can cause injury.*



- *The lithium ion battery pack can explode if not replaced, used, handled or disposed of properly. Dispose of the battery as required by local ordinances or regulations. Use only batteries recommended by TOSHIBA as replacements.*
- *The computer's RTC battery is a lithium battery and should be replaced only by your dealer or by a TOSHIBA service representative. The battery can explode if not properly replaced, used, handled or disposed. Dispose of the battery as required by local ordinances or regulations.*
- *Charge the battery pack only in an ambient temperature between 5 and 35 degrees Celsius. Otherwise, the electrolyte solution might leak, battery pack performance might deteriorate and the battery life might be shortened.*
- *Never install or remove the battery pack without first turning off the power and disconnecting the AC adaptor. Never remove the battery pack while the computer is in Sleep Mode. Data could be lost.*



- *Never remove the battery pack while the Wake-up on LAN function is enabled. Data will be lost. Before you remove a battery pack, disable the Wake-up on LAN function.*

## Charging the batteries

When the power in the battery pack becomes low, the **DC IN/Battery** indicator will blink amber to indicate that only a few minutes of battery power remain. If you continue to use the computer while the **DC IN/Battery** indicator blinks, the computer will enable Hibernation Mode so that you do not lose any data, and automatically turn itself off.

You must recharge a battery pack when it becomes discharged.

### Procedures

To recharge a battery pack while it is installed in the computer, connect the AC adaptor to the DC IN 19V jack and plug the other end into a working outlet - the **DC IN/Battery** indicator will glow amber while the battery is being charged.



*Use only the computer connected to an AC power source or optional TOSHIBA Battery charger to charge the battery pack. Never attempt to charge the battery pack with any other charger.*

### Time

Refer to User Information Guide about Charging time.

### Battery charging notice

The battery may not begin charging immediately under the following conditions:

- The battery is extremely hot or cold (if the battery is extremely hot, it might not charge at all). To ensure the battery charges to its full capacity, you should charge it at room temperature of between 5° to 35°C (41° to 95°F).
- The battery is nearly completely discharged. In this instance you should leave the AC adaptor connected for a few minutes and the battery should begin charging.

The **DC IN/Battery** indicator may show a rapid decrease in battery operating time when you try to charge a battery under the following conditions:

- The battery has not been used for a long time.
- The battery has completely discharged and been left in the computer for a long time.
- A cool battery is installed in a warm computer.

In such cases you should follow the steps as detailed below:

1. Fully discharge the battery by leaving it in the computer with the power on until the system automatically turns itself off.
2. Connect the AC adaptor to the DC IN 19V jack of the computer, and to a wall outlet that is supplying power.
3. Charge the battery until the **DC IN/Battery** indicator glows green.

Repeat these steps two or three times until the battery recovers normal capacity.

## Monitoring battery capacity

Remaining battery power can be monitored using the following methods.

- Clicking the battery icon on the Taskbar



- *You should wait at least 16 seconds after turning on the computer before trying to monitor the remaining operating time. This is because the computer needs this time to check the battery's remaining capacity and then calculate the remaining operating time, based on this together with the current power consumption.*
- *Please be aware that the actual remaining operating time may differ slightly from the calculated time.*
- *With repeated discharges and recharges, the battery's capacity will gradually decrease. In view of this it will be noted that an often used, older battery will not operate for as long as a new battery even when both are fully charged.*

## Maximizing battery operating time

A battery's usefulness depends on how long it can supply power on a single charge, while how long the charge lasts in a battery depends on:

- Processor speed
- Screen brightness
- System Sleep Mode
- System Hibernation Mode
- Display power off period
- Hard disk drive power off period
- How often and for how long you use the hard disk drive and external disk(c) drives, for example, optical disc drive.
- How much charge the battery contained to begin with.
- How you use optional devices, such as an external monitor, to which the battery supplies power.
- Whether you enable Sleep Mode, which can conserve battery power if you are frequently turning the computer off and on.
- Where you store your programs and data.
- Whether you close the display panel when you are not using the keyboard - closing the display saves power.
- The environmental temperature - operating time decreases at low temperatures.
- The condition of the battery terminals - you should always ensure the terminals stay clean by wiping them with a clean dry cloth before installing the battery pack.



## Battery exhausted time

Refer to User Information Guide about battery exhausted time.

## Extending battery life

To maximize the life of your battery packs:

- At least once a month, disconnect the computer from a power source and operate it on battery power until the battery pack fully discharges. Before doing so, follow the steps as detailed below.
  1. Turn off the computer's power.
  2. Disconnect the AC adaptor and turn on the computer's power - if it does not turn on then go to Step 4.
  3. Operate the computer on battery power for five minutes. If you find that the battery pack has at least five minutes of operating time, continue operating until the battery pack is fully discharged, however, if the **DC IN/Battery** indicator blinks or there is some other warning to indicate a low battery condition, go to Step 4.
  4. Connect the AC adaptor to the DC IN 19V jack of the computer, and to a wall outlet that is supplying power.
  5. Charge the battery pack until the **DC IN/Battery** indicator glows green.
- If you have extra battery packs, rotate their use.
- If you will not be using the system for an extended period, for example for more than one month, remove the battery pack from the computer.
- Store spare battery packs in a cool dry place out of direct sunlight.

## Replacing the battery pack

Please be aware that the battery pack is classified as a consumable item.

The operating life of the battery pack will gradually reduce through repeated charging and discharging, and will need to be replaced when it reaches the end of its operating life. In addition to this, you might also replace a discharged battery pack with a charged spare when you are operating your computer away from an AC power source for an extended period of time.

This section explains how to remove and install the battery pack, and begins with the removal process which is detailed through the following steps.



- *Do not remove the battery pack while the computer is in Sleep Mode. Data is stored in RAM, so if the computer loses power it could be lost.*
- *In Hibernation Mode, data will be lost if you remove the battery pack or disconnect the AC adaptor before the save is completed.*
- *Do not touch the battery release latch while holding the computer or the battery pack might fall out due to the unintentional release of the battery release latch and cause injuries.*

## Removing the battery pack

To remove a discharged battery, follow the steps as detailed below:

1. Save your work.
2. Turn the computer's power off - ensure that the **Power** indicator is off.
3. Remove all cables and peripherals that are connected to the computer.
4. Close the display panel and turn the computer upside down.
5. Slide the battery lock into its unlocked (⏏) position.

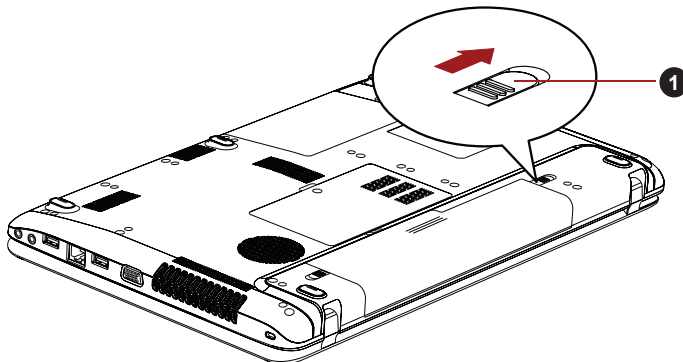

1. Battery lock

Figure 6-1 Releasing the battery pack - 1

6. Slide and hold the battery release latch to disengage the battery pack and then remove it from the computer.

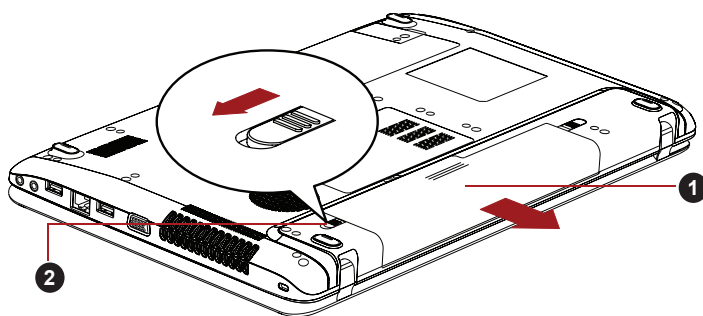

1. Battery pack

2. Battery release latch

Figure 6-2 Releasing the battery pack - 2

## Installing the battery pack

To install a battery pack, follow the steps as detailed below:



*Do not touch the battery release latch while holding the computer or the battery pack might fall out due to the unintentional release of the battery release latch and cause injuries.*

1. Insert the battery pack as far as it will go into the computer.
2. Ensure that the battery pack is securely in place and the battery lock is in its locked position.

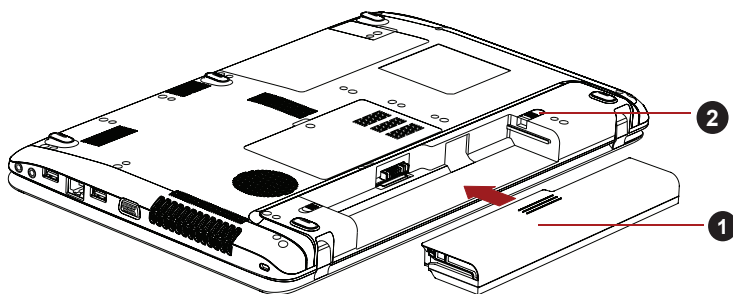

1. Battery pack

2. Battery lock

*Figure 6-3 Securing the battery pack*

3. Turn your computer over.

## Password Utility

The password utility allows you to maintain an additional level of security and provides two levels of password security: User and Supervisor.



*Passwords set in TOSHIBA Supervisor Password Utility are different from the Windows® login password.*

### User Password

To start the utility, point to or click the following items:

**Start -> All Programs -> TOSHIBA -> Utilities -> TOSHIBA Assist -> SECURE -> User password**

#### ■ Registered

Click to register a password of up to 10 characters. After a password is set, you will be prompted to enter it when you start the computer.

#### ■ Not Registered

Click to delete a registered password. Before you can delete a password, you must first enter the current password correctly.

#### ■ Owner String (text box)

You can use this box to associate text with the password. After you enter text, click Apply or OK, then, each time the computer is switched on, this text will be displayed along with the prompt for the password.

## Supervisor password

If you set a supervisor password, some functions will be restricted when a user logs on with the user password. To set a supervisor password:

Click **Start** -> **All Programs** -> **TOSHIBA** -> **Utilities** -> **TOSHIBA Assist** -> **SECURE** -> **Supervisor password**

This utility lets you do the following:

- Register or delete the supervisor password.
- Specify restrictions for general users.

## Starting the computer by password

To start up the computer with the user password, follow these steps:

1. Turn on the power as described in Chapter 1, [Getting Started](#). The following message will appear in the screen:

Enter Current Password



*At this point, the hotkeys **FN + F1** to **F9** do not work. They will function after you enter the password.*

2. Enter the Password.
3. Press **ENTER**.



*If you enter the password incorrectly three times in a row, the computer shuts off. In this case, you must turn the computer back on to retry password entry.*

## Power-up modes

The computer has three different power-up modes as follows:

- **Shut Down Mode:** The computer will shut down without saving data - in view of this you must always save your work before you turn the computer off.
- **Hibernation Mode:** Data in memory will be saved to the hard disk drive.
- **Sleep Mode:** Data will be maintained in the computer's memory.



*Please refer to the sections [Turning on the power](#) and [Turning off the power](#) in Chapter 1, [Getting Started](#) for further information.*

## Windows utilities

You can configure various settings associated with both Sleep Mode and Hibernation Mode within the Power Options (to access it, **Start** -> **Control Panel** -> **System and Security** -> **Power Options**).

## Hot keys

You can use the **FN + F3** hot key to enter Sleep Mode or **FN + F4** to enter Hibernation Mode - please refer to Chapter 5, *The Keyboard* for further details.

## Panel power on/off

You can set up your computer so that power is turned off automatically when you close the display panel, and turned on again when you open it. Please note that this function is only available for Sleep Mode or Hibernation Mode, not for Shut Down Mode.



*If the panel power off function is enabled, and you manually shut down Windows, do not close the display panel until the shut down process has been completed.*

## System automatic Sleep/Hibernation

This feature automatically turns off the system in Sleep or Hibernation Mode if the computer is not used for a set duration. Refer to *Special features*, in Chapter 3 for an explanation of how to set the duration.

## Chapter 7

### HW Setup

This chapter explains how to use the TOSHIBA HW Setup program to configure your computer, and provides information on settings for various functions.

#### Accessing HW Setup

To run the HW Setup program, click **Start -> All Programs -> TOSHIBA -> Utilities -> HWSETUP**.

#### HW Setup window

The HW Setup window contains a number of tabs (General, Password, Display, Boot Setting, Keyboard, LAN, SATA and USB) to allow specific functions of the computer to be configured.

In addition there are also three buttons: **OK**, **Cancel** and **Apply**.

---

<b>OK</b>	Accepts your changes and closes the HW Setup window.
<b>Cancel</b>	Closes the window without accepting your changes.
<b>Apply</b>	Accepts all your changes without closing the HW Setup window.

---

## General

This window displays the BIOS/EC version and contains two buttons: **Default** and **About**.

<b>Default</b>	Return all HW Setup values to the factory settings.
<b>About</b>	Display the HW Setup version.

## Setup

This field displays the installed **BIOS version**, **date** and **EC version**.

## Password

This option allows you to set or reset the user password for power on.

### User Password

Lets you register a new password or change/remove an existing password.

<b>Not Registered</b>	Changes or remove the password (default).
<b>Registered</b>	Selects the password. A dialogue box will appear to allow you to set the password.

To enter a user password:

1. Select **Registered** to display the following prompt:

**Enter Password:**

Enter a password of up to 10 characters. The character string you enter is displayed as a string of asterisk.

2. Click **OK**. The following message appears, allowing you to verify the password.

**Verify Password:**

3. If character strings match, the password is registered. Click **OK**. If they do not match, the following message appears. You must repeat from step 1.

**Entry Error!!!**

To delete a user password:

1. Select **Not Registered** to display the following prompt:

**Enter Password:**

2. Enter the currently registered password. The character string you enter is displayed as a string of asterisks.

3. Click **OK**. If the character string you enter matches the registered password, the password option is reset and the display changes to:

**Not registered**

If they do not match, the following message appears. You must repeat from step 1.

**Incorrect Password.**

### Owner String

This blank field is used to display a message when the password field is displayed on startup. If a password is not registered the message will not be shown. The maximum length is 511 characters.

### Display

This tab lets you customize your computer's display settings for either the internal display or an external monitor.

### Power On Display

This tab allows you to select the display to be used when the computer is started. Please note that this setting is only available on standard VGA mode and is not available as part of the Windows Desktop properties.



*The Power On Display is supported with some models.*

<b>Auto-Selected</b>	Selects an external monitor if one is connected, otherwise, it selects the internal display (default).
<b>System LCD Only</b>	Selects the internal LCD, even if an external monitor is connected.

### Boot Setting

This function allows you to modify the boot settings.

### Boot Setting Options

This tab allows you to set the priority for booting the computer. The Boot Priority Options setting window will be displayed. Click the up and down arrow buttons to adjust the priority.

To change the boot drive, follow the steps below.

1. Hold down **F12** and boot the computer. when the **TOSHIBA Leading Innovation >>>** screen appears, release the **F12** key.
2. Use the up and down cursor keys to select the boot device you want and press **ENTER**.



*If a Supervisor Password has been set, manual boot device selection functions may be restricted.*

*The boot device selection methods described above will not change the boot priority settings that have been configured in HW Setup. In addition, if you press a key other than one of those listed, or if the selected device is not installed, the system will continue to boot according to the current and available settings in HW Setup.*



## Boot Speed

This feature allows you to select system boot-up speed.

<b>Fast</b>	Reduces system boot-up time. System can boot only from the built-in HDD and only internal LCD and keyboard are supported during the boot process.
<b>Normal</b>	System boots up at normal speed. (Default)

## Panel Open - Power On

This feature allows you to change the **Panel Open - Power On** setting.

<b>Enabled</b>	Enables the <b>Panel Open - Power On</b> function. When you open the display panel while your computer is turned off, the system will boot up automatically.
<b>Disabled</b>	Disables the <b>Panel Open - Power On</b> function. (Default)

## Keyboard

### Wake-up on Keyboard

When this feature is enabled, and the computer is in Sleep Mode, you can turn on the system by pressing any key. However, please be aware that this option will only work with the internal keyboard and only when the computer is in Sleep Mode.

<b>Enabled</b>	Enables the Wake-up on Keyboard function.
<b>Disabled</b>	Disables the Wake-up on Keyboard function (Default).

## LAN

### Wake-up on LAN

This feature lets the computer's power be turned on from shutdown when it receives a wake-up packet (Magic packet) from the LAN.



*Do not install or remove a memory module while Wake-up on LAN is enabled.*



- *The Wake-up on LAN function consumes power even when the system is off. Leave the AC adaptor connected while using this feature.*
- *Regarding Wake-up on LAN from sleep or hibernation, you must check the "Allow the device to wake the computer" check box within the LAN Device properties. (This feature does not effect the Wake-up on LAN from sleep or hibernation.)*

Power will be automatically turned on when a signal is received from an administrator's computer which is connected via a network.

The following settings can be changed when the Built-in LAN is **Enabled**. Connect the AC adaptor when using the Wake-up on LAN function. The battery retention time will be shorter than the times listed in this manual when this function is enabled. Refer to the section *Battery exhausted time* in chapter 6.

<b>Enabled</b>	Enables Wake-up on LAN from shutdown.
<b>Disabled</b>	Disables Wake-up on LAN from shutdown (Default).

### ***Built-in LAN***

This feature enables or disables the Built-in LAN.

<b>Enabled</b>	Enables Built-in LAN functions (Default).
<b>Disabled</b>	Disables Built-in LAN functions.

### ***USB***

#### ***Legacy USB Support***

Use this option to enable or disable USB Legacy Emulation. If your operating system does not support USB, you can still use a USB mouse and keyboard by setting the Legacy USB Support item to enabled.

<b>Enabled</b>	Enables the USB Legacy Emulation (Default).
<b>Disabled</b>	Disables the USB Legacy Emulation.

### ***SATA***

#### ***SATA Interface setting***

This feature allows you to set SATA interface setting.

<b>Performance</b>	Let HDD/SSD work with maximum performance (Default).
<b>Battery life</b>	Let HDD/SSD work with battery life mode. If this setting is selected, this caused performance down.

## Chapter 8

### Troubleshooting

TOSHIBA have designed this computer for durability, however, should problems occur you are able to use the procedures detailed in this chapter to help determine the cause.

All users should become familiar with this chapter as knowing what might go wrong can help prevent problems from occurring in the first place.

#### Problem solving process

Resolving problems will be much easier if you observe the following guidelines:

- Stop immediately when you recognize a problem exists as taking further action may result in data loss or damage, or you may destroy valuable problem related information that can help solve the problem.
- Observe what is happening - write down what the system is doing and what actions you performed immediately before the problem occurred. Make a screenshot of the current display.

Please also be aware that the questions and procedures described in this chapter are meant only as a guide, they are not definitive problem solving techniques. In reality many problems can be solved simply, but a few may require help from your reseller, dealer or service provider - if you find you need to consult others, be prepared to describe the problem in as much detail as possible.

#### Preliminary checklist

You should always consider the simplest solution first - the items detailed in this checklist are easy to fix and yet can cause what appears to be a serious problem:

- Make sure you turn on all peripheral devices before you turn on the computer - this includes your printer and any other external device you are using.

- Before you attach an external device you should first turn the computer off, then when you turn the computer back on again it will recognize the new device.
- Make sure all optional accessories are configured properly in the computer's setup program and that all required driver software has been loaded (please refer to the documentation included with the optional accessories for further information on its installation and configuration).
- Check all cables to ensure they are correctly and firmly attached to the computer - loose cables can cause signal errors.
- Inspect all connecting cables for loose wires and all connectors for loose pins.
- Check that your CD/DVD media is correctly loaded and, in the case of a floppy diskette, that its write protect tab is correctly set.

Always try to make detailed notes of your observations and keep them in a permanent error log - this will help you to describe your problems to your reseller, dealer or service provider. In addition, if a problem recurs, the log you have made will help to identify the problem faster.

## Analyzing the problem

Sometimes the computer will give you clues that can help you identify why it is malfunctioning. In view of this you should keep the following questions in mind:

- Which part of the computer is not operating properly - keyboard, hard disk drive, display panel, touch pad, touch pad control buttons - as each device will produce different symptoms.
- Check the options within the operating system to ensure that its configuration is set properly.
- What appears on the display? Does it display any messages or random characters? Make a screenshot of the current display and, if possible, look up the messages in the documentation included with the computer, software or operating system.
- Check that all connecting cables are correctly and firmly attached as loose cables can cause erroneous or intermittent signals.
- Do any indicators light, if so, which ones, what color are they and do they stay on or blink? Write down what you see.
- Do you hear any beeps, if so how many, are they long or short and are they high pitched or low pitched? In addition, is the computer making any unusual noises? Write down what you hear.

Record your observations so you can describe them in detail to your reseller, dealer or service provider.

<b>Software</b>	<p>The problems may be caused by your software or disk. If you cannot load a software package, the media may be damaged or the program might be corrupted - in these instances try loading another copy of the software if possible.</p> <p>If an error message appears while you are using a software package you should refer to the documentation supplied with it as this will usually include a problem solving section or a summary of error messages.</p> <p>Next, you should check any error messages against the operating system documentation.</p>
<b>Hardware</b>	<p>If you cannot find a software problem, you should then check the setup and configuration of your hardware. First run through the items in the preliminary checklist as described previously then, if you still cannot correct the problem, try to identify the source - the next section provides checklists for individual components and peripherals.</p>



*Before using a peripheral device or application software that is not an authorized TOSHIBA part or product, make sure the device or software can be used with your computer. Use of incompatible devices may cause injury or may damage your computer.*

## Hardware and system checklist

This section discusses problems caused by your computer's hardware or attached peripherals. Basic problems may occur in the following areas:

- System start-up
- Self test
- Power
- Keyboard
- Internal display panel
- Hard disk drive
- DVD Super Multi drive
- Memory Cards: SD/SDXC Card, MultiMediaCard
- Pointing device
- USB device
- Additional memory module
- Sound system
- External monitor
- LAN
- Wireless LAN
- Bluetooth
- Recovery Media

### System start-up

When the computer does not start properly, check the following items:

- Self Test
- Power Sources

## Self test

While booting up the computer, self test is executed automatically and the **TOSHIBA** logo is displayed on the screen.

This message remains on the screen for a few seconds.

If the self test is successful, the computer tries to load the operating system according to how the **Boot Priority Options** is set within the TOSHIBA HW Setup program.

If any of the following conditions are present, the self test has failed:

- The computer stops and does not proceed to display information or messages except for the TOSHIBA logo.
- Random characters appear on the screen and the system does not function normally.
- The screen displays an error message.

In these instances, turn off the computer, check all cable connections and then restart it - if the self test fails again, contact your reseller, dealer or service provider.

## Power

When the computer is not plugged into an AC power outlet, the battery pack is the primary power source. However, your computer also has a number of other power resources, including an intelligent power supply and a Real Time Clock (RTC) battery, all of which are interrelated with any one having the ability to produce apparent power problems.

This section provides checklists for AC power and the battery. If you cannot resolve a problem after following them, the cause may lie with another power related resource - in such an instance you should contact your reseller, dealer or service provider.

### ***Overheating power down***

If the processor's temperature reaches an unacceptably high level with either setting, the computer will automatically shut down to prevent any damage - in this instance all unsaved data in memory will be lost.

## AC power

If you have trouble turning on the computer with the AC adaptor connected you should check the status of the **DC IN/Battery** indicator. Please refer to Chapter 6, *Power and Power-Up Modes* for further information.

Problem	Procedure
AC adaptor doesn't power the computer	<p>Check the connections to make sure that the power cord/adaptor is firmly connected to the computer and a working power outlet.</p> <hr/> <p>Check the condition of the cord and terminals. If the cord is frayed or damaged it should be replaced, while if the terminals are soiled, they should be cleaned with a clean cotton cloth.</p> <hr/> <p>If the AC adaptor still does not power the computer, you should contact your reseller, dealer or service provider.</p>

## Battery

If you suspect a problem with the battery, you should check the status of the **DC IN/Battery** indicator. Please refer to Chapter 6, *Power and Power-Up Modes* for more information on these indicators, together with general battery operation.

Problem	Procedure
Battery doesn't power the computer	The battery may be discharged - connect the AC adaptor to recharge the battery.
Battery doesn't charge when the AC adaptor is attached.	<p>If the battery is completely discharged, it will not begin charging immediately, in these instances you should wait a few minutes before trying again. If the battery still does not charge, you should check that the power outlet the AC adaptor is connected to is supplying power - this can be tested by plugging another appliance into it.</p> <hr/> <p>Check whether the battery is hot or cold to the touch - if so, it will not charge properly and should be allowed to reach room temperature before you try again.</p>

Problem	Procedure
	<p>Unplug the AC adaptor and remove the battery to make sure its connecting terminals are clean - if necessary wipe them with a soft dry cloth lightly dipped in alcohol.</p> <p>Connect the AC adaptor and replace the battery, taking care to ensure that it is securely seated in the computer.</p> <p>Check the <b>DC IN/Battery</b> indicator - if it does not glow, allow the computer to charge the battery for at least twenty minutes. If the <b>DC IN/Battery</b> indicator starts to glow after this period, allow the battery to continue to charge for at least another twenty minutes before turning on the computer. However, if the indicator still does not glow, the battery may be at the end of its operating life and should be replaced. However, if you do not believe the battery is at the end of its operating life, you should speak to your reseller, dealer or service provider.</p>
<p>Battery doesn't power the computer as long as expected</p>	<p>If you frequently recharge a partially charged battery, the battery might not charge to its full potential - in these instances you should fully discharge the battery and then attempt to charge it again.</p> <p>Check the <b>Power saver</b> option under <b>Select a power plan</b> in the <b>Power Options</b>.</p>



## Real Time Clock

Problem	Procedure
The BIOS setting and system date/time are lost.	<p>The charge in the Real Time Clock (RTC) battery has run out - you will need to set the date and time in the BIOS setup application by using the following steps:</p> <ol style="list-style-type: none"><li>1. Turn on the computer while pressing the <b>F2</b> key.</li><li>1. Release the <b>F2</b> key when the <b>TOSHIBA Leading Innovation &gt;&gt;&gt;</b> screen appears - the BIOS setup application will load.</li><li>2. Set the date in the <b>System Date</b> field.</li><li>3. Set the time in the <b>System Time</b> field.</li><li>4. Press <b>F10</b> - a confirmation message will be displayed.</li><li>5. Press <b>ENTER</b> - the BIOS setup application will end and the computer will restart.</li></ol>

## Keyboard

Keyboard problems can be caused by the setup and configuration of the computer - please refer to Chapter 5, *The Keyboard* for further information.

Problem	Procedure
Output to screen is garbled	<p>Please refer to your software's documentation to ensure that its is not remapping the keyboard in any way (remapping involves changing or reassigning the function of each key).</p> <p>If you are still unable to use the keyboard, you should contact your reseller, dealer or service provider.</p>

## Internal display panel

Apparent computer's display panel problems may be related to the computer's setup and configuration - please refer to Chapter 7, *HW Setup*, for further information.

Problem	Procedure
No display	Press the <b>FN + F5</b> hot keys to adjust the display priority, and to make sure it is not set for output to an external monitor.
Markings appear on the computer's display panel.	These marks may have come from contact with the keyboard and Touch Pad while the display panel has been closed. You should try to remove the marks by gently wiping the display panel with a clean dry cloth or, if this fails, with a good quality LCD screen cleaner. In this latter instance you should always follow the instructions with the screen cleaner and always ensure you let the display panel dry properly before closing it.
Problems above remain unresolved or other problems occur	You should initially refer to the documentation supplied with you software to determine if it is this that is causing the problems. Alternatively you may wish to run the TOSHIBA PC Diagnostic Tool to check the general operation of the computer.  If you are still unable to resolve the problem, contact your reseller, dealer or service provider.

## Hard disk drive

Problem	Procedure
Computer does not boot from hard disk drive	<p>Check to see whether that is a CD-ROM/DVD-ROM in the optical disc drive - if so remove it and try to start the computer again.</p> <p>If this has no effect, check the <b>Boot Priority Options</b> setting within the TOSHIBA HW Setup utility - please refer to the <i>Boot Setting</i> section in Chapter 7, HW Setup for further information.</p> <hr/> <p>Please refer to your operating system documentation in order to determine whether there is a problem with any of the operating system files or settings.</p>

Problem	Procedure
Slow performance	<p>The files on the hard disk drive may be fragmented - in this instance you should run the disk Defragmentation utility to check the condition of your files and the hard disk drive. Please refer to the operating system's documentation or online Help File for further information on operating and using the Defragmentation utility.</p> <hr/> <p>As a last resort you should reformat the hard disk drive and then reload the operating system and all other files and data. If you are still unable to resolve the problem, contact your reseller, dealer or service provider.</p>

### DVD Super Multi drive

For more information, refer to Chapter 4, *Operating Basics*.

Problem	Procedure
You cannot access a CD/DVD in the drive	<p>Make sure the drive's disc tray is securely closed. Press gently until it clicks into place.</p> <hr/> <p>Open the disc tray and make sure the CD/DVD is properly seated. It should lie flat with the label facing up.</p> <hr/> <p>A foreign object in the disc tray could block laser light from reading the CD/DVD. Make sure there is no obstruction. Remove any foreign object.</p> <hr/> <p>Check whether the CD/DVD is dirty. If it is, wipe it with a clean cloth dipped in water or a neutral cleaner. Refer to the <i>Media care</i> section in Chapter 4 for details on cleaning.</p>
Some CD/DVDs run correctly, but others do not	<p>The software or hardware configuration may be causing a problem. Make sure the hardware configuration matches your software's needs. Check the CD/DVD's documentation.</p>

Check the type of CD/DVD you are using. The drive supports:

DVD-ROM: DVD-ROM, DVD-Video

CD-ROM: CD-DA, CD-Text, Photo CD (single/multi-session), CD-ROM Mode 1, Mode 2, CD-ROM XA Mode 2 (Form1, Form2), Enhanced CD (CD-EXTRA), Addressing Method 2

Recordable DVD: DVD-R/-R DL, DVD+R/+R DL, DVD-RW, DVD+RW, DVD-RAM

Check the region code on the DVD. It must match that on the DVD Super Multi drive. Region codes are listed in the [Keyboard indicators](#) section in Chapter 2, The Grand Tour.

### Memory Cards: SD/SDXC Card, MultiMediaCard

For further information, please refer to Chapter 3, [Hardware, Utilities and Options](#).

Problem	Procedure
Memory Card error occurs	Remove the Memory Card from the computer and then reinsert it in order to ensure it is firmly connected.  If the problem persists, then you should refer to the documentation supplied with your Memory Card for further information.
You cannot write to an Memory Card	Remove the Memory Card from the computer and check to ensure that it is not write protected.
You cannot read a file	Check to ensure the required file is actually on the Memory Card that is inserted into the computer.  If you are still unable to resolve the problem, contact your reseller, dealer or service provider.

## Pointing device

If you are using a USB mouse, you should also refer to both the [USB device](#) section in this chapter, and the documentation supplied with your mouse.

### Touch Pad

Problem	Procedure
The Touch Pad does not work.	<p>Check the Device Select settings.</p> <p>Click <b>Start -&gt; Control Panel -&gt; Hardware and Sound -&gt; Mouse</b>.</p> <p>Pressing <b>FN + F9</b> to enable.</p>
On-screen pointer does not respond to pointing device operation	<p>In this instance the system might be busy - Try moving the mouse again after waiting a short while.</p>
Double-tapping does not work	<p>In this instance, you should initially try changing the double-click speed setting within the Mouse Control utility.</p> <ol style="list-style-type: none"> <li>1. To access this utility, click <b>Start -&gt; Control Panel -&gt; Hardware and Sound -&gt; Mouse</b>.</li> <li>2. Within the Mouse Properties window, click the <b>Buttons</b> tab.</li> <li>3. Set the double-click speed as required and click <b>OK</b>.</li> </ol>
The on-screen pointer moves too fast or too slow	<p>In this instance, you should initially try changing the speed setting within the Mouse Control utility.</p> <ol style="list-style-type: none"> <li>1. To access this utility, click <b>Start -&gt; Control Panel -&gt; Hardware and Sound -&gt; Mouse</b>.</li> <li>2. Within the Mouse Properties window, click the <b>Pointer Options</b> tab.</li> <li>3. Set the pointer speed as required and click <b>OK</b>.</li> </ol>

Problem	Procedure
The reaction of Touch pad is either too sensitive or not sensitive enough.	<p>Adjust the touch Sensitivity.</p> <ol style="list-style-type: none"> <li>1. Click <b>Start</b> -&gt; <b>Control Panel</b> -&gt; <b>Hardware and Sound</b> -&gt; <b>Mouse</b>.</li> <li>2. Click the <b>Device Settings</b> tab.</li> <li>3. Click the <b>Settings...</b> button.</li> <li>4. Double click <b>Pointing</b> in the Select an item section on the left side of the displayed screen.</li> <li>5. Click <b>Sensitivity</b> and then click <b>Touch Sensitivity</b>.</li> <li>6. Move the slider bar to adjust the sensitivity in the Touch Sensitivity.</li> <li>7. Click <b>OK</b> button.</li> <li>8. Click the <b>OK</b> button on the <b>Device Settings</b> tab.</li> </ol> <p>If you are still unable to resolve the problem, contact your reseller, dealer or service provider.</p>

### **USB mouse**

Problem	Procedure
On-screen pointer does not respond to mouse operation	<p>In this instance the system might be busy - Try moving the mouse again after waiting a short while.</p> <hr/> <p>Remove the mouse from the computer and then reconnect it to a free USB port it in order to ensure it is firmly attached.</p>
Double-clicking does not work	<p>In this instance, you should initially try changing the double-click speed setting within the Mouse Control utility.</p> <ol style="list-style-type: none"> <li>1. To access this utility, click <b>Start</b> -&gt; <b>Control Panel</b> -&gt; <b>Hardware and Sound</b> -&gt; <b>Mouse</b>.</li> <li>2. Within the Mouse Properties window, click the <b>Buttons</b> tab.</li> <li>3. Set the double-click speed as required and click <b>OK</b>.</li> </ol>

Problem	Procedure
The on-screen pointer moves too fast or too slow	<p>In this instance, you should initially try changing the speed setting within the Mouse Control utility.</p> <ol style="list-style-type: none"> <li>1. To access this utility, click <b>Start -&gt; Control Panel -&gt; Hardware and Sound -&gt; Mouse</b>.</li> <li>2. Within the Mouse Properties window, click the <b>Pointer Options</b> tab.</li> <li>3. Set the pointer speed as required and click <b>OK</b>.</li> </ol>
The on-screen pointer moves erratically	<p>The elements of the mouse responsible for detecting movement might be dirty - please refer to the documentation supplied with the mouse for instructions on how to clean it.</p> <p>If you are still unable to resolve the problem, contact your reseller, dealer or service provider.</p>

## USB device

In addition to the information in this section, please also refer to the documentation supplied with your USB device.

Problem	Procedure
USB device does not work	<p>Remove the USB device from the computer and then reconnect it to a free port it in order to ensure it is firmly attached.</p> <hr/> <p>Ensure that any required USB device drivers are properly installed - to achieve this you should refer to both the device documentation and the operating system documentation.</p> <hr/> <p>If you are using an operating system that does not support USB, you are still able to use a USB mouse and/or USB keyboard by setting the <b>Legacy USB Support</b> option within the TOSHIBA HWSetup utility to Enabled.</p> <p>If you are still unable to resolve the problem, contact your reseller, dealer or service provider.</p>

## Additional memory module

Please also refer to Chapter 3, *Hardware, Utilities and Options*, for further information on installing and removing memory modules.

Problem	Procedure
An error will occur if a memory module is inserted into Slot B while no memory module is inserted in Slot A.	Remove the memory module from Slot B and insert it into Slot A.

## Sound system

In addition to the information in this section, please also refer to the documentation supplied with your audio device.

Problem	Procedure
No sound is heard	<p>Adjust the volume.</p> <p>Press <b>FN +4</b> to increase the volume, and press <b>FN + 3</b> to decrease the volume.</p> <hr/> <p>Check the software volume settings.</p> <hr/> <p>Please check to see if Mute is turned to Off</p> <hr/> <p>Check to make sure the headphone connection is secure.</p> <hr/> <p>Check within the Windows Device Manager application to ensure the sound device is enabled and that the device is properly working.</p> <p>For further information, please refer to "Troubleshooting in Windows" section of Windows Help and Support.</p>
Annoying sound is heard	<p>In this instance you may be experiencing feedback from either the internal microphone or an external microphone connected to the computer - please refer to <i>Sound System</i> in Chapter 4, Operating Basics for further information.</p> <p>Volume cannot be adjusted during Windows start up or shut down.</p> <p>If you are still unable to resolve the problem, contact your reseller, dealer or service provider.</p>



## External monitor

Please also refer to Chapter 3, *Hardware, Utilities and Options*, and to the documentation supplied with your monitor for further information.

Problem	Procedure
Monitor does not turn on	<p>After confirming that the monitor's power switch is on, you should check the connections to make sure that the power cord/adaptor is firmly connected to the monitor and to a working power outlet.</p>
No display	<p>Try adjusting the contrast and brightness controls on the external monitor.</p> <p>Press the <b>FN + F5</b> hot key in order to change the display priority and ensure that it is not set for the internal display only.</p> <p>Check to see if the external monitor is connected. When the external monitor is set as the primary display device in extended desktop mode, it will not display when the computer wakes up from Sleep Mode if the external monitor has been disconnected while in Sleep Mode. To keep this from happening, do not disconnect the external monitor while the computer is in Sleep or Hibernation Mode. Remember to turn off the computer before disconnecting the external monitor.</p> <p>When the display panel and an external monitor are set to clone mode and they are turned off by the timer, the display panel or the external monitor may not display when turned on again. If this occurs, press <b>FN + F5</b> to re-set the display panel and external monitor to clone mode.</p>
Display error occurs	<p>Check that the cable connecting the external monitor to the computer is firmly attached. If you are still unable to resolve the problem, contact your reseller, dealer or service provider.</p>

## LAN

Problem	Procedure
Cannot access LAN	Check for a firm cable connection between the LAN jack and the LAN hub.
Wake-up on LAN does not work	Make sure the AC adaptor is connected. The Wake-up on LAN function consumes power even when the system is off. If problems persist, consult your LAN administrator.

## Wireless LAN

If the following procedures do not restore LAN access, consult your LAN administrator. For more information on wireless communication, refer to Chapter 4, *Operating Basics*.

Problem	Procedure
Cannot access Wireless LAN	Make sure the computer's Wireless communication function is on. If problems persist, contact your LAN administrator.

## Bluetooth

For further information on Bluetooth wireless communication, please refer to Chapter 4, *Operating Basics*.

Problem	Procedure
Cannot access Bluetooth device	Check to ensure the computer's Wireless Communication function is on.
	Check to ensure the Bluetooth Manager application is running on the computer and that power to the external Bluetooth device is turned on.
	Check to ensure that no optional Bluetooth Adaptor is installed in the computer - the built-in Bluetooth hardware cannot operate simultaneously with another Bluetooth controller. If you are still unable to resolve the problem, contact your reseller, dealer or service provider.

## Recovery Media

Problem	Procedure
<p>The following message appears when executing Recovery Media Creator.</p> <p><b>"The Recovery Media Creator can not be launched because there is no recovery partition."</b></p>	<p>You will see this message if you have previously chosen to remove the partition and are trying to create "Recovery Media".</p> <p>When there is no recovery partition, the Recovery Media Creator cannot make Recovery Media.</p> <p>However, if you have already created a "Recovery Media", you can use it to restore the recovery partition.</p> <p>Simply follow the instructions in <i>Restoring the pre-installed software from your created Recovery Media</i> section in Chapter1, Getting Started.</p> <p>You will be directed to select "Restore Original Factory Image" from the drop-down menu.</p> <p>If you have not created "Recovery Media", please contact TOSHIBA support for assistance.</p>

## TOSHIBA support

If you require any additional help using your computer or if you are having problems operating the computer, you may need to contact TOSHIBA for additional technical assistance.

### Before you call

Some problems you experience may be related to software or the operating system so it is important that you investigate other sources of assistance first. Before contacting TOSHIBA, try the following:

- Review troubleshooting sections in the documentation supplied with your software and/or peripheral devices.
- If a problem occurs when you are running software applications, consult the software documentation for troubleshooting suggestions and consider calling the software company's technical support department for assistance.
- Consult the reseller or dealer from where you purchased your computer and/or software - they are your best resource for current information and support.

## Where to write

If you are still unable to solve the problem and suspect that it is hardware related, write to TOSHIBA at the nearest location listed below:

Outside of Europe	In Europe
<p><b>Australia</b></p> <p>TOSHIBA Australia Pty. Ltd. Information Systems Division Building C, 12-24 Talavera Rd, North Ryde, 2113, NSW, Australia.</p>	<p><b>Germany &amp; Austria</b></p> <p>TOSHIBA Europe (I.E.) GmbH Geschäftsbereich, Deutschland-Österreich Hammfelddamm 8, D-41460 Neuss, Germany</p>
<p><b>Canada</b></p> <p>TOSHIBA of Canada Ltd. 191 McNabb Street, Markham, Ontario L3R 8H2</p>	<p><b>France</b></p> <p>TOSHIBA Systèmes France S.A. 7, Rue Ampère B.P. 131, 92804 Puteaux Cedex</p>
<p><b>China</b></p> <p>TOSHIBA Personal Computer &amp; Network (Shanghai) Co., Ltd. 10F, BEA Finance Tower, No.66 Hua Yuan Shi Qiao Road, Pudong, Shanghai, P.R.China 200120</p>	<p><b>Netherlands</b></p> <p>TOSHIBA Information Systems, Benelux B.V. Rivium Boulevard 41 2909 LK Capelle a/d IJssel</p>
<p><b>Singapore</b></p> <p>TOSHIBA Singapore Pte. Ltd. 438B Alexandra Road #06-01 Alexandra Technopark Singapore 119968</p>	<p><b>Spain</b></p> <p>TOSHIBA Information Systems, ESPAÑA Parque Empresarial San Fernando Edificio Europa, 1a Planta, Escalera A 28830 Madrid España</p>
<p><b>United States of America</b></p> <p>TOSHIBA America Information Systems, Inc. 9740 Irvine Boulevard Irvine, California 92618 USA</p>	<p><b>United Kingdom</b></p> <p>TOSHIBA Information Systems (U.K.) Ltd. TOSHIBA Court Weybridge Business Park Addlestone Road Weybridge, Surrey KT15 2UL</p>
<p><b>India</b></p> <p>TOSHIBA India Pvt Ltd. PC Division 6th Floor, DR Gopal Das Bhawan Barakhamba Road, Delhi- 110001, India</p>	<p><b>The Rest of Europe</b></p> <p>TOSHIBA Europe (I.E.) GmbH Geschäftsbereich, Deutschland- Österreich Hammfelddamm 8, D- 41460 Neuss, Germany</p>

## Appendix A

### Specifications

This appendix summarizes the computer's technical specifications.

#### Physical Dimensions

<b>Size</b>	380(w) x 250 (d) x 28/37.9 (h) millimeters (not including parts that extend beyond the main body).
-------------	---

#### Environmental Requirements

<b>Conditions</b>	<b>Ambient temperature</b>	<b>Relative humidity</b>
<b>Operating</b>	5°C (41°F) to 35°C (95°F)	20% to 80% (noncondensing)
<b>Non-operating</b>	-20°C (-4°F) to 65°C (149°F)	10% to 90% (noncondensing)
<b>Wet-bulb temperature</b>	26°C maximum	
<b>Conditions</b>	<b>Altitude (from sea level)</b>	
<b>Operating</b>	0 to 3,000 meters	
<b>Non-operating</b>	0 to 10,000 meters maximum	

## Power Requirements

<b>AC adaptor</b>	100-240 volts AC 50 or 60 hertz (cycles per second)
<b>Computer</b>	19V DC

## External RGB monitor port pin assignment

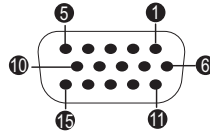

Pin	Signal Name	Description	I/O
1	CRV	Red Video Signal	O
2	CGV	Green Video Signal	O
3	CBV	Blue Video Signal	O
4	Reserved	Reserved	
5	GND	Ground	
6	GND	Ground	
7	GND	Ground	
8	GND	Ground	
9	+5V	Power Supply	
10	GND	Ground	
11	Reserved	Reserved	
12	SDA	Data Signal	I/O
13	HSYNC	Horizontal Sync Signal	O
14	VSYNC	Vertical Sync Signal	O
15	SCL	Data Clock Signal	O

I/O (I): Input to computer

I/O (O): Output from computer

## Appendix B

### Display Controller and Video mode

#### Display controller

The display controller interprets software commands into hardware commands that turn particular parts on the screen on or off.



*Due to the display panel's increased resolution, lines may appear broken in when displaying images in full-screen text mode.*

The display controller also controls the video mode and uses industry standard rules to govern the screen resolution and the maximum number of colors that can be displayed at any one time. Therefore, software written for a given video mode will run on any computer that supports that mode.

#### Video mode

Video mode settings are configured via the **Screen Resolution** dialog.

To open the **Screen Resolution** dialog, click **Start -> Control Panel -> Appearance and Personalization -> Display -> Change display settings**.



*If you are running some applications (for example a 3D application or video playback and so on), you may see some disturbance, flickering or frame dropping on your screen.*

*If that occurs, adjust the resolution of display, lowering it until the screen is displayed properly.*

*Disabling Windows Aero™ may also help correct this issue.*

## Appendix C

### Information for Wireless Devices

#### Wireless LAN Interoperability

The Wireless LAN is compatible with other LAN systems Direct Sequence Spread Spectrum (DSSS) /Orthogonal Frequency Division Multiplexing (OFDM) radio technology, and is compliant to:

- The IEEE 802.11 Standard on Wireless LANs (Revision a/b/g/n, b/g/n), as defined and approved by the Institute of Electrical and Electronics Engineers.
- The Wireless Fidelity (**Wi-Fi**<sup>®</sup>) certification as defined by the **Wi-Fi Alliance**<sup>®</sup>.  
The "**Wi-Fi CERTIFIED**<sup>™</sup>" logo is a certification mark of the **Wi-Fi Alliance**<sup>®</sup>.

#### Bluetooth wireless technology Interoperability

Bluetooth<sup>™</sup> Cards from TOSHIBA are designed to be interoperable with any product with Bluetooth wireless technology that is based on Frequency Hopping Spread Spectrum (FHSS) radio technology, and is compliant to:

- Bluetooth Specification Ver. 3.0+HS or Ver. 3.0, as defined and approved by The Bluetooth Special Interest Group.
- Logo certification with Bluetooth wireless technology as defined by The Bluetooth Special interest Group.



## CAUTION about Wireless Devices



*The wireless devices have not completed verification of connection and operation with all devices which are using the Wireless LAN or Bluetooth radio technology.*

*Bluetooth and Wireless LAN devices operate within the same radio frequency range and may interfere with one another. If you use Bluetooth and Wireless LAN devices simultaneously, you may occasionally experience a less than optimal network performance or even lose your network connection.*

*If you should experience any such problem, immediately turn off either one of your Bluetooth or Wireless LAN.*

*Please visit <http://www.pc.support.global.toshiba.com>, if you have any questions about using Wireless LAN or Bluetooth Card from TOSHIBA.*

*In Europe visit*

*<http://www.toshiba-europe.com/computers/tnt/bluetooth.htm>*

*Your Bluetooth product is not compatible with devices using Bluetooth Version 1.0B specifications.*

## Wireless Devices and your health

Wireless products, like other radio devices, emit radio frequency electromagnetic energy. The level of energy emitted by Wireless products however is far much less than the electromagnetic energy emitted by wireless devices like for example mobile phones.

Because Wireless products operate within the guidelines found in radio frequency safety standards and recommendations, TOSHIBA believes Wireless products is safe for use by consumers. These standards and recommendations reflect the consensus of the scientific community and result from deliberations of panels and committees of scientists who continually review and interpret the extensive research literature.

In some situations or environments, the use of Wireless products may be restricted by the proprietor of the building or responsible representatives of the organization. These situations may for example include:

- Using the Wireless products equipment on board of airplanes, or
- In any other environment where the risk of interference to other devices or services is perceived or identified as harmful.

If you are uncertain of the policy that applies on the use of wireless devices in a specific organization or environment (e.g. airports), you are encouraged to ask for authorization to use the Wireless device prior to turning on the equipment.

## Radio Regulatory Information

The Wireless device is must be installed and used in strict accordance with the manufacturer's instructions as described in the user documentation that comes with the product. This product complies with the following radio frequency and safety standards.

### Europe

#### *Restrictions for Use of 2400.0-2483.5MHz Frequencies in Europe*

<b>France:</b>	Outdoor use limited to 10mW e.i.r.p. within the band 2454-2483.5MHz	Military Radio location use.Refarming of the 2.4GHz band has been ongoing in recent years to allow current relaxed regulation Full implementation planned 2012.
<b>Italy:</b>	-	For private use, a general authorization is required if WAS/RLAN's are used outside own premises. For public use, a general authorization is required.
<b>Luxembourg:</b>	Implemented	General authorization required for network and service supply.
<b>Norway:</b>	Implemented	This subsection does not apply for the geographical area within a radius of 20 km from the centre of Ny-Alesund.
<b>Russian Federation:</b>	-	Only for indoor applications.

#### *Restrictions for Use of 5150-5350MHz Frequencies in Europe*

<b>Italy:</b>	-	For private use, a general authorization is required if WAS/RLAN's are used outside own premises.
---------------	---	---

<b>Luxembourg:</b>	Implemented	General authorization required for network and service supply.
<b>Russian Federation:</b>	Limited	e.i.r.p 100mW. Permitted to use only for indoor applications, closed industrial and warehouse areas, and on board aircraft. <ol style="list-style-type: none"> <li>1. Permitted to use for local networks of aircraft crew service communications on board aircraft in area of the airport and at all stages of flight.</li> <li>2. Permitted to use for public wireless access local networks on board aircraft during a flight at the altitude not less than 3000m.</li> </ol>

### *Restrictions for Use of 5470-5725MHz Frequencies in Europe*

<b>Italy:</b>	-	For private use, a general authorization is required if WAS/RLAN's are used outside own premises.
<b>Luxembourg:</b>	Implemented	General authorization required for network and service supply
<b>Russian Federation:</b>	Limited	e.i.r.p 100mW. Permitted to use only for indoor applications, closed industrial and warehouse areas, and on board aircraft. <ol style="list-style-type: none"> <li>1. Permitted to use for local networks of aircraft crew service communications on board aircraft in area of the airport and at all stages of flight.</li> <li>2. Permitted to use for public wireless access local networks on board aircraft during a flight at the altitude not less than 3000m.</li> </ol>

To remain in conformance with European spectrum usage laws for Wireless LAN operation, the above 2.4GHz and 5GHz channel limitations apply for outdoor usage. The user should use the wireless LAN utility to check the current channel of operation. If operation is occurring outside of the allowable frequencies for outdoor use, as listed above, the user must contact the applicable national spectrum regulator to request a license for outdoor operation.

## Canada - Industry Canada (IC)

This device complies with RSS 210 of Industry Canada.

Operation is subject to the following two conditions: (1) this device may not cause interference, and (2) this device must accept any interference, including interference that may cause undesired operation of this device.

The term "IC" before the equipment certification number only signifies that the Industry Canada technical specifications were met.

## USA-Federal Communications Commission (FCC)

This equipment has been tested and found to comply with the limits for a Class B digital device, pursuant to Part 15 of FCC Rules. These limits are designed to provide reasonable protection against harmful interference in a residential installation.

Refer to the FCC information section for the detailed information.

## Caution: Exposure to Radio Frequency Radiation

The radiated output power of the Wireless device is far below the FCC radio frequency exposure limits. Nevertheless, the Wireless device shall be used in such a manner that the potential for human contact during normal operation is minimized.

In the usual operating configuration, the distance between the antenna and the user should not be less than 20cm. Please refer to the computer user's manual for the details regarding antenna location.

The installer of this radio equipment must ensure that the antenna is located or pointed such that it does not emit RF field in excess of Health Canada limits for the general population; consult Safety Code 6, obtainable from Health Canada's website [www.hc-sc.gc.ca](http://www.hc-sc.gc.ca).

## Caution: Radio Frequency Interference Requirements

This device is restricted to indoor use due to its operation in the 5.15 to 5.25GHz frequency range.

### *Taiwan*

Article 12 Without permission granted by the DGT or NCC, any company, enterprise, or user is not allowed to change frequency, enhance transmitting power or alter original characteristic as well as performance to an approved low power radio-frequency devices.

Article 14 The low power radio-frequency devices shall not influence aircraft security and interfere legal communications; If found, the user shall cease operating immediately until no interference is achieved.

The said legal communications means radio communications is operated in compliance with the Telecommunications Act.

The low power radio-frequency devices must be susceptible with the interference from legal communications or ISM radio wave radiated devices.

## Using this equipment in Japan

In Japan, the frequency bandwidth of 2,400MHz to 2,483.5MHz for second generation low-power data communication systems such as this equipment overlaps that of mobile object identification systems (premises radio station and specified low-power radio station).

### 1. Important notice

The frequency bandwidth of this equipment may operate within the same range as industrial devices, scientific devices, medical devices, microwave ovens, licensed radio stations and non-licensed specified low-power radio stations for mobile object identification systems (RFID) used in factory production lines (Other Radio Stations).

1. Before using this equipment, ensure that it does not interfere with any of the equipment listed above.
2. If this equipment causes RF interference to other radio stations, promptly change the frequency being used, change the location of use, or turn off the source of emissions.
3. Contact an authorized TOSHIBA service provider if you have problems with interference caused by this product to Other Radio Stations.

### 2. Indication for Wireless LAN

The indication shown below appears on this equipment.

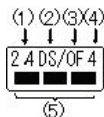

- (1) 2.4 : This equipment uses a frequency of 2.4GHz.
- (2) DS : This equipment uses DS-SS modulation.
- (3) OF : This equipment uses OFDM modulation.
- (4) 4 : The interference range of this equipment is less than 40m.
- (5) ■ ■ ■ : This equipment uses a frequency bandwidth from 2,400MHz to 2,483.5MHz. It is possible to avoid the band of mobile object identification systems.

### 3. Indication for Bluetooth

The indication shown below appears on this equipment.

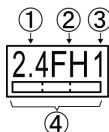

- (1) 2.4 : This equipment uses a frequency of 2.4 GHz.
- (2) FH : This equipment uses FH-SS modulation.
- (3) 1: The interference range of this equipment is less than 10 m.

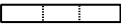
- (4)  This equipment uses a frequency bandwidth from 2,400 MHz to 2,483.5 MHz. It is impossible to avoid the band of mobile object identification systems.

#### 4. About the JEITA

5GHz Wireless LAN supports W52/W53/W56 Channel.

IEEE802.11b/g/n			
IEEE802.11a/n			
<del>W52</del>	W52	W53	W56

### Device Authorization

This device obtains the Technical Regulation Conformity Certification and it belongs to the device class of radio equipment of low-power data communication system radio station stipulated in the Telecommunications Business Law of Japan.

- Atheros AR9285 Wireless Network Adapter b/g/n(b/g) module  
The Name of the radio equipment: AR5B95  
DSP Research, Inc.  
Approval Number: D081038003
- Realtek® RTL8188CE Wireless LAN 802.11n PCI-E NIC b/g/n Wireless LAN  
The Name of the radio equipment: RTL8188CE  
Japan Approvals Institute for Telecommunications Equipment  
Approval Number: D100075001
- Atheros AR9002WB-1NG Wireless Network Adapter b/g/n(b/g) Wireless LAN and Bluetooth  
The Name of the radio equipment: AR5B195  
DSP Research, Inc.  
Approval Number: D091014003

The following restrictions apply:

- Do not disassemble or modify the device.
- Do not install the embedded wireless module into other device.

When using the wireless device in any country or region, refer to the section Approved Countries/Regions for use in the online manual.

## Radio approvals for wireless devices

### Approved Countries/Regions for the Atheros® AR9285 Wireless Network Adapter b/g/n (b/g) Wireless LAN

This equipment is approved to the radio standard by the countries/regions in the following table.



*Do not use this equipment in the countries/regions which are not listed in the table below.*



- *Available channel of Peer-to-peer connection by ad-hoc mode is Ch1-Ch11.*
- *Connection with an access point by the Infrastructure mode is Ch1-Ch13.*

As of Mar. 2011

Albania	Australia	Austria	Azerbaijan
Argentina	Bahrain	Belgium	Bolivia
Bosnia and Herzegovina	Bulgaria	Canada	Cambodia
Chile	China	Colombia	Costa Rica
Croatia	Cyprus	Czech Republic	Denmark
Dominican Republic	Ecuador	Egypt	El Salvador
Estonia	Finland	France	Germany
Ghana	Greece	Guatemala	Hong Kong
Hungary	Iceland	India	Indonesia
Ireland	Italy	Japan	Jordan
Kazakhstan	Kenya	Kuwait	Kyrgyzstan
Latvia	Lebanon	Liechtenstein	Lithuania
Luxembourg	Macedonia	Malaysia	Malta
Mexico	Monaco	Montenegro	Netherlands
New Zealand	Norway	Oman	Panama

Pakistan	Papua New Guinea	Paraguay	Peru
Philippines	Poland	Portugal	Puerto Rico
Qatar	Romania	Saudi Arabia	Serbia
Singapore	Slovak Republic	Slovenia	South Africa
South Korea	Spain	Sri Lanka	Sweden
Switzerland	Taiwan	Thailand	Turkey
UAE	UK	Ukraine	USA
Uruguay	Venezuela	Vietnam	Yemen
Zimbabwe			

### Approved Countries/Regions for the Realtek® RTL8188CE Wireless LAN 802.11n PCI-E NIC b/g/n Wireless LAN

This equipment is approved to the radio standard by the countries/regions in the following table.



*Do not use this equipment in the countries/regions which are not listed in the table below.*



- *An ad-hoc mode is not available in 802.11n mode.*
- *Available channel of Peer-to-peer connection by ad-hoc mode is Ch1-Ch11.*
- *Connection with an access point by the Infrastructure mode is Ch1-Ch13.*

As of Mar. 2011

Albania	Australia	Austria	Azerbaijan
Bahrain	Belgium	Bolivia	Bosnia and Herzegovina
Brazil	Bulgaria	Canada	Cambodia
Chile	China	Colombia	Costa Rica
Croatia	Cyprus	Czech Republic	Denmark



Dominican Republic	Ecuador	Egypt	El Salvador
Estonia	Finland	France	Germany
Ghana	Greece	Guatemala	Hong Kong
Hungary	Iceland	India	Indonesia
Ireland	Italy	Japan	Jordan
Kazakhstan	Kenya	Kuwait	Kyrgyzstan
Latvia	Lebanon	Lesotho	Liechtenstein
Lithuania	Luxembourg	Macedonia	Malaysia
Malta	Mexico	Monaco	Montenegro
Mozambique	Namibia	Netherlands	New Zealand
Norway	Oman	Pakistan	Panama
Papua New Guinea	Paraguay	Peru	Philippines
Poland	Portugal	Puerto Rico	Qatar
Romania	Saudi Arabia	Senegal	Serbia
Singapore	Slovak Republic	Slovenia	South Africa
South Korea	Spain	Sri Lanka	Sweden
Switzerland	Taiwan	Thailand	Turkey
Ukraine	UAE	UK	USA
Uruguay	Venezuela	Vietnam	

### Approved Countries/Regions for the Atheros AR9002WB-1NG Wireless Network Adaptor b/g/n (b/g) Wireless LAN and Bluetooth

This equipment is approved to the radio standard by the countries/regions in the following table.



*Do not use this equipment in the countries/regions which are not listed in the table below.*



- Available channel of Peer-to-peer connection by ad-hoc mode is Ch1-Ch11.
- Connection with an access point by the Infrastructure mode is Ch1-Ch13.

As of Mar. 2011

Albania	Algeria	Angola	Argentina
Australia	Austria	Azerbaijan	Bahrain
Bangladesh	Belarus	Belgium	Bolivia
Bosnia and Herzegovina	Botswana	Brazil	Bulgaria
Burkina Faso	Burundi	Cambodia	Cameroon
Canada	Central African Republic	Chile	China
Colombia	Comoros	Costa Rica	Croatia
Cyprus	Czech Republic	Democratic Republic of the Congo	Denmark
Dominican Republic	Ecuador	Egypt	El Salvador
Estonia	Finland	France	Georgia
Germany	Ghana	Greece	Guatemala
Honduras	Hong Kong	Hungary	Iceland
India	Indonesia	Ireland	Israel
Italy	Ivory Coast	Japan	Jordan
Kazakhstan	Kenya	Kuwait	Kyrgyzstan
Latvia	Lebanon	Lesotho	Liberia
Liechtenstein	Lithuania	Luxembourg	Libia
Madagascar	Malawi	Malaysia	Malta
Mauritius	Mexico	Monaco	Montenegro

---

Morocco	Mozambique	Namibia	Netherlands
New Zealand	Nicaragua	Niger	Nigeria
Norway	Oman	Pakistan	Panama
Paraguay	Peru	Philippines	Poland
Portugal	Puerto Rico	Qatar	Republic of Chad
Republic of Djibouti	Republic of The Gambia	Reunion	Romania
Rwanda	Saudi Arabia	Senegal	Serbia
Sierra Leone	Singapore	Slovak Republic	Slovenia
South Africa	South Korea	Spain	Sri Lanka
Swaziland	Sweden	Switzerland	Taiwan
Tajikistan	Thailand	Togo	Tunisia
Turkey	Turkmenista	UAE	UK
Ukraine	Uruguay	USA	Venezuela
Vietnam	Yemen	Zambia	Zimbabwe

## Appendix D

### AC Power Cord and Connectors

The power cord's AC input plug must be compatible with the various international AC power outlets and the cord must meet the standards for the country/region in which it is used. All cords must meet the following specifications:

<b>Wire size:</b>	Minimum 0.75 mm <sup>2</sup>
<b>Current rating:</b>	Minimum 2.5 amperes
<b>Voltage rating:</b>	125 or 250 VAC (depending on country/region's power standards)

### Certification agencies

<b>China</b>	CQC, CEMC		
<b>U.S. and Canada:</b>	UL listed and CSA certified No. 18 AWG, Type SVT or SPT-2		
<b>Australia:</b>	AS		
<b>Japan:</b>	DENANHO		
<b><i>Europe:</i></b>			
<b>Austria:</b>	OVE	<b>Italy:</b>	IMQ
<b>Belgium:</b>	CEBEC	<b>The Netherlands:</b>	KEMA
<b>Denmark:</b>	DEMKO	<b>Norway:</b>	NEMKO

<b>Finland:</b>	FIMKO	<b>Sweden:</b>	SEMKO
<b>France:</b>	LCIE	<b>Switzerland:</b>	SEV
<b>Germany:</b>	VDE	<b>United Kingdom:</b>	BSI

In Europe, two conductors power cord must be VDE type, H05VVH2-F or H03VVH2-F and for three conductors power cord must be VDE type, H05VV-F.

For the United States and Canada, two pin plug configuration must be a 2-15P (250V) or 1-15P (125V) and three pin plug configuration must be 6-15P (250V) or 5-15P (125V) as designated in the U.S. National Electrical code handbook and the Canadian Electrical Code Part II.

The following illustrations show the plug shapes for the U.S.A. and Canada, the United Kingdom, Australia, Europe and China.

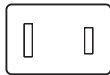
**USA**

UL approved

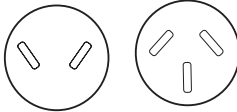
**Australia**

AS approved

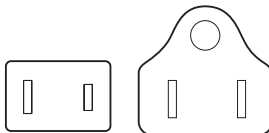
**Canada**

CSA approved

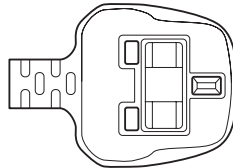
**United Kingdom**

BS approved

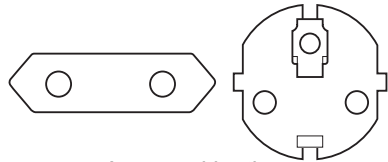
**Europe**

Approved by the appropriate agency

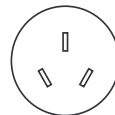
**China**

CCC approved

## Appendix E

### Legal Footnotes

This chapter states the Legal Footnotes information applicable to TOSHIBA computers.

### Non-applicable Icons

Certain computer chassis are designed to accommodate all possible configurations for an entire product series. Therefore, please be aware that your selected model may not have all the features and specifications corresponding to all of the icons or switches shown on the computer chassis.

### CPU

Central Processing Unit ("CPU") Performance Legal Footnotes.

CPU performance in your computer product may vary from specifications under the following conditions:

- use of certain external peripheral products
- use of battery power instead of AC power
- use of certain multimedia, computer generated graphics or video applications
- use of standard telephone lines or low speed network connections
- use of complex modeling software, such as high end computer aided design applications
- use of several applications or functionalities simultaneously
- use of computer in areas with low air pressure (high altitude >1,000 meters or >3,280 feet above sea level)

- use of computer at temperatures outside the range of 5°C to 30°C (41°F to 86°F) or >25°C (77°F) at high altitude (all temperature references are approximate and may vary depending on the specific computer model - please refer to your computer documentation or visit the TOSHIBA website at [www.pcsupport.toshiba.com](http://www.pcsupport.toshiba.com) for details).

CPU performance may also vary from specifications due to design configuration.

Under some conditions, your computer product may automatically shut-down. This is a normal protective feature designed to reduce the risk of lost data or damage to the product when used outside recommended conditions. To avoid risk of lost data, always make back-up copies of data by periodically storing it on an external storage medium. For optimum performance, use your computer product only under recommended conditions. Read additional restrictions in your product documentation. Contact TOSHIBA technical service and support, refer to [TOSHIBA support](#) section in Chapter 8 Troubleshooting for more information.

## 64-Bit Computing

64-bit processors are designed to take advantage of 32 and 64 bit computing.

64-bit computing requires that the following hardware and software requirements are met:

- 64-bit Operating System
- 64-bit CPU, Chipset and BIOS (Basic Input/Output System)
- 64-bit Device drivers
- 64-bit applications

Certain device drivers and/or applications may not be compatible with a 64-bit CPU and therefore may not function properly.

## Memory (Main System)

Part of the main system memory may be used by the graphics system for graphics performance and therefore reduce the amount of main system memory available for other computing activities. The amount of main system memory allocated to support graphics may vary depending on the graphics system, applications utilized, system memory size and other factors.

Computers configured with a 32-bit operating system can address up to approximately 3 GB of system memory.

Computers configured with a 64-bit operating system can address 4 GB or more of system memory.

## Battery Life

Battery life may vary considerably depending on product model, configuration, applications, power management settings and features utilized, as well as the natural performance variations produced by the design of individual components. Published battery life numbers are achieved on select models and configurations tested by TOSHIBA at the time of publication. Recharge time varies depending on usage. Battery may not charge while computer is consuming full power.

After going through many charge and discharge cycles, the battery will lose its ability to perform at maximum capacity and will need to be replaced. This is a normal phenomenon for all batteries. To purchase a new battery pack, see the accessories information that is shipped with your computer.

## Hard Disk Drive (HDD) Capacity

One Gigabyte (GB) means  $10^9 = 1,000,000,000$  bytes using powers of 10. The computer operating system, however, reports storage capacity using powers of 2 for the definition of  $1 \text{ GB} = 2^{30} = 1,073,741,824$  bytes, and therefore shows less storage capacity. Available storage capacity will also be less if the product includes one or more pre-installed operating systems, such as Microsoft Operating System and/or pre-installed software applications, or media content. Actual formatted capacity may vary.

## LCD

Over a period of time, and depending on the usage of the computer, the brightness of the LCD screen will deteriorate. This is an intrinsic characteristic of LCD technology.

Maximum brightness is only available when operating in AC power mode. Screen will dim when the computer is operated on battery power and you may not be able to increase the brightness of the screen.

## Graphics Processing Unit ("GPU")

Graphics processing unit ("GPU") performance may vary depending on product model, design configuration, applications, power management settings and features utilized. GPU performance is only optimized when operating in AC power mode and may decrease considerably when operating in battery power mode.

Total Available Graphics Memory is the total of, as applicable, Dedicated Video Memory, System Video Memory and Shared System Memory. Shared System Memory will vary depending on system memory size and other factors.



## Wireless LAN

The transmission speed over the wireless LAN and the distance over which wireless LAN can reach may vary depending on surrounding electromagnetic environment, obstacles, access point design and configuration, and client design and software/hardware configurations.

The actual transmission speed will be lower than the theoretical maximum speed.

## Copy Protection

Applicable copy protection standards included in certain media may prevent or limit recording or viewing of the media.

## Glossary

The terms in this glossary cover topics related to this manual. Alternate naming is included for reference.

### **Abbreviations**

**AC:** Alternating current

**ACPI:** Advanced Configuration and Power Interface

**ASCII:** American Standard Code for Information Interchange

**BD-R:** Blu-ray Disc Recordable

**BD-RE:** Blu-ray Disc Rewritable

**BIOS:** basic input/output system

**bps:** bits per second

**CD:** compact disc

**CD-ROM:** Compact Disc Read-Only Memory

**CD-RW:** Compact Disc-ReWritable

**CMOS:** complementary metal-oxide semiconductor

**CPU:** central processing unit

**CRT:** cathode ray tube

**DC:** direct current

**DDR:** double data rate

**DIMM:** dual inline memory module

**DVD:** digital versatile disc

**DVD-R:** Digital Versatile Disc-Recordable

**DVD-RAM:** Digital Versatile Disc-Random Access Memory

**DVD-R (Dual Layer):** Digital Versatile Disc Recordable Dual Layer

**DVD-ROM:** Digital Versatile Disc-Read Only Memory

**DVD-RW:** Digital Versatile Disc-ReWritable

**DVD+R (Double Layer):** Digital Versatile Disc Recordable Double Layer

**eSATA:** external Serial ATA

**FDD:** floppy diskette drive

**FIR:** fast infrared

**GB:** gigabyte

**HDD:** hard disk drive

**HDMI:** High-Definition Multimedia Interface

**IDE:** integrated drive electronics  
**IEEE:** Institute of Electrical and Electronics Engineers  
**I/O:** input/output  
**IRQ:** interrupt request  
**KB:** kilobyte  
**LAN:** local area network  
**LCD:** liquid crystal display  
**LED:** light emitting diode  
**MB:** megabyte  
**MMC:** multi media card  
**OCR:** optical character recognition (reader)  
**PC:** personal computer  
**PCI:** peripheral component interconnect  
**RAM:** random access memory  
**RGB:** red, green, and blue  
**ROM:** read only memory  
**RTC:** real time clock  
**S/P DIF:** Sony/Philips Digital Interface Format  
**SD:** Secure Digital  
**SDXC:** Secure Digital Extended Capacity  
**SDRAM:** synchronous dynamic random access memory  
**SLI:** Scalable Link Interface  
**SSD:** Solid state drive  
**TFT:** thin-film transistor  
**USB:** Universal Serial Bus  
**UXGA:** ultra extended graphics array  
**VGA:** video graphics array  
**WAN:** wide area network  
**WSXGA:** wide super extended graphics array  
**WSXGA+:** wide super extended graphics array plus  
**WUXGA:** Wide Ultra Extended Graphics Array  
**WXGA:** wide extended graphics array  
**WXGA+:** wide extended graphics array plus  
**XGA:** extended graphics array

## Index

### A

- AC adaptor 3-3
  - additional 3-24
  - connecting 1-3
  - DC IN 19V jack 2-5
- ASCII characters 5-5

### B

- Battery
  - charging 6-5
  - extending life 6-7
  - monitoring capacity 6-6
  - real time clock 3-3, 6-4
  - save mode 3-7
  - types 6-3
- Battery pack 2-5, 3-2
  - replacing 6-7
- Bluetooth 3-5, 4-22
  - Bluetooth Stack for Windows by Toshiba 3-9
  - problems 8-16
- Boot Priority Options 7-3

### C

- CD/DVD drive
  - using 4-6
- Cleaning the computer 4-25
- Cooling vents 2-3

### D

- DC IN/Battery
  - indicator 6-2
- DC IN/Battery indicator 2-9
- Display 3-4
  - automatic power off 3-6

- brightness down 5-3
- brightness up 5-3
- controller B-1
- hinges 2-8
- opening 1-6
- screen 2-9

- Documentation list 1-1
- DVD Super Multi drive
  - problems 8-9

### E

- Enable/Disable Wireless communication 4-23
- Equipment checklist 1-1
- External monitor 2-3, 3-20
  - problems 8-15

### F

- FN + ESC (Mute) 5-2
- FN + F1 (Lock) 5-2
- FN + F2 (Power Plan) 5-3
- FN + F3 (Sleep) 5-3
- FN + F4 (Hibernate) 5-3
- FN + F5 (Output) 5-3
- FN + F6 (Brightness Down) 5-3
- FN + F7 (Brightness Up) 5-3
- FN + F8 (Wireless) 5-3
- FN + F9 (Touch Pad) 5-3
- FN + space (Zoom) 5-4
- Function keys 5-2

### G

- Graphics controller 3-4

### H

- Hard disk drive 3-3

---

- automatic power off 3-6
- HDMI 3-21
- Heat dispersal 3-7, 4-26
- Hibernation Mode 3-7
- Hot keys 3-6
  - Brightness Down 5-3
  - Brightness Up 5-3
  - Hibernate 5-3
  - Lock 5-2
  - Mute 5-2
  - Output 5-3
  - Power Plan 5-3
  - Sleep 5-3
  - Touch Pad 5-3
  - Wireless 5-3
  - Volume down 5-4
  - Volume up 5-4
  - Zoom 5-4

- HW Setup
  - accessing 7-1
  - Boot priority 7-3
  - Boot Speed 7-4
  - display 7-3
  - general 7-2
  - LAN 7-4
  - SATA 7-5
  - window 7-1
  - USB 7-5

- J**
- Indicators 2-9

- K**
- Keyboard 5-1
  - FN Sticky key 5-4
  - Function keys F1...F12 5-2
  - Hot keys 5-2
  - problems 8-7
  - typewriter keys 5-1
  - Windows special keys 5-4

- L**
- LAN 3-5, 4-23
  - cable types 4-23
  - connecting 4-24
  - disconnecting 4-24
  - jack 2-3

- problems 8-16

- M**
- Media care 4-18
  - Card care 3-13
  - Memory card care 3-14
- Memory 3-2
  - additional 3-24
  - installing 3-16
  - problems 8-14
  - removing 3-19

- Memory media
  - inserting 3-14
  - removing 3-15
- Memory media slot 2-2, 3-12
  - using 3-12
- Moving the computer 4-25

- P**
- Panel Open - Power On 7-4
- Password
  - power on 3-6
  - Starting the computer by 6-10
- Pointing Device
  - Touch Pad 2-8, 4-1, 8-11
  - Touch Pad control buttons 4-1
  - using 4-1

- Power
  - conditions 6-1
  - Hibernation Mode 1-10
  - indicators 6-2
  - panel on/off 3-7, 6-11
  - Shut Down mode (Boot Mode) 1-7
  - Sleep Mode 1-8
  - System Auto Off 6-11
  - turning off 1-7
  - turning on 1-7

- Problems
  - AC power 8-5
  - Additional memory module 8-14
  - Analyzing the problem 8-2
  - Battery 8-5
  - Bluetooth 8-16
  - DVD Super Multi drive 8-9
  - External monitor 8-15
  - Hard disk drive 8-8
  - Hardware and system checklist 8-3

---

- Internal display panel 8-8
- Keyboard 8-7
- LAN 8-16
- Memory Cards 8-10
- Overheating power down 8-4
- Pointing device 8-11
- Power 8-4
- Real Time Clock 8-7
- Self test 8-4
- Sound system 8-14
- System start-up 8-3
- TOSHIBA support 8-17
- Touch Pad 8-11
- Wireless LAN 8-16
- USB device 8-13
- USB mouse 8-12

Processor 3-1

## R

- Recovery hard disk drive 1-13
- Recovery Media 1-14
  - problems 8-17
- Restarting the computer 1-11

## S

- SD/SDHC/SDXC Card
  - formatting 3-13
  - note 3-12
- Security lock 3-23
- Sleep Mode
  - setting 1-8
  - System automatic 3-6
- Sound system
  - headphone jack 2-3
  - microphone jack 2-3
  - problems 8-14
  - SmartAudio 4-19
  - Stereo speakers 2-8

## T

- TOSHIBA Assist 3-9
- TOSHIBA ConfigFree 3-9
- TOSHIBA Disc Creator 3-9, 4-14
- TOSHIBA DVD-RAM Utility 3-9
- TOSHIBA HDD/SSD Alert Utility 3-10
- TOSHIBA PC Diagnostic Tool 3-8
- TOSHIBA Service Station 3-10

TOSHIBA Speech System 3-11

## W

- Web Camera 2-8, 3-5, 4-2
- Video mode B-1
- Video RAM 3-2
- Wireless communication 4-20
- Wireless LAN 3-5, 4-21
  - problems 8-16
- USB device
  - problems 8-13
- Utilities and Applications 3-8