

TOSHIBA

Leading Innovation >>>

User's Manual

Satellite C650/C650D

Satellite Pro C650/C650D Series

Copyright

© 2010 by TOSHIBA Corporation. All rights reserved. Under the copyright laws, this manual cannot be reproduced in any form without the prior written permission of TOSHIBA. No patent liability is assumed, with respect to the use of the information contained herein.

TOSHIBA Satellite C650/Satellite C650D/Satellite Pro C650/Satellite Pro C650D Series Portable Personal Computer User's Manual

First edition April 2010

Copyright authority for music, movies, computer programs, data bases and other intellectual property covered by copyright laws belongs to the author or to the copyright owner. Copyrighted material can be reproduced only for personal use or use within the home. Any other use beyond that stipulated above (including conversion to digital format, alteration, transfer of copied material and distribution on a network) without the permission of the copyright owner is a violation of copyright or author's rights and is subject to civil damages or criminal action. Please comply with copyright laws in making any reproduction from this manual.

Disclaimer

This manual has been validated and reviewed for accuracy. The instructions and descriptions it contains are accurate for the TOSHIBA Satellite C650/Satellite C650D/Satellite Pro C650/Satellite Pro C650D Series Portable Personal Computer at the time of this manual's production. However, succeeding computers and manuals are subject to change without notice. TOSHIBA assumes no liability for damages incurred directly or indirectly from errors, omissions or discrepancies between the computer and the manual.

Trademarks

IBM is a registered trademark, and IBM PC and PS/2 are trademarks of International Business Machines Corporation.

Intel, Intel SpeedStep and Intel Core and Centrino are trademarks or registered trademarks of Intel Corporation or its subsidiaries in the United States and other countries/regions.

AMD, the AMD Arrow logo, AMD Athlon, AMD Turion, Radeon, and combinations thereof, ATI Mobility Radeon™ are trademarks of Advanced Micro Devices, Inc.

Windows® and Microsoft are registered trademarks of Microsoft Corporation.

Photo CD is a trademark of Eastman Kodak.

ConfigFree is a trademark of Toshiba Corporation.

Wi-Fi is a registered trademark of the Wi-Fi Alliance.

Secure Digital and SD are trademarks of SD Card Association.
MultiMediaCard and MMC are trademarks of MultiMediaCard Association.
Labelflash™ is a trademark of YAMAHA CORPORATION.
Other trademarks and registered trademarks not listed above may be used
in this manual.

Safety Instructions

Use the following safety guidelines to help to protect yourself and your computer.

When Using Your Computer



Do not operate your portable computer for an extended period of time with the base resting directly on your body. With extended operation, heat can potentially build up in the base. Allowing sustained contact with the skin could cause discomfort or, eventually, a burn.

- Do not attempt to service the computer yourself. Always follow installation instructions closely.
- Do not carry a battery in your pocket, purse, or other container where metal objects (such as car keys) could short-circuit the battery terminals. The resulting excessive current flow can cause extremely high temperatures and may result in damage from burns.
- Be sure that nothing rests on your AC adaptor's power cable and that the cable is not located where it can be tripped over or stepped on.
- Place the AC adaptor in a ventilated area, such as a desk top or on the floor, when you use it to run the computer or to charge the battery. Do not cover the AC adaptor with papers or other items that will reduce cooling; also, do not use the AC adaptor while it is inside a carrying case.
- Use only the AC adaptor and batteries that are approved for use with this computer. Use of another type of battery or AC adaptor may risk fire or explosion.
- Before you connect the computer to a power source, ensure that the voltage rating of the AC adaptor matches that of the available power source. 115 V/60 Hz in most of North and South America and some Far Eastern countries such as Taiwan. 100 V/50 Hz in eastern Japan and 100 V/60 Hz in western Japan. 230 V/50 Hz in most of Europe, the Middle East, and the Far East.
- If you use an extension cable with your AC adaptor, ensure that the total ampere rating of the products plugged in to the extension cable does not exceed the ampere rating of the extension cable.
- To remove power from the computer, turn it off, remove the battery, and disconnect the AC adaptor from the electrical outlet.
- To help avoid the potential hazard of electric shock, do not connect or disconnect any cables or perform maintenance or reconfiguration of this product during an electrical storm.
- When setting up the computer for work, place it on a level surface.

FCC Information

FCC Notice “Declaration of Conformity Information”

This equipment has been tested and found to comply with the limits for a Class B digital device, pursuant to part 15 of the FCC rules. These limits are designed to provide reasonable protection against harmful interference in a residential installation. This equipment generates, uses and can radiate radio frequency energy and, if not installed and used in accordance with the instructions, may cause harmful interference to radio communications. However, there is no guarantee that interference will not occur in a particular installation. If this equipment does cause harmful interference to radio or television reception, which can be determined by turning the equipment off and on, the user is encouraged to try to correct the interference by one or more of the following measures:

- Reorient or relocate the receiving antenna.
- Increase the separation between the equipment and receiver.
- Connect the equipment into an outlet on a circuit different from that to which the receiver is connected.
- Consult the dealer or an experienced radio/TV technician for help.



Only peripherals complying with the FCC class B limits may be attached to this equipment. Operation with non-compliant peripherals or peripherals not recommended by TOSHIBA is likely to result in interference to radio and TV reception. Shielded cables must be used between the external devices and the computer's external monitor port, USB port, and microphone jack. Changes or modifications made to this equipment, not expressly approved by TOSHIBA or parties authorized by TOSHIBA could void the user's authority to operate the equipment.

FCC Conditions

This device complies with part 15 of the FCC Rules. Operation is subject to the following two conditions:

1. This device may not cause harmful interference.
2. This device must accept any interference received, including interference that may cause undesired operation.

Contact

Address: TOSHIBA America Information Systems, Inc.
9740 Irvine Boulevard
Irvine, California 92618-1697
Telephone: (949) 583-3000

EU Conformity Statement



This product is carrying the CE-Mark in accordance with the related European Directives. Responsible for CE-Marking is TOSHIBA Europe GmbH, Hammfelddamm 8, 41460 Neuss, Germany. The complete and official EU Declaration of Conformity can be found on TOSHIBA's web site <http://epps.toshiba-teg.com> on the Internet.

CE compliance

This product is labelled with the CE Mark in accordance with the related European Directives, notably Electromagnetic Compatibility Directive 2004/108/EC for the notebook and the electronic accessories including the supplied power adapter, the Radio Equipment and Telecommunications Terminal Equipment Directive 1999/5/EC in case of implemented telecommunication accessories and the Low Voltage Directive 2006/95/EC for the supplied power adapter. Furthermore the product complies with the Ecodesign Directive 2009/125/EC (ErP) and its related implementing measures.

This product and the original options are designed to observe the related EMC (Electromagnetic Compatibility) and safety standards. However, TOSHIBA cannot guarantee that this product still observes these EMC standards if options or cables not produced by TOSHIBA are connected or implemented. In this case the persons who have connected/implemented those options/cables have to provide assurance that the system (PC plus options/cables) still fulfils the required standards. To avoid general EMC problems, the following guidance should be noted:

- Only CE marked options should be connected/implemented
- Only best shielded cables should be connected

Working environment

This product was designed to fulfil the EMC (Electromagnetic Compatibility) requirements to be observed for so-called "Residential, commercial and light industry environments". TOSHIBA do not approve the use of this product in working environments other than the above mentioned "Residential, commercial and light industry environments". For example, the following environments are not approved:

- Industrial Environments (e.g. environments where a mains voltage of 380 V three-phase is used)
- Medical Environments
- Automotive Environments
- Aircraft Environments

Any consequences resulting from the use of this product in working environments that are not approved are not the responsibility of TOSHIBA. The consequences of the use of this product in non-approved working environments may be:

- Interference with other devices or machines in the near surrounding area.
- Malfunction of, or data loss from, this product caused by disturbances generated by other devices or machines in the near surrounding area.

Therefore TOSHIBA strongly recommend that the electromagnetic compatibility of this product should be suitably tested in all non-approved working environments before use. In the case of automobiles or aircraft, the manufacturer or airline respectively should be asked for permission before use of this product.

Furthermore, for general safety reasons, the use of this product in environments with explosive atmospheres is not permitted.

VCCI Class B Information

この装置は、クラスB情報技術です。この装置は、家庭環境で使用することを目的としていますが、この装置がラジオやテレビジョン受信機に近接して使用されると、受信障害を引き起こすことがあります。

取扱説明書に従って正しい取り扱いをしてください。

V C C I - B

Canadian Regulatory Information (Canada only)

This digital apparatus does not exceed the Class B limits for radio noise emissions from digital apparatus as set out in the Radio Interference Regulation of the Canadian Department of Communications.

Note that Canadian Department of Communications (DOC) regulations provide, that changes or modifications not expressly approved by TOSHIBA Corporation could void your authority to operate this equipment.

This Class B digital apparatus meets all requirements of the Canadian Interference-Causing Equipment Regulations.

Cet appareil numérique de la class B respecte toutes les exigences du Règlement sur le matériel brouilleur du Canada.

Following Information Is Only Valid for EU-member States

Disposal of Products



The crossed out wheeled dust bin symbol indicates that products must be collected and disposed of separately from household waste. Integrated batteries and accumulators can be disposed of with the product. They will be separated at the recycling centres.

The black bar indicates that the product was placed on the market after August 13, 2005.



By participating in separate collection of products and batteries, you will help to assure the proper disposal of products and batteries and thus help to prevent potential negative consequences for the environment and human health.

For more detailed information about the collection and recycling programmes available in your country, please visit our website (<http://eu.computers.toshiba-europe.com>) or contact your local city office or the shop where you purchased the product.

Disposal of Batteries and/or Accumulators



Pb, Hg, Cd

The crossed out wheeled dust bin symbol indicates that batteries and/or accumulators must be collected and disposed of separately from household waste.

If the battery or accumulator contains more than the specified values of lead (Pb), mercury (Hg), and/or cadmium (Cd) defined in the Battery Directive (2006/66/EC), then the chemical symbols for lead (Pb), mercury (Hg) and/or cadmium (Cd) will appear below the crossed out wheeled dust bin symbol.

By participating in separate collection of batteries, you will help to assure the proper disposal of products and batteries and thus help to prevent potential negative consequences for the environment and human health.

For more detailed information about the collection and recycling programmes available in your country, please visit our website (<http://eu.computers.toshiba-europe.com>) or contact your local city office or the shop where you purchased the product.



This symbol may not be displayed depending on the country and region where you purchased.

Disposing of the Computer and the Computer's Batteries

- Discard this computer in accordance with applicable laws and regulations. For further information, contact your local government.
- This computer contains rechargeable batteries. After repeated use, the batteries will finally lose their ability to hold a charge and you will need to replace them. Under certain applicable laws and regulation, it may be illegal to dispose of old batteries by placing them in the trash.
- Please be kind to our shared environment. Check with your local government authority for details regarding where to recycle old batteries or how to dispose of them properly. This product contains mercury. Disposal of this material may be regulated due to environmental considerations. For disposal, reuse or recycling information, please contact your local government.

REACH - Compliance Statement

The new European Union (EU) chemical regulation, REACH (Registration, Evaluation, Authorization and Restriction of Chemicals), entered into force on 1 June 2007. TOSHIBA will meet all REACH requirements and is committed to provide our customers with information about the chemical substances in our products according to REACH regulation.

Please consult the following website

www.toshiba-europe.com/computers/info/reach for information about the presence in our articles of substances included on the candidate list according to article 59(1) of Regulation (EC) No 1907/2006 ("REACH") in a concentration above 0.1 % weight by weight.

Following information is only for Turkey

- Compliant with EEE Regulations: TOSHIBA meets all requirements of Turkish regulation 26891 "Restriction of the use of certain hazardous substances in electrical and electronic equipment.
- The number of possible pixel failures of your display is defined according to ISO 13406-2 standards. If the number of pixel failures is less than this standard, they will not be counted as defect or failure.
- Battery is a consumption product, since the battery time depends on the usage of your computer. If the battery can not be charged at all, then it is a defect or failure. The changes in battery time is not a defect or failure.

ENERGY STAR® Program



Your computer model may be ENERGY STAR® Compliant. If the model you purchased is compliant, it is labeled with the ENERGY STAR logo on the computer and the following information applies.

TOSHIBA is a partner in the ENERGY STAR Program and has designed this computer to meet the latest ENERGY STAR guidelines for energy efficiency. Your computer ships with the power management options preset to a configuration that will provide the most stable operating environment and optimum system performance for both AC power and battery modes.

To conserve energy, your computer is set to enter the low-power Sleep Mode which shuts down the system and display within 15 minutes of inactivity in AC power mode. TOSHIBA recommends that you leave this and other energy saving features active, so that your computer will operate at its maximum energy efficiency. You can wake the computer from Sleep Mode by pressing the power button.

Products that earn the ENERGY STAR prevent greenhouse gas emissions by meeting strict energy efficiency guidelines set by the US EPA and the EU Commission. According to the EPA, a computer meeting the new ENERGY STAR specifications will use between 20% and 50% less energy depending on how it is used.

Visit <http://www.eu-energystar.org> or <http://www.energystar.gov> for more information regarding the ENERGY STAR Program.

Optical Disc Drive Standards

TOSHIBA Satellite C650/Satellite C650D/Satellite Pro C650/Satellite Pro C650D Series computer is shipped with one of the following drives preinstalled: DVD Super Multi (±R DL) drive or DVD Super Multi (±R DL) /w Label Flash drive.

The drive has one of the following labels:

CLASS 1 LASER PRODUCT

LASER KLASSE 1

LUOKAN 1 LASERLAITE

APPAREIL A LASER DE CLASSE1

KLASS 1 LASER APPARAT

Before it is shipped, the Class 1 Laser is certified to meet the United States Chapter 21 Standards of the Department of Health and Human Services (DHHS 21 CFR).

For any other country, the drive is certified to meet the Class 1 Laser standards of IEC825 and EN60825.

Optical Disc Drive Safety Instructions



- *The drive employs a laser system. To ensure proper use of this product, please read this manual carefully and retain for future reference.
Should the unit ever require maintenance, contact an authorized service location.*
- *Use of controls, adjustments or the performance of procedures other than those specified may result in hazardous radiation exposure*
- *To prevent direct exposure to the laser beam, do not try to open the enclosure.*

DVD Super Multi (±R DL) Drive

Panasonic System Networks

UJ890AD/UJ890ED

Location of the required label

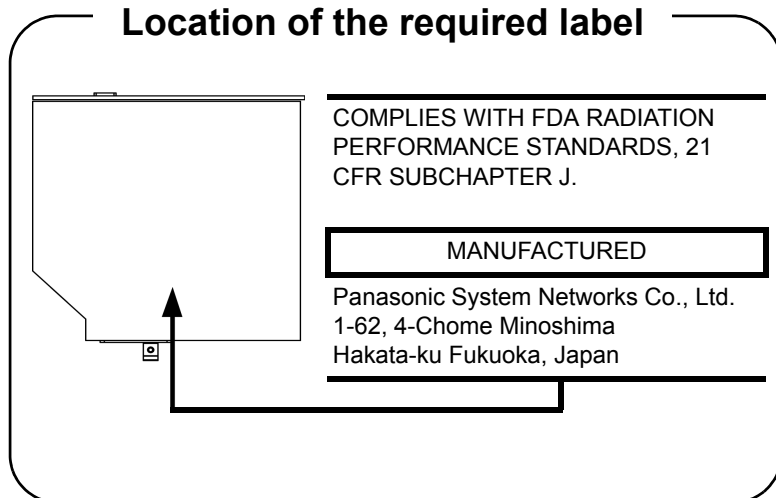

*Toshiba Samsung Storage Technology
TS-L633C/TS-L633Y*

Location of the required label

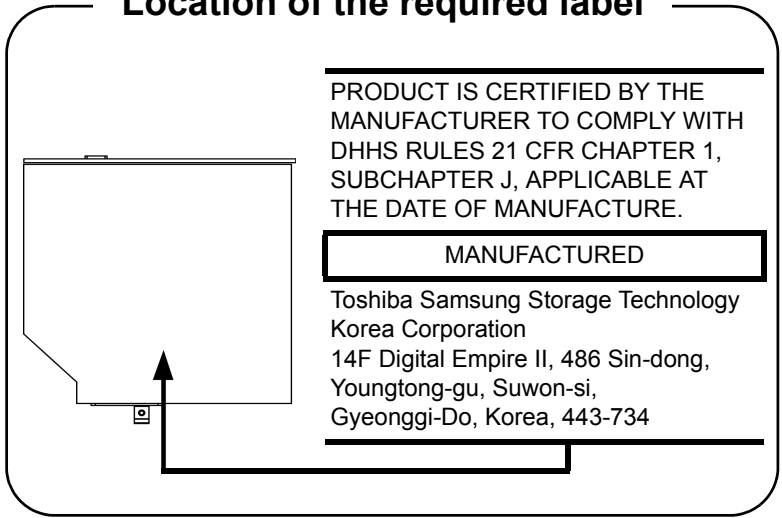

*Hitachi-LG Data Storage
GT30N/GT30F*

Location of the required label

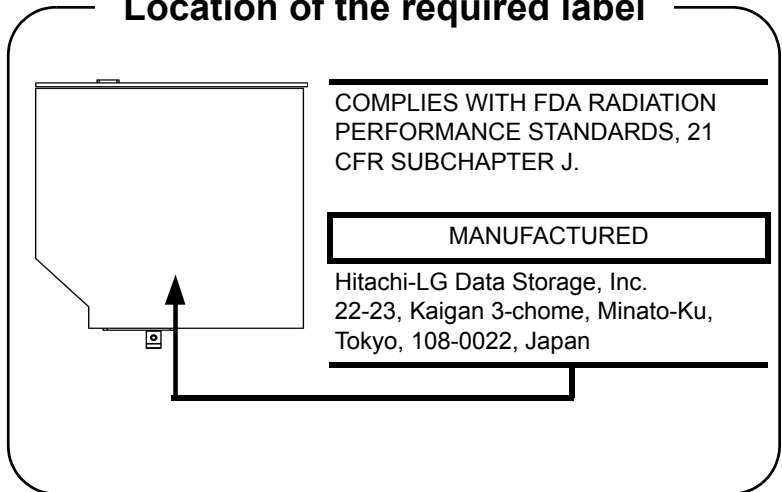

TEAC
DV-W28S-V

Location of the required label

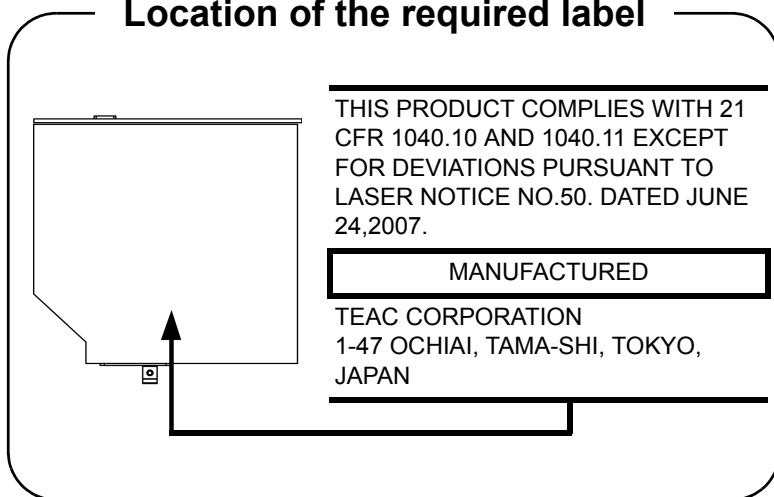

International Precautions

CLASS 1 LASER PRODUCT
LASER KLASSE 1 PRODUKT
TO EN 60825-1
クラス1 レーザ 製品

CLASS 1 LASER PRODUCT
LASERSCHUTZKLASSE 1
PRODUKT
TO EN60825

ADVERSEL: USYNLIG
LASERSTRÅLING VED ÅBNING,
NÅR SIKKERHEDSAF-BRYDER
ER UDE AF FUNKTION.
UNDGÅ UDSÆTTELSE FOR
STRÅLING

CAUTION: *This appliance contains a laser system and is classified as a "CLASS 1 LASER PRODUCT." To use this model properly, read the instruction manual carefully and keep this manual for your future reference. In case of any trouble with this model, please contact your nearest "AUTHORIZED service station." To prevent direct exposure to the laser beam, do not try to open the enclosure.*

VORSICHT: *Dieses Gerät enthält ein Laser-System und ist als "LASERSCHUTZKLASSE 1 PRODUKT" klassifiziert. Für den richtigen Gebrauch dieses Modells lesen Sie bitte die Bedienungsanleitung sorgfältig durch und bewahren diese bitte als Referenz auf. Falls Probleme mit diesem Modell auftreten, benachrichtigen Sie bitte die nächste "autorisierte Service-Vertretung". Um einen direkten Kontakt mit dem Laserstrahl zu vermeiden darf das Gerät nicht geöffnet werden.*

ADVARSEL: *Denne mærking er anbragt udvendigt på apparatet og indikerer, at apparatet arbejder med laserstråler af klasse 1, hvilket betyder, at der anvendes laserstråler af svageste klasse, og at man ikke på apparatets yderside kan bilve udsat for utilsadelig kraftig stråling.*

**APPARATET BOR KUN ÅBNES AF
FAGFOLK MED SÆRLIGT KENDSKAB
TIL APPARATER MED
LASERSTRÅLER!**

Indvendigt i apparatet er anbragt den her gengivne advarselmækning, som advarer imod at foretage sådanne indgreb i apparatet, at man kan komme til at udsatte sig for laserstråling.

OBS! Apparaten innehåller laserkomponent som avger laserstråling överstigande gränsen för laserklass 1.

VAROITUS. Suojakoteloä si saa avata. Laite sisältää laserdiodin, joka lähettää näkymätöntä silmille vaarallista lasersäteilyä.

CAUTION: USE OF CONTROLS OR ADJUSTMENTS OR PERFORMANCE OF PROCEDURES OTHER THAN THOSE SPECIFIED IN THE OWNER'S MANUAL MAY RESULT IN HAZARDOUS RADIATION EXPOSURE.

VORSICHT: DIE VERWENDUNG VON ANDEREN STEUERUNGEN ODER EINSTELLUNGEN ODER DAS DURCHFÜHREN VON ANDEREN VORGÄNGEN ALS IN DER BEDIENUNGSANLEITUNG BESCHRIEBEN KÖNNEN GEFÄHRLICHE STRAHLENEXPOSITIONEN ZUR FOLGE HABEN.

Table of Contents

Preface

General Precautions

Chapter 1

Getting Started

Equipment Checklist	1-1
Hardware	1-1
Documentation	1-1
Software	1-2
Getting Started	1-2
Connecting the AC Adaptor	1-3
Opening The Display	1-6
Turning On The Power	1-7
Starting Up for The First Time	1-7
Turning Off The Power	1-7
Shut Down Mode	1-7
Sleep Mode	1-8
Hibernation Mode	1-10
Restarting The Computer	1-11
System Recovery Options	1-12
System Recovery Options	1-12
System Recovery	1-13
Creating Recovery Media	1-13
Restoring the pre-installed software from the Recovery hard disk drive	1-14
Restoring the pre-installed software from your created Recovery Media	1-14

Chapter 2

The Grand Tour

Front with The Display Closed	2-1
Left Side	2-2
Right Side	2-4
Back Side	2-4
Underside	2-5
Front with The Display Open	2-6
System Indicators	2-8

Keyboard Indicators	2-9
Optical Disc Drive	2-10
Region Codes for DVD Drives and Media	2-10
Writable Discs	2-10
DVD Super Multi (± R DL) Drive	2-11
AC Adaptor	2-12

Chapter 3 **Hardware, Utilities and Options**

Hardware	3-1
Processor*1	3-1
Memory*2	3-1
Disks	3-2
Display	3-3
Keyboard	3-4
Pointing Device	3-5
Power	3-5
Ports	3-5
Slots	3-5
Multimedia	3-6
Communications	3-6
Security	3-6
Software	3-6
Special Features	3-7
TOSHIBA Value Added Package	3-9
Utilities and Applications	3-10
Options	3-12
Optional Devices	3-12
Cards/Memory	3-12
Power Devices	3-13
Peripheral Devices	3-13
Other	3-13
Bridge Media Slot	3-13
Memory Media	3-14
Media Care	3-15
Inserting a Memory Media	3-16
Removing a Memory Media	3-16
Memory Expansion	3-17
Installing Memory Module	3-17
Removing Memory Module	3-20
Additional Battery Pack (3 Cell and 6 Cell)	3-21
Additional AC Adaptor	3-21
USB FDD Kit	3-21
External Monitor	3-21
Security Lock	3-22

Connecting the security lock	3-22
--	------

Chapter 4 Operating Basics

Using The Touchpad	4-1
Using The Web Camera	4-3
Using TOSHIBA Web Camera Application	4-4
Using The TOSHIBA Face Recognition	4-5
Note on Use	4-5
Disclaimer	4-5
How to Register The Face Recognition Data	4-6
How to Delete The Face Recognition Data	4-7
How to Launch The Help File	4-7
Windows Logon Via TOSHIBA Face Recognition	4-7
Using Optical Disc Drives	4-8
Loading Discs	4-9
Removing Discs	4-11
Writing CD/DVDs on DVD Super Multi (±R DL) Drive	4-12
Important Message (DVD Super Multi (±R DL) Drive)	4-12
Before Writing or Rewriting	4-13
When Writing or Rewriting	4-15
Disclaimer (DVD Super Multi (±R DL) Drive)	4-16
TOSHIBA Disc Creator	4-16
Data Verification	4-17
How to Learn More about TOSHIBA Disc Creator	4-17
TOSHIBA DVD PLAYER	4-18
Notes on Use	4-18
Display Devices & Audio	4-19
Starting TOSHIBA DVD PLAYER	4-20
Operating TOSHIBA DVD PLAYER	4-20
Open TOSHIBA DVD PLAYER HELP	4-20
Media Care	4-21
CD/DVD	4-21
Sound System	4-21
Adjusting System Volume	4-21
Changing System Sounds	4-22
Smart Audio	4-22
Using The Microphone	4-24
Wireless Communications	4-25
Wireless LAN	4-25
Wireless Communication Hot key	4-26
LAN	4-26
LAN Cable Types	4-26
Connecting LAN Cable	4-27
Disconnecting LAN Cable	4-28

	Cleaning The Computer	4-28
	Moving The Computer	4-28
	Heat Dispersal	4-29
<i>Chapter 5</i>	The Keyboard	
	Typewriter Keys	5-1
	Function Keys: F1 ... F9	5-2
	Soft Keys: FN Key Combinations	5-2
	Hot Keys	5-2
	FN Sticky Key	5-5
	Windows Special Keys	5-5
	Generating ASCII Characters	5-5
<i>Chapter 6</i>	Power and Power-up Modes	
	Power Conditions	6-1
	System Indicators	6-2
	DC IN/Battery Indicator	6-2
	Power Indicator	6-3
	Battery Types	6-3
	Battery	6-3
	Real Time Clock Battery	6-4
	Care and Use of The Battery Pack	6-4
	Safety Precautions	6-4
	Charging The Batteries	6-7
	Monitoring Battery Capacity	6-8
	Maximizing Battery Operating Time	6-9
	Retaining Data with Power off	6-9
	Extending Battery Life	6-10
	Replacing The Battery Pack	6-10
	Removing The Battery Pack	6-11
	Installing The Battery Pack	6-12
	Starting The Computer by Password	6-13
	Power-up Modes	6-13
	Windows Utilities	6-13
	Hot Keys	6-13
	Panel Power On/Off	6-14
	System Auto Off	6-14
<i>Chapter 7</i>	HW Setup and Passwords	
	Accessing HW Setup	7-1
	HW Setup Window	7-1
<i>Chapter 8</i>	Troubleshooting	
	Problem Solving Process	8-1
	Preliminary Checklist	8-2
	Analyzing The Problem	8-2

Hardware and System Checklist	8-3
System Start-up	8-3
Self Test	8-4
Power	8-4
Password	8-6
Keyboard	8-6
LCD Panel	8-7
Hard Disk Drive	8-7
DVD Super Multi(±R DL) Drive	8-8
Diskette Drive	8-9
Pointing Device	8-9
Memory cards:Secure Digital (SD), Secure Digital High Capacity (SDHC), Secure Digital Extended Capacity (SDXC) and MultiMediaCard (MMC)	8-11
External Monitor	8-11
Sound System	8-12
USB	8-13
Sleep/Hibernation	8-13
LAN	8-13
Wireless LAN	8-14
Recovery Media	8-14
TOSHIBA Support	8-15
Before You Call	8-15
Where to Write	8-15

Appendix A **Specifications**

Appendix B **Display Controller and Video Mode**

Appendix C **Wireless LAN**

Appendix D **AC Power Cord and Connectors**

Appendix E **Legal Footnotes**

Glossary

Index

Preface

Congratulations on your purchase of the TOSHIBA Satellite C650/Satellite C650D/Satellite Pro C650/Satellite Pro C650D Series computer. This powerful, lightweight notebook computer is designed to provide years of reliable, high-performance computing.

This manual tells you how to set up and begin using your Satellite C650/Satellite C650D/Satellite Pro C650/Satellite Pro C650D Series computer. It also provides detailed information on configuring your computer, basic operations and care, using optional devices and troubleshooting.

If you are a new user of computers or if you're new to portable computing, first read over the *Hardware, Utilities and Options* and *The Grand Tour* chapters to familiarize yourself with the computer's features, components and accessory devices. Then read *Getting Started* for step-by-step instructions on setting up your computer.

If you are an experienced computer user, please continue reading the preface to learn how this manual is organized, then become acquainted with this manual by browsing through its pages. Be sure to read the *Special Features* section of the Introduction, to learn about features that are uncommon or unique to the computers and carefully read *HW Setup and Passwords*. If you are going to install memory cards or connect external devices such as a printer, be sure to read Chapter 3, *Hardware, Utilities and Options*

Manual Contents

This manual is composed of the following chapters, appendixes, a glossary and an index.

Chapter 1, *Getting Started*, is an overview of the computer's features, capabilities, and options.

Chapter 2, *The Grand Tour*, identifies the components of the computer and briefly explains how they function.

Chapter 3, *Hardware, Utilities and Options*, provides a quick overview of how to begin operating your computer.

Chapter 4, *Operating Basics*, includes tips on care of the computer and on using the touchpad, optical disc drive, Audio/Video controls, the web camera, the microphone, wireless communication and LAN.

Chapter 5, *The Keyboard*, describes special keyboard functions such as hot keys.

Chapter 6, *Power and Power-up Modes*, gives details on the computer's power resources and battery save modes.

Chapter 7, *HW Setup and Passwords*, explains how to configure the computer using the HW Setup program. It also tells how to set a password.

Chapter 8, *Troubleshooting*, provides helpful information on how to perform some diagnostic tests, and suggests courses of action if the computer doesn't seem to be working properly.

The appendixes provide technical information about your computer.

The *Glossary* defines general computer terminology and includes a list of acronyms used in the text.

The *Index* quickly directs you to the information contained in this manual.

Conventions

This manual uses the following formats to describe, identify, and highlight terms and operating procedures.

Abbreviations

On first appearance, and whenever necessary for clarity, abbreviations are enclosed in parenthesis following their definition. For example: Read Only Memory (ROM). Acronyms are also defined in the *Glossary*.

Icons

Icons identify ports, dials, and other parts of your computer. The indicator panel also uses icons to identify the components it is providing information on.

Keys

The keyboard keys are used in the text to describe many computer operations. A distinctive typeface identifies the key top symbols as they appear on the keyboard. For example, **ENTER** identifies the Enter key.

Key Operation

Some operations require you to simultaneously use two or more keys. We identify such operations by the key top symbols separated by a plus sign (+). For example, **CTRL + C** means you must hold down **CTRL** and at the same time press **C**. If three keys are used, hold down the first two and at the same time press the third.

ABC When procedures require an action such as clicking an icon or entering text, the icon's name or the text you are to type in is represented in the typeface you see to the left.

Display

ABC Names of windows or icons or text generated by the computer that appear on its display screen are presented in the typeface you see to the left.

Messages

Messages are used in this manual to bring important information to your attention. Each type of message is identified as shown below.



Pay attention! A caution informs you that improper use of equipment or failure to follow instructions may cause data loss or damage your equipment.



Please read. A note is a hint or advice that helps you make best use of your equipment.



Indicates a potentially hazardous situation, which could result in death or serious injury if you do not follow instructions.

Terminology

This term is defined in this document as follows:

Start

The word “**Start**” refers to the “” button in Windows® 7.

General Precautions

TOSHIBA computers are designed to optimize safety, minimize strain and withstand the rigors of portability. However, certain precautions should be observed to further reduce the risk of personal injury or damage to the computer.

Be certain to read the general precautions below and to note the cautions included in the text of the manual.

Provide Adequate Ventilation

- Always make sure your computer and AC adaptor have adequate ventilation and are protected from overheating when the power is turned on or when an AC adaptor is connected to a power outlet (even if your computer is in Sleep Mode). In this condition, observe the following:
 - Never cover your computer or AC adaptor with any object.
 - Never place your computer or AC adaptor near a heat source, such as an electric blanket or heater.
 - Never cover or block the air vents including those located at the base of the computer.
- Always operate your computer on a hard flat surface. Using your computer on a carpet or other soft material can block the vents.
- Always provide sufficient space around the computer.
- Overheating your computer or AC adaptor could cause system failure, computer or AC adaptor damage or a fire, possibly resulting in serious injury.

Creating a Computer-friendly Environment

Place the computer on a flat surface that is large enough for the computer and any other items you are using, such as a printer.

Leave enough space around the computer and other equipment to provide adequate ventilation. Otherwise, they may overheat.

To keep your computer in prime operating condition, protect your work area from:

- Dust, moisture, and direct sunlight.
- Equipment that generates a strong electromagnetic field, such as stereo speakers (other than speakers that are connected to the computer) or speakerphones.
- Rapid changes in temperature or humidity and sources of temperature change such as air conditioner vents or heaters.
- Extreme heat, cold, or humidity.
- Liquids and corrosive chemicals.

Stress Injury

Carefully read the *Instruction Manual for Safety and Comfort*. It contains information on the prevention of stress injuries to your hands and wrists that can be caused by extensive keyboard use. *Instruction Manual for Safety and Comfort* also includes information on work space design, posture and lighting that can help reduce physical stress.

Heat Injury

- Avoid prolonged physical contact with the computer. If the computer is used for long periods, its surface can become very warm. While the temperature will not feel hot to the touch, if you maintain physical contact with the computer for a long time, for example if you rest the computer on your lap or if you keep your hands on the palm rest, your skin might suffer a low-heat injury.
- If the computer has been used for a long time, avoid direct contact with the metal plate supporting the various interface ports as this can become hot.
- The surface of the AC adaptor can become hot when in use but this condition does not indicate a malfunction. If you need to transport the AC adaptor, you should disconnect it and let it cool before moving it.
- Do not lay the AC adaptor on a material that is sensitive to heat as the material could become damaged.

Pressure or Impact Damage

Do not apply heavy pressure to the computer or subject it to any form of strong impact as this can damage the computer's components or otherwise cause it to malfunction.

Mobile Phones

Please be aware that the use of mobile phones can interfere with the audio system. The operation of the computer will not be impaired in any way, but it is recommended that a minimum distance of 30cm is maintained between the computer and a mobile phone that is in use.

Instruction Manual for Safety and Comfort

All important information on the safe and proper use of this computer is described in the enclosed *Instruction Manual for Safety and Comfort*. Be sure to read it before using the computer.

Chapter 1

Getting Started

This chapter provides an equipment checklist, and it identifies the computer's features, options and accessories.



Some of the features described in this manual may not function properly if you use an operating system that was not preinstalled by TOSHIBA.

Equipment Checklist

Carefully unpack your computer. Save the box and packaging materials for future use.

Hardware

Check to make sure you have all the following items:

- Satellite C650/Satellite C650D/Satellite Pro C650/Satellite Pro C650D Series Portable Personal Computer
- Battery pack
- AC adaptor and power cord (2-pin plug or 3-pin plug)

Documentation

- *User's Manual*
- *Instruction Manual for Safety and Comfort*

If any of the items are missing or damaged, contact your dealer immediately.

Software

Windows 7

The following software is preinstalled:

- Windows 7
- Display Drivers for Windows
- LAN Driver
- Pointing Device Driver
- Sound Driver for Windows
- Wireless LAN driver
- TOSHIBA Assist
- TOSHIBA ConfigFree
- TOSHIBA Disc Creator
- TOSHIBA DVD PLAYER (Is preinstalled with some models)
- TOSHIBA Face Recognition (Is preinstalled with some models)
- TOSHIBA User's Manual
- TOSHIBA Value Added Package
- TOSHIBA Bulletin Board
- TOSHIBA ReelTime
- TOSHIBA Recovery Media Creator
- TOSHIBA Media Controller

Getting Started



- *All users should be sure to read the section [Starting Up for The First Time](#).*
- *Be sure to read the enclosed Instruction Manual for Safety and Comfort for information on the safe and proper use of this computer. It is intended to help you be more comfortable and productive while using a notebook computer. By following the recommendations in it you may reduce your chance of developing a painful or disabling injury to your hand, arms, shoulders or neck.*

This chapter provides basic information to start using your computer. It covers the following topics:

- Connecting the AC adaptor
- Opening the display
- Turning on the power
- Starting up for the first time
- Turning off the power
- Restarting the computer
- System recovery options

- Restoring the pre-installed software from the Recovery hard disk drive
 - Restoring the pre-installed software from your created Recovery Media
- If you are a new user, follow the steps in each section of this chapter as you prepare to operate your computer



- *Use a virus-check program and make sure it is updated regularly.*
- *Never format storage media without checking its content - formatting destroys all stored data.*
- *It is a good idea to periodically back up the internal hard disk drive or other main storage device to external media. General storage media is not durable or stable over long periods of time and under certain conditions may result in data loss.*
- *Before you install a device or application, save any data in memory to the hard disk drive or other storage media. Failure to do so may result in the loss of data.*

Connecting the AC Adaptor

Attach the AC adaptor when you need to charge the battery or you want to operate from AC power. It is also the fastest way to get started, because the battery pack will need to be charged before you can operate from battery power.

The AC adaptor can be connected to any power source supplying from 100 to 240 volts and 50 or 60 hertz. For details on using the AC adaptor to charge the battery pack, refer to Chapter 6, [Power and Power-up Modes](#).



- *Always use the TOSHIBA AC adaptor that was included with your computer or use AC adaptors specified by TOSHIBA to avoid any risk of fire or other damage to the computer. Use of an incompatible AC adaptor could cause fire or damage to the computer possibly resulting in serious injury. TOSHIBA assumes no liability for any damage caused by use of an incompatible adaptor.*
 - *Never plug the AC adaptor into a power source that does not correspond to both the voltage and the frequency specified on the regulatory label of the unit. Failure to do so could result in a fire or electric shock, possibly resulting in serious injury.*
 - *Always use or purchase power cables that comply with the legal voltage and frequency specifications and requirements in the country of use. Failure to do so could result in a fire or electric shock, possibly resulting in serious injury.*
 - *The supplied power cord conforms to safety rules and regulations in the region the product is bought and should not be used outside this region. For use in other regions, please buy power cords that conform to safety rules and regulations in the particular region.*
 - *Do not use a 3-pin to 2-pin conversion plug.*
 - *When you connect the AC adaptor to the computer, always follow the steps in the exact order as described in the User's Manual. Connecting the power cable to a live electrical outlet should be the last step otherwise the adaptor DC output plug could hold an electrical charge and cause an electrical shock or minor bodily injury when touched. As a general safety precaution, avoid touching any metal parts.*
 - *Never place your computer or AC adaptor on a wooden surface, furniture, or any other surface that could be marred by exposure to heat since the computer base and AC adaptor's surface increase in temperature during normal use.*
 - *Always place your computer or AC adaptor on a flat and hard surface that is resistant to heat damage.*
- Refer to the enclosed Instruction Manual for Safety and Comfort for detailed precautions and handling instructions.*

1. Connect the power cord to the AC adaptor.

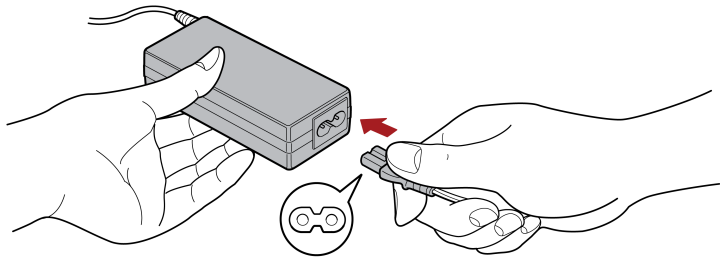

Figure 1-1 Connecting the power cord to the AC adaptor (2-pin plug)

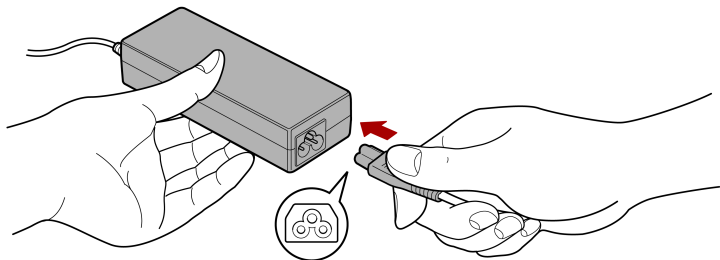

Figure 1-2 Connecting the power cord to the AC adaptor (3-pin plug)



Either a 2-pin or 3-pin adaptor/cord will be included with the computer depending on the model.

2. Connect the AC adaptor's DC output plug to the DC IN 19V jack on the right side of the computer.

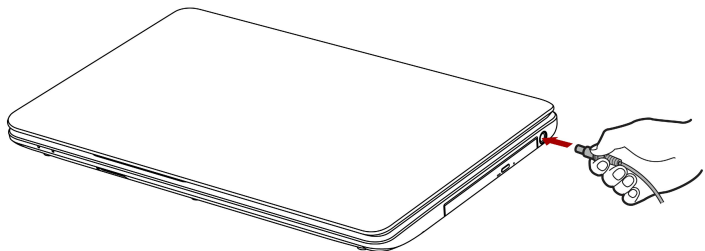

Figure 1-3 Connecting the adaptor to the computer

3. Plug the power cord into a live wall outlet - the **DC IN/Battery** indicator on the front of the computer should glow.

Opening The Display

The display panel can be opened to a wide range of angles for optimal viewing.

While holding down the palm rest with one hand so that the main body of the computer is not raised, slowly lift the display panel - this will allow the angle of the display panel to be adjusted to provide optimum clarity.

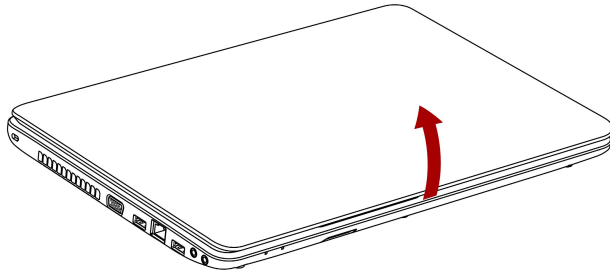

Figure 1-4 Opening the display panel



Use reasonable care when opening and closing the display panel. Opening it vigorously or slamming it shut could damage the computer.



- *Be careful not to open the display panel too far as this could put stress on the display panel's hinges and cause damage.*
- *Do not press or push on the display panel.*
- *Do not lift the computer by the display panel.*
- *Do not close the display panel with pens or any other objects left in between the display panel and the keyboard.*
- *When opening or closing the display panel, place one hand on the palm rest to hold the computer in place and use the other hand to slowly open or close the display panel (Do not use excessive force when opening or closing the display panel).*



Turning On The Power

This section describes how to turn on the power - the **Power** indicator will then indicate the status. Please refer to the [System Indicators](#) section in Chapter 6, [Power and Power-up Modes](#) for more information.



- After you turn on the power for the first time, do not turn it off until you have set up the operating system. Please refer to the section [Starting Up for The First Time](#) for more information.
- Volume cannot be adjusted during Windows Setup.

1. Open the display panel.
2. Press and hold the computer's power button for two or three seconds.

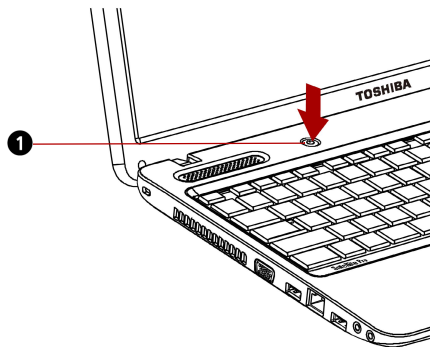

1. POWER BUTTON

Figure 1-5 Turning on the power

Starting Up for The First Time

The Windows 7 Startup Screen will be the first screen displayed when you turn on the power. Follow the on-screen instructions on each screen in order to properly install the operating system.



When it is displayed, be sure to read the Software License Terms carefully.

Turning Off The Power

The power can be turned off in one of three modes, either Shut Down Mode, Hibernation Mode or Sleep Mode.

Shut Down Mode

When you turn off the power in Shut Down Mode no data will be saved and the computer will boot to the operating system's main screen the next time it is turned on.

1. If you have entered data, either save it to the hard disk drive or to other storage media.
2. Make sure all disk/disc activity has stopped before removing the CD/DVD or floppy diskette.



- *Make sure the **Optical Disc Drive** indicator is off. If you turn off the power while a disk (disc) is being accessed, you may lose data or damage the disk.*
- *Never turn off the power while an application is running. Doing so could cause loss of data.*
- *Never turn off the power, disconnect an external storage device or remove storage media during data read/write. Doing so can cause data loss.*

3. Click **Start**.
4. Click the **Shut down** button ().
5. Turn off any peripheral devices connected to your computer.



Do not turn the computer or peripheral devices back on immediately - wait a short period to avoid any potential damage.

Sleep Mode

If you have to interrupt your work, you are able to turn off the power without exiting from your software by placing the computer into Sleep Mode. In this mode data is maintained in the computer's main memory so that when you turn on the power again, you can continue working right where you left off.



When you have to turn off your computer aboard an aircraft or in places where electronic devices are regulated or controlled, always completely shut down the computer. This includes turning off any wireless communication functionalities and cancelling settings that reactivate the computer automatically, such as a timer recording function. Failure to completely shut down the computer in this way could allow the operating system to reactivate and run pre-programmed tasks or preserve unsaved data, which could interfere with aviation or other systems, possibly causing serious injury.



- *Before entering Sleep Mode, be sure to save your data.*
- *Do not install or remove a memory module while the computer is in Sleep Mode. The computer or the memory module could be damaged.*
- *Do not remove the battery pack while the computer is in Sleep Mode (unless the computer is connected to an AC power source). Data in memory will be lost.*



- When the AC adaptor is connected, the computer will go into Sleep Mode according to the settings in the Power Options (to access it, **Start** → **Control Panel** → **System and Security** → **Power Options**).
- To restore the operation of the computer from Sleep Mode, press and hold the power button or any key on the keyboard for a short amount of time. Please note that keyboard keys can only be used if the Wake-up on Keyboard option is enabled within the HW Setup utility.
- If the computer enters Sleep Mode while a network application is active, the application might not be restored when the computer is next turned on and the system returns from Sleep Mode.
- To prevent the computer from automatically entering Sleep Mode, disable Sleep Mode within the Power Options (to access it, **Start** → **Control Panel** → **System and Security** → **Power Options**).
- To use the Hybrid Sleep function, configure it in the Power Options.

Benefits of Sleep Mode

The Sleep Mode feature provides the following benefits:

- Restores the previous working environment more rapidly than does the Hibernation Mode feature.
- Saves power by shutting down the system when the computer receives no input or hardware access for the time period set by the System Sleep Mode feature.
- Allows the use of the panel power off feature.

Executing Sleep Mode



You can also enable Sleep Mode by pressing **FN + F3** - please refer to Chapter 5, [The Keyboard](#), for further details.

You can enter Sleep Mode in one of the following ways:

- Click **Start**, point to the arrow icon () and then select **Sleep** from the menu.
- Close the display panel. Please note that this feature must be enabled within the Power Options (to access it, click **Start** → **Control Panel** → **System and Security** → **Power Options**).
- Press the power button. Please note that this feature must be enabled within the Power Options (to access it, click **Start** → **Control Panel** → **System and Security** → **Power Options**).

When you turn the power back on, you can continue where you left when you shut down the computer.



- *When the computer is shut down in Sleep Mode, the power indicator will blink amber.*
- *If you are operating the computer on battery power, you can lengthen the overall operating time by turning it off into Hibernation Mode - Sleep Mode will consume more power while the computer is off.*

Sleep Mode limitations

Sleep Mode will not function under the following conditions:

- Power is turned back on immediately after shutting down.
- Memory circuits are exposed to static electricity or electrical noise.

Hibernation Mode

The Hibernation Mode feature saves the contents of memory to the hard disk drive when the computer is turned off so that, the next time it is turned on, the previous state is restored. Please note that the Hibernation Mode feature does not save the status of any peripheral devices connected to the computer.



- *Save your data. While entering Hibernation Mode, the computer saves the contents of memory to the hard disk drive. However, for safety sake, it is best to save your data manually.*
- *Data will be lost if you remove the battery or disconnect the AC adaptor before the save is completed. Wait for the **Optical Disc Drive** indicator to go out.*
- *Do not install or remove a memory module while the computer is in Hibernation Mode. Data will be lost.*

Benefits of Hibernation Mode

The Hibernation Mode feature provides the following benefits:

- Saves data to the hard disk drive when the computer automatically shuts down because of a low battery condition.
- You can return to your previous working environment immediately when you turn on the computer.
- Saves power by shutting down the system when the computer receives no input or hardware access for the time period set by the System Hibernate feature.
- Allows the use of the panel power off feature.

Starting Hibernation Mode



You can also enable Hibernation Mode by pressing **FN + F4** - please refer to Chapter 5, *The Keyboard*, for further details.

To enter Hibernation Mode, follow the steps below.

1. Click **Start**.
2. Point to the arrow icon () and then select **Hibernate** from the menu.

Automatic Hibernation Mode

The computer can be configured to enter Hibernation Mode automatically when you press the power button or close the lid. In order to define these settings, you can follow the steps as described below:

1. Click **Start** and click the **Control Panel**.
2. Click **System and Security** and click **Power Options**.
3. Click **Choose what the power buttons do** or **Choose what closing the lid does**.
4. Enable the desired Hibernation Mode settings for **When I press the power button** and **When I close the lid**.
5. Click the **Save changes** button.

Data Save in Hibernation Mode

When you turn off the power in Hibernation Mode, the computer will take a moment to save the current data in memory to the hard disk drive.

After you turn off the computer, and the content of memory has been saved to the hard disk drive, turn off the power to any peripheral devices.



Do not turn the computer or devices back on immediately. Wait a moment to let all capacitors fully discharge.

Restarting The Computer

Certain conditions require that you reset the computer, for example, if:

- You change certain computer settings.
- An error occurs and the computer does not respond to your keyboard commands.

If you need to restart the computer, there are three ways this can be achieved:

- Click **Start**, point to the arrow icon() and then select **Restart** from the menu.
- Press **CTRL, ALT** and **DEL** simultaneously (once) to display the menu window, then select **Restart** from the **Shut down options**.

- Press the power button and hold it down for five seconds. Once the computer has turned itself off, wait between ten and fifteen seconds before turning the power on again by pressing the power button.

System Recovery Options

There is a hidden partition allocated on the hard disk drive for the System Recovery Options.

This partition stores files which can be used to repair the system in the event of a problem.



The System Recovery Options feature will be unusable if this partition is deleted.

System Recovery Options

The System Recovery Options feature is installed on the hard disk when shipped from the factory. The System Recovery Options menu includes tools to repair startup problems, run diagnostics or restore the system.

See the **Windows Help and Support** content for more information about **Startup Repair**.

The System Recovery Options can also be run manually to repair problems.

The procedure is as follows. Follow the instructions shown on the on-screen menu.

1. Turn off the computer.
2. While holding the **F8** key, turn on the computer.
3. The Advanced **Boot Options** menu will be displayed. Use the arrow keys to select **Repair Your Computer** and press **ENTER**.
4. Follow the on-screen instructions.



Check your Windows manual for more information on backing up your system (including the system image backup feature).

System Recovery

This section describes the creation of Recovery Media and their use.

Creating Recovery Media

This section describes how to create Recovery Media.



- *Be sure to connect the AC adaptor when you create Recovery Media.*
- *Be sure to close all other software programs except the Recovery Media Creator.*
- *Do not run software such as screen savers which can put a heavy load on the CPU.*
- *Operate the computer at full power.*
- *Do not use power-saving features.*
- *Do not write to the media when the virus check software is running. Wait for it to finish, then disable virus detection programs including any software that checks files automatically in the background.*
- *Do not use utilities, including those intended to enhance hard disk drive access speed. They may cause unstable operation and damage data.*
- *Do not shut down/log off or Sleep/Hibernate while writing or rewriting the media.*
- *Set the computer on a level surface and avoid places subjected to vibrations such as airplanes, trains, or cars.*
- *Do not use on an unstable surface such as a stand.*

A recovery image of the software on your computer is stored on the hard disk drive, and can be copied to either DVD or USB Flash Memory by using the following steps:

1. Select either blank DVD or USB Flash Memory.

The application will allow you to choose from a variety of different media onto which the recovery image can be copied including DVD-R, DVD-R DL, DVD-RW, DVD+R, DVD+R DL, DVD+RW and USB Flash Memory.



- *Please note that some of the above media may not be compatible with the optical disc drive installed into your computer. You should therefore verify the optical disc drive supports the blank media you have chosen before proceeding.*
- *USB Flash Memory will be formatted and all the data in the USB Flash Memory will be lost when proceeding.*

2. Turn on your computer and allow it to load the Windows 7 operating system from the hard disk drive as normal.
3. Insert the media into the computer.
 - Insert the first blank disc into the optical disc drive tray, or insert the USB Flash Memory into one available USB port.

4. Double click the **Recovery Media Creator** icon on the Windows 7 desktop, or select the application from **Start Menu**.
5. After Recovery Media Creator starts, select the type of media and the title you wish to copy, and then click the **Create** button.

Restoring the pre-installed software from the Recovery hard disk drive

A portion of the total hard disk drive space is configured as a hidden recovery partition. This partition stores files which can be used to restore pre-installed software in the event of a problem.

If you subsequently set up your hard disk drive again, do not change, delete or add partitions in a manner other than specified in the manual, otherwise you may find that space for the required software is not available.

In addition, if you use a third-party partitioning program to reconfigure the partitions on your hard disk drive, you may find that it becomes impossible to setup your computer.



*When the sound mute feature has been activated by pressing the **FN + ESC** key, be sure to disable this to allow sounds to be heard before starting the restore process. Please refer to Chapter 5, [The Keyboard](#), for further details.*

You can not use System Recovery Options if restoring the pre-installed software without System Recovery Options.



When you reinstall the Windows operating system, the hard disk will be reformatted and all data will be lost.

1. Turn off your computer.
2. While holding down **0** (zero) key on the keyboard, turn on your computer.
3. A menu will be displayed from which you should follow the on-screen instructions.

Restoring the pre-installed software from your created Recovery Media

If the pre-installed files are damaged, you are able to either use the Recovery Media you have created or the hard disk drive recovery process to restore the computer to the state it was in when you originally received it. To perform this restoration, follow the steps below:



*When the sound mute feature has been activated by pressing the **FN + ESC** key, be sure to disable this to allow sounds to be heard before starting the restore process. Please refer to Chapter 5, [The Keyboard](#), for further details.*

You can not use System Recovery Options if restoring the pre-installed software without System Recovery Options.



When you reinstall the Windows operating system, the hard disk will be reformatted and all data will be lost.

1. Load the Recovery Media into the computer and turn off the computer's power.
2. While holding down **F12** key on the keyboard, turn on your computer - when the TOSHIBA Leading Innovation>>> logo screen appears, release the **F12** key.
3. Use the up and down cursor key to select the appropriate option from the menu according to your actual recovery media. Please refer to the [Boot Priority](#) section in Chapter 7, [HW Setup and Passwords](#) for further information.
4. A menu will be displayed from which you should follow the on-screen instructions



*When drivers/utilities are installed, you can setup the respective drivers/utilities from the following place. To open the setup files, Click **Start** → **All Programs** → **TOSHIBA** → **Applications and Drivers**.*

Chapter 2

The Grand Tour

This chapter identifies the various components of your computer. Become familiar with each component before you operate the computer.

Front with The Display Closed

Figure 2-1 shows the computer's front with its display panel in the closed position.



1. BRIDGE MEDIA SLOT

Figure 2-1 Front of the computer with display closed

Bridge media slot



This slot allows you to easily transfer data from devices, such as digital camera and PDA, that use flash memory (Secure Digital (SD)/Secure Digital High Capacity (SDHC)/Secure Digital Extended Capacity (SDXC) /MultiMediaCard (MMC)).

Left Side

Figure 2-2 shows the computer's left side.

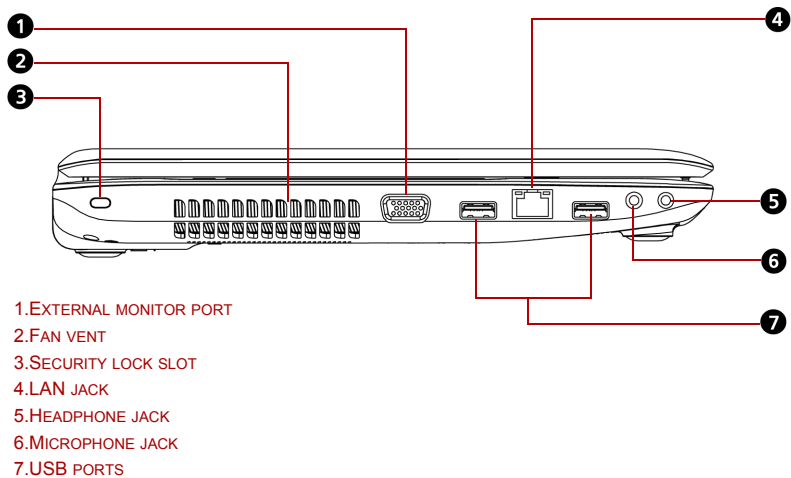

Figure 2-2 The left side of the computer

External monitor port

This 15-pin port allows you to connect an external monitor.



Fan vent

Provides air flow for the fan.



Be careful not to block the fan vent. Also be careful to keep foreign objects out of the vents. A pin or similar object can damage the computer's circuitry.

Security lock slot

A security cable attaches to this slot. The optional security cable anchors your computer to a desk or other large object to deter theft.

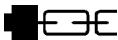

LAN jack

This jack allows you to connect to a LAN. The adaptor has built-in support for Fast Ethernet (10BASE-T/100BASE-TX).
 See Chapter 4, [Operating Basics](#), for details.





- *Do not connect any cable other than a LAN cable to the LAN jack. It could cause damage or malfunction.*
- *Do not connect the LAN cable to a power supply. It could cause damage or malfunction.*

Headphone jack

A standard 3.5 mm mini headphone jack enables connection of a stereo headphone (16 ohm minimum) or other device for audio output. When you connect headphones, the internal speaker is automatically disabled.

Microphone jack

A standard 3.5 mm mini microphone jack enables connection of a microphone or other device for audio input.

Universal serial bus (USB 2.0) ports

Two universal serial bus (USB) ports comply with USB 2.0 standards, which enable data transfer speeds 40 times faster than the USB 1.1 standards.



Keep foreign objects out of the USB connectors. A pin or similar object can damage the computer's circuitry.



Operation of all functions of all USB devices has not been confirmed. Some functions might not execute properly.

Right Side

Figure 2-3 shows the computer's right side.

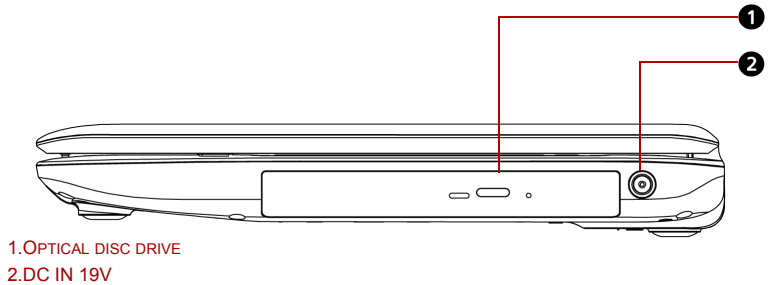

Figure 2-3 The right side of the computer

Optical disc drive

A DVD Super Multi (\pm R DL) drive.

DC IN 19V



The AC adaptor connects to this socket. Use only the model of AC adaptor that comes with the computer. Using the wrong adaptor can damage your computer.

Back Side

Figure 2-4 shows the computer's back side.

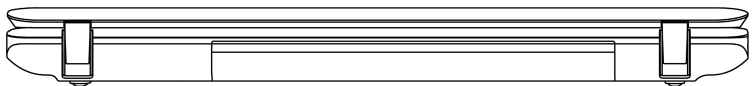
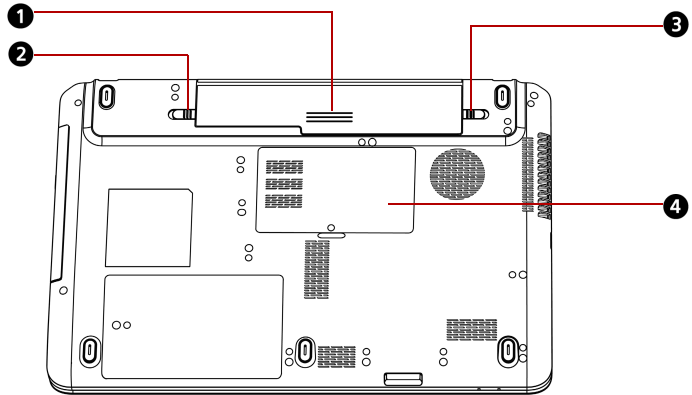

Figure 2-4 The computer's back side

Underside

Figure 2-5 shows the underside of the computer. Make sure the display is closed before turning over your computer.



1. BATTERY PACK
2. BATTERY PACK LOCK
3. BATTERY RELEASE LATCH
4. MEMORY MODULE COVER

Figure 2-5 The underside of the computer

Battery pack

The battery pack powers the computer when the AC adaptor is not connected. The Batteries section in Chapter 6, [Power and Power-up Modes](#), describes how to access the battery pack. Additional battery packs can be purchased from your TOSHIBA dealer to extend the computer's battery operating time.

Battery pack lock

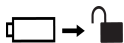

Slide the battery pack lock to unlocked position to free the battery release latch.

Battery release latch



Slide this latch to release the battery pack. This latch moves only when the computer is upside down.

Memory module cover



This cover protects two memory module sockets. One or two modules are preinstalled.

Front with The Display Open

Figure 2-6 shows the front of the computer with the display open. To open the display, lift the display up and position the display at a comfortable viewing angle.

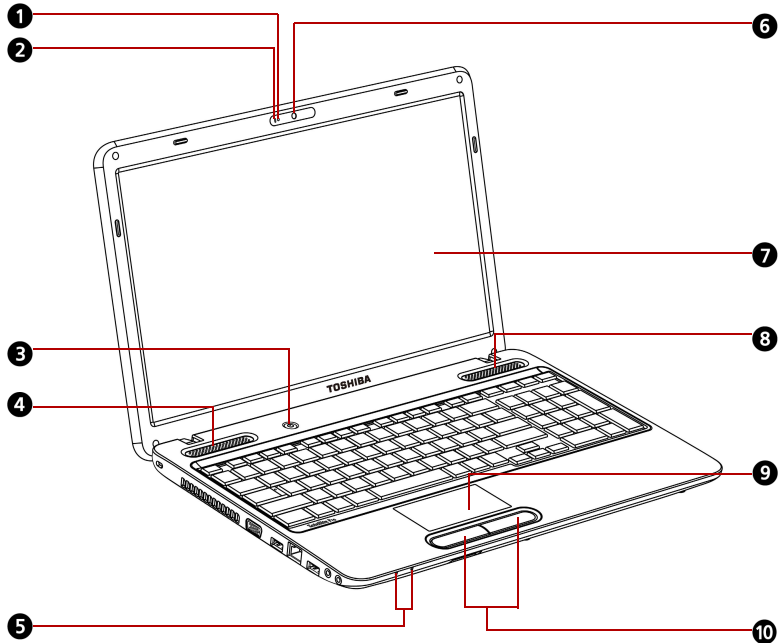

- | | |
|-------------------------|-----------------------------|
| 1.WEB CAMERA LED* | 6.WEB CAMERA* |
| 2.BUILT-IN MICROPHONE* | 7.DISPLAY SCREEN |
| 3.POWER BUTTON | 8.STEREO SPEAKER (RIGHT) |
| 4.STEREO SPEAKER (LEFT) | 9.TOUCHPAD |
| 5.SYSTEM INDICATORS | 10.TOUCHPAD CONTROL BUTTONS |

*PROVIDED WITH SOME MODELS.

Figure 2-6 The front with the display open

Web camera LED	The web camera LED glows blue when the web camera software is used. (Provided with some models)
Built-in microphone	Records monaural sounds into your applications. (Provided with some models)

Power button 	Press the power button to turn the computer's power on and off. The Power indicator indicates the status.
Stereo speaker	The speaker emits sound generated by your software as well as audio alarms, such as low battery condition, generated by the system.
System indicators	Two LEDs allow you to monitor the DC IN, Battery charge and power status. Refer to the System Indicators section in this chapter.
Web camera	Record/Send still or video images with this integrated web camera. (Provided with some models)
Display screen	Please be aware that, when the computer is operating on the AC adaptor, the image displayed on the internal screen will be somewhat brighter than when it operates on battery power. This difference in brightness levels is intended to save power when operating on batteries. For more information on the computer's display, please refer to the Display Controller and Video Mode section in Appendix B.
Touchpad	Moves the pointer and selects or activates items on the screen. Can be set to perform other mouse functions, such as scrolling, selecting, and double-clicking.
Touchpad control buttons	Function like the left and right buttons on an external mouse.



Please handle your computer carefully to avoid scratching or damaging the surface.

System Indicators

Figure 2-7 shows the system indicators, which light when various computer operations are in progress.

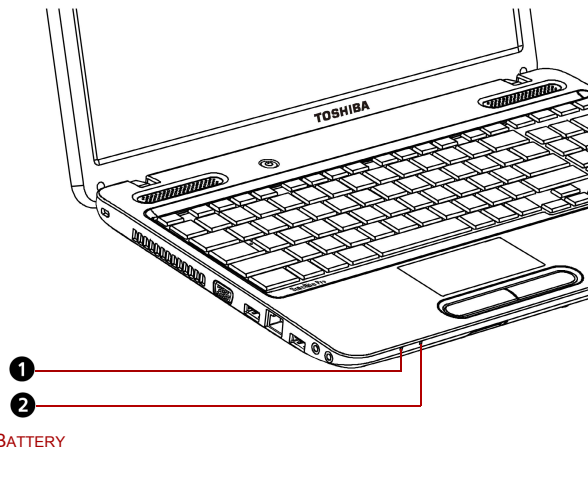
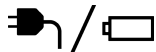

Figure 2-7 System indicators

DC IN/Battery



The **DC IN/Battery** indicator shows the condition of the charge. Green means fully charged and glows amber means being charged. During critical low battery, the indicator will blink amber. Refer to Chapter 6, [Power and Power-up Modes](#).

Power



The **Power** indicator glows green when the computer is on. If you turn off the computer in Sleep Mode, this indicator blinks green. If the computer shuts down, this indicator shows no light.

Keyboard Indicators

The figure below shows the position of the **CAPS LOCK** indicator and the **NUM LOCK** indicator which show the following conditions:

- When the **CAPS LOCK** indicator glows, the keyboard is in all-caps mode.
- When the **NUM LOCK** indicator glows, the ten key allows you to enter numbers.

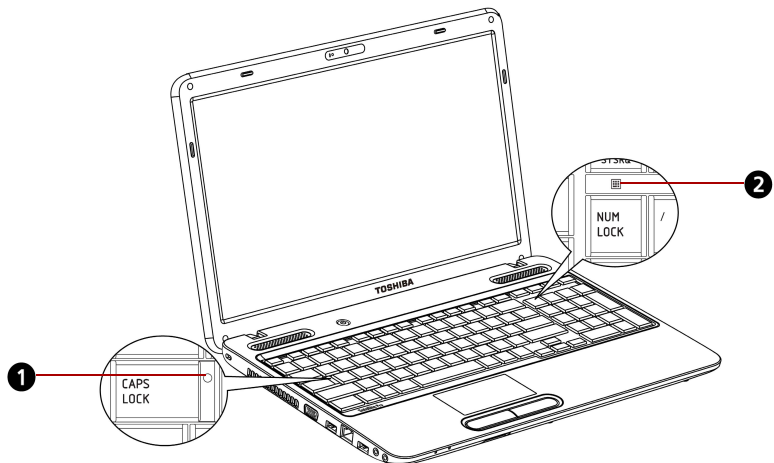

1. CAPS LOCK INDICATOR
2. NUM LOCK INDICATOR

Figure 2-8 Keyboard indicators

CAPS LOCK

This indicator glows green when letter keys are locked into their uppercase format.

NUM LOCK

When the NUM LOCK indicator glows, you can use the number keys on the keyboard for number entry.



Optical Disc Drive

The computer is equipped with a DVD Super Multi (±R DL) drive.

Region Codes for DVD Drives and Media

DVD

DVD drive and their media are manufactured according to the specifications of six marketing regions. When you purchase DVD-Video, make sure it matches your drive, otherwise it will not play properly.

Code	Region
1	Canada, United States
2	Japan, Europe, South Africa, Middle East
3	Southeast Asia, East Asia
4	Australia, New Zealand, Pacific Islands, Central America, South America, Caribbean
5	Russia, Indian Subcontinent, Africa, North Korea, Mongolia
6	China

Writable Discs

This section describes the types of writable CD/DVD discs. Check the specifications of your drive to for the type of discs it can write. Use TOSHIBA Disc Creator to write compact discs. Refer to Chapter 4, [Operating Basics](#).

CDs

- CD-R discs can be written only once. The recorded data cannot be erased or changed.
- CD-RW discs can be recorded more than once.

DVDs

- DVD-R, DVD+R, DVD-R DL and DVD+R DL discs can be written only once. The recorded data cannot be erased or changed.
- DVD-RW, DVD+RW and DVD-RAM discs can be recorded more than once.

DVD Super Multi (± R DL) Drive

The full-size DVD Super Multi drive (±R DL) module allows you to record data to rewritable CD/DVDs as well as run either 12cm (4.72") or 8cm (3.15") CD/DVDs without using an adapter.



The read speed is slower at the center of a disc and faster at the outer edge.

DVD read	8 speed (maximum)
DVD-R write	8 speed (maximum)
DVD-RW write	6 speed (maximum)
DVD+R write	8 speed (maximum)
DVD+RW write	8 speed (maximum)
DVD+R DL write	6 speed (maximum)
DVD-R DL write	6 speed (maximum)
DVD-RAM write	5 speed (maximum)
CD read	24 speed (maximum)
CD-R write	24 speed (maximum)
CD-RW write	24 speed (maximum, Ultra-speed media)

AC Adaptor

The AC adaptor converts AC power to DC power and reduces the voltage supplied to the computer. It can automatically adjust to any voltage from 100 to 240 volts and to a frequency of either 50 or 60 hertz, enabling you to use the computer in almost any region.

To recharge the battery, simply connect the AC adaptor to a power source and the computer. See Chapter 6 [Power and Power-up Modes](#) for details.

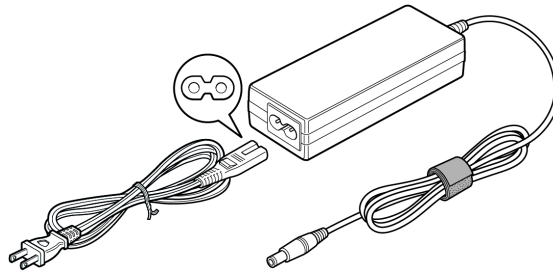

Figure 2-9 The AC adaptor (2-pin plug)

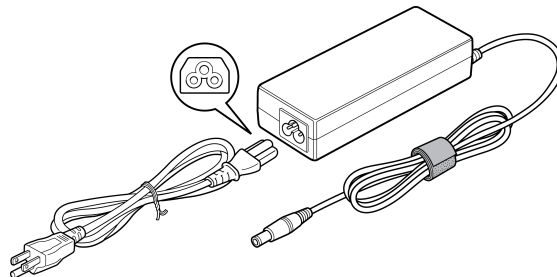

Figure 2-10 The AC adaptor (3-pin plug)



- Depending on the model in question, either a 2-pin or 3-pin adaptor/power lead will be bundled with the computer.
- Do not use a 3-pin to 2-pin conversion plug.
- The supplied power cord conforms to safety rules and regulations in the region the product is bought and should not be used outside of this region. In order to use the adaptor/computer in other regions, you should please buy a power cord that conforms to the safety rules and regulations in that particular region.



Always use the TOSHIBA AC adaptor that was included with your computer, or use AC adaptors specified by TOSHIBA to avoid any risk of fire or other damage to the computer. Use of an incompatible AC adaptor could cause fire or damage to the computer possibly resulting in serious injury. TOSHIBA assumes no liability for any damage caused by use of an incompatible adaptor.

Chapter 3

Hardware, Utilities and Options

Hardware

This section describes the hardware of your computer.

The actual specifications may vary depending on the model you purchased.

Processor*1

Built-in

Your computer is equipped with one processor and processor type varies depending on model. To check which type of processor is included in your model, open the TOSHIBA PC Diagnostic Tool Utility by clicking **Start** → **All Programs** → **TOSHIBA** → **Utilities** → **PC Diagnostic Tool**.

Memory*2

Slots

PC2-6400, PC3-8500 1 GB, 2 GB or 4 GB memory modules can be installed in the two memory slots.

- Maximum size of memory can be installed on Mobile Intel® GL40 Express Chipset models is 4 GB.
 - Maximum system memory size and speed are depending on the model you purchased.
-

Video RAM*6

Depending on the model you purchased.

Mobile Intel® GM45 Express Chipset model/
Mobile Intel® GL40 Express Chipset mode/
Mobile Intel® HM55 Express Chipset model:
Video RAM capacity shares with main memory,
and the proportion depends on Dynamic Video
Memory Technology.

AMD M880G Chipset model:
Video RAM capacity shares with main memory,
and the proportion depends on ATI
HyperMemory™.

Disks**Hard Disk Drive
(HDD)***4

The computer is equipped with a Hard Disk Drive
(HDD) for nonvolatile storage of data and
software.(Depending on the model you
purchased)

- HDD
 - 250 GB
 - 320 GB
 - 500 GB

Please note that part of the hard disk drive's
overall capacity is reserved as administration
space.

DVD Super Multi (±R DL) Drive

Some models are equipped with a full-size DVD Super Multi (± R DL) drive module that allows you to record data to rewritable CD/DVDs as well as run CD/DVDs without using an adaptor. It reads DVD-ROMs at maximum 8 speed and CD-ROMs at maximum 24 speed. It writes CD-R at up to 24 speed, CD-RW at up to 24 speed, DVD-R at up to 8 speed, DVD-RW at up to 6 speed, DVD-RAM at up to 5 speed, DVD+R at up to 8 speed, DVD+RW at up to 8 speed, DVD+R DL at up to 6 speed and DVD-R DL at up to 6 speed. This drive supports the following formats:

- DVD-ROM
 - DVD-Video
 - DVD-R
 - DVD-RW
 - DVD+R
 - DVD+RW
 - DVD-RAM
 - DVD+R DL
 - DVD-R DL
 - CD-DA
 - CD-Text
 - CD-R
 - CD-RW
 - CD-ROM Mode 1, Mode 2
 - CD-ROM XA Mode 2 (Form1, Form2)
 - CD-G (Audio CD only)
 - Photo CD (single/multi-session)
 - Enhanced CD (CD-EXTRA)
 - Addressing Method 2
-

Display

The computer's internal display panel supports high-resolution video graphics and can be set to a wide range of viewing angles for maximum comfort and readability.

Display panel *5

39.6cm (15.6") TFT LCD screen, 16 million colors, with the following resolution:

- HD, 1366 horizontal x 768 vertical pixels
-

Display Power Saving Technology

Your model may include the Display Power Saving Technology feature that can save the computer's power consumption by optimizing picture contrast on the internal LCD. This feature can be used if the computer is:

- configured with Mobile Intel® GM45 Express Chipset model in graphic chip by Intel® or Mobile Intel® HM55 Express Chipset model in graphic chip by Intel®*
- running under battery mode
- using the internal LCD display only

The Display Power Saving Technology feature can be enabled in the Intel® Graphics and Media Control Panel.

To access this control panel in one of the following ways:

- Click **Start** → **Control Panel**. Select **Large icons** or **Small icons** in **View by**, and then click **Intel® Graphics and Media**.
- Right-click on the desktop and click **Graphics Properties...**

In this control panel,

1. Click **Power** and then click **Power Features**.
2. Select **On battery** from the drop-down menu in **Graphics Power Plan Settings** and then select the **Display Power Saving Technology** check box.

If you want to improve the picture quality under the conditions mentioned above, adjust the setting towards Maximum Quality or disable this feature.

*Please visit your region's web site or refer to the catalog for the configuration details of the model that you have purchased.

AMD® Vari-Bright™

Your model may include the AMD® Vari-Bright™ feature that can save the computer's power consumption by optimizing picture contrast on the internal LCD. This feature can be used if the computer is:

- running under battery mode.
- using the internal LCD display only



The power and performance settings can be adjusted in the Catalyst Control Center. To access this utility, go to

Start → **All Programs** → **Catalyst Control Center** → **CCC - Advanced** → **Enable Vari-Bright™**

If you want to improve the picture quality under the conditions mentioned above, adjust the setting towards Maximum Quality or disable this feature.

Keyboard

Built-in

104 keys or 105 keys, dedicated cursor control,  and  keys. See Chapter 5, [The Keyboard](#), for details.

Pointing Device

Built-in	A touchpad and control buttons in the palm rest enable control of the on-screen pointer.
-----------------	--

Power

Battery pack *3	The computer is powered by one rechargeable lithium-ion battery pack.
RTC battery	The internal RTC battery backs up the Real Time Clock (RTC) and calendar.
AC adaptor	The universal AC adaptor provides power to the system and recharges the batteries when they are low. It comes with a detachable power cord. Because it is universal, it can receive a range of AC voltage between 100 and 240 volts.

Ports

Headphone	Enables connection of a stereo headphone.
Microphone	Enables connection of a microphone.
External monitor	15-pin, analog VGA port.
Universal Serial Bus (USB 2.0) ports	Two Universal Serial Bus (USB) enable a chain connection of USB-equipped devices to your computer through the ports.

Slots

Bridge media slot	This slot allows you to easily transfer data from devices, such as digital cameras and Personal Digital Assistants, that use flash memory (Secure Digital (SD)/Secure Digital High Capacity (SDHC)/Secure Digital Extended Capacity (SDXC)/MultiMediaCard (MMC)). see Bridge Media Slot in this Chapter for details.
--------------------------	--

Multimedia

Web camera	Record/Send still or video images with this integrated web camera. (Provided with some models)
Sound system	Windows Sound System compatible sound system provides internal speaker as well as jacks for an external microphone and headphone.

Communications

LAN	The computer has built-in support for Fast Ethernet (10BASE-T/100BASE-TX). It is preinstalled as a standard device in some markets.
Wireless LAN*7	A Wireless LAN PCI Express Mini Card is equipped with other LAN systems based on Direct Sequence Spread Spectrum/Orthogonal Frequency Division Multiplexing radio technology that complies with the IEEE 802.11 Standard (Revision B, G and N). Roaming over multiple channels.

Security

Security lock slot	Connects a security lock to anchor the computer to a desk or other large object.
---------------------------	--

Software

Operating system	Windows 7 is available. Refer to the preinstalled Software section at the Chapter 1, Getting Started .
TOSHIBA Utilities	A number of utilities and drivers are preinstalled to make your computer more convenient to use. Refer to the TOSHIBA Value Added Package and Utilities and Applications sections in this chapter.
Plug and Play	When you connect an external device to the computer or when you install a component, Plug and Play capability enables the system to recognize the connection and make the necessary configurations automatically.

Special Features

The following features are either unique to TOSHIBA computers or are advanced features which make the computer more convenient to use. To access the Power Options, click **Start** → **Control Panel** → **System and Maintenance** → **Power Options**.

Hot keys	Key combinations allow you to quickly modify the system configuration directly from the keyboard without running a system configuration program.
Display automatic power off	This feature automatically cuts off power to the internal display when there is no keyboard input for a time specified. Power is restored when any key is pressed. This can be specified in the Power Options.
HDD automatic power off	This feature automatically cuts off power to the hard disk drive when it is not accessed for a time specified. Power is restored when the hard disk is accessed. This can be specified in the Power Options.
System automatic sleep/hibernation	This feature automatically shuts down the system in Sleep Mode or Hibernation Mode when there is no input or hardware access for a time specified. This can be specified in the Power Options.
Power-on password	Two levels of password security, supervisor and user, are available to prevent unauthorized access to your computer.
Instant security	A hot key function blanks the screen and disables the computer providing data security.
Intelligent power supply	A microprocessor in the computer's intelligent power supply detects the battery's charge and calculates the remaining battery capacity. It also protects electronic components from abnormal conditions, such as voltage overload from an AC adaptor. This can be specified in the Power Options.
Battery save mode	This feature allows you to configure the computer in order to save battery power. This can be specified in the Power Options.

Panel power on/off	This feature turns power to the computer off when the display panel is closed and turns it back on when the panel is opened. This can be specified in the Power Options.
Low battery automatic Hibernation Mode	When battery power is exhausted to the point that computer operation cannot be continued, the system automatically enters hibernation and shuts down. This can be specified in the Power Options.
Heat dispersal	To protect from overheating, the CPU has an internal temperature sensor. If the computer's internal temperature rises to a certain level, the cooling fan is turned on or the processing speed is lowered. This can be specified in the Power Options.
Maximum Performance	Turns on fan first, then if necessary lowers CPU processing speed.
Battery Optimized	Turns on fan first, if necessary lowers CPU processing speed earlier than at Maximum Performance Mode for long battery life.
Hibernation	This feature allows you to turn off the power without exiting from your software. The contents of main memory are saved to the hard disk, when you turn on the power again, you can continue working right where you left off. Refer to the Turning Off The Power section in Chapter 1, Getting Started , for details.
Sleep	If you have to interrupt your work, you can turn off the power without exiting from your software. Data is maintained in the computer's main memory. When you turn on the power again, you can continue working right where you left off.

TOSHIBA Value Added Package

This section describes the TOSHIBA Component features preinstalled on the computer.

TOSHIBA Power Saver	TOSHIBA Power Saver provides you with the features of more various power supply managements.
TOSHIBA Zooming Utility	This utility allows you to enlarge or reduce the icon size on the Windows Desktop, or the zoom factor associated with specific supported applications.
TOSHIBA PC Diagnostic Tool	The TOSHIBA PC Diagnostic Tool will display basic system configuration information and allow the functionality of some of the computer's built-in hardware devices to be tested.
TOSHIBA Flash Cards	This utility supports the following functions. <ul style="list-style-type: none">■ Hot key function■ TOSHIBA utility launcher function
TOSHIBA Accessibility	The TOSHIBA Accessibility utility provides support to movement impaired users when they need to use the TOSHIBA hot key functions. In use, the utility allows you to make the FN key, "sticky" that is you can press it once, release it, and then press one of the " F " keys in order to access its specific function. When set, the FN key will remain active until another key is pressed.

Utilities and Applications

This section describes preinstalled utilities and tells how to start them. For details on operation, refer to each utility's online manual, help files or readme.txt files

TOSHIBA Assist	TOSHIBA Assist is a graphical user interface that provides access to specific tools, utilities and applications that make the use and configuration of the computer easier.
HW Setup utility	To start the utility, click the Windows Start button, point to All Programs , click TOSHIBA , click Utilities , and select HWSSetup icon.
TOSHIBA DVD PLAYER	This software is provided for playback of DVD-Video. (Is preinstalled with some models) To start this utility, click Start → All Programs → TOSHIBA DVD PLAYER → TOSHIBA DVD PLAYER .
TOSHIBA Disc Creator	You can create CD/DVDs in several formats including audio CDs that can be played on a standard stereo CD player and data CD/DVDs to store the files and folders on your hard disk drive. This software can be used on a model with DVD Super Multi (± R DL) drive. You can boot TOSHIBA Disc Creator from the menu bar as follows. Start → All Programs → TOSHIBA → CD&DVD Applications → Disc Creator
TOSHIBA DVD-RAM utility	TOSHIBA DVD-RAM Utility has the function of Physical Format and Write-Protect to DVD-RAM. This utility is contained the setup module of TOSHIBA Disc Creator. You can boot TOSHIBA DVD-RAM Utility from the menu bar as follows. Start → All Programs → TOSHIBA → CD&DVD Applications → DVD-RAM Utility
TOSHIBA ConfigFree	ConfigFree is a suite of utilities to allow easy control of communication devices and network connections. ConfigFree also allows you to find communication problems and create profiles for easy switching between location and communication networks. You can boot ConfigFree from the menu bar as follows. Start → All Programs → TOSHIBA → ConfigFree

TOSHIBA Media Controller	<p>This application allows you to control your music, pictures and videos by streaming content to any compatible device in your home.</p> <p>To access this utility,click Start →All Programs→ TOSHIBA → TOSHIBA Media Controller → TOSHIBA Media Controller.</p> <p>For more information, please refer to the TOSHIBA Media Controller Help.</p>
TOSHIBA Face Recognition	<p>TOSHIBA Face Recognition uses a face verification library to verify the face data of users when they log in to Windows. If the verification is successful, the user will be logged into Windows automatically. The user can thus avoid having to enter a password or the like, which makes the login process easier.(Is preinstalled with some models)</p>
TOSHIBA HDD/SSD Alert	<p>The TOSHIBA HDD/SSD Alert includes wizard functions to monitor the Disk Drive operating status and execute system backup.</p>
TOSHIBA Service Station	<p>This application allows your computer to automatically search for TOSHIBA software updates or other alerts from TOSHIBA that are specific to your computer system and its programs. When enabled, this application periodically transmits to our servers a limited amount of system information, which will be treated in strict accordance with the rules and regulations as well as applicable data protection law.</p> <p>To access this utility, click Start→All Programs→ TOSHIBA → Utilities → Service Station</p>
TOSHIBA Bulletin Board	<p>Bulletin Board is a convenient place to pin things to visually organize in a fun and creative way. Simply drag and drop your favorite pictures, files or notes to pin them on the Board. You can use it to create thumbnail shortcuts, reminders, to-do list and so on according to your personal style.</p> <p>To access this utility, click Start→All Programs→ TOSHIBA → TOSHIBA Bulletin Board</p>
TOSHIBA ReelTime	<p>This application is a graphical history/indexing tool that enables you to view recently accessed files in a fun and easy-to-use format. View and scroll through your history of opened or imported files via thumbnails in an intuitive user interface.</p> <p>To access this utility, click Start→All Programs→ TOSHIBA → TOSHIBA ReelTime</p>

Options

You can add a number of options to make your computer even more powerful and convenient to use. The following options are available:

Memory expansion	<p>Two memory expansion slots are available for installing PC2-6400, PC3-8500 1 GB, 2 GB or 4 GB memory modules of all models.</p> <ul style="list-style-type: none"> ■ Maximum size of memory can be installed on Mobile Intel® GL40 Express Chipset models is 4 GB. ■ Maximum system memory size and speed are depending on the model you purchased.
Battery Pack	<p>An additional battery pack 3 cell type and 6 cell type can be purchased from your TOSHIBA dealer. The battery pack is identical to the one that came with your computer. Use it as a spare or replacement.</p>
AC adaptor	<p>If you use your computer at more than one site, it may be convenient to purchase an additional AC adaptor for each site so you will not have to carry the adaptor with you.</p>
USB FDD kit	<p>The USB floppy disk drive accommodates either a 1.44 MB or 720 KB floppy disk through connection to one of the computer's USB ports. In use, please be aware that, while you cannot format 720 KB floppy disks under Windows 7, you are able to read and write to disks that have already been formatted.</p>
Security lock	<p>A slot is available to attach a security cable to the computer to deter theft.</p>

Optional Devices

Optional devices can expand the computer's capabilities and its versatility. The following optional devices are available from your TOSHIBA dealer:

Cards/Memory

- Memory cards: Secure Digital (SD), Secure Digital High Capacity (SDHC), Secure Digital Extended Capacity (SDXC) and MultiMediaCard (MMC)
- Memory expansion

Power Devices

- Additional battery pack (3 cell and 6 cell)
- Additional AC adaptor

Peripheral Devices

- USB FDD Kit
- External monitor

Other

- Security lock

Bridge Media Slot

The computer is equipped with a Bridge media slot that can accommodate some kinds of memory media with various memory capacities so that you can easily transfer data from devices, such as digital cameras and Personal Digital Assistants.



Keep foreign objects out of the Bridge media slot. Never allow metal objects, such as screws, staples and paper clips, to enter the computer or Keyboard. Foreign metal objects can create a short circuit, which can cause computer damage and fire, possibly resulting in serious injury.



- *This Bridge media slot supports the following memory media.*
 - *Secure Digital (SD) Card (SD memory card, SDHC memory card, SDXC memory card, miniSD Card and microSD card)*
 - *MultiMediaCard (MMC™)*
- *Please note that an adaptor is required to use miniSD/microSD Card.*
- *Please note that not all memory media have been tested and verified to work correctly. Therefore, it is not possible to guarantee that all memory media will operate properly.*

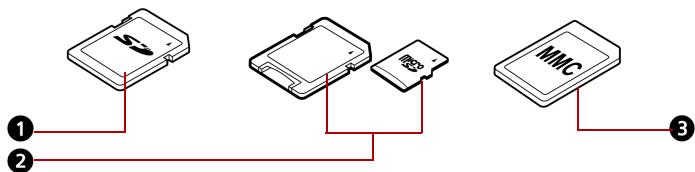

1. SECURE DIGITAL (SD) CARD
2. MICROSD CARD AND ADAPTOR
3. MULTIMEDIA CARD (MMC)

Figure 3-1 Examples of memory media

Memory Media

This section provides the important safety precautions in order to handle your memory media.

Points to Note About the SD/SDHC/SDXC Memory Card

SD/SDHC/SDXC memory cards comply with SDMI (Secure Digital Music Initiative), which is a technology adopted to prevent unlawful copy or playback of digital music. For this reason, you cannot copy or playback protected material on another computer or other device, and you may not reproduce any copyrighted material except for your personal enjoyment.

Below is a simple explanation for distinguishing SD memory cards from SDHC and SDXC memory cards.

- SD,SDHC and SDXC memory cards appear the same externally.
- The logo on SD,SDHC and SDXC memory cards are different, so pay careful attention to the logo when purchasing.



The SD memory card logo is .

The SDHC memory card logo is .

The SDXC memory card logo is .

- The maximum capacity of SD memory cards is 2 GB. The maximum capacity of SDHC memory cards is 32 GB. The maximum capacity of SDXC memory cards is 64 GB.

Card Type	Capacities
SD	8 MB, 16 MB, 32 MB, 64 MB, 128 MB, 256 MB, 512 MB, 1 GB, 2 GB.
SDHC	4 GB, 8 GB, 16 GB, 32 GB
SDXC	64 GB

Memory Media Format

New media cards are formatted according to specific standards. If you wish to reformat a media card, be sure to do so with a device that uses media cards.

Formatting an SD/SDHC/SDXC Memory Card

SD/SDHC/SDXC memory cards are sold already formatted in conformity to specific standards. If you reformat an SD/SDHC/SDXC memory card, be sure to reformat it with a device such as digital camera or digital audio player that uses the SD/SDHC/SDXC memory cards, not with the format command provided within Windows.



Should you need to format all areas of the memory card, including the protected area, you will need to obtain an appropriate application that applies the copy protection system.

Media Care

Observe the following precautions when handling the card.

Card Care

- Do not twist or bend cards.
- Do not expose cards to liquids or store in humid areas or lay media close to containers of liquid.
- Do not touch the metal part of a card or expose it to liquids or let it get dirty.
- After using card, return it to its case.
- The card is designed so that it can be inserted only one way. Do not try to force the card into the slot.
- Do not leave a card partially inserted in the slot. Press the card until you hear it click into place.

Memory Card Care

- Set the write-protect switch to the lock position, if you do not want to record data.
- Memory cards have a limited lifespan, so it is important to backup important data.
- Do not write to a card if the battery power is low. Low power could affect writing accuracy.
- Do not remove a card while read/write is in progress.



For more details on using memory cards, see manuals accompanying the cards.

About the Write-protect

The following memory media have a function for protect.

- SD Card (SD memory card, SDHC memory card and SDXC memory card)



Set the write-protect switch to the lock position, if you do not want to record data.

Inserting a Memory Media

The following instructions apply to all types of supported media devices. To insert a memory media, follow the steps as detailed below:

1. Insert the memory card.
2. Press gently to ensure a firm connection.

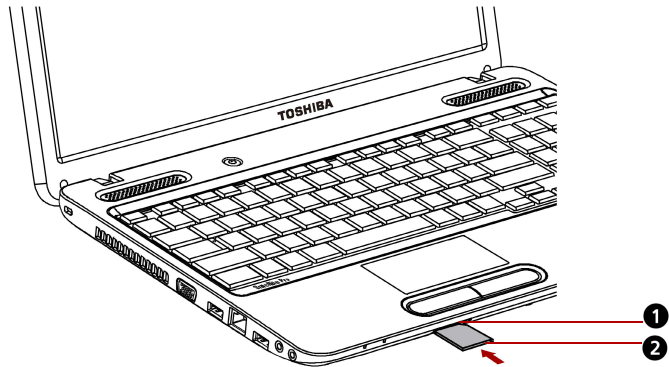

1. BRIDGE MEDIA SLOT

2. THE MEMORY CARD*

*THE CARD'S SHAPE DEPENDS ON THE CARD YOU PURCHASED.

Figure 3-2 Inserting the memory card



- When inserting memory media, do not touch the metal contacts. You could expose the storage area to static electricity, which can destroy data.
- Do not turn the computer off or switch to Sleep Mode or Hibernation Mode while files are being copied - doing so may cause data to be lost.

Removing a Memory Media

The following instructions apply to all types of supported media devices. To remove a memory media, follow the steps as detailed below:

1. open the **Safely Remove Hardware and Eject Media** icon on the system tray and disable the inserted memory card.
2. Grasp the card and remove it.

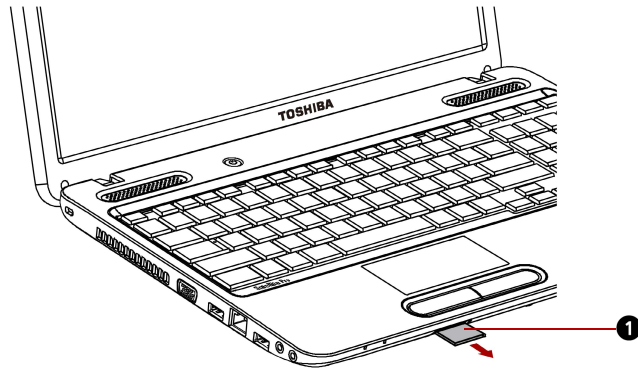

1. THE MEMORY CARD*

*THE CARD'S SHAPE DEPENDS ON THE CARD YOU PURCHASED.

Figure 3-3 Removing the inserted memory card



- If you remove the memory media or turn off the power while the computer is accessing the memory media, you may lose data or damage the media.
- Do not remove the memory media while the computer is in Sleep or Hibernation Mode. The computer could become unstable or data in the memory media could be lost.
- Do not remove only the miniSD/microSD Card while leaving the adaptor in the Bridge Media slot.

Memory Expansion

You can install additional memory in the computer's memory module to increase the amount of RAM.

Installing Memory Module

To install a memory module, make sure the computer is in boot mode then:

1. Turn the computer off in boot mode. Refer to the [Turning Off The Power](#) section in Chapter 1.



- If you use the computer for a long time, the memory modules will become hot. In this case, let the memory modules cool to room temperature before you replace them.
- Do not try to install a memory module with the computer turned on or turned off in Sleep and Hibernation Mode. You can damage the computer and the memory module.

2. Remove all cables connected to the computer.
3. Turn the computer upside down and remove the battery pack (refer to [Replacing The Battery Pack](#) section in Chapter 6.)
4. Remove one screw securing the memory module cover.
5. Lift off the cover.



- Use a point size 0 Phillips screwdriver.
- Insert the two memory modules of the same specifications and capacity into Slot A and Slot B respectively. The computer will operate in dual channel mode. You can access the inserted memory modules efficiently in dual channel.

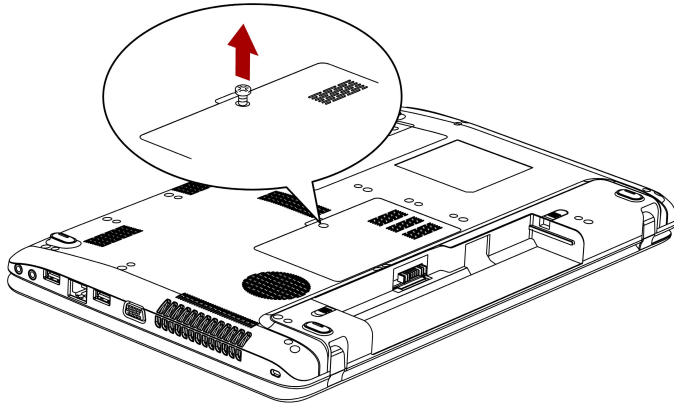

Figure 3-4 Removing the cover

6. Insert the memory module into the connector on the computer. Press the module carefully and firmly to ensure a solid connection.
7. Push the module down so that it lies flat and is secured by two latches.



Do not touch the connectors on the memory module or on the computer. Debris on the connectors may cause memory access problems.

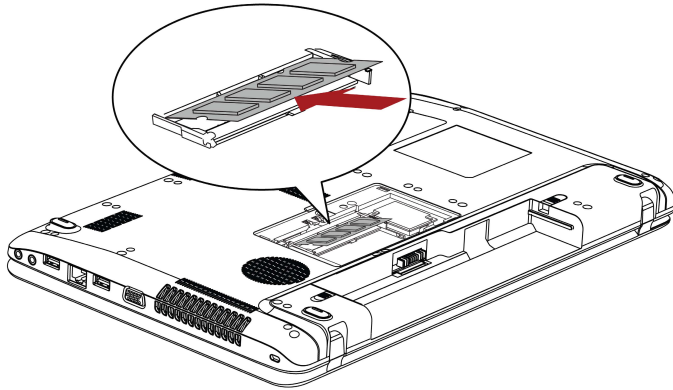

Figure 3-5 Inserting the memory module

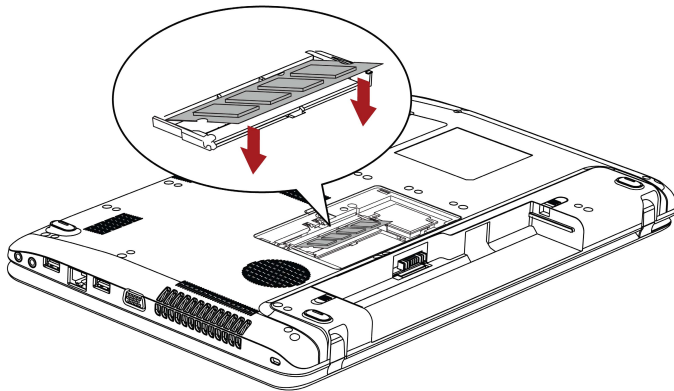

Figure 3-6 Pushing the memory module down

8. Seat the cover and secure it with one screw.
9. When you turn the computer on, it should automatically recognize the total memory capacity. Use the HW Setup program to verify that the added memory is recognized. If it is not recognized, check the module's connection.

Removing Memory Module

To remove the memory module, make sure the computer is in boot mode then:

1. Turn the computer off and remove all cables connected to the computer.



- *If you use the computer for a long time, the memory modules will become hot. In this case, let the memory modules cool to room temperature before you replace them.*
- *Do not try to remove a memory module with the computer turned on or turned off in Sleep and Hibernation Mode. You can damage the computer and the memory module.*

2. Turn the computer upside down and remove the battery pack (refer to Chapter 6, [Power and Power-up Modes](#).)
3. Remove one screw securing the memory module cover.
4. Lift off the cover.
5. Use a slender object such as a pen to press two latches on either side of the memory module to the outside. The memory module will pop up.
6. Grasp the memory module by the sides and pull it out.



Do not touch the connectors on the memory module or on the computer. Debris on the connectors may cause memory access problems.

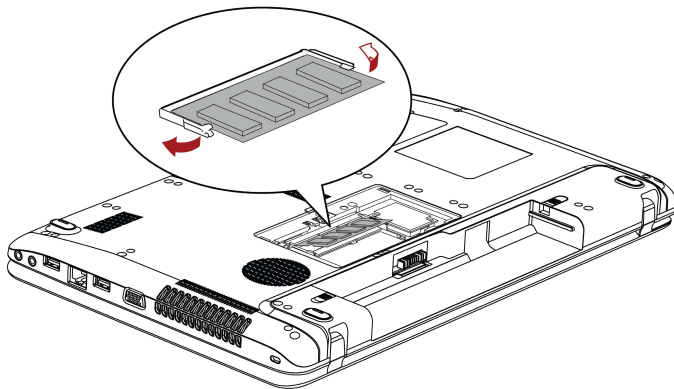

Figure 3-7 Removing the memory module

7. Seat the cover and secure it with one screw.

Additional Battery Pack (3 Cell and 6 Cell)

You can increase the portability of the computer with additional battery packs. If you're away from an AC power source, you can replace a low battery with a fully charged one. See Chapter 6, [Power and Power-up Modes](#).

Additional AC Adaptor

If you frequently transport the computer between different sites such as your home and office, purchasing an AC adaptor for each location will reduce the weight and bulk of your carrying load.

USB FDD Kit

The external FDD drive module can be connected to the USB port.

External Monitor

An external analog monitor can be connected to the external monitor port on the computer. To connect a monitor, follow the steps as detailed below:

connecting the monitor cable

1. Turn the computer's power off.
2. Connect the monitor cable to the external monitor port.

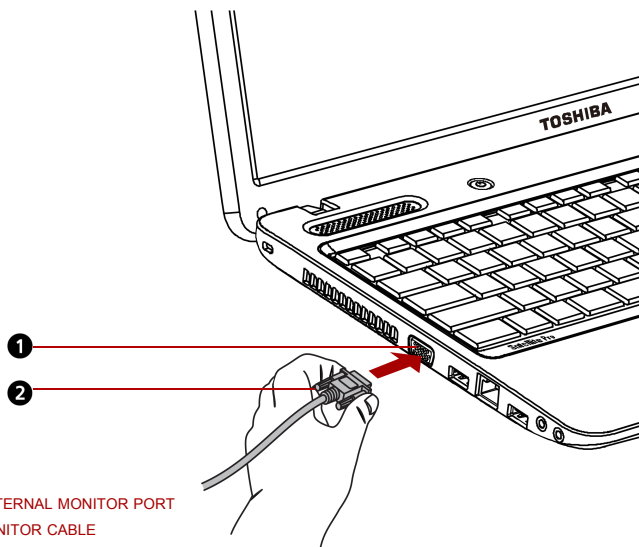

Figure 3-8 Connecting the monitor cable to the external monitor port

3. Turn the external monitor's power on.
4. Turn the computer's power on.

When you turn on the power, the computer automatically recognizes the monitor and determines whether it is color or monochrome device. In the event that you find that there are issues getting an image displayed on the correct monitor, you should consider using the **FN + F5** hot key to change the display settings (if you then disconnect the external monitor before you turn the computer's power off, be sure to press **FN + F5** hot key again to switch to the internal display).

Please refer to Chapter 5, [The Keyboard](#), for further details on using hot keys to change the display setting.



Do not disconnect the external monitor while in Sleep or Hibernation Mode. Turn off the computer before disconnecting the external monitor.

When displaying desktop at external analog monitor, desktop is sometimes displayed on the center of the monitor with black bars around desktop (with small size).

At that time, please read the manual of the monitor and set the display mode which is supporting at the monitor. Then it will be displayed with suitable size with correct aspect ratio.

Security Lock

A security lock enables you to anchor your computer to a desk or other heavy object to help prevent unauthorized removal of the computer.

Attach one end of a cable to the desk and the other end to the security lock slot on the right side of the computer.

Connecting the security lock

In order to connect a security cable to the computer, follow the steps as detailed below:

1. Turn the computer so its left side faces you.
2. Align the security cable with the lock slot and secure it in place.

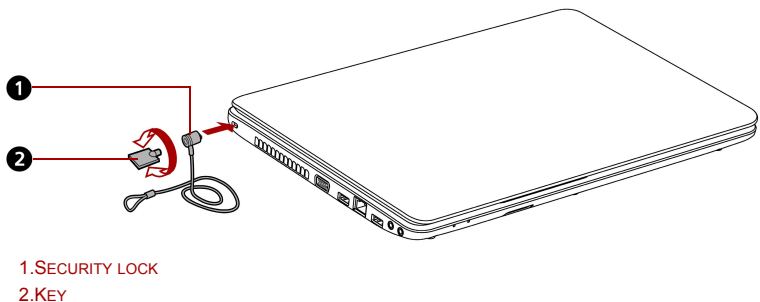

Figure 3-9 Security lock

Chapter 4

Operating Basics

This chapter gives information on basic operations including using the touchpad, optical disc drives, Audio/Video controls, the web camera, the microphone, wireless communication and LAN. It also provides tips on caring for your computer, diskettes and CD/DVD.

Using The Touchpad

To use the touchpad, simply touch and move your finger tip across it in the direction you want the on-screen pointer to go.

Two buttons below the touchpad are used like the buttons on a mouse pointer.

Press the left button to select a menu item or to manipulate text or graphics designated by the pointer. Press the right button to display a menu or other function depending on the software you are using.



You can also tap the touchpad to perform functions similar to those of the left button on a standard mouse.

Click: Tap the touchpad once.

Double-click: Tap twice.

Drag and drop: Tap to select the material you want to move. Leave your finger on the touchpad after the second tap and move the material.

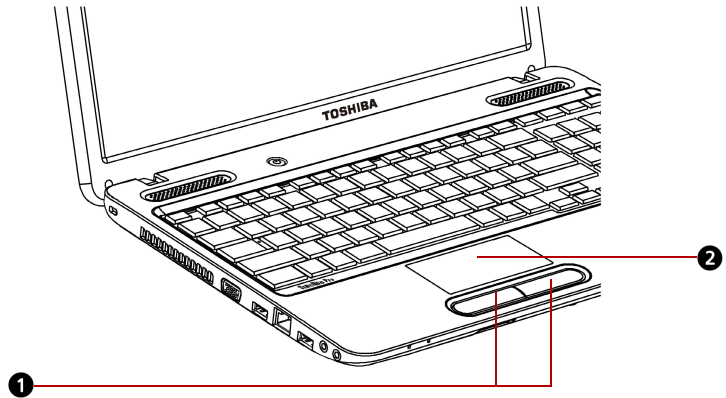

1. TOUCHPAD CONTROL BUTTONS
2. TOUCHPAD

Figure 4-1 Touchpad and control buttons

Touch Pad Gesture

Please refer to the touch pad settings in mouse properties.

Using The Web Camera

Built-in web camera is provided with some models.

This section describes the bundled webcam utility, which can capture still and video images. The web camera will auto-run when Windows starts and the LED glows blue.



Please unstick the protective plastic-film before using the web camera.

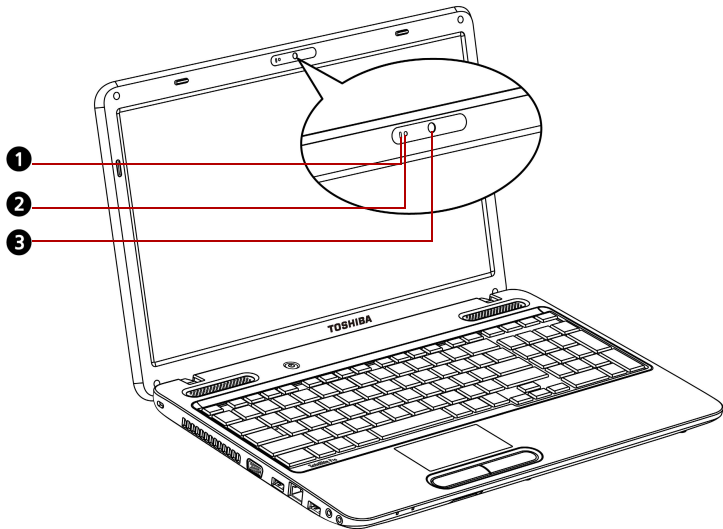

1. BUILT-IN MICROPHONE
2. WEB CAMERA LED
3. WEB CAMERA LENS

Figure 4-2 Web camera

Using TOSHIBA Web Camera Application

TOSHIBA Web Camera Application is pre-configured to start when you turn on Windows 7; if you need to restart it go to **Start** → **All Programs** → **TOSHIBA** → **Utilities** → **Web Camera Application**.

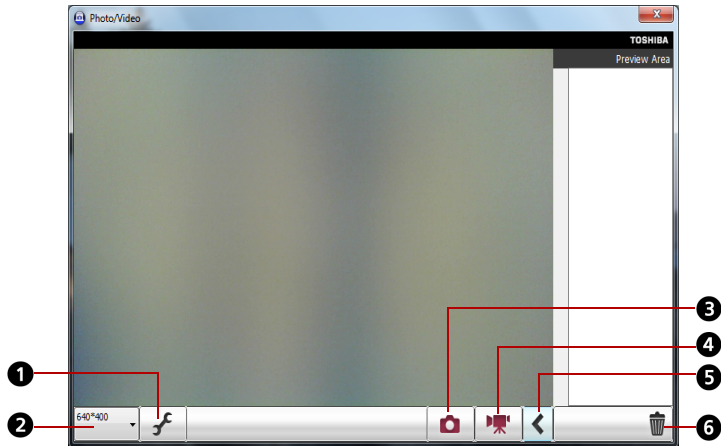

1. CAPTURE SETTINGS
2. CAMERA RESOLUTION
3. CAPTURE STILL IMAGE
4. VIDEO RECORDING
5. OPEN/CLOSE PREVIEW AREA
6. DELETE RECORDED FILE

Figure 4-3 Using TOSHIBA Web Camera Application

Capture Settings	Open Capture Settings dialog box. Chooses from the Basic tab to select photo and video saving location, select Capture Format and Video Quality.
Camera Resolution	Choose resolution for Preview, Capture and Record.
Capture Still Image	Click to capture a still image, and see a preview of the captured image in preview area.
Video Recording	Click to start recording. One more to stop recording and see preview of the video in preview area.
Open/Close Preview Area	Click to open Preview Area. One more to close Preview Area.
Delete Recorded File	Choose a thumbnail of recorded file and click this button to delete this file from hard disk.

Using The TOSHIBA Face Recognition

TOSHIBA Face Recognition uses a face verification library to verify the face data of users when they log in to Windows. The user can thus avoid having to enter a password or the like, which makes the login process easier. This software is preinstalled with some models.

Note on Use

- TOSHIBA Face Recognition does not guarantee the correct identification of a user. Changes to the likeness of a registrant, such as hair style changes, wearing a cap, or wearing glasses may effect the recognition rates when such changes occur after the registrant had registered.
- TOSHIBA Face Recognition may incorrectly recognize faces that are similar to a registrant.
- For high security purposes, TOSHIBA Face Recognition is not a suitable substitute for Windows passwords. When security is a high priority, use your established Windows passwords to log in.
- Bright background light and/or shadows may prevent a registrant from being recognized correctly. In that case, log in using your Windows password. If recognition of a registrant fails repeatedly, refer to your computer documentation to learn ways to improve recognition performance.
- TOSHIBA Face Recognition records face data in a log when face recognition fails. When transferring ownership or disposing of your computer, please uninstall the application or delete all the logs created by the application. For details on how to do this, see help file.
- TOSHIBA Face Recognition can be used only in Windows Vista and Windows 7.

Disclaimer

TOSHIBA does not guarantee that the face recognition utility technology will be completely secure or error-free. TOSHIBA does not guarantee that the face recognition utility will accurately screen out unauthorized users at all times. TOSHIBA is not liable for any failure or damage that might arise out of the use of the face recognition software or utility.

TOSHIBA, ITS AFFILIATES AND SUPPLIERS SHALL HAVE NO RESPONSIBILITY FOR DAMAGE TO OR LOSS OF ANY BUSINESS, PROFITS, PROGRAMS, DATA, NETWORK SYSTEMS OR REMOVABLE STORAGE MEDIA ARISING OUT OF OR RESULTING FROM THE USE OF THE PRODUCT, EVEN IF ADVISED OF THE POSSIBILITY THEREOF.

How to Register The Face Recognition Data

Take a picture for facial verification purposes, and register the data needed when you log in. To register the data needed when you log in, follow the steps as described below:

1. To launch this utility, click **Start** → **All Programs** → **TOSHIBA** → **Utilities** → **Face Recognition**.
 - The **Registration** screen is displayed for a logged-in user whose face has not been registered.
 - The **Management** screen is displayed for a logged-in user whose face has already been registered.
2. Click the **Register** button in the **Management** screen. The Registration screen is displayed.
 - If you wish to practice, click on the **Next** button in the **Registration** screen.
 - If you do not wish to practice, click on the **Skip** button in the **Registration** screen.
3. Click the **Next** button to start the guide.
4. First, take a picture while moving your neck slightly to the left and right.
5. Now take a picture while moving your neck down and up.
 - Click the **Back** button to practice the guide once more.
6. Click the **Next** button to start image-capturing process. Adjust the position of your face so that it fits within the face-shaped frame.
7. Once your face has been positioned properly, the recording will commence. Start moving your neck very slightly to the left and right, and then move your neck down and up.
8. Registration will end after you have repeatedly moved your neck left, right, down and up. When the register succeeds, below message will be displayed on the screen:

Registration successful. Now we'll do the verification test. Click the Next button.

Click the **Next** button to perform the verification test.
9. Perform the verification test. Face the screen as you do when you register.
 - If verification fails, click the **Back** button and re-register. Please refer to step 8 from step 6.
10. If verification is successful, click the **Next** button and register an account.
11. Register the account. Fill in the account registration fields.
 - Fill in the all fields.When you have finished it, click **Next** button.

12. The **Management** screen is displayed. The registered account name will be displayed. Clicking on it will cause the captured image of your face to be displayed on the left.

How to Delete The Face Recognition Data

Delete image data, account information, and personal record data created during registration. To delete the Face Recognition Data, follow the steps as described below:

1. To launch this utility, click **Start** → **All Programs** → **TOSHIBA** → **Utilities** → **Face Recognition**. The **Management** screen is displayed.
2. Select a user which is deleted in the **Management** screen.
3. Click the **Delete** button. “You are about to delete the user data. Would you like to continue?” will be displayed on the screen.
 - If you do not want the data to be deleted, click the **No** button and you will then be returned to the **Management** screen.
 - Clicking on the **Yes** button will remove the selected user from the **Management** screen.

How to Launch The Help File

For further information on this utility, please refer to help file.

- To launch the help file, click **Start** → **All Programs** → **TOSHIBA** → **Utilities** → **Face Recognition Help**.

Windows Logon Via TOSHIBA Face Recognition

This section explains how to login to Windows with TOSHIBA Face Recognition. Two authentication modes are provided.

- **1:N Mode Login screen** : If the face authentication tile is selected by default, you can log in without using the keyboard or mouse.
- **1:1 Mode Login screen** : This mode is essentially the same as N mode, but the **Select Account** screen will appear before the **Display Captured Image** screen, and you will need to select the user account to be authenticated in order to start the authentication process.

1:N Mode Login Screen

1. Turn on the computer.
2. The **Select Tiles** screen will be displayed.
3. Select **Start face recognition**.
4. “Please face the camera” will be displayed.
5. Verification will be performed. If the authentication is successful, the image data taken in step 4 will be faded in and placed over one another.
 - If an error occurs during authentication, you will be returned to the **Select Tiles** screen.

6. **Windows Welcome** screen will be displayed, and will be logged in automatically to Windows.

1:1 Mode Login Screen

1. Turn on the computer.
2. The **Select Tiles** screen will be displayed.
3. Select **Start face recognition**.
4. The **Select Account** screen will be displayed.
5. Select the account, and click the **arrow** button.
6. "**Please face the camera**" will be displayed.
7. Verification will be performed. If the authentication is successful, the image data taken in step 6 will be faded in and placed over one another.
 - If an error occurs during authentication, you will be returned to the Select Tiles screen.
8. **Windows Welcome** screen will be displayed, and will be logged in automatically to Windows.
 - If authentication was successful, but an authentication error subsequently occurred during the login to Windows, you will be asked to provide your account information.

Using Optical Disc Drives

The full-size DVD Super Multi (\pm R DL) drive provides high-performance execution of CD/DVD. You can run either 12cm (4.72") or 8cm (3.15") CD/DVDs without an adapter. A Serial ATA interface controller is used for CD/DVD operation.



- *Use the TOSHIBA DVD PLAYER application to view DVD-Video discs in the model which has preinstalled TOSHIBA DVD PLAYER.*
- *Use the Windows Media Player application to view DVD-Video discs in the model which has not preinstalled TOSHIBA DVD PLAYER.*

Please also refer to the [Writing CD/DVDs on DVD Super Multi \(\$\pm\$ R DL\) Drive](#) section for precautions on writing to CD/DVDs.

Loading Discs

Please follow the steps below and refer to figures.

1. a. When the power is on, press the eject button to open the drawer slightly.

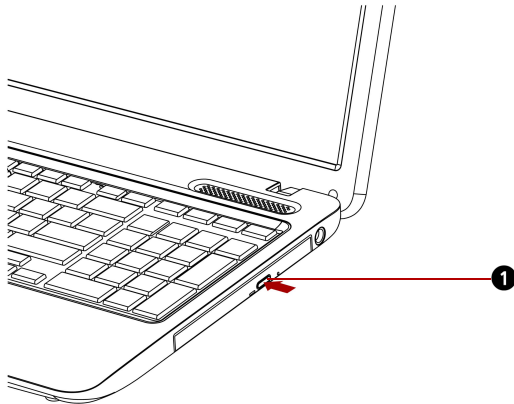

1.EJECT BUTTON

Figure 4-4 Pressing the eject button

- b. Pressing the eject button will not open the drawer when the drive's power is off. If the power is off, you can open the drawer by inserting a slender object (about 15 mm) such as a straightened paper clip into the eject hole just to the right of the eject button.

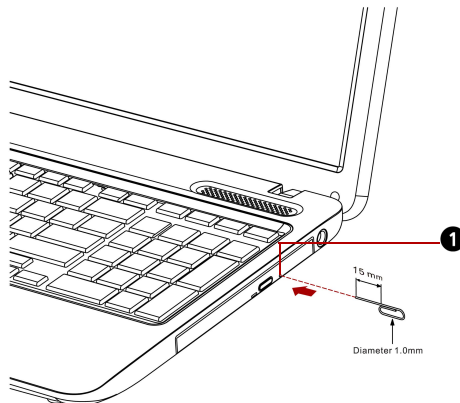

1.EJECT HOLE

Figure 4-5 Manual release with the eject hole

2. Grasp the drawer gently and pull until it is fully opened.

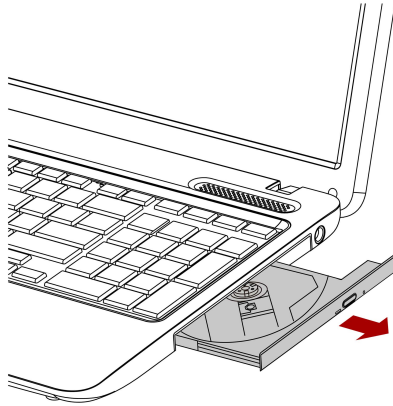

Figure 4-6 Pulling the drawer open

3. Lay the CD/DVD with the label side up in the drawer.

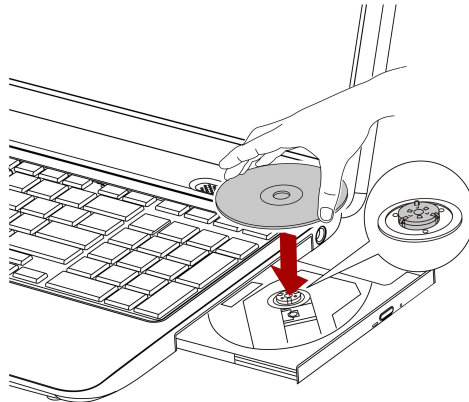

Figure 4-7 Inserting a CD/DVD



When the drawer is fully opened, the edge of the computer will extend slightly over the CD/DVD tray. Therefore, you will need to turn the CD/DVD at an angle when you place it in the tray. After seating the CD/DVD, however, make sure it lies flat, as shown in above figure.



- *Do not touch the laser lens. Doing so could cause misalignment.*
- *Do not keep foreign matter from entering the drive. Check the back edge of the tray to make sure it carries no debris before closing the drive.*

4. Press gently at the center of the CD/DVD until you feel it click into place. The CD/DVD should lie below the top of the spindle, flush with the spindle base.
5. Push the center of the drawer to close it. Press gently until it locks into place.



If the CD/DVD is not seated properly when the drawer is closed, the CD/DVD might be damaged. Also, the drawer might not open fully when you press the eject button.

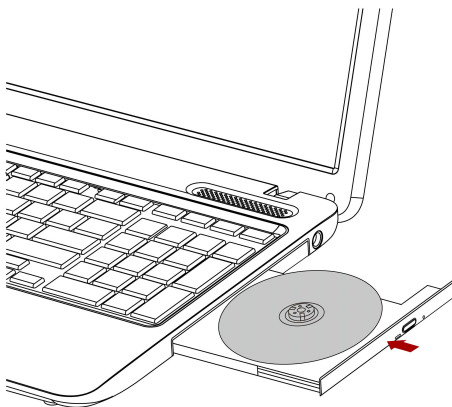

Figure 4-8 Closing the drawer

Removing Discs

To remove the CD/DVD, follow the steps below and refer to below figure.



Do not press the eject button while the computer is accessing the drive. Wait for the optical disc drive indicator to go out before you open the drawer. Also, if the CD/DVD is spinning when you open the drawer, wait for it to stop before you remove it.

Please follow the steps below and refer to figures.

1. To pop the drawer partially open, press the eject button. Gently pull the drawer out until it is fully opened.



- *When the drawer pops open slightly, wait a moment to make sure the CD/DVD has stopped spinning before pulling the drawer fully open.*
- *Turn off the power before you use the eject hole. If the CD/DVD is spinning when you open the drawer, the CD/DVD could fly off the spindle and cause injury.*

2. The CD/DVD extends slightly over the sides of the drawer so you can grasp it. Hold the CD/DVD gently and lift it out.

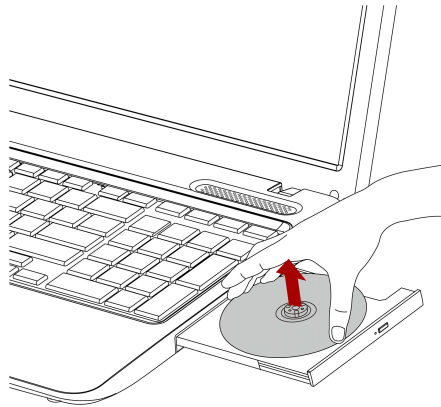

Figure 4-9 Removing a CD/DVD

3. Push the center of the drawer to close it. Press gently until it locks into place.

Writing CD/DVDs on DVD Super Multi (±R DL) Drive

Some models are equipped with a full-size DVD Super Multi (±R DL) drive, which can be used to write data to either CD-R/-RW or DVD-R/-RW/+R/+RW/-RAM/+R DL/-R DL discs. The following application for writing is supplied: TOSHIBA Disc Creator.

Important Message (DVD Super Multi (±R DL) Drive)

Before you write or rewrite to CD-R/-RW or DVD-R/-RW/+R/+RW/-RAM/+R DL/-R DL disc, read and follow all setup and operating instructions in this section.

If you fail to do so, the DVD Super Multi (±R DL) drive may not function properly, and you may fail to write or rewrite, lose data or incur other damage.

Before Writing or Rewriting

- Based on TOSHIBA's limited compatibility testing, we suggest the following manufacturers of CD-R/-RW and DVD-R/+R/-RW/+RW/-RAM/+R DL/-R DL disc. However, in no event does TOSHIBA guarantee the operation, quality or performance of any disc. Disc quality can affect write or rewrite success rates

CD-R:

TAIYO YUDEN CO., LTD.
MITSUBISHI KAGAKU MEDIA CO., LTD.
HITACHI MAXELL LTD.

CD-RW: (High-Speed and Multi-Speed)

MITSUBISHI KAGAKU MEDIA CO., LTD.

CD-RW: (Ultra-Speed)

MITSUBISHI KAGAKU MEDIA CO., LTD.

DVD-R:

DVD Specifications for Recordable Disc for General Version 2.0

TAIYO YUDEN CO., LTD. (for 8x and 16x speed media)
MITSUBISHI KAGAKU MEDIA CO., LTD. (for 4x, 8x and 16x speed media)
HITACHI MAXELL LTD. (for 8x and 16x speed media)

DVD-R (Dual Layer):

MITSUBISHI KAGAKU MEDIA CO., LTD. (for 4x and 8x speed media)

DVD-R for Labelflash:

FUJIFILM CORPORATION. (for 16x speed media)

DVD+R:

MITSUBISHI KAGAKU MEDIA CO., LTD. (for 8x and 16x speed media)
TAIYO YUDEN CO., LTD. (for 8x and 16x speed media)

DVD+R (Dual Layer):

MITSUBISHI KAGAKU MEDIA CO., LTD. (for 2.4x and 8x speed media)

DVD+R for Labelflash:

FUJIFILM CORPORATION. (for 16x speed media)

DVD-RW:**DVD Specifications for Recordable Disc for General Version 1.1 or Version 1.2**

VICTOR COMPANY OF JAPAN, LTD. (JVC) (for 2x, 4x and 6x speed media)

MITSUBISHI KAGAKU MEDIA CO., LTD. (for 2x, 4x and 6x speed media)

DVD+RW:

MITSUBISHI KAGAKU MEDIA CO., LTD. (for 2.4x, 4x and 8x speed media)

DVD-RAM:**DVD Specifications for Recordable Disc for General Version 2.0, Version 2.1 or Version 2.2**

Panasonic CORPORATION. (for 3x and 5x speed media)

HITACHI MAXELL LTD. (for 3x and 5x speed media)



This DVD Super Multi ($\pm R$ DL) drive cannot use discs that allow writing faster than 16x speed (DVD-R and DVD+R media), 8x speed DVD-R (Double layer), DVD+RW, and DVD+R (Double layer) media, 6x speed (DVD-RW media), 5x speed (DVD-RAM media).

- If the disc is poor in quality, dirty or damaged, writing or rewriting errors may occur. Be careful to check the disc for dirt or damage before you use it.
- The actual number of rewrites to CD-RW, DVD-RW, DVD+RW or DVD-RAM is affected by the quality of the disc and the way it is used.
- There are two types of DVD-R discs: authoring and general use discs. Do not use authoring discs. Only general use discs can be written to by a computer drive.
- We can support only format 1 of DVD-R DL. Therefore you can not do the additional writing. If your data is under DVD-R(SL) capacity, we suggest to use DVD-R(SL) media.
- You can use DVD-RAM discs that can be removed from a cartridge and DVD-RAM discs designed without a cartridge. You cannot use a disc with a 2.6 GB single-sided capacity or 5.2 GB double-sided capacity.
- Other DVD-ROM drives for computers or other DVD players may not be able to read DVD-R/R DL/-RW or DVD+R/+R DL/+RW discs.
- Data written to a CD-R/DVD-R/DVD+R disc cannot be deleted either in whole or in part.
- Data deleted (erased) from a CD-RW and DVD-RW, DVD+RW and DVD-RAM disc cannot be recovered. Check the content of the disc carefully before you delete it. If multiple drives that can write data to discs are connected, be careful not to delete data from the wrong drive.

- In writing to a DVD-R/-R DL/-RW, DVD+R/+R DL/+RW or DVD-RAM disc, some disc space is required for file management, so you may not be able to write the full capacity of the disc.
- Since the disc is based on the DVD standard, it will be filled with dummy data if the written data is less than about 1 GB. Even if you write only a small amount of data, it might take time to fill in the dummy data.
- DVD-RAM formatted by FAT32 cannot be read in Windows 2000 without DVD-RAM Driver Software.
- When multiple drives that can write data to discs are connected, be careful not to write to the wrong drive.
- Be sure to connect the universal AC adaptor before you write or rewrite.
- Before you enter Sleep/Hibernation Mode, be sure to finish DVD-RAM writing. Writing is finished if you can eject DVD-RAM media.
- Be sure to close all other software programs except the writing software.
- Do not run software such as a screen saver, which can put a heavy load on the CPU.
- Operate the computer in the full-power mode. Do not use power-saving features.
- Do not write while virus check software is running. Wait for it to finish, and then disable virus detection programs including any software that checks files automatically in the background.
- Do not use hard disk utilities, including those intended to enhance HDD access speed. They may cause unstable operation and data damage.
- Write from the computer's HDD to the CD/DVD. Do not try to write from shared devices such as a LAN server or any other network device.
- Writing with software other than TOSHIBA Disc Creator is not recommended.

When Writing or Rewriting

Please observe/consider the following when you write or rewrite to a CD-R/-RW, DVD-R/-R DL/-RW/-RAM or DVD+R/+R DL/+RW disc.

- Do not perform any of the following actions:
 - Change users in the Windows 7 operating system.
 - Operate the computer for any other function, including use of a mouse or touchpad, closing/opening the LCD panel.
 - Start a communication application such as Wireless LAN.
 - Apply impact or vibration to the PC.
 - Install, remove or connect external devices, including items such as a Secure Digital(SD), Secure Digital High Capacity(SDHC), Secure Digital Extended Capacity (SDXC), MultiMediaCard(MMC), USB device, external monitor or an optical digital device.
 - Use the Audio/Video control button to reproduce music or voice.
 - Open the optical disc drive.

- Do not use shut down/log off and sleep/hibernation while writing or rewriting.
- Make sure writing or rewriting is completed before going into sleep/hibernation. Writing is completed if you can open the DVD Super Multi (\pm R DL) drive tray.
- Set the computer on a level surface and avoid places subject to vibration such as airplanes, trains, or cars. Do not use an unstable surface such as a stand.
- Keep mobile phones and other wireless communication devices away from the computer.
- Always copy data from the HDD to the optical disc. Do not use cut-and-paste. The original data will be lost if there is a write error.

Disclaimer (DVD Super Multi (\pm R DL) Drive)

TOSHIBA does not bear responsibility for the following:

- Damage to any CD-R/-RW or DVD-R/-R DL/-RW/+R/+R DL/+RW/DVD-RAM disc that may be caused by writing or rewriting with this product.
- Any change or loss of the recorded contents of CD-R/-RW or DVD-R/-R DL/-RW/+R/+R DL/+RW/DVD-RAM disc that may be caused by writing or rewriting with this product, or for any business profit loss or business interruption that may be caused by the change or loss of the recorded contents.
- Damage that may be caused by using third party equipment or software.

Given the technological limitations of current optical disc writing drives, you may experience unexpected writing or rewriting errors due to disc quality or problems with hardware devices. Also, it is a good idea to make two or more copies of important data, in case of undesired change or loss of the recorded contents.

TOSHIBA Disc Creator

Note the following limitations when you use TOSHIBA Disc Creator:

- DVD-Video cannot be created using TOSHIBA Disc Creator.
- DVD-Audio cannot be created using TOSHIBA Disc Creator.
- You cannot use TOSHIBA Disc Creator's 'Audio CD for Car or Home CD Player' function to record music to DVD-R, DVD-R DL, DVD-RW, DVD+R, DVD+R DL or DVD+RW media.
- Do not use the 'Disc Backup' function of TOSHIBA Disc Creator in order to copy DVD-Video or DVD-ROM material that has copyright protection.
- DVD-RAM discs cannot be backed up using the 'Disc Backup' function of TOSHIBA Disc Creator.
- You cannot back up CD-ROM, CD-R or CD-RW media to DVD-R, DVD-R DL or DVD-RW media using the 'Disc Backup' function of TOSHIBA Disc Creator.

- You cannot back up CD-ROM, CD-R or CD-RW media to DVD+R, DVD+R DL or DVD+RW media using the 'Disc Backup' function of TOSHIBA Disc Creator.
- You cannot back up DVD-ROM, DVD-Video, DVD-R, DVD-R DL, DVD-RW, DVD+R, DVD+R DL or DVD+RW to CD-R or CD-RW media using the 'Disc Backup' function of TOSHIBA Disc Creator.
- TOSHIBA Disc Creator cannot record in packet format.
- You might not be able to use the 'Disc Backup' function of TOSHIBA Disc Creator to back up a DVD-R, DVD-R DL, DVD-RW, DVD+R, DVD+R DL or DVD+RW disc that was made with other software on a different optical media recorder.
- If you add data to a DVD-R, DVD-R DL, DVD+R or DVD+R DL disc that you have already recorded to, you might not be able to read the added data under some circumstances. For example, it cannot be read under 16-bit operating systems, such as Windows 98SE and Windows Me, while in Windows NT4 you will need Service Pack 6 or later, and in Windows 2000, you will need Service Pack 2. In addition to this, some DVD-ROM and DVD-ROM/CD-RW drives cannot read this added data regardless of the operating system.
- TOSHIBA Disc Creator does not support recording to DVD-RAM discs - to achieve this you should use Windows Explorer or another similar utility.
- When you back up a DVD disc, be sure that the source drive supports recording to DVD-R, DVD-R DL, DVD-RW, DVD+R, DVD+R DL or DVD+RW media - if this is not the case then the source disc might not be backed up correctly.
- When you back up a DVD-R, DVD-R DL, DVD-RW, DVD+R, DVD+R DL or DVD+RW disc, be sure to use the same type of disc.
- You cannot partially delete any data written to a CD-RW, DVD-RW, DVD+RW disc.

Data Verification

To verify that data has been written or rewritten correctly to a data CD/DVD you should follow the steps below before you begin the write/rewrite process:

1. Display the setting dialog box by one of the following two steps:
 - Click the **Recording settings** button () for writing on the main toolbar in the **Data CD/DVD** mode.
 - Select **Settings for Each Mode** → **Data CD/DVD** in the **Settings** menu.
2. Mark the **Verify written data** check box.
3. Select **File Open** or **Full Compare** mode.
4. Click the **OK** button.

How to Learn More about TOSHIBA Disc Creator

Please refer to the Help files for additional TOSHIBA Disc Creator information.

TOSHIBA DVD PLAYER

Please be aware of the following limitations when you use the TOSHIBA DVD PLAYER. (Is preinstalled with some models)

Notes on Use

- "TOSHIBA DVD PLAYER" software is supported for playback of DVD-Video and DVD-VR.
- Frame dropping, audio skipping or out of synch audio and video may occur during playback of some DVD-Video titles.
- Close all other applications when using the "TOSHIBA DVD PLAYER". Do not open any other applications or carry out any other operations during DVD-Video playback. Playback may stop or not function properly in some situations.
- Unfinalized DVDs created on home DVD recorders may not be playable on the computer.
- Use DVD-Video discs with a region code which is either "the same as the factory default setting" or "ALL".
- Do not playback DVD discs Video while watching or recording television programs using other applications. Doing so may cause DVD-Video playback or television program recording errors. In addition, if prescheduled recording starts during DVD-Video playback it may cause DVD-Video playback or television program recording errors. Please view DVD-Video during times when there is no recording prescheduled.
- The resume function cannot be used with some discs on the "TOSHIBA DVD PLAYER".
- It is recommended the AC adaptor be connected when playing DVD-Video. Power saving features may interfere with smooth playback. When playing DVD-Video using battery power, set the Power Options to "Balance".
- Screen savers will not display while playing a movie in the "TOSHIBA DVD PLAYER". The computer will also not go into Sleep Mode, Hibernation Mode or Shut Down while using "TOSHIBA DVD PLAYER".
- Do not configure the Display automatic power off function to run while the "TOSHIBA DVD PLAYER" is running.
- Do not switch to Hibernation or Sleep Mode when running the "TOSHIBA DVD PLAYER".
- Do not lock the computer using the **Windows logo** () + **L** keys or the **FN + F1** keys when running the "TOSHIBA DVD PLAYER".
- Do not change Windows Users while "TOSHIBA DVD PLAYER" is running.
- The "TOSHIBA DVD PLAYER" does not have a parental control function.
- In order to protect copyrights, the Windows Print Screen function is disabled when "TOSHIBA DVD PLAYER" is running.

- (Print Screen functions are disabled even when running other applications besides "TOSHIBA DVD PLAYER" and when "TOSHIBA DVD PLAYER" is minimized.) Please close the "TOSHIBA DVD PLAYER" to use the Print Screen function.
- For some DVD-Video discs, using the control window to change the audio track will also change the subtitle track.
- Carry out the installation/uninstallation of the "TOSHIBA DVD PLAYER" under a user account with administrator rights.
- If you see the screen blinking while playing DVD with subtitle on at Media Player, please use "TOSHIBA DVD PLYER" or "Media Center" to play DVD.

Display Devices & Audio

- "TOSHIBA DVD PLAYER" will only run when "Colors" is set to "True color (32 bit)". Click **Start** → **Control Panel** → **Appearance and Personalization** → **Display** → **Adjust resolution**, click **Advanced settings**, select **Monitor** tab, set **colors** to **True color (32 bit)**.
- If the DVD-Video image is not displayed on an external display or television, stop the "TOSHIBA DVD PLAYER", and change the screen resolution. To change the screen resolution, click **Start** → **Control Panel** → **Appearance and Personalization** → **Display** → **Adjust resolution**. However, video cannot be output to some external displays and televisions due to output or playback conditions.
- When viewing DVD-Video on an external display or TV, change the display device before playing. DVD-Video cannot be displayed simultaneously (in clone mode) on both the computer's display panel and an external display.
- Do not change the screen resolution while running the "TOSHIBA DVD PLAYER".

Starting TOSHIBA DVD PLAYER

Use the following procedure to start "TOSHIBA DVD PLAYER".

1. Insert an DVD-Video in the DVD Super Multi drive while Windows 7 is running. When an DVD-Video disc is set in the DVD drive, the following application selection screen may appear. If this occurs, select **Play DVD movie (using TOSHIBA DVD PLAYER)**, to launch the **TOSHIBA DVD PLAYER**.

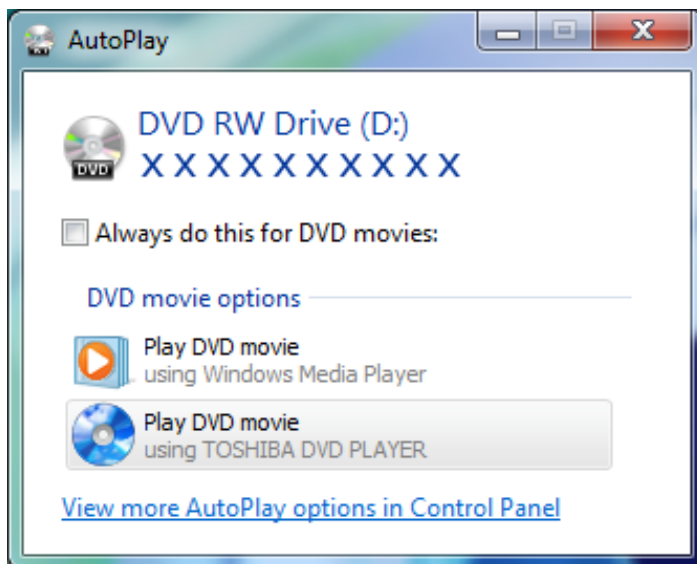

2. Select **Start** → **All Programs** → **TOSHIBA DVD PLAYER** → **TOSHIBA DVD PLAYER** to start "TOSHIBA DVD PLAYER".

Operating TOSHIBA DVD PLAYER

Notes on using "TOSHIBA DVD PLAYER".

- Screen display and available features may vary amongst and scenes.
- If the menu is opened in the Display Area using the Control Top Menu or Menu buttons, touch pad and mouse menu may not be able to be used.

Open TOSHIBA DVD PLAYER HELP

TOSHIBA DVD PLAYER features and instructions are also detail in TOSHIBA DVD PLAYER Help.

Use the following procedure to open TOSHIBA DVD PLAYER Help.

- Click the **Help** button () in the Display Area.

Media Care

This section provides tips on protecting data stored on your CD/DVD. Handle your media with care. The following simple precautions will increase the lifetime of your media and protect the data stored on them.

CD/DVD

1. Store your CD/DVD in the container they came in to protect them and keep them clean.
2. Do not bend the CD/DVD.
3. Do not write on, apply a sticker to, or otherwise mark the surface of the CD/DVD that contains data.
4. Hold the CD/DVD by its outside edge or the edge on the center hole. Fingerprints on the surface can prevent the drive from properly reading data.
5. Do not expose to direct sunlight, extreme heat or cold.
6. Do not place heavy objects on your CD/DVD.
7. If your CD/DVD become dusty or dirty, wipe them with a clean dry cloth. Wipe from the center out, do not wipe in a circular direction around the CD/DVD. If necessary, use a cloth dampened in water or a neutral cleaner. Do not use benzine, thinner or similar cleaner.

Sound System

This section describes some of the audio control functions.

Adjusting System Volume

You can control the overall level of sound using Windows **Volume Mixer**.

To launch Volume Mixer, follow the steps below.

1. Locate the **Speaker** icon on the task tray.
2. Right-click the **Speaker** icon on the task tray.
3. Select **Open Volume Mixer** from the menu.

Click the **Device** button to display available playback devices. Select **Speakers** to use the internal speakers for listening. Adjust speaker volume by moving the slider up or down to raise or lower the volume. Click the **Mute** button to mute the sound.

You may see another control under **Applications** in **Volume Mixer**. It is the control for an application which is currently running. The **System Sounds** is always displayed since it controls the system sounds' volume.

Changing System Sounds

System sounds are assigned to inform you when certain events happen. This section explains how to select an existing scheme or save one you have modified.

To launch the configuration dialog window for system sounds, follow the steps below.

1. Right-click the **Speaker** icon on the task tray.
2. Select **Sounds** from the menu.

Smart Audio

You can confirm and change the audio configuration using the **Smart Audio**. To launch the **Smart Audio**, click **Start** → **Control Panel** → **Hardware and Sound** → **Smart Audio**. When you first launch the Smart Audio, you will see the following device tabs.

Volume Mixer

Displays all connected audio devices in the system. Every device has a Volume Slider Bar and a Mute button.

Clicking once on a device will select and highlight it. On Windows 7, double clicking will make it the default device, which is denoted by a green checkmark.



When a playback device is selected, a preview image is displayed like the computer in the above screenshot. A slider may appear that allows you to adjust the balance between the speakers.

Voice Effects

Controls **Voice Recording** and **Voice Over IP (VOIP)** phone conversation settings.

- **Voice Recording** - Microphone Noise Reduction effect will be enabled to suppress background noise and project a clear voice. To select / deselect this setting, click on the **Voice Recording** icon.
- **Voice Over IP** - In addition to Microphone Noise Reduction, Speaker Noise Reduction and Acoustic Echo Cancellation effects will also be enabled to remove disturbances caused by sound echo. To select / deselect this setting, click on the **Voice Over IP** icon.

Audio Director

Allows you to define how sound is directed to devices. There are two modes to select: Classic and Multi-Stream.

- **Classic mode** - Emulates the behavior of Microsoft Windows XP, where sound is heard either on the speakers or on the headphones, but not both at the same time. To select Classic mode, click on the **corresponding** icon.
- **Multi-Stream** - Different sounds can be played on speakers and headphones simultaneously. To select Multi-Stream mode, click on the **corresponding** icon.

Two "**Play**" buttons allow you to play separate sounds in both modes:

- When the **red Play** button is pressed, a sample sound is played on the headphones.
- When the **blue Play** button is pressed, a different sample sound is played on the speakers.

In **Classic mode**, if the headphones are plugged in, both red and blue sounds are heard from the headphones and if they are unplugged, both red and blue sounds are heard from the speakers.

In **Multi-Stream mode**, the red sound is only played on the headphones and the blue sound is only played on the speakers.

SmartEQ and 3D setting

On this page allow you to customize your listening experience by selecting different profiles for headphones and speakers.

The smart equalizer (EQ) has five presets that automatically enhance the sound quality of music or voice communications. The preset options include: Jazz, Dance, Concert, Classical, and Voice. Each preset has been optimized for the fullest sound experience. For example, the Classical preset emphasizes the middle range of notes while the Dance preset emphasizes the bass end of notes. Selected devices and profiles are denoted by highlighted icons.

To select an equalizer preset, click on the device and then click on the profile desired. For example, to apply the Jazz profile to the speakers:

1. Click on the **Speakers** button.

2. Click on the **Jazz** button and you will immediately hear how the Jazz profile enhances the music output on the speakers.
 3. To disable the selected profile, click on the **OFF** button.
- **Custom** - Profiles will be created when you adjust the Equalizer Bars below the preset icons.
 - **Night Mode** - An option that boosts vocal clarity while maintaining background sound quality. It brings up the volume for subtle sounds like whispers while suppressing the volume of loud sounds like explosions. Night Mode allows you to hear details in soundtracks of high energy sound sources without making the volume louder and potentially disturbing others, which is especially useful for late-night viewing.

Two additional effects are offered on this page that apply to stereo speakers only and are disabled for headphones and mono speaker.

- **Phantom Speakers** - Gives you a closer-to-live experience when you are watching a movie or listening to concert music. If you sit between the internal speakers, the sound you hear will appear to be coming from sources around you, rather than just from the speakers on the PC. This option is ON by default when the Concert profile is selected.
- **3D Immersion** - Gives you a headphone experience without actually wearing one. The effect is particularly useful when you are listening to Voice. This option is ON by default if the Voice profile is selected.

You can adjust the level of the Phantom Speakers and 3D Immersion effects from "None" to "Expanded" by adjusting the Slider Bar under their corresponding icons. For Phantom Speakers, your selection will be depicted by the position of speakers and the opacity of the glow around the speakers and the rays emanating from them. For 3D Immersion, your selection will be depicted by a circle around the PC that will get dimmer or brighter with the movement of the Slider Bar.

Using The Microphone

You can use the built-in or an external microphone that connects to the microphone jack to record monaural sounds into your applications. It can also be used to issue voice commands to applications that support such functions. (Built-in microphone is provided with some models)

Since your computer has a microphone and speaker, "feedback" may be heard under certain conditions. Feedback occurs when sound from the speaker is picked up in the microphone and amplified back to the speaker, which amplifies it again to the microphone.

This feedback occurs repeatedly and causes a very loud, high-pitched noise. It is a common phenomenon that occurs in any sound system when the microphone input is output to the speaker (throughput) and the speaker volume is too loud or too close to the microphone. You can control throughput by adjusting the volume of your speaker or through the Mute function in the Master Volume panel. Refer to your Windows documentation for details on using the Master Volume panel.

Wireless Communications

The computer's wireless communication function supports some wireless communication devices.



- *Do not use the Wireless LAN (Wi-Fi) functionality near a microwave oven or in areas subject to radio interference or magnetic fields. Interference from a microwave oven or other source can disrupt Wi-Fi operation.*
- *Turn all wireless functionalities off when near a person who may have a cardiac pacemaker implant or other medical electric device. Radio waves may affect pacemaker or medical device operation, possibly resulting in serious injury. Follow the instruction of your medical device when using any wireless functionality.*
- *Always turn off wireless functionality if the computer is near automatic control equipment or appliances such as automatic doors or fire detectors. Radio waves can cause malfunction of such equipment, possibly resulting in serious injury.*
- *It may not be possible to make a network connection to a specified network name using the ad hoc network function. If this occurs, the new network(*) will have to be configured for all computers connected to the same network in order to re-enable network connections.*
** Please be sure to use new network name.*

Wireless LAN

The Wireless LAN is compatible with other LAN systems based on Direct Sequence Spread Spectrum/Orthogonal Frequency Division Multiplexing radio technology that complies with IEEE 802.11 Wireless LAN standard (Revision B, G or N).

Setting

1. Please make sure that the **Wireless Communication function** is on.
2. Click **Start** → **Control Panel** → **Network and Internet** → **Network and Sharing Center**.
3. Click **Set up a new connection or network**.
4. Follow the wizard. You will need the name of the wireless network together with security settings. Consult the documentation accompanied with your router or ask your wireless network administrator for the settings.

Security

- Be sure to enable encryption function. Otherwise your computer will allow the illegal access by outsider through Wireless LAN to cause illegal instruction, eavesdropping, and loss or destruction of stored data. TOSHIBA strongly recommends the customer to enable the encryption function.

- TOSHIBA is not liable for the eavesdropping of data due to the use of Wireless LAN and the damage thereof.

Wireless Communication Hot key

You can enable or disable RF transmission(Wireless LAN, etc.) functions on and off by pressing **FN+F8**. No transmissions are sent or received when the function is off.



Set the function to off in airplanes and hospitals.

Turn the computer off when you enter an airplane and check the carrier's regulations before you use a computer on board.

LAN

The computer has built-in support for Fast Ethernet (10BASE-T/100BASE-TX). This section describes how to connect/disconnect to a LAN.



Do not install or remove an optional memory module while Wake-up on LAN is enabled.



The Wake-up on LAN function consumes power even when the system is off. Leave the AC adaptor connected while using this feature.

LAN Cable Types



The computer must be configured properly before connecting to a LAN. Logging onto a LAN using the computer's default settings could cause a malfunction in LAN operation. Check with your LAN administrator regarding set-up procedures.

If you are using Fast Ethernet LAN (100 megabits per second, 100BASE-TX), be sure to connect with a CAT5 cable or higher. You cannot use a CAT3 cable.

If you are using Ethernet LAN (10 megabits per second, 10BASE-T), you can connect with a CAT3 or higher cable.

Connecting LAN Cable



- Connect the AC adaptor before connecting the LAN cable. The AC adaptor must remain connected during LAN use. If you disconnect the AC Adaptor while the computer is accessing a LAN, the system may hang up.
- Do not connect any other cable to the LAN jack except the LAN cable. Otherwise, malfunctions or damage may occur.
- Do not connect any power supplying device to the LAN cable that is connected to the LAN jack. Otherwise, malfunctions or damage may occur.

To connect the LAN cable, follow the steps below.

1. Turn off the power to the computer and to all external devices connected to the computer.
2. Plug one end of the cable into the LAN jack. Press gently until you hear the latch click into place.

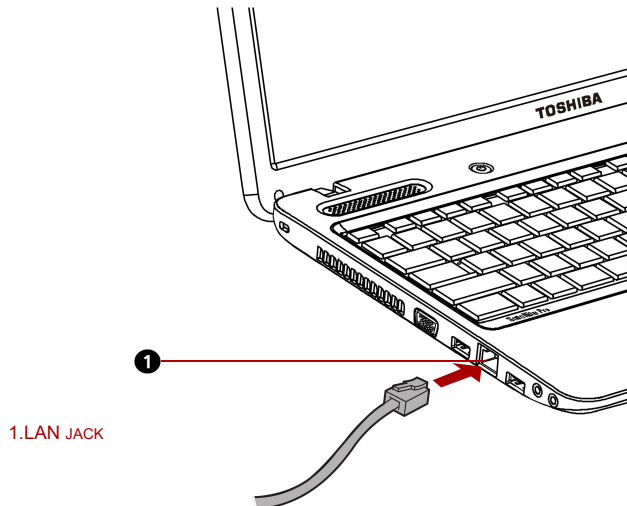

Figure 4-10 Connecting the LAN cable

3. Plug the other end of the cable into a LAN hub connector. Check with your LAN administrator before connecting to a hub.

Disconnecting LAN Cable

To disconnect the LAN cable, follow the steps below.

1. Pinch the lever on the connector in the computer's LAN jack and pull out the connector.
2. Disconnect the cable from the LAN hub in the same manner. Check with your LAN administrator before disconnecting from the hub.

Cleaning The Computer

To help ensure long, trouble-free operation, keep the computer free of dust and use care with liquids around the computer.

- Be careful not to spill liquids into the computer. If the computer does get wet, turn the power off immediately and let the computer dry completely before you turn it on again.
- Clean the computer using a slightly damp (with water) cloth. You can use glass cleaner on the display. Spray a small amount of cleaner on a soft, clean cloth and wipe the screen gently with the cloth.



Never spray cleaner directly onto the computer or let liquid run into any part of it. Never use harsh or caustic chemical products to clean the computer.

Moving The Computer

The computer is designed for rugged durability. However, a few simple precautions taken when moving the computer will help ensure trouble-free operation.

- Make sure all disk activities are terminated before moving the computer.
- If a CD/DVD is in the drive, remove it. Also make sure the drawer is securely closed.
- Turn off the power to the computer.
- Disconnect the AC adapter and all peripherals before moving the computer.
- Close the display. Do not pick up the computer by its display panel.
- Close all port covers.
- Use the carrying case when transporting the computer.
- When carrying your computer, be sure to hold it securely so that it does not fall or hit anything.
- Do not carry your computer by holding protruded portions.

Heat Dispersal

To protect from overheating, the CPU has an internal temperature sensor. If the computer's internal temperature rises to a certain level, the cooling fan is turned on or the processing speed is lowered. You can select whether to control the CPU temperature by turning on the fan first, then if necessary, lowering the CPU speed. Or, turns on fan first, if necessary lowers CPU processing speed earlier than at Maximum Performance Mode for long battery life. These functions are controlled within the Power Options.

When the CPU temperature falls to a normal range, the fan is turned off and the CPU operation returns to standard speed.



If the CPU temperature reaches an unacceptably high level with either setting, the system automatically shuts down to prevent damage. Data in memory will be lost.

Chapter 5

The Keyboard

The number of keys on your keyboard depends on which country/region's keyboard layout your computer is configured with. Keyboards for numerous languages are available.

There are four types of keys: typewriter keys, function keys, soft keys and Windows special keys.

Typewriter Keys

The typewriter keys, produce the uppercase and lowercase letters, numbers, punctuation marks, and special symbols that appear on the screen.

There are some differences, however, between using a typewriter and using a computer keyboard:

- Letters and numbers produced in computer text vary in width. Spaces, which are created by a "space character," may also vary depending on line justification and other factors.
- The lowercase l (el) and the number 1 (one) are not interchangeable on computers as they are on a typewriter.
- The uppercase O (oh) and the 0 (zero) are not interchangeable.
- The **CAPS LOCK** function key locks only the alphabetic characters in uppercase while the shift lock on a typewriter places all keys in the shifted position.
- The **SHIFT** keys, the **TAB** key, and the **BACK SPACE** key perform the same function as their typewriter counterparts but also have special computer functions.

Function Keys: F1 ... F9

The function keys, not to be confused with **FN**, are the 9 keys at the top of your keyboard. These keys are dark gray, but function differently from the other dark gray keys.



F1 through **F9** are called function keys because they execute programmed functions when pressed. Used in combination with the **FN** key, keys marked with icons execute specific functions on the computer. See the section, [Soft Keys: FN Key Combinations](#) in this chapter. The function executed by individual keys depends on the software you are using.

Soft Keys: FN Key Combinations

The **FN** (function) is unique to TOSHIBA computers and is used in combination with other keys to form soft keys. Soft keys are key combinations that enable, disable or configure specific features.



Some software may disable or interfere with soft-key operations. Soft key settings are not restored by the Resume feature.

Hot Keys

Hot keys (pressing **FN** + a function or **ESC** key) allow you to enable or disable certain features of the computer.

Sound mute

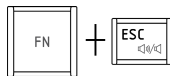

Pressing **FN + ESC** in a Windows environment turns sound on or off. When you press these hot keys, the current setting will be displayed as an icon.

Lock

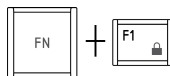

Pressing **FN + F1** enters “Lock computer” mode. To restore your desktop, you need to log on again.

Power plan

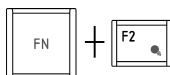

Pressing **FN + F2** changes the power settings.

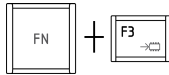
Sleep

Pressing **FN + F3** switches the system to Sleep Mode.

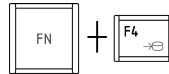
Hibernate

Pressing **FN + F4** switches the system to Hibernation Mode.

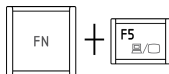
Output

Pressing **FN + F5** changes the active display device.

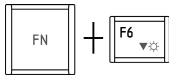
Brightness down

Pressing **FN + F6** decreases the computer's display panel brightness in individual steps.

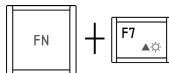
Brightness up

Pressing **FN + F7** increases the computer's display panel brightness in individual steps.

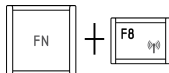
Wireless

Pressing **FN + F8** enables or disables Wireless (WLAN).



If your wireless communication device is not installed, a dialog box will not appear.

Touchpad

Pressing **FN + F9** enables or disables the touchpad function.

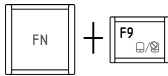
**Zoom**

Pressing **FN + SPACE** changes the display resolution.

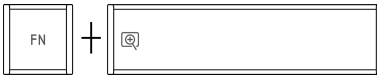
**TOSHIBA zooming utility (reduce)**

Pressing **FN + 1** reduces the icon size on the desktop or the font sizes within one of the supported application windows.

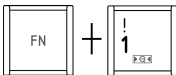
**TOSHIBA zooming utility (enlarge)**

Pressing **FN + 2** enlarges the icon size on the desktop or the font sizes within one of the supported application windows.

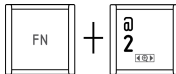
**Volume Down**

Pressing **FN + 3** decreases the volume.

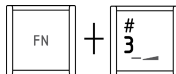
**Volume Up**

Pressing **FN + 4** increases the volume.

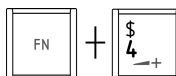
**SYSRQ**

Pressing **FN + HOME** enables SYSRQ function.

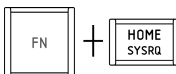
**PRTSC**

Pressing **FN + END** enables PRTSC function.

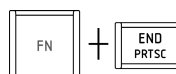

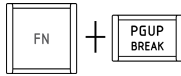
BREAKPressing **FN + PGUP** enables BREAK function.

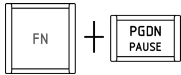
PAUSEPressing **FN + PGDN** enables PAUSE function.

FN Sticky Key

To motive the TOSHIBA Accessibility Utility , you can press **FN** sticky key once and then press any "**F number**".

To start the TOSHIBA Accessibility Utility, click **Start** → **All Programs** → **TOSHIBA** → **Utilities** → **Accessibility**.

Windows Special Keys

The keyboard provides two keys that have special functions in Windows: one activates the **Start** menu and the other has the same function as the secondary mouse button.



This key activates the Windows **Start** menu.

This key has the same function as the secondary mouse button.

Generating ASCII Characters

Not all ASCII characters can be generated using normal keyboard operation. But, you can generate these characters using their ASCII codes.

1. Hold down **ALT**.
2. Using the numeric keypad, type the ASCII code.
3. Release **ALT**, and the ASCII character appears on the display screen.

Chapter 6

Power and Power-up Modes

The computer's power resources include the AC adaptor and internal batteries. This chapter gives details on making the most effective use of these resources including charging and changing batteries, tips for saving battery power, and power-up modes.

Power Conditions

The computer's operating capability and battery charge status are affected by the power conditions: whether an AC adaptor is connected, whether a battery is installed and what the charge level is for the battery.

Power conditions Table

		Power on	Power off (no operation)
AC adaptor connected	Battery fully charged	<ul style="list-style-type: none"> Operates DC IN/Battery LED: green 	<ul style="list-style-type: none"> DC IN/Battery LED: green
	Battery partially charged or no charge	<ul style="list-style-type: none"> Operates Quick Charge DC IN/Battery LED: amber 	<ul style="list-style-type: none"> Quick charge DC IN/Battery LED: amber
	No battery installed	<ul style="list-style-type: none"> Operates No charge DC IN/Battery LED: green 	<ul style="list-style-type: none"> No charge DC IN/Battery LED: green

		Power on	Power off (no operation)
AC adaptor not connected	Battery charge is above low battery trigger point	<ul style="list-style-type: none"> Operates DC IN/Battery LED: amber 	
	Battery charge is below low battery trigger point	<ul style="list-style-type: none"> Operates DC IN/Battery LED: blinking amber 	
	Battery charge is exhausted	Computer goes into hibernation or shuts down (depending on the TOSHIBA power Management Utility Setting)	
	No battery installed	<ul style="list-style-type: none"> No operation DC IN/Battery LED: off 	

System Indicators

The **DC IN/Battery** and **Power** indicators on the system indicator panel alert you to the computer's operating capability and battery charge status.

DC IN/Battery Indicator

Check the **DC IN/Battery** indicator to determine the status of the battery pack- the following indicator conditions should be noted:

Blinking amber	Indicates battery charge is below low battery trigger point
Amber	Indicates the AC adaptor is connected and charging the battery.
Green	Indicates the AC adaptor is connected or the battery is fully charged.
No light	Under any other conditions, the indicator does not light.



*If the battery becomes too hot while it is being charged, the charge will stop and the **DC IN/Battery** indicator will go out. When the battery's temperature falls to a normal range, charge will resume. This event occurs regardless of whether the power to the computer is on or off.*

Power Indicator

Check the **Power** indicator to determine the power status of the computer - the following indicator conditions should be noted:

Green	Indicates power is being supplied to the computer and the computer is turned on.
Blinking green	Indicates the power was turned off while the computer was in Sleep Mode.
No light	Under any other conditions, the indicator does not light.

Battery Types

The computer has two different types of batteries:

- Battery — 3 cell or 6 cell (depending on the models)
- Real Time Clock (RTC) battery

Battery

When the AC power cord is not connected, the computer's main power source is a removable lithium ion battery pack, also referred to in this manual as the battery. You can purchase additional battery packs for extended use of the computer away from an AC power source.



The battery pack is a lithium ion battery, which can explode if not properly replaced, used, handled or disposed of. Dispose of the battery as required by local ordinances or regulations. Use only batteries recommended by TOSHIBA as replacements.

The battery maintains the state of the computer when you enable Resume.



When the computer is powered off in Hibernation and Sleep Mode, and the AC adaptor is not connected, the battery pack supply power to maintain data and programs in memory. If the battery pack is completely discharged, hibernation and sleep do not function and the computer loses all data in memory. One of the following messages appears when you turn on the power:

The firmware has detected that a CMOS battery fail occurred.<F1> continue

The firmware has detected that a CMOS battery fail occurred.<F1> continue, <F2> to setup

To ensure that the battery pack maintains its maximum capacity, operate the computer on battery power at least once a month until the battery pack is fully discharged. Refer to [Extending Battery Life](#) in this chapter for procedures. If the computer is continuously operated on AC power, more than a month, the battery may fail to retain a charge. It may not function efficiently over the expected life of the battery and the Battery LED may not indicate a low-battery condition.

Real Time Clock Battery

The Real Time Clock (RTC) battery provides power for the internal real time clock and calendar. It also maintains the system configuration.

If the RTC battery becomes completely discharged, the system loses this data and the real time clock and calendar stop working. One of the following messages appears when you turn on the power:

```
The firmware has detected that a CMOS
battery fail occurred.<F1> continue
The firmware has detected that a CMOS
battery fail occurred.<F1> continue,
<F2> to setup
```



The computer's RTC battery is a lithium battery and should be replaced only by your dealer or by a TOSHIBA service representative. The battery can explode if not properly replaced, used, handled or disposed of. Dispose of the battery as required by local ordinances or regulations

Care and Use of The Battery Pack

The battery pack is a vital component of portable computing. Taking proper care of it will help ensure longer operating time on battery power as well as a longer life for your battery pack. Follow the instructions in this section carefully to ensure safe operation and maximum performance.

Safety Precautions

Mishandling of batteries can cause death, serious injury or property damage. Carefully observe the following advisories:

Danger: Indicates an imminently hazardous situation, Which could result in death or serious injury, if you do not follow instructions.

Warning: Indicates a potentially hazardous situation, Which could result in death or serious injury, if you do not follow instructions.

Caution: Indicates a potentially hazardous situation, Which if not avoided, may result in moderate or minor injury or property damage.

Note: Provides important information.

Danger

1. Never try to dispose of the battery pack by burning or expose it to a heating device such as a microwave oven. The battery pack could explode and cause bodily injury.
2. Never try to disassemble, repair or otherwise tamper with a battery pack. The battery pack will overheat and ignite. Leakage of caustic alkaline solution or other electrolytic substances will cause fire or injury, possibly resulting in death or serious injury.
3. Never short-circuit the battery pack by contacting the terminals with a metal object. A short-circuit can cause fire or otherwise damage the battery pack and possibly cause injury. To avoid accidental short-circuit, always wrap the battery pack in plastic and cover the terminals with electrical tape when storing or disposing of the battery pack.
4. Never puncture the battery pack with a nail or other sharp object. Never strike it with a hammer or other object. Never step on it.
5. Never try to change the battery pack in any manner other than that described in user's manual. Never connect the battery pack to a plug socket or to a automobile's cigarette lighter socket. It may rupture or ignite.
6. Use only the battery pack supplied with the computer or other device or an battery pack approved by the computer or device's manufacturer. Battery packs have different voltages and terminal polarities. Use of an improper battery could cause smoke, fire or rupture of the battery pack.
7. Never subject a battery pack to heat, such as storage near a heat source. Exposure to heat can cause the battery pack to ignite, explode or leak caustic liquid and cause death or serious injury. It could also fail or malfunction causing data lose.
8. Never expose the battery pack to abnormal shock, vibration or pressure. The battery pack's internal protective device will fail, causing it to overheat, explode, ignite or leak caustic liquids possibly resulting in death or serious injury.
9. Never let a battery pack become wet. A wet battery pack will overheat, ignite or rupture possibly resulting in death or serious injury.

Warning

1. Never allow caustic electrolyte fluid leaked from a battery pack to contact your eyes, skin or clothing. If caustic electrolyte fluid should contact your eyes, immediately wash your eyes with large amounts of running water and seek medical attention, to help prevent eye damage. If electrolyte fluid should contact your skin immediately wash it under running water to prevent rash. If it contacts your clothes, promptly remove them to prevent the fluid from contacting your skin or eyes.

2. Immediately turn off the power, disconnect the AC adaptor and remove the battery if any of the following events are observed in the battery pack: offensive or unusual odor, excessive heat, discoloration or deformation. Never use the computer again until it has been checked by a TOSHIBA service provider. It might generate smoke or fire, or the battery pack might rupture.
3. Make sure the battery is securely installed in the computer before attempting to charge the battery pack. Improper installation could generate smoke or fire, or cause the battery pack to rupture.
4. Keep the battery pack out of reach of infants and children. It can cause injury.

Caution

1. Never continue to use a battery pack after its recharging capacity has become impaired, or after the display of a warning message indicating that the battery pack's power is exhausted. Continued use of an exhausted or impaired battery pack could cause the loss of data.
2. Never dispose of battery packs with normal trash. Bring them to your TOSHIBA dealer or to another recycling center to save resources and prevent environmental damage. Cover the terminals with electrical tape to prevent short-circuits, which could cause the battery pack to ignite or rupture.
3. Use only battery packs recommended by TOSHIBA as replacements.
4. Always make sure the battery pack is installed correctly and securely. Otherwise, a battery pack could fall out and possibly cause injury.
5. Change the battery pack only in an ambient temperature between 5 and 35 degrees Celsius. Otherwise, the electrolyte solution might leak, battery pack performance might deteriorate and the battery life might be shortened.
6. Be sure to monitor the remaining battery power. If the battery pack and real time clock battery discharge completely. Sleep and hibernation will not function and data in memory will be lost. Also, the computer might register an incorrect time and date. In this case, connect the AC adaptor to recharge the batteries.
7. Never install or remove the battery pack without first turning off the power and disconnecting the AC adaptor. Never remove the battery pack while the computer is in Hibernate or Sleep Mode. Data will be lost.

Note

1. Never remove the battery pack while the Wake-up on LAN function is enabled. Data will be lost. Before you remove a battery pack, disable the Wake-up on LAN function.
2. To ensure the battery pack maintains maximum capacity, operate the computer on battery power once a week until the battery pack is fully discharged. Refer to the section [Extending Battery Life](#) in this chapter

for procedures. If the computer is continuously operated on AC power for an extended period, more than a month, the battery might fail to retain a charge. It might not function efficiently over the expected life of the battery pack and **DC IN/Battery** indicator might not indicate a low-battery condition.

3. After the battery pack is charged, avoid leaving the AC adaptor connected and the computer turned off for more than a few hours at a time. Continuing to charge a fully-charged battery pack can damage the battery.

Charging The Batteries

When the power in the battery pack becomes low, the **DC IN/Battery** indicator flashes amber indicating that only a few minutes of battery power remain. If you continue to use the computer while the **DC IN/Battery** indicator flashes, the computer enables hibernation mode (so you don't lose data) and automatically turns off.

You must recharge a battery pack when it becomes discharged.

Procedures

To recharge a battery pack while it is installed in the computer, connect the AC adaptor to the **DC IN** socket and plug the other end into a working outlet.

The **DC IN/Battery** indicator glows amber when the battery is being charged.



Use only the computer connected to an AC power source or the optional TOSHIBA Batteries charger to charge the battery pack. Never attempt to charge the battery pack with any other charger.

Time

The following table shows the approximate time required to fully charge a discharged battery.

Charging time (hours)

Battery type	Power on	Power off
Battery pack (3 cell)	8 hours or more	2.5 hours
Battery pack (6 cell)	8 hours or more	3.8 hours



The charging time when the computer is on is affected by ambient temperature, the temperature of the computer and how you use the computer. If you make heavy use of external devices, for example, the battery might scarcely charge at all during operation. Refer also to the section [Maximizing Battery Operating Time](#).

Battery Charging Notice

The battery may not charge right away under the following conditions:

- The battery is extremely hot or cold. If the battery is extremely hot, it might not charge at all. Also, to ensure the battery charges to its full capacity, charge the battery at room temperature of 10° to 30°C (50° to 86°F).
- The battery is nearly completely discharged. Leave the AC adaptor connected for a few minutes and the battery should begin charging.

The **DC IN/Battery** indicator may show a rapid decrease in battery operating time when you try to charge a battery under the following conditions:

- The battery has not been used for a long time.
- The battery has completely discharged and been left in the computer for a long time.
- A cool battery is installed in a warm computer.

In such case, follow the steps below.

1. Fully discharge the battery by leaving it in the computer with the power on until the power automatically shuts off.
2. Plug in the AC adaptor.
3. Charge the battery until the **DC IN/Battery** indicator glows green.

Repeat the steps two or three times until the battery recovers normal capacity.



Leaving the AC adaptor connected will shorten battery life. At least once a month, run the computer on battery power until the battery is fully discharged, then recharged the battery.

Monitoring Battery Capacity

Remaining battery power can be monitored in Power Options.

- Clicking the battery icon on the Taskbar



- *You should wait at least 16 seconds after turning on the computer before trying to monitor the remaining operating time. This is because the computer needs this time to check the battery's remaining capacity and then calculate the remaining operating time, based on this together with the current power consumption.*
- *Please be aware that the actual remaining operating time may differ slightly from the calculated time.*
- *With repeated discharges and recharges, the battery's capacity will gradually decrease. In view of this it will be noted that an often used, older battery will not operate for as long as a new battery even when both are fully charged.*

Maximizing Battery Operating Time

A battery's usefulness depends on how long it can supply power on a single charge.

How long the charge lasts in a battery depends on:

- How you configure the computer (for example, whether you enable battery-power saving options). The computer provides a battery save mode, which can be set in Power Options, to conserve battery power. This mode has the following options:
 - CPU Precessing speed
 - Screen brightness
 - Cooling Method
 - System sleep
 - System hibernation
 - Monitor Power off
 - HDD Power off
- How often and how long you use the hard disk, optical disc drive and the diskette drive.
- How much charge the battery contained to begin with.
- How you use optional devices, such as an external monitor, to which the battery supplies power.
- Enabling Hibernation and Sleep Mode conserves battery power if you are frequently turning the computer off and on.
- Where you store your programs and data.
- Closing the display when you are not using the keyboard saves power.
- Operating time decreases at low temperatures.
- The condition of the battery terminals. Make sure the battery terminals stay clean by wiping them with a clean dry cloth before installing the battery pack.

Retaining Data with Power off

When you turn off your computer with fully charged batteries, the batteries retain data for the following approximate time periods.

Retention Time

Battery type	State and Retention Time
Battery pack (3 cell)	about 28 hours (Sleep Mode) about 11 days (Shut Down Mode)
Battery pack (6 cell)	about 40 hours (Sleep Mode) about 18.5 days (Shut Down Mode)

Extending Battery Life

To maximize the life of your battery packs:

- At least once a month, disconnect the computer from a power source and operate it on battery power until the battery pack fully discharges. Before doing so, follow the steps below.
 1. Turn off the computer's power.
 2. Disconnect the AC adaptor and turn on the computer's power. If it does not turn on then go to Step 4.
 3. Operate the computer on battery power for five minutes. If the battery pack has at least five minutes of operating time, continue operating until the battery pack is fully discharged. If the **DC IN/Battery** LED flashes or there is some other warning to indicate a low battery, go to step 4.
 4. Connect the AC adaptor to the computer and the power cord to a power outlet.
 5. Charge the battery pack until the **DC IN/Battery** indicator glows green.
- If you have extra battery packs, rotate their use.
- If you will not be using the system for an extended period more than one month, remove the battery pack.
- Disconnect the AC adaptor when the battery is fully charged. Overcharging makes the battery hot and shortens life.
- If you are not going to use the computer for more than eight hours, disconnect the AC adaptor.
- Store spare battery packs in a cool dry place out of direct sunlight.

Replacing The Battery Pack

When the battery pack reaches the end of its operating life you will need to install a new one. If the **DC IN/Battery** indicator flashes amber shortly after fully recharging the battery, the battery pack needs to be replaced. You might also replace a discharged battery pack with a charged spare when you are operating your computer away from an AC power source. This section explains how to remove and install battery packs.

Removing The Battery Pack

To remove a discharged battery, follow the steps as detailed below:



- *When handling battery pack, be careful not to short circuit the terminals. Also do not drop, hit or otherwise apply impact; do not scratch or break the casing and do not twist or bend the battery pack.*
- *Do not remove the battery pack while the computer is in Sleep Mode. Data is stored in RAM, so if the computer loses power it will be lose.*
- *In Hibernation Mode, data will be lose if you remove the battery or disconnect the AC adaptor before the save is completed. Wait for the optical disc drive indicator and external device indicator to go out.*

1. Save your work.
2. Turn the computer's power off. Make sure the **Power** indicator is off.
3. Remove all cables connected to the computer.
4. Turn the computer upside down with the back of the computer facing you.
5. Slide the battery pack locking latch toward the unlock position.

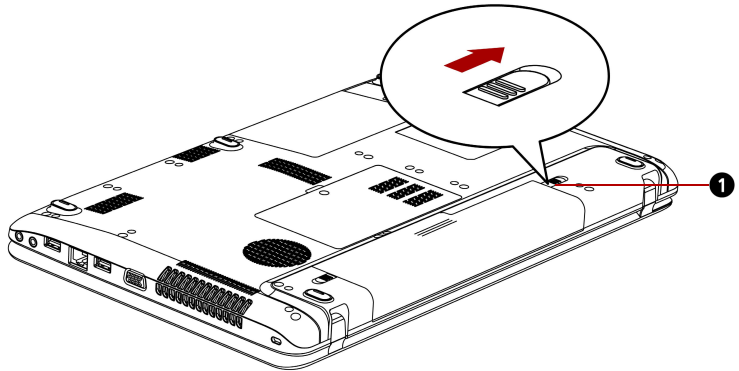

1. BATTERY PACK LOCK

Figure 6-1 Slide the locking latch to the unlocked position

- Slide the battery release latch to free the battery pack for removal, then pull out the battery pack.

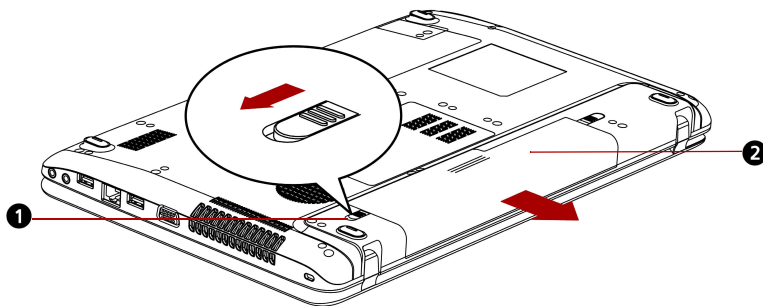

- BATTERY RELEASE LATCH
- BATTERY PACK

Figure 6-2 Removing the battery pack

- Pull the battery pack forward to remove it.



For environmental reasons, do not throw away a spent battery pack. Please return spent battery pack to your TOSHIBA dealer.

Installing The Battery Pack

To install a battery pack, follow the steps below.



The battery pack is a lithium ion battery, which can explode if not properly replaced, used, handled or disposed of. Dispose of the battery as required by local ordinances or regulations. Use only batteries recommended by TOSHIBA as replacements.

- Be sure the computer's power is off and all cables are disconnected.
- Insert the battery pack.

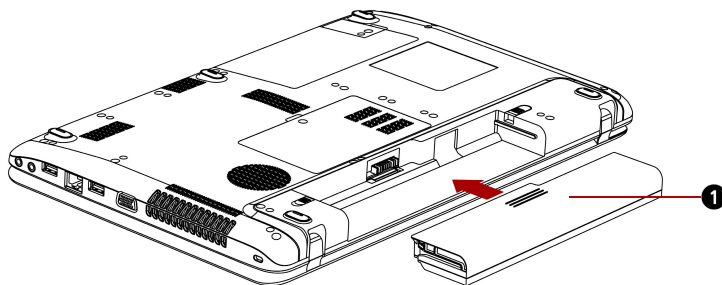

- BATTERY PACK

Figure 6-3 Installing the battery pack

3. Push the battery pack until it is firmly seated.
4. Slide the battery pack locking latch toward the lock position.

Starting The Computer by Password

If you have already registered a password, there are two ways to start the computer:

- TOSHIBA Face Recognition uses a face verification library to verify the face data of users when they log in to Windows. If the verification is successful, the user will be logged into Windows automatically. The user can thus avoid having to enter a password or the like, which makes the login process easier.
- Enter a password manually.

To enter a password manually, follow these steps:

1. Turn on the power as described in Chapter 1, [Getting Started](#). The following message appears:

Enter Current Password



*At this point, the hot keys **FN + F1** to **F9** do not work. They will function after you enter the password.*

2. Enter the password.
3. Press **ENTER**.



If you enter the password incorrectly three times in a row, the computer shuts off. In this case, you must turn the computer back on to retry password entry.

Power-up Modes

The computer has the following power-up modes:

- Boot: Computer shuts down without saving data. Always save your work before you turn the computer off in boot mode.
- Hibernation: Data in memory is saved to the hard disk.
- Sleep: Data is maintained in the computer's main memory.



Refer also to the sections [Turning On The Power](#) and [Turning Off The Power](#) in Chapter 1.

Windows Utilities

You can specify the setting in Power Options.

Hot Keys

You can use hot keys **FN + F3** to enter Sleep Mode and **FN + F4** to enter Hibernation Mode. See Chapter 5, [The Keyboard](#) for details.

Panel Power On/Off

You can set up your computer so that power turns off automatically when you close the display panel. When you open the panel, power turns on in Sleep or Hibernation Mode but not in boot mode.



If the panel power off function is enabled and use Shut down Windows, do not close the display until the shut down function is completed.

System Auto Off

This feature turns the system off automatically if it is not used for a set duration. The system shuts down in Sleep Mode or Hibernation Mode.

Chapter 7

HW Setup and Passwords

This chapter explains how to use TOSHIBA HW Setup program to configure your computer, and provides information on settings for various functions.

Accessing HW Setup

To run the HW Setup program, click **Start** → **All Programs** → **TOSHIBA** → **Utilities** → **HWSetup**.

HW Setup Window

The HW Setup window contains a number of tabs (General, Password, Display, Boot Priority, Keyboard, LAN and USB) to allow specific functions of the computer to be configured. In addition there are also three buttons : **OK**, **Cancel** and **Apply**.

OK	Accepts your changes and closes the HW Setup window.
Cancel	Closes the window without accepting your changes.
Apply	Accepts all your changes without closing the HW Setup window.

General

This window displays the BIOS/EC version and contains two buttons: **Default** and **About**.

Default	Returns all HW Setup values to the factory settings.
About	Displays the HW Setup version.

Setup

This field displays the installed **BIOS version**, **date** and **EC version**.

Password

User Password

Lets you register a new password or change/remove an existing password.

Not Registered	Changes or remove the password. (Default)
Registered	Sets the password. A dialogue box will appear to allow you to set the password.

Owner String

This blank field is used to display a message when the password field is displayed on startup. If a password is not registered the message will not be shown. The maximum length is 256 characters.

Display

This tab allows you to customize your computer's display settings for either the internal LCD screen or for an external monitor.

Power On Display

This tab allows you to select the display to be used when the computer is started. Please note that this setting is only available on standard VGA mode and is not available as part of the Windows Desktop properties.



The Power On Display is supported with some models.

Auto-Selected	Selects an external monitor if one is connected, otherwise, it selects the internal display (Default).
System LCD only	Selects the internal LCD, even if an external monitor is connected.

Boot Priority

Boot Priority Options

This tab allows you to set the priority for booting the computer. The Boot Priority Options setting window will be displayed as shown below. Click the up and down arrow buttons to adjust the priority.

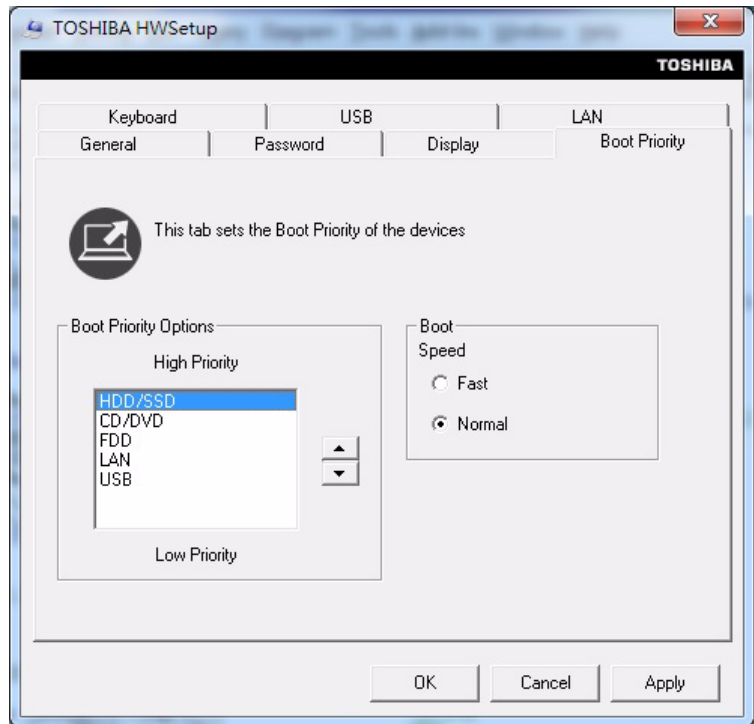

You can override the settings and manually select a boot device by pressing one of the following keys while the computer is booting:

U	Selects the USB diskette drive*1.
N	Selects the network.
1	Selects the built-in hard disk drive.
C	Selects the CD-ROM*2.
S	Selects the USB memory drive.

*1 The floppy diskette drive will be used to start the computer when there is a bootable disk contained in the external drive.

*2 The optical disc drive will be used to start the computer when there is a bootable disk contained in the drive.

To change the boot drive, follow the steps below.

1. Hold down **F12** and boot the computer. When the TOSHIBA Leading Innovation>>> screen appears, release the **F12** key.
2. Use the up and down cursor keys to select boot device you want and press **ENTER**.



If a Supervisor Password has been set, manual boot device selection functions may be restricted.

The boot device selection methods described above will not change the boot priority settings that have been configured in HW Setup. In addition, if you press a key other than one of those listed, or if the selected device is not installed, the system will continue to boot according to the current and available settings in HW Setup.

Keyboard

Wake-up on Keyboard

When this feature is enabled and the computer is in Sleep Mode, you can turn on the computer by pressing any key. However, please be aware that this option will only work with the internal keyboard and only when the computer is in Sleep Mode.

Enabled	Enables the Wake-up on Keyboard function.
Disabled	Disables the Wake-up on Keyboard function. (Default)

USB

Legacy USB Support

You can use this option to enable or disable USB keyboard/mouse legacy emulation so that, even if your operating system does not support USB devices, you can still use a standard USB mouse and keyboard - to achieve this you should set the appropriate option(s) to Enabled.

Enabled	Enables the USB KB/Mouse Legacy Emulation function (Default).
Disabled	Disables the USB KB/Mouse Legacy Emulation function.

LAN

Wake-up on LAN

This feature lets the computer's power be turned on from shutdown when it receives a wake-up packet (Magic packet) from the LAN.



Do not install or remove a memory module while Wake-up on LAN is enabled.



- *The Wake-up on LAN function consumes power even when the system is off. Leave the AC adaptor connected while using this feature.*
- *Regarding Wake-up on LAN from sleep or hibernation, you must check the "allow the device to wake the computer" check box within the LAN Device properties. (This feature does not effect the Wake-up on LAN from sleep or hibernation.)*

Power will be automatically turned on when a signal is received from an administrator's computer which is connected via a network. The following settings can be changed when the Built-in LAN is **Enabled**. Connect the AC adaptor when using the Wake-up on LAN function. The battery retention time will be shorter than the times listed in this manual when this function is enabled. Refer to the section in chapter 6, [Retaining Data with Power off](#).

Enabled	Enables Wake-up on LAN from shutdown.
Disabled	Disables Wake-up on LAN from shutdown. (Default)

Built-in LAN

This feature enables or disables the Built-in LAN.

Enabled	Enables built-in LAN functions. (Default)
Disabled	Disables built-in LAN functions.

Chapter 8

Troubleshooting

TOSHIBA designed the computer for durability. However, should problems occur, following the procedures in this chapter can help to determine the cause.

All readers should become familiar with this chapter. Knowing what might go wrong can help prevent problems from occurring.

Problem Solving Process

Resolving problems will be much easier if you observe the following guidelines:

- Stop immediately when you recognize a problem exists. Further action may result in data loss or damage. You may destroy valuable problem-related information that can help solve the problem.
- Observe what is happening. Write down what the system is doing and what actions you performed immediately before the problem occurred. If you have a printer attached, print a copy of the screen using the PRTSC(Print Screen) key by pressing **FN+END**.

The questions and procedures offered in this chapter are meant as a guide, they are not definitive problem solving techniques. Many problems can be solved simply, but a few may require help from your dealer. If you find you need to consult your dealer or others, be prepared to describe the problem in as much detail as possible.

Preliminary Checklist

Consider the simplest solution first. The items in this checklist are easy to fix and yet can cause what appears to be a serious problem.

- Make sure you turn on all peripheral devices before you turn on the computer. This includes your printer and any other external device you are using.
- Before you attach an external device, turn the computer off. When you turn the computer back on it recognizes the new device.
- Make sure all options are set properly in the setup program.
- Check all cables. Are they correctly and firmly attached? Loose cables can cause signal errors.
- Inspect all connecting cables for loose wires and all connectors for loose pins.
- Check that your diskette is correctly inserted and that the diskette's write protect tab is correctly set.

Make notes of your observations and keep them in a permanent error log. This will help you describe your problems to your dealer. If a problem recurs, the log will help you identify the problem faster.

Analyzing The Problem

Sometimes the system gives clues that can help you identify why it is malfunctioning. Keep the following questions in mind:

- Which part of the system is not operating properly: keyboard, diskette drives, hard disk drive, printer, display. Each device produces different symptoms.
- Is the operating system configuration set properly? Check the configuration options.
- What appears on the display screen? Does it display any messages or random characters? Print a copy of the screen if you have a printer attached. Look up the messages in the software and operating system documentation.
- Check that all connecting cables are correctly and firmly attached. Loose cables can cause erroneous or intermittent signals.
- Do any icons light? Which ones? What color are they? Do they stay on or blink? Write down what you see.
- Do you hear any beeps, if so how many, are they long or short and are they high pitched or low pitched? In addition, is the computer making any unusual noises? Write down what you hear. Record your observations so you can describe them to your dealer.

Software	<p>The problems may be caused by your software or diskette. If you cannot load a software package, the media (usually a diskette) may be damaged or the program might be corrupted. Try loading another copy of the software.</p> <p>If an error message appears while you are using a software package, check the software documentation. These documents usually include a problem solving section or a summary of error messages.</p> <p>Next, check any error messages in the OS documentation.</p>
Hardware	<p>If you cannot find a software problem, check your hardware. First run through the items in the preliminary checklist above. If you still cannot correct the problem, try to identify the source. The next section provides checklists for individual components and peripherals.</p>



Before using a peripheral device or application software that is not an authorized TOSHIBA part or product, make sure the device or software can be used with your computer. Use of incompatible devices may cause injury or may damage your computer.

Hardware and System Checklist

This section discusses problems caused by your computer's hardware or attached peripherals. Basic problems may occur in the following areas:

- System start-up
- Self test
- Power
- Password
- Keyboard
- LCD panel
- Hard disk drive
- DVD Super Multi (±R DL) drive
- Diskette drive
- Pointing device
- Memory cards: Secure Digital (SD), Secure Digital High Capacity (SDHC), Secure Digital Extended Capacity (SDXC) and MultiMediaCard (MMC)
- External Monitor
- Sound System
- USB
- Sleep/Hibernation
- LAN
- Wireless LAN
- Recovery Media

System Start-up

When the computer does not start properly, check the following items:

- Self Test
- Power Sources
- Power-on Password

Self Test

When the computer starts up, the self-test will be run automatically, and the following will be displayed:

```
TOSHIBA Leading Innovation>>>
```

This message remains on the screen for a few seconds.

If the self test is successful, the computer tries to load the operating system.

Depending on how the Boot Priority is set in the Hardware Setup, the computer tries to load first from drive A then from drive C, or first from drive C then from drive A.

If any of the following conditions are present, the self test failed:

- The computer stops and does not proceed to display information or messages.
- Random characters appear on the screen, and the system does not function normally.
- The screen displays an error message.

Turn off the computer and check all cable connections. If the test fails again, contact your dealer.

Power

When the computer is not plugged into an AC adaptor, the battery pack is the primary power source. However, your computer has a number of other power resources, including intelligent power supply and Real Time Clock battery. These resources are interrelated and any one could affect apparent power problems.

This section provides check lists for AC adaptor and the main battery. If you cannot resolve a problem after following them, the cause could lie with another power resource. In such case, contact your dealer.

Overheating Power Down

If the processor's temperature reaches an unacceptably high level with either setting, the computer will automatically shut down to prevent any damage - in this instance all unsaved data in memory will be lost.

AC Power

If you have trouble turning on the computer with the AC adaptor connected, check the **DC IN/Battery** indicator. Refer to Chapter 6, *Power and Power-up Modes* for more information.

Problem	Procedure
AC adaptor doesn't power the computer	<p>Check the connections. Make sure the cord is firmly connected to the computer and a power outlet.</p> <hr/> <p>Check the condition of the cord and terminals. If the cord is frayed or damaged, replace it. If the terminals are soiled, wipe them with cotton or a cleaning cloth.</p> <hr/> <p>If the AC adaptor still does not power the computer, contact your dealer.</p>

Battery

If you suspect a problem with the battery, check the **DC IN/Battery** indicator. For information on indicators and battery operation see Chapter 6, *Power and Power-up Modes*.

Problem	Procedure
Battery doesn't power the computer	The battery may be discharged - connect the AC adaptor to recharge the battery.
Battery doesn't charge when the AC adaptor is attached	<p>If the battery is completely discharged, it will not begin charging immediately. Wait a few minutes.</p> <hr/> <p>If the battery still does not charge, make sure the outlet is supplying power. Test it by plugging in an appliance. If it doesn't work, try another power source.</p> <hr/> <p>Check whether the battery is hot or cold to the touch. If the battery is too hot or too cold, it will not charge properly. Let it reach room temperature.</p> <hr/> <p>Unplug the AC adaptor and remove the battery to make sure the terminals are clean. If necessary wipe them with a soft dry cloth dipped in alcohol. Connect the AC adaptor and replace the battery. Make sure it is securely seated.</p>

Problem	Procedure
	<p>Check the DC IN/Battery indicator. If it does not glow, let the computer charge the battery for at least 20 minutes. If the DC IN/Battery indicator glows after 20 minutes, let the battery continue to charge at least another 20 minutes before turning on the computer.</p> <p>If the indicator still does not glow, the battery may be at the end of its operating life. Replace it. If you do not think the battery is at the end of its operating life, see your dealer.</p>
<p>Battery doesn't power the computer as long as expected</p>	<p>If you frequently recharge a partially charged battery, the battery might not charge to its full potential. Fully discharge the battery, then try to charge it again.</p> <p>Check the power consumption settings in Power Options. Consider using a power saving mode.</p>

Password

Problem	Procedure
<p>Cannot enter password</p>	<p>Refer to the Password section in Chapter 7, HW Setup and Passwords.</p>

Keyboard

Keyboard problems can be caused by your setup configuration. For more information refer to Chapter 5, [The Keyboard](#) and Chapter 7, [HW Setup and Passwords](#).

Problem	Procedure
<p>Output to screen is garbled</p>	<p>Make sure the software you are using is not remapping the keyboard. Remapping involves reassigning the meaning of each key. See your software's documentation.</p> <p>If you are still unable to use the keyboard, consult your dealer.</p>

LCD Panel

Apparent LCD problems may be related to the computer's setup. Refer to Chapter 7, *HW Setup and Passwords*, for more information.

Problem	Procedure
No display	Press hot keys FN + F5 to change the display priority, to make sure it is not set for an external monitor.
Markings appear on the LCD screen.	They might have come from contact with the keyboard or touchpad. Try wiping the LCD gently with a clean dry cloth. If markings remain, use LCD cleaner. Be sure to let the LCD dry before closing it.
Problems above remain unresolved or other problems occur	Refer to your software's documentation to determine if the software is causing the difficulty. Contact your dealer if the problems continue.

Hard Disk Drive

Problem	Procedure
Computer does not boot from Hard Disk Drive	Check if a diskette is in the diskette drive or a CD/DVD is in the optical disc drive. Remove any diskette and/or CD/DVD and check Boot priority. Refer to Chapter 7, <i>Boot Priority</i> section. There may be a problem with your operating system files. Refer to your OS documentation.
Slow performance	Your files may be fragmented. Run SCANDISK and defragmenter to check the condition of your files and disk. Refer to your OS documentation or online HELP for information on running SCANDISK and the defragmenter. As a last resort, reformat the hard disk. Then, reload the operating system and other files. If problems persist, contact your dealer.

DVD Super Multi(±R DL) Drive

For more information, refer to Chapter 4, [Operating Basics](#).

Problem	Procedure
<p>You cannot access a CD/DVD in the drive</p>	<p>Make sure the drive's drawer is securely closed. Press gently until it clicks into place.</p> <hr/> <p>Open the drawer and make sure the CD/DVD is properly seated. It should lie flat with the label facing up.</p> <hr/> <p>A foreign object in the drawer could block laser light from reading the CD or DVD. Make sure there is no obstruction. Remove any foreign object.</p> <hr/> <p>Check whether the DVD is dirty. If it is, wipe it with a cleaning cloth dipped in water or a neutral cleaner. See the Media Care section in Chapter 4 for details on cleaning.</p>
<p>Some CD/DVDs run correctly, but others do not</p>	<p>The software or hardware configuration may be causing a problem. Make sure the hardware configuration matches your software's needs. Check the CD/DVD's documentation.</p> <hr/> <p>Check the type of CD/DVD you are using. Refer to Chapter 3, Hardware, Utilities and Options for more information.</p> <hr/> <p>Check the region code on the DVD. It must match that on the drive. Region codes are listed in the Optical Disc Drive section in Chapter 2, The Grand Tour.</p>
<p>Cannot write correctly</p>	<p>If you have trouble writing, make sure you are observing the following precautions:</p> <ul style="list-style-type: none"> ■ Use only media recommended by TOSHIBA ■ Do not use the mouse or keyboard during writing. ■ Use only the software supplied with the computer for recording. ■ Do not run or start other software during writing. ■ Do not jar the computer during writing. ■ Do not connect/disconnect external devices or install/remove internal cards during writing. <p>If problems persist, contact your dealer.</p>

Diskette Drive

Problem	Procedure
Drive does not operate	There may be a faulty cable connection. Check the connection to the computer and to the drive.
Some programs run correctly but others do not	The software or hardware configuration may be causing a problem. Make sure the hardware configuration matches your software needs.
You cannot access the external diskette drive	Try another diskette. If you can access the diskette, the original diskette (not the drive) is probably causing the problem.
	If problems persist, contact your dealer.

Pointing Device

If you are using a USB mouse, also refer to the [USB](#) section in this chapter and to your mouse documentation.

Touchpad

Problem	Procedure
On-screen pointer does not respond to Pad operation	The system might be busy. If the pointer is shaped as an hourglass, wait for it to resume its normal shape and try again to move it.
Double-tapping does not work	Try changing the double-click speed setting in the mouse control utility. Click Start → Control Panel → Hardware and Sound → Mouse to access it.

Problem	Procedure
The mouse pointer moves too fast or too slow	Try changing the speed setting in the mouse control utility. Click Start → Control Panel → Hardware and Sound → Mouse to access it.
When the reaction of touchpad is sensitive to slow	<p>Adjust the touch Sensitivity.</p> <ol style="list-style-type: none"> 1. Open the Control Panel. 2. Click the Hardware and Sound icon. 3. Click the Mouse icon. 4. Click the Device Setting tab. 5. Click the Settings button. 6. The Properties for Synaptics touchpad on PS/2 port screen appears. Double-click Sensitivity in the Select an item section on the left side of the screen. 7. PalmCheck and Touch Sensitivity are displayed. Click Touch Sensitivity. 8. Move the slide bar for Touch Sensitivity to make an adjustment. Click the OK button. 9. Click the OK button on the Device Setting tab. <p>If problems persist, contact your dealer.</p>

USB Mouse

This section applies only with Windows 7 operating system.

Problem	Procedure
On-screen pointer does not respond to mouse operation	<p>The system might be busy. If the pointer is shaped as an hourglass, wait for it to resume its normal shape and try again to move it.</p> <hr/> <p>Make sure the mouse is properly connected to the USB port.</p>
Double-clicking does not work	<p>Try changing the double-click speed setting in the mouse control utility. Click Start → Control Panel → Hardware and Sound → Mouse to access it.</p>

Problem	Procedure
The mouse pointer moves too fast or too slow	Try changing the double-click speed setting in the mouse control utility. Click Start → Control Panel → Hardware and Sound → Mouse to access it.
The mouse pointer moves erratically	The mouse might be dirty. Refer to your mouse documentations for instructions on cleaning.
If problems persist, contact your dealer.	

Memory cards:Secure Digital (SD), Secure Digital High Capacity (SDHC), Secure Digital Extended Capacity (SDXC) and MultiMediaCard (MMC)

Refer also to Chapter 3, [Hardware, Utilities and Options](#).

Problem	Procedure
Memory card error occurs	Reseat the memory card to make sure it is firmly connected. Check the card's documentation.
You cannot write to the memory card	Make sure the card is not write protected.
You cannot read a file	Make sure the target file is on the memory card inserted in the slot. If problems persist, contact your dealer.

External Monitor

Refer also to Chapter 3, [Hardware, Utilities and Options](#), and to your monitor's documentation.

Problem	Procedure
Monitor does not turn on	Make sure that the external monitor's power switch is on. Confirm that the external monitor's power cable is plugged into a working power outlet.
No display	Try adjusting the contrast and brightness controls on the external monitor.

Problem	Procedure
	Press hot keys FN + F5 to change the display priority and make sure it is not set for the internal display.
Display error occurs	<p>Check that the cable connecting the external monitor to the computer is attached firmly.</p> <p>If problems persist, contact your dealer.</p>

Sound System

Problem	Procedure
No sound is heard	<p>Adjust the volume by pressing FN + 3 to decrease or FN + 4 to increase.</p> <p>Check the software volume settings.</p> <p>Make sure the headphone connection is secure.</p> <p>Check Windows Device Manager. Make sure the sound function is enabled and that settings for I/O address, Interrupt level and DMA are correct for your software and do not conflict with other hardware devices that you may have connected to the computer.</p> <p>If problems persist, contact your dealer.</p>

USB

Refer also to your USB device's documentation.

Problem	Procedure
USB device does not work	<p>Check for a firm cable connection between the USB ports on the computer and the USB device.</p> <p>Make sure the USB device drivers are properly installed. Refer to your Windows documentation for information on checking the drivers.</p> <p>If you are using an operating system that does not support USB, you can still use a USB mouse and/or USB keyboard. If these devices do not work, make sure the USB KB/Mouse Legacy Emulation item in HW Setup is set to [Enable].</p> <p>If problems persist, contact your dealer.</p>

Sleep/Hibernation

Problem	Procedure
The system will not enter sleep/hibernation	<p>Is Windows Media Player open? The system might not enter sleep/hibernation, if Windows Media Player is either playing a selection or finished playing a selection. Close Windows Media Player before you select sleep/hibernation.</p> <p>If problems persist, contact your dealer.</p>

LAN

Problem	Procedure
Cannot access LAN	<p>Check for a firm cable connection between the LAN jack and the LAN HUB.</p>
Wake-up on LAN	<p>Make sure the AC adaptor is connected. The does not work Wake-up on LAN function consumes power even when the system is off.</p> <p>If problems persist, consult your LAN administrator.</p>

Wireless LAN

If the following procedures do not restore LAN access, consult your LAN administrator. For more information on wireless communication, refer to Chapter 4, *Operating Basics*.

Problem	Procedure
Cannot access Wireless LAN	Make sure the computer's wireless communication function is set to on. If problems persist, consult your LAN administrator.

Recovery Media

Problem	Procedure
The following message appears when executing Recovery Media Creator. [The Recovery Media Creator can not be launched because there is no recovery partition.]	You will see this message if you have previously chosen to remove the partition and are trying to create Recovery Media. When there is no recovery partition, the Recovery Media Creator cannot make Recovery Media. However, if you have already created a "Recovery Media", you can use it to restore the recovery partition. Simply follow the instructions in "Restoring the preinstall software from your creating Recovery Media" section in this manual. You will be directed to select Restore Original Factory Image from the drop-down menu. If you have not created Recovery Media, please contact TOSHIBA support for assistance.

TOSHIBA Support

If you require any additional help using your computer or if you are having problems operating the computer, you may need to contact TOSHIBA for additional technical assistance.

Before You Call

Some problems you experience may be related to software or the operating system so it is important that you investigate other sources of assistance first. Before contacting TOSHIBA, try the following:

- Review troubleshooting sections in the documentation supplied with your software and/or peripheral devices.
- If a problem occurs when you are running software applications, consult the software documentation for troubleshooting suggestions and consider calling the software company's technical support department for assistance.
- Consult the dealer you purchased your computer and/or software. They are your best resource for current information and support.

Where to Write

If you are still unable to solve the problem and suspect that it is hardware related, write to TOSHIBA at the nearest location listed on the below.

Outside of Europe	Europe
Australia TOSHIBA Australia Pty Ltd. Information Systems Division Building C, 12-24 Talavera Rd, North Ryde, 2113, NSW, Australia	Germany & Austria TOSHIBA Europe (I.E.) GmbH Geschäftsbereich, Deutschland-Österreich Hammfelddamm 8, D-41460 Neuss, Germany
Canada TOSHIBA of Canada Ltd. 191 McNabb Street, Markham, Ontario L3R 8H2	France TOSHIBA Systèmes France S.A. 7, Rue Ampère B.P. 131, 92804 Puteaux Cedex
China TOSHIBA Personal Computer & Network (Shanghai) Co., Ltd. 10F, BEA Finance Tower, NO.66 Hua Yuan Shi Qiao Road, Pudong, Shanghai, P.R. China 200120	Netherlands TOSHIBA Information Systems, Benelux B.V. Rivium Boulevard 41 2909 LK Capelle a/d IJssel

Singapore

TOSHIBA Singapore Pte. Ltd.
438B Alexandra Road #06-01
Alexandra Technopark
Singapore 119968

Spain

TOSHIBA Information Systems,
ESPAÑA
Parque Empresarial San Fernando
Edificio Europa, 1a Planta, Escalera A
28830, Madrid, España

United States of America

TOSHIBA America Information
Systems, Inc.
9740 Irvine Boulevard
Irvine, California 92618
USA

United Kingdom

TOSHIBA Information Systems (U.K.)
Ltd.
TOSHIBA Court
Weybridge Business Park
Addlestone Road
Weybridge, Surrey KT15 2UL

India

TOSHIBA India Pvt Ltd.
PC Division
6th Floor, DR Gopal Das Bhawan
Barakhamba Road,
Delhi-110001, India

The Rest of Europe

TOSHIBA Europe (I.E.) GmbH
Geschäftsbereich,
Deutschland-Österreich
Hammfelddamm 8,
D-41460 Neuss, Germany

Appendix A

Specifications

This appendix summarizes the computer's technical specifications.

Environmental Requirements

	Operating	Non-operating
Ambient temperature	5°C to 35°C	-20°C to 60°C
Relative humidity	20% to 80%	10% to 90%
Altitude (from sea level)	0 to 3,000 meters	0 to 10,000 meters

Power Requirements

AC adaptor	100-240 volts AC 50 or 60 hertz (cycles per second)
Computer	19V DC

Appendix B

Display Controller and Video Mode

Display Controller

The display controller interprets software commands into hardware commands that turn particular pixels on or off.



Due to the display panel's increased resolution, lines may appear broken in when displaying images in full-screen text mode.

The display controller also controls the video mode and uses industry standard rules to govern the screen resolution and the maximum number of colors that can be displayed at any one time. Therefore, software written for a given video mode will run on any computer that supports that mode.

Video mode

Video mode settings are configured via the **Screen Resolution** dialog. To open the **Screen Resolution** dialog, click **Start** → **Control Panel** → **Appearance and Personalization** → **Display** → **Change display settings**.



If you are running some application (for example a 3D application or video playback and so on), you may use some disturbance, flickering or frame dropping on your screen.

If that occurs, adjust the resolution of display, lowering it until the screen is displayed properly.

Disabling Windows Aero™ may also help correct this issue.

Appendix C

Wireless LAN

This appendix is intended to help you get your Wireless LAN network up and running, with a minimum of parameters.

Card Specifications

Form Factor	■ PCI Express Mini Card
Compatibility	■ IEEE 802.11 Standard for Wireless LANs ■ Wi-Fi (Wireless Fidelity) certified by the Wi-Fi Alliance. The “Wi-Fi CERTIFIED” logo is a certification mark of the Wi-Fi Alliance.
Network Operating System	■ Microsoft Windows Networking
Media Access Protocol	■ CSMA/CA (Collision Avoidance) with Acknowledgment (ACK)

Radio Characteristics

Radio characteristics of Wireless LAN cards may vary according to:

- Country/region where the product was purchased
- Type of product

Wireless communication is often subject to local radio regulations. Although Wireless LAN wireless networking products have been designed for operation in the license-free 2.4 GHz and 5 GHz band, local radio regulations may impose a number of limitations to the use of wireless communication equipment.

Radio	■ Band 5 GHz (5150-5850 MHz) (Revision A, N)
Frequency	■ Band 2.4 GHz (2400-2483.5 MHz) (Revision B, G, N)

The range of the wireless signal is related to the transmit rate of the wireless communication. Communications at lower transmit range may travel larger distances.

- The range of your wireless devices can be affected when the antennas are placed near metal surfaces and solid high-density materials.
- Range is also impacted due to “obstacles” in the signal path of the radio that may either absorb or reflect the radio signal.

Supported Frequency Sub-bands

Subject to the radio regulations that apply in the countries/regions, your Wireless LAN module may support a different set of 5 GHz/2.4 GHz channels. Consult your Authorized Wireless LAN or TOSHIBA Sales office for information about the radio regulations that apply in the countries/regions.

2.4 GHz Band Channels Sets (Wireless IEEE 802.11 Revision B, G and N)

Frequency Range Channel ID	2400-2483.5 MHz
1	2412
2	2417
3	2422
4	2427
5	2432
6	2437
7	2442
8	2447
9	2452
10	2457*1
11	2462
12	2467*2
13	2472*2

*1 Factory-set default channels

*2 The band width and the channel which can be used depends on the installed wireless LAN module. And the approved channels on using are different at each country or region. The channel configuration is managed as follows:

- For wireless clients that operate in a Wireless LAN Infrastructure, the Wireless LAN module will automatically start operation at the channel identified by the Wireless LAN Access Point. When roaming between different access points the station can dynamically switch to another channel if required.
- For Wireless LAN modules installed in wireless clients that operating in a peer-to-peer mode, the module will use the default channel 10.

- In a Wireless LAN Access Point, the Wireless LAN module will use the factory-set default channel (printed in bold), unless the LAN Administrator selected a different channel when configuring the Wireless LAN Access Point device.

5 GHz Band Channels Sets (Wireless IEEE 802.11 Revision A and N)

Frequency Range Channel ID	5150-5850 MHz
34	5170 *2
36	5180 *2
38	5190 *2
40	5200 *2
42	5210 *2
44	5220 *2
46	5230 *2
48	5240 *2
52	5260 *2
56	5280 *2
60	5300 *2
64	5320 *2
100	5500 *2
104	5520 *2
108	5540 *2
112	5560 *2
116	5580 *2
120	5600 *2
124	5620 *2
128	5640 *2
132	5660 *2
136	5680 *2
140	5700 *2
149	5745 *2
153	5765 *2
157	5785 *2

161	5805 *2
165	5825 *2

*1 Factory-set default channels

*2 The channel which can be used depends on the installed wireless LAN module. And the approved channels on using are different at each country or region. The channel configuration is managed as follows:

- For wireless clients that operate in a Wireless LAN Infrastructure, the Wireless LAN module will automatically start operation at the channel identified by the Wireless LAN Access Point. When roaming between different access points the station can dynamically switch to another channel if required.
- In a Wireless LAN Access Point, the Wireless LAN module will use the factory-set default channel (printed in bold), unless the LAN Administrator selected a different channel when configuring the Wireless LAN Access Point device.

Appendix D

AC Power Cord and Connectors

The AC input plug of power cord must be compatible with various international AC power outlets. Power cords need to meet the local standards and the specifications listed as below:

Length:	Minimum 1.7 meters
Wire size:	Minimum 0.75 mm ²
Current rating:	Minimum 2.5 amperes
Voltage rating:	125 or 250V AC (depending on country/region's power standards)

Certification agencies

Europe:

Austria:	OVE	Italy:	IMQ
Belgium:	CEBEC	The Netherlands:	KEMA
Denmark:	DEMKO	Norway:	NEMKO
Finland:	FIMKO	Sweden:	SEMKO
France:	LCIE	Switzerland:	SEV
Germany:	VDE	United Kingdom:	BSI

Outside of Europe:

U.S. and Canada:	UL listed and CSA certified No. 18 AWG, Type SVT or SPT-2		
China:	CCC, CQC	India:	STQC
Australia:	AS		

In Europe, two conductors power cords must be VDE type, H05VVH2-F or H03VVH2-F; while three conductors be VDE type, H05VV-F.

For the United States and Canada, two pin plug configuration must be 2-15P (250V) or 1-15P (125V); while three pin be 6-15P (250V) or 5-15P (125V) as designated in the U.S. National Electrical code handbook and the Canadian Electrical Code Part II.

The following illustrations show the plug shapes for USA, Australia, Canada, United Kingdom, Europe, and China.

USA

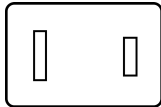

UL approved

United Kingdom

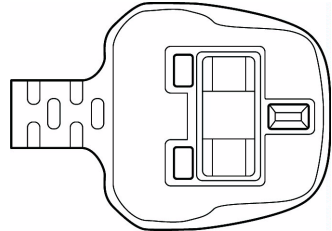

BS approved

Australia

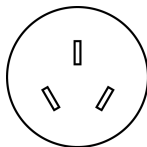

AS approved

Europe

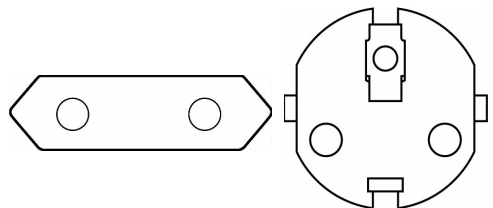

Approved by the appropriate agency

Canada

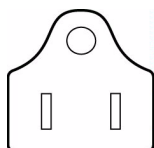

CSA approved

China

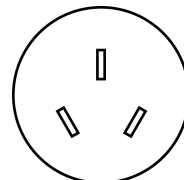

CCC approved

Appendix E

Legal Footnotes

This chapter states the Legal Footnotes information applicable to TOSHIBA computers. In the text in this manual, *XX is used to show which Legal Footnotes description is related to TOSHIBA computers.

Description(s) related to this computer are marked with a blue *XX in this manual. Clicking on *XX will display the related description.

CPU*1

Central Processing Unit (CPU) Performance Disclaimer.

CPU performance in your computer product may vary from specifications under the following conditions:

- use of certain external peripheral products
- use of battery power instead of AC power
- use of certain multimedia, computer generated graphics or video applications
- use of standard telephone lines or low speed network connections
- use of complex modeling software, such as high end computer aided design applications
- use of several applications or functionalities simultaneously
- use of computer in areas with low air pressure (high altitude > 1,000 meters or > 3,280 feet above sea level)
- use of computer at temperatures outside the range of 5°C to 30°C (41°F to 86°F) or > 25°C (77°F) at high altitude (all temperature references are approximate and may vary depending on the specific computer model-please refer to your PC documentation or visit the TOSHIBA website at <http://www.pcsupport.toshiba.com> for details)

CPU performance may also vary from specifications due to design configuration.

Under some conditions, your computer product may automatically shut-down. This is a normal protective feature designed to reduce the risk of lost data or damage to the product when used outside recommended conditions. To avoid risk of lost data, always make back-up copies of data by periodically storing it on an external storage medium. For optimum performance, use your computer product only under recommended conditions. Read additional restrictions under “Environmental Conditions” in your PC documentation. Contact TOSHIBA Technical Service and Support for more information.

64-Bit Computing

64-bit processors are designed to take advantage of 32 and 64 bit computing.

64-bit computing requires that the following hardware and software requirements are met:

- 64-bit Operating System
- 64-bit CPU, Chipset and BIOS (Basic Input/Output System)
- 64-bit Device drivers
- 64-bit applications

Certain device drivers and/or applications may not be compatible with a 64-bit CPU and therefore may not function properly.

Memory (Main System)*2

Part of the main system memory may be used by the graphics system for graphics performance and therefore reduce the amount of main system memory available for other computing activities. The amount of main system memory allocated to support graphics may vary depending on the graphics system, applications utilized, system memory size and other factors. Computers configured with a 32-bit operating system can address up to 3 GB of system memory. Only computers configured with a 64-bit operating system can address 4 GB or more of system memory.

Battery Life*3

Battery life may vary considerably depending on product model, configuration, applications, power management settings and features utilized, as well as the natural performance variations produced by the design of individual components. Published battery life numbers are achieved on select models and configurations tested by TOSHIBA at the time of publication. Recharge time varies depending on usage. Battery may not charge while computer is consuming full power.

After a period of time, the battery will lose its ability to perform at maximum capacity and will need to be replaced. This is normal for all batteries. To purchase a new battery pack, see the accessories information that shipped with your computer or visit the TOSHIBA web site at <http://www.pcsupport.toshiba.com>.

HDD Drive Capacity and External HDD Capacity*4

One Gigabyte (GB) means $10^9 = 1,000,000,000$ bytes using powers of 10. The computer operating system, however, reports storage capacity using powers of 2 for the definition of $1 \text{ GB} = 2^{30} = 1,073,741,824$ bytes, and therefore shows less storage capacity. Available storage capacity will also be less if the product includes one or more pre-installed operating systems, such as Microsoft Operating System and/or pre-installed software applications, or media content. Actual formatted capacity may vary.

LCD*5

Over a period of time, and depending on the usage of the computer, the brightness of the LCD screen will deteriorate. This is an intrinsic characteristic of LCD technology.

Maximum brightness is only available when operating in AC power mode. Screen will dim when the computer is operated on battery power and you will not be able to increase the brightness of the screen.

Graphics Processor Unit (GPU)*6

Graphics processor unit (GPU) performance may vary depending on product model, design configuration, applications, power management settings and features utilized. GPU performance is only optimized when operating in AC power mode and may decrease considerably when operating in battery power mode.

Total Available Graphics Memory is the total of, as applicable, Dedicated Video Memory, System Video Memory and Shared System Memory. Shared System Memory will vary depending on system memory size and other factors.

Wireless LAN*7

The transmission speed over the Wireless LAN and the distance over which Wireless LAN can reach may vary depending on surrounding electromagnetic environment, obstacles, access point design and configuration, and client design and software/hardware configurations. The actual transmission speed will be lower than the theoretical maximum speed.

Non-applicable Icons

Certain notebook chassis are designed to accommodate all possible configurations for an entire product series. Your selected model may not have all the features and specifications corresponding to all of the icons or switches shown on the notebook chassis, unless you have selected all those features.

Copy Protection

Copy protection technology included in certain media may prevent or limit recording or viewing of the media.

Glossary

The terms in this glossary cover topics related to this manual. Alternate naming is included for reference.

Abbreviations

- AC:** alternating current
- ACPI:** Advanced Configuration and Power Interface
- AGP:** accelerated graphics port
- AMT:** Intel Active Management Technology
- ANSI:** American National Standards Institute
- APM:** advanced power manager
- ASCII:** American Standard Code for Information Interchange
- BIOS:** basic input output system
- bps:** bits per second
- CD:** compact disc
- CD-ROM:** Compact Disc Read Only Memory
- CD-RW:** Compact Disc ReWritable
- CMOS:** complementary metal-oxide semiconductor
- CPU:** central processing unit
- CRT:** cathode ray tube
- DC:** direct current
- DDC:** display data channel
- DIMM:** dual inline memory module
- DMA:** direct memory access
- DOS:** disk operating system
- DVD:** digital versatile disc
- DVD-R:** Digital Versatile Disc Recordable
- DVD-RAM:** Digital Versatile Disc Random Access Memory
- DVD-R DL:** Digital Versatile Disc Recordable Dual Layer
- DVD-ROM:** Digital Versatile Disc Read Only Memory
- DVD-RW:** Digital Versatile Disc ReWritable
- DVD+R DL:** Digital Versatile Disc Recordable Double Layer

ECP: extended capabilities port
FDD: floppy diskette drive
FIR: fast infrared
GB: gigabyte
HDD: hard disk drive
IDE: integrated drive electronics
I/O: input/output
IrDA: Infrared Data Association
IRQ: interrupt request
KB: kilobyte
LAN: local area network
LCD: liquid crystal display
LED: light emitting diode
LSI: large scale integration
MB: megabyte
MMC: multi media card
OCR: optical character recognition (reader)
PC: personal computer
PCB: printed circuit board
PCI: peripheral component interconnect
RAM: random access memory
RGB: red, green, and blue
ROM: read only memory
RTC: real time clock
SCSI: small computer system interface
SD: Secure Digital
SDHC: Secure Digital High Capacit
SDXC: Secure Digital Extended Capacity
SDRAM: synchronous dynamic random access memory
SIO: serial input/output
SLI: Scalable Link Interface
TFT: thin-film transistor
UART: universal asynchronous receiver/transmitter
USB: Universal Serial Bus
UXGA: ultra extended graphics array
VESA: Video Electronic Standards Association
VGA: video graphics array
VRT: voltage reduction technology
WAN: wide area network
WSXGA: wide super extended graphics array

WSXGA+: wide super extended graphics array plus

WUXGA: wide ultra extended graphics array

WXGA: wide extended graphics array

WXGA+: wide extended graphics array plus

XGA: extended graphics array

A

adaptor: A device that provides an interface between two dissimilar electronic devices. For example, the AC adaptor modifies the power from a wall outlet for use by the computer. This term also refers to the add-in circuit cards that control external devices, such as video monitors and magnetic tape devices.

allocate: To assign a space or function for a specific task.

alphanumeric: Keyboard characters including letters, numbers and other symbols, such as punctuation marks or mathematical symbols.

alternating current (AC): Electric current that reverses its direction of flow at regular intervals.

analog signal: A signal whose characteristics such as amplitude and frequency vary in proportion to (are an analog of) the value to be transmitted. Voice communications are analog signals.

ANSI: American National Standards Institute. An organization established to adopt and define standards for a variety of technical disciplines. For example, ANSI defined the ASCII standard and other information processing requirements.

antistatic: A material used to prevent the buildup of static electricity.

application: A group of programs that together are used for a specific task such as accounting, financial planning, spreadsheets, word processing and games.

ASCII: American Standard Code for Information Interchange. ASCII code is a set of 256 binary codes that represent the most commonly used letters, numbers, and symbols.

async: Short for asynchronous.

asynchronous: Lacking regular time relationship. As applied to computer communications, asynchronous refers to the method of transmitting data that does not require a steady stream of bits to be transmitted at regular time intervals.

B

backup: A duplicate copy of files kept as a spare in case the original is destroyed.

batch file: A file that can be executed from the system prompt containing a sequence of operating system commands or executable files.

- binary:** The base two number system composed of zeros and ones (off or on), used by most digital computers. The right-most digit of a binary number has a value of 1, the next a value of 2, then 4, 8, 16, and so on. For example, the binary number 101 has a value of 5. *See also* ASCII.
- BIOS:** Basic Input Output System. The firmware that controls data flow within the computer. *See also* firmware.
- bit:** Derived from “binary digit,” the basic unit of information used by the computer. It is either zero or one. Eight bits is one byte. *See also* byte.
- board:** A circuit board. An internal card containing electronic components, called chips, which perform a specific function or increase the capabilities of the system.
- boot:** Short for bootstrap. A program that starts or restarts the computer. The program reads instructions from a storage device into the computer’s memory.
- bps:** Bits per second. Typically used to describe the data transmission speed of a modem.
- buffer:** The portion of the computer’s memory where data is temporarily stored. Buffers often compensate for differences in the rate of flow from one device to another.
- bus:** An interface for transmission of signals, data or electric power.
- byte:** The representation of a single character. A sequence of eight bits treated as a single unit; also the smallest addressable unit within the system.

C

- cache memory:** High speed memory which stores data that increases processor speed and data transfer rate. When the CPU reads data from main memory, it stores a copy of this data in cache memory. The next time the CPU needs that same data, it looks for it in the cache memory rather than the main memory, which saves time. The computer has two cache levels. Level one is incorporated into the processor and level two resides in external memory.
- capacity:** The amount of data that can be stored on a magnetic storage device such as a floppy diskette or hard disk drive. It is usually described in terms of kilobytes (KB), where one KB = 1024 bytes and megabytes (MB), where one MB = 1024 KB.
- card:** Synonym for board. *See* board.
- CardBus:** An industry standard bus for 32-bit PC Cards.
- CD-ROM:** A Compact Disc Read Only Memory is a high capacity disc that can be read from but not written to. The CD-ROM drive uses a laser, rather than magnetic heads, to read data from the disc.
- CD-R:** A Compact Disc Recordable disc can be written once and read many times. *See also* CD-ROM.
- CD-RW:** A Compact Disc ReWritable disc can be rewritten many times. *See also* CD-ROM.

- character:** Any letter, number, punctuation mark, or symbol used by the computer. Also synonymous with byte.
- chassis:** The frame containing the computer.
- chip:** A small semiconductor containing computer logic and circuitry for processing, memory, input/output functions and controlling other chips.
- CMOS:** Complementary Metal-Oxide Semiconductor. An electronic circuit fabricated on a silicon wafer that requires very little power. Integrated circuits implemented in CMOS technology can be tightly packaged and are highly reliable.
- cold start:** Starting a computer that is currently off (turning on the power).
- COM1, COM2, COM3 and COM4:** The names assigned to the serial and communication ports.
- commands:** Instructions you enter at the terminal keyboard that direct the actions of the computer or its peripheral devices.
- communications:** The means by which a computer transmits and receives data to and from another computer or device.
- compatibility:** 1) The ability of one computer to accept and process data in the same manner as another computer without modifying the data or the media upon which it is being transferred.
2) the ability of one device to connect to or communicate with another system or component.
- components:** Elements or parts (of a system) which make up the whole (system).
- Composite Video (YUV):** A standard video signal used to transmit images, e.g. from a VCR to a TV.
- computer program:** A set of instructions written for a computer that enable it to achieve a desired result.
- computer system:** A combination of hardware, software, firmware, and peripheral components assembled to process data into useful information.
- configuration:** The specific components in your system (such as the terminal, printer, and disk drives) and the settings that define how your system works. You use the HW Setup program to control your system configuration.
- control keys:** A key or sequence of keys you enter from the keyboard to initiate a particular function within a program.
- controller:** Built-in hardware and software that controls the functions of a specific internal or peripheral device (e.g. keyboard controller).
- co-processor:** A circuit built into the processor that is dedicated to intensive math calculations.
- CPS:** Characters Per Second. Typically used to indicate the transmission speed of a printer.
- CPU:** Central Processing Unit. The portion of the computer that interprets and executes instructions.

CRT: Cathode Ray Tube. A vacuum tube in which beams projected on a fluorescent screen-producing luminous spots. An example is the television set.

cursor: A small, blinking rectangle or line that indicates the current position on the display screen.

D

data: Information that is factual, measurable or statistical that a computer can process, store, or retrieve.

data bits: A data communications parameter controlling the number of bits (binary digits) used to make up a byte. If data bits = 7 the computer can generate 128 unique characters. If data bits = 8 the computer can generate 256 unique characters.

DC: Direct Current. Electric current that flows in one direction. This type of power is usually supplied by batteries.

default: The parameter value automatically selected by the system when you or the program do not provide instructions. Also called a preset value.

delete: To remove data from a disk or other data storage device. Synonymous with erase.

device driver: A program that controls communication between a specific peripheral device and the computer. The CONFIG.SYS file contains device drivers that MS-DOS loads when you turn the computer on.

dialog box: A window that accepts user input to make system settings or record other information.

Digital Audio: An audio compression standard that enables high-quality transmission and real-time playback of sound files.

disk drive: The device that randomly accesses information on a disk and copies it to the computer's memory. It also writes data from memory to the disk. To accomplish these tasks, the unit physically rotates the disk at high speed past a read-write head.

disk storage: Storing data on magnetic disk. Data is arranged on concentric tracks much like a phonograph record.

display: A CRT, LCD, or other image producing device used to view computer output.

documentation: The set of manuals and/or other instructions written for the users of a computer system or application. Computer system documentation typically includes procedural and tutorial information as well as system functions.

DOS: Disk Operating System. See operating system.

driver: A software program, generally part of the operating system, that controls a specific piece of hardware (frequently a peripheral device such as a printer or mouse).

DVB-T (Digital Video Broadcasting - Terrestrial): Also known as terrestrial digital TV. Digital TV broadcasting standard.

- DVD-R (+R, -R):** A Digital Versatile Disc Recordable disk can be written once and read many times. The DVD-R drive uses a laser to read data from the disc.
- DVD-RAM:** A Digital Versatile Disc Random Access Memory is a high-capacity, high performance disc that allows you to store large volumes of data. The DVD-RAM drive uses a laser to read data from the disc.
- DVD-R DL:** A disc having two layers on one side with the DVD-R storage capacity about 1.8 times larger than before. The DVD-RW drive uses a laser to read data from the disc.
- DVD-ROM:** A Digital Versatile Disc Read Only Memory is a high capacity, high performance disc suitable for play back of video and other high-density files. The DVD-ROM drive uses a laser to read data from the disc.
- DVD-RW (+RW, -RW):** A Digital Versatile Disc ReWritable disc can be rewritten many times.
- DVD+R DL:** A disc having two layers on one side with the DVD+R storage capacity about 1.8 times larger than before. The DVD-RW drive uses a laser to read data from the disc.

E

- echo:** To send back a reflection of the transmitted data to the sending device. You can display the information on the screen, or output it to the printer, or both. When a computer receives back data it transmitted to a CRT (or other peripheral device) and then retransmits the data to printer, the printer is said to echo the CRT.
- erase:** See delete.
- escape:** 1) A code (ASCII code 27), signaling the computer that what follows are commands; used with peripheral devices such as printers and modems.
2) A means of aborting the task currently in progress.
- escape guard time:** A time before and after an escape code is sent to the modem which distinguishes between escapes that are part of the transmitted data, and escapes that are intended as a command to the modem.
- execute:** To interpret and execute an instruction.
- Extended Capability Port:** An industry standard that provides a data buffer, switchable forward and reverse data transmission, and run length encoding (RLE) support.

F

- fast infrared:** An industry standard that enables cableless infrared serial data transfer at speeds of up to 4 Mbps.
- file:** A collection of related information; a file can contain data, programs, or both.

- firmware:** A set of instructions built into the hardware which controls and directs a microprocessor's activities.
- floppy diskette:** A removable disk that stores magnetically encoded data.
- floppy diskette drive (FDD):** An electromechanical device that reads and writes to floppy diskettes.
- Fn-esse:** A TOSHIBA utility that allows you to assign functions to hot keys.
- folder:** An icon in Windows used to store documents or other folders.
- format:** The process of readying a blank disk for its first use. Formatting establishes the structure of the disk that the operating system expects before it writes files or programs onto the disk.
- function keys:** The keys labeled **F1** through **F12** that tell the computer to perform certain functions.

G

- gigabyte (GB):** A unit of data storage equal to 1024 megabytes. *See also* megabyte.
- graphics:** Drawings, pictures, or other images, such as charts or graphs, to present information.

H

- hard disk:** A non-removable disk usually referred to as drive C. The factory installs this disk and only a trained engineer can remove it for servicing. Also called fixed disk.
- hard disk drive (HDD):** An electromechanical device that reads and writes a hard disk. *See also* hard disk.
- hardware:** The physical electronic and mechanical components of a computer system: typically, the computer itself, external disk drives, etc. *See also* software and firmware.
- hertz:** A unit of wave frequency that equals one cycle per second.
- hexadecimal:** The base 16 numbering system composed of the digits 0 through 9 and the letters A, B, C, D, E, and F.
- host computer:** The computer that controls, regulates, and transmits information to a device or another computer.
- hot key:** The computer's feature in which certain keys in combination with the extended function key, **FN**, can be used to set system parameters, such as speaker volume.
- HW Setup:** A TOSHIBA utility that allows you to set the parameters for various hardware components.

I

- icon:** A small graphic image displayed on the screen or in the indicator panel. In Windows, an icon represents an object that the user can manipulate.
- i.LINK (IEEE1394):** This port enables high-speed data transfer directly from external devices such as digital video cameras.

input: The data or instructions you provide to a computer, communication device or other peripheral device from the keyboard or external or internal storage devices. The data sent (or output) by the sending computer is input for the receiving computer.

instruction: Statements or commands that specify how to perform a particular task.

interface: 1) Hardware and/or software components of a system used specifically to connect one system or device to another.
2) To physically connect one system or device to another to exchange information.
3) The point of contact between user, the computer, and the program, for example, the keyboard or a menu.

interrupt request: A signal that gives a component access to the processor.

I/O: Input/output. Refers to acceptance and transfer of data to and from a computer.

I/O devices: Equipment used to communicate with the computer and transfer data to and from it.

IrDA 1.1: An industry standard that enables cableless infrared serial data transfer at speeds of up to 4 Mbps.

J

jumper: A small clip or wire that allows you to change the hardware characteristics by electrically connecting two points of a circuit.

K

K: Taken from the Greek word kilo, meaning 1000; often used as equivalent to 1024, or 2 raised to the 10th power. See *also* byte and kilobyte.

KB: See kilobyte.

keyboard: An input device containing switches that are activated by manually pressing marked keys. Each keystroke activates a switch that transmits a specific code to the computer. For each key, the transmitted code is, in turn, representative of the (ASCII) character marked on the key.

kilobyte (KB): A unit of data storage equal to 1024 bytes. See *also* byte and megabyte.

L

level 2 cache: See cache.

Light Emitting Diode (LED): A semiconductor device that emits light when a current is applied.

Liquid Crystal Display (LCD): Liquid crystal sealed between two sheets of glass coated with transparent conducting material. The viewing-side coating is etched into character forming segments with leads that extend to the edge of the glass. Applying a voltage between the glass sheets alters the brightness of the liquid crystal.

LSI: Large Scale Integration.

- 1) A technology that allows the inclusion of up to 100,000 simple logic gates on a single chip.
- 2) An integrated circuit that uses large scale integration.

M

main board: See motherboard.

megabyte (MB): A unit of data storage equal to 1024 kilobytes. *See also* kilobyte.

megahertz: A unit of wave frequency that equals 1 million cycles per second. *See also* hertz.

menu: A software interface that displays a list of options on the screen. Also called a screen.

microprocessor: A hardware component contained in a single integrated circuit that carries out instructions. Also called the central processing unit (CPU), one of the main parts of the computer.

mode: A method of operation, for example, the Boot Mode, Sleep Mode or the Hibernation Mode.

modem: Derived from modulator/demodulator, a device that converts (modulates) digital data for transmission over telephone lines and then converts modulated data (demodulates) to digital format where received.

monitor: A device that uses rows and columns of pixels to display alphanumeric characters or graphic images. *See also* CRT.

motherboard: A name sometimes used to refer to the main printed circuit board in processing equipment. It usually contains integrated circuits that perform the processor's basic functions and provides connectors for adding other boards that perform special functions. Sometimes called a main board.

N

non-system disk: A formatted floppy diskette you can use to store programs and data but you cannot use to start the computer. *See* system disk.

nonvolatile memory: Memory, usually read-only (ROM), that is capable of permanently storing information. Turning the computer's power off does not alter data stored in nonvolatile memory.

numeric keypad overlay: A feature that allows you to use certain keys on the keyboard to perform numeric entry, or to control cursor and page movement.

O

OCR: Optical Character Recognition (reader). A technique or device that uses laser or visible light to identify characters and input them into a storage device.

online state: A functional state of a peripheral device when it is ready to receive or transmit data.

operating system: A group of programs that controls the basic operation of a computer. Operating system functions include interpreting programs, creating data files, and controlling the transmission and receipt (input/output) of data to and from memory and peripheral devices.

output: The results of a computer operation. Output commonly indicates data.

1) printed on paper, 2) displayed at a terminal, 3) sent through the serial port of internal modem, or 4) stored on some magnetic media.

P

PAL: PAL (Phase Alternating Line) is the dominant video and broadcasting standard in Europe.

parity: 1) The symmetrical relationship between two parameter values (integers) both of which are either on or off; odd or even; 0 or 1.
2) In serial communications, an error detection bit that is added to a group of data bits making the sum of the bits even or odd. Parity can be set to none, odd, or even.

password: A unique string of characters used to identify a specific user. The computer provides various levels of password protection such as user and supervisor.

pel: The smallest area of the display that can be addressed by software. Equal in size to a pixel or group of pixels. See pixel.

peripheral component interconnect: An industry standard 32-bit bus.

peripheral device: An I/O device that is external to the central processor and/or main memory such as a printer or a mouse.

Péritel: Péritel is a 21-pin connecting cable/port system that allows images and high-quality stereo sound (including Dolby® Pro-Logic sound formats) to be sent from one audio-visual device to another. It is also known as a "SCART connector" or "Euro connector".

pixel: A picture element. The smallest dot that can be made on a display or printer. Also called a pel.

plug and play: A capability with Windows that enables the system to automatically recognize connections of external devices and make the necessary configurations in the computer.

port: The electrical connection through which the computer sends and receives data to and from devices or other computers.

Power Saver Utility: A TOSHIBA utility that allows you to set the parameters for various power-saving functions.

printed circuit board (PCB): A hardware component of a processor to which integrated circuits and other components are attached. The board itself is typically flat and rectangular, and constructed of fiberglass, to form the attachment surface.

program: A set of instructions a computer can execute that enables it to achieve a desired result. *See also* application.

prompt: A message the computer provides indicating it is ready for or requires information or an action from you.

R

Radio frequency interference (RFI) shield: A metal shield enclosing the printed circuit boards of the printer or computer to prevent radio and TV interference. All computer equipment generates radio frequency signals. The FCC regulates the amount of signals a computing device can allow past its shielding. A Class A device is sufficient for office use. Class B provides a more stringent classification for home equipment use. TOSHIBA portable computers comply with Class B computing device regulations.

Random Access Memory (RAM): High speed memory within the computer circuitry that can be read or written to.

restart: Resetting a computer without turning it off (also called “warm boot” or “soft reset”). *See also* boot.

RGB: Red, green and blue. A device that uses three input signals, each activating an electron gun for a primary additive color (red, green and blue) or port for using such a device. *See also* CRT.

RJ11: A modular telephone jack.

RJ45: A modular LAN jack.

ROM: Read Only Memory: A nonvolatile memory chip manufactured to contain information that controls the computer’s basic operation. You cannot access or change information stored in ROM.

S

S-Video: Short for *Super-Video*, a type of connection used by S-VHS videocassette players, camcorders, DVD players, etc. to transmit high-quality video signals.

SCSI: Small Computer System Interface is an industry standard interface for connection of a variety of peripheral devices.

SD Card: Secure Digital cards are flash memory widely used in a variety of digital devices such as digital cameras and Personal Digital Assistants.

SECAM L: SECAM (Sequential Color Memory) is a broadcasting standard used in France.

serial communications: A communications technique that uses as few as two interconnecting wires to send bits one after another.

serial interface: Refer to a type of information exchange that transmits information sequentially, one bit at a time.

- SIO:** Serial Input/Output. The electronic methodology used in serial data transmission.
- soft key:** Key combinations that emulate keys on the IBM keyboard, change some configuration options, stop program execution, and access the numeric keypad overlay.
- software:** The set of programs, procedures and related documentation associated with a computer system. Specifically refers to computer programs that direct and control the computer system's activities. *See also* hardware.
- stop bit:** One or more bits of a byte that follow the transmitted character or group codes in asynchronous serial communications.
- subpixel:** Three elements, one red, one green and blue (RGB), that make up a pixel on the color LCD. The computer sets subpixels independently, each may emit a different degree of brightness. *See also* pixel.
- synchronous:** Having a constant time interval between successive bits, characters or events.
- system disk:** A disk that has been formatted with an operating system. For MS-DOS the operating system is contained in two hidden files and the COMMAND.COM file. You can boot a computer using a system disk. Also called an operating system disk.

T

- terminal:** A typewriter-like keyboard and CRT display screen connected to the computer for data input/output.
- TFT display:** A liquid crystal display (LCD) made from an array of liquid crystal cells using active-matrix technology with thin film transistor (TFT) to drive each cell.
- touchpad:** A pointing device integrated into the TOSHIBA computer palm rest.
- TTL:** Transistor-transistor logic. A logic circuit design that uses switching transistors for gates and storage.

U

- Universal Serial Bus:** This serial interface allows you to communicate with several devices connected in a chain to a single port on the computer.

V

- VGA:** Video Graphics Array is an industry standard video adaptor that allows you to run any popular software.
- volatile memory:** Random access memory (RAM) that stores information as long as power is supplied to the computer.

W

warm start: Restarting or resetting a computer without turning it off.

window: A portion of the screen that can display its own application, document or dialog box. Often used to mean a Microsoft Windows window.

Wireless LAN: Local Area Network (LAN) through wireless communication.

write protection: A method for protecting a floppy diskette from accidental erasure.

Index

A

- AC adaptor, 2-4, 2-12, 3-5, A-1
 - additional, 3-12, 3-21
 - connecting, 1-3
 - problems, 8-5
 - safety instructions, -ii

B

- Battery
 - charging, 6-7
 - life, E-2
 - monitoring capacity, 6-8
 - Real Time Clock battery, 3-5, 6-4
 - retention time, 6-9
 - types, 6-3
- Battery pack, 2-5, 3-5, 3-12, 6-3
 - additional, 3-21
 - extending battery life, 6-10
 - indicator, 6-2
 - operating time, 6-9
 - problems, 8-5
 - replacing, 6-10
 - safety instructions, -ii, 6-4
 - save mode, 3-7
- Bridge media slot
 - function, 3-13
 - problems, 8-11

C

- Checklist
 - equipment, 1-1
 - problems, 8-2, 8-3
- Cleaning the computer, 4-28

D

- DC IN, 2-4
 - connecting, 1-5
 - location, 2-4
- DC IN/Battery
 - indicator, 2-8
- Display, 2-6, 2-7, 3-3, E-3
 - automatic power off, 3-7
 - brightness down, 5-3
 - brightness up, 5-3
 - controller, B-1
 - HW Setup, 7-2
 - opening, 1-6
 - problems, 8-7, 8-11
 - resolution, 5-4
 - switching, 5-3
- DVD Super Multi (+-R DL) drive, 2-11, 3-3, 4-12
 - problems, 8-8

E

- External monitor, 3-21
 - controller, B-1
 - HW Setup, 7-2
 - port, 2-2, 3-5
 - problems, 8-11

F

- Fan vent
 - location, 2-2
- FN + 1 (TOSHIBA zooming utility reduce), 5-4
- FN + 2 (TOSHIBA zooming utility enlarge), 5-4
- FN + 3 (Volume Down), 5-4
- FN + 4 (Volume Up), 5-4

FN + END (PRTSC), 5-4
 FN + ESC (sound mute), 5-2
 FN + F1 (lock), 5-2
 FN + F2 (power plan), 5-2
 FN + F3 (sleep), 5-3
 FN + F4 (hibernate), 5-3
 FN + F5 (output), 5-3
 FN + F6 (brightness down), 5-3
 FN + F7 (brightness up), 5-3
 FN + F8 (wireless), 5-3
 FN + F9 (touchpad), 5-4
 FN + HOME (SYSRQ), 5-4
 FN + PGDN (PAUSE), 5-5
 FN + PGUP (BREAK), 5-5
 FN + SPACE (zoom), 5-4
 Function keys, 5-2

H

Hard disk drive

- automatic power off, 3-7
- capacity, E-3
- problems, 8-7

 Headphone, 3-5

- problems, 8-12

 Hibernation mode, 3-8

- problems, 8-13
- setting, 1-10

 Hot keys, 3-7

- BREAK, 5-5
- brightness down, 5-3
- brightness up, 5-3
- hibernate, 5-3
- lock, 5-2
- output/display, 5-3
- PAUSE, 5-5
- power plan, 5-2
- PRTSC, 5-4
- sleep, 5-3
- sound mute, 5-2
- SYSRQ, 5-4
- TOSHIBA zooming utility
 - enlarge, 5-4
 - reduce, 5-4
- Volume Down, 5-4
- Volume Up, 5-4
- Wireless, 5-3

HW Setup

- accessing, 7-1
- Boot Priority, 7-3
- display, 7-2
- general, 7-2
- keyboard, 7-4
- LAN, 7-5
- password, 7-2

I

Indicator

- battery, 6-2
- keyboard, 2-9
- power, 6-3
- system, 2-7, 2-8
- web camera, 2-6

K

Keyboard, 3-4, 5-1

- FN sticky key, 5-5
- function keys, 5-2
- hot keys, 5-2
- HW Setup, 7-4
- indicator, 2-9
- problems, 8-6
- typewriter keys, 5-1
- Windows special keys, 5-5

L

LAN, 3-6, 4-26

- cable types, 4-27
- connecting, 4-27
- disconnecting, 4-28
- port, 2-2
- problems, 8-13

 LCD, See Display
 Legal Footnotes, E-1
 Lock, security, See Security lock

M

Memory, 3-1, E-2

- expansion, 3-12, 3-17
- installing module, 3-17
- module cover, 2-5
- removing module, 3-20

- Microphone, 3-5
 - built-in, 2-6
 - function, 4-24
 - port, 2-3
 - problems, 8-12
- Microprocessor, See Processor
- Moving the computer, 4-28
- O**
- Optical disc drive, 2-4
 - Function, 4-8
 - safety instructions, -ix
- P**
- Password
 - power on, 3-7
 - problems, 8-6
 - starting the computer with, 6-13
- Pointing device
 - problems, 8-9
 - touchpad, 4-1
- Ports
 - DC IN, 2-4
 - External monitor port, 2-2
 - LAN, 2-2
 - USB, 2-2
- Power, 3-5
 - button, 2-7
 - conditions, 6-1
 - hibernation mode, 1-10
 - indicator, 2-8, 6-3
 - power-up modes, 6-13
 - problems, 8-4
 - settings, 3-7, 5-2
 - shut down mode (boot mode), 1-7
 - sleep mode, 1-8
 - turning off, 1-7
 - turning on, 1-7
- Problems
 - AC power, 8-5
 - analyzing the problem, 8-2
 - battery, 8-5
 - diskette drive, 8-9
 - DVD Super Multi (+-R DL) drive, 8-8
 - external monitor, 8-11
 - hard disk drive, 8-7
 - hardware and system checklist, 8-3
 - keyboard, 8-6
 - LAN, 8-13
 - LCD panel, 8-7
 - memory cards, 8-11
 - overheating power down, 8-4
 - password, 8-6
 - pointing device, 8-9
 - power, 8-4
 - Secure Digital(SD), Secure Digital High Capacity(SDHC), Secure Digital Extended Capacity (SDXC) and Multi Media Card(MMC), 8-11
 - self test, 8-4
 - sleep/hibernation, 8-13
 - sound system, 8-12
 - system start-up, 8-3
 - TOSHIBA support, 8-15
 - touchpad, 8-9
 - USB, 8-13
 - USB mouse, 8-10
 - Wireless LAN, 8-14
- Processor, 3-1
- R**
- Real Time Clock battery, See Battery
- Recovery media
 - problems, 8-14
- Restarting the computer, 1-11
- S**
- Security lock
 - attaching, 3-22
- Shut down mode (boot mode), 1-7
- Sleep mode, 3-8
 - problems, 8-13
 - setting, 1-8
- Sound system, 3-6
 - headphone, 2-3, 3-5
 - microphone, 2-3, 2-6
 - speaker, 2-7

T

- TOSHIBA Accessibility, 3-9
- TOSHIBA Assist, 3-10
- TOSHIBA Bulletin Board, 3-11
- TOSHIBA ConfigFree, 3-10
- TOSHIBA Disc Creator, 3-10, 4-16
- TOSHIBA DVD PLAYER, 3-10
- TOSHIBA DVD-RAM utility, 3-10
- TOSHIBA Face Recognition, 3-11
 - using, 4-5
- TOSHIBA Flash Cards, 3-9
- TOSHIBA HDD/SSD Alert, 3-11
- TOSHIBA HW setup, 7-1
- TOSHIBA Media Controller, 3-11
- TOSHIBA PC Diagnostic Tool, 3-9
- TOSHIBA Power Saver, 3-9
- TOSHIBA ReelTime, 3-11
- TOSHIBA Service Station, 3-11
- TOSHIBA zooming utility, 3-9
- Touchpad, 2-7
 - control buttons, 2-7
 - problems, 8-9
 - using, 4-1

U

- USB, 3-5
 - location, 2-2
 - problems, 8-13
- USB mouse
 - problems, 8-10

V

- Video RAM, 3-2

W

- Web camera, 2-7, 3-6
 - using, 4-3
- Wireless LAN, 3-6, E-3
 - function, 4-25
 - problems, 8-14