

Dell Studio™ 1745/1747 Service Manual

[Before You Begin](#)

[Battery](#)

[Base Cover](#)

[Hard Drive\(s\)](#)

[Memory Module\(s\)](#)

[Wireless Mini-Card](#)

[Coin-Cell Battery](#)

[Center Control Cover](#)

[Keyboard](#)

[Media Controls Board](#)

[Display](#)

[Camera](#)

[Power Button Board](#)

[Palm Rest](#)

[Internal Card With Bluetooth® Wireless Technology](#)

[Thermal Fan](#)

[Media Card Reader Board](#)

[Optical Drive](#)

[USB Board](#)

[Speakers](#)

[System Board](#)

[Processor Heat Sink](#)

[Processor Module](#)

[TV Antenna Cable Assembly](#)

[Subwoofer Assembly](#)

[AC Adapter Connector](#)

[Battery Latch Assembly](#)

[Flashing the BIOS](#)

Notes, Cautions, and Warnings



NOTE: A NOTE indicates important information that helps you make better use of your computer.



CAUTION: A CAUTION indicates either potential damage to hardware or loss of data and tells you how to avoid the problem.



WARNING: A WARNING indicates a potential for property damage, personal injury, or death.

Information in this document is subject to change without notice.
© 2009 Dell Inc. All rights reserved.

Reproduction of these materials in any manner whatsoever without the written permission of Dell Inc. is strictly forbidden.

Trademarks used in this text: *Dell* and the *DELL* logo are trademarks of Dell Inc.; *Bluetooth* is a registered trademark owned by Bluetooth SIG, Inc. and is used by Dell under license; *Microsoft*, *Windows*, *Windows Vista*, and *Windows Vista* start button logo are either trademarks or registered trademarks of Microsoft Corporation in the United States and/or other countries.

Other trademarks and trade names may be used in this document to refer to either the entities claiming the marks and names or their products. Dell Inc. disclaims any proprietary interest in trademarks and trade names other than its own.

Regulatory Model P02E Series

Regulatory Type P02E001

August 2009 Rev. A00

AC Adapter Connector

Dell Studio™ 1745/1747 Service Manual

- [Removing the AC Adapter Connector](#)
- [Replacing the AC Adapter Connector](#)

- WARNING:** Before working inside your computer, read the safety information that shipped with your computer. For additional safety best practices information, see the Regulatory Compliance Homepage at www.dell.com/regulatory_compliance.
- CAUTION:** Only a certified service technician should perform repairs on your computer. Damage due to servicing that is not authorized by Dell™ is not covered by your warranty.
- CAUTION:** To avoid electrostatic discharge, ground yourself by using a wrist grounding strap or by periodically touching an unpainted metal surface (such as a connector on your computer).
- CAUTION:** To help prevent damage to the system board, remove the main battery (see [Removing the Battery](#)) before working inside the computer.
-

Removing the AC Adapter Connector

1. Follow the procedures in [Before You Begin](#).
2. Remove the subwoofer assembly (see [Removing the Subwoofer Assembly](#)).
3. Make a note of the AC adapter connector cable routing and lift the AC adapter connector out of the computer base.

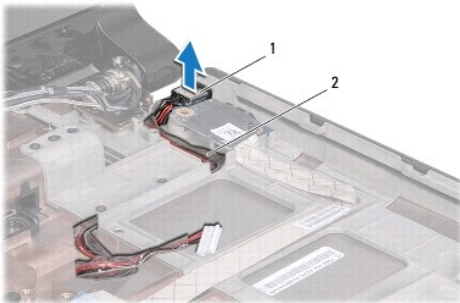

1	AC adapter connector	2	AC adapter connector cable
---	----------------------	---	----------------------------

Replacing the AC Adapter Connector

1. Follow the procedures in [Before You Begin](#).
 2. Route the AC adapter connector cable and place the AC adapter connector on the computer base.
 3. Replace the subwoofer assembly (see [Replacing the Subwoofer Assembly](#)).
-

Base Cover

Dell Studio™ 1745/1747 Service Manual

- [Removing the Base Cover](#)
- [Replacing the Base Cover](#)

- WARNING:** Before working inside your computer, read the safety information that shipped with your computer. For additional safety best practices information, see the Regulatory Compliance Homepage at www.dell.com/regulatory_compliance.
- CAUTION:** Only a certified service technician should perform repairs on your computer. Damage due to servicing that is not authorized by Dell™ is not covered by your warranty.
- CAUTION:** To avoid electrostatic discharge, ground yourself by using a wrist grounding strap or by periodically touching an unpainted metal surface (such as a connector on your computer).
- CAUTION:** To help prevent damage to the system board, remove the main battery (see [Removing the Battery](#)) before working inside the computer.
-

Removing the Base Cover

1. Follow the procedures in [Before You Begin](#).
2. Remove the battery (see [Removing the Battery](#)).
3. Remove the six screws that secure the base cover to the computer base.
4. Lift the base cover off the computer at an angle as shown in the following illustration.

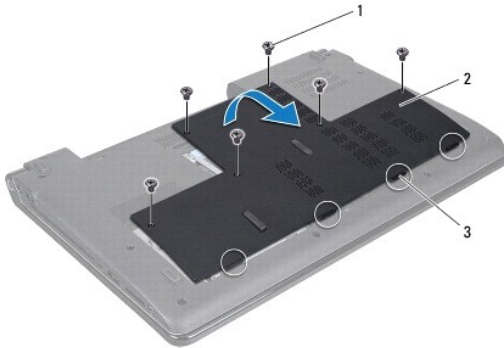

1	screws (6)	2	base cover
3	tabs (4)		

Replacing the Base Cover

1. Follow the procedures in [Before You Begin](#).
 2. Align the four tabs on the base cover with the slots on the computer base and gently snap it into place.
 3. Replace the six screws that secure the base cover to the computer base.
 4. Replace the battery (see [Replacing the Battery](#)).
-

Battery Latch Assembly

Dell Studio™ 1745/1747 Service Manual

- [Removing the Battery Latch Assembly](#)
- [Replacing the Battery Latch Assembly](#)

- WARNING:** Before working inside your computer, read the safety information that shipped with your computer. For additional safety best practices information, see the Regulatory Compliance Homepage at www.dell.com/regulatory_compliance.
- CAUTION:** Only a certified service technician should perform repairs on your computer. Damage due to servicing that is not authorized by Dell™ is not covered by your warranty.
- CAUTION:** To avoid electrostatic discharge, ground yourself by using a wrist grounding strap or by periodically touching an unpainted metal surface (such as a connector on your computer).
- CAUTION:** To help prevent damage to the system board, remove the main battery (see [Removing the Battery](#)) before working inside the computer.
-

Removing the Battery Latch Assembly

1. Follow the procedures in [Before You Begin](#).
2. Remove the subwoofer assembly (see [Removing the Subwoofer Assembly](#)).
3. Remove the three screws that secure the battery latch assembly to the computer base.
4. Using a small screwdriver, remove the latch spring on the battery latch assembly.
5. Lift the battery latch assembly out of the computer base.

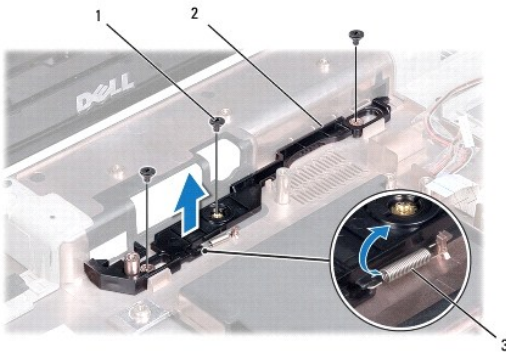

1	screws (3)	2	battery latch assembly
3	latch spring		

Replacing the Battery Latch Assembly

1. Follow the procedures in [Before You Begin](#).
 2. Place the battery latch assembly on the computer base.
 3. Using a small screwdriver, place the latch spring over the hook on the computer base.
 4. Replace the three screws that secure the battery latch assembly to the computer base.
 5. Replace the subwoofer assembly (see [Replacing the Subwoofer Assembly](#)).
-

[Back to Contents Page](#)

[Back to Contents Page](#)

Before You Begin

Dell Studio™ 1745/1747 Service Manual

- [Recommended Tools](#)
- [Turning Off Your Computer](#)
- [Before Working Inside Your Computer](#)

This manual provides procedures for removing and installing components in your computer. Unless otherwise noted, each procedure assumes that the following conditions exist:

- 1 You have performed the steps in [Turning Off Your Computer](#) and [Before Working Inside Your Computer](#).
- 1 You have read the safety information that shipped with your computer.
- 1 A component can be replaced or—if purchased separately—installed by performing the removal procedure in the reverse order.

Recommended Tools

The procedures in this document may require the following tools:

- 1 Small flat-blade screwdriver
- 1 Phillips screwdriver
- 1 Plastic scribe
- 1 BIOS upgrade CD or the BIOS executable update program available on the Dell Support website at support.dell.com

Turning Off Your Computer

 **CAUTION:** To avoid losing data, save and close all open files and exit all open programs before you turn off your computer.

1. Save and close all open files and exit all open programs.
2. Shut down the operating system:

Windows® Vista:

Click Start , click the arrow , and then click **Shut Down**.





Windows® 7:

Click Start  and then click **Shut Down**.

3. Ensure that the computer is turned off. If your computer did not automatically turn off when you shut down the operating system, press and hold the power button until the computer turns off.

Before Working Inside Your Computer

Use the following safety guidelines to help protect your computer from potential damage and to help to ensure your own personal safety.

-  **WARNING:** Before working inside your computer, read the safety information that shipped with your computer. For additional safety best practices information, see the Regulatory Compliance Homepage at www.dell.com/regulatory_compliance.
-  **CAUTION:** To avoid electrostatic discharge, ground yourself by using a wrist grounding strap or by periodically touching an unpainted metal surface (such as a connector on your computer).
-  **CAUTION:** Handle components and cards with care. Do not touch the components or contacts on a card. Hold a card by its edges or by its metal mounting bracket. Hold a component such as a processor by its edges, not by its pins.
-  **CAUTION:** Only a certified service technician should perform repairs on your computer. Damage due to servicing that is not authorized by Dell™ is not covered by your warranty.
-  **CAUTION:** When you disconnect a cable, pull on its connector or on its pull-tab, not on the cable itself. Some cables have connectors with locking tabs; if you are disconnecting this type of cable, press in on the locking tabs before you disconnect the cable. As you pull connectors apart, keep them evenly aligned to avoid bending any connector pins. Also, before you connect a cable, ensure that both connectors are correctly oriented and aligned.

 **CAUTION:** To avoid damaging the computer, perform the following steps before you begin working inside the computer.

1. Ensure that the work surface is flat and clean to prevent the computer cover from being scratched.
2. Turn off your computer (see [Turning Off Your Computer](#)) and all attached devices.

 **CAUTION:** To disconnect a network cable, first unplug the cable from your computer and then unplug the cable from the network device.

3. Disconnect all telephone or network cables from the computer.
4. Press and eject any installed cards from the ExpressCard slot or the 8-in-1 media card reader.
5. Disconnect your computer and all attached devices from their electrical outlets.
6. Disconnect all attached devices from your computer.

 **CAUTION:** To help prevent damage to the system board, remove the main battery (see "Removing the Battery" on page 13) before working inside the computer.

7. Remove the battery (see [Removing the Battery](#)).
8. Turn the computer top-side up, open the display, and press the power button to ground the system board.

[Back to Contents Page](#)

Flashing the BIOS

Dell Studio™ 1745/1747 Service Manual

- [Flashing the BIOS From a CD](#)
- [Flashing the BIOS From the Hard Drive](#)

If a BIOS upgrade CD is provided with the new processor or new system board, flash the BIOS from the CD. If you do not have a BIOS upgrade CD, flash the BIOS from the hard drive.

Flashing the BIOS From a CD

1. Ensure that the AC adapter is plugged in and that the main battery is installed properly.

 **NOTE:** If you use a BIOS upgrade CD to flash the BIOS, set up the computer to boot from a CD before inserting the CD.

2. Insert the BIOS upgrade CD, and restart the computer.
Follow the procedures that appear on the screen. The computer continues to boot and updates the new BIOS. When the flash update is complete, the computer will automatically restart.
 3. Press <F2> during POST to enter the system setup program.
 4. Press <Esc> and then click **Load Setup Defaults** and click **Yes** in the pop-up window to reset the computer defaults.
 5. Remove the BIOS upgrade CD from the drive.
 6. Select **Exit Saving Changes** and select **Yes** in the pop-up window to save configuration changes.
 7. The BIOS upgrade finishes and the computer restarts automatically.
-

Flashing the BIOS From the Hard Drive

1. Ensure that the AC adapter is plugged in, the main battery is properly installed, and a network cable is attached.
2. Turn on the computer.
3. Go to the Dell Support website at support.dell.com.
4. Click **Drivers & Downloads**→ **Select Model**.
5. Select the type of product in the **Select Your Product Family** list.
6. Select the product brand in the **Select Your Product Line** list.
7. Select the product model number in the **Select Your Product Model** list.

 **NOTE:** If you have selected a different model and want to start over again, click **Start Over** on the top right of the menu.

8. Click **Confirm**.
 9. A list of results appear on the screen. Click **BIOS**.
 10. Click **Download Now** to download the latest BIOS file.
The **File Download** window appears.
 11. Click **Save** to save the file on your desktop. The file downloads to your desktop.
 12. Click **Close** if the **Download Complete** window appears.
The file icon appears on your desktop and is titled the same as the downloaded BIOS update file.
 13. Double-click the file icon on the desktop and follow the procedures on the screen.
-

[Back to Contents Page](#)

Internal Card With Bluetooth® Wireless Technology

Dell Studio™ 1745/1747 Service Manual

- [Removing the Bluetooth Card](#)
- [Replacing the Bluetooth Card](#)

- WARNING:** Before working inside your computer, read the safety information that shipped with your computer. For additional safety best practices information, see the Regulatory Compliance Homepage at www.dell.com/regulatory_compliance.
- CAUTION:** Only a certified service technician should perform repairs on your computer. Damage due to servicing that is not authorized by Dell™ is not covered by your warranty.
- CAUTION:** To avoid electrostatic discharge, ground yourself by using a wrist grounding strap or by periodically touching an unpainted metal surface (such as a connector on your computer).
- CAUTION:** To help prevent damage to the system board, remove the main battery (see [Removing the Battery](#)) before working inside the computer.

If you ordered a card with Bluetooth wireless technology with your computer, it is already installed.

Removing the Bluetooth Card

1. Follow the procedures in [Before You Begin](#).
2. Remove the battery (see [Removing the Battery](#)).
3. Remove the center control cover (see [Removing the Center Control Cover](#)).
4. Remove the keyboard (see [Removing the Keyboard](#)).
5. Remove the media controls board (see [Removing the Media Controls Board](#)).
6. Remove the palm rest (see [Removing the Palm Rest](#)).
7. Remove the screw that secures the Bluetooth card to the system board.
8. Lift the Bluetooth card to disconnect it from the system board connector.

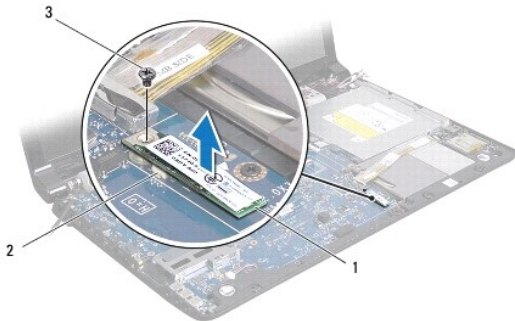

1	Bluetooth card	2	system board connector
3	screw		

Replacing the Bluetooth Card

1. Follow the procedures in [Before You Begin](#).
2. Align the connector on the Bluetooth card with the connector on the system board and press the Bluetooth card until it is fully seated.

3. Replace the screw that secures the Bluetooth card to the system board.
 4. Replace the palm rest (see [Replacing the Palm Rest](#)).
 5. Replace the media controls board (see [Replacing the Media Controls Board](#)).
 6. Replace the keyboard (see [Replacing the Keyboard](#)).
 7. Replace the center control cover (see [Replacing the Center Control Cover](#)).
 8. Replace the battery (see [Replacing the Battery](#)).
-

[Back to Contents Page](#)

Camera

Dell Studio™ 1745/1747 Service Manual

- [Removing the Camera](#)
- [Replacing the Camera](#)

- WARNING:** Before working inside your computer, read the safety information that shipped with your computer. For additional safety best practices information, see the Regulatory Compliance Homepage at www.dell.com/regulatory_compliance.
- CAUTION:** Only a certified service technician should perform repairs on your computer. Damage due to servicing that is not authorized by Dell™ is not covered by your warranty.
- CAUTION:** To avoid electrostatic discharge, ground yourself by using a wrist grounding strap or by periodically touching an unpainted metal surface (such as a connector on your computer).
- CAUTION:** To help prevent damage to the system board, remove the main battery (see [Removing the Battery](#)) before working inside the computer.
-

Removing the Camera

1. Follow the procedures in [Before You Begin](#).
2. Remove the battery (see [Removing the Battery](#)).
3. Remove the base cover (see [Removing the Base Cover](#)).
4. Disconnect the antenna cables from the Mini-Card(s) (see [Removing the Mini-Card](#)).
5. Disconnect the subwoofer assembly cable from the subwoofer assembly cable connector on the system board (see [Removing the Palm Rest](#)).
6. Remove the center control cover (see [Removing the Center Control Cover](#)).
7. Remove the keyboard (see [Removing the Keyboard](#)).
8. Remove the media controls board (see [Removing the Media Controls Board](#)).
9. Remove the display assembly (see [Removing the Display Assembly](#)).
10. Remove the display panel (see [Removing the Display Panel](#)).
11. Remove the two screws that secure the camera module to the display cover.
12. Remove the camera module.

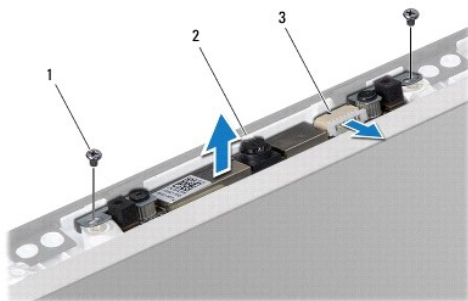

1	screws (2)	2	camera
3	camera cable connector		

Replacing the Camera

1. Follow the procedures in [Before You Begin](#).
2. Align the screw holes on the camera module with the screw holes on the display cover.
3. Replace the two screws that secure the camera module to the display cover.
4. Replace the display panel (see [Replacing the Display Panel](#)).
5. Replace the display assembly (see [Replacing the Display Assembly](#)).
6. Replace the media controls board (see [Replacing the Media Controls Board](#)).
7. Replace the keyboard (see [Replacing the Keyboard](#)).
8. Replace the center control cover (see [Replacing the Center Control Cover](#)).
9. Connect the subwoofer assembly cable to the subwoofer assembly cable connector on the system board (see [Replacing the Palm Rest](#)).
10. Connect the antenna cables to the Mini-Card(s) (see [Replacing the Mini-Card](#)).
11. Replace the base cover (see [Replacing the Base Cover](#)).
12. Replace the battery (see [Replacing the Battery](#)).

[Back to Contents Page](#)

Media Card Reader Board

Dell Studio™ 1745/1747 Service Manual

- [Removing the Media Card Reader Board](#)
- [Replacing the Media Card Reader Board](#)

- WARNING:** Before working inside your computer, read the safety information that shipped with your computer. For additional safety best practices information, see the Regulatory Compliance Homepage at www.dell.com/regulatory_compliance.
- CAUTION:** Only a certified service technician should perform repairs on your computer. Damage due to servicing that is not authorized by Dell™ is not covered by your warranty.
- CAUTION:** To avoid electrostatic discharge, ground yourself by using a wrist grounding strap or by periodically touching an unpainted metal surface (such as a connector on your computer).
- CAUTION:** To help prevent damage to the system board, remove the main battery (see [Removing the Battery](#)) before working inside the computer.
-

Removing the Media Card Reader Board

1. Follow the procedures in [Before You Begin](#).
2. Press and eject any installed cards from the ExpressCard slot or the 8-in-1 media card reader.
3. Remove the battery (see [Removing the Battery](#)).
4. Remove the center control cover (see [Removing the Center Control Cover](#)).
5. Remove the keyboard (see [Removing the Keyboard](#)).
6. Remove the media controls board (see [Removing the Media Controls Board](#)).
7. Remove the palm rest (see [Removing the Palm Rest](#)).
8. Disconnect the media card reader board cable from the connector on the system board.
9. Remove the screw that secures the media card reader board to the computer base.
10. Lift the media card reader board out of the computer base.

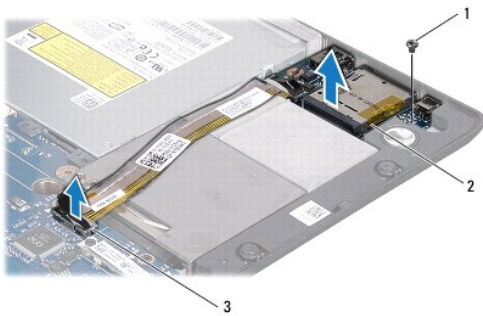

1	screw	2	media card reader board
3	media card reader board cable connector		

Replacing the Media Card Reader Board

1. Follow the procedures in [Before You Begin](#).
2. Place the media card reader board on the computer base and replace the screw that secures the media card reader board to the computer base.

3. Connect the media card reader board cable to the connector on the system board.
 4. Replace the palm rest (see [Replacing the Palm Rest](#)).
 5. Replace the media controls board (see [Replacing the Media Controls Board](#)).
 6. Replace the keyboard (see [Replacing the Keyboard](#)).
 7. Replace the center control cover (see [Replacing the Center Control Cover](#)).
 8. Replace the battery (see [Replacing the Battery](#)).
 9. Reinstall any removed cards in the ExpressCard slot or the 8-in-1 media card reader.
-

[Back to Contents Page](#)

[Back to Contents Page](#)

Center Control Cover

Dell Studio™ 1745/1747 Service Manual

- [Removing the Center Control Cover](#)
- [Replacing the Center Control Cover](#)

- WARNING:** Before working inside your computer, read the safety information that shipped with your computer. For additional safety best practices information, see the Regulatory Compliance Homepage at www.dell.com/regulatory_compliance.
- CAUTION:** Only a certified service technician should perform repairs on your computer. Damage due to servicing that is not authorized by Dell™ is not covered by your warranty.
- CAUTION:** To avoid electrostatic discharge, ground yourself by using a wrist grounding strap or by periodically touching an unpainted metal surface (such as a connector on your computer).
- CAUTION:** To help prevent damage to the system board, remove the main battery (see [Removing the Battery](#)) before working inside the computer.
-

Removing the Center Control Cover

1. Follow the procedures in [Before You Begin](#).
2. Remove the battery (see [Removing the Battery](#)).
3. Remove the screw that secures the center control cover to the computer base.

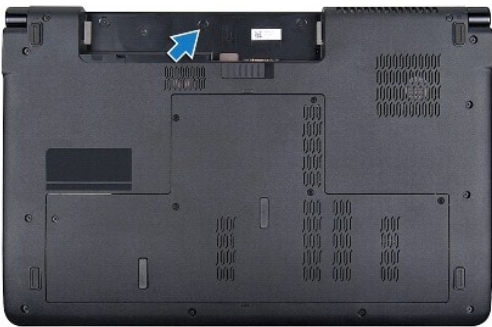

4. Turn the computer over and open the display as far as it will open.
5. Pry out the center control cover with a plastic scribe starting from the back of the computer.
6. Ease the center control cover up.



1	center control cover	2	plastic scribe
---	----------------------	---	----------------

Replacing the Center Control Cover

1. Follow the procedures in [Before You Begin](#).
2. Align the tabs on the center control cover with the slots on the palm rest and snap the cover in place.
3. Turn the computer over and replace the screw that secures the center control cover to the computer base.
4. Replace the battery (see [Replacing the Battery](#)).

[Back to Contents Page](#)

Coin-Cell Battery

Dell Studio™ 1745/1747 Service Manual

- [Removing the Coin-Cell Battery](#)
- [Replacing the Coin-Cell Battery](#)

- WARNING:** Before working inside your computer, read the safety information that shipped with your computer. For additional safety best practices information, see the Regulatory Compliance Homepage at www.dell.com/regulatory_compliance.
- CAUTION:** Only a certified service technician should perform repairs on your computer. Damage due to servicing that is not authorized by Dell™ is not covered by your warranty.
- CAUTION:** To avoid electrostatic discharge, ground yourself by using a wrist grounding strap or by periodically touching an unpainted metal surface (such as a connector on your computer).
- CAUTION:** To help prevent damage to the system board, remove the main battery (see [Removing the Battery](#)) before working inside the computer.
-

Removing the Coin-Cell Battery

1. Follow the procedures in [Before You Begin](#).
2. Remove the battery (see [Removing the Battery](#)).
3. Remove the base cover (see [Removing the Base Cover](#)).
4. Disconnect the coin-cell battery cable from the coin-cell battery cable connector on the system board.
5. Using a plastic scribe, pry the coin-cell battery off the computer base.



1	coin-cell battery	2	coin-cell battery cable connector
---	-------------------	---	-----------------------------------

Replacing the Coin-Cell Battery

1. Follow the procedures in [Before You Begin](#).
 2. Place the coin-cell battery on the computer base.
 3. Connect the coin-cell battery cable to the coin-cell battery cable connector on the system board.
 4. Replace the base cover (see [Replacing the Base Cover](#)).
 5. Replace the battery (see [Replacing the Battery](#)).
-

Processor Module

Dell Studio™ 1745/1747 Service Manual

- [Removing the Processor Module](#)
- [Replacing the Processor Module](#)

- WARNING:** Before working inside your computer, read the safety information that shipped with your computer. For additional safety best practices information, see the Regulatory Compliance Homepage at www.dell.com/regulatory_compliance.
- CAUTION:** Only a certified service technician should perform repairs on your computer. Damage due to servicing that is not authorized by Dell™ is not covered by your warranty.
- CAUTION:** To avoid electrostatic discharge, ground yourself by using a wrist grounding strap or by periodically touching an unpainted metal surface (such as a connector on your computer).
- CAUTION:** To prevent intermittent contact between the ZIF-socket cam screw and the processor when removing or replacing the processor, press to apply slight pressure to the center of the processor while turning the cam screw.
- CAUTION:** To avoid damage to the processor, hold the screwdriver so that it is perpendicular to the processor when turning the cam screw.
- CAUTION:** To help prevent damage to the system board, remove the main battery (see [Removing the Battery](#)) before working inside the computer.
-

Removing the Processor Module

1. Follow the procedures in [Before You Begin](#).
2. Remove the central processor heat sink (see [Removing the Central Processor Heat Sink](#)).
3. To loosen the ZIF socket, use a small, flat-blade screwdriver and rotate the ZIF-socket cam screw counterclockwise until it comes to the cam stop.

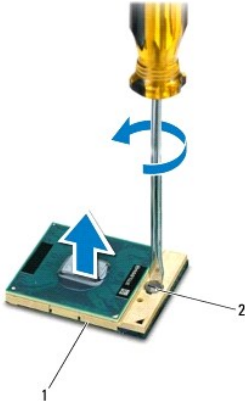

1	ZIF socket	2	ZIF-socket cam screw
---	------------	---	----------------------

- CAUTION:** To ensure maximum cooling for the processor, do not touch the heat transfer areas on the processor thermal-cooling assembly. The oils in your skin can reduce the heat transfer capability of the thermal pads.
- CAUTION:** When removing the processor module, pull the module straight up. Be careful not to bend the pins on the processor module.
4. Lift the processor module from the ZIF socket.
-

Replacing the Processor Module

 **NOTE:** If a new processor is installed, you will receive a new thermal-cooling assembly, which will include an affixed thermal pad, or you will receive a new thermal pad along with documentation to illustrate proper installation.

1. Follow the procedures in [Before You Begin](#).
2. Align the pin-1 corner of the processor module with the pin-1 corner of the ZIF socket, then insert the processor module.

 **NOTE:** The pin-1 corner of the processor module has a triangle that aligns with the triangle on the pin-1 corner of the ZIF socket.

When the processor module is properly seated, all four corners are aligned at the same height. If one or more corners of the module are higher than the others, the module is not seated properly.

 **CAUTION:** To avoid damage to the processor, hold the screwdriver perpendicular to the processor when turning the cam screw.

3. Tighten the ZIF socket by turning the cam screw clockwise to secure the processor module to the system board.
4. Replace the central processor heat sink (see [Replacing the Central Processor Heat Sink](#)).

[Back to Contents Page](#)

Processor Heat Sink

Dell Studio™ 1745/1747 Service Manual

- [Central Processor Heat Sink](#)
- [Graphic Processor Heat Sink](#)

- WARNING:** Before working inside your computer, read the safety information that shipped with your computer. For additional safety best practices information, see the Regulatory Compliance Homepage at www.dell.com/regulatory_compliance.
- WARNING:** If you remove the processor heat sink from the computer when the heat sink is hot, do not touch the metal housing of the processor heat sink.
- CAUTION:** Only a certified service technician should perform repairs on your computer. Damage due to servicing that is not authorized by Dell™ is not covered by your warranty.
- CAUTION:** To avoid electrostatic discharge, ground yourself by using a wrist grounding strap or by periodically touching an unpainted metal surface (such as a connector on your computer).
- CAUTION:** To help prevent damage to the system board, remove the main battery (see [Removing the Battery](#)) before working inside the computer.
-

Central Processor Heat Sink

Removing the Central Processor Heat Sink

1. Follow the instructions in [Before You Begin](#).
2. Remove the battery (see [Removing the Battery](#)).
3. Follow the instructions from [step 2](#) to [step 20](#) in [Removing the System Board](#).
4. In sequential order (indicated on the processor heat sink), loosen the four captive screws that secure the processor heat sink to the system board.
5. Lift the central processor heat sink off the system board.

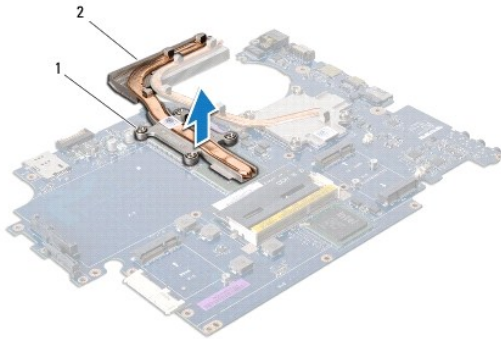

1	captive screws (4)	2	central processor heat sink
---	--------------------	---	-----------------------------

Replacing the Central Processor Heat Sink

NOTE: This procedure assumes that you have already removed the central processor heat sink and are ready to replace it.

1. Follow the procedures in [Before You Begin](#).
2. Place the central processor heat sink on the system board.
3. Align the four captive screws on the central processor heat sink with the screw holes on the system board and tighten the screws in sequential order (indicated on the processor heat sink).

4. Follow the instructions from [step 5](#) to [step 21](#) in [Replacing the System Board](#).
 5. Replace the battery (see [Replacing the Battery](#)).
-

Graphic Processor Heat Sink

Removing the Graphic Processor Heat Sink

1. Follow the instructions in [Before You Begin](#).
2. Remove the battery (see [Removing the Battery](#)).
3. Follow the instructions from [step 2](#) to [step 20](#) in [Removing the System Board](#).
4. In sequential order (indicated on the processor heat sink), loosen the four captive screws that secure the processor heat sink to the system board.
5. Lift the graphic processor heat sink off the system board.

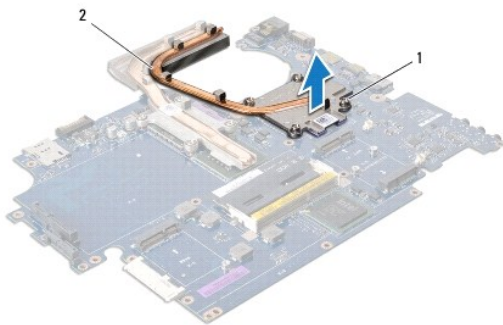

1	screws (4)	2	graphic processor heat sink
---	------------	---	-----------------------------

Replacing the Graphic Processor Heat Sink

 **NOTE:** This procedure assumes that you have already removed the graphic processor heat sink and are ready to replace it.

1. Follow the procedures in [Before You Begin](#).
 2. Place the graphic processor heat sink on the system board.
 3. Align the four captive screws on the graphic processor heat sink with the screw holes on the system board and tighten the screws in sequential order (indicated on the processor heat sink).
 4. Follow the instructions from [step 5](#) to [step 21](#) in [Replacing the System Board](#).
 5. Replace the battery (see [Replacing the Battery](#)).
-

[Back to Contents Page](#)

Display

Dell Studio™ 1745/1747 Service Manual

- [Display Assembly](#)
- [Display Bezel](#)
- [Display Panel](#)
- [Display Panel Cable](#)

- ⚠ WARNING:** Before working inside your computer, read the safety information that shipped with your computer. For additional safety best practices information, see the Regulatory Compliance Homepage at www.dell.com/regulatory_compliance.
- ⚠ CAUTION:** Only a certified service technician should perform repairs on your computer. Damage due to servicing that is not authorized by Dell™ is not covered by your warranty.
- ⚠ CAUTION:** To avoid electrostatic discharge, ground yourself by using a wrist grounding strap or by periodically touching an unpainted metal surface (such as a connector on your computer).
- ⚠ CAUTION:** To help prevent damage to the system board, remove the main battery (see [Removing the Battery](#)) before working inside the computer.
-

Display Assembly

Removing the Display Assembly

1. Follow the procedures in [Before You Begin](#).
2. Remove the battery (see [Removing the Battery](#)).
3. Remove the base cover (see [Removing the Base Cover](#)).
4. Disconnect the antenna cables from the Mini-Card(s) (see [Removing the Mini-Card](#)).
5. Disconnect the subwoofer assembly cable from the subwoofer assembly cable connector on the system board (see [Removing the Palm Rest](#)).
6. Remove the two screws from the computer base.

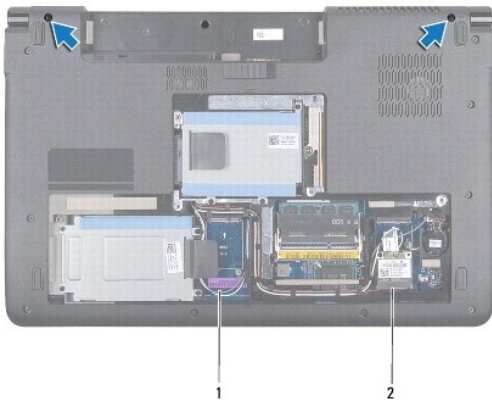

1	antenna cables	2	subwoofer assembly cable
---	----------------	---	--------------------------

7. Remove the center control cover (see [Removing the Center Control Cover](#)).
8. Remove the keyboard (see [Removing the Keyboard](#)).
9. Remove the media controls board (see [Removing the Media Controls Board](#)).
10. Remove the screw that secures the display cable to the computer base.

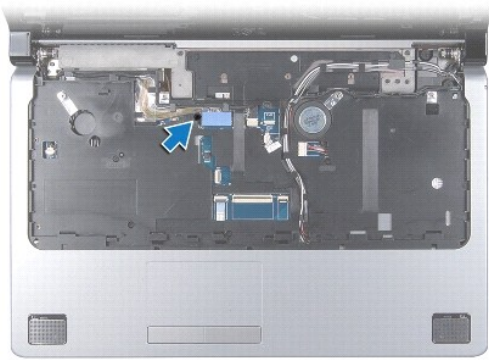

11. Disconnect the display cable, camera cable, and power button cable from the respective system board connectors.
12. Make note of the antenna cable and subwoofer cable routing, and carefully dislodge the cables from the routing guides and release them through the slot.
13. Make note of the display cable, power button cable, and camera cable routing and carefully dislodge the cables from their routing guides.
14. Remove the four screws (two on each side) that secure the display assembly to the computer base.
15. Lift and remove the display assembly from the computer base.



1	display assembly	2	screws (4)
3	power button cable connector	4	camera cable connector
5	display cable connector		

Replacing the Display Assembly

1. Follow the procedures in [Before You Begin](#).
2. Place the display assembly in position and replace the four screws (two on each side) that secure the display assembly to the computer base.
3. Route the antenna cables and subwoofer cable through the slot and routing guides.
4. Route the display cable, power button cable, and camera cable through their routing guides.

5. Connect the display cable, camera cable, and power button cable to the respective system board connectors.
 6. Replace the screw that secures the display cable to the computer base.
 7. Replace the media controls board (see [Replacing the Media Controls Board](#)).
 8. Replace the keyboard (see [Replacing the Keyboard](#)).
 9. Replace the center control cover (see [Replacing the Center Control Cover](#)).
 10. Replace the two screws at the bottom of the computer.
 11. Connect the subwoofer assembly cable to the subwoofer assembly cable connector on the system board.
 12. Connect the antenna cables to the Mini-Card(s) (see [Replacing the Mini-Card](#)).
 13. Replace the base cover (see [Replacing the Base Cover](#)).
 14. Replace the battery (see [Replacing the Battery](#)).
-

Display Bezel

Removing the Display Bezel

⚠ CAUTION: The display bezel is extremely fragile. Be careful when removing it to prevent damaging the bezel.

1. Follow the procedures in [Before You Begin](#).
2. Remove the display assembly (see [Removing the Display Assembly](#)).
3. Using your fingertips, carefully pry up the inside edge of the display bezel.
4. Remove the display bezel.



1	display bezel
---	---------------

Replacing the Display Bezel

1. Follow the procedures in [Before You Begin](#).
2. Realign the display bezel over the display panel, and gently snap into place.
3. Replace the display assembly (see [Replacing the Display Assembly](#)).

Display Panel

Removing the Display Panel

1. Follow the procedures in [Before You Begin](#).
2. Remove the display assembly (see [Removing the Display Assembly](#)).
3. Remove the display bezel (see [Removing the Display Bezel](#)).
4. Remove the eight screws that secure the display panel to the display cover.

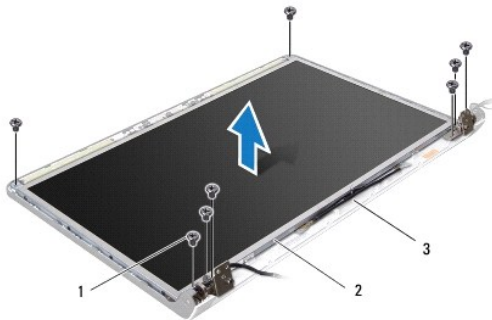

1	screws (8)	2	display panel
3	display cover		

5. Remove the antenna cables, power button cable, and display cable from the hinge latches.
6. Disconnect the camera cable from the connector on the camera board (see [Removing the Camera](#)).
7. Lift the display panel off the display cover.
8. Remove the eight screws (four on each side) that secure the display panel brackets to the display panel.

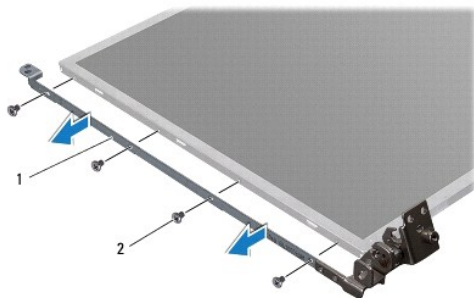

1	display panel brackets (2)	2	screws (8)
---	----------------------------	---	------------

Replacing the Display Panel

1. Follow the procedures in [Before You Begin](#).
2. Replace the eight screws (four on each side) that secure the display panel brackets to the display panel.
3. Connect the camera cable to the connector on the camera board (see [Replacing the Camera](#)).

4. Align the screw holes on the display panel with the holes on the display cover.
 5. Replace the eight screws that secure the display panel to the display cover.
 6. Route the antenna cables, power button cable, and display cable through the hinge latches.
 7. Replace the display bezel (see [Replacing the Display Bezel](#)).
 8. Replace the display assembly (see [Replacing the Display Assembly](#)).
-

Display Panel Cable

Removing the Display Panel Cable

1. Follow the instructions in [Before You Begin](#).
2. Remove the display assembly (see [Removing the Display Assembly](#)).
3. Remove the display bezel (see [Removing the Display Bezel](#)).
4. Remove the display panel (see [Removing the Display Panel](#)).
5. Turn the display panel over and place it on a clean surface.
6. Lift the tape that secures the display cable to the display board connector and disconnect the display cable.

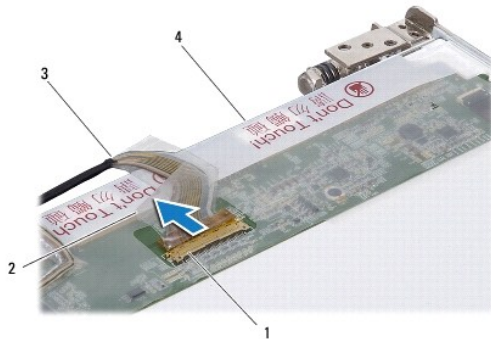

1	display board connector	2	tape
3	display cable	4	back of the display panel

Replacing the Display Panel Cable

1. Follow the procedures in [Before You Begin](#).
 2. Connect the display cable to the display board connector and secure it with the tape.
 3. Replace the display panel (see [Replacing the Display Panel](#)).
 4. Replace the display bezel (see [Replacing the Display Bezel](#)).
 5. Replace the display assembly (see [Replacing the Display Assembly](#)).
-

Thermal Fan

Dell Studio™ 1745/1747 Service Manual

- [Removing the Thermal Fan](#)
- [Replacing the Thermal Fan](#)

- WARNING:** Before working inside your computer, read the safety information that shipped with your computer. For additional safety best practices information, see the Regulatory Compliance Homepage at www.dell.com/regulatory_compliance.
- CAUTION:** Only a certified service technician should perform repairs on your computer. Damage due to servicing that is not authorized by Dell™ is not covered by your warranty.
- CAUTION:** To avoid electrostatic discharge, ground yourself by using a wrist grounding strap or by periodically touching an unpainted metal surface (such as a connector on your computer).
- CAUTION:** To help prevent damage to the system board, remove the main battery (see [Removing the Battery](#)) before working inside the computer.
-

Removing the Thermal Fan

1. Follow the procedures in [Before You Begin](#).
2. Remove the battery (see [Removing the Battery](#)).
3. Remove the center control cover (see [Removing the Center Control Cover](#)).
4. Remove the keyboard (see [Removing the Keyboard](#)).
5. Remove the media controls board (see [Removing the Media Controls Board](#)).
6. Remove the palm rest (see [Removing the Palm Rest](#)).
7. Disconnect the thermal fan cable from the thermal fan cable connector on the system board.
8. Remove the two screws that secure the thermal fan to the computer base.
9. Lift the thermal fan along with the cable, off the computer base.

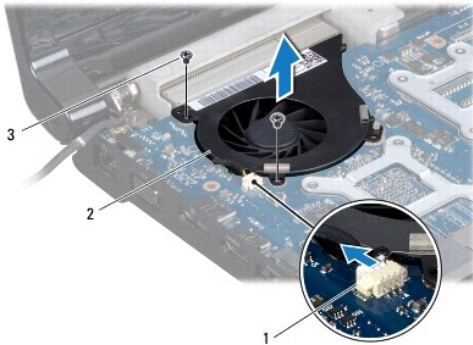

1	thermal fan cable connector	2	thermal fan
3	screws (2)		

Replacing the Thermal Fan

1. Follow the procedures in [Before You Begin](#).

2. Place the thermal fan on the computer base and replace the two screws that secure the thermal fan to the computer base.
 3. Connect the thermal fan cable to the thermal fan cable connector on the system board.
 4. Replace the palm rest (see [Replacing the Palm Rest](#)).
 5. Replace the media controls board (see [Replacing the Media Controls Board](#)).
 6. Replace the keyboard (see [Replacing the Keyboard](#)).
 7. Replace the center control cover (see [Replacing the Center Control Cover](#)).
 8. Replace the battery (see [Replacing the Battery](#)).
-

[Back to Contents Page](#)

Hard Drive(s)

Dell Studio™ 1745/1747 Service Manual

- [Removing the Hard Drive\(s\)](#)
- [Replacing the Hard Drive\(s\)](#)

- ⚠ **WARNING:** Before working inside your computer, read the safety information that shipped with your computer. For additional safety best practices information, see the Regulatory Compliance Homepage at www.dell.com/regulatory_compliance.
- ⚠ **WARNING:** If you remove the hard drive from the computer when the drive is hot, do not touch the metal housing of the hard drive.
- ⚠ **CAUTION:** Only a certified service technician should perform repairs on your computer. Damage due to servicing that is not authorized by Dell™ is not covered by your warranty.
- ⚠ **CAUTION:** To prevent data loss, turn off your computer (see [Turning Off Your Computer](#)) before removing the hard drive. Do not remove the hard drive while the computer is On or in Sleep state.
- ⚠ **CAUTION:** To avoid electrostatic discharge, ground yourself by using a wrist grounding strap or by periodically touching an unpainted metal surface (such as a connector on your computer).
- ⚠ **CAUTION:** Hard drives are extremely fragile. Exercise care when handling the hard drive.
- ⚠ **CAUTION:** To help prevent damage to the system board, remove the main battery (see [Removing the Battery](#)) before working inside the computer.
- 🔧 **NOTE:** Dell does not guarantee compatibility or provide support for hard drives from sources other than Dell.
- 🔧 **NOTE:** If you are installing a hard drive from a source other than Dell, you need to install an operating system, drivers, and utilities on the new hard drive (see the *Dell Technology Guide*).

Removing the Hard Drive(s)

1. Follow the procedures in [Before You Begin](#).
 2. Remove the battery (see [Removing the Battery](#)).
 3. Remove the base cover (see [Removing the Base Cover](#)).
- ⚠ **CAUTION:** When the hard drive is not in the computer, store it in protective antistatic packaging (see "Protecting Against Electrostatic Discharge" in the safety instructions that shipped with your computer).
4. Remove the hard drive(s) from the computer base.
 1. For hard drive 1:
 - o Remove the four screws that secure the hard drive assembly to the computer base.
 - o Using the pull-tab, slide the hard drive towards the left to disconnect the hard drive assembly from the connector on the system board.
 - o Lift the hard drive assembly out of the computer base.

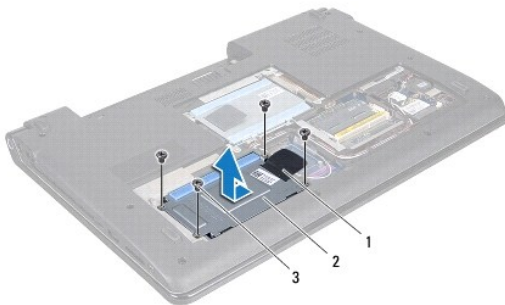

1	pull-tab	2	hard drive assembly
3	screws (4)		

- o Remove the four screws that secure the hard drive cage to the hard drive.

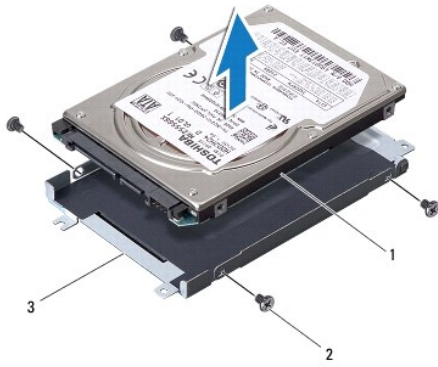

1	hard drive	2	screws (4)
3	hard drive cage		

1 For hard drive 2:

- o Remove the three screws that secure the hard drive assembly to the computer base.
- o Using the pull-tab, lift the hard drive to disconnect the hard drive from the connector on the system board.
- o Lift the hard drive assembly out of the computer base.

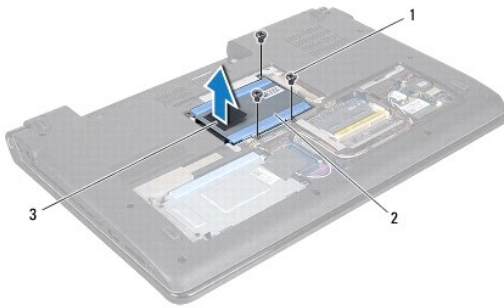

1	screws (3)	2	hard drive assembly
3	pull-tab		

- o Remove the four screws that secure the hard drive cage to the hard drive.



1	hard drive	2	screws (4)
3	hard drive cage		

- o Pull the interposer to disconnect it from the hard drive.



1	hard drive	2	interposer
---	------------	---	------------

5. Lift the hard drive off the hard drive cage.
-

Replacing the Hard Drive(s)

1. Follow the procedures in [Before You Begin](#).
2. Remove the new drive from its packaging.
Save the original packaging for storing or shipping the hard drive.
3. Replace the hard drive(s) in the computer base.
 - 1 For hard drive 1:
 - o Replace the four screws that secure the hard drive cage to the hard drive.
 - o Place the hard drive assembly in the hard drive compartment.
 - o Using the pull-tab, slide the hard drive assembly to connect it to the system board connector.
 - o Replace the four screws that secure the hard drive assembly to the computer base.
 - 1 For hard drive 2:

CAUTION: Use firm and even pressure to slide the drive into place. If you use excessive force, you may damage the connector.

- o Connect the interposer to the hard drive.
 - o Replace the four screws that secure the hard drive cage to the hard drive.
 - o Place the hard drive assembly in the hard drive compartment.
 - o Align the connector on the hard drive with the connector on the system board and press the hard drive until it is fully seated.
 - o Replace the three screws that secure the hard drive assembly to the computer base.
4. Replace the base cover (see [Replacing the Base Cover](#)).

CAUTION: Before turning on the computer, replace all screws and ensure that no stray screws remain inside the computer. Failure to do so may result in damage to the computer.

5. Replace the battery (see [Replacing the Battery](#)).
 6. Install the operating system for your computer, as needed. See "Restoring Your Operating System" in the *Setup Guide*.
 7. Install the drivers and utilities for your computer, as needed. For more information, see the *Dell Technology Guide*.
-

[Back to Contents Page](#)

Keyboard

Dell Studio™ 1745/1747 Service Manual

- [Removing the Keyboard](#)
- [Replacing the Keyboard](#)

- WARNING:** Before working inside your computer, read the safety information that shipped with your computer. For additional safety best practices information, see the Regulatory Compliance Homepage at www.dell.com/regulatory_compliance.
- CAUTION:** Only a certified service technician should perform repairs on your computer. Damage due to servicing that is not authorized by Dell™ is not covered by your warranty.
- CAUTION:** To avoid electrostatic discharge, ground yourself by using a wrist grounding strap or by periodically touching an unpainted metal surface (such as a connector on your computer).
- CAUTION:** To help prevent damage to the system board, remove the main battery (see [Removing the Battery](#)) before working inside the computer.

Removing the Keyboard

1. Follow the procedures in [Before You Begin](#).
2. Remove the battery (see [Removing the Battery](#)).
3. Remove the center control cover (see [Removing the Center Control Cover](#)).
4. Remove the four screws that secure the keyboard to the palm rest.

- CAUTION:** The keycaps on the keyboard are fragile, easily dislodged, and time-consuming to replace. Be careful when removing and handling the keyboard.
- CAUTION:** Be extremely careful when removing and handling the keyboard. Failure to do so could result in scratching the display panel.

5. Ease the keyboard up until it clears off the palm rest.
6. Without pulling hard on the keyboard, turn it over and place it over the palm rest.
7. Lift the connector latch that secures the keyboard cable to the system board connector and remove the cable.
8. Lift the connector latch that secures the backlit keyboard cable to the system board connector and remove the cable.
9. Lift the keyboard off the computer.

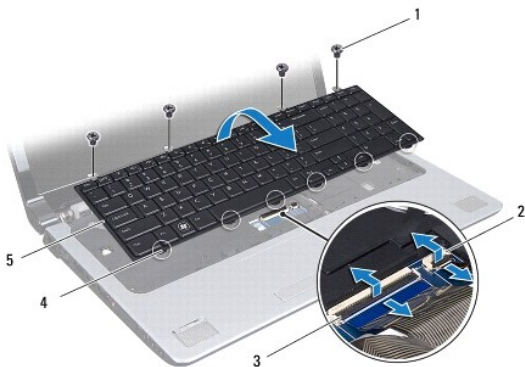

1	screws (4)	2	backlit keyboard cable connector
3	keyboard cable connector	4	keyboard tabs (6)
5	keyboard		

Replacing the Keyboard

1. Follow the procedures in [Before You Begin](#).
2. Slide the keyboard cable into the connector on the system board. Press down on the connector latch to secure the cable to the system board connector.
3. Slide the backlit keyboard cable into the connector on the system board. Press down on the connector latch to secure the cable to the system board connector.
4. Align the six tabs on the keyboard with the slots on the palm rest.
5. Place the keyboard on the palm rest.
6. Replace the four screws that secure the keyboard to the palm rest.
7. Replace the center control cover (see [Replacing the Center Control Cover](#)).
8. Replace the battery (see [Replacing the Battery](#)).

[Back to Contents Page](#)

Media Controls Board

Dell Studio™ 1745/1747 Service Manual

- [Removing the Media Controls Board](#)
- [Replacing the Media Controls Board](#)

- WARNING:** Before working inside your computer, read the safety information that shipped with your computer. For additional safety best practices information, see the Regulatory Compliance Homepage at www.dell.com/regulatory_compliance.
- CAUTION:** Only a certified service technician should perform repairs on your computer. Damage due to servicing that is not authorized by Dell™ is not covered by your warranty.
- CAUTION:** To avoid electrostatic discharge, ground yourself by using a wrist grounding strap or by periodically touching an unpainted metal surface (such as a connector on your computer).
- CAUTION:** To help prevent damage to the system board, remove the main battery (see [Removing the Battery](#)) before working inside the computer.
-

Removing the Media Controls Board

1. Follow the procedures in [Before You Begin](#).
2. Remove the battery (see [Removing the Battery](#)).
3. Remove the center control cover (see [Removing the Center Control Cover](#)).
4. Remove the keyboard (see [Removing the Keyboard](#)).
5. Remove the three screws that secure the media controls board to the computer base.
6. Lift the connector latch to release the media controls board cable from the media controls board cable connector on the system board.
7. Lift the media controls board off the computer base.

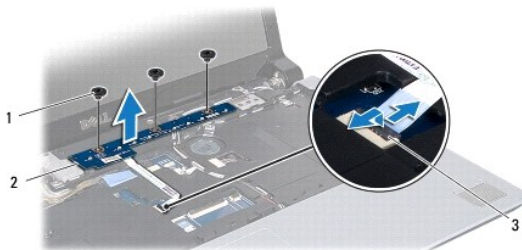

1	screws (3)	2	media controls board
3	media controls board cable connector		

Replacing the Media Controls Board

1. Follow the procedures in [Before You Begin](#).
2. Align the screw holes on the media controls board with the holes on the computer base.
3. Replace the three screws that secure the media controls board to the computer base.
4. Slide the media controls board cable into the media controls board cable connector on the system board and press down on the connector latch to secure the cable to the connector.
5. Replace the keyboard (see [Replacing the Keyboard](#)).

6. Replace the center control cover (see [Replacing the Center Control Cover](#)).
 7. Replace the battery (see [Replacing the Battery](#)).
-

[Back to Contents Page](#)

Memory Module(s)

Dell Studio™ 1745/1747 Service Manual

- [Removing the Memory Module\(s\)](#)
- [Replacing the Memory Module\(s\)](#)

- WARNING:** Before working inside your computer, read the safety information that shipped with your computer. For additional safety best practices information, see the Regulatory Compliance Homepage at www.dell.com/regulatory_compliance.
- CAUTION:** Only a certified service technician should perform repairs on your computer. Damage due to servicing that is not authorized by Dell™ is not covered by your warranty.
- CAUTION:** To avoid electrostatic discharge, ground yourself by using a wrist grounding strap or by periodically touching an unpainted metal surface (such as a connector on your computer).
- CAUTION:** To help prevent damage to the system board, remove the main battery (see [Removing the Battery](#)) before working inside the computer.

You can increase your computer memory by installing memory modules on the system board. See "Specifications" in your *Setup Guide* for information on the type of memory supported by your computer.

NOTE: Memory modules purchased from Dell™ are covered under your computer warranty.

Your computer has two user-accessible SODIMM sockets, DDR III A and DDR III B, that can be accessed from the bottom of the computer.

Removing the Memory Module(s)

1. Follow the procedures in [Before You Begin](#).
2. Remove the battery (see [Removing the Battery](#)).
3. Remove the base cover (see [Removing the Base Cover](#)).

CAUTION: To prevent damage to the memory module connector, do not use tools to spread the memory module securing clips.

4. Use your fingertips to carefully spread apart the securing clips on each end of the memory module connector until the module pops up.
5. Remove the memory module from the memory module connector.

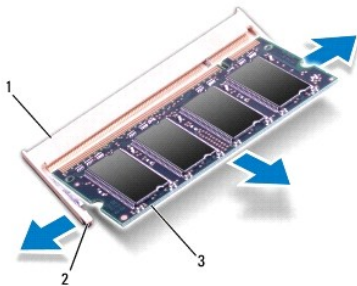

1	memory module connector	2	securing clips (2)
3	memory module		

Replacing the Memory Module(s)

CAUTION: If you need to install memory modules in two connectors, install a memory module in the connector labeled "DDR III A" before you install a memory module in the connector labeled "DDR III B."

1. Follow the procedures in [Before You Begin](#).

2. Align the notch in the memory module with the tab in the memory module connector.
3. Slide the memory module firmly into the slot at a 45-degree angle, and press the memory module down until it clicks into place. If you do not hear the click, remove the memory module and reinstall it.

 **NOTE:** If the memory module is not installed properly, the computer may not boot.

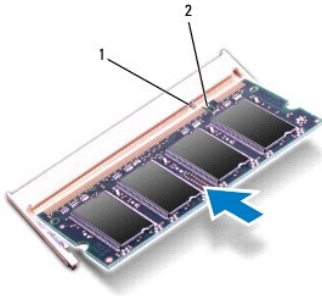

1	tab	2	notch
---	-----	---	-------

4. Replace the base cover (see [Replacing the Base Cover](#)).
5. Replace the battery (see [Replacing the Battery](#)), or connect the AC adapter to your computer and an electrical outlet.
6. Turn on the computer.

As the computer boots, it detects the memory module(s) and automatically updates the system configuration information.

To confirm the amount of memory installed in the computer, click **Start**  → **Help and Support** → **Dell System Information**.

[Back to Contents Page](#)

Wireless Mini-Card

Dell Studio™ 1745/1747 Service Manual

- [Removing the Mini-Card](#)
- [Replacing the Mini-Card](#)

- WARNING:** Before working inside your computer, read the safety information that shipped with your computer. For additional safety best practices information, see the Regulatory Compliance Homepage at www.dell.com/regulatory_compliance.
- CAUTION:** Only a certified service technician should perform repairs on your computer. Damage due to servicing that is not authorized by Dell™ is not covered by your warranty.
- CAUTION:** To avoid electrostatic discharge, ground yourself by using a wrist grounding strap or by periodically touching an unpainted metal surface (such as a connector on your computer).
- CAUTION:** To help prevent damage to the system board, remove the main battery (see [Removing the Battery](#)) before working inside the computer.
- CAUTION:** When the Mini-Card is not in the computer, store it in protective antistatic packaging (see "Protecting Against Electrostatic Discharge" in the safety instructions that shipped with your computer).
- NOTE:** Dell does not guarantee compatibility or provide support for Mini-Cards from sources other than Dell.

If you ordered a wireless Mini-Card with your computer, the card is already installed.

Your computer supports one full Mini-Card slot and two half Mini-Card slots:

- 1 One full Mini-Card slot — Mobile broadband or Wireless Wide Area Network (WWAN)
- 1 One half Mini-Card slot — Wireless Local Area Network (WLAN), or Worldwide Interoperability for Microwave Access (WiMax)
- 1 One half Mini-Card slot — TV tuner module

NOTE: Depending on the configuration of the computer when it was sold, the Mini-Card slots may or may not have Mini-Cards installed in them.

Removing the Mini-Card

1. Follow the instructions in [Before You Begin](#).
2. Remove the battery (see [Removing the Battery](#)).
3. Remove the base cover (see [Removing the Base Cover](#)).

CAUTION: When you disconnect a cable, pull on its connector or on its pull-tab, not on the cable itself. Some cables have connectors with locking tabs; if you are disconnecting this type of cable, press in on the locking tabs before you disconnect the cable. As you pull connectors apart, keep them evenly aligned to avoid bending any connector pins. Also, before you connect a cable, ensure that both connectors are correctly oriented and aligned.

4. Disconnect the antenna cables from the Mini-Card.

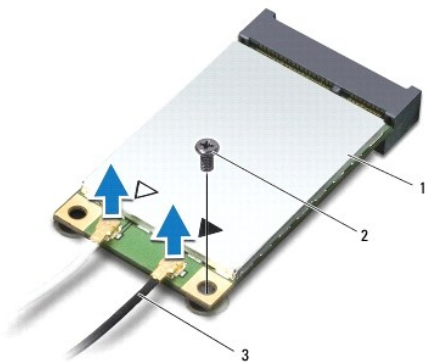

1 | Mini-Card | 2 | securing screw | 3 | antenna cable connectors (2)

5. Remove the screw that secures the Mini-Card to the system board connector.
6. Lift the Mini-Card out of the system board connector.

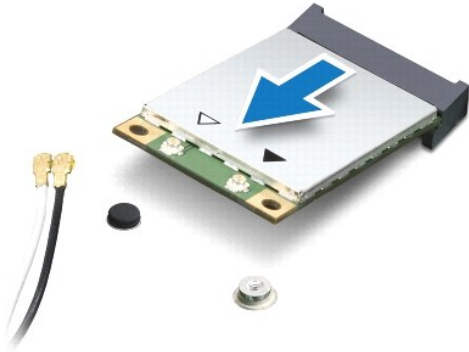

Replacing the Mini-Card

1. Follow the procedures in [Before You Begin](#).
2. Remove the new Mini-Card from its packaging.

CAUTION: Use firm and even pressure to slide the card into place. If you use excessive force, you may damage the connector.

CAUTION: The connectors are keyed to ensure correct insertion. If you feel resistance, check the connectors on the card and on the system board, and realign the card.

CAUTION: To avoid damage to the Mini-Card, never place cables under the card.

3. Insert the Mini-Card connector at a 45-degree angle into the appropriate system board connector. For example, the WLAN card connector is labeled **WLAN** and so on.
4. Press the other end of the Mini-Card down into the slot on the system board and replace the screw that secures the Mini-Card to the system board connector.
5. Connect the appropriate antenna cables to the Mini-Card you are installing. The following table provides the antenna cable color scheme for each Mini-Card supported by your computer.

Connectors on the Mini-Card	Antenna Cable Color Scheme
WWAN (2 antenna cables)	
Main WWAN (white triangle)	white with gray stripe
Auxiliary WWAN (black triangle)	black with gray stripe
WLAN (2 antenna cables)	
Main WLAN (white triangle)	white
Auxiliary WLAN (black triangle)	black
TV tuner (1 antenna cable)	black

6. Secure the unused antenna cables in the protective mylar sleeve.
7. Replace the base cover (see [Replacing the Base Cover](#)).
8. Replace the battery (see [Replacing the Battery](#)).
9. Install the drivers and utilities for your computer, as required. For more information, see the *Dell Technology Guide*.

 **NOTE:** If you are installing a wireless Mini-Card from a source other than Dell, you must install the appropriate drivers and utilities. For more generic driver information, see the *Dell Technology Guide*.

[Back to Contents Page](#)

Optical Drive

Dell Studio™ 1745/1747 Service Manual

- [Removing the Optical Drive](#)
- [Replacing the Optical Drive](#)

- WARNING:** Before working inside your computer, read the safety information that shipped with your computer. For additional safety best practices information, see the Regulatory Compliance Homepage at www.dell.com/regulatory_compliance.
- CAUTION:** Only a certified service technician should perform repairs on your computer. Damage due to servicing that is not authorized by Dell™ is not covered by your warranty.
- CAUTION:** To avoid electrostatic discharge, ground yourself by using a wrist grounding strap or by periodically touching an unpainted metal surface (such as a connector on your computer).
- CAUTION:** To help prevent damage to the system board, remove the main battery (see [Removing the Battery](#)) before working inside the computer.
-

Removing the Optical Drive

1. Follow the procedures in [Before You Begin](#).
2. Remove the battery (see [Removing the Battery](#)).
3. Remove the center control cover (see [Removing the Center Control Cover](#)).
4. Remove the keyboard (see [Removing the Keyboard](#)).
5. Remove the media controls board (see [Removing the Media Controls Board](#)).
6. Remove the palm rest (see [Removing the Palm Rest](#)).
7. Remove the media card reader board (see [Removing the Media Card Reader Board](#)).
8. Remove the three screws that secure the optical drive to the computer base.
9. Lift the optical drive to disconnect the optical drive from the connector on the system board.
10. Lift the optical drive out of the computer base.

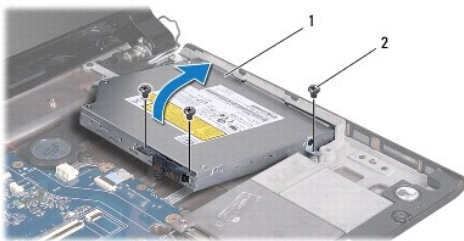

1	optical drive	2	screws (3)
---	---------------	---	------------

11. Disconnect the interposer from the optical drive.



1	interposer
---	------------

Replacing the Optical Drive

1. Follow the procedures in [Before You Begin](#).
 2. Connect the interposer to the optical drive.
 3. Align the connector on the optical drive with the connector on the system board and press the optical drive until it is fully seated.
 4. Replace the three screws that secure the optical drive to the computer base.
 5. Replace the media card reader board (see [Replacing the Media Card Reader Board](#)).
 6. Replace the palm rest (see [Replacing the Palm Rest](#)).
 7. Replace the media controls board (see [Replacing the Media Controls Board](#)).
 8. Replace the keyboard (see [Replacing the Keyboard](#)).
 9. Replace the center control cover (see [Replacing the Center Control Cover](#)).
 10. Replace the battery (see [Replacing the Battery](#)).
-

[Back to Contents Page](#)

[Back to Contents Page](#)

Palm Rest

Dell Studio™ 1745/1747 Service Manual

- [Removing the Palm Rest](#)
- [Replacing the Palm Rest](#)

- WARNING:** Before working inside your computer, read the safety information that shipped with your computer. For additional safety best practices information, see the Regulatory Compliance Homepage at www.dell.com/regulatory_compliance.
- CAUTION:** Only a certified service technician should perform repairs on your computer. Damage due to servicing that is not authorized by Dell™ is not covered by your warranty.
- CAUTION:** To avoid electrostatic discharge, ground yourself by using a wrist grounding strap or by periodically touching an unpainted metal surface (such as a connector on your computer).
- CAUTION:** To help prevent damage to the system board, remove the main battery (see [Removing the Battery](#)) before working inside the computer.
-

Removing the Palm Rest

1. Follow the procedures in [Before You Begin](#).
2. Press and eject any installed cards from the ExpressCard slot or the 8-in-1 media card reader.
3. Remove the battery (see [Removing the Battery](#)).
4. Remove the base cover (see [Removing the Base Cover](#)).
5. Disconnect the antenna cables from the Mini-Card(s) (see [Removing the Mini-Card](#)).
6. Disconnect the subwoofer assembly cable from the subwoofer assembly cable connector on the system board.
7. Remove the twelve screws from the computer base.

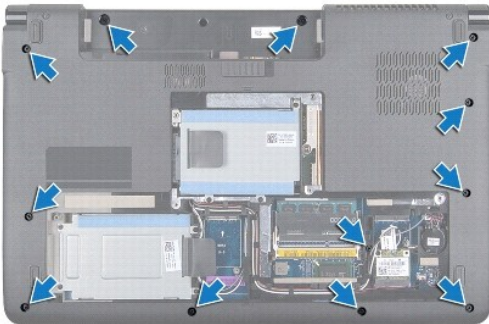

8. Remove the center control cover (see [Removing the Center Control Cover](#)).
9. Remove the keyboard (see [Removing the Keyboard](#)).
10. Remove the media controls board (see [Removing the Media Controls Board](#)).
11. Remove the six screws on the palm rest.

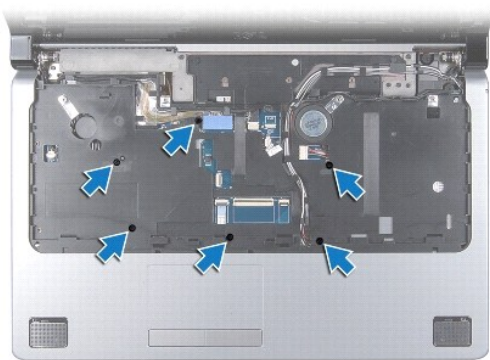

⚠ CAUTION: Pull on the plastic tab on top of the connectors to avoid damaging the connectors.

12. Disconnect the display cable, camera cable, power button cable, and the touch pad cable from the respective system board connectors.
13. Make note of the antenna cable and subwoofer cable routing, and carefully dislodge the cables from the routing guides and release them through the slot.
14. Make note of the display cable, power button cable, and camera cable routing and carefully dislodge the cables from their routing guides.

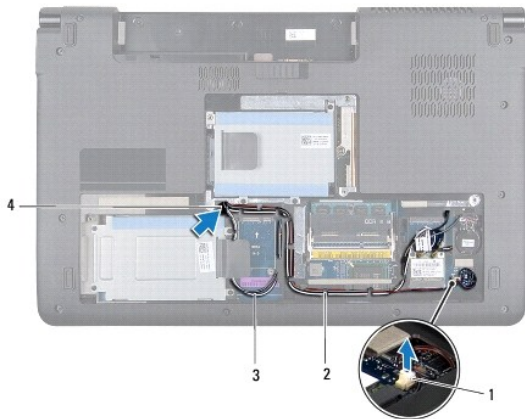

1	subwoofer assembly cable connector	2	routing guides
3	antenna cables	4	cable routing slot

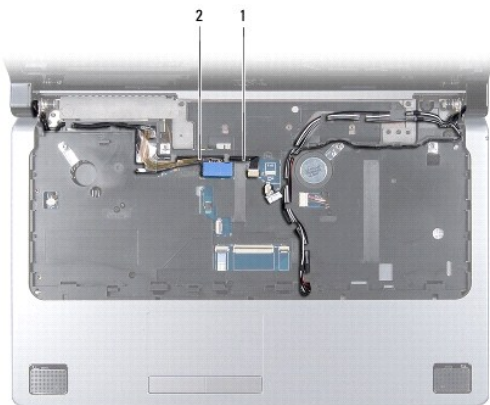

1	camera cable	2	display cable
---	--------------	---	---------------

CAUTION: Carefully separate the palm rest from the computer base to avoid damage to the palm rest.

- Starting at the right or left of the palm rest, use your fingers to separate the palm rest from the computer base.
- Release the subwoofer assembly cable through the slot in the palm rest.
- Lift the palm rest off the computer base.

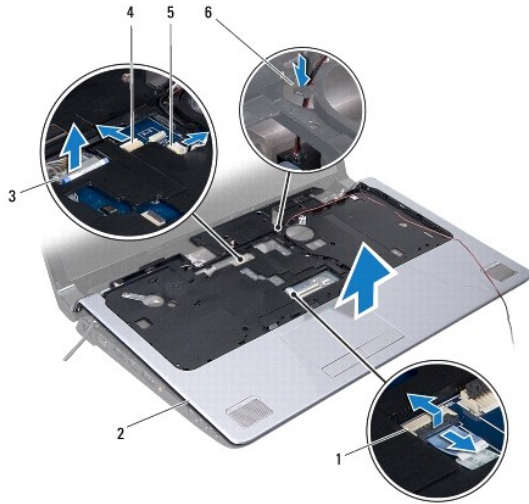

1	touch pad cable connector	2	palm rest
3	display cable connector	4	camera cable connector
5	power button cable connector	6	subwoofer assembly cable slot

Replacing the Palm Rest

- Follow the procedures in [Before You Begin](#).
- Guide the subwoofer assembly cable through the slot in the palm rest.
- Align the palm rest with the computer base and gently snap the palm rest into place.
- Route the antenna cables, display cable, power button cable, and subwoofer assembly cable through the routing guides.
- Connect the display cable, camera cable, power button cable, and the touch pad cable to the respective system board connectors.
- Replace the six screws on the palm rest.
- Replace the media controls board (see [Replacing the Media Controls Board](#)).
- Replace the keyboard (see [Replacing the Keyboard](#)).
- Replace the center control cover (see [Replacing the Center Control Cover](#)).
- Replace the twelve screws at the bottom of the computer.
- Connect the antenna cables to the Mini-Card(s) (see [Replacing the Mini-Card](#)).
- Connect the subwoofer assembly cable to the subwoofer assembly cable connector on the system board.
- Replace the base cover (see [Replacing the Base Cover](#)).
- Replace the battery (see [Replacing the Battery](#)).

15. Reinstall any removed cards in the ExpressCard slot or the 8-in-1 media card reader.

[Back to Contents Page](#)

Power Button Board

Dell Studio™ 1745/1747 Service Manual

- [Removing the Power Button Board](#)
- [Replacing the Power Button Board](#)

- ⚠ WARNING:** Before working inside your computer, read the safety information that shipped with your computer. For additional safety best practices information, see the Regulatory Compliance Homepage at www.dell.com/regulatory_compliance.
- ⚠ CAUTION:** Only a certified service technician should perform repairs on your computer. Damage due to servicing that is not authorized by Dell™ is not covered by your warranty.
- ⚠ CAUTION:** To avoid electrostatic discharge, ground yourself by using a wrist grounding strap or by periodically touching an unpainted metal surface (such as a connector on your computer).
- ⚠ CAUTION:** To help prevent damage to the system board, remove the main battery (see [Removing the Battery](#)) before working inside the computer.
-

Removing the Power Button Board

1. Follow the procedures in [Before You Begin](#).
2. Remove the battery (see [Removing the Battery](#)).
3. Remove the base cover (see [Removing the Base Cover](#)).
4. Disconnect the antenna cables from the Mini-Card(s) (see [Removing the Mini-Card](#)).
5. Disconnect the subwoofer assembly cable from the subwoofer assembly cable connector on the system board (see [Removing the Palm Rest](#)).
6. Remove the center control cover (see [Removing the Center Control Cover](#)).
7. Remove the keyboard (see [Removing the Keyboard](#)).
8. Remove the media controls board (see [Removing the Media Controls Board](#)).
9. Remove the display assembly (see [Removing the Display Assembly](#)).
10. Remove the display panel (see [Removing the Display Panel](#)).
11. Remove the screw that secures the power button board to the display cover.
12. Release the power button board from the notch on the display cover and remove the power button board off the display cover.

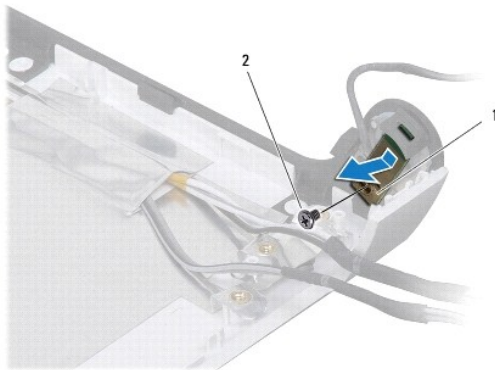

1	power button board	2	screw
---	--------------------	---	-------

Replacing the Power Button Board

1. Follow the procedures in [Before You Begin](#).
2. Secure the power button board using the notch on the display cover.
3. Replace the screw that secures the power button board to the display cover.
4. Replace the display panel (see [Replacing the Display Panel](#)).
5. Replace the display assembly (see [Replacing the Display Assembly](#)).
6. Replace the media controls board (see [Replacing the Media Controls Board](#)).
7. Replace the keyboard (see [Replacing the Keyboard](#)).
8. Replace the center control cover (see [Replacing the Center Control Cover](#)).
9. Connect the subwoofer assembly cable to the subwoofer assembly cable connector on the system board (see [Replacing the Palm Rest](#)).
10. Connect the antenna cables to the Mini-Card(s) (see [Replacing the Mini-Card](#)).
11. Replace the base cover (see [Replacing the Base Cover](#)).
12. Replace the battery (see [Replacing the Battery](#)).

[Back to Contents Page](#)

Battery

Dell Studio™ 1745/1747 Service Manual

- [Removing the Battery](#)
- [Replacing the Battery](#)

- WARNING:** Before working inside your computer, read the safety information that shipped with your computer. For additional safety best practices information, see the Regulatory Compliance Homepage at www.dell.com/regulatory_compliance.
- CAUTION:** Only a certified service technician should perform repairs on your computer. Damage due to servicing that is not authorized by Dell™ is not covered by your warranty.
- CAUTION:** To avoid electrostatic discharge, ground yourself by using a wrist grounding strap or by periodically touching an unpainted metal surface (such as a connector on your computer).
- CAUTION:** To avoid damage to the computer, use only the battery designed for this particular Dell computer. Do not use batteries designed for other Dell computers.
-

Removing the Battery

1. Shut down the computer and turn it over.
2. Slide the battery release latch until it clicks into place.
3. Slide the battery out of the battery bay.

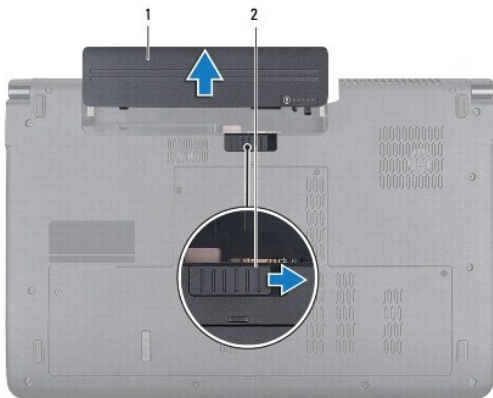

1	battery	2	battery release latch
---	---------	---	-----------------------

Replacing the Battery

Slide the battery into the battery bay until it clicks into place.

Speakers

Dell Studio™ 1745/1747 Service Manual

- [Removing the Speakers](#)
- [Replacing the Speakers](#)

- WARNING:** Before working inside your computer, read the safety information that shipped with your computer. For additional safety best practices information, see the Regulatory Compliance Homepage at www.dell.com/regulatory_compliance.
- CAUTION:** Only a certified service technician should perform repairs on your computer. Damage due to servicing that is not authorized by Dell™ is not covered by your warranty.
- CAUTION:** To avoid electrostatic discharge, ground yourself by using a wrist grounding strap or by periodically touching an unpainted metal surface (such as a connector on your computer).
- CAUTION:** To help prevent damage to the system board, remove the main battery (see [Removing the Battery](#)) before working inside the computer.
-

Removing the Speakers

1. Follow the procedures in [Before You Begin](#).
2. Remove the battery (see [Removing the Battery](#)).
3. Remove the center control cover (see [Removing the Center Control Cover](#)).
4. Remove the keyboard (see [Removing the Keyboard](#)).
5. Remove the media controls board (see [Removing the Media Controls Board](#)).
6. Remove the palm rest (see [Removing the Palm Rest](#)).
7. Disconnect the speaker cable from the speaker cable connector on the system board.
8. Remove the four screws that secure the speakers to the computer base.
9. Lift the speakers off the computer base.

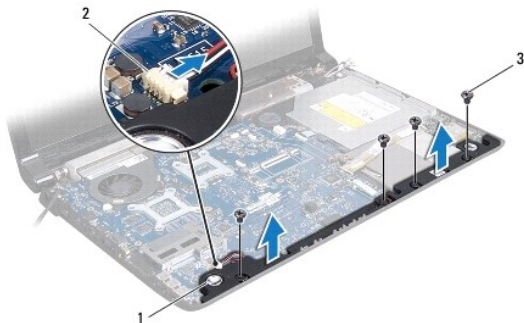

1	speakers (2)	2	speaker cable connector
3	screws (4)		

Replacing the Speakers

1. Follow the procedures in [Before You Begin](#).
2. Place the speakers on the computer base and replace the four screws that secure the speakers to the computer base.

3. Connect the speaker cable to the speaker cable connector on the system board.
 4. Replace the palm rest (see [Replacing the Palm Rest](#)).
 5. Replace the media controls board (see [Replacing the Media Controls Board](#)).
 6. Replace the keyboard (see [Replacing the Keyboard](#)).
 7. Replace the center control cover (see [Replacing the Center Control Cover](#)).
 8. Replace the battery (see [Replacing the Battery](#)).
-

[Back to Contents Page](#)

Subwoofer Assembly

Dell Studio™ 1745/1747 Service Manual

- [Removing the Subwoofer Assembly](#)
- [Replacing the Subwoofer Assembly](#)

- WARNING:** Before working inside your computer, read the safety information that shipped with your computer. For additional safety best practices information, see the Regulatory Compliance Homepage at www.dell.com/regulatory_compliance.
- CAUTION:** Only a certified service technician should perform repairs on your computer. Damage due to servicing that is not authorized by Dell™ is not covered by your warranty.
- CAUTION:** To avoid electrostatic discharge, ground yourself by using a wrist grounding strap or by periodically touching an unpainted metal surface (such as a connector on your computer).
- CAUTION:** To help prevent damage to the system board, remove the main battery (see [Removing the Battery](#)) before working inside the computer.
-

Removing the Subwoofer Assembly

1. Follow the procedures in [Before You Begin](#).
2. Remove the battery (see [Removing the Battery](#)).
3. Follow the instructions from [step 2](#) to [step 19](#) in [Removing the System Board](#).
4. Loosen the three captive screws that secure the subwoofer assembly to the computer base.
5. Lift the subwoofer assembly out of the computer base.

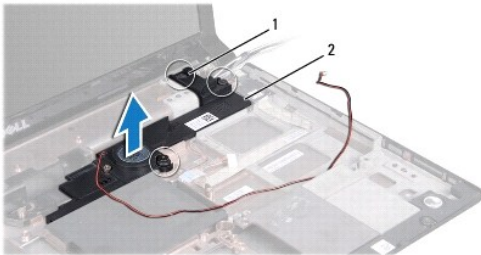

1	captive screws (3)	2	subwoofer assembly
---	--------------------	---	--------------------





Replacing the Subwoofer Assembly

1. Follow the procedures in [Before You Begin](#).
 2. Place the subwoofer assembly on the computer base.
 3. Tighten the three captive screws that secure the subwoofer assembly to the computer base.
 4. Follow the instructions from [step 6](#) to [step 21](#) in [Replacing the System Board](#).
 5. Replace the battery (see [Replacing the Battery](#)).
-

System Board

Dell Studio™ 1745/1747 Service Manual

- [Removing the System Board](#)
- [Replacing the System Board](#)
- [Entering the Service Tag in the BIOS](#)

-  **WARNING:** Before working inside your computer, read the safety information that shipped with your computer. For additional safety best practices information, see the Regulatory Compliance Homepage at www.dell.com/regulatory_compliance.
-  **CAUTION:** Only a certified service technician should perform repairs on your computer. Damage due to servicing that is not authorized by Dell™ is not covered by your warranty.
-  **CAUTION:** To avoid electrostatic discharge, ground yourself by using a wrist grounding strap or by periodically touching an unpainted metal surface (such as a connector on your computer).
-  **CAUTION:** To help prevent damage to the system board, remove the main battery (see [Removing the Battery](#)) before working inside the computer.
-

Removing the System Board

1. Follow the procedures in [Before You Begin](#).
2. Press and eject any installed cards from the ExpressCard slot or the 8-in-1 media card reader.
3. Remove the battery (see [Removing the Battery](#)).
4. Remove the base cover (see [Removing the Base Cover](#)).
5. Remove the memory module(s) (see [Removing the Memory Module\(s\)](#)).
6. Remove the Mini-Card(s) (see [Removing the Mini-Card](#)).
7. Remove the hard drive(s) (see [Removing the Hard Drive\(s\)](#)).
8. Remove the coin-cell battery (see [Removing the Coin-Cell Battery](#)).
9. Remove the center control cover (see [Removing the Center Control Cover](#)).
10. Remove the keyboard (see [Removing the Keyboard](#)).
11. Remove the media controls board (see [Removing the Media Controls Board](#)).
12. Remove the palm rest (see [Removing the Palm Rest](#)).
13. Remove the Bluetooth card (see [Removing the Bluetooth Card](#)).
14. Remove the thermal fan (see [Removing the Thermal Fan](#)).
15. Remove the media card reader board (see [Removing the Media Card Reader Board](#)).
16. Remove the optical drive (see [Removing the Optical Drive](#)).
17. Remove the seven screws that secure the system board assembly to the computer base.

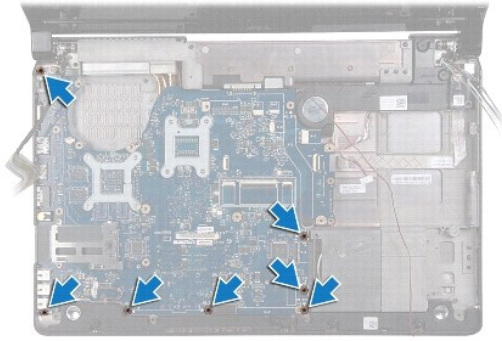

18. Disconnect the speaker cable, USB board cable, and the AC adapter cable from the connectors on the system board.

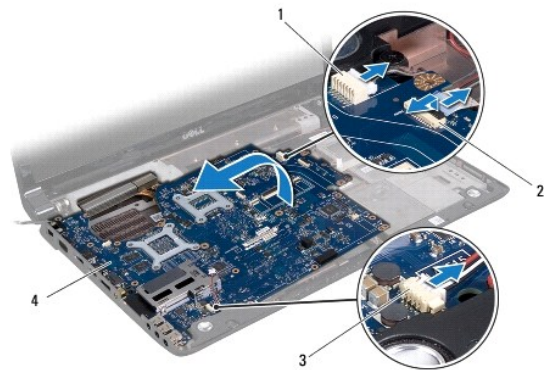

1	AC adapter cable connector	2	USB board cable connector
3	speaker cable connector	4	system board

19. Lift the system board assembly at an angle toward the side of the computer and out of the computer base.

20. Turn the system board assembly over.

21. Remove the central processor heat sink (see [Removing the Central Processor Heat Sink](#)).

22. Remove the graphic processor heat sink (see [Removing the Graphic Processor Heat Sink](#)).

23. Remove the processor module (see [Removing the Processor Module](#)).

Replacing the System Board

1. Follow the procedures in [Before You Begin](#).

2. Replace the processor module (see [Replacing the Processor Module](#)).

3. Replace the central processor heat sink (see [Replacing the Central Processor Heat Sink](#)).

4. Replace the graphic processor heat sink (see [Replacing the Graphic Processor Heat Sink](#)).

5. Turn the system board assembly over.

6. Place the system board assembly on the computer base.

7. Connect the speaker cable, USB board cable, and the AC adapter cable to the connectors on the system board.

8. Replace the seven screws that secure the system board assembly to the computer base.

9. Replace the optical drive (see [Replacing the Optical Drive](#)).
10. Replace the media card reader board (see [Replacing the Media Card Reader Board](#)).
11. Replace the thermal fan (see [Replacing the Thermal Fan](#)).
12. Replace the Bluetooth card (see [Replacing the Bluetooth Card](#)).
13. Replace the palm rest (see [Replacing the Palm Rest](#)).
14. Replace the media controls board (see [Replacing the Media Controls Board](#)).
15. Replace the keyboard (see [Replacing the Keyboard](#)).
16. Replace the center control cover (see [Replacing the Center Control Cover](#)).
17. Replace the coin-cell battery (see [Replacing the Coin-Cell Battery](#)).
18. Replace the hard drive(s) (see [Replacing the Hard Drive\(s\)](#)).
19. Replace the Mini-Card(s) (see [Replacing the Mini-Card](#)).
20. Replace the memory module(s) (see [Replacing the Memory Module\(s\)](#)).
21. Replace the base cover (see [Replacing the Base Cover](#)).
22. Replace the battery (see [Replacing the Battery](#)).
23. Reinstall any removed cards in the ExpressCard slot or the 8-in-1 media card reader.

 **CAUTION:** Before turning on the computer, replace all screws and ensure that no stray screws remain inside the computer. Failure to do so may result in damage to the computer.

24. Turn on the computer.

 **NOTE:** After you have replaced the system board, enter the computer Service Tag in the BIOS of the replacement system board.

25. Enter the service tag (see [Entering the Service Tag in the BIOS](#)).

Entering the Service Tag in the BIOS

1. Ensure that the AC adapter is plugged in and that the main battery is installed properly.
2. Turn on the computer.
3. Press <F2> during POST to enter the system setup program.
4. Navigate to the security tab and enter the service tag in the **Set Service Tag** field.

[Back to Contents Page](#)

[Back to Contents Page](#)

Dell Studio™ 1745/1747 Service Manual



NOTE: A NOTE indicates important information that helps you make better use of your computer.



CAUTION: A CAUTION indicates either potential damage to hardware or loss of data and tells you how to avoid the problem.



WARNING: A WARNING indicates a potential for property damage, personal injury, or death.

Information in this document is subject to change without notice.
© 2009 Dell Inc. All rights reserved.

Reproduction of these materials in any manner whatsoever without the written permission of Dell Inc. is strictly forbidden.

Trademarks used in this text: *Dell* and the *DELL* logo are trademarks of Dell Inc.; *Bluetooth* is a registered trademark owned by Bluetooth SIG, Inc. and is used by Dell under license; *Microsoft*, *Windows*, *Windows Vista*, and *Windows Vista* start button logo are either trademarks or registered trademarks of Microsoft Corporation in the United States and/or other countries.

Other trademarks and trade names may be used in this document to refer to either the entities claiming the marks and names or their products. Dell Inc. disclaims any proprietary interest in trademarks and trade names other than its own.

August 2009 Rev. A00

[Back to Contents Page](#)

TV Antenna Cable Assembly

Dell Studio™ 1745/1747 Service Manual

- [Removing the TV Antenna Cable Assembly](#)
- [Replacing the TV Antenna Cable Assembly](#)

- WARNING:** Before working inside your computer, read the safety information that shipped with your computer. For additional safety best practices information, see the Regulatory Compliance Homepage at www.dell.com/regulatory_compliance.
- CAUTION:** Only a certified service technician should perform repairs on your computer. Damage due to servicing that is not authorized by Dell™ is not covered by your warranty.
- CAUTION:** To avoid electrostatic discharge, ground yourself by using a wrist grounding strap or by periodically touching an unpainted metal surface (such as a connector on your computer).
- CAUTION:** To help prevent damage to the system board, remove the main battery (see [Removing the Battery](#)) before working inside the computer.
-

Removing the TV Antenna Cable Assembly

1. Follow the procedures in [Before You Begin](#).
2. Remove the battery (see [Removing the Battery](#)).
3. Follow the instructions from [step 2](#) to [step 19](#) in [Removing the System Board](#).
4. Remove the two screws that secure the TV antenna cable assembly to the computer base.
5. Release the TV antenna cable assembly from the routing guides on the computer base.
6. Lift the TV antenna cable assembly off the computer base.



1	screws (2)	2	TV antenna cable assembly
3	routing guides		

Replacing the TV Antenna Cable Assembly

1. Follow the procedures in [Before You Begin](#).
 2. Route the TV antenna cable assembly through the routing guides on the computer base.
 3. Replace the two screws that secure the TV antenna cable assembly to the computer base.
 4. Follow the instructions from [step 6](#) to [step 21](#) in [Replacing the System Board](#).
 5. Replace the battery (see [Replacing the Battery](#)).
-

USB Board

Dell Studio™ 1745/1747 Service Manual

- [Removing the USB Board](#)
- [Replacing the USB Board](#)

- WARNING:** Before working inside your computer, read the safety information that shipped with your computer. For additional safety best practices information, see the Regulatory Compliance Homepage at www.dell.com/regulatory_compliance.
- CAUTION:** Only a certified service technician should perform repairs on your computer. Damage due to servicing that is not authorized by Dell™ is not covered by your warranty.
- CAUTION:** To avoid electrostatic discharge, ground yourself by using a wrist grounding strap or by periodically touching an unpainted metal surface (such as a connector on your computer).
- CAUTION:** To help prevent damage to the system board, remove the main battery (see [Removing the Battery](#)) before working inside the computer.
-

Removing the USB Board

1. Follow the procedures in [Before You Begin](#).
2. Remove the battery (see [Removing the Battery](#)).
3. Remove the center control cover (see [Removing the Center Control Cover](#)).
4. Remove the keyboard (see [Removing the Keyboard](#)).
5. Remove the media controls board (see [Removing the Media Controls Board](#)).
6. Remove the palm rest (see [Removing the Palm Rest](#)).
7. Remove the media card reader board (see [Removing the Media Card Reader Board](#)).
8. Remove the optical drive (see [Removing the Optical Drive](#)).
9. Lift the latch to disconnect the USB board cable from the USB board cable connector on the system board.
10. Remove the screw that secures the USB board to the computer base.
11. Make note of the USB board cable routing and pry up the USB board cable.
12. Remove the USB board from the computer base.

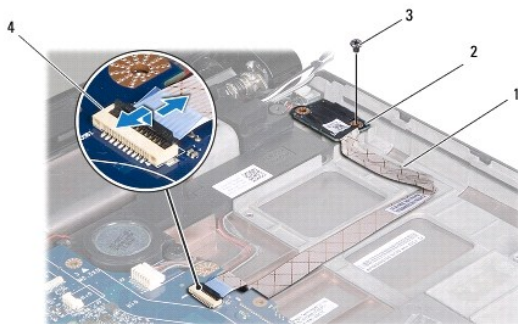

1	USB board cable	2	USB board
3	screw	4	USB board cable connector

Replacing the USB Board

1. Follow the procedures in [Before You Begin](#).
 2. Align the hole on the USB board with the protrusion on the computer base.
 3. Replace the screw that secures the USB board to the computer base.
 4. Route the USB board cable and press down on the latch to connect the USB board cable to the USB board cable connector on the system board.
 5. Replace the optical drive (see [Replacing the Optical Drive](#)).
 6. Replace the media card reader board (see [Replacing the Media Card Reader Board](#)).
 7. Replace the palm rest (see [Replacing the Palm Rest](#)).
 8. Replace the media controls board (see [Replacing the Media Controls Board](#)).
 9. Replace the keyboard (see [Replacing the Keyboard](#)).
 10. Replace the center control cover (see [Replacing the Center Control Cover](#)).
 11. Replace the battery (see [Replacing the Battery](#)).
-

[Back to Contents Page](#)