

TOSHIBA
Satellite P200/
Satellite Pro P200 Series
User's Manual

Copyright

© 2007 by TOSHIBA Corporation. All rights reserved. Under copyright law, this manual cannot be reproduced in any form without the prior written permission of TOSHIBA. No patent liability is assumed, with respect to the use of the information contained herein.

TOSHIBA Satellite P200/Satellite Pro P200 Series Portable Personal Computer User's Manual

First edition March 2007

Ownership and copyright of music, video computer programs, databases, etc. are protected by the copyright laws. These copyrighted materials may be copied for private use at home only. If, beyond the limitation above, you copy (including to transform data formats) or modify these materials, transfer them or distribute them via the Internet without approval of copyright owners, you may be subject to claims for compensation for damage and/or criminal penalties due to infringements of copyrights or personal rights. Please remember to observe the copyright laws when you use this product to copy the copyrighted works or perform other actions. Please note that you may infringe the owner's rights protected by the copyright laws if you use the screen mode switching functions (e.g. Wide mode, Wide Zoom mode, etc.) of this product to display enlarged images/video at coffee shops or hotels for the purposes of profits or providing these to the public.

Disclaimer

This manual has been validated and reviewed for accuracy. The instructions and descriptions it contains are accurate for the Satellite P200/Satellite Pro P200 Series Portable Personal Computers at the time of this manual's production. However, succeeding computers and manuals are subject to change without notice. TOSHIBA assumes no liability for damages incurred directly or indirectly from errors, omissions or discrepancies between the computer and the manual.

Trademarks

IBM is a registered trademark and IBM PC, OS/2, and PS/2 are trademarks of International Business Machines Corporation.

Celeron, Intel, Intel SpeedStep, Pentium, Intel Core and Centrino are trademarks or registered trademarks of Intel Corporation or its subsidiaries in the United States and other countries.

MS-DOS, Microsoft, Windows and DirectX are registered trademarks and Microsoft Vista is a Trademark of Microsoft Corporation.

Centronics is a registered trademark of Centronics Data Computer Corporation. Photo CD is a trademark of Eastman Kodak.

Bluetooth is a trademark owned by its proprietor and used by TOSHIBA under license.

iLINK is a trademark of Sony Corporation.

Other trademarks and registered trademarks not listed above may be used in this manual.

Macrovision License of Notice

This product incorporates copyright protection technology that is protected by U.S. patents and other intellectual property rights. Use of this copyright protection technology must be authorized by Macrovision, and is intended for home and other limited viewing uses only unless otherwise authorized by Macrovision. Reverse engineering or disassembly is prohibited.

Safety Instructions

Use the following safety guidelines to help protect yourself and your computer.

When Using Your Computer

Do not operate your portable computer for an extended period of time with the base resting directly on your body. With extended operation, heat can potentially build up in the base. Allowing sustained contact with the skin could cause discomfort or, eventually, a burn.

- Do not attempt to service the computer yourself. Always follow installation instructions closely.
- Do not carry a battery in your pocket, purse, or other container where metal objects (such as car keys) could short-circuit the battery terminals. The resulting excessive current flow can cause extremely high temperatures and may result in damage from burns.
- Be sure that nothing rests on your AC adapter's power cable and that the cable is not located where it can be tripped over or stepped on.
- Place the AC adapter in a ventilated area, such as a desk top or on the floor, when you use it to run the computer or to charge the battery. Do not cover the AC adapter with papers or other items that will reduce cooling; also, do not use the AC adapter while it is inside a carrying case.
- Use only the AC adapter and batteries that are approved for use with this computer. Use of another type of battery or AC adapter may risk fire or explosion.

- Before you connect the computer to a power source, ensure that the voltage rating of the AC adapter matches that of the available power source.
 - 115V/60Hz in most of North and South America and some Far Eastern countries such as Taiwan.
 - 100 V/50Hz in eastern Japan and 100 V/60Hz in western Japan.
 - 230 V/50 Hz in most of Europe, the Middle East, and the Far East.
- If you use an extension cable with your AC adapter, ensure that the total ampere rating of the products that are plugged into it do not exceed the ampere rating of the extension cable itself.
- To help avoid the potential hazard of electric shock, do not connect or disconnect any cables or perform maintenance or reconfiguration of this product during an electrical storm.
- When setting up the computer for work, place it on a level surface.
- Do not dispose of batteries in a fire. They may explode. Check with local authorities for disposal instructions.
- When travelling, do not check the computer as baggage. You can put your computer through an X-ray security machine, but never put your computer through a metal detector. If you have the computer checked by hand, be sure to have a charged battery available in case you are asked to turn on the computer.
- When travelling with the hard drive removed from the computer, wrap the drive in a non-conducting material, such as cloth or paper. If you have the drive checked by hand, be ready to install the drive in the computer. You can put the hard drive through an X-ray security machine, but never put it through a metal detector.
- When travelling, do not place the computer in overhead storage compartments where it could slide around. Do not drop your computer or subject it to other mechanical shocks.
- Protect your computer, battery, and hard drive from environmental hazards such as dirt, dust, food, liquids, temperature extremes, and overexposure to sunlight.
- When you move your computer between environments with very different temperature and/or humidity ranges, condensation may form on or within the computer. To avoid damaging the computer, allow sufficient time for the moisture to evaporate before using the computer.
- When you disconnect a cable, pull on its connector or on its strain relief loop, not on the cable itself. As you pull out the connector, keep it evenly aligned to avoid bending any connector pins. Also, before you connect a cable make sure both connectors are correctly oriented and aligned.
- Before you clean your computer, turn it off, unplug it from its power source, and remove the battery.
- Handle components with care. Hold a component such as a memory module by its edges, not its pins.



When using telephone equipment in conjunction with your computer, basic safety precautions should always be followed to reduce the risk of fire, electric shock and injury to persons, including the following:

- Do not use this product near water, for example, near a bathtub, washing bowl, kitchen sink or laundry tub, in a wet basement or near a swimming pool.
- Avoid using a telephone (other than a cordless type) during an electrical storm. There may be a remote risk of electric shock from lightning.
- Do not use the telephone to report a gas leak in the vicinity of the leak.
- Use only the power cord indicated in this manual.
- Replace only with the same or equivalent type battery recommended by the manufacturer.
- Dispose of used batteries according to the manufacturer's instructions.
- To reduce the risk of fire, use only No. 26 AWG or larger telecommunication line cord.



Use only the battery pack that came with the computer or an optional battery pack. Use of the wrong battery could damage your computer.

TOSHIBA assumes no liability for any damage in such case.

FCC information

Model Name: Satellite P200/Satellite Pro P200 Series

FCC notice "Declaration of Conformity Information"

This equipment has been tested and found to comply with the limits for a Class B digital device, pursuant to part 15 of the FCC rules. These limits are designed to provide reasonable protection against harmful interference in a residential installation.

This equipment generates, uses and can radiate radio frequency energy and, if not installed and used in accordance with the instructions, may cause harmful interference to radio communications. However, there is no guarantee that interference will not occur in a particular installation. If this equipment does cause harmful interference to radio or television reception, which can be determined by turning the equipment off and on, the user is encouraged to try to correct the interference by one or more of the following measures:

- Reorient or relocate the receiving antenna.
- Increase the separation between the equipment and receiver.
- Connect the equipment into an outlet on a circuit different from that to which the receiver is connected.
- Consult the dealer or an experienced radio/TV technician for help.



Only peripherals complying with the FCC class B limits may be attached to this equipment. Operation with non-compliant peripherals or peripherals not recommended by TOSHIBA is likely to result in interference to radio and TV reception. Shielded cables must be used between the external devices and the computer's or expansion unit's external monitor port, parallel port, USB port and microphone jack. Changes or modifications made to this equipment, not expressly approved by TOSHIBA or parties authorized by TOSHIBA could void the user's authority to operate the equipment.

EMC Regulatory Information

Contact

Address:	TOSHIBA America Information Systems, Inc. 9740 Irvine Boulevard Irvine, California 92618-1697
Telephone:	(949) 583-3000

EU Declaration of Conformity



TOSHIBA declares, that the product: Satellite P200/Satellite Pro P200 Series conforms to the following Standards:

This product is labelled with the CE Mark in accordance with the related European Directives, notably Electromagnetic Compatibility Directive 89/336/EEC for the notebook and the electronic accessories including the supplied power adapter, the Radio Equipment and Telecommunications Terminal Equipment Directive 99/5/EEC in case of implemented telecommunication accessories and the Low Voltage Directive 73/23/EEC for the supplied power adapter.

CE Marking is the responsibility of TOSHIBA EUROPE GmbH, Hammfelddamm 8, 41460 Neuss, Germany, phone +49-(0)-2131-158-01. For a copy of the related CE Declaration of Conformity please refer to the following website: <http://epps.toshiba-teg.com>.

Canadian Regulatory Information (Canada Only)

This digital apparatus does not exceed the Class B limits for radio noise emissions from digital apparatus as set out in the Radio Interference Regulation of the Canadian Department of Communications.

Note that Canadian Department of Communications (DOC) regulations provide, that changes or modifications not expressly approved by TOSHIBA Corporation could void your authority to operate this equipment.

This Class B digital apparatus meets all requirements of the Canadian Interference-Causing Equipment Regulations.

Cet appareil numérique de la class B respecte toutes les exigences du Règlement sur le matériel brouilleur du Canada.

BSMI Notice (Taiwan Only)

警告使用者：

這是乙類的資訊產品，在開放的環境中使用時，可能會造成無線電干擾，在這種情形下，使用者會被要求採取某些適當的對策。

Following information is only for EU-member states:

The symbol indicates that this product may not be treated as household waste. Please ensure this product is properly disposed as inappropriate waste handling of this product may cause potential hazards to the environment and human health. For more detailed information about recycling of this product, please contact your local city office, your household waste disposal service or the shop where you purchased the product.



This symbol may not stick depending on the country and region where you purchased.

Optical Disc Drive Safety Instruction



■ *Be sure to check the international precautions at the end of this section.*

The optical drive that is used in this computer is equipped with a laser device. A classification label with the following sentence is affixed to the surface of the drive.

CLASS 1 LASER PRODUCT
LASER KLASSE 1
LUOKAN 1 LASERLAITE
APPAREIL A LASER DE CLASSE 1
KLASS 1 LASER APPARAT

The drive with the above label is certified by the manufacturer that the drive complies with the requirement for laser product on the date of manufacturing pursuant to article 21 of Code of Federal Regulations by the United States of America, Department of Health & Human Services, Food and Drug Administration.

In other countries, the drive is certified to comply with the requirement pursuant to IEC 825 and EN60825 on class 1 laser product.

This computer is equipped with one of the optical drive in the following list according to the model.

TOSHIBA Samsung Storage Technology

CD-RW/DVD-ROM TS-L462D



- *The CD-RW/DVD-ROM drive employs a laser system. To ensure proper use of this product, please read this instruction manual carefully and retain for future reference. Should the unit ever require maintenance, contact an authorized service location.*
- *Use of controls, adjustments or the performance of procedures other than those specified may result in hazardous radiation exposure.*
- *To prevent direct exposure to the laser beam, do not try to open the enclosure.*

Location of the required label

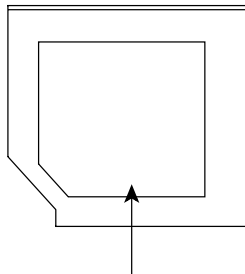

SERIAL NO.

MANUFACTURED:

COMPLIES WITH FDA RADIATION
PERFORMANCE STANDARDS, 21 CFR
SUBCHAPTER J.

CLASS 1 LASER PRODUCT
LASER KLASSE 1

TOSHIBA Samsung Storage Technology
Korea Corporation
416, Maetan-3Dong, Yeongtong-Gu, Suwon City,
Gyeonggi-Do, 443-742, Korea

TEAC

CD-RW/DVD-ROM DW-224E



- *The CD-RW/DVD-ROM drive employs a laser system. To ensure proper use of this product, please read this instruction manual carefully and retain for future reference. Should the unit ever require maintenance, contact an authorized service location.*
- *Use of controls, adjustments or the performance of procedures other than those specified may result in hazardous radiation exposure.*
- *To prevent direct exposure to the laser beam, do not try to open the enclosure.*

Location of the required label

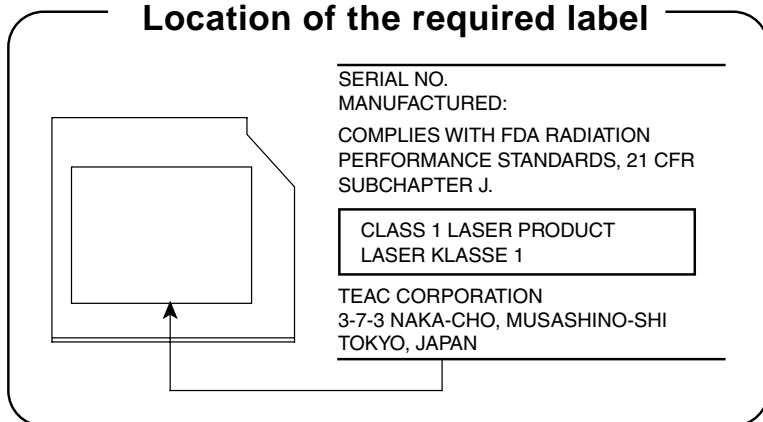

Pioneer

DVD Super Multi DVR-K17



- The DVD Super Multi drive employs a laser system. To ensure proper use of this product, please read this instruction manual carefully and retain for future reference. Should the unit ever require maintenance, contact an authorized service location.
- Use of controls, adjustments or the performance of procedures other than those specified may result in hazardous radiation exposure.
- To prevent direct exposure to the laser beam, do not try to open the enclosure.

Location of the required label

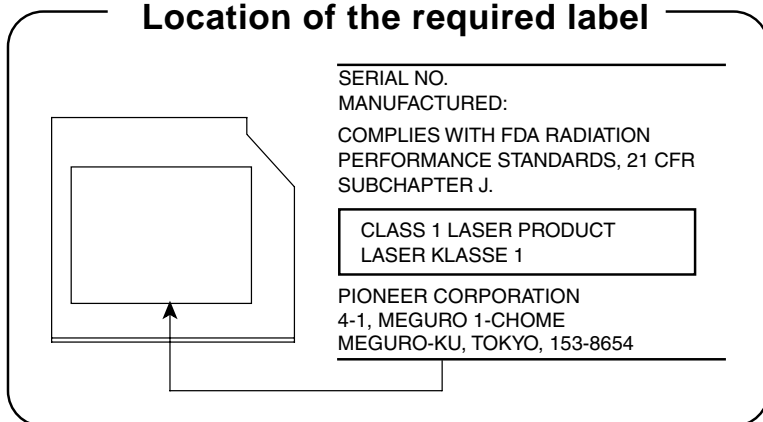

TOSHIBA Samsung Storage Technology

TS-L632D



- *The drive employs a laser system. To ensure proper use of this product, please read this instruction manual carefully and retain for future reference. Should the unit ever require maintenance, contact an authorized service location.*
- *Use of controls, adjustments or the performance of procedures other than those specified may result in hazardous radiation exposure.*
- *To prevent direct exposure to the laser beam, do not try to open the enclosure.*

Location of the required label

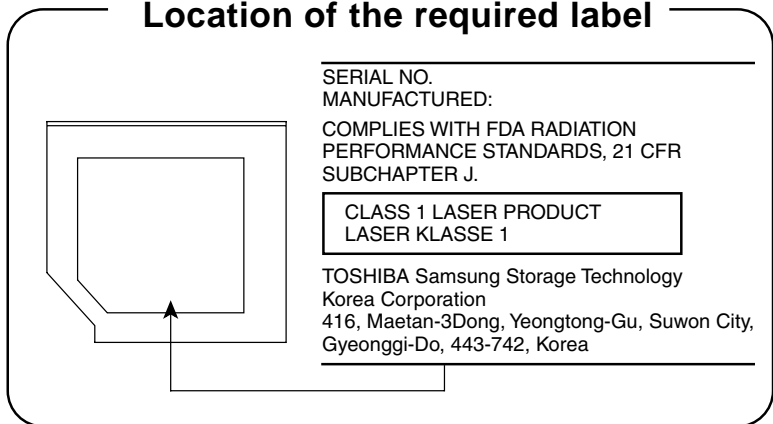

Hitachi-LG Data Storage

DVD Super Multi GSA-T20N



- *The DVD Super Multi drive employs a laser system. To ensure proper use of this product, please read this instruction manual carefully and retain for future reference. Should the unit ever require maintenance, contact an authorized service location.*
- *Use of controls, adjustments or the performance of procedures other than those specified may result in hazardous radiation exposure.*
- *To prevent direct exposure to the laser beam, do not try to open the enclosure.*

Location of the required label

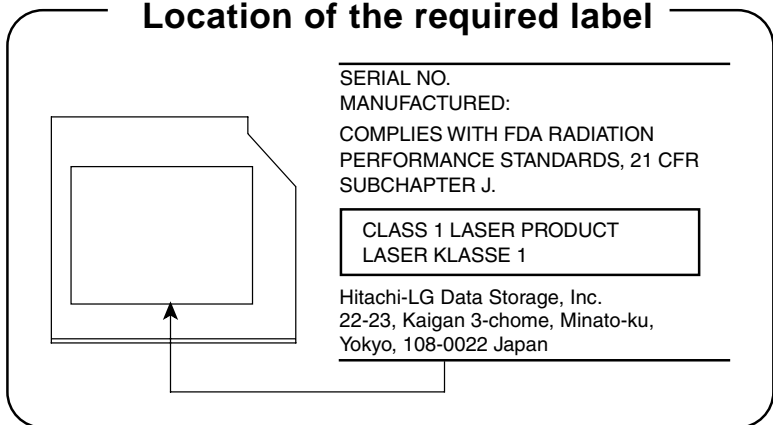

Panasonic

DVD Super Multi UJ-850U



- *The DVD Super Multi drive employs a laser system. To ensure proper use of this product, please read this instruction manual carefully and retain for future reference. Should the unit ever require maintenance, contact an authorized service location.*
- *Use of controls, adjustments or the performance of procedures other than those specified may result in hazardous radiation exposure.*
- *To prevent direct exposure to the laser beam, do not try to open the enclosure.*

Location of the required label

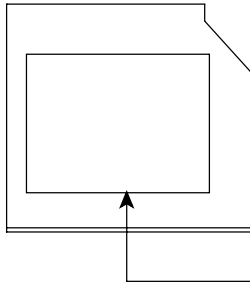

SERIAL NO.
MANUFACTURED:
COMPLIES WITH FDA RADIATION
PERFORMANCE STANDARDS, 21 CFR
SUBCHAPTER J.

CLASS 1 LASER PRODUCT
LASER KLASSE 1

Panasonic Communications Co., Ltd.
1-62, 4-Chome Minoshima, Hakata-Ku
Fukuoka, Japan

TEAC

DV-W28EC



- *The drive employs a laser system. To ensure proper use of this product, please read this instruction manual carefully and retain for future reference. Should the unit ever require maintenance, contact an authorized service location.*
- *Use of controls, adjustments or the performance of procedures other than those specified may result in hazardous radiation exposure.*
- *To prevent direct exposure to the laser beam, do not try to open the enclosure.*

Location of the required label

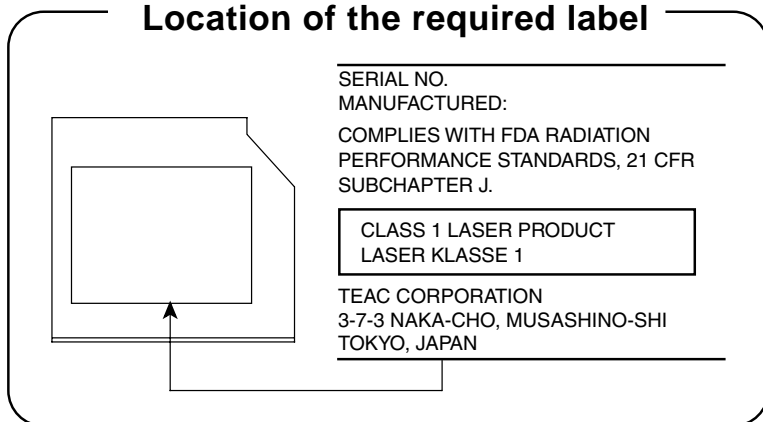

International Precautions

CLASS 1 LASER PRODUCT
LASER KLASSE 1 PRODUKT
TO EN 60825-1
クラス1レーザー製品

CAUTION: This appliance contains a laser system and is classified as a "CLASS 1 LASER PRODUCT." To use this model properly, read the instruction manual carefully and keep this manual for your future reference. In case of any trouble with this model, please contact your nearest "AUTHORIZED service station." To prevent direct exposure to the laser beam, do not try to open the enclosure.

CLASS 1 LASER PRODUCT
LASERSCHUTZKLASSE 1
PRODUKT
TO EN60825

VORSICHT: Dieses Gerät enthält ein Laser-System und ist als "LASERSCHUTZKLASSE 1 PRODUKT" klassifiziert. Für den richtigen Gebrauch dieses Modells lesen Sie bitte die Bedienungsanleitung sorgfältig durch und bewahren diese bitte als Referenz auf. Falls Probleme mit diesem Modell auftreten, benachrichtigen Sie bitte die nächste "autorisierte Service-Vertretung". Um einen direkten Kontakt mit dem Laserstrahl zu vermeiden darf das Gerät nicht geöffnet werden.

ADVERSEL: USYNLIG
LASERSTRÅLING VED ÅBNING.
NÅR SIKKERHEDSAF-BRYDER
ER UDE AF FUNKTION.
UNDGÅ UDSÆTTELSE FOR
STRÅLING

ADVARSEL: Denne mærkning er anbragt udvendigt på apparatet og indikerer, at apparatet arbejder med laserstråler af klasse 1, hvilket betyder, at der anvendes laserstråler af svageste klasse, og at man ikke på apparatets yderside kan blive udsat for utilsigelig kraftig stråling.

APPARATET BOR KUN ÅBNES AF FAGFOLK MED SÆRLIGT KENDSKAB TIL APPARATER MED LASERSTRÅLER!

Indvendigt i apparatet er anbragt den her gengivne advarselsmærkning, som advarer imod at foretage sådanne indgreb i apparatet, at man kan komme til at udsætte sig for laserstråling.

OBS! Apparaten innehåller laserkomponent som avger laserstråling överstigande gränsen för laserklass 1.

VAROITUS. Suojakoteloja si saa avata. Laite sisältää laserdiodin, joka lähettää näkymätöntä silmilie vaarallista lasersäteilyä.

CAUTION: USE OF CONTROLS OR ADJUSTMENTS OR PERFORMANCE OF PROCEDURES OTHER THAN THOSE SPECIFIED IN THE OWNER'S MANUAL MAY RESULT IN HAZARDOUS RADIATION EXPOSURE.

VORSICHT: DIE VERWENDUNG VON ANDEREN STEUERUNGEN ODER EINSTELLUNGEN ODER DAS DURCHFÜHREN VON ANDEREN VORGÄNGEN ALS IN DER BEDIENUNGSANLEITUNG BESCHRIEBEN KÖNNEN GEFÄHRLICHE STRAHLENEXPOSITIONEN ZUR FOLGE HABEN.

Modem warning notice

Conformity Statement

The equipment has been approved to [Commission Decision "CTR21"] for pan-European single terminal connection to the Public Switched Telephone Network (PSTN).

However, due to differences between the individual PSTNs provided in different countries/regions the approval does not, of itself, give an unconditional assurance of successful operation on every PSTN network termination point.

In the event of problems, you should contact your equipment supplier in the first instance.

Network Compatibility Statement

This product is designed to work with, and is compatible with the following networks. It has been tested to and found to conform with the additional requirements conditional in EG 201 121.

Germany	ATAAB AN005, AN006, AN007, AN009, AN010 and DE03, 04, 05, 08, 09, 12, 14, 17
Greece	ATAAB AN005, AN006 and GR01, 02, 03, 04
Portugal	ATAAB AN001, 005, 006, 007, 011 and P03, 04, 08, 10
Spain	ATAAB AN005, 007, 012, and ES01
Switzerland	ATAAB AN002
Norway	ATAAB AN002, 005, 007 and NO 01, 02
All other countries/ regions	ATAAB AN003, 004

Specific switch settings or software setup are required for each network, please refer to the relevant sections of the user guide for more details.

The hookflash (timed break register recall) function is subject to separate national type approvals. It has not been tested for conformity to national type regulations, and no guarantee of successful operation of that specific function on specific national networks can be given.

Japan regulations

Region selection

If you are using the computer in Japan, technical regulations described in the Telecommunications Business Law require that you select the Japan country mode.

It is illegal to use the modem in Japan with any other selection.

Redial

Up to two redial attempts can be made. If more than two redial attempts are made, the modem will return Black Listed. If you are experiencing problems with the Black Listed code, set the interval between redials at one minute or longer.

Japan's Telecommunications Business Law permits up to two redials on analogue telephones, but the redials must be made within a total of three minutes.

The internal modem is approved by Japan Approvals Institute for Telecommunications Equipment.



A05-0413001

Pursuant to FCC CFR 47, Part 68:

When you are ready to install or use the modem, call your local telephone company and give them the following information:

- The telephone number of the line to which you will connect the modem
- The registration number that is located on the device

US: AGSMD01BDELPHI

The FCC registration number of the modem will be found on either the device which is to be installed, or, if already installed, on the bottom of the computer outside of the main system label.

- The Ringer Equivalence Number (REN) of the modem, which can vary. For the REN of your modem, refer to your computer's user's guide.

The modem connects to the telephone line by means of a standard jack called the USOC RJ11C.

Type of service

Your modem is designed to be used on standard-device telephone lines. Connection to telephone company-provided coin service (central office implemented systems) is prohibited. Connection to party lines service is subject to state tariffs. If you have any questions about your telephone line, such as how many pieces of equipment you can connect to it, the telephone company will provide this information upon request.

Telephone company procedures

The goal of the telephone company is to provide you with the best service it can. In order to do this, it may occasionally be necessary for them to make changes in their equipment, operations, or procedures. If these changes might affect your service or the operation of your equipment, the telephone company will give you notice in writing to allow you to make any changes necessary to maintain uninterrupted service.

If problems arise

If any of your telephone equipment is not operating properly, you should immediately remove it from your telephone line, as it may cause harm to the telephone network. If the telephone company notes a problem, they may temporarily discontinue service. When practical, they will notify you in advance of this disconnection.

If advance notice is not feasible, you will be notified as soon as possible. When you are notified, you will be given the opportunity to correct the problem and informed of your right to file a complaint with the FCC. In the event repairs are ever needed on your modem, they should be performed by TOSHIBA Corporation or an authorized representative of TOSHIBA Corporation.

Disconnection

If you should ever decide to permanently disconnect your modem from its present line, please call the telephone company and let them know of this change.

Fax branding

The Telephone Consumer Protection Act of 1991 makes it unlawful for any person to use a computer or other electronic device to send any message via a telephone fax machine unless such message clearly contains in a margin at the top or bottom of each transmitted page or on the first page of the transmission, the date and time it is sent and an identification of the business, other entity or individual sending the message and the telephone number of the sending machine or such business, other entity or individual. In order to program this information into your fax modem, you should complete the setup of your fax software before sending messages.

Instructions for IC CS-03 certified equipment

1. NOTICE: The Industry Canada label identifies certified equipment. This certification means that the equipment meets certain telecommunications network protective, operational and safety requirements as prescribed in the appropriate Terminal Equipment Technical Requirements document(s). The Department does not guarantee the equipment will operate to the user's satisfaction.

Before installing this equipment, users should ensure that it is permissible to be connected to the facilities of the local telecommunications company. The equipment must also be installed using an acceptable method of connection.

The customer should be aware that compliance with the above conditions may not prevent degradation of service in some situations. Repairs to certified equipment should be coordinated by a representative designated by the supplier. Any repairs or alterations made by the user to this equipment, or equipment malfunctions, may give the telecommunications company cause to request the user to disconnect the equipment.

Users should ensure for their own protection that the electrical ground connections of the power utility, telephone lines and internal metallic water pipe system, if present, are connected together. This precaution may be particularly important in rural areas.



Users should not attempt to make such connections themselves, but should contact the appropriate electric inspection authority, or electrician, as appropriate.

2. The user manual of analog equipment must contain the equipment's Ringer Equivalence Number (REN) and an explanation notice similar to the following: The Ringer Equivalence Number (REN) of the modem, which can vary. For the REN of your modem, refer to your computer's user's guide.



The Ringer Equivalence Number (REN) assigned to each terminal device provides an indication of the maximum number of terminals allowed to be connected to a telephone interface. The termination on an interface may consist of any combination of devices subject only to the requirement that the sum of the Ringer Equivalence Numbers of all the devices does not exceed 5.

3. The standard connecting arrangement (telephone jack type) for this equipment is jack type(s): USOC RJ11C.

The IC registration number of the modem is shown below.

Canada: 4005B-DELPHI

Notes for Users in Australia and New Zealand

Modem warning notice for Australia

Modems connected to the Australian telecoms network must have a valid Austel permit. This modem has been specifically configured to ensure compliance with Austel standards when the country/region selection is set to Australia.

The use of other country/region setting while the modem is attached to the Australian PSTN would result in your modem being operated in a non-compliant manner. To verify that the country/region is correctly set, enter the command AT1 which displays the currently active setting.

To set the country/region permanently to Australia, enter the following command sequence:

- AT%TE=1
- ATS133=1
- AT&F
- AT&W
- AT%TE=0
- ATZ

Failure to set the modem to the Australia country/region setting as shown above will result in the modem being operated in a non-compliant manner. Consequently, there would be no permit in force for this equipment and the Telecoms Act 1991 prescribes a penalty of \$12,000 for the connection of non-permitted equipment.

Notes for use of this device in New Zealand

- The grant of a Telepermit for a device in no way indicates Telecom acceptance of responsibility for the correct operation of that device under all operating conditions. In particular the higher speeds at which this modem is capable of operating depend on a specific network implementation which is only one of many ways of delivering high quality voice telephony to customers. Failure to operate should not be reported as a fault to Telecom.
- In addition to satisfactory line conditions a modem can only work properly if:
 - a/ it is compatible with the modem at the other end of the call and
 - b/ the application using the modem is compatible with the application at the other end of the call - e.g., accessing the Internet requires suitable software in addition to a modem.
- This equipment shall not be used in any manner which could constitute a nuisance to other Telecom customers.

- Some parameters required for compliance with Telecom's PTC Specifications are dependent on the equipment (PC) associated with this modem. The associated equipment shall be set to operate within the following limits for compliance with Telecom Specifications:
 - a/ There shall be no more than 10 call attempts to the same number within any 30 minute period for any single manual call initiation, and
 - b/ The equipment shall go on-hook for a period of not less than 30 seconds between the end of one attempt and the beginning of the next.
 - c/ Automatic calls to different numbers shall be not less than 5 seconds apart.
- Immediately disconnect this equipment should it become physically damaged, and arrange for its disposal or repair.
- The correct settings for use with this modem in New Zealand are as follows:
 - ATB0 (CCITT operation)
 - AT&G2 (1800 Hz guard tone)
 - AT&P1 (Decadic dialling make-break ratio =33%/67%)
 - ATS0=0 (not auto answer)
 - ATS10=less than 150 (loss of carrier to hangup delay, factory default of 15 recommended)
 - ATS11=90 (DTMF dealing on/off duration=90 ms)
 - ATX2 (Dial tone detect, but not (U.S.A.) call progress detect)
- When used in the Auto Answer mode, the S0 register must be set with a value of 3 or 4. This ensures:
 - (a) a person calling your modem will hear a short burst of ringing before the modem answers. This confirms that the call has been successfully switched through the network.
 - (b) caller identification information (which occurs between the first and second ring cadences) is not destroyed.
- The preferred method of dialling is to use DTMF tones (ATDT...) as this is faster and more reliable than pulse (decadic) dialling. If for some reason you must use decadic dealing, your communications program must be set up to record numbers using the following translation table as this modem does not implement the New Zealand "Reverse Dialling" standard.
 - Number to be dialled: 0 1 2 3 4 5 6 7 8 9
 - Number to program into computer: 0 9 8 7 6 5 4 3 2 1
 - Note that where DTMF dealing is used, the numbers should be entered normally.
- The transmit level from this device is set at a fixed level and because of this there may be circumstances where the performance is less than optimal. Before reporting such occurrences as faults, please check the line with a standard Telepermitted telephone, and only report a fault if the phone performance is impaired.

- It is recommended that this equipment be disconnected from the Telecom line during electrical storms.
- When relocating the equipment, always disconnect the Telecom line connection before the power connection, and reconnect the power first.
- This equipment may not be compatible with Telecom Distinctive Alert cadences and services such as FaxAbility.

(NOTE THAT FAULT CALL OUT CAUSED BY ANY OF THE ABOVE CAUSES MAY INCUR A CHARGE FROM TELECOM)

General conditions

As required by PTC 100, please ensure that this office is advised of any changes to the specifications of these products which might affect compliance with the relevant PTC Specifications.

The grant of this Telepermit is specific to the above products with the marketing description as stated on the Telepermit label artwork. The Telepermit may not be assigned to other parties or other products without Telecom approval.

A Telepermit artwork for each device is included from which you may prepare any number of Telepermit labels subject to the general instructions on format, size and colour on the attached sheet.

The Telepermit label must be displayed on the product at all times as proof to purchasers and service personnel that the product is able to be legitimately connected to the Telecom network.

The Telepermit label may also be shown on the packaging of the product and in the sales literature, as required in PTC 100.

The charge for a Telepermit assessment is \$337.50. An additional charge of \$337.50 is payable where an assessment is based on reports against non-Telecom New Zealand Specifications. \$112.50 is charged for each variation when submitted at the same time as the original.

An invoice for \$NZ1237.50 will be sent under separate cover.

Important Notice

Copyrighted works including, but not limited to music, video, computer program, databases are protected by copyright laws. Unless specifically permitted under applicable copyright laws, you cannot copy, modify, assign, transmit or otherwise dispose of any copyrighted work with the consent of the owner of the copyright.

Please take notice that unauthorized copying, modification, assignment, transmission and disposition may be subject to claims for damages and penalties.

General Precautions

TOSHIBA computers are designed to optimize safety, minimize strain and withstand the rigors of portability. However, certain precautions should be observed to further reduce the risk of personal injury or damage to the computer.

Be certain to read the general precautions below and to note the cautions included in the text of the manual.

Creating a computer-friendly environment

Place the computer on a flat surface that is large enough for the computer and any other items you are using, such as a printer.

Leave enough space around the computer and other equipment to provide adequate ventilation. Otherwise, they may overheat.

To keep your computer in prime operating condition, protect your work area from:

- Dust, moisture, and direct sunlight.
- Equipment that generates a strong electromagnetic field, such as stereo speakers (other than speakers that are connected to the computer) or speakerphones.
- Rapid changes in temperature or humidity and sources of temperature change such as air conditioner vents or heaters.
- Extreme heat, cold, or humidity.
- Liquids and corrosive chemicals.

Stress injury

Carefully read the Instruction Manual for Safety and Comfort. It contains information on the prevention of stress injuries to your hands and wrists that can be caused by extensive keyboard use. Chapter 3, *Getting Started*, also includes information on work space design, posture and lighting that can help reduce physical stress.

Heat injury

- Avoid prolonged physical contact with the computer. If the computer is used for long periods, its surface can become very warm. While the temperature will not feel hot to the touch, if you maintain physical contact with the computer for a long time, for example if you rest the computer on your lap or if you keep your hands on the palm rest, your skin might suffer a low-heat injury.
- If the computer has been used for a long time, avoid direct contact with the metal plate supporting the various interface ports as this can become hot.
- The surface of the AC adaptor can become hot when in use but this condition does not indicate a malfunction. If you need to transport the AC adaptor, you should disconnect it and let it cool before moving it.
- Do not lay the AC adaptor on a material that is sensitive to heat as the material could become damaged.

Pressure or impact damage

Do not apply heavy pressure to the computer or subject it to any form of strong impact as this can damage the computer's components or otherwise cause it to malfunction.

PC Card overheating

Some PC Cards can become hot during prolonged use which may result in errors or instability in the operation of the device in question. In addition, you should also be careful when you remove a PC Card that has been used for a long time.

Mobile phones

Please be aware that the use of mobile phones can interfere with the audio system. The operation of the computer will not be impaired in any way, but it is recommended that a minimum distance of 30cm is maintained between the computer and a mobile phone that is in use.

Instruction Manual for Safety and Comfort

All important information on the safe and proper use of this computer is described in the enclosed Instruction Manual for Safety and Comfort. Be sure to read it before using the computer.

Table of Contents

Preface

Manual contents	xxxii
Conventions	xxxiii
Equipment checklist	xxxiv

Chapter 1 Satellite P200/Satellite Pro P200 Series

Features

Features	1-1
Special features	1-8
TOSHIBA Value Added Package	1-9
Utilities and Applications	1-10
Options	1-13

Chapter 2 The Grand Tour

Front with the display closed.	2-1
Right side	2-3
Left side	2-4
Underside.	2-6
Front with the display open	2-7
Keyboard Indicators.	2-10
Optical Disc drive.	2-10

Chapter 3 Getting Started

Connecting the AC adapter	3-2
Opening the display	3-3
Turning on the power	3-3
Starting up for the first time	3-4
Turning off the power	3-4
Restarting the computer	3-8
System Recovery Options	3-9
Restoring the preinstalled software from the Product Recovery disc	3-9
Create an Optical Recovery Discs	3-10
Restoring the pre-installed software from the Recovery Hard Disk Drive	3-11
Restoring the pre-installed software from your created Recovery Discs	3-11

Chapter 4 Operating Basics

Using the TouchPad/Dual Mode Pad	4-1
Dual Mode Pad Button function (Dual Mode Pad is provided with some models)	4-2
Using the FingerPrint (FingerPrint sensor is provided with some models)	4-3
Using the Web Camera	4-11
Using the internal modem	4-13
LAN	4-16
Wireless LAN	4-17
Using optical disc drives	4-19
*Writing CDs on a CD-RW/DVD-ROM drive	4-24
Writing CDs/DVDs on a DVD Super Multi drive supporting double layer disc recording	4-26
When Using Ulead DVD MovieFactory® for TOSHIBA	4-30
TOSHIBA Disc Creator	4-32
Media Care	4-33
Disks	4-34
TV-Out	4-34
Setting up more than one display	4-35
Cleaning the computer	4-36
Moving the computer	4-36

Chapter 5 The Keyboard

Typewriter keys	5-1
F1 ... F12 function keys	5-2
Soft keys: Fn key combinations	5-2
Hotkeys	5-3
Windows special keys	5-4
Number Pad	5-4
Generating ASCII characters	5-4

Chapter 6 Power and Power-Up Modes

Power conditions	6-1
Power indicators	6-3
Battery types	6-4
Care and use of the battery pack	6-5
Replacing the battery pack	6-10
TOSHIBA Password Utility	6-13
Power-up modes	6-14
Panel power off/on	6-14
System automatic Sleep/Hibernation	6-14

Chapter 7 HW Setup

Accessing HW Setup	7-1
HW Setup Window	7-1

Chapter 8 Optional Devices

Express Card	8-2
SD/SDHC/MMC/MS/MS Pro/xD Memory cards	8-3
Memory expansion	8-6
Additional battery pack	8-9
Additional AC adapter	8-9
Battery charger	8-9
External monitor	8-9
Television	8-10
i.LINK (IEEE1394a)	8-15
Security lock	8-16

Chapter 9 Troubleshooting

Problem solving process	9-1
Hardware and system checklist	9-3
TOSHIBA support	9-18

Chapter 10 Disclaimers

CPU	10-1
Memory (Main System)	10-2
Battery Life	10-2
HDD Drive Capacity	10-3
LCD	10-3
Graphics Processor Unit (“GPU”)	10-3
Wireless LAN	10-3
Non-applicable Icons	10-3
Copy Protection	10-4
Images	10-4
LCD Brightness and Eye Strain	10-4

Appendix A Specifications

Appendix B Display Modes

Appendix C AC Power Cord and Connectors

Glossary

Preface

Congratulations on your purchase of the Satellite P200/Satellite Pro P200 Series computer. This powerful notebook computer provides excellent expansion capability, including multimedia devices, and it is designed to provide years of reliable, high-performance computing.

This manual tells how to set up and begin using your Satellite P200/Satellite Pro P200 Series computer. It also provides detailed information on configuring your computer, basic operations and care, using optional devices and troubleshooting.

If you are a new user of computers or if you're new to portable computing, first read over the *Satellite P200/Satellite Pro P200 Series Features* and *The Grand Tour* chapters to familiarize yourself with the computer's features, components and accessory devices. Then read *Getting Started* for step-by-step instructions on setting up your computer.

If you are an experienced computer user, please continue reading the preface to learn how this manual is organized, then become acquainted with this manual by browsing through its pages. Be sure to look over the *Special features* section of the *Satellite P200/Satellite Pro P200 Series Features*, to learn about features that are unique to the computer.

Manual contents

This manual has ten chapters, three appendixes and a glossary.

Chapter 1, *Satellite P200/Satellite Pro P200 Series Features*, is an overview of the computer's special features, utilities, and options.

Chapter 2, *The Grand Tour*, identifies the components of the computer and briefly explains how they function.

Chapter 3, *Getting Started*, provides a quick overview of how to begin operating your computer and gives tips on safety and designing your work area. Be sure to read the sections on setting up the operating system and on restoring the pre-installed software.

Chapter 4, *Operating Basics*, includes instructions on using the following devices: TouchPad/Dual Mode Pad, the optical disc drives, the internal modem, LAN and wireless LAN. It also provides tips on care of the computer, disks and DVD/CD-ROMs.

Chapter 5, *The Keyboard*, describes special keyboard functions including the keypad overlay and hotkeys.

Chapter 6, *Power and Power-Up Modes*, gives details on the computer's power resources.

Chapter 7, *HW Setup*, introduces you to the TOSHIBA Hardware Setup program.

Chapter 8, *Optional Devices*, describes the optional hardware available.

Chapter 9, *Troubleshooting*, provides helpful information on how to perform some diagnostic tests, and suggests courses of action if the computer doesn't seem to be working properly.

Chapter 10, *Disclaimers*, provides disclaimer information related to your computer.

The Appendixes provide technical information about your computer.

The Glossary defines general computer terminology and includes a list of acronyms used in the text.

Conventions

This manual uses the following formats to describe, identify, and highlight terms and operating procedures.

Abbreviations

On first appearance, and whenever necessary for clarity, abbreviations are enclosed in parentheses following their definition. For example: Read Only Memory (ROM). Acronyms are also defined in the Glossary.

Icons

Icons identify ports, dials, and other parts of your computer. The indicator panel also uses icons to identify the components it is providing information on.

Keys

The keyboard keys are used in the text to describe many computer operations. A distinctive typeface identifies the key top symbols as they appear on the keyboard. For example, **Enter** identifies the Enter key.

Key operation

Some operations require you to simultaneously use two or more keys. We identify such operations by the key top symbols separated by a plus sign (+). For example, **Ctrl + C** means you must hold down **Ctrl** and at the same time press **C**. If three keys are used, hold down the first two and at the same time press the third.

DISKCOPY A: B: When procedures require an action such as clicking an icon or entering text, the icon's name or the text you are to type in is represented in the type face you see to the left.

Display



Names of windows or icons or text generated by the computer that appears on its display screen is presented in the type face you see to the left.

Messages

Messages are used in this manual to bring important information to your attention. Each type of message is identified as shown below.



Pay attention! A caution informs you that improper use of equipment or failure to follow instructions may cause data loss or damage your equipment.



Please read. A note is a hint or advice that helps you make best use of your equipment.

Terminology

This term is defined in this document as follows:

Start	The word “Start” refers to the  button in Microsoft® Windows Vista™.
--------------	---

Equipment checklist

Carefully unpack your computer. Save the box and packing materials for future use. Check to make sure you have all the following items:

Hardware

- Satellite P200/Satellite Pro P200 Series Portable Personal Computer
- Universal AC Adapter and Power Cord
- USB Floppy Disk Drive (provided with some models)
- Modular cable for modem (provided with some models)

Software

Microsoft® Windows Vista™ Home Basic/Home Premium/Business Edition

- The following software which is pre-installed on your hard disk:
 - Microsoft® Windows Vista™ Home Basic/Home Premium/Business Edition
 - DVD Video Player
 - TOSHIBA Disc Creator
 - TOSHIBA ConfigFree
 - TOSHIBA Assist
 - TOSHIBA SD Memory Card Format*
 - TOSHIBA HW Setup
 - TOSHIBA Value Added Package Utility
 - TOSHIBA Supervisor Password Utility
 - Ulead DVD MovieFactory®
 - FingerPrint Utility*
 - Online Manual
- Product Recovery disc (provided with some models)

* The availability of this software is dependent on the model you purchased.



The system may not function properly if you use drivers that are not pre-installed or distributed by TOSHIBA.



*SD Memory Card Format Utility and other SD functions are packaged into TOSHIBA SD Memory Utilities. When uninstalling the SD utilities, click **Start** → **Control Panel** → **Uninstall a program**, and select **TOSHIBA SD Memory Utilities**.*

Documentation

- Your computer's documentation:
 - *Satellite P200/Satellite Pro P200 Series Personal Computer User's Manual*
 - Microsoft® Windows Vista™ manual package (provided with some models)
 - International Limited Warranty (ILW) Instruction (This instruction is included only with computers sold in ILW supported areas.)



If any of the items are missing or damaged, contact your dealer immediately.

Chapter 1

Satellite P200/Satellite Pro P200 Series Features

This chapter identifies the computer's special features, options and accessories.



Basic features are described in a separate pamphlet.



Some of the features described in this manual may not function properly if you use an operating system that was not pre-installed by TOSHIBA.

Features

Please visit your region's web site for the configuration details of the model that you have purchased.

Processor

Depending on the model you purchased:

Intel® Core™ 2 Duo Processor

Intel® Core™ Duo Processor

Intel® Pentium® Dual Core Processor

Intel® Celeron® M Processor

Disclaimer (CPU)

For more information on the Disclaimer regarding CPU, please refer to the *Disclaimers* section in Chapter 10.

Chipset

Mobile Intel® 945GM/PM, 943GML Express Chipset
 T1 CardReader & 1394a Controller PCI8402
 Realtek High Definition Audio Codec ALC861D
 Realtek 10M/100M/1Gbps LAN Controller
 RTL8111B, 10M/100M LAN Controller RTL8101E

Memory



The graphics system in your computer may use part of the main system memory for graphics performance and therefore reduce the amount of system memory available for other computing activities. The amount of system memory allocated to support graphics may vary depending on the graphics system, applications utilized, system memory size and other factors.

Slot	Two DDRII SO-DIMM, up to 4GB with Intel® 945PM/GM Express Chipset; up to 2GB with Intel 943GML Express Chipset can be upgraded through the memory expansion slot. You need to remove existing SO-DIMM if SO-DIMM is Maximum upgradable system memory size is depending on the system you purchased.
L2 Cache	Depending on the model you purchased. Intel® Core™ 2 Duo Processor with 4MB or 2MB L2 Cache Intel® Core™ Duo Processor with 2MB L2 Cache Intel® Pentium® Dual Core Processor with 2MB L2 Cache Intel® Merom Celeron® M processor with 1MB L2 Cache.
Video RAM	Depending on the model you purchased: Mobile Intel® 945GM/943GML Express Chipset, up to 128MB shared with main memory. Nvidia GeForce7600 up to 64MB shared with main memory (for 256MB main memory), up to 128MB shared with main memory (for 512MB, 756MB main memory), up to 256MB shared with main memory (for more than 1GB main memory).

BIOS

1MB Flash ROM for system BIOS
Suspend to memory or hard disk drive
Various Hotkey functions for system control
Complete ACPI 1.0b functionality

Power

Battery Pack

6-cell Lithium Ion smart battery pack with
10.8V*4000mAh

9-cell Lithium Ion smart battery pack with
10.8V*6000mAh

Approximately 12 hours or longer charging time to 100% battery capacity with system switched on.

Approximately 4 hours charge time to 100% battery capacity with system switched off.

Approximately 1.5 days discharging time in Sleep Mode for the 9-cell battery, 1 day for the 6-cell battery.

Discharge time in shutdown mode is approximately 1 month

* The availability of this battery is dependent on the model you purchased.

Disclaimer (Battery Life)

For more information on the Disclaimer regarding Battery Life, please refer to the *Disclaimers* section in Chapter 10.

RTC Battery

The computer has an internal battery to back up its Real Time Clock (RTC), calendar and setup information. This battery will last for an average of one month with no external power source.

AC adapter

The universal AC adapter provides power to the system and recharges the batteries when they are low. It comes with a detachable power cord.

Floppy Disk Drive devices

External USB Floppy Disk Drive (depends on the model purchased)

TouchPad/Dual Mode Pad

A TouchPad/Dual Mode Pad and control buttons in the palm rest enable control of the on-screen pointer.

The Dual Mode Pad is a TouchPad that provides normal touchpad features in its default mode and switches to a DualMode interface when the upper right corner of the TouchPad is tapped. Tapping the same corner again will revert to normal pointing mode.



The volume control on the right side of the TouchPad and print button may not function with some applications.

Display

17" TFT screen with a resolution of 1440 horizontal x 900 vertical pixels WXGA+.

Disclaimer (LCD)

For more information on the Disclaimer regarding LCD, please refer to the *Disclaimers* section in Chapter 10.

Graphics controller Nvidia GeForce7600 (Graphics controller chipset depends on the model purchased)
The graphics controller maximizes display performance. Refer to *Display Modes* section in Appendix B for more information.

Disclaimer (Graphics Processor Unit ("GPU"))

For more information on the Disclaimer regarding Graphic Processor Unit ("GPU"), please refer to the *Disclaimers* section in Chapter 10.

Disks

Fixed hard disk 9.5mm 2.5" hard disk drive
(60/80/100/120/160/200 GB)
12.5mm 2.5" hard disk drive
(160/200/250/300 GB)
Serial ATA 1.5 Gb/s

Disclaimer (HDD Drive Capacity)

For more information on the Disclaimer regarding HDD Drive Capacity, please refer to the *Disclaimers* section in Chapter 10.

CD-RW/DVD-ROM drive

Some models are equipped with a full-size CD-RW/DVD-ROM module that lets you record data to rewritable CD/CD-RWs as well as run either 12cm (4.72") or 8cm (3.15") CD/DVDs without using an adapter. It reads DVD-ROMs at maximum 8x speed and CD-ROMs at maximum 24x speed. It writes CD-Rs at up to 24x speed, CD-RWs at up to 24x speed. This drive supports the following formats:

- DVD-ROM
- DVD-Video
- CD-R
- CD-RW
- CD-DA
- CD-Text
- Photo CD (single/multi-session)
- CD-ROM Mode1, Mode2
- CD-ROMXA Mode2 (Form1, Form2)
- Enhanced CD(CD-EXTRA)

DVD Super Multi drive supporting \pm R Double Layer

Some models are equipped with a full-size DVD Super Multi drive supporting \pm R Double Layer module with dual layer support that lets you record data to rewritable CD/DVDs as well as run either 12cm (4.72") or 8cm (3.15") CD/DVDs without using an adapter. It reads DVD-ROMs at maximum 8x speed and CD-ROMs at maximum 24x speed. It writes CD-Rs at up to 24x speed, CD-RWs at up to 16x speed, DVD-Rs at maximum 8x speed, DVD-RWs at maximum 6x speed, DVD+RWs at maximum 8x speed, DVD+Rs at maximum 8x speed, DVD+R (double layer) at maximum 4x speed, DVD-R (dual layer) at maximum 4x speed and DVD-RAM at maximum 5x speed. This drive supports the same formats as the CD-RW/DVD-ROM drive plus the following:

- DVD-ROM
- DVD-Video
- DVD-R
- DVD-RW
- DVD+R
- DVD+RW
- DVD-RAM
- DVD+R (double layer)
- CD-R
- CD-RW
- CD-DA
- CD-Text
- DVD-R (dual layer)
- Photo CD (single/multi-session)
- CD-ROM Mode1, Mode2
- CD-ROMXA Mode2 (Form1, Form2)
- Enhanced CD (CD-EXTRA)



Computers in this series can be configured with multiple types of optical disc drive. For more information on the optical disc drives available, talk to your dealer. More information on using the optical disc drive can be found in Chapter 4, *Operating Basics*.

Slots (depending on configuration)

Multiple Digital Media Card (SD/SDHC/MMC/MS/MS Pro/xD)	This slot lets you easily transfer data from devices, such as digital cameras and Personal Digital Assistants, that use flash-memory. You can use a memory module in this slot.
Express Card	The Express Card expansion slot that can accommodate two standard module formats; an Express Card/34 module and an Express Card/54 module. An Express Card module is a small add-in card technology based on the PCI Express and Universal Serial Bus (USB) interfaces.

Ports (depending on configuration)

External monitor	15-pin analog VGA port supports VESA DDC2B compatible functions.
Universal Serial Bus	The computer has Four Universal Serial Bus (USB) ports that comply with the USB 2.0 standard, which enables data transfer speeds more than 40 times faster than USB 1.1 (which this computer also supports).
i.LINK (IEEE1394a)	This port enables high-speed data transfer directly from external devices such as digital video cameras.
TV Out	The 4-pin S-Video port is compatible with PAL or NTSC TV standard, supporting Macrovision 7.02 copy protection.

Multimedia

Sound system	The integrated Windows® compatible sound system provides support for internal speakers as well as jacks for an external microphone and headphones.
Headphone jack	A standard 3.5mm stereo jack is provided for the connection of external headphones or speakers.

Microphone jack	A standard 3.5 mm mini microphone jack enables connection of monaural microphone input.
Web Camera	Record/Send still or video images with this integrated Web Camera.

Communications (depending on configuration)

Modem	An internal modem provides capability for data and fax communication. It supports the V.90 or V.92 standards depending on the region and provides a modem jack for connection to a telephone line. The speed of data and fax transfer depends on the analog telephone line conditions.
LAN	The computer has built-in support for Ethernet LAN (10 Mbps, 10BASE-T), Fast Ethernet LAN (100 Mbps 100BASE-TX), or Gigabit Ethernet LAN (1000 Mbps, 1000BASE-T).
Wireless LAN	The computer has a built-in wireless LAN mini-PCIE card that is compatible with other LAN systems that support the following: 802.11a/b/g/n wireless LAN module/ 802.11a/b/g wireless LAN module/ 802.11b/g wireless LAN module. It has a Frequency Channel Selection (2.4 or 5 GHz) and allows roaming over multiple channels.
Bluetooth	Bluetooth is a short-range wireless technology used to create PANs (Personal Area Networks) among your devices, and with other nearby devices like mobile computers, mobile phones, and digital cameras.

Security

Power-on password protection
Two level password architecture
Fingerprint authentication

Security Lock Slot

Receives an optional security lock in order to anchor the computer to a desk or other large, heavy object.

Special features

The following features are either unique to TOSHIBA computers or are advanced features, which make the computer more convenient to use.

Hotkeys	Key combinations that let you quickly modify the system configuration directly from the keyboard without running a system configuration program.
Display Automatic Power off	This feature automatically cuts off power to the internal display when there is no input from the keyboard or pointing device for a specified time period. Power is restored when any key is pressed or when there is input from a pointing device. You can specify the time period in the TOSHIBA Power Saver utility.
Hard Disk Drive Automatic Power Off	This feature automatically cuts off power to the hard disk drive when it is not accessed for a specified time period. Power is restored when the hard disk is accessed. You can specify the time period in the TOSHIBA Power Saver utility.
System Automatic Sleep/Hibernation	This feature automatically places the system into either Sleep Mode or Hibernation Mode when there is no input or hardware access for a specified time period. You can specify the time period and select either System Sleep or System Hibernate in the TOSHIBA Power Saver utility.
Keypad Overlay	A ten-key pad is integrated into the keyboard. Refer to the <i>Keypad overlay</i> section in Chapter 5, <i>The Keyboard</i> , for instructions on using the keypad overlay.
Power-on Password	Two levels of password security are available, Supervisor and User, which can prevent unauthorized access to your computer.
Battery Save Mode	This feature lets you save battery power. You can specify the level of system power management in the TOSHIBA Power Saver utility.
Instant Security	A Hotkey function which blanks the screen and activates password security to provide quick and easy data security.
Panel Power Off/On	This feature turns power to the computer off when the display panel is closed and turns it back on when the panel is opened. You can specify the setting in the TOSHIBA Power Saver utility.

Low Battery Automatic Hibernation	When battery power is exhausted to the point that computer operation cannot be continued, the system automatically enters Hibernation Mode and shuts itself down. You can specify the setting in the TOSHIBA Power Saver utility.
Hibernation	This feature lets you turn off the power without exiting from your software. The contents of main memory are saved to the hard disk. When you turn on the power again, you can continue working right where you left off. Refer to the <i>Turning off the power</i> section in Chapter 3, <i>Getting Started</i> , for details.
Sleep	In Sleep Mode, power to the system remains on, but the processor and all other devices are effectively in 'sleep mode'. When the computer is in Sleep Mode, the Power LED flashes amber. The computer enters Sleep Mode regardless of the Hibernate Mode setting. Refer to the <i>Turning off the power</i> section in Chapter 3, <i>Getting Started</i> , for details..
Fingerprint	Adds an additional layer of security to your files by requiring a valid fingerprint to access them.



- *Before entering Sleep mode, be sure to save your data.*
- *Do not install or remove a memory module while the computer is in Sleep mode. The computer or the module could be damaged.*
- *Do not remove the battery pack while the computer is in Sleep mode. Data in memory will be lost.*

TOSHIBA Value Added Package

This section describes the TOSHIBA Component features pre-installed on the computer.

TOSHIBA Power Saver	TOSHIBA Power Saver provides you with the features of more various power supply managements.
TOSHIBA Button Support	This utility controls the button operation of the computer. The starting application from the button can be changed.
TOSHIBA PC Diagnostic Tool	The TOSHIBA PC Diagnostic Tool will display basic system configuration information and allow the functionality of some of the computer's builtin hardware devices to be tested.

TOSHIBA Flash Cards	This utility supports the following functions, <ul style="list-style-type: none"> ■ Hot key function ■ TOSHIBA utility launcher function
TOSHIBA Components Common Driver	TOSHIBA Components Common Driver contains the module required for the utility which TOSHIBA offers.
TOSHIBA Accessibility	The TOSHIBA Accessibility utility provides support to movement impaired users when they need to use the TOSHIBA Hot-key functions. In use, the utility allows you to make the Fn key 'sticky', that is you can press it once, release it, and they press one of the ' F ' keys in order to access its specific function. When set, the Fn key will remain active until another key is pressed.
TOSHIBA Zooming Utility	This utility allows you to enlarge or reduce the icon size on Windows Desktop or the zoom factor associated with specific supported applications.

Utilities and Applications

This section describes preinstalled utilities and tells how to start them. For details on operations, refer to each utility's online manual, help files or readme.txt files.

TOSHIBA Assist	TOSHIBA Assist is a graphical user interface that provides easy access to help and services.
DVD Video Player	The DVD player is used to play DVD Video media through an on-screen interface and functions.
TOSHIBA ConfigFree	<p>ConfigFree is a suite of utilities to allow easy control of communication devices and network connections. ConfigFree also allows you to find communication problems and create profiles for easy switching between location and communication networks.</p> <p>To start ConfigFree, click the Start Button, point to All Programs, point to TOSHIBA, point to Networking and click ConfigFree.</p>

TOSHIBA Disc Creator	You can create discs in several formats including audio CDs that can be played on a standard stereo CD player and data discs to store the files and folders on your hard disk drive. This software can be used on a model with a CD-RW/DVD-ROM drive or a DVD Super Multi drive.
TOSHIBA DVD-RAM Utility	TOSHIBA DVD-RAM Utility has the function of Physical Format and Write-Protect to DVD-RAM. This utility is contained the setup module of TOSHIBA Disc Creator. You can boot TOSHIBA DVD-RAM Utility from the menu bar as follows. Start -> All Programs -> TOSHIBA -> CD&DVD Applications -> DVD-RAM Utility.
TOSHIBA Hardware Setup	This program lets you customize your hardware settings according to the way you work with your computer and the peripherals you use. To access this utility, click the Start Button, point to All Programs, point to TOSHIBA, point to Utilities, point to HWsetup.
CD/DVD Drive Acoustic Silencer	This utility allows you to configure the read speed of CD drive. You can either configure Normal Mode, which operates the drive at its maximum speed for quick data access, or Quiet Mode, which runs at single speed for CD audio and which can lessen operational noise. It is ineffective in DVD.
Ulead DVD MovieFactory® for TOSHIBA	You can edit digital video and make a DVD-Video and support Label Flash function.



The availability of Label Flash function depends on the model you purchased.

FingerPrint utility

This product has a fingerprint utility installed for the purpose of enrolling and recognizing fingerprints. (depending on the model purchased.) By enrolling the ID and password to the fingerprint authentication device, it is no longer necessary to input the password from the keyboard. Just by swiping the finger against the fingerprint sensor, the following functions will be enabled:

- Logon to Windows and access a security-enabled homepage through IE (Internet Explorer).
- Files and folders can be encrypted/decrypted and third party access to them prevented.
- Disable the password-protected screen-saver when returning from power-saving (Sleep) mode.
- System boot authentication and Single Touch Boot feature.
- Power on Security and Single Sign On feature.



Fingerprint cannot be used in models that do not have a fingerprint module installed.

Windows Mobility Center

Mobility Center is a utility for accessing several mobile PC settings quickly in one window. A default maximum of eight tiles are provided by the operating system, and the additional two titles are added to your Mobility Center

- Lock Computer:
This can be used to lock your computer without turning it off. This has the same function as the **Lock** button at the bottom of the right pane in the start menu.
 - TOSHIBA Assist:
This can be used to open **TOSHIBA Assist** if it is already installed in your computer.
-

Options

You can add a number of options to make your computer even more powerful and convenient to use. The following options are available:

Memory Modules	Two memory module can be installed in this computer.
-----------------------	--



Use only PC4200 and PC5300 compatible DDRII memory modules. See your TOSHIBA dealer for details.*

** The availability of DDRII is dependent on the model you purchased.*

Battery Pack	An additional battery pack can be purchased from your TOSHIBA dealer. Use it as a spare to increase your computer operating time.
---------------------	---

High capacity battery pack	An additional battery pack can be purchased from your TOSHIBA dealer. Use it as a spare to increase your computer operating time.
-----------------------------------	---

AC adapter	If you use your computer at more than one site frequently, it may be convenient to purchase an additional AC adapter for each site so you will not have to carry the adapter with you.
-------------------	--

USB Floppy Disk Drive	Lets you attach a floppy disk drive to your computer by means of a USB cable.
------------------------------	---

The Grand Tour

This chapter identifies the various components of your computer. Become familiar with each component before you operate the computer.



Certain types of notebook chassis are designed to accommodate all possible configurations for an entire product series. Your selected model may not have all the features and specifications corresponding to all of the icons or switches shown on the notebook chassis, unless you have selected all those features.

Front with the display closed



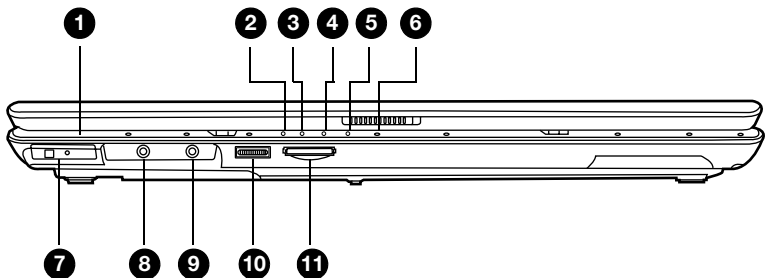





The following figure shows the computer front with its display panel in the closed position.



- | | |
|---|---|
| 1. FRONT EDGE LOGO* | 7. WIRELESS COMMUNICATION SWITCH AND LED* |
| 2. DC IN LED | 8. MICROPHONE JACK |
| 3. POWER LED | 9. HEADPHONE JACK |
| 4. BATTERY LED | 10. VOLUME CONTROL |
| 5. HARD DISK DRIVE LED | 11. MULTIPLE DIGITAL MEDIA CARD SLOT* |
| 6. MULTIPLE DIGITAL MEDIA CARD SLOT ACCESS LED* | |

* The availability of this feature is dependent on the model you purchased.

Front of the computer with display closed

	Front Edge Logo*	Front Edge Logo indicates the computer series you bought. (The availability of this function is dependent on the model you purchased.)
	DC IN LED	The DC IN LED indicates the computer is connected to the AC adapter and it is plugged into an AC power source.
	Power LED	In normal operating mode, the Power LED is blue (depending on the model you purchased). If the system is in Sleep Mode the LED will flash amber, while the LED will be off when the computer is turned off or is in Hibernation Mode.
	Battery LED	The Battery LED indicates the battery's current charge/discharge status. It lights blue (depending on the model you purchased) when the battery is fully charged. It lights amber while the battery is being charged from the AC adapter. It flashes amber when the battery capacity is low.
	Hard Disk Drive LED	The Hard Disk Drive LED indicates that the hard disk drive is being accessed. Every time your computer runs a program, opens a file, or performs some other function in which it must access the hard disk drive, this light will go on.
	Multiple Digital Media Card Slot Access LED*	The Multiple Digital Media Card Slot Access LED lights up when the Multiple Digital Media Card is accessed. (The availability of this function is dependent on the model you purchased.)
	Wireless Communication Switch and LED*	The wireless communication switch turns on the wireless networking transceiver. The Wireless Communication LED beside it indicates that wireless networking is turned on. Indicates whether the Wireless devices is active or not. (The availability of this function is dependent on the model you purchased.)
	Microphone Jack	The standard 3.5 mm mini microphone jack enables connection of a three conductive type mini-jack for a monaural microphone.
	Headphone Jack	The headphone jack lets you connect stereo headphones or other audio-output devices such as external speakers. Connecting headphones or other devices to this jack automatically disables the internal speakers.

**Volume Control**

Use this dial to adjust the volume of the stereo speakers or headphones.

**Multiple Digital Media Card Slot***

The Multiple Digital Media Card Slot allows you to use media cards from digital still cameras and various forms of portable information equipment. (The availability of this function depends on the model you purchased.)

Right side

The following figure shows the computer's right side.

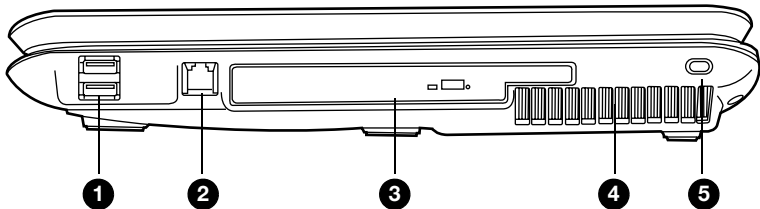

- | | |
|------------------------------------|-------------------------------|
| 1. UNIVERSAL SERIAL BUS (USB) PORT | 3. OPTICAL DISC DRIVE AND LED |
| 2. MODEM JACK | 4. FAN VENTS |
| | 5. SECURITY LOCK |

The right side of the computer

**Universal Serial Bus (USB) Port**

The Universal Serial Bus (USB 2.0 and 1.1 compatible) port enables USB-equipped devices such as keyboards, mice, hard drives, scanners, and printers to be connected to the computer.

**Modem Jack**

In regions where an internal modem is installed as standard equipment, this jack lets you use a modular cable to connect the modem directly to a telephone line.

Optical Disc Drive and LED

The computer is configured with a full-size optical disc drive module that lets you run either 12 cm (4.72") or 8 cm (3.15") discs without using an adapter. See the Drives section in this chapter for technical specifications on each drive and Chapter 4, *Operating Basics*, for information on using the drive and caring for discs. The LED lets you know when the Optical Disc Drive is being accessed.

Fan Vents

The fan vents help prevent the CPU from overheating.

To prevent possible over heating of the CPU, never block the fan vents.



Security Lock

An optional security cable attaches to this port in order to anchor your computer to a desk or other large object to deter theft.

Left side

The following figure shows the computer's left side.

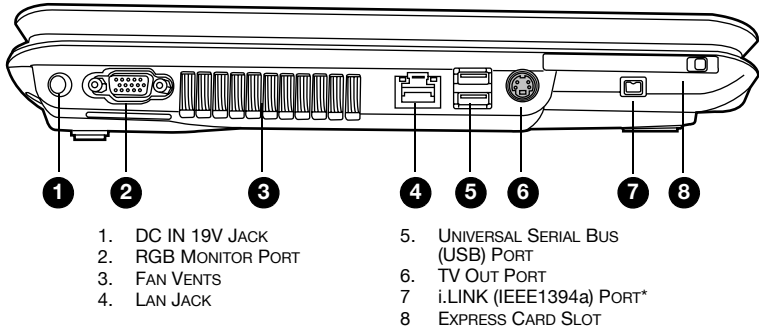

* The availability of this feature is dependent on the model you purchased.

The left side of the computer

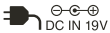

DC IN 19V Jack

The DC IN jack is where you plug in the AC adapter.



RGB Monitor Port

This 15-pin port lets you connect an external video display to the computer.

Fan Vents

The fan vents help prevent the CPU from overheating.



To prevent possible over heating of the CPU, never block the fan vents.

**LAN Jack**

This jack lets you connect to a LAN. The adapter has built-in support for Ethernet LAN (10 megabits per second, 10BASE-T), Fast Ethernet LAN (100 megabits per second, 100BASE-TX) and Gigabit Ethernet LAN (1000 megabits per second, 1000BASE-T). Two indicators built into the jack let you see the LAN status.

**Universal Serial Bus (USB) Port**

The Universal Serial Bus (USB 2.0 and 1.1 compatible) port enables USB-equipped devices such as keyboards, mice, hard drives, scanners, and printers to be connected to the computer.

**TV Out Port**

Connect a 4-pin S- video cable into this connector in order to output either an NTSC or PAL television signal.

**i.LINK (IEEE1394a) Port**

This port allows you to connect an external device, such as a digital video camera, for high-speed data transfer.

**Express Card Slot**

This slot allows you to insert an Express Card. An Express Card module is a small, modular add-in card technology based on PCI Express and Universal Serial Bus (USB) interface. The max. transmission rate at 2.5Gbps. Both 34mm type and 54mm type are supported.

Underside

The following figure shows the underside of the computer. Make sure the display is closed before turning over your computer.

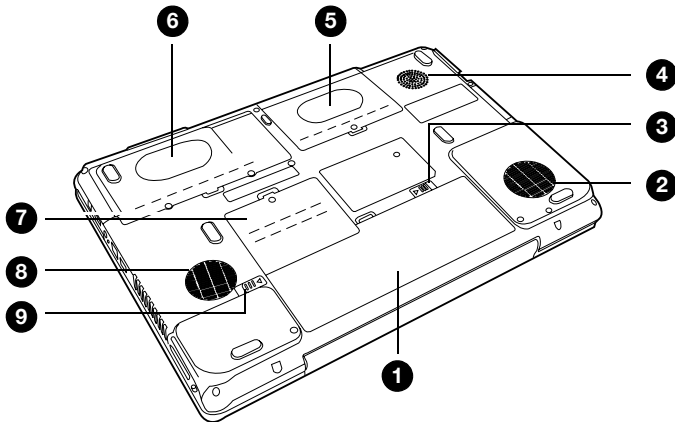

- | | |
|----------------------|----------------------------|
| 1. BATTERY PACK | 6. HDD2* |
| 2. FAN VENT | 7. EXPANSION MEMORY SOCKET |
| 3. BATTERY PACK LOCK | 8. FAN VENT |
| 4. SPEAKER | 9. BATTERY PACK LATCH |
| 5. HDD1 | |

* The availability of this feature is dependent on the model you purchased.

The bottom of the computer

Battery Pack	The battery pack powers the computer when the AC adapter is not connected. For detailed information on the battery pack, refer to Chapter 6, <i>Power and Power-Up Modes</i> .
Fan Vent	The fan vents help prevent the CPU from overheating.
①  Battery Pack Lock	When you slide this into its locked position, the battery pack cannot be released even if you attempt to slide the battery pack latch into its open position.
Speaker	A third speaker to indicate bios beeps.
HDD1	Hard Disk Drives store data, files and programs.
HDD2*	Hard Disk Drives store data, files and programs. (The availability of this function depends on the model you purchased.)



Expansion Memory Socket

Use this socket to install a memory module to increase your computer's memory. Refer to the *Memory expansion* section in Chapter 8, *Optional Devices*.



To prevent possible overheating of the CPU, never block the fan vents.



Battery Pack Latch

With the Battery Pack Lock in its unlocked position, you can slide this latch in order to remove the battery pack.

Front with the display open

The following figure shows the front of the computer with the display open. To open the display, push the latch on the front of the display and lift it up. Position the display at a comfortable viewing angle.

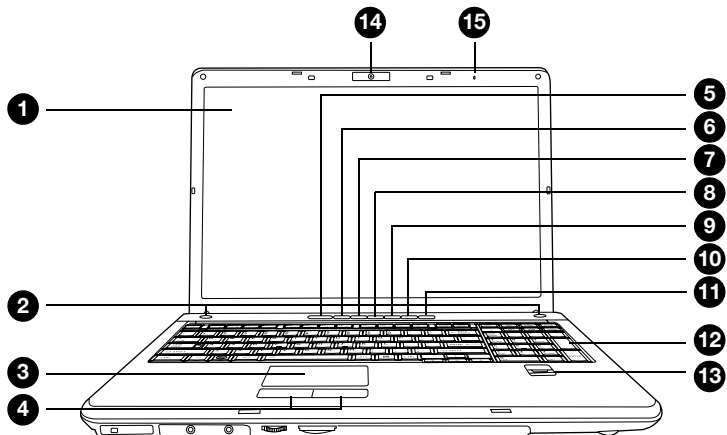

- | | |
|--------------------------------|---------------------------|
| 1. DISPLAY SCREEN | 8. PLAY/PAUSE BUTTON* |
| 2. LEFT AND RIGHT SPEAKERS | 9. STOP* |
| 3. TOUCHPAD/DUAL MODE PAD | 10. PREVIOUS BUTTON* |
| 4. TOUCHPAD CONTROL
BUTTONS | 11. NEXT BUTTON* |
| 5. POWER BUTTON | 12. NUMBER PAD |
| 6. INTERNET BUTTON* | 13. FINGER PRINT SCANNER* |
| 7. CD/DVD BUTTON* | 14. WEB CAMERA* |
| | 15. MICROPHONE* |

* The availability of this feature is dependent on the model you purchased.

The front with the display open

Display Screen The LCD displays high-contrast text and graphics at a resolution up to 1680 x 1050 pixels. Refer to *Appendix B - Display Modes* for further information. When the computer operates from the AC adapter, the display screen's image will be somewhat brighter than when it operates on battery power - this is normal and is designed to conserve battery power.



To prolong the life of your display screen, use a screen saver when you're not using the computer and it is idle.

Left and Right Speakers The computer provides two speakers for stereo sound reproduction.

TouchPad/Dual Mode Pad The TouchPad/Dual Mode Pad pointing device is located in the centre of the palm rest and is used to control the on-screen pointer. Refer to the *How the Swipe the Finger* section in Chapter 4, *Operating Basics*.

TouchPad Control Buttons Control buttons below the TouchPad/Dual Mode Pad let you select menu items or manipulate text and graphics designated by the on-screen pointer.



Power Button Press the power button to turn the computer's power on and off. There is an LED inside the power button which shines in blue (depending on the model you purchased) when the system is on.



Internet Button* Press this button to launch an Internet browser. If the computer's power is off, you can press this button to turn on the computer's power and launch the browser automatically in one step. (The availability of this function depends on the model you purchased.)



CD/DVD Button* Pressing this button will launch an application program that allows for watching CD/DVD. An application that is launched differs by a model: Windows Media Player/DVD Video Player. (The availability of this function depends on the model you purchased.)



Play/Pause Button* Press this button to begin playing an audio CD, a DVD movie or digital audio files. This button also acts as a Pause button. (The availability of this function depends on the model you purchased.)

**Stop***

Stops playing the CD, DVD or digital audio.
(The availability of this function depends on the model you purchased.)

**Previous Button***

Skips backwards to the previous track, chapter or digital file. Refer to Chapter 4, *Operating Basics*, for details.
(The availability of this function depends on the model you purchased.)

**Next Button***

Skips forward to the next track, chapter or digital file. Refer to Chapter 4, *Operating Basics*, for details.
(The availability of this function depends on the model you purchased.)



If Random or Shuffle is selected in Windows® Media Player, selecting Next or Previous advances to a random selection.

Number Pad

Press the Number Lock button to activate the number pad. Use the number pad instead of the number buttons on the keyboard to enter numbers and ASCII codes.

Finger Print Scanner*

Use the fingerprint scanner to prevent unauthorised access to the laptop. See “Using the FingerPrint (FingerPrint sensor is provided with some models)” on page 4-3.
(The availability of this function depends on the model you purchased.)

Web Camera*

Take your picture or send your image to web contacts.
(The availability of this function depends on the model you purchased.)

Microphone*

The Microphone is used with the Web Camera to talk to other Web Camera users and to record messages on windows media.
(The availability of this function depends on the model you purchased.)

Keyboard Indicators



Numeric Mode

You can use the keypad overlay (light gray labeled keys) for numeric input when the Numeric mode icon lights blue. Refer to the *Keypad overlay* section in Chapter 5, *The Keyboard*.



Caps Lock

The Caps Lock LED lights when you press the Caps Lock key. When this light is on, pressing a letter key on the keyboard produces an uppercase (capital) letter.

Optical Disc drive

The computer will either have a CD-RW/DVD-ROM drive, or a single layer or dual layer DVD Super Multi drive supporting $\pm R$ Double Layer depending on its configuration. An ATAPI interface controller is used for the operation of these optical drives. When the computer is accessing a disc, an indicator on the drive glows.

Region codes for DVD drives and media

The disc drive and its media are manufactured according to the specifications of six marketing regions. When you purchase DVD-Video, make sure it matches your drive, otherwise it will not play properly.

Code	Region
1	Canada, United States
2	Japan, Europe, South Africa, Middle East
3	Southeast Asia, East Asia
4	Australia, New Zealand, Pacific Islands, Central America, South America, Caribbean
5	Russia, Indian Subcontinent, Africa, North Korea, Mongolia
6	China

Writable discs

This section describes the types of writable discs. Check the specifications for your drive to for the type of discs it can write. Use TOSHIBA Disc Creator to write compact discs. Refer to Chapter 4, *Operating Basics*.

CDs

- CD-R discs can be written only once. The recorded data cannot be erased or changed.
- CD-RW discs can be recorded more than once. Use either 1x, 2x, or 4x multi-speed CD-RW discs or high-speed 4x to 10x discs. The write speed of ultra-speed CD-RW discs is a maximum of 24x speed.

DVDs

- DVD-R and DVD+R discs can be written only once. The recorded data cannot be erased or changed.
- DVD-RW, DVD+RW and DVD-RAM discs can be recorded more than once.

CD-RW/DVD-ROM drive

The full-size CD-RW/DVD-ROM drive module lets you record data to rewritable CDs as well as run either 12 cm (4.72") or 8 cm (3.15") discs without using an adapter.



The read speed is slower at the centre of a disc and faster at the other edge.

DVD read	<i>8 speed (maximum)</i>
CD read	<i>24 speed (maximum)</i>
CD-R write	<i>24 speed (maximum)</i>
CD-RW write	<i>24 speed (maximum, ultra-speed media)</i>

DVD Super Multi drive supporting \pm R Double Layer

The full-size DVD Super Multi drive supporting \pm R Double Layer module lets you record data to rewritable discs as well as run either 12cm (4.72") or 8cm (3.15") discs without using an adapter.



The read speed is slower at the centre of a disc and faster at the other edge.

DVD read	8 speed (maximum)
DVD-R write	8 speed (maximum)
DVD-RW write	6 speed (maximum)
DVD+R write	8 speed (maximum)
DVD+RW write	8 speed (maximum)
DVD-RAM write	5 speed (maximum)
CD read	24 speed (maximum)
CD-R write	24 speed (maximum)
CD-RW write	16 speed (maximum, ultra-speed media)
DVD+R (DL) write	4 speed (maximum)
DVD-R(DL) write	4 speed (maximum)

This drive cannot use discs that allow writing faster than 8x speed or faster (DVD-R and DVD+R with Single Layer), 6x speed or faster (DVD-RW), 8x speed or faster (DVD+RW), 5x speed (DVD-RAM) or ultra-speed or faster (CD-RW).

AC adapter

The AC adapter converts AC power to DC power and reduces the voltage supplied to the computer. It can automatically adjust to any voltage from 100 to 240 volts and to a frequency of either 50 or 60 hertz, enabling you to use the computer in almost any country/region.

To recharge the battery, simply connect the AC adapter to a power source and the computer. See Chapter 6, *Power and Power-Up Modes*, for details.

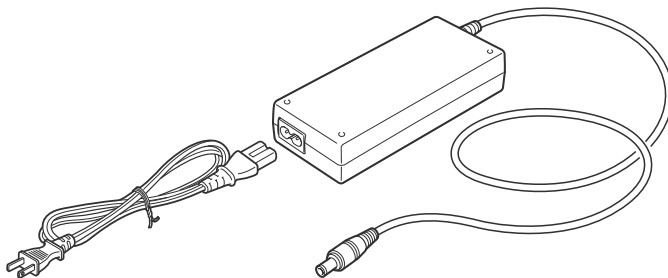

The AC adapter



Use of the wrong adapter could damage your computer. TOSHIBA assumes no liability for any damage in such case. The output rating for the computer is 19 volts DC.



Please use only the AC Adapter supplied with the computer or an AC adapter certified by TOSHIBA.

Getting Started

This chapter provides basic information to get you started using your computer. It covers the following topics:



Be sure also to read Instruction Manual for Safety & Comfort. This guide, which is included with the computer, explains product liability.

- Connecting the AC adapter
- Opening the display
- Turning on the power
- Starting up for the first time
- Turning off the power
- Restarting the computer
- Restoring the pre-installed software from the Product Recovery media.



All users should be sure to carefully read the section Starting up for the first time, which describes the actions to take when you turn on the power for the first time.

Connecting the AC adapter

Attach the AC adapter when you need to charge the battery or you want to operate from AC power. It is also the fastest way to get started, because the battery pack will need to be charged before you can operate from battery power. The AC adapter can be connected to any power source supplying from 100 to 240 volts and 50 or 60 hertz. For details on using the AC adapter to charge the battery pack, refer to Chapter 6, *Power and Power-Up Modes*.



Use of the wrong adapter could damage your computer. TOSHIBA assumes no liability for any damage in such case. The output rating for the computer is 19 volts DC.

1. Connect the power cord to the AC adapter.

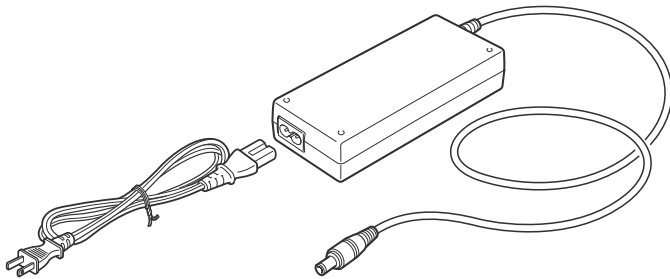

Connecting the power cord to the AC adapter

2. Connect the DC output plug on the AC adapter to the **DC IN** input port on the back of the computer.

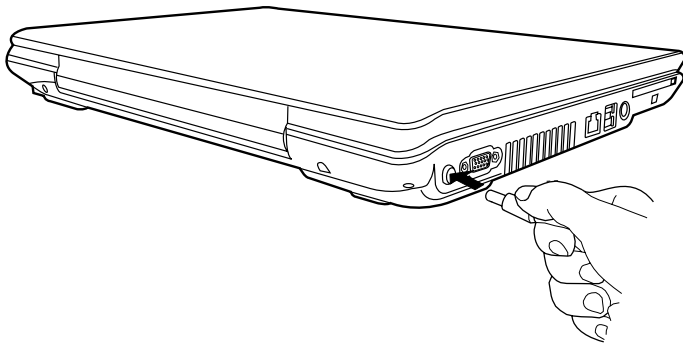

Connecting the adapter to the computer

3. Plug the power cord into a live wall outlet. The **Battery** and **DC IN** indicators on the front of the computer should glow.



To disconnect AC adaptor, you can follow the reversed procedure of Connecting AC adaptor. Please hold the DC output plug portion by your fingers and then plug it out when you disconnect the DC output plug.

Opening the display

The display panel can be rotated in a wide range of angles for optimal viewing.

1. Push the display latch on the front of the computer.

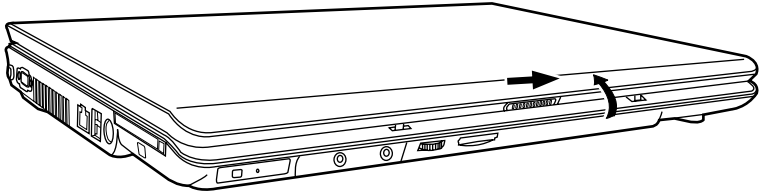

Opening the display

2. Lift the panel up and adjust it to the best viewing angle for you.



Use reasonable care when opening and closing the display panel. Opening it vigorously or slamming it shut could damage the computer.

Turning on the power

This section describes how to turn on the power.



After you turn on the power for the first time, do not turn it off until you have set up the operating system. Refer to the section Starting up for the first time in this chapter.

1. If a USB floppy disk drive is connected, make sure the drive is empty - if a disk is in the drive, press the eject button to remove it.
2. Open the display panel.
3. Press the computer's power button and then release it.

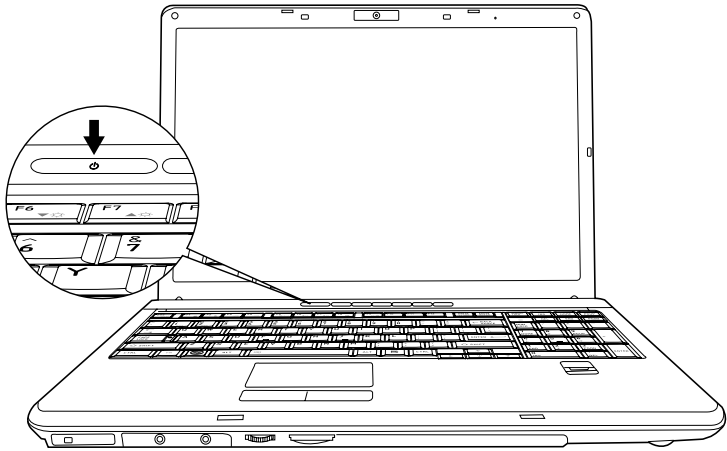

Turning on the power

Starting up for the first time

When you first turn on the power, the computer's initial screen is the Windows® Vista Startup Screen Logo. Follow the on-screen directions for each screen. During setup, you can click the **Back** button to return to the previous screen.

Be sure to read the **Windows® Operating System End User License Agreement** carefully.

Turning off the power

The power can be turned off in one of three modes, either Shutdown (Boot) Mode, Hibernation Mode or Sleep Mode.



Shut Down mode (Boot mode)

When you turn off the power in Shut Down mode no data will be saved and the computer will boot to the operating system's main screen the next time it is turned on.

1. If you have entered data, either save it to the hard disk, drive or to other storage media.
2. Make sure all disk/disks activity has stopped before removing the CD/DVD or floppy diskette.



- *Make sure the **Hard Disk Drive** indicators is off. If you turn off the power while a disk (disks) is being accessed, you can lose data or damage the disk.*
- *Never turn off the power while an application is running. Doing so could cause loss data.*
- *Never turn off the power, disconnect an external storage device or remove storage media during data read/write. Doing so can cause data loss.*

3. Click **Start** then click the arrow button () located in the power management buttons () and select Shut Down from the menu.
4. Turn off any peripheral devices connected to your computer.



Do not turn the computer or peripheral devices back on immediately - wait a short period to avoid and peripheral damage.

Sleep Mode

If you do have to interrupt your work, you are able to turn off the power without exiting from your software by placing the computer into Sleep Mode. In this mode data is maintained in the computer's main memory so that, when you turn on the power again, you can continue working right where you left off



- *When the AC adaptor is connected, the computer will go into Sleep Mode according to the settings in the Power Options.*
- *To restore the operation from the computer from Sleep Mode, press the power button or press any key. Please be aware that this latter action only works on the internal keyboard if the. Wake-up on Keyboard option is enabled within the HW Setup utility.*
- *If the computer enters Sleep Mode while a network application is active, the application might not be restored when the computer is next turned on and the system returns from Sleep Mode.*
- *To prevent the computer from automatically entering Sleep Mode, disable Sleep Mode within the Power Options. However, please be aware that this configuration will nullify the computer's Energy Star compliance.*



- *Before entering Sleep Mode, be sure to save your data.*
- *Do not install or remove a memory module while the computer is in Sleep Mode. The Computer or the module could be damaged.*
- *Do not remove the battery pack while the computer is in Sleep Mode (unless the computer is connected to an AC power source). Data in memory will be lost.*

Benefits of Sleep Mode

The Sleep Mode feature provides the following benefits:



- Restore the previous working environment more rapidly than does the Hibernation Mode feature.
- Saves power by shutting down the system when the computer receives no input or hardware access for the time period set by the System Sleep Mode feature.
- Allows the use of the panel power off feature.

Executing Sleep Mode



*You can enter also Sleep Mode by pressing **Fn + F3** - please refer to Chapter 5, The Keyboard, for further details.*

You can enter Sleep Mode in one of three ways:

1. Click **Start** then click the sleep button () located in the power management buttons (), or click the arrow button () and select Sleep from the menu.
2. Close the computer's LCD display panel. Please note that this feature must be enabled - please refer to the Power Options (to access it, click **Start** followed by **Control Panel** followed by **System and Maintenance** and then click the **Power Options**).
3. Press the power button. Please note that this feature must be enabled - please refer to the Power Options (to access it, click **Start** followed by **Control Panel** followed by **System and Maintenance** and then click the **Power Options** and point to **Choose what the power button do**).

When you turn the power back on, you can continue where you left when you shutdown the computer.



- *When the computer is in Sleep Mode, the power indicator will blink orange.*
- *If you are operating the computer on battery power, you can lengthen the overall operating time by turning it off into Hibernation Mode - Sleep Mode will consume more power while the computer is off.*

Sleep Mode limitations

Sleep Mode will not function under the following conditions:

- Power is turned back on immediately after shutting down.
- Memory circuits are exposed to static electricity or electrical noise.

Hibernation mode

The Hibernation Mode feature saves the contents of memory to the hard disk drive when the computer is turned off so that, the next time it is turned on, the previous state is restored. Please note that the Hibernation Mode feature does not save the status of any peripheral devices connected to the computer.



- *Save your data. While entering Hibernation Mode, the computer saves the contents of memory to the hard disk drive. However, for safety sake, it is best to save your data manually.*
- *Data will be lost if you remove the battery or disconnect the AC adaptor before the save is completed. Wait for the **Hard Disk Drive** indicator to go out.*
- *Do not install or remove a memory module while the computer is in Hibernation Mode. Data will be lost.*

Benefits of Hibernation Mode



The Hibernation Mode feature provides the following benefits:

- Saves Data to the hard disk drive when the computer automatically shutsdown because of a low battery condition.
- You can return to your previous working environment immediately when you turn on the computer.
- Saves power by shutting down the system when the computer receives no input or hardware access for the time period set by the System Hibernate feature.
- Allows the use of the panel power off feature.

Starting Hibernation Mode

You can also enable Hibernation Mode by pressing Fn + F4 - please refer to Chapter 5, The Keyboard, for further details.

To enter Hibernation Mode, follow the steps below.

1. Click **Start**.
2. Click the arrow button () in the power management buttons ().
3. Select Hibernate from the menu.

Automatic Hibernation Mode

The computer can be configured to enter Hibernate Mode automatically when you press the power button or close the lid. In order to define these settings, you can follow the steps as described below:

1. Click **Start** and click the **Control Panel**.
2. Click **System and Maintenance** and click **Power Options**.
3. Click **Choose what the Power Button do** or **Choose what closing the lid does**.
4. Enable the desired Hibernation Mode settings for **When I press the power button** or **When I close the lid**.
5. Click the **Save Changes** button.

Data save in Hibernation Mode

When you turn off the power in Hibernation Mode, the computer takes a moment to save the current data in memory to the hard disk drive. During this time, the **Hard Disk Drive** indicator will glow.

After you turn off the computer, and the content of memory has been saved to the hard disk drive, turn off the power to any peripheral devices.





Do not turn the computer or devices back on immediately. Wait a moment to let all capacitors fully discharge.

Restarting the computer

Certain conditions require that you reset the computer, for example if:

- You change certain computer settings.
- An errors and the computer does not respond you your keyboard commands.

If you need to restart the computer, there are three ways this can be achieved:

1. Click Start then click the arrow button () in the power management buttons () and select Restart from the menu.
2. Press Ctrl+Alt+Del to display the menu window, then select Restart from the Shutdown options.
3. Press the power button and hold it down for five seconds. Once the computer has turned itself off, wait between ten and fifteen seconds before turning the power on again by pressing the power button.

System Recovery Options

About 1.5GB hidden partition is allocated on the hard disk drive for the System Recovery Options. This partition stores files which can be used to repair the system in the event of a problem.



The System Recovery Options feature will be unusable if this partition is deleted.

System Recovery Options

The System Recovery Options feature is installed on the hard disk when shipped from the factory. In the event that an error occurs between the time power is turned ON and login, and the error is repairable, the Windows Recovery Environment will automatically repair the error.

The Windows Recovery Environment can also be run manually to repair errors.

The procedure is as follows. Follow the instructions shown on the on-screen menu.

1. Turn off the computer.
2. While holding the **F8** key, turn the computer again.
3. The **Advanced Boot Options** menu will be displayed.
Use the arrow keys to select **Repair Your Computer** and press **Enter**.
4. Follow the on-screen instructions.



The Windows Vista™ Complete PC Backup feature can be used on Windows Vista™ Business Edition and Ultimate Edition.

Restoring the preinstalled software from the Product Recovery disc

If preinstalled files are damaged, use the Product Recovery disc to restore them. To restore the operating system and all preinstalled software, follow the steps below.



When you reinstall the Windows operating system, the hard disk will be reformatted and all data will be lost. You can not use System Recovery Options if restoring the pre-installed software without System Recovery options.

1. Load the Product Recovery disc in the drive and turn off the computer's power.
2. Switch on the computer and, when the **In Touch with Tomorrow TOSHIBA** prompt appears, press the **F12** key to display the Boot Menu.
3. Use the up or down cursor key to select the CD-ROM/DVD drive in the display menu.
4. Follow the on-screen instructions.



When removing pre-installed drivers / utilities or when installing, you can setup the respective drivers / utilities from the following folder.

*C: \TOSAPINS****



When Installing TOSHIBA SD Memory Card Format or other SD utilities, select TOSHIBA SD Memory Utilities from C:\TOSAPINS\.

Create an Optical Recovery Discs



- *Be sure to connect the AC adaptor when you create Recovery Discs.*
- *Be sure to close all other software programs except the Recovery Disc Creator.*
- *Do not run software such as screen savers which can put a heavy load on the CPU.*
- *Operate the computer at full power.*
- *Do not use power-saving features.*
- *Do not write to the disc when the virus check software is running. Wait for it to finish, then disable virus detection programs including any software that checks files automatically in the background.*
- *Do not use utilities, including those intended to enhance hard disk drive access speed. They may cause unstable operation and damage data.*
- *Do not shut down/log off or Sleep/Hibernate while writing or rewriting the disc.*
- *Set the computer on a level surface and avoid places subjected to vibrations such as airplanes, trains, or cars.*
- *Do not use on an unstable surface such as a stand.*

A recovery image of the software on your computer is stored on the hard disk drive, and can be copied to either CD or DVD media by using the following steps:

1. Select either blank CD or DVD media.
2. The application will allow you to choose from a variety of different media onto which the recovery image can be copied including CD-R, CD-RW, DVD-R, DVD-RW, DVD+R and DVD+RW.



Please note that some of the above media may not be compatible with the optical disc drive installed into your computer. You should therefore verify the optical drive supports the blank media you have chosen before proceeding.

3. Turn on your computer and allow it to load the Windows Vista™ operating system from the hard disk drive as normal.
4. Insert the first blank media into the optical disc drive tray.
5. Double click the Recovery Disc Creator icon on the Windows Vista™ desktop, or select the application from Start Menu.
6. After Recovery Disc Creator starts, select the type of media and the title you wish to copy, and then click the Burn button.



If your optical disc drive can only write to CD's, select 'CD' as the 'Type' within the Recovery Disc Creator application otherwise, if your optical disc drive can write either CD's or DVD's, select the appropriate format based around the type of media you wish to create.

Restoring the pre-installed software from the Recovery Hard Disk Drive

A portion of the total hard disk drive space is configured as a hidden recovery partition. This partition stores files which can be used to restore pre-installed software in the event of a problem.

If you subsequently set up your hard disk drive again, do not change, delete or add partitions in a manner other than specified in the manual, otherwise you may find that space for the required software is not available.

In addition, if you use a third-party partitioning program to reconfigure the partitions on your hard disk drive, you may find that it becomes impossible to setup your computer.



When the sound mute feature has been activated by pressing the Fn + Esc key, be sure to disable this to allow sounds to be heard before starting the restore process. Please refer to Chapter 5, The Keyboard, for further details.

1. Turn off your computer.
2. While holding down 0 (zero) key on the keyboard, turn on your computer.
3. A menu will be displayed from which you should follow the on-screen instructions.

Restoring the pre-installed software from your created Recovery Discs

If the pre-installed files are damaged, you are able to either use the Recovery Discs you have created or the hard disk drive recovery process to restore the computer to the state it was in when you originally received it. To perform this restoration, follow the steps below:



When the sound mute feature has been activated by pressing the Fn + Esc key, be sure to disable this to allow sounds to be heard before starting the restore process. Please refer to Chapter 5, The Keyboard, for further details.



When you reinstall the Windows operating system, the hard disc will be reformatted and all data will be lost. You can not use System Recovery Options if restoring the pre-installed software without System Recovery options.

1. Load the Recovery Discs into the optical disc drive and turn off the computer's power.
2. While holding down **F12** key on the keyboard, turn on your computer - when the In Touch with Tomorrow TOSHIBA logo screen appears, release the **F12** key.
3. Use the left and right cursors key to select the optical disc drive icon from the menu. Please refer to the Boot Priority section in Chapter 7, HW Setup for further information.



When removing pre-installed drivers / utilities or when installing, you can setup the respective drivers / utilities from the following folder.

*C: \TOSAPINS****



When Installing TOSHIBA SD Memory Card Format or other SD utilities, select TOSHIBA SD Memory Utilities from C:\TOSAPINS\.

Operating Basics

This chapter gives information on basic operations including using the TouchPad/Dual Mode Pad, optical disc drives, the internal modem, LAN and wireless LAN. It also provides tips on caring for your computer and on heat dispersal.

Using the TouchPad/Dual Mode Pad

To use the TouchPad/Dual Mode Pad, simply move your finger tip across it in the direction you want the on-screen pointer to go.

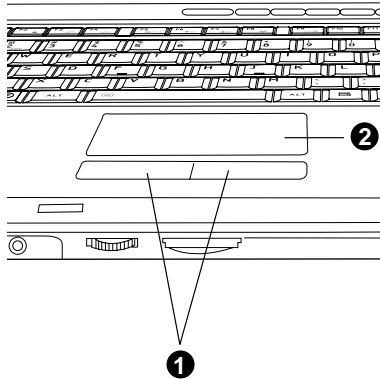

1. TOUCHPAD CONTROL BUTTONS 2. TOUCHPAD/DUAL MODE PAD

TouchPad/Dual Mode Pad and control buttons

The two buttons below the TouchPad/Dual Mode Pad are used like the buttons on a standard mouse.

Press the left button to select a menu item or to manipulate text or graphics designated by the pointer. Press the right button to display a menu or other function depending on the software you are using.



Do not press on the TouchPad/Dual Mode Pad too hard or press a sharp object such as a ball point pen against it. The TouchPad/Dual Mode Pad could be damaged.

The TouchPad/Dual Mode Pad has similar functions to a two-button mouse with a scroll wheel. For some functions, you can tap it instead of pressing a button.



You can customize pointing device actions in Mouse Properties. Open the Control Panel, select the Mouse icon and press Enter to open the Mouse Properties window.

- Click:** Click the left control button or tap the TouchPad/Dual Mode Pad once.
- Double-click:** Click the left control button twice or tap the TouchPad/Dual Mode Pad twice.
- Scroll Vertical:** Move your finger up or down the right edge of the TouchPad/Dual Mode Pad.
- Horizontal:** Move your finger left or right along the bottom edge of the TouchPad/Dual Mode Pad.

Dual Mode Pad Button function (Dual Mode Pad is provided with some models)

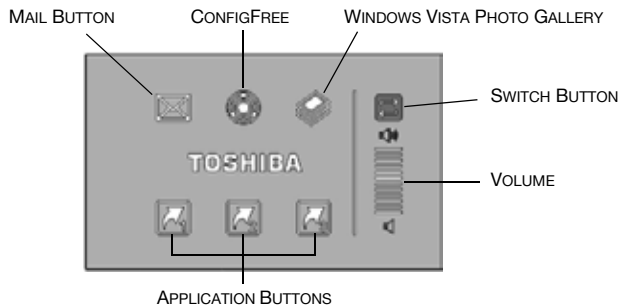

Dual Mode Pad Button



Switch button To switch between Cursor Mode and Button Mode. When you switch to Button Mode, the pad blinks blue.



Volume Increases or decreases the volume of speaker and headphone.



Mail button Starts your mail box for you to receive and send mails.



Configfree

Configfree is a suite of utilities to allow easy control of communication devices and network connections. It also allows you to find communication problems and create profiles for easy switching between locations and communication networks.



Windows Vista Photo Gallery

Windows Vista Photo Gallery gives you many tools for your digital photos and videos. You can organize, find, and view your photos and videos, as well as edit, print, and share them from within Windows Vista Photo Gallery. It also makes it easy to transfer your photos from your camera to your computer, using a simple import process.



Application buttons

Three application buttons have default setting. You can assign other functions and programs to button 1 to 3.



Please refer to "Properties for synaptics Dual Mode Pad" for details.

Using the FingerPrint (FingerPrint sensor is provided with some models)

This product has a FingerPrint utility installed for the purpose of enrolling and recognizing FingerPrints. By enrolling the ID and password to the FingerPrint authentication device, it is no longer necessary to input the password from the keyboard. Just by swiping the finger against the FingerPrint sensor, the following functions will be enabled:

- Logon to Windows and access a security-enabled homepage through IE (Internet Explorer).
- Files and folders can be encrypted/decrypted and third party access to them prevented.
- Disable the password-protected screen-saver when returning from power-saving mode such as Sleep Mode.
- Power-on Security and Single Sign-On feature.



To "swipe" refers to the action of reading a FingerPrint using the FingerPrint sensor.

How the Swipe the Finger

Using the following steps when swiping fingers for FingerPrint registration or authentication will help to minimize authentication failures:

1. Align the first joint of the finger to the center of the sensor. Lightly touch the sensor and swipe finger levelly towards you.

While lightly touching the sensor, swipe the finger towards you until the sensor surface becomes visible.

Ensure the center of the FingerPrint is on the sensor when swiping the finger.



- *Avoid swiping with the finger stiff or pressed-on too hard*
FingerPrint reading may fail if the center of the FingerPrint is not touching on the sensor, or when finger is swiped while pressing hard. Make sure that the center of the FingerPrint is touching the sensor before swiping.
- *Confirm the center of the FingerPrint whirl before swiping*
The thumb's FingerPrint has a bigger whirl, which is prone to misalignment and distortions. This will cause difficulty in registration and a drop in the authentication success rate. Always confirm the center of the FingerPrint whirl so that it is swiped along the centerline of the sensor.
- *When FingerPrint reading is not successful*
There is a possibility of authentication failures if the finger is swiped too quickly or too slowly. Follow the onscreen instructions to adjust the speed of the swipe.

The following illustrations show the correct way to slide your finger over the recognition sensor.

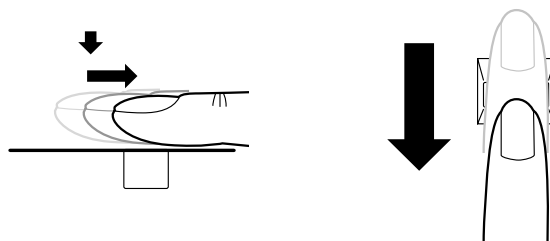

Align the finger and sensor like the drawings.

Points to note about the FingerPrint Sensor

Please be aware of the following considerations when using the FingerPrint sensor. A failure to follow these guidelines might result in damage to the sensor, sensor failure, FingerPrint recognition problems or a lower FingerPrint recognition success rate.

- Do not scratch or poke the sensor with your nails or any hard or sharp objects.
- Do not press the sensor strongly.
- Do not touch the sensor with a wet finger or any wet objects - keep sensor surface dry and free of water vapor.
- Do not touch the sensor with a soiled or dirty finger as minute foreign particles of dust and dirt may scratch it.
- Do not paste stickers or write on the sensor.
- Do not touch the sensor with a finger or any other object which may have a built-up of up static electricity on it.

Observe the following before you place your finger on the sensor whether for FingerPrint enrollment/registration or recognition.

- Wash and dry your hands thoroughly.
- Remove static electricity from your fingers by touching any metal surface. Static electricity is a common cause of sensor failures, especially when the weather is dry.
- Clean the sensor with a lint-free cloth - do not use detergent to any other chemicals to clean the sensor.
- Avoid the following finger conditions for enrollment or recognition as they may result in FingerPrint enrollment errors or a drop in the FingerPrint recognition success rate.
 - Soaked or swollen finger (e.g. after taking bath)
 - Injured finger
 - Wet finger
 - Soiled or oily finger
 - Extremely dry skin condition on finger

Observe the following to improve the FingerPrint recognition success rate.

- Enroll two or more fingers.
- Enroll additional fingers if recognition failure occurs when using already enrolled fingers.
- Check the condition of your finger - any conditions which have changed since enrollment, such as injured, rough, extremely dry, wet, soiled, dirty, oily, soaked, swollen fingers, may lower the recognition success rate. Also if the FingerPrint is worn down or the finger becomes thinner or fatter, the recognition success rate may be lowered.
- As the FingerPrint for each finger is different and unique, you should ensure that only the registered or enrolled FingerPrint or FingerPrints are used for identification.
- Check the position and speed at which you swipe your finger across the sensor - please refer to the preceding drawing.

How to Delete the FingerPrint Data

Saved FingerPrint Data is stored in special non-volatile memory inside the FingerPrint sensor. Therefore, if you give the computer to someone else, or dispose of it in any way, the following process is recommended to delete your FingerPrint information:

1. Click **Start** followed by **All Programs**, followed by **Protector Suite QL** and then click **Control Center**.
2. The **Protector Suite QL** screen is displayed.
3. Click **FingerPrint** and click **Delete**.
4. Click Settings and click FingerPrint Storage Inspector.
5. The **FingerPrint Storage Inspector** screen will be displayed. If FingerPrint data is displayed as part of the list, simply select all of this information and then **Remove**.
6. Check whether all of the FingerPrint data was deleted on the **FingerPrint Storage Inspector** screen.

In use, please be aware of the following limitations of the FingerPrint sensor:

- The FingerPrint sensor compares and analyzes the unique characteristics in a FingerPrint.
- A warning message will be displayed when recognition is abnormal or recognition is not successful within a fixed duration.
- The recognition success rate may differ from user to user.
- Toshiba does not guarantee that this FingerPrint recognition technology will be error-free.
- Toshiba does not guarantee that the FingerPrint sensor will recognize the enrolled user or accurately screen out unauthorized users at all times. Toshiba is not liable for any failure or damage that might arise out of the use of this FingerPrint recognition software or utility.

Points to note about the FingerPrint Utility software



You are able to backup saved FingerPrint data and information within the PasswordBank by using the import or Export User Data facility under the FingerPrint management software. However, please be aware that any encrypted files cannot be backup within FileSafe using this function - in these instances it is recommended that you backup these files to external media using standard file copy processes.

The user should back up the user profile information when using the functions provided in this software to encrypt files or folders. If this software or the user information is deleted without backing up the user profile information, the encrypted files will no longer be accessible. In addition, if the backup data is not used, the user will not be identified as the same user even if the same name is used again in user enrolment.

Please refer to the following procedures to back up.

If Windows Vista™'s file encryption function EFS (Encryption File System) is used to encrypt a file, the file cannot be further encrypted using the encryption function of this software. In the help file, it is stated that this software's Password Bank function can be used for the Internet and general applications. However, the Internet Password Bank function in the FingerPrint utility provided in this computer can only be used with IE (Internet Explorer).

Set up Procedure

Please use the following procedure when first using FingerPrint authentication.

FingerPrint Registration

You should initially enroll the required authentication data using the 'User Enrollment' Wizard.



- *In use, the FingerPrint authentication system will use the same username and password as defined within Windows operating system. If no Windows password has been configured, you must do this before starting the FingerPrint registration process.*
- *Up to twenty-one FingerPrint patterns can be registered on this sensor.*

1. Click **Start** followed by **All Programs** followed by **Protector Suite QL** and then click **User Enrollment**.



You are also able to start the User Enrollment Wizard by using the following method.

- *Click the Protector Suite QL icon in the Task Bar.*
- *Swipe your finger across the FingerPrint Sensor.*

2. Click **Next**.

3. At the **User's Password** screen which is then displayed, you should ensure that the same Windows username is displayed before entering the appropriate password into the **Enter your password** field. Once this has been done, click **Next**.
4. At the Hints for **FingerPrint Enrollment** screen, confirm the message displayed and ensure that there is a check mark in the **Run Interactive Tutorial** box. Once this has been done, click **Next**.
5. At the **Correct swipe Procedure** screen, confirm the message that is displayed and then click **Next**.
6. At the **Scanning Practice** screen, you are able to practice swiping your finger to ensure you use the correct method. Once you have finished practicing, click **Next**.
7. At the **User's Fingers** screen, select the finger you wish to enroll from the illustration and then click **Next**. On this screen please be aware that any previously enrolled FingerPrints would have green check marks, while the FingerPrint you are about to enroll will have a red check mark. If any of the previously enrolled FingerPrints is selected again, the latest information will be enrolled and any previous information over-written.
8. At **Advanced Security** screen, select whether you wish to enable the security function, and then click **Next**.
9. At **Finalization** screen, click **Finish** - this will complete the FingerPrint registration process.

Window Logon via FingerPrint Authentication

If required, you are also able to use FingerPrint authentication in place of the usual Windows logon process using your username and password. This method is specially useful where there are many users using the same computer as it removes the need for actual user selection when the system is started.

FingerPrint Authentication Procedure

1. Start up the computer.
2. At the **Logon Authorization** screen, choose any of the enrolled fingers and swipe the FingerPrint on the sensor - If the authentication process is successful, the user will automatically be logged into Windows.



If the FingerPrint authentication process fails you will need to log into Windows using the appropriate username and password. In addition, you should use this manual login process if Finger Print authentication fails for three consecutive tries - a warning message will be displayed when authentication is not normal or is not successful within a fixed duration.

FingerPrint Power-on Security

General

The FingerPrint authentication system can be used to replace the keyboard based password authentication system that is used when the computer is turned on.

If you do not want to use the FingerPrint authentication system for password authentication when the computer is turned on, but instead prefer to use the keyboard entry method instead, simply press the **BkSP** (backspace) key or the ESC/Rotation button when the FingerPrint Power-on Security screen is displayed. Using this process will switch the password input screen across to the keyboard based entry screen.



- *You must ensure that you use the TOSHIBA Password Utility to register a User Password before using the FingerPrint Power-on Security and its extended function to allow FingerPrint to be used to access the computer when it is turned on.*
- *If the FingerPrint authentication process fails five times, a preset time limit is exceeded, or you press the BkSP (backspace) key, [Password=] will be displayed on the screen and you will have to enter either the User Password or Supervisor Password manually in order to start the computer.*
- *When swipe your finger, please ensure you do it slowly and at a constant speed. If you find that this does not improve the authentication rate, you should try to adjust the speed at which the finger is swiped.*
- *If there are any changes in the environment or setting related to authorization, you will be required to provide authorization information such as a User Password (and, if applicable, the HDD (Hard Disk Drive) password).*

How to Enable FingerPrint Power-on Security Settings

It is necessary to first enroll your FingerPrint with the Protector Suite QL application prior to enabling and configuring the FingerPrint Power-on Security System. You should check that your FingerPrint is enrolled before configuring the settings (please refer to the Manual for FingerPrint Registration/Enrollment for further instructions.)

1. Swipe your finger across the FingerPrint Sensor.
2. MENU will appear in the lower right corner of the screen. Swipe(*) your finger on the FingerPrint sensor and then select Control Center from the items presented in this menu

(*) It is recommended that the keyboard cursor keys (movement) and enter key (selection) or the directional pad be used when selecting an item from the Menu in laptop or landscape modes.

3. At the **FingerPrint Software Management** screen, click **Settings** and then click **Power-on Security**.
4. At the **Power Security** screen, place a check mark in the Replace the power-on and hard disk drive passwords with the FingerPrint reader setting and then click **OK**.

FingerPrint Single Sign-On Feature

General

This is a feature that allows the user to complete the authentication for both the User/BIOS Password (and, if applicable, the HDD (Hard Disk Drive) Password) and logging onto Windows using only one FingerPrint authentication when booting up. It is necessary to register the User/BIOS Password and Windows Logon password before using the FingerPrint Power-on Security and this FingerPrint Single Sign On Feature. Please use TOSHIBA Password Utility to register your User/BIOS Password. If Windows Logon is not the default for your system, see Manual to register your Windows Logon password.

Only one FingerPrint authentication is required to replace the User/BIOS Password (and, if applicable, the HDD (Hard Disk Drive) Password) and Windows Logon Password.

How to Enable FingerPrint Single Sign-On Feature

It is necessary to first enroll your FingerPrint with the Protector Suite QL application prior to enabling and configuring the FingerPrint Single Sign-On Feature. You should check that your FingerPrint is enrolled before configuring the settings (please refer to the Manual for FingerPrint Registration/Enrollment for further instructions).

1. Swipe your finger across the FingerPrint Sensor.
2. MENU will appear in the lower right corner of the screen. Swipe(*) your finger on the FingerPrint Sensor and select Control Center from the items presented in this menu.

(*) It is recommended that the keyboard cursor keys (movement) and enter key (selection) or the directional pad be used when selecting an item from the Menu in laptop or landscape modes.

3. At the **FingerPrint Software Management** screen, click **Settings** and then click **Power-on Security**.
4. At the **Power Security** screen, place a check mark in the Replace the power-on and hard disk drive passwords with the FingerPrint reader setting and then click **OK**.

FingerPrint utility limitations

TOSHIBA does not guarantee that the FingerPrint utility technology will be completely secure or error-free or it will be accurately screen out unauthorized users at all times. TOSHIBA is not liable for any failure or damage that might arise out of the use of the FingerPrint software.

Using the Web Camera

This section describes the bundled Web Camera utility, which can capture still and video images. The Web Camera will auto-run when Windows starts.

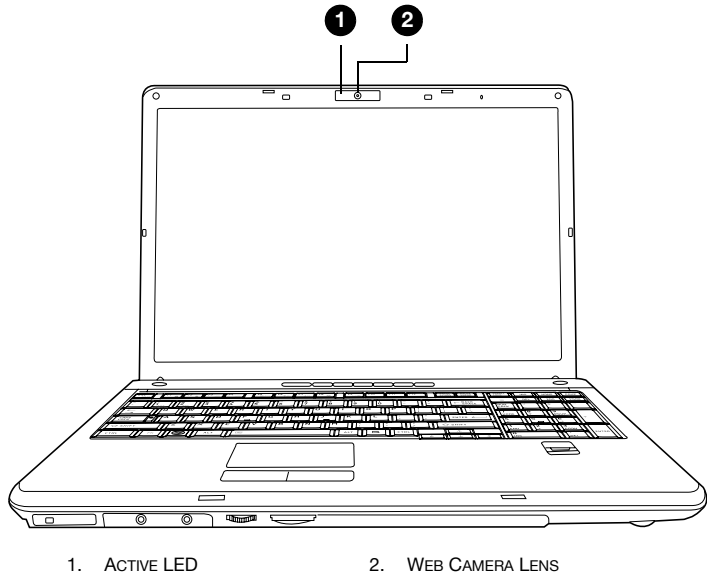

Using the software

The Web Camera software is pre-configured to start when you turn on Windows Vista; if you need to restart it go to **Start** → **Programs** → **Camera Assistant Software** → **Camera Assistant Software**.

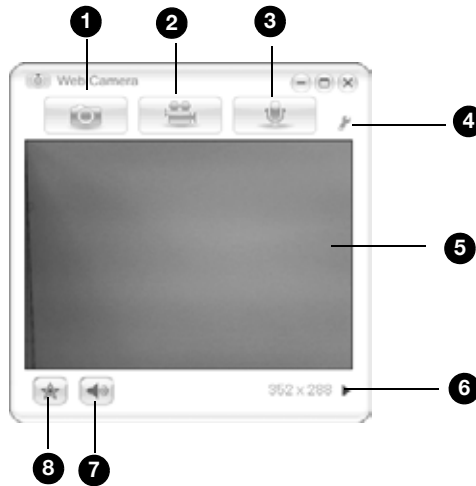

- | | |
|-------------------------|----------------------|
| 1. CAPTURE STILL IMAGES | 5. DISPLAY WINDOW |
| 2. VIDEO RECORDING | 6. CAMERA RESOLUTION |
| 3. AUDIO RECORDING | 7. MUTE |
| 4. FUNCTION | 8. EFFECTS |

Capture Still Images	Click to see a preview of the captured image; you can also e-mail the image.
Video Recording	Click to start recording, click again to stop recording and see a preview of the video.
Audio Recording	Click to start recording, click again to stop and listen to a preview of the audio.
Function	Access additional functions: About, Player, Effects, Properties, Settings and Help.
About	Displays software manufacturer details.
Player	Play video files.
Effects	Choose images to be displayed on the capture screen.
Properties	Choose from the Options tab to flip, zoom, flicker rate, night mode and backlight compensation; in the Image tab change the colour settings; in the profile tab change the lighting conditions.

Settings	Choose from the: Options tab to change the tool position; the Picture tab to select picture output options such as size, export file and saving location; the Video tab to choose output settings such as Frame Rate, Size, Compression and the file save path; the Audio tab to change the Audio Device, Compression, Volume and file save path.
Help	Displays the help files for the software.

Using the internal modem

This section describes how to setup the modem and use it to connect to other computer systems. Refer to the computer's online help files and the online help files for your modem software, for more information.



The internal modem does not support the voice functions described in the help files. All data and fax functions are supported.



- *In case of a lightning storm, unplug the modem cable from the telephone jack.*
- *Do not connect the modem to a digital telephone line. A digital line will damage the modem.*

IMPORTANT SAFETY INSTRUCTIONS



When using your telephone equipment, basic safety precautions should always be followed to reduce the risk of fire, electric shock and injury to persons, including the following:

1. *Do not use this product near water, for example, near a bathtub, wash bowl, kitchen sink or laundry tub, in a wet basement or near a swimming pool.*
2. *Avoid using a telephone (other than a cordless type) during an electrical storm. There may be a remote risk of electric shock from lightning.*
3. *Do not use the telephone to report a gas leak in the vicinity of the leak.*
4. *Use only the power cord indicated in this manual.*

Region selection

Telecommunication regulations vary from one country/region to another, so you will need to make sure the internal modem's settings are correct for the country/region in which it will be used.

1. Open the Modem Region Select application. It is located on the Programs menu at TOSHIBA → Networking → Modem Region Select.



Do not use the Country/Region Select function in the Modem setup utility in the Control Panel if the function is available. If you change the Country/Region in the Control Panel, the change may not take effect.

- The Region Selection icon appears on the Windows Task Bar.



The Region Selection icon

- Click the icon with the primary mouse button to display a list of regions that the modem supports. A sub menu for telephony location information will also be displayed. A check will appear next to the currently selected region and telephony location.
- Select a region from the region menu or a telephony location from the submenu.
 - When you click a region it becomes the modem's region selection, and the New Location for telephony will be set automatically.
 - When you select a telephony location, the corresponding region is automatically selected and it becomes the modem's current region setting.

Properties menu

Click the icon with the secondary mouse button to display the following menu.

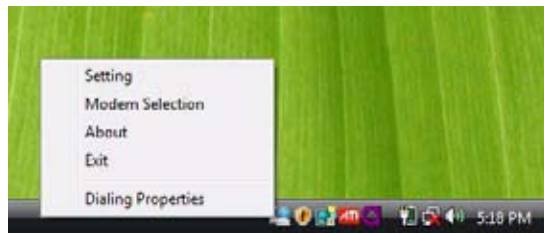

The properties menu

Settings

You can enable or disable the following settings:

AutoRun Mode

Region Select Utility starts automatically when you start up the operating system.

Open the Dialling Properties dialogue box after selecting region.

The dialling properties dialogue box will be displayed automatically after you select the region.

Location list for region selection.

A submenu appears displaying location information for telephony.

Open dialogue box, if the modem and Telephony Current Location region code do not match.

A warning dialogue box is displayed if current settings for region code and telephony location are incorrect.

Modem Selection

If the computer cannot recognize the internal modem, a dialogue box is displayed. Select the COM port for your modem to use.

Dialing Properties

Select this item to display the dialing properties.



If you are using the computer in Japan, technical regulations described in the Telecommunications Business Law require that you select Japan region mode. It is illegal to use the modem in Japan with any other selection.

Connecting

To connect the internal modem cable, follow the steps below.



- *In case of a lightning storm, unplug the modem cable from the telephone jack.*
- *Do not connect the modem to a digital telephone line. A digital line will damage the modem.*

1. Plug one end of the modular cable into the modem jack.
2. Plug the other end of the modular cable into a telephone jack

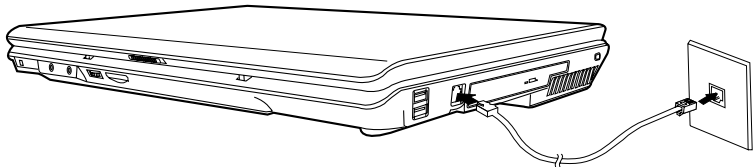

Connecting the internal modem



Do not pull on the cable or move the computer while the cable is connected.



If you find that the modem speed is low or communication is interrupted when you are using the modem, please set the CPU speed to Maximum within the TOSHIBA Power Saver utility.

Disconnecting

To disconnect the internal modem cable, follow the steps below.

1. Pinch the lever on the connector in the telephone jack and pull out the connector.
2. Disconnect the cable from the computer in the same manner.

LAN

The computer is equipped with networking hardware that supports Ethernet LAN (10 megabits per second, 10BASE-T), Fast Ethernet LAN (100 megabits per second and Gigabit Ethernet LAN (1000BASE-T).



Do not install or remove an optional memory module while the Wake-up on LAN feature is enabled.



The Wake-up on LAN feature does not work on battery power, you should always leave the computer connected to the AC adapter if you are using this feature.

Connecting the LAN cable



The computer must be configured properly before connecting to a LAN. Logging onto a LAN using the computer's default settings could cause a malfunction in LAN operation. Check with your LAN administrator regarding set-up procedures.

If you are using Ethernet LAN (10 megabits per second, 10BASE-T), you can connect using either a CAT5 or a CAT3 cable.

If you are using 100BASE-TX Fast Ethernet or 1000BASE-T Gigabit Ethernet, you must connect using a CAT5 cable.

To connect the LAN cable, follow the steps below.

1. Turn off the power to the computer and to all external devices connected to the computer.
2. Plug one end of the cable into the LAN jack. Press gently until you hear the latch click into place.

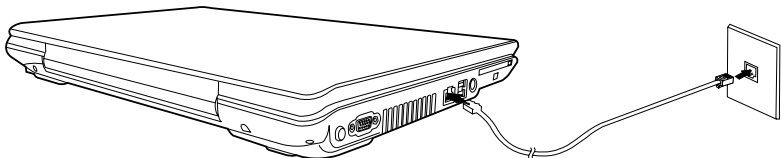

Connecting the LAN cable

3. Plug the other end of the cable into a LAN hub connector. Check with your LAN administrator before connecting to a hub.

Disconnecting the LAN cable

To disconnect the LAN cable, follow the steps below.

1. Pinch the lever on the connector in the computer's LAN jack and pull out the connector.
2. Disconnect the cable from the LAN hub in the same manner. Check with your LAN administrator before disconnecting from the hub.

Wireless LAN

The wireless LAN is compatible with other LAN systems that comply with the IEEE802.11a, 11b, 11g and Draft 11n wireless LAN standards.

It supports the following:

- Automatic Transmit Rate Select mechanism in the transmit range of 54, 48, 36, 24, 18, 9, 6 Mbps for 802.11a/b/g and 802.11b/g wireless LAN module.
- Advanced Encryption Standard (AES) data encryption, based on 256bit encryption algorithm.



Wake-up on LAN does not function on a Wireless LAN.

- Frequency Channel Selection (5GHz and 2.4 GHz)
- Roaming over multiple channels
- Card Power Management
- Wi-Fi Protected Access (WPA) data encryption



11a, 11b, 11g and 11n wireless are based on IEEE 802.11a, 802.11b, 802.11g and 802.11n respectively. The IEEE 802.11n specification has not been finalized and is currently in draft release. The TOSHIBA 11a/b/g/n Wireless LAN Adapters are based on the Draft Release, Version 1.0, of the IEEE 802.11n specification. An Adapter with 11a/b, 11a/b/g or 11a/b/g/n can communicate on any of its supported formats; the actual connection will be based on the access point to which it connects.

Connection compatibility with the wireless equipment in Draft 11n mode is not guaranteed.

The Draft 11n function cannot be used with WEP/TKIP. Draft 11n mode can be used only with WPA-PSK (AES) mode or no security mode.

Security

1. TOSHIBA strongly recommends that you enable the WPA encryption function otherwise your computer could be left open to illicit access via the wireless LAN connection which may result in an intrusion that can lead to the theft or loss of stored data among other things. In addition, the owner of an Internet connection is responsible for all browsing, downloading, and uploading activities on that connection. Therefore, an unsecured wireless network connected directly to the Internet is an open invitation for outsiders to abuse your ISP account and privileges.
2. TOSHIBA is not liable for the eavesdropping on your data due to the use of the wireless LAN connection and any damage that may occur thereof.

Bluetooth wireless technology

Bluetooth™ wireless technology eliminates the need for cables between electronic devices such as desktop computers, printers and mobile phones. Bluetooth wireless technology has the following features:

Worldwide operation

The Bluetooth radio transmitter and receiver operate in the 2.4 GHz band, which is license-free and compatible with radio systems in most countries in the world.

Radio links

You can easily establish links between two or more devices. The link is maintained even if the devices are not within line of sight.

Security

Two advanced security mechanisms ensure a high level of security:

- Authentication prevents access to critical data and makes it impossible to falsify the origin of a message.
- Encryption prevents eavesdropping and maintains link privacy.

Bluetooth™ Stack for Windows® by TOSHIBA

Please note that this software is specifically designed for the following operating systems:

- Microsoft® Windows Vista™

Detailed information regarding the use with these operating systems is listed below. Please refer also to the electronic information which is included with each software.



This Bluetooth™ Stack is based on Bluetooth™ Version 1.1/1.2/2.0+EDR specification. TOSHIBA cannot confirm compatibility between any PC products and/or other electronic devices that use Bluetooth™ other than TOSHIBA mobile PCs.

Release Notes related to the Bluetooth™ Stack for Windows® by TOSHIBA

1. Fax application software:

Regarding FAX application software, there are some software that you cannot use on this Bluetooth™ Stack.

2. Multi User:

On Windows Vista, the use of Bluetooth is not supported in a multi-user environment. This means that, when you use Bluetooth, other users logged onto the same computer will not be able to use its Bluetooth functionality.

Product Support:

The latest information regarding Operating System support, Language Support or available upgrades can be found on our web site <http://www.toshiba-europe.com/computers/tnt/bluetooth.htm> in Europe or www.pcsupport.toshiba.com in the United States.

Wireless communication switch

You can enable or disable the Wireless devices function with the on/off switch. No transmissions are sent or received when the switch is off. Slide the switch forward to turn it on and backward to turn it off.



Turn the switch off in airplanes and hospitals. Check the LED, it stops glowing when the wireless communication function is off.

Wireless communication LED

The LED indicates the status of the wireless communication functions.

LED status	Indication
LED off	Wireless communication switch is set to off.
LED glows	Wireless communication switch is on.

Using optical disc drives

The illustrations in this section might differ slightly from your drive, but operation is the same for all optical disc drives. The full-size drive provides high-performance execution of disc-based programs. You can run either 12 cm (4.72") or 8 cm (3.15") discs without an adapter. An ATAPI interface controller is used for disc drive operation. When the computer is accessing a disc, an indicator on the drive illuminates.



Use the DVD Video Player to view DVD-Video discs.

If you have a CD-RW/DVD-ROM drive, refer also to the Writing CDs on CD-RW/DVD-ROM drive section for precautions on writing to CDs.

If you have a DVD Super Multi drive supporting $\pm R$ Double Layer, refer also to the Writing CD/DVDs on DVD Super Multi drive supporting $\pm R$ Double Layer section for precautions on writing to CDs.

Loading optical disc media

To load a disc, follow the steps below.

1. Turn on the power.
2. a. Press the eject button to open the drawer slightly.

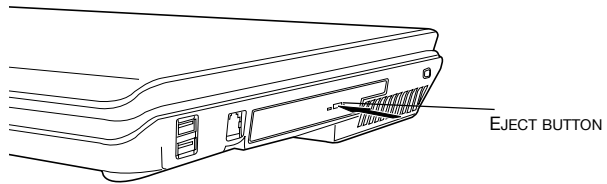

Pressing the eject button

- b. Pressing the eject button will not open the drawer when the computer's power is off. If the power is off, you can open the drawer by inserting a slender object (about 15 mm) such as a straightened paper clip into the eject hole just to the right of the eject button.

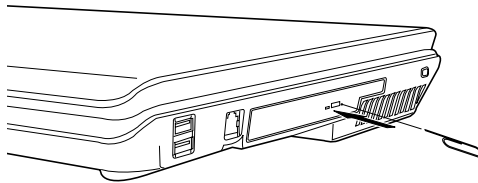

Manual release with the eject hole

3. Grasp the drawer gently and pull until it is fully open.

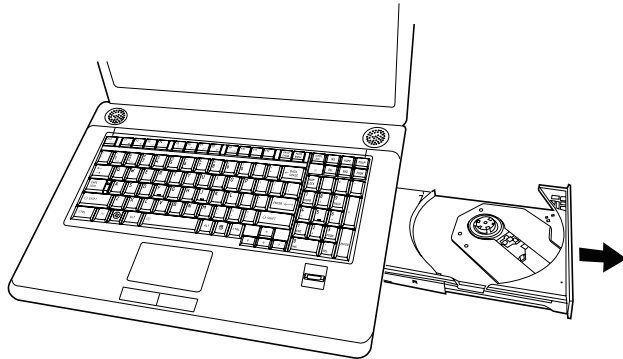

Pulling the drawer open

4. Lay the disc, label side up, in the drawer.

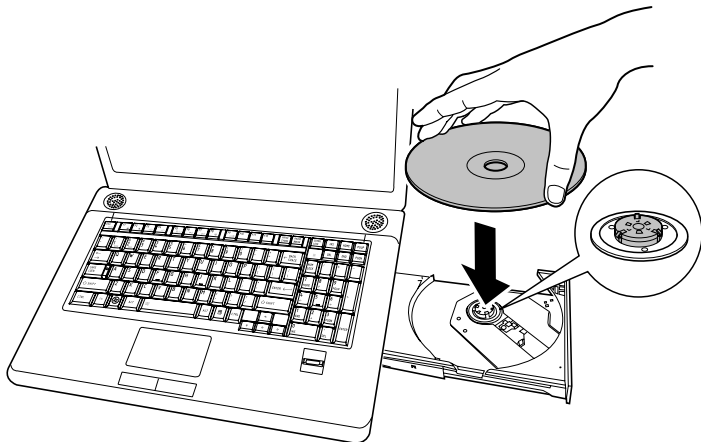

Inserting a disc



Be careful not to touch the lens or the area around it. Doing so could cause the drive to malfunction.

5. Press gently at the centre of the disc until you feel it click into place. The disc should lie below the top of the spindle, flush with its base.
6. Push the centre of the drawer to close it. Press gently until it locks in place.



If the disc is not seated properly when the drawer is closed, it might be damaged. Also, the drawer might not open fully when you press the eject button.

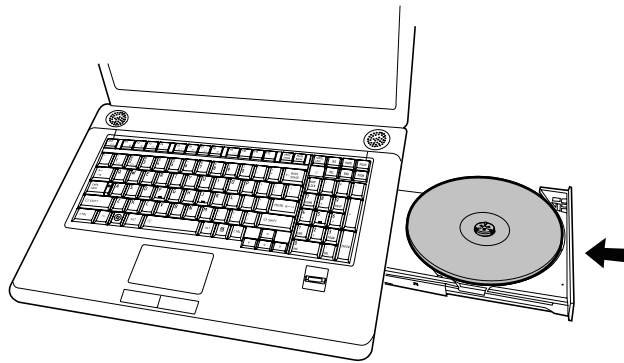

Closing the drive drawer

Removing optical disc media

To remove the disc, follow the steps below.



*Do not press the eject button while the computer is accessing the disc drive. Wait for the **optical disc** indicator to go out before you open the drawer. Also, if the disc is spinning when you open it, wait for it to stop before you remove it.*

1. To pop the drawer partially open, press the eject button. Gently pull the drawer out until it is fully opened.



- *When the drawer pops open slightly, wait a moment to make sure the disc has stopped spinning before pulling the drawer fully open.*
- *Turn off the power before you use the eject hole. If the disc is spinning when you open the drawer, it could fly off the spindle and cause injury.*

2. The disc extends slightly over the sides of the drawer so you can grasp it. Hold it gently and lift it out.

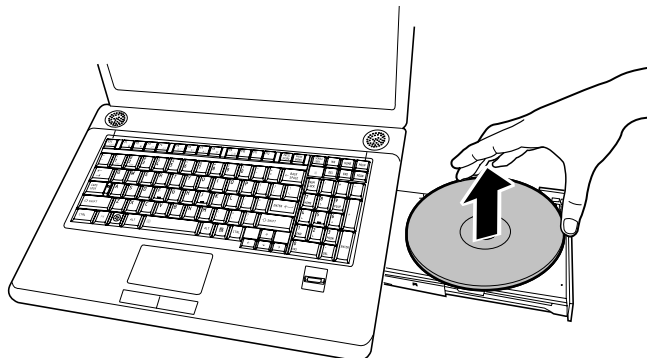

Removing a disc

3. Push the centre of the drawer to close it. Press gently until it locks into place.

Buttons

The Internet button and the CD/DVD button can be assigned functions and applications in the TOSHIBA Controls Properties.

1. Move mouse cursor and reach the top of desktop screen. The back cards and white cards appear. Click "Button support" white card.
2. "Button Support" white card fully appears. After double click this card, the dialog for changing button function is displayed.
3. Change function of Buttons.
Or you can go to 1. Start/All programs/TOSHIBA/Utilities and select Toshiba Assist. 2. Choose optimize from left panel then select TOSHIBA Button Controls.

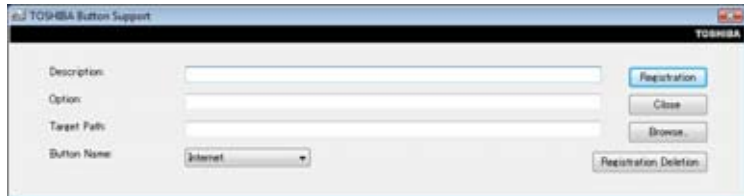

TOSHIBA Button Support

CD/DVD play control buttons

In addition to the power button, the following four buttons control functions relating to the playback of optical media and digital audio data:

Play/Pause	Starts or pauses play
Stop	Stops play
Next	Advances to the next track, chapter or data
Previous	Returns to the previous track, chapter or data



If Random or Shuffle is selected in Windows Media Player, selecting Next or Previous advances to a random selection.

*Writing CDs on a CD-RW/DVD-ROM drive

You can use the CD-RW/DVD-ROM drive to write data to CD-R/RW discs. The following applications for writing are preinstalled:
TOSHIBA Disc Creator/Direct Disc Writer.

Important message

Before you write or rewrite to CD-R/RW media, read and follow all setup and operating instructions in this section. If you fail to do so, the CD-RW/DVD-ROM drive may not function properly, and you may fail to write or rewrite, lose data or incur other damage.

Disclaimer

TOSHIBA does not bear responsibility for the following:

- Damage to any CD-R/-RW disc that may be caused by writing or rewriting with this product.
- Any change or loss of the recorded contents of CD-R/-RW media that may be caused by writing or rewriting with this product, or for any business profit loss or business interruption that may be caused by the change or loss of the recorded contents.
- Damage that may be caused by using third party equipment or software.

Given the technological limitations of current optical disc writing drives, you may experience unexpected writing or rewriting errors due to disc quality or problems with hardware devices. Also, it is a good idea to make two or more copies of important data, in case of undesired change or loss of the recorded contents.



CD-R discs can be written only once. CD-RW discs can be rewritten many times.

Before writing or rewriting

Please observe the following points when you write or rewrite the data.

- We recommend the following manufacturers of CD-R and CD-RW media. Media quality can affect write or rewrite success rates.

CD-R: TAIYOYUDEN CO., LTD.
 MITSUBISHI CHEMICAL CORPORATION
 RICOH Co., Ltd.
 Hitachi Maxell Ltd.

CD-RW: MITSUBISHI CHEMICAL CORPORATION
 RICOH Co., Ltd.

TOSHIBA has confirmed the operation of CD-R and CD-RW media of the manufacturers above. Operation of other media cannot be guaranteed.

- CD-RW can generally be rewritten about 1,000 times. However, the actual number of rewrites is affected by the quality of the media and the way it is used.
- Be sure to connect the universal AC adapter when you write or rewrite.
- Be sure to close all other software programs except the writing software.
- Do not run software such as a screen saver which can put a heavy load on the CPU.
- Operate the computer at full power. Do not use power-saving features.
- Do not write while virus check software is running. Wait for it to finish, then disable virus detection programs including any software that checks files automatically in the background.
- Do not use hard disk utilities, including those intended to enhance hard disk access speeds, as they may cause unstable operation and damage data.
- Write from the computer's hard disk drive to the CD. Do not try to write from shared devices such as a LAN server or any other network device.
- Writing with software other than TOSHIBA Disc Creator has not been confirmed. Therefore, operation with other software cannot be guaranteed.

When writing or rewriting

Please observe/consider the following when you write or rewrite to a CD-R/RW disc.

- Do not perform any of the following actions when writing or rewriting:
 - Change users in the Windows Vista™ operating system.
 - Operate the computer for any other function, including using a mouse or TouchPad/Dual Mode Pad or closing/opening the LCD panel.
 - Start a communication application such as a modem.
 - Apply impact or vibration to the computer.
 - Install, remove or connect external devices such as USB devices, an external display, i.Link devices or optical digital devices.
 - Use the audio/video control button to reproduce music or voice.
 - Open the drive.

- Do not use shut down/log off and Sleep/Hibernation while writing or rewriting
- Make sure writing or rewriting is completed before going into Sleep/hibernation. Writing is completed if you can open the drive tray.
- Set the computer on a level surface and avoid places subject to vibration such as airplanes, trains or cars. Do not use an unstable surface such as a stand.
- Keep mobile phones and other wireless communication devices away from the computer.
- Always copy data from the hard disk drive to the CD. Do not use cut-and-paste as the original data will be lost if there is a write error.

Writing CDs/DVDs on a DVD Super Multi drive supporting double layer disc recording

You can use the DVD Super Multi drive to write data to either CD-R/RW or DVD-R/-RW/+R/+RW/-RAM discs. The following applications for writing are preinstalled:

TOSHIBA Disc Creator/Direct Disc Writer. Ulead DVD MovieFactory® for TOSHIBA, which is a product of Ulead Systems, Inc.

Important message

Before you write or rewrite to CD-R/RW or DVD-R/-RW/+R/+RW/-RAM media, read and follow all set-up and operating instructions in this section. If you fail to do so, the DVD Super Multi drive may not function properly, and you may fail to write or rewrite, lose data or incur other damage.

Disclaimer

TOSHIBA does not bear responsibility for the following:

- Damage to any CD-R/RW or DVD-R/-RW/+R/+RW/-RAM disc that may be caused by writing or rewriting with this product.
- Any change or loss of the recorded contents of CD-R/RW or DVD-R/-RW/+R/+RW/-RAM media that may be caused by writing or rewriting with this product, or for any business profit loss or business interruption that may be caused by the change or loss of the recorded contents.
- Damage that may be caused by using third party equipment or software.

Given the technological limitations of current optical disc writing drives, you may experience unexpected writing or rewriting errors due to disc quality or problems with hardware devices. Also, it is a good idea to make two or more copies of important data, in case of undesired change or loss of the recorded contents.

Before writing or rewriting

Please observe the following points when you write or rewrite data.

- Based on TOSHIBA's limited compatibility testing, we suggest the following manufacturers of CD-R/RW and DVD-R/+R/-RW/+RW/-RAM media. However, in no event does TOSHIBA guarantee the operation, quality or performance of any disc. Disc quality can affect write or rewrite success rates.

CD-R:	TAIYOYUDEN CO., LTD. MITSUBISHI CHEMICAL CORPORATION RICOH Co., Ltd. Hitachi Maxell Ltd.
CD-RW:	MITSUBISHI CHEMICAL CORPORATION RICOH Co., Ltd.
DVD-R:	DVD Specifications for Recordable Disc for General Version 2.0 TAIYOYUDEN CO., LTD. Matsushita Electric Industrial Co., Ltd.
DVD-RW:	DVD Specifications for Re-recordable Disc for Version 1.1 or Version 1.2 VICTOR COMPANY OF JAPAN, LIMITED MITSUBISHI CHEMICAL CORPORATION
DVD+R:	MITSUBISHI CHEMICAL CORPORATION RICOH Co., Ltd.
DVD+RW:	MITSUBISHI CHEMICAL CORPORATION RICOH Co., Ltd.
*DVD-RAM	DVD Specifications for DVD-RAM Disc for Version 2.0, Version 2.1 or Version 2.2 Matsushita Electric Industrial Co., Ltd. Hitachi Maxell Ltd. *DVD Multi drive and DVD Super Multi can use DVD-RAM.
DVD+R (Double Layer)	MITSUBISHI CHEMICAL CORPORATION
DVD-R (Dual Layer)	MITSUBISHI CHEMICAL COPORATION
DVD-R Label Flash	FUJIFILM Corporation
DVD+R Label Flash	FUJIFILM Corporation

- If the disc is poor in quality, dirty or damaged, writing or rewriting errors may occur. Be careful to check the disc for dirt or damage before you use it.
- The actual number of rewrites to CD-RW or DVD-RW/+RW/-RAM is affected by the quality of the disc and the way it is used.
- There are two types of DVD-R: authoring and general use discs. Do not use authoring discs. Only general use discs can be written to by a computer drive.
- We can support only Format 1 of DVD-R DL. Therefore you can not do the additional writing. If your data is under DVD-R (SL) capacity, we suggest to use DVD-R (SL) media.
- You can use DVD-RAM discs that can be removed from a cartridge and DVD-RAM discs designed without a cartridge. You cannot use a disc with a 2.6 GB single-sided capacity or 5.2 GB double-sided capacity.
- Other DVD-ROM drives for computers or other DVD players may not be able to read DVD-R/+R/-RW/+RW/-RAM discs.
- Data written to a CD-R/DVD-R/+R disc cannot be deleted either in whole or in part.
- Data deleted (erased) from a CD-RW and DVD-RW/+RW/-RAM disc cannot be recovered. Check the content of the disc carefully before you delete it. If multiple drives that can write data to discs are connected, be careful not to delete data from the wrong drive.
- In writing to a DVD-R/+R/-RW/+RW disc, some disc space is required for file management, so you may not be able to write the full capacity of the disc.
- Since the disc is based on the DVD-R/-RW standard, it will be filled with dummy data if the written data is less than about 1 GB. Even if you write only a small amount of data, it might take time to fill in the dummy data.
- Two types of DVD-R/+R/-RW/+RW/-RAM discs are on the market: data and video. Use a video disc to store video data. You can use video discs on a DVD recorder as well as on your computer's DVD-ROM drive. You cannot use data discs on a DVD recorder.
- DVD-RAM formatted by FAT32 cannot be read in Windows 2000 without DVD-RAM Driver Software.
- When multiple drives that can write data to discs are connected, be careful not to write to the wrong drive.
- Be sure to connect the universal AC adapter before you write or rewrite.
- Before you enter Sleep/Hibernation Mode, be sure to finish DVD-RAM writing. Writing is finished if you can eject DVD-RAM media.
- Be sure to close all other software programs except the writing software.
- Do not run software such as a screen saver, which can put a heavy load on the CPU.

- Operate the computer at full power. Do not use power-saving features.
- Do not write while virus check software is running. Wait for it to finish, then disable virus detection programs including any software that checks files automatically in the background.
- Do not use hard disk utilities, including those intended to enhance hard disk access speed, as they may cause unstable operation and damage data.
- Write from the computer's hard disk drive to the CD. Do not try to write from shared devices such as a LAN server or any other network device.
- Writing with software other than TOSHIBA Disc Creator or Ulead DVD MovieFactory® for TOSHIBA has not been confirmed. Therefore, operation with other software cannot be guaranteed.

When writing or rewriting

Please observe/consider the following when you write or rewrite to a CD-R/RW, DVD-R/-RW/-RAM or DVD+R/+RW disc.

- Do not perform any of the following actions when writing or rewriting:
 - Change users in the Windows Vista™ operating system.
 - Operate the computer for any other function, including using a mouse or TouchPad/Dual Mode Pad or closing/opening the LCD panel.
 - Start a communication application such as a modem.
 - Apply impact or vibration to the computer.
 - Install, remove or connect external devices such as USB devices, an external display, i.Link devices or optical digital devices.
 - Use the audio/video control button to reproduce music or voice.
 - Open the drive.
- Do not use shut down/log off and Sleep/Hibernation while writing or rewriting.
- Make sure writing or rewriting is completed before going into Sleep/hibernation. Writing is completed if you can open the drive tray.
- Set the computer on a level surface and avoid places subject to vibration such as airplanes, trains or cars. Do not use an unstable surface such as a stand.
- Keep mobile phones and other wireless communication devices away from the computer.
- Always copy data from the hard disk drive to the CD. Do not use cut-and-paste as the original data will be lost if there is a write error.

How to make a Label Flash DVD

Simplified steps for making a Label Flash DVD:

1. Insert a Label Flash disc in DVD drive.



Set printable surface for underside.

2. Click **Start** → **All Programs** → **DVD MovieFactory for TOSHIBA** → **Ulead DVD MovieFactory for TOSHIBA Launcher** to launch DVD MovieFactory.
3. Click **Print Disc Label** → **Label Printing**. Ulead Label@Once is started.
4. Click the **General** tab.
5. Choose **DVD Drive** for Printer. e.g. <E:> PIONEER DVD....
6. Add and customize the look of your images and text.
7. Click **Label Flash setting** and choose **Draw Quality**.
8. Click **Print**.



The availability of Label Flash function depends on the model you purchased.

When Using Ulead DVD MovieFactory® for TOSHIBA

How to make a DVD-Video

Simplified steps for making a DVD-Video from video data captured from a DV-Camcorder:

1. Click **Start** → **All Programs** → **DVD MovieFactory for TOSHIBA** → **Ulead DVD MovieFactory for TOSHIBA Launcher** to launch DVD MovieFactory.
2. Insert a DVD-RW or DVD+RW disc in Burner.
3. Click **Video Disc** → **Burn Video to Disc** to launch **Direct Recording** dialog box, choose **DVD-Video/+VR** to invoke **Straight Capture to Disc** Page.
4. Choose **DVD-Video** format.
5. Confirm the capture source is DV.
6. Press **Capture** button.

Simplified steps for making a DVD-Video from adding a video source:

1. Click **Start** → **All Programs** → **DVD MovieFactory for TOSHIBA** → **Ulead DVD MovieFactory for TOSHIBA Launcher** to launch DVD MovieFactory.
2. Click **Video Disc** → **New Project** to invoke 2nd Launcher, choose your project type, then invoke DVD MovieFactory.
3. Add source from HD Disk by click Add Video files button to invoke browser dialog box.
4. Choose the source video then go to the Next page to apply Menu.
5. After choose the menu template, press **Next** button to go to **Burning Page**.
6. Choose the output type then press **Burn** button.

How to learn more about Ulead DVD MovieFactory®

Please refer to the Help and Manul file for additional Ulead DVD MovieFactory information.

Important information for use

Note the following limitations when you write video DVD:

1. Editing digital video
 - Log in with Administrator rights to use DVD MovieFactory.
 - Make sure that your computer is running on AC power when using DVD MovieFactory
 - Operate the computer at Full Power. Do not use power-saving features.
 - While you are editing DVD, you can display previews. However, if another application is running, the preview might not display properly.
 - DVD MovieFactory cannot edit or play copy protected content.
 - Do not enter Sleep/Hibernation Mode while using DVD MovieFactory
 - Do not operate DVD MovieFactory immediately after turning on the computer. Please wait until all Disc Drive activity has stopped.
 - When recording to a DV-Camcorder, to ensure you capture all of your data, let the camcorder record for a few seconds before you begin recording your actual data.
 - CD recorder, JPEG functions, DVD-Audio, mini DVD and Video CD functions are not supported in this version.
 - While recording video to DVD or tape, please close all other programs.
 - Do not run software like a screen saver because it can put a heavy load on the CPU.
 - Do not support MP3 decode and encode.
2. Before recording the video to DVD
 - When you record to DVD disc, please use only discs recommended by the Drive manufacturer.
 - Do not set the working drive to a slow device like a USB 1.1 hard disk drive or it will fail to write DVD.
 - Do not perform any of the following actions:
 - Operate the computer for any other function, including using a mouse or TouchPad/Dual Mode Pad or closing/opening the LCD panel.
 - Bump or cause vibration to the computer.
 - Use the Mode control button and Audio/Video control button to reproduce music or voice.
 - Open the DVD drive.
 - Install, remove or connect external devices, including the following: SD card, USB devices, external display, i.LINK. devices, optical digital devices.

- Please verify your disc after recording important data.
 - DVD-R/+R/-RW disc cannot be written in VR format.
 - Not support to output VCD or SVCD format.
3. About Straight to Disc
- Not support to record on DVD-R/+R disc
 - Not support to record DVD+VR format by HDV
 - HDV support to burn DVD-Video only
 - DVD-VR format not support to add Menu
4. About recorded DVDs
- Some DVD-ROM drives for personal computers or other DVD players may not be able to read DVD-R/+R/-RW/-RAM discs.
 - When playing your recorded disc on your computer, please use the DVD Video Player.
 - If you use an over-used rewritable disc, the full formatting might be locked. Please use a brand new disc.

TOSHIBA Disc Creator

Note the following limitations when you use TOSHIBA Disc Creator:

- DVD-Video cannot be created using TOSHIBA Disc Creator
- DVD-Audio cannot be created using TOSHIBA Disc Creator
- You cannot use the TOSHIBA Disc Creator "Audio CD" function to record music to the DVD-R/-RW or DVD+R/+RW media.
- Do not use the "Disc Backup" function of TOSHIBA Disc Creator to copy DVD-Video and DVD-ROM with copyright protection.
- DVD-RAM media cannot be backed up with the "Disc Backup" function of TOSHIBA Disc Creator
- You cannot back up a CD-ROM or CD-R/RW to DVD-R/-RW or DVD+R/+RW using the "Disc Backup" function of TOSHIBA Disc Creator.
- You cannot back up DVD-ROM, DVD-Video or DVD-R/-RW or DVD+R/+RW to CD-R/RW using TOSHIBA Disc Creator
- TOSHIBA Disc Creator cannot record in packet format.
- You might not be able to use the "Disc Backup" function of TOSHIBA Disc Creator to backup a DVD-R/-RW or DVD+R/+RW disc that was made with other software on a different DVD-R/-RW or DVD+R/+RW recorder.
- If you add data to a DVD-R and DVD+R disc that you have already recorded to, you might not be able to read the added data under some circumstances. It cannot be read in 16-bit operating systems, such as Windows 98SE and Windows ME, in Windows NT4 you will need Service Pack 6 or later to read the data, and in Windows 2000 you will need Service Pack 2 or later to read it. Some optical media drives cannot read added data regardless of the operating system.

- TOSHIBA Disc Creator does not support recording to DVD-RAM discs. To record to a DVD-RAM, use Explorer or other similar utility.
- When you back up a DVD disc, be sure the source drive supports recording to DVD-R/-RW or DVD+R/+RW discs. If the source drive does not support recording to DVD-R/-RW or DVD+R/+RW discs, it might not be backed up correctly.
- When you back up a DVD-R, DVD-RW, DVD+R or DVD+RW, be sure to use the same type of disc.
- You cannot partially delete any data written to a CD-RW, DVD-RW or DVD+RW disc.

Data Verification

To verify that data is written or rewritten correctly, follow the steps below before you write or rewrite a Data CD/DVD.

1. Display the setting dialog box by one of the following two steps:
 - Click the setting button () for writing on the main toolbar in the **Data CD/DVD** mode.
 - Select **Setting for writing** → **Data CD/DVD** in the **Setting** menu.
2. Mark the **Verify written data** check box.
3. Select **File Open** or **Full Compare** mode.
4. Click the OK button.

Media Care

This section provides tips on protecting data stored on your discs and disks. Handle your media with care. The following simple precautions will increase the lifetime of your media and protect the data stored on it:

1. Store your discs in the container they came in to protect them and keep them clean.
2. Do not bend the disc.
3. Do not write on, apply a sticker to, or otherwise mar the surface of the disc that contains data.
4. Hold the disc by its outside edge or the edge on the center hole. Fingerprints on the surface can prevent the drive from properly reading data.
5. Do not expose to direct sunlight, or extreme heat or cold, and do not place heavy objects on your discs.
6. If your discs become dusty or dirty, wipe them with a clean dry cloth. Wipe from the center out, do not wipe in a circular direction around the disc. If necessary, use a cloth dampened in water or a neutral cleaner. Do not use benzine, thinner or similar cleaner.

Disks

1. Store your disks in the container they came in to protect them and keep them clean. If a disk is dirty, do not use cleaning fluid. Clean it with a soft damp cloth.
2. Do not slide back the disk's protective metal covering or touch the disk's magnetic surface. Fingerprints may prevent the disk drive from reading data from the disk.
3. Data may be lost if the disk is twisted, bent, or exposed to direct sunlight, or extreme heat or cold.
4. Do not place heavy objects on your disks.
5. Do not eat, smoke, or use erasers near your disks. Foreign particles inside the disk's jacket can damage the magnetic surface.
6. Magnetic energy can destroy data on disks. Keep your disks away from speakers, radios, television sets and other sources of magnetic fields.

TV-Out

Use the TV-Out port to connect to a television. Be sure to use a 4 pin type S-video cable.

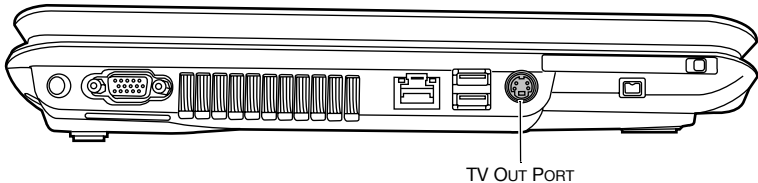

Setting up more than one display

You can set up your computer to utilize more than one display, effectively spreading a single desktop screen across two monitors.

The Display settings window allows you to adjust more precisely the relative positioning of the two displays when they are configured as an extended desktop. On the Display Settings window, the two displays can be positioned horizontally, vertically or in any diagonal configuration you wish, as shown below.

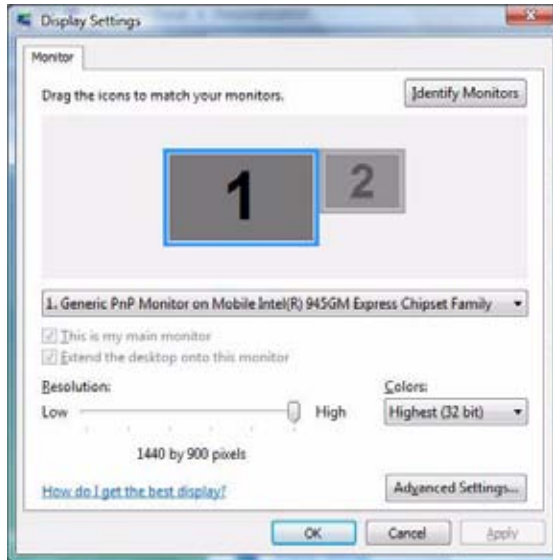

If an external display will not be connected next time you use your computer, you should cancel any extended desktop or clone display settings before shutting down your computer.

Clone display settings are those where more than one device has been selected and is simultaneously applicable.

Cleaning the computer

To help ensure long, trouble-free operation, keep the computer free of dust and use care with liquids around the computer.

- Be careful not to spill liquids into the computer. If the computer does get wet, turn the power off immediately and let the computer dry completely before you turn it on again.
- Clean the computer using a slightly damp (with water) cloth. You can use glass cleaner on the display. Spray a small amount of cleaner on a soft, clean cloth and wipe the screen gently with the cloth.



Never spray cleaner directly onto the computer or let liquid run into any part of it. Never use harsh or caustic chemical products to clean the computer.

Moving the computer

The computer is designed for rugged durability. However, a few simple precautions taken when moving the computer will help ensure trouble-free operation.

- Make sure all disk activity has ended before moving the computer. Check the **Built-in Hard Disk Drive** and **optical disc drive** indicators on the computer.
- If a disk is in the disk drive, remove it.
- If a disc is in the optical disc drive, remove it. Also make sure the optical disc drive drawer is securely closed.
- Turn off the power to the computer.
- Disconnect all peripherals before moving the computer.
- Close the display. Do not pick up the computer by its display panel or back (where the interface ports are located).
- Close all port covers.
- Disconnect the AC adapter if it is connected.
- Use the carrying case when transporting the computer.

The Keyboard

The computer's keyboard layouts are compatible with a 104/105-key enhanced keyboard. By pressing some keys in combination, all the 104/105-key keyboard functions can be executed on the computer.

The number of keys on your keyboard depends on which country/region's keyboard layout your computer is configured with. Keyboards for numerous languages are available.

There are five types of keys: typewriter keys, keypad overlay, function keys, soft keys and cursor control keys.

Typewriter keys

The typewriter keys, produce the upper- and lower-case letters, numbers, punctuation marks, and special symbols that appear on the screen.

There are some differences, however, between using a typewriter and using a computer keyboard:

- Letters and numbers produced in computer text vary in width. Spaces, which are created by a space character may also vary depending on line justification and other factors.
- The lowercase l (el) and the number 1 (one) are not interchangeable on computers as they are on a typewriter.
- The uppercase O (oh) and the 0 (zero) are not interchangeable.
- The **Caps Lock** function key locks only the alphabetic characters in uppercase while the shift lock on a typewriter places all keys in the shifted position.
- The **Shift** keys, the **Tab** key, and the **BkSp** (backspace) key perform the same function as their typewriter counterparts but also have special computer functions.

F1 ... F12 function keys

The function keys, not to be confused with Fn, are the 12 keys at the top of your keyboard. These keys are dark gray, but function differently from the other dark gray keys.



F1 through **F12** are called function keys because they execute programmed functions when pressed. Used in combination with the **Fn** key, keys marked with icons execute specific functions on the computer. See the section, *Soft keys: Fn key combinations*, in this chapter. The function executed by individual keys depends on the software you are using.

Soft keys: Fn key combinations

The **Fn** (function) is unique to TOSHIBA computers and is used in combination with other keys to form soft keys. Soft keys are key combinations that enable, disable or configure specific features.



Some software may disable or interfere with soft-key operations. Soft-key settings are not restored by the Sleep feature.

Emulation keys

Your software may require you to use keys that the keyboard does not have. Pressing the **Fn** key and one of the following keys simulates the enhanced keyboard's functions.

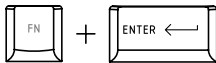



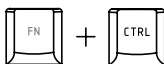











Press **Fn + Enter** to simulate **Enter** on the enhanced keyboard's numeric keypad.



Press **Fn + Ctrl** to simulate the enhanced keyboard's right **Ctrl** key.

Hotkeys

	Fn + ESC	Volume Mute Turns the volume on and off.
	Fn + F1	Instant Security Enters screen saver mode and blanks the screen. To restore your desktop, press any key or use the TouchPad/Dual Mode Pad.
	Fn + F2	Power Save Modes Displays the power save modes and lets you change the power settings
	Fn + F3	Sleep This hot key switches the system to Sleep mode.
	Fn + F4	Hibernate This hot key switches the system to Hibernate mode.
	Fn + F5	Display Selection Changes displays.
	<i>Default resolution for simultaneous mode is set to WXGA+ (1440x900). If you connect an RGB (Monitor) that is not WXGA+, change it in "Control Panel/Personalization/Display settings".</i>	
	Fn + F6	Brightness Down
	Fn + F7	Brightness Up
	Fn + F8	Wireless Device Controls Pressing this hot key allows you to switch between active wireless devices if the wireless communication switch is switched on.
	Fn + F9	TouchPad/Dual Mode Pad On/Off
	Fn + Space	Change Resolution Cycles sequentially from the current resolution to 800x600 to 1024x768 and back again to the original resolution.
	Fn + 1	Zoom Out To reduce the icon size on the desktop or the application window, press the 1 key while holding down the Fn key.
	Fn + 2	Zoom In To enlarge the icon size on the desktop or the application window, press the 2 key while holding down the Fn key.

 Before using Fn+1 and Fn+2, you must install the TOSHIBA Zooming Utility. Please be aware that this 'zooming' function is only available within Microsoft Internet Explorer, Microsoft Office, Windows Media Player and Adobe Reader, and for the icons on the desktop.

Windows special keys

The keyboard provides two keys that have special functions in Windows Vista. One activates the Start menu and the other has the same function as the secondary mouse button.



This key activates the Windows Vista Start menu



This key has the same function as the Right mouse button.

Number Pad

The number pad is activated by pressing the Num Lock key, the LED will appear when active. Use the keypad to type numbers and generate ASCII characters.

Generating ASCII characters

Not all ASCII characters can be generated using normal keyboard operation. But, you can generate these characters using their ASCII codes.

With the Num lock on:

1. Hold down **Alt**.
2. Using the number pad keys, type the ASCII code.
3. Release **Alt**, and the ASCII character appears on the display screen.

With the Num Lock off:

1. Hold **Alt + Fn**.
2. Using the number pad keys, type the ASCII code.
3. Release **Alt + Fn**, and the ASCII character appears on the display screen.

Chapter 6

Power and Power-Up Modes

The computer's power resources include the AC adapter and internal batteries. This chapter gives details on making the most effective use of these resources including charging and changing batteries, tips for saving battery power, and power up modes.

Power conditions

The computer's operating capability and battery charge status are affected by the power conditions: whether an AC adapter is connected, whether a battery is installed and what the charge level is for the battery.

		Power on	Power off (no operation)
AC adapter connected	Battery fully charged	<ul style="list-style-type: none">• Operates• No charge• LED: Battery blue DC IN blue	<ul style="list-style-type: none">• No charge• LED: Battery blue DC IN blue
	Battery partially charged	<ul style="list-style-type: none">• Operates• Charge• LED: Battery Amber DC IN blue	<ul style="list-style-type: none">• Charge• LED: Battery Amber DC IN blue
	No battery installed or no charge	<ul style="list-style-type: none">• Operates• No charge• LED: Battery off DC IN blue	<ul style="list-style-type: none">• No charge• LED: Battery off DC IN blue

		Power on	Power off (no operation)
AC adapter not connected	Battery capacity is above low battery trigger point	<ul style="list-style-type: none"> Operates LED: Battery off DC IN off 	
	Battery capacity is below low battery trigger point	<ul style="list-style-type: none"> Operates Alarm sounds (this function depends on how the computer is configured) LED: Battery flashes amber DC IN off 	
	Battery capacity exhausted	Computer goes into Hibernation or shuts down (depending on the TOSHIBA Power Saver setting)	
	No battery installed	<ul style="list-style-type: none"> No operation LED: Battery off DC IN off 	



* The LED is dependent on the model you purchased.

Power indicators

As shown in the above table, the **Battery**, **DC IN** and **Power** indicators alert you to the computer's operating capability and battery charge status

Battery indicator

Check the **Battery** indicator to determine the status of the battery. The following indicator lights indicate the battery status.

Flashing Amber	The battery charge is low. The AC adapter must be connected to recharge the battery
Amber	Indicates the AC adapter is connected and is charging the battery.
Blue	Indicates the AC adapter is connected and the battery is fully charged.
No light	Under any other conditions, the indicator does not light.

DC IN indicator

Check the **DC IN** indicator to determine the power status with the AC adapter connected:

Blue	Indicates the AC adapter is connected and is correctly supplying power to the computer.
No light	Indicates the AC adapter is not connected.

Power indicator

Check the **Power** indicator to determine the power status with the AC adapter connected:

Blue	Indicates power is being supplied and the computer is turned on. Power indicator is located inside of the Power Button (depending the model you purchased) and in the front of the computer.
Blinking Amber	Indicates power is being supplied to the computer while the computer is in Sleep mode.
No light	Under any other conditions, the indicator does not light.

Battery types

The computer has two types of batteries:

- Battery pack
- Real Time Clock (RTC) battery

Battery pack

When the AC adapter is not connected, the computer's main power source is a removable lithium ion battery pack, also referred to in this manual as the battery.

You can purchase additional battery packs for extended use of the computer away from an AC power source.

The battery is a disposable item. When its operation becomes short even when fully charged, replace it with a new one.



- *The battery pack is a lithium ion battery, which can explode if not properly replaced, used, handled or disposed of. Dispose of the battery as required by local ordinances or regulations. Use only batteries recommended by TOSHIBA as replacements.*
- *Do not remove the battery pack while the computer is in Sleep Mode. In this mode data is stored in memory, so if the computer loses power, it will be lost.*
- *Battery type (depending on the model you purchased):*
6 cell-PA3536U-1BRS,PA3536U-1BAS
9 cell-PA3537U-1BRS,PA3537U-1BASon
- ** The availability of this battery is dependent on the model you purchased.*

Real Time Clock battery

The Real Time Clock (RTC) battery provides power for the internal real time clock and calendar. It also maintains the system configuration.

If the RTC battery becomes completely discharged, the system loses this data and the real time clock and calendar stop working. The following message appears when you turn on the power:



```
ERROR 0271:Check date and time settings.
WARNING 0251:System CMOS checksum bad - Default
configuration used.
Press <F1> to resume, <F2> to Setup.
```



The computer's RTC battery is a lithium battery and should be replaced only by your dealer or by a TOSHIBA service representative. The battery can explode if not properly replaced, used, handled or disposed of. Dispose of the battery as required by local ordinances or regulations.

When this error appears, the following action is recommended.

1. Connect the AC adapter and let the battery charge for 24-hours.
2. Press F2 to enter BIOS setup menu.
3. Set correct time and date.



If you still see the error message after performing the above actions, please contact your TOSHIBA service representative.

Care and use of the battery pack

The battery pack is a vital component of portable computing. Taking proper care of it will help ensure longer operating time on battery power as well as a longer life for your battery pack. Follow the instructions in this section carefully to ensure safe operation and maximum performance.

Safety precautions

Mishandling of batteries can cause death, serious injury or property damage.

Carefully observe the following advice:

Danger: Indicates an imminently hazardous situation, which could result in death or serious injury, if you do not follow instructions.

Warning: Indicates a potentially hazardous situation, which could result in death or serious injury, if you do not follow instructions.

Caution: Indicates a potentially hazardous situation, which if not avoided, may result in moderate or minor injury or property damage.

Note: Provides important information.

Danger

1. Never try to dispose of the battery pack by burning or expose it to a heating device such as a microwave oven. The battery pack could explode and cause bodily injury.
2. Never try to disassemble, repair or otherwise tamper with a battery pack. The battery pack will overheat and ignite. Leakage of caustic alkaline solution or other electrolytic substances will cause fire or injury, possibly resulting in death or serious injury.
3. Never short-circuit the battery pack by contacting the terminals with a metal object. A short-circuit can cause fire or otherwise damage the battery pack and possibly cause injury. To avoid accidental short-circuit, always wrap the battery pack in plastic and cover the terminals with electrical tape when storing or disposing of the battery pack.
4. Never puncture the battery pack with a nail or other sharp object. Never strike it with a hammer or other object. Never step on it.
5. Never try to charge the battery pack in any manner other than that described in the user's manual. Never connect the battery pack to a plug socket or to an automobile's cigarette lighter socket. It may rupture or ignite.

6. Use only the battery pack supplied with the computer or other device or an battery pack approved by the computer or device's manufacturer. Battery packs have different voltages and terminal polarities. Use of an improper battery could cause smoke, fire or rupture of the battery pack.
7. Never subject a battery pack to heat, such as storage near a heat source. Exposure to heat can cause the battery pack to ignite, explode or leak caustic liquid and cause death or serious injury. It could also fail or malfunction causing data loss.
8. Never expose the battery pack to abnormal shock, vibration or pressure. The battery pack's internal protective device will fail, causing it to overheat, explode, ignite or leak caustic liquids possibly resulting in death or serious injury.
9. Never let a battery pack become wet. A wet battery pack will overheat, ignite or rupture possibly resulting in death or serious injury.

Warning

1. Never allow caustic electrolyte fluid leaked from a battery pack to contact your eyes, skin or clothing. If caustic electrolyte fluid should contact your eyes, immediately wash your eyes with large amounts of running water and seek medical attention, to help prevent eye damage. If electrolyte fluid should contact your skin, immediately wash it under running water to prevent rash. If it contacts your clothes, promptly remove them to prevent the fluid from contacting your skin or eyes.
2. Immediately turn off the power, disconnect the AC adapter and remove the battery if any of the following events are observed in the battery pack: offensive or unusual odor, excessive heat, discoloration or deformation. Never use the computer again until it has been checked by a TOSHIBA service provider. It might generate smoke or fire, or the battery pack might rupture.
3. Make sure the battery is securely installed in the computer before attempting to charge the battery pack. Improper installation could generate smoke or fire, or cause the battery pack to rupture.
4. Keep the battery pack out of reach of infants and children. It can cause injury.

Caution

1. Never continue to use a battery pack after its recharging capacity has become impaired, or after the display of a warning message indicating that the battery pack's power is exhausted. Continued use of an exhausted or impaired battery pack could cause the loss of data.
2. Never dispose of battery packs with normal trash. Bring them to your TOSHIBA dealer or to another recycling centre to save resources and prevent environmental damage. Cover the terminals with electrical tape to prevent short-circuits, which could cause the battery pack to ignite or rupture.
3. Use only battery packs recommended by TOSHIBA as replacements.
4. Always make sure the battery pack is installed correctly and securely. Otherwise, a battery pack could fall out and possibly cause injury.

5. Charge the battery pack only in an ambient temperature between 5 and 30 degrees Celsius. Otherwise, the electrolyte solution might leak, battery pack performance might deteriorate and the battery life might be shortened.
6. Be sure to monitor the remaining battery power. If the battery pack or real time clock battery discharge completely, Sleep Mode will not function, and data in memory will be lost, and the computer might register an incorrect time and date. In this case, connect the AC adapter to recharge the batteries.
7. Never install or remove the battery pack without first turning off the power and disconnecting the AC adapter. Never remove the battery pack while the computer is in Sleep Mode as data will be lost.

Note

1. Never remove the battery pack while the Wake-up on LAN function is enabled. Data will be lost. Before you remove a battery pack, disable the Wake-up on LAN function.
2. To ensure the battery pack maintains maximum capacity, operate the computer on battery power once a week until the battery pack is fully discharged. Refer to the section *Extending battery life* in this chapter for procedures. If the computer is continuously operated on AC power for an extended period, more than a week, the battery might fail to retain a charge. It might not function efficiently over the expected life of the battery pack and the Battery indicator might not indicate a low-battery condition.
3. After the battery pack is charged, avoid leaving the AC adapter connected and the computer turned off for more than a few hours at a time. Continuing to charge a fully charged battery pack can damage the battery.

Charging the batteries

When the power in the battery pack becomes low, the **Battery** indicator flashes amber indicating that only a few minutes of battery power remain. If you continue to use the computer while the **Battery** indicator flashes, the computer enables Hibernation mode (so you don't lose data) and automatically turns off.

You must recharge a battery pack when it becomes discharged.

Procedures

To recharge a battery pack while it is installed in the computer, connect the AC adapter to the **DC IN** socket and plug the other end into a working outlet. The **Battery** indicator glows amber when the battery is being charged.



Use only the computer connected to an AC power source to charge the battery pack. Do not attempt to charge the battery pack with any other charger.

Time

The following table shows the time required to fully charge a discharged battery.

Charging time (hours)

Battery type	Power on	Power off
Battery pack	about 12 or longer	about 4 or longer
RTC battery	about 24	about 24 with AC or Battery pack



The charging time when the computer is on is affected by ambient temperature, the temperature of the computer and how you use the computer.

If you make heavy use of external devices the battery might scarcely charge at all during operation. Refer also to the section Maximizing battery operating time.

Battery charging notice

The battery may not charge right away under the following conditions:

- The battery is extremely hot or cold. To make sure the battery charges to its full capacity, charge the battery at room temperature of 10° to 30°C (50° to 86°F).
- The battery is nearly completely discharged. Leave the AC adapter connected for a few minutes and the battery should begin charging.



Once a battery pack is fully charged, it is recommended that you operate the computer only on battery power until the battery pack completely discharges. Doing so extends battery life and helps ensure accurate monitoring of battery capacity.

The **Battery** indicator may show a rapid decrease in battery operating time when you try to charge a battery under the following conditions:

- The battery has not been used for a long time.
- The battery has completely discharged and been left in the computer for a long time.
- A cool battery is installed in a warm computer.

In such case, follow the steps below.

1. Fully discharge the battery by leaving it in the computer with the power on until the power automatically shuts off.
2. Plug in the AC adapter.
3. Charge the battery until the Battery indicator glows blue (depending the model you purchased).

Repeat these steps two or three times until the battery recovers normal capacity.



Leaving the AC adapter connected will shorten battery life. At least once a week, run the computer on battery power until the battery is fully discharged, then recharge the battery.

Monitoring battery capacity

Remaining battery power can be monitored using the following methods.

- Clicking the battery icon on the task bar
- Via the Battery Stats in the Windows Mobility Center Window



■ *You should wait at least 16 seconds after turning on the computer before trying to monitor the remaining operating time. This is because the computer needs this time to check the battery's remaining capacity and then calculate the remaining operating time, based on this together with the current power consumption.*

- *Please be aware that the actual remaining operation time may differ slightly from the calculated time.*

With repeated discharges and recharges, the battery's capacity will gradually decrease. In view of this it will be noted that an often used, older battery will not operate for as long as a new battery even when both are fully charged.

Maximizing battery operating time

A battery's usefulness depends on how long it can supply power on a single charge.

How long the charge lasts in a battery depends on:

- How you configure the computer (for example, whether you enable battery power saving options). The computer provides a battery save mode to conserve battery power. This mode has the following options:
 - Display auto off
 - Hard Disk Drive auto off
 - System auto off
 - LCD brightness
- How often and how long you use the hard disk, optical media drive and the disk drive (if one is connected).
- How much charge the battery contained to begin with.
- Enabling Sleep Mode or Hibernation Mode conserves battery power if you are frequently turning the computer off and on.
- Where you store your programs and data.
- Closing the display when you are not using the keyboard saves power.
- Operating time decreases at low temperatures.
- The condition of the battery terminals. Make sure the battery terminals stay clean by wiping them with a clean dry cloth before installing the battery pack.

Retaining data with power off (sleep mode)

When you turn off your computer with fully charged batteries, the batteries retain data/charge for the following approximate time periods:

Battery	Approximately 1.5days(Sleep mode,9-cell) Approximately 1 days (Sleep mode,6-cell) Approximately 1 month (Shut down mode, all type of battery packs)
RTC battery	Approximately 1 month

* The availability of this battery is dependent on the model you purchased.

Extending battery life

To maximize the life of your battery pack:

- If you have extra battery packs, rotate their use.
- If you will not be using the system for an extended period, remove the battery pack.
- Store spare battery packs in a cool dry place out of direct sunlight.

Replacing the battery pack

When the battery pack reaches the end of its operating life you will need to install a new one. If the **Battery** indicator flashes amber shortly after the battery has been fully recharged, the battery pack needs to be replaced.

You might also replace a discharged battery pack with a charged spare when you are operating your computer away from an AC power source. This section explains how to remove and install the battery pack.

Removing the battery pack

To replace a discharged battery pack, follow the steps below.



- *When handling battery packs, be careful not to short circuit the terminals. Also do not drop, hit or otherwise apply impact; do not scratch or break the casing and do not twist or bend the battery pack.*
- *Do not remove the battery pack while the computer is in Sleep Mode as data in memory will be lost.*

1. Save your work.
2. Turn the computer's power off. Make sure the Power indicator is off.
3. Remove all cables connected to the computer.
4. Turn the computer upside down.

5. Unlock the Battery Pack Lock.

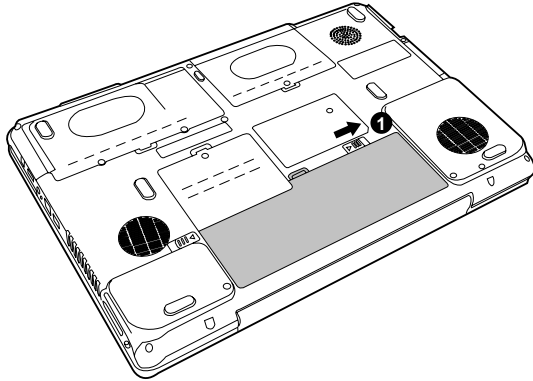

Removing the battery pack-1

6. Slide the battery pack latch to the left, then pull the battery out of the battery bay.

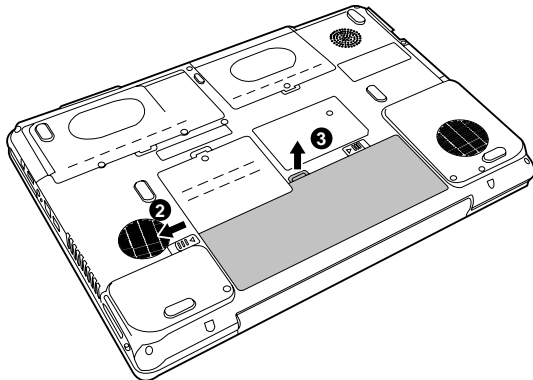

Removing the battery pack-2

Installing the battery pack

To install a battery pack, follow the steps below.



The battery pack is a lithium ion battery, which can explode if not properly replaced, used, handled or disposed of. Dispose of the battery as required by local ordinances or regulations. Use only batteries recommended by TOSHIBA as replacements.

1. Turn the computer's power off.
2. Disconnect all cables connected to the computer.
3. Hold the battery pack so that the label faces down and the connectors on the battery face the connectors on the computer.
4. Gently slide the battery into the battery bay until the latch clicks into place.

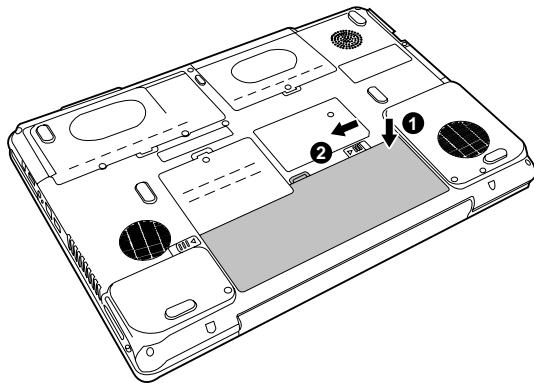

Installing the battery pack

TOSHIBA Password Utility

The TOSHIBA Supervisor Password Utility provides two levels of password security: User and Supervisor.



Passwords set in TOSHIBA Supervisor Password Utility are different from the Windows® login password.

User Password

To start the utility, point to or click the following items:

Launch **TOSHIBA Assist** → **SECURE** → **User Password**

- **Registered**

Click to register a password of up to 8 characters. After a password is set, you will be prompted to enter it when you start the computer.

- **Not Registered**

Click to delete a registered password. Before you can delete a password, you must first enter the current password correctly.

- **Owner String** (text box)

You can use this box to associate text with the password. After you enter text, click **Apply** or **OK**, then, each time the computer is switched on, this text will be displayed along with the prompt for the password.

Supervisor password

If you set a supervisor password, some functions will be restricted when a user logs on with the user password. To set a supervisor password:

TOSHIBA Assist → **SECURE** → **Supervisor password**

This utility lets you do the following:

- Register or delete the supervisor password.
- Specify restrictions for general users.

Starting the computer by password

If you have already registered a password, there are two ways to start the computer:

- Swipe your fingerprint on the sensor if you have already registered the fingerprint with the Fingerprint utility and enabled **Fingerprint Power-on Security**. If you would not like to swipe your finger or cannot authenticate the fingerprint for some reasons, push the **BkSp** key to skip the fingerprint authentication screen. You can try to swipe the fingerprint up to five times. If you failed fingerprint authentication more than five times, you must enter the password manually to start the computer.
- Enter the password manually.



The password is necessary only if the computer was shut down in boot mode, not in Hibernation or Sleep mode.

To enter a password manually, follow these steps:

1. Turn on the power as described in Chapter 3, *Getting Started*. The following message will appear in the LCD:

Enter Password [xxxxxxxx]



*At this point, the hotkeys **Fn + F1 to F9** do not work. They will function after you enter the password.*

2. Enter the Password.
3. Press **Enter**.



If you enter the password incorrectly three consecutive times, the computer shuts down. You must turn on the computer again and re-enter the password.

Power-up modes

The computer has three power-up modes:

- Hibernation (saves data in memory to the hard disk)
- Sleep (power remains on, maintaining the data in memory, but the CPU and all other devices effectively enter a 'sleep' mode)
- Boot (does not save data in memory)



*Refer also to the section *Turning off the power* in Chapter 3, *Getting Started*.*

Panel power off/on

This feature makes the computer to enter Hibernation when the display panel is closed and turns it back on when the display panel is opened.



If the panel power off function is enabled and you use Shut down Windows, do not close the display until the shut down function is completed.

System automatic Sleep/Hibernation

This feature automatically turns off the system in Sleep or Hibernation mode if the computer is not used for a set duration.

Refer to *Special features*, in Chapter 1, *Satellite P200/Satellite Pro P200 Series Features* for an explanation of how to set the duration.

Chapter 7

HW Setup

This chapter explains how to use the TOSHIBA HW Setup utility to configure your computer. TOSHIBA HW Setup lets you configure settings for various hardware devices through a number of tabs titled General, Password, Display, Boot Priority, Keyboard, CPU, LAN, and USB.

Accessing HW Setup

Start, point to All Programs, point to TOSHIBA, point to Utilities and click HWSetup.

HW Setup Window

The HW Setup window contains the following tabs: General, Password, Display, Boot Priority, Keyboard, LAN, and USB.

There are also these three buttons:

OK	Accepts your changes and closes the HW Setup window.
Cancel	Closes the window without accepting your changes.
Apply	Accepts all your changes without closing the HW Setup window.

General

This window displays the BIOS version and contains two buttons:

Default	Return all HW Setup values to the factory settings.
About	Display the HW Setup version.

Setup

This field displays BIOS Version and date.



When finish BIOS update , please restart your computer and press F2 into BIOS setup manual and load BIOS default one time .

Password

This tab allows you to set or reset the user password for power on.

Display

This tab lets you customize your computer's display settings for either the internal LCD screen or for an external monitor.

Power On Display

This option allows you to select the display to be used when the computer is switched on.

Auto-Selected	Selects an external monitor if one is connected. Otherwise, it selects the internal LCD (Default).
LCD + Analog RGB	Selects both the internal LCD and external monitor for simultaneous display.

CPU

This function lets you set the CPU operating mode.



This option is displayed only for Core Duo/Solo processor based model.

Dynamic CPU Frequency Mode

This option lets you choose from the following settings:

Dynamically Switchable	CPU power consumption and clock speed automatic switching function is enabled. When the computer is in use, CPU operation is automatically switched when necessary (Default).
Always Low	CPU power consumption and clock speed automatic switching function is disabled. The CPU always runs at low power consumption and low speed.

Boot Priority

Boot Priority Options

This option sets the priority for booting the computer.

Select the boot priority from the drop down list.

You can override the settings and manually select a boot device by pressing one of the following keys while the computer is booting:

U	Selects the USB floppy disk drive.
N	Selects the Network.
C	Selects optical device.

To select the boot drive you want, follow the steps below.

1. Boot-up your computer and press **F12 to enter the boot menu.**
2. The boot select screen will be displayed: HDD1, HDD2, CD/DVD, and LAN.
3. Use the upper/lower cursor keys to highlight the boot device you want and press **Enter**.

Keyboard

Wake-up on Keyboard

When this feature is enabled and the computer is in Sleep mode, you can turn on the computer by pressing any key. It is effective only for the internal keyboard and only when the computer is in Sleep mode.

Enabled	Enables the Wake-up on Keyboard feature.
Disabled	Disables the Wake-up on Keyboard function (Default).

USB

Legacy USB Support

Use this option to enable or disable legacy USB support. If your operating system does not support USB, you can still use a USB mouse, keyboard, and floppy disk drive by setting the Legacy USB Support option to enable.

Enabled	Enables Legacy USB Support.
Disabled	Disables Legacy USB Support.

LAN

Wake-up on LAN

This feature lets the computer's power be turned on when it receives a wake-up signal from the LAN.

Enabled	Enables Wake-up on LAN.
----------------	-------------------------

Disabled	Disables Wake-up on LAN (Default).
-----------------	------------------------------------



The Wake-up LAN function support AC adapter mode only, before you plan to use this function please make sure your AC power source is connected to system properly.



Do not install or remove an optional memory module while Wake-up on LAN is enabled.

Built-in LAN

This feature enables or disables the Built-in LAN.

Enabled	Enables Built-in LAN function (Default).
----------------	--

Disabled	Disables Built-in LAN function.
-----------------	---------------------------------

Optional Devices

Optional devices can expand the computer's capabilities and its versatility. This chapter describes connection or installation of the following types of devices, which are available from your TOSHIBA dealer:

Cards/Memory

- Express Card
- SD (Secure Digital) / SDHC(Secure Digital High Capacity) / MMC (Multi Media Card) / MS (Memory Stick) /MS Pro (Memory Stick Pro) / xD (xD-Picture Card) cards
- Memory modules

Power devices

- Battery pack
- AC adapter

Peripheral devices

- External monitor
- Television
- i.LINK (IEEE1394a)
- Security lock

Express Card

The computer (depending on the model) is equipped with an Express Card expansion slot that can accommodate two standard module formats; an Express Card/34 module and an Express Card/54 module. An Express Card module is a small, modular add-in card technology based on PCI Express and Universal Serial Bus (USB) interfaces.

Installing an Express Card

One Express Card connector is located on the right side of the computer. The computer's hot-install feature lets you install Express Card while the computer's power is on.

To install an Express Card, follow the steps below.

1. Insert the Express Card.
2. Press gently to ensure a firm connection.

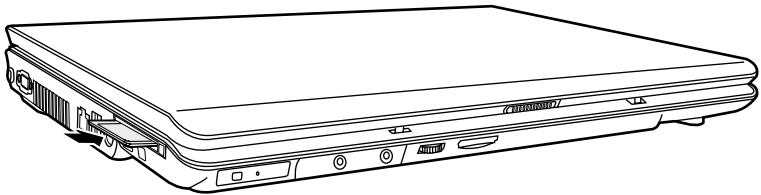

Installing an Express Card

After installing the card, refer to the card's documentation and check the configuration in Windows to make sure it is appropriate for your card.

Removing an Express Card

1. Click the **Safety Remove Hardware** icon on the Task Bar.
2. Click the Express Card you want to remove.
3. Press the Express Card once to extend it.
4. Grasp the extended Express Card, and remove it.

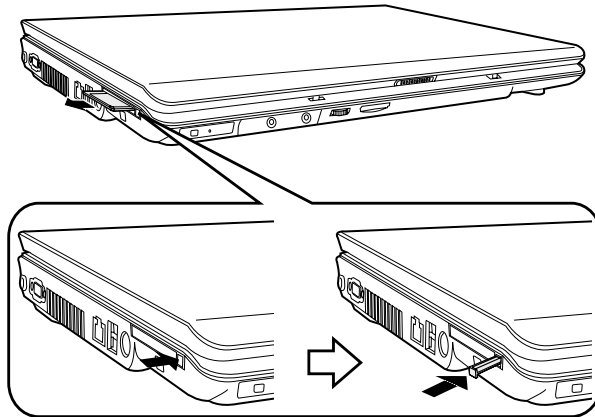

Removing an Express Card

SD/SDHC/MMC/MS/MS Pro/xD Memory cards

The computer is equipped with a multiple digital media card slot that can accommodate SD/SDHC/MMC/MS/MS Pro/xD memory cards. These memory cards let you easily transfer data from devices, such as digital cameras and Personal Digital Assistants, which use flash-memory.

Card Type	Capacities
SD	up to 2GB
SDHC	4GB
MMC	up to 1GB
MS	up to 128MB, 256MB (128MB x 2, selectable)
MS Pro	up to 2GB
xD	up to 2GB



Keep foreign objects out of the memory card slot. A pin or similar object can damage the computer's circuitry.



Do not format a memory card with Windows[®] as it might result in that card not being able to be used with some peripheral devices.



The Logo of SD memory card is .



The Logo of SDHC memory card is .



The card is designed so that it can be inserted only one way. Do not try to force the card into the slot.



Memory Stick Duo/PRO Duo and the Memory Stick adaptor are not compatible with the Multiple Digital Media Card slot. Do not insert Memory Stick Duo/PRO Duo into the slot. Data may be lost or damaged if you use any card other than those supported.



For more details on using memory cards, see manuals accompanying the cards.

Installing a memory card

To install a memory card:

1. Insert the memory card.
2. Press gently to ensure a firm connection.

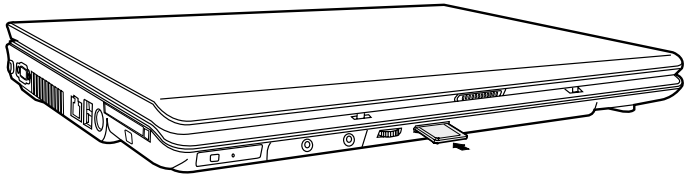

Inserting a memory card



Make sure the memory card is oriented properly before you insert it. If Windows® fails to read the card, remove it then re-insert it.



■ The multiple digital media card slot only accepts one type of card at a time. Do not attempt to install more than one card as you risk damaging either the cards themselves or the computer.

Removing a memory card

To remove a memory card, follow the steps below:

1. Click the **Safely Remove Hardware** icon on the Taskbar.
2. Select a device, then click the **Stop** button. A confirmation dialog may appear, depending on how the device is registered with the system; if so, confirm that you want to remove the device.
3. Gently press the memory card inside the socket to eject it.
4. Grasp the card and remove it.

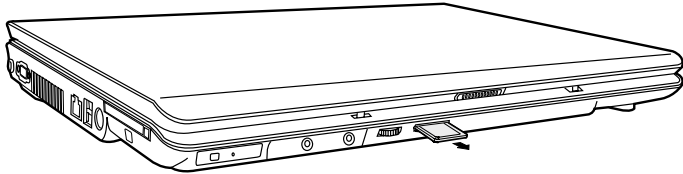

Removing a memory card



- *Make sure the memory card indicator is out before you remove the card or turn off the computer's power. If you remove the card or turn off the power while the computer is accessing the card you may lose data or damage the card.*
- *Do not remove the card while the computer is in Sleep or Hibernation mode. The computer could become unstable or data in the memory card could be lost.*
- *Do not turn off or place the computer into either Sleep Mode or Hibernation Mode while data is being transferred to or from the memory card. The system may become unstable or data in the memory card may be lost.*

Memory card care



Set the write-protect switch to the lock position, if you do not want to record data.

1. Do not write to a memory card if the battery power is low. Low power could affect writing accuracy.
2. Do not remove a memory card while read/write is in progress.
3. The memory card is designed so that it can be inserted only one way. Do not try to force the card into the slot.
4. Do not leave a memory card partially inserted in the slot. Press the memory card until you hear it click into place.
5. Do not twist or bend memory cards.
6. Do not expose memory cards to liquids or store in humid areas or lay media close to containers of liquid.
7. After using a memory card, return it to its case.
8. Do not touch the metal part or expose it to liquids or let it get dirty.

Memory expansion

You can install additional memory in the computer's memory module socket to increase the amount of RAM. This section describes how to install and remove a memory module.



- *Before you install or remove a memory module, turn off the computer with the Shut Down option in the Windows Start menu. If you install or remove a memory module while the computer is in Sleep or Hibernation mode, data will be lost.*

- *Some memory modules can be physically installed but are not compatible with the computer. In this case the computer will issue a warning.*

CAUTION: *If you want to upgrade system memory, you should only use certified modules. Ask your vendor or check the TOSHIBA web site for a list of approved memory products.*



Insert the two memory modules of the same specifications and capacity into Slot A and Slot B respectively. The computer will operate in dual channel mode.

You can access the inserted memory modules efficiently in dual channel.

Installing Memory on Bottom Side



If you use the computer for a long time, the memory modules will become hot. In this case, let the memory modules cool to room temperature before you replace them.

Follow these steps to install a memory module:

1. Set the computer to boot mode and turn off the power.



Do not try to install a memory module under the following conditions. You can damage the computer and the module.

- a. *The computer is turned on.*
 - b. *The computer was shut down using the Stand by mode.*
 - c. *Power to the optical disc drive has been turned on by the CD Power switch.*
2. Remove all cables connected to the computer.
 3. Turn the computer upside down and remove the battery, refer to Chapter 6, *Power and Power-Up Modes*.
 4. Loosen the one screw securing the memory module socket cover.

- Slide your fingernail or a thin object under the cover and lift it off.

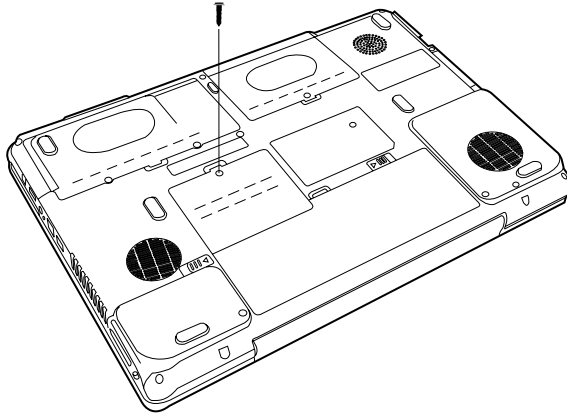

Removing the memory module socket cover

- Fit the module's connectors into the computer's connectors at about a 45 degree angle and press the module carefully to ensure a firm connection.



Do not touch the connectors on the memory module or on the computer. Debris on the connectors may cause memory access problems.

- Push the module down so it lies flat. Latches on either side will click into place to secure the module.

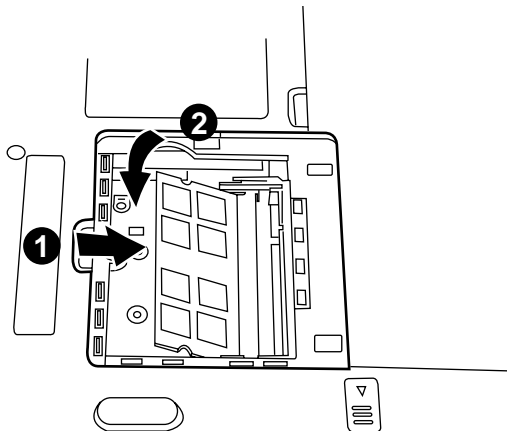

Installing a module

8. Seat the cover and secure it with the screw.
9. Replace the battery pack as described in Chapter 6, *Power and Power-Up Modes*.
10. Turn the power on and make sure the added memory is recognized.

Removing Memory on Bottom Side



If you use the computer for a long time, the memory modules will become hot. In this case, let the memory modules cool to room temperature before you replace them.

To remove the memory module, make sure the computer is in boot mode then:

1. Be sure the power is off and all cables are disconnected from the computer.



Do not try to remove a memory module with the computer turned on. You can damage the computer and the module.

2. Turn the computer upside down and remove the battery and loosen the screw securing the memory module socket cover.
3. Slide your fingernail or a thin object under the cover and lift it off.
4. Push the latches to the outside to release the module. A spring will force one end of the module up.
5. Grasp the module and pull it out.



Do not touch the connectors on the memory module or on the computer. Debris on the connectors may cause memory access problems.

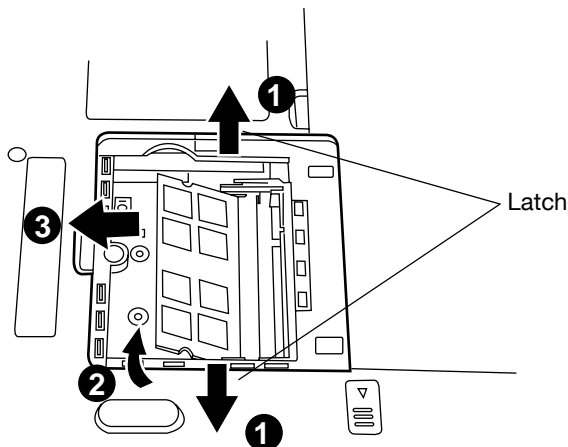

Removing the memory module

6. Seat the cover and secure its screw.
7. Replace the battery.

Additional battery pack

You can increase the portability of the computer with additional battery packs. If you're away from an AC power source and your battery runs low, you can replace it with a freshly charged battery. See Chapter 6, *Power and Power-Up Modes*.

Additional AC adapter

If you frequently carry the computer to different sites such as your home and office, having an AC adapter at each location reduces the weight and bulk of your load.

Battery charger

The battery charger provides a convenient way to charge battery packs without requiring the use of your computer. The battery charger holds up to two battery packs (lithium ion).

External monitor

An external analog monitor can be connected to the external monitor port on the computer.

To connect a monitor, follow the steps below.

1. Turn the computer off.
2. Connect the monitor to the external monitor port.
3. Turn the monitor's power on.
4. Turn the computer on.

When you turn on the power, the computer automatically recognizes the monitor.

To change the display settings, press **Fn + F5**. If you disconnect the monitor before you turn the computer off, be sure to press **Fn + F5** to switch to the internal display. Refer to Chapter 5, *The Keyboard*, for details on using hot keys to change the display settings.

Television

A television can be connected to the video out port on the computer. To connect a television, follow the steps below.

1. Turn the computer off.
2. Use a video cable (not supplied) to connect the television to the video out port.
3. Turn the television on.
4. Turn the computer on.

You can use the hotkeys **Fn + F5** or use the **TV-Out** button to change the display device. Refer to Chapter 5, *The Keyboard*.

If a television is connected to the computer, set the TV type in Display Properties. Follow the steps below, based on the configuration of your computer:

For Intel

1. Click **Start >Control Panel >Appearance and Personalization > Personalization**.
2. Choose **Display settings**.



- Click the **Advanced Settings** button. The **(Multiple Monitors) and Mobile Intel® 945GM/943GML Express Chips Family** dialogue box opens.

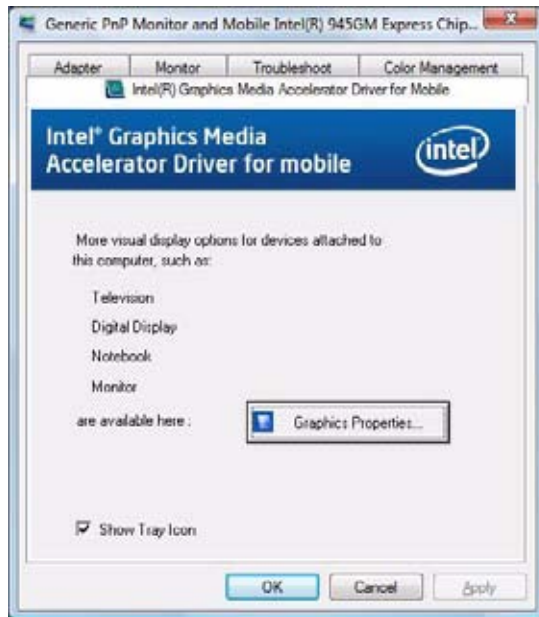

- Click the **Graphics Properties** button.



- In the subsequent dialogue box, click **Display Devices** and then set up your television and notebook displays.

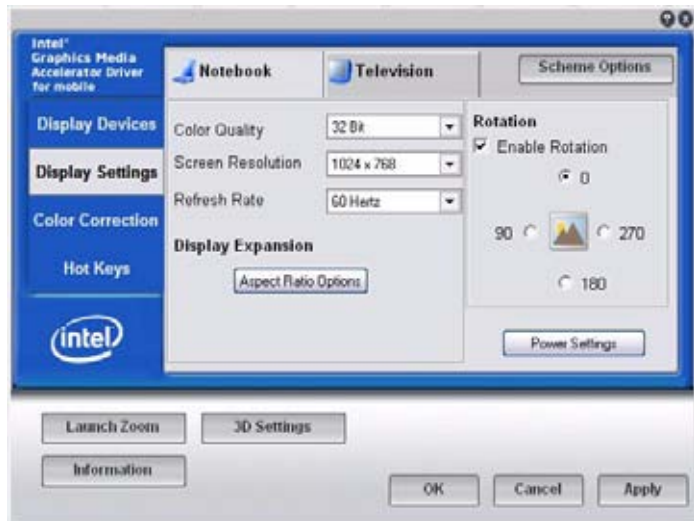

For nVidia

- Click **Start > Control Panel > Appearance and Personalization > Personalization**.
- Choose **Display Settings**.



3. Click the **Advanced Settings** button. The **Generic PnP Monitor and NVIDIA GeForce Go 7600 Properties** dialogue box opens.



4. Click **Start the NVIDIA Control Panel**.

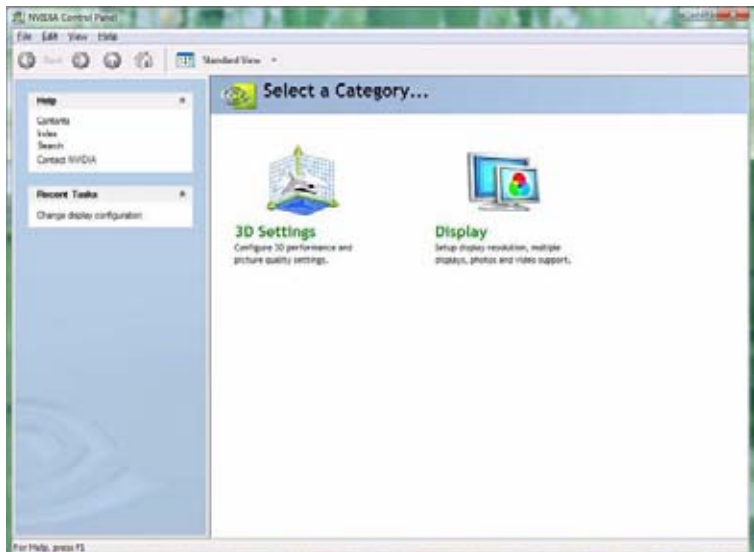

5. Click **Display** item.

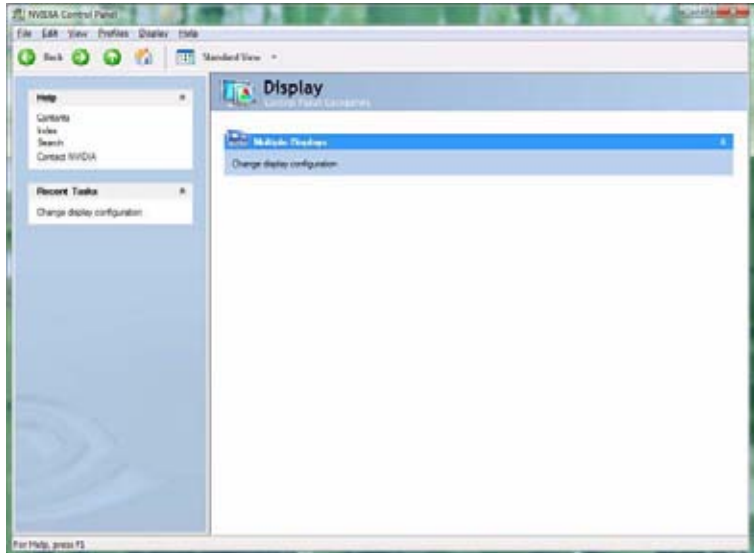

6. Click **Change Display Configuration** item.

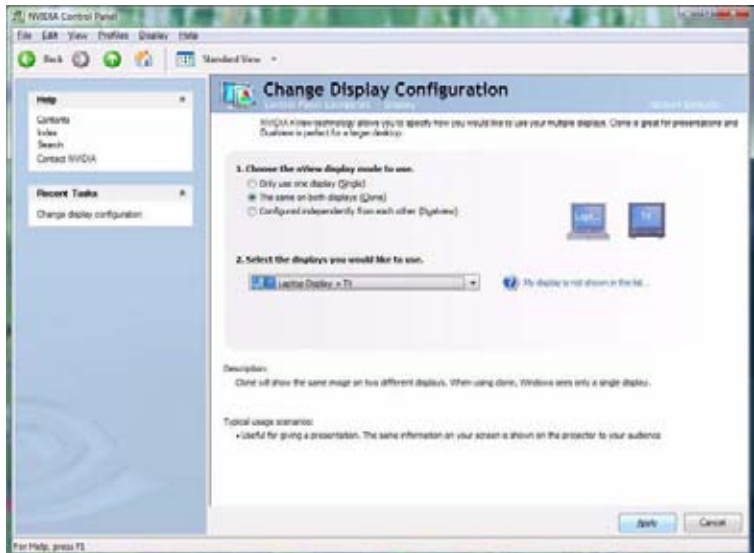

7. Setup your television and notebook display.

i.LINK (IEEE1394a)

i.LINK (IEEE1394a) is used for high-speed data transfer for a range of compatible devices such as:

- Digital video cameras
- Hard disk drives
- MO drives
- Optical disc drives



i.LINK uses a four-pin connector, which does not carry electric current. External devices will need their own power supply.

Precautions

- Make a back-up of your data before transferring it to the computer. There is a possibility that the original data will be damaged. There is a particular risk that some frames will be deleted in the case of digital video transfer.
- Do not transfer data in areas where static electricity is easily generated or in areas subjected to electronic noise. Data can be destroyed.
- If you are transferring data through an IEEE1394a hub, do not connect or disconnect other devices from the hub during data transfer. There is a likelihood that data will be damaged. Connect all devices to the hub before you turn on the computer's power.

Connecting

1. Make sure the connectors are properly aligned and plug the i.LINK (IEEE1394a) cable into the computer.
2. Plug the other end of the cable into the device.

Note the following when you use i.LINK:

- You may need to install drivers for your i.LINK devices.
- Not all i.LINK devices have been tested. Therefore, compatibility with all i.LINK devices cannot be guaranteed.
- Use S100, S200 or S400 cables no longer than three meters.
- Some devices might not support Sleep or automatic off functions.
- Do not connect or disconnect an i.LINK device while it is using an application or when the computer is automatically shutting it down to save power. Data might be destroyed.

Disconnecting

1. Click the **Safely Remove Hardware** icon on the Task Bar.
2. Point to **i.LINK (IEEE1394a) device** and click.
3. Disconnect the cable from the computer then from the i.LINK device.



Refer also to the documentation that came with your i.LINK device.

Security lock

A security lock enables you to anchor your computer to a desk or other heavy object to help prevent unauthorized removal of the computer.

Attach one end of a cable to the desk and the other end to the security lock slot on the right side of the computer.

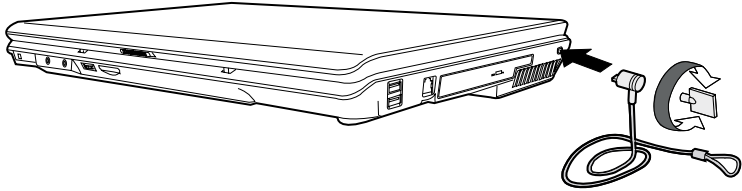

Security lock

Troubleshooting

TOSHIBA designed the computer for durability. However, should problems occur, following the procedures in this chapter can help to determine the cause.

All readers should become familiar with this chapter. Knowing what might go wrong can help prevent problems from occurring.

Problem solving process

Resolving problems will be much easier if you observe the following guidelines:

- Stop immediately when you recognize a problem exists. Further action may result in data loss or damage. You may destroy valuable problem-related information that can help solve the problem.
- Observe what is happening. Write down what the system is doing and what actions you performed immediately before the problem occurred. If you have a printer attached, print a copy of the screen using PrtSc.
- Isolate the problem. Using the tools available to you, such as the troubleshooting tips in this chapter, try to discover the specific actions that caused the problem.

The questions and procedures offered in this chapter are meant as a guide, they are not definitive problem solving techniques. Many problems can be solved simply, but a few may require help from your dealer. If you find you need to consult your dealer or others, be prepared to describe the problem in as much detail as possible.

Preliminary checklist

Consider the simplest solution first. The items in this checklist are easy to fix and yet can cause what appears to be a serious problem.

- Make sure you turn on all peripheral devices before you turn on the computer.
This includes your printer and any other external device you are using.
- Before you attach an external device, turn the computer off. When you turn the computer back on it recognizes the new device.
- Make sure all options are set properly in the setup program.
- Check all cables. Are they correctly and firmly attached? Loose cables can cause signal errors.
- Inspect all connecting cables for loose wires and all connectors for loose pins.
- Check that the optical disc drive is correctly inserted.

Make notes of your observations and keep them in a permanent error log. This will help you describe your problems to your dealer. If a problem recurs, the log will help you identify the problem faster.

Analyzing the problem

Sometimes the system gives clues that can help you identify why it is malfunctioning. Keep the following questions in mind:

- Which part of the system is not operating properly: keyboard, disk drives, hard disk drive, printer, display. Each device produces different symptoms.
- Is the operating system configuration set properly? Check the configuration options.
- What appears on the display screen? Does it display any messages or random characters? Print a copy of the screen if you have a printer attached. Look up the messages in the software and operating system documentation. Check that all connecting cables are correctly and firmly attached. Loose cables can cause erroneous or intermittent signals.
- Do any indicators light? Which ones? What color are they? Do they stay on or blink? Write down what you see.
- Do you hear any beeps? How many? Are they long or short? Are they high pitched or low? Is the computer making any unusual noises? Write down what you hear.

Record your observations so you can describe them to your dealer.

Software	<p>The problems may be caused by your software. If you cannot load a software package, the media may be damaged or the program might be corrupted. Try loading another copy of the software.</p> <p>If an error message appears while you are using a software package, check the software documentation. These documents usually include a problem solving section or a summary of error messages.</p> <p>Next, check any error messages in the operating system documentation.</p>
Hardware	<p>If you cannot find a software problem, check your hardware. First run through the items in the preliminary checklist above. If you still cannot correct the problem, try to identify the source. The next section provides checklists for individual components and peripherals.</p>

Hardware and system checklist

This section discusses problems caused by your computer's hardware or attached peripherals. Basic problems may occur in the following areas:

- System start-up
- Self test
- Power
- Battery
- Keyboard
- LCD panel
- Hard disk drive
- Password
- i.LINK (IEEE1394)
- Wireless LAN
- Monitor
- Sound system
- Pointing Device
- USB
- TV output signal
- LAN
- Sleep/Hibernation
- Memory expansion
- Modem
- CD-RW/DVD-ROM drive
- DVD Super Multi drive with double layer disc recording support
- Disk drive
- Real Time Clock
- Fingerprint Sensor
- Web Camera

System start-up

When the computer does not start properly, check the following items:

- Self Test
- Power Sources
- Power-on Password

Self test

When the computer starts up, the self test will be run automatically, and the following will be displayed:



(This screen image is one of the examples. You may see the different screen image depending on the model you purchased.)

This message remains on the screen for a few seconds.

If the self test is successful, the computer tries to load the operating system based around how the Boot Priority option is set within the computer's BIOS setup.

If any of the following conditions are present, the self test failed:

- The computer stops and does not proceed to display information or messages except the TOSHIBA logo.
- Random characters appear on the screen, and the system does not function normally.
- The screen displays an error message.

Turn off the computer and check all cable connections as well as memory module connections. If the test fails again, contact your dealer.

Power

When the computer is not plugged into an AC outlet, the battery pack is the primary power source. However, your computer has a number of other power resources, including an intelligent power supply and Real Time Clock battery. These resources are interrelated and any one could affect apparent power problems. This section provides check lists for AC power and the battery. If you cannot resolve a problem after following them, the cause could lie with another power resource. In such cases you should contact your dealer.

Overheating power down

If the computer's internal temperature becomes too high, the computer will automatically shut down

AC power

If you have trouble turning on the computer with the AC adapter connected, check the **DC IN** indicator. Refer to Chapter 6, *Power and Power-Up Modes*, for more information.

Problem	Procedure
AC adapter doesn't power the computer (DC IN indicator does not glow blue).	<p>Check the connections. Make sure the cord is firmly connected to the computer and a power outlet.</p> <p>Check the condition of the cord and terminals. If the cord is frayed or damaged, replace it. If the terminals are soiled, wipe them with cotton or a clean cloth.</p> <p>If the AC adapter still does not power the computer, contact your dealer.</p>

Battery

If you suspect a problem with the battery, check the **DC IN** indicator as well as the indicators for the battery. For information on indicators and battery operation see Chapter 6, *Power and Power-Up Modes*.

Problem	Procedure
Battery doesn't power the computer.	The battery may be discharged. Connect the AC power cord to charge the battery.
Battery doesn't charge when the AC power cord is attached. (Battery indicator does not glow amber.)	<p>If the battery is completely discharged, it will not begin charging at once. Wait a few minutes.</p> <p>If the battery still does not charge, make sure the outlet is supplying power. Plug in an appliance and see if it works. If it doesn't, try another power source.</p> <p>Check whether the battery is hot or cold. If the battery is too hot or too cold, it will not charge properly. Let it reach room temperature.</p> <p>Unplug the AC adapter and remove the battery to make sure the terminals are clean. If necessary wipe them with a soft dry cloth dipped in alcohol.</p> <p>Connect the AC adapter and replace the battery.</p> <p>Check the Battery indicator. If it does not glow, let the computer charge the battery for at least 20 minutes. If the Battery indicator glows after 20 minutes, let the battery continue to charge for at least another 20 minutes before turning on the computer.</p> <p>If the indicator still does not glow, the battery may be at the end of its operating life. Replace it.</p> <p>If you do not think the battery is at the end of its operating life, see your dealer.</p>
Battery doesn't power the computer as long as expected.	Check the power consumption settings in the Power Options. Consider using a power saving mode.

Keyboard

Keyboard problems can be caused by your setup configuration. For more information refer to Chapter 5, *The Keyboard*.

Problem	Procedure
Some letter keys produce numbers.	Check that the numeric keypad overlay is not selected. Press Fn + F10 and try typing again.
Output to screen is garbled.	Make sure the software you are using is not remapping the keyboard. Remapping involves reassigning the meaning of each key. See your software's documentation. If you are still unable to use the keyboard, consult your dealer.

LCD panel

Problem	Procedure
Lines appear broken.	Check if you are in DOS mode. In DOS, lines may appear broken, because of the LCD screen's higher resolution. The Windows display should appear normal.
No display	Press the Hotkey Fn + F5 to change the display priority and ensure it is not set for an external monitor. Make sure instant security was not activated. Try entering your password, if you have one registered. Or, turn the power off and back on to clear instant security .
Problems above remain unresolved or other problems occur.	Refer to your software's documentation to determine if the software is causing the difficulty. Contact your dealer if the problems continue.

Hard disk drive

Problem	Procedure
Computer does not boot from hard drive.	<p>Insert a system disk and reboot.</p> <p>There may be a problem with your operating system files. Refer to your operating system documentation.</p>
Slow performance	<p>Your files may be fragmented. Run SCANDISK and defragmenter to check the condition of your files and disk. Refer to your operating system documentation or online HELP for information on running SCANDISK and the defragmenter.</p> <p>Contact your dealer if the problems continue.</p>

Password

Problem	Procedure
Cannot enter password	Refer to Chapter 6, <i>Power and Power-Up Modes</i> .

i.LINK (IEEE1394)

Problem	Procedure
i.LINK device does not function	<p>Make sure the cable is securely connected to the computer and to the device.</p> <p>Make sure the device's power is turned on.</p> <p>Reinstall the drivers. Open the Windows Control Panel and double-click the Add New Hardware icon. Follow the on-screen directions.</p> <p>Restart Windows.</p> <p>If problems persist, contact your dealer.</p>

Wireless LAN

If the following procedures do not restore LAN access, consult your LAN administrator. For more information on wireless communication, refer to Chapter 4, *Operating Basics*.

Problem	Procedure
Cannot access Wireless LAN	<p>Make sure the computer's wireless communication switch is set to on.</p> <p>Use the ConfigFree program that comes pre-installed in your computer to see LAN status.</p> <p>If problems persist, consult your LAN administrator.</p>

Monitor

Refer also to Chapter 8, *Optional Devices*, and to your monitor's documentation.

Problem	Procedure
Monitor does not turn on	<p>Make sure that the external monitor's power switch is on. Confirm that the external monitor's power cable is plugged into a working power outlet.</p>
No display	<p>Try adjusting the contrast and brightness controls on the external monitor.</p> <p>Press hotkeys Fn + F5 to change the display priority and make sure it is not set for the internal display.</p>
Display error occurs	<p>Check that the cable connecting the external monitor to the computer is attached firmly.</p> <p>If problems persist, contact your dealer.</p>
Monitor goes into panning mode	<p>Check your monitor specification. It might not support the selected resolution and refresh rate. The resolution on the monitor might go into panning mode when wide screen resolution is selected. Refer to Appendix B, <i>Display Modes</i>.</p>

Sound system

Problem	Procedure
No sound is heard	<p>Adjust the volume control dial.</p> <p>Check the software volume settings.</p> <p>If appropriate, make sure the headphone connection is secure. Check Windows Device Manager and ensure the sound function is enabled and that settings for I/O address, interrupt level and DMA are correct for your software and do not conflict with other hardware devices that you have connected to the computer.</p> <p>If problems persist, contact your dealer.</p>

Pointing device

If you are using a USB mouse, also refer to the *USB* section in this chapter and to your mouse documentation.

TouchPad/Dual Mode Pad

Problem	Procedure
On-screen pointer does not respond to Pad operation	<p>The system might be busy. If the pointer is shaped as an hourglass, wait for it to resume its normal shape and try again to move it. You may also press Fn + F9 to enable the TouchPad/Dual Mode Pad and then try again to move it.</p>
Double-tapping does not work	<p>Try changing the double-click speed setting in the mouse control utility.</p> <ol style="list-style-type: none"> 1. Open the Control Panel, select the Mouse icon and press Enter. 2. Click the Buttons tab. 3. Set the double-click speed as instructed and click OK.
The mouse pointer moves too fast or too slow	<p>Try changing the speed setting in the mouse control utility.</p> <ol style="list-style-type: none"> 1. Open the Control Panel, select the Mouse icon and press Enter. 2. Click the Pointer Options tab. 3. Set the speed as instructed and click OK. <p>If problems persist, contact your dealer.</p>

USB mouse

Problem	Procedure
On-screen pointer does not respond to mouse movement	<p>The system might be busy. If the pointer is shaped as an hourglass, wait for it to resume its normal shape and try again to move it.</p> <p>Make sure the mouse is properly connected to the USB port.</p>
Double-clicking does not work	<p>Try changing the double-click speed setting in the mouse control utility.</p> <ol style="list-style-type: none"> 1. Open the Control Panel, select the Mouse icon and press Enter. 2. Click the Buttons tab. 3. Set the double-click speed as instructed and click OK.
The mouse pointer moves too fast or too slow	<p>Try changing the speed setting in the mouse control utility.</p> <ol style="list-style-type: none"> 1. Open the Control Panel, select the Mouse icon and press Enter. 2. Click the Pointer Options tab. 3. Set the speed as instructed and click OK.
The mouse pointer moves erratically	<p>The mouse might be dirty. Refer to your mouse documentations for instructions on cleaning.</p> <p>If problems persist, contact your dealer.</p>

USB

Refer also to your USB device's documentation.

Problem	Procedure
USB device does not work	<p>Check for a firm cable connection between the USB ports on the computer and the USB device.</p> <p>Make sure the USB device drivers are properly installed. Refer to your Windows documentation for information on checking the drivers.</p> <p>If problems persist, contact your dealer.</p>

TV output signal

Problem	Procedure
Display on TV is poor	Make sure the TV type is correct for your area: NTSC (US) or PAL (Europe).
No display	Try adjusting the contrast and brightness controls on the external monitor. Press hotkeys Fn + F5 to change the display. Refer to Chapter 5, <i>The Keyboard</i> . If problems persist, contact your dealer.



If you turn the computer off in Sleep Mode while the display is on a TV, the computer will select either the internal LCD or an external computer CRT as the display device the next time it is switched on.

LAN

Problem	Procedure
Cannot access LAN or the Wake up on LAN feature does not work	Check for a firm cable connection between the LAN hub. Make sure the AC adapter is connected. You cannot access a LAN using the computer's battery power. If problems persist, consult your LAN administrator.

Sleep/Hibernation

Problem	Procedure
The system will not enter Sleep/Hibernation	Is Windows Media Player open? The system might not enter Sleep/Hibernation, if Windows Media Player is either playing a selection or finished playing a selection. Close Windows Media Player before you select Sleep/Hibernation. If problems persist, contact your dealer.

Memory expansion

Refer also to Chapter 8, *Optional Devices*, for information on installing memory modules.

Problem	Procedure
The computer hangs up and issues beep sounds. (A long beep, three short beeps, three short beeps, and then a long beep.)	<p>Make sure the memory module installed in the expansion slot is compatible with the computer.</p> <p>If an incompatible module has been installed, follow the steps below.</p> <ol style="list-style-type: none"> 1. Turn off the power. 2. Disconnect the AC adapter and all peripheral devices. 3. Remove the battery pack. 4. Remove the memory module. 5. Replace the battery pack and/or connect the AC adapter. 6. Turn on the power. <p>If problems persist, contact your dealer.</p>

Modem

Problem	Procedure
Communication software can't initialize the modem	Make sure the computer's internal modem settings are correct. Refer to Phone and Modem Options Properties in the Control Panel.
You can hear a dial tone but can't make a call	If the call is going through a PBX machine, make sure the communication application's tone dial detection feature is disabled.
You place a call, but a connection can't be made	Make sure the settings are correct in your communications application.
After making a call you can't hear a ring	Make sure the tone or pulse selection in your communications application is set correctly.
Communication is cut off unexpectedly	The computer will automatically cut off communication when connection with the carrier is not successful for a set time interval. Try lengthening this time interval.
A CONNECT display is quickly replaced by NO CARRIER	Check the error control setting in your communications application.

Problem	Procedure
Character display becomes garbled during a communication	In data transmission, make sure the parity bit and stop bit settings correspond with those of the remote computer. Check the flow control and communication protocol.
You cannot receive an incoming call	Check the "rings before auto answer" setting in your communications application. If problems persist, contact your dealer.

CD-RW/DVD-ROM drive

For more information, refer to Chapter 4, *Operating Basics*.

Problem	Procedure
You cannot access a disc in the drive	Make sure the drive's drawer is securely closed. Press gently until it clicks into place. Open the drawer and make sure the disc is properly seated. It should lie flat with the label facing up. A foreign object in the drawer could block laser light from reading the disc. Make sure there is no obstruction. Remove any foreign object. Check whether the disc is dirty. If it is, wipe it with a clean cloth dipped in water or a neutral cleaner. Refer to <i>Media Care</i> section in Chapter 4 for details on cleaning.
Some discs run correctly, but others do not	The software or hardware configuration may be causing a problem. Make sure the hardware configuration matches your software's needs. Check the disc's documentation. Check the type of disc you are using. The drive supports: DVD-ROM: DVD-ROM, DVD-Video CD-ROM: CD-DA, CD-Text, Photo CD™ (single/multi-session), CD-ROM Mode 1, Mode 2, CD-ROM XA Mode 2 (Form1, Form2), Enhanced CD (CD-EXTRA), CD-G (Audio CD only) Recordable: CD-R, CD-RW Check the region code on the DVD. It must match that on the CD-RW/DVD-ROM drive. Region codes are listed in the <i>optical disc</i> section in Chapter 2, <i>The Grand Tour</i> .

Problem	Procedure
Cannot write correctly	<p>If you have trouble writing, make sure you are observing the following precautions:</p> <ul style="list-style-type: none"> ■ Use only media recommended by TOSHIBA. ■ Do not use the mouse or keyboard during writing. ■ Use only the software supplied with the computer for recording. ■ Do not run or start other software during writing. ■ Do not jar the computer during writing. ■ Do not connect/ disconnect external devices or install/remove internal cards during writing. <p>If problems persist, contact your dealer.</p>

DVD Super Multi drive with double layer disc recording support

For more information, refer to Chapter 4, *Operating Basics*.

Problem	Procedure
You cannot access a disc in the drive	<p>Make sure the drive's drawer is securely closed. Press gently until it clicks into place.</p> <p>Open the drawer and make sure the disc is properly seated. It should lie flat with the label facing up.</p> <p>A foreign object in the drawer could block laser light from reading the disc. Make sure there is no obstruction. Remove any foreign object.</p> <p>Check whether the disc is dirty. If it is, wipe it with a clean cloth dipped in water or a neutral cleaner. See the <i>Media care</i> section in Chapter 4 for details on cleaning.</p>

Problem	Procedure
Some discs run correctly, but others do not	<p>The software or hardware configuration may be causing a problem. Make sure the hardware configuration matches your software's needs. Check the disc's documentation.</p> <p>Check the type of disc you are using. The drive supports:</p> <p>DVD-ROM: DVD-ROM, DVD-Video, DVD-R, DVD-RW, DVD+R, DVD+RW, DVD-RAM, DVD+R (Double Layer) , DVD-R (dual Layer)</p> <p>CD-ROM: CD-DA, CD-Text, Photo CD (single/multi-session), CD-ROM Mode 1, Mode 2, CD-ROM XA Mode 2 (Form1, Form2), Enhanced CD (CD-EXTRA), CD-G (Audio CD only)</p> <p>Check the region code on the DVD. It must match that on the DVD Super Multi drive.</p>
Cannot write correctly	<p>If you have trouble writing, make sure you are observing the following precautions:</p> <ul style="list-style-type: none"> ■ Use only media recommended by TOSHIBA. ■ Do not use the mouse or keyboard during writing. ■ Use only the software supplied with the computer for recording. ■ Do not run or start other software during writing. ■ Do not jar the computer during writing. ■ Do not connect/ disconnect external devices or install/remove internal cards during writing. <p>If problems persist, contact your dealer.</p>

Disk drive

For information on disk care refer to Chapter 4, *Operating Basics*.

Problem	Procedure
Some programs run correctly, but others do not	The software or hardware configuration may be causing a problem. Make sure the hardware configuration match's your software's needs.
You cannot access the disk drive	Try another disk. If you can access this disk, the original disk (not the disk drive) is problem. If problems persist, contact your dealer.

Real Time Clock

Problem	Procedure
The following message is displayed on the LCD: RTC battery is low or CMOS checksum is inconsistent. Press [F2] key to set Date/Time.	The RTC battery charge has become exhausted, you should set the date and time in within the BIOS setup screen through the following steps: 1. Press [F1] key. BIOS setup will boot up. 2. Press [F2] to set the date in [System Date]. 3. Press [F2] to set the time in [System Time].

Fingerprint Sensor

Problem	Procedure
Reading of the fingerprint was not successful.	Please try again using the correct posture. Refer to <i>Using the Fingerprint Sensor</i> in Chapter 4, <i>Operating Basics</i> . Try the recognition process again using another enrolled finger.
The fingerprint cannot be read due to injuries to the finger.	Try the recognition process again using another enrolled finger. If fingerprints from all the enrolled fingers cannot be read, please logon by using the keyboard to input the password for the time being. If problems persist, contact your dealer.

Problem	Procedure
Fingerprint Power on Security or Single Sign On feature cannot be enabled.	Please use TOSHIBA Password Utility to register the User Password if it was not registered.
Fingerprint Power on Security does not work	<ol style="list-style-type: none"> 1. Make sure you have enroll finger in windows account. 2. Set the User Password by using TOSHIBA Password Utility and restart the system. 3. Make sure place a checkmark in Replace the power-on and hard drive passwords with the fingerprint reader on the Protector Suite QL setting.

Web Camera

Problem	Procedure
Cannot use the Web Camera	Refer to Chapter 4, <i>Using the Web Camera</i> .

TOSHIBA support

If you require any additional help using your computer or if you are having problems operating the computer, you may need to contact TOSHIBA for additional technical assistance.

Before you call

Some problems you experience may be related to software or the operating system, it is important to investigate other sources of assistance first. Before contacting TOSHIBA, try the following:

- Review troubleshooting sections in the documentation for software and peripheral devices.
- If a problem occurs when you are running software applications, consult the software documentation for troubleshooting suggestions. Call the software company's technical support for assistance.
- Consult the dealer you purchased your computer and/or software from. They are your best sources for current information and support.

Where to write

If you are still unable to solve the problem and suspect that it is hardware related, write to TOSHIBA at the nearest location listed below:

Outside of Europe	In Europe
<p>Australia TOSHIBA (Australia) Pty, Ltd. Information Systems Division 84-92 Talavera Road, North Ryde, N.S.W. 2113 Sydney</p>	<p>Germany & Austria TOSHIBA Europe (I.E.) GmbH Geschäftsbereich, Deutschland-Österreich Hammfelddamm8, D-41460 Neuss, Germany</p>
<p>Canada TOSHIBA of Canada Ltd. 191 McNabb Street, Markham, Ontario L3R8H2</p>	<p>France TOSHIBA Systèmes France S.A. 7, Rue Ampère B.P. 131, 92804 Puteaux Cedex</p>
<p>China TOSHIBA Personal Computer & Network (Shanghai) Co. Ltd. 43F Hongkong new world tower, No. 300 Huai Hai Zhong Road Shanghai, P.R. China 20002</p>	<p>Netherlands TOSHIBA Information Systems, Benelux B.V. Rivium Boulevard 41 2909 LK Capelle a/d IJssel</p>
<p>Singapore TOSHIBA Singapore Pte. Ltd. 438B Alexandra Road #06-01 Alexandra Technopark Singapore 119968</p>	<p>Spain TOSHIBA Information Systems, ESPAÑA Parque Empresarial San Fernando Edificio Europa, la Planta, Escalera A 28830 Madrid</p>
<p>United States of America TOSHIBA America Information Systems, Inc. 9740 Irvine Boulevard Irvine, California 92 718 USA</p>	<p>United Kingdom TOSHIBA Information Systems (U.K.) Ltd. TOSHIBA Court Weybridge Business Park Addlestone Road KT15 2UL Weybridge, Surrey</p>
	<p>The Rest of Europe TOSHIBA Europe (I.E.) GmbH Hammfelddamm8, D-41460 Neuss, Germany</p>

Disclaimers

This chapter states the Disclaimer(s) information applicable to TOSHIBA computers.

CPU

Central Processing Unit (“CPU”) Performance Disclaimer.

CPU performance in your computer product may vary from specifications under the following conditions:

- use of certain external peripheral products
- use of battery power instead of AC power
- use of certain multimedia, computer generated graphics or video applications
- use of standard telephone lines or low speed network connections
- use of complex modeling software, such as high end computer aided design applications
- use of several applications or functionalities simultaneously
- use of computer in areas with low air pressure (high altitude >1,000 meters or >3,280 feet above sea level)
- use of computer at temperatures outside the range of 5 °C to 30 °C (41 °F to 86 °F) or >25 °C (77 °F) at high altitude (all temperature references are approximate and may vary depending on the specific computer model - please refer to your PC documentation or visit the Toshiba website at www.pcsupport.toshiba.com for details).

CPU performance may also vary from specifications due to design configuration.

Under some conditions, your computer product may automatically shutdown. This is a normal protective feature designed to reduce the risk of lost data or damage to the product when used outside recommended conditions. To avoid risk of lost data, always make back-up copies of data by periodically storing it on an external storage medium. For optimum performance, use your computer product only under recommended conditions. Read additional restrictions in your product documentation. Contact Toshiba technical service and support, refer to *TOSHIBA support* section in Chapter 9 *Troubleshooting* for more information.

64-Bit Computing.

64-bit processors are designed to take advantage of 32 and 64 bit computing.

64-bit computing requires that the following hardware and software requirements are met:

- 64-bit Operating System
- 64-bit CPU, Chipset and BIOS (Basic Input/Output System)
- 64-bit Device drivers
- 64-bit applications

Certain device drivers and/or applications may not be compatible with a 64-bit CPU and therefore may not function properly. A 32-bit version of the operating system is preinstalled on your computer unless explicitly stated that the operating system is 64-bit.

Memory (Main System)

Part of the main system memory may be used by the graphics system for graphics performance and therefore reduce the amount of main system memory available for other computing activities. The amount of main system memory allocated to support graphics may vary depending on the graphics system, applications utilized, system memory size and other factors. For PC's configured with 4GB of system memory, the full system memory space for computing activities will be considerably less and will vary by model and system configuration.

Battery Life

Battery life may vary considerably depending on product model, configuration, applications, power management settings and features utilized, as well as the natural performance variations produced by the design of individual components. Published battery life numbers are achieved on select models and configurations tested by Toshiba at the time of publication. Recharge time varies depending on usage. Battery may not charge while computer is consuming full power.

After going through many charge and discharge cycles, the battery will lose its ability to perform at maximum capacity and will need to be replaced. This is a normal phenomenon for all batteries. To purchase a new battery pack, see the accessories information that is shipped with your computer.

HDD Drive Capacity

1 Gigabyte (GB) means $10^9 = 1,000,000,000$ bytes using powers of 10. The computer operating system, however, reports storage capacity using powers of 2 for the definition of $1 \text{ GB} = 2^{30} = 1,073,741,824$ bytes, and therefore shows less storage capacity. Available storage capacity will also be less if the product includes one or more pre-installed operating systems, such as Microsoft Operating System and/or pre-installed software applications, or media content. Actual formatted capacity may vary.

LCD

Over a period of time, and depending on the usage of the computer, the brightness of the LCD screen will deteriorate. This is an intrinsic characteristic of LCD technology.

Maximum brightness is only available when operating in AC power mode. The screen will dim when the computer is operated on battery power and you will not be able to increase the brightness of the screen.

Graphics Processor Unit ("GPU")

Graphics processor unit ("GPU") performance may vary depending on product model, design configuration, applications, power management settings and features utilized. GPU performance is only optimized when operating in AC power mode and may decrease considerably when operating in battery power mode.

Wireless LAN

The transmission speed over the wireless LAN and the distance over which wireless LAN can reach may vary depending on surrounding electromagnetic environment, obstacles, access point design and configuration, and client design and software/hardware configurations.

[54Mbps is the theoretical maximum speed under the IEEE802.11 (a/b/g) standard.] The actual transmission speed will be lower than the theoretical maximum speed.

Non-applicable Icons

Certain notebook chassis are designed to accommodate all possible configurations for an entire product series. Therefore, please be aware that your selected model may not have all the features and specifications corresponding to all of the icons or switches shown on the notebook chassis.

Copy Protection

Copy protection technology included in certain media may prevent or limit recording or viewing of the media.

Images

All images are simulated for purposes of illustration.

LCD Brightness and Eye Strain

Your LCD display has a brightness approaching that of a TV device. We recommend that you adjust the brightness of your LCD to a comfortable level to prevent possible strain on your eyes.

Appendix A

Specifications

This appendix summarizes the computer's technical specifications.

Dimensions

399mm (W) x 288mm (D) x 46.5mm (H. Max.)

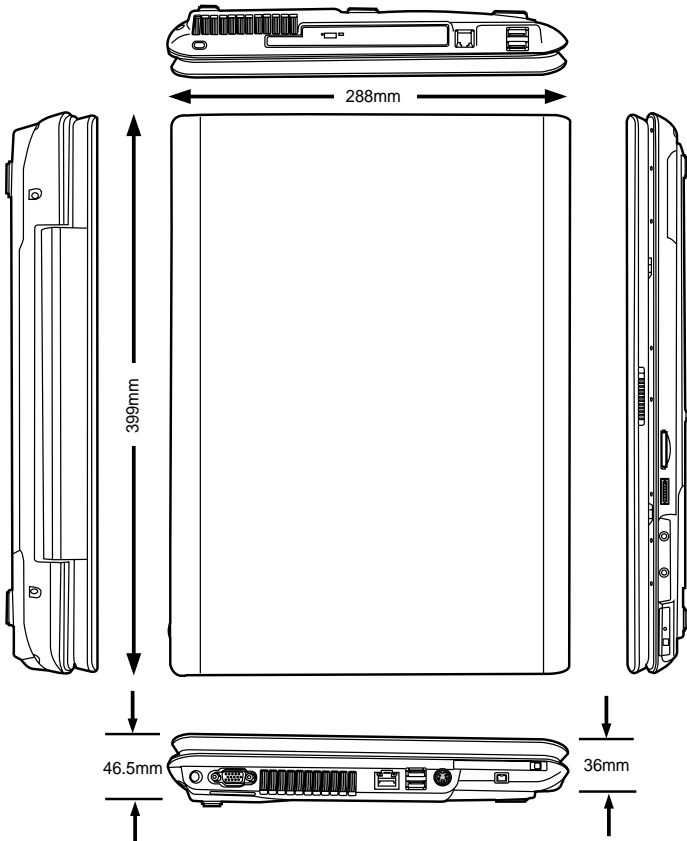

Weight

Starting at 7.2 lbs / 3.27 kg

* Weight may vary depending on product configuration, vendor components, manufacturing variability and options selected.

Environmental Requirements

Conditions	Ambient temperature	Relative humidity
Operating	5°C to 35°C	20% to 80%
Non-operating	-20°C to 65°C	
Conditions	Altitude (from sea level)	
Operating	-30 to 10,000 feet	
Non-operating	-30 to 40,000 feet	

Built-in Modem

Network control unit (NCU)		
Type of NCU	AA	
Type of line	Telephone line (analog only)	
Type of dialling	Pulse Tone	
Control command	AT commands EIA-578 commands	
Monitor function	Computer's speaker	
Communication specifications		
Communication System	Data:	Full duplex
	Fax:	Half duplex

Communication Protocol	Data:	
	ITU-T-Rec (Former CCITT)	V.21/V.22/V.22bis/ V.32/ V.32bis/V.34/ V.90/ V.92(only for USA and Canada)
	Bell	103/212A
	Fax:	
	ITU-T-Rec (Former CCITT)	V.17/V.29/V.27ter /V.21 ch2
Communication Speed	Data transmission and reception	
		300/1200/2400/4800/7200/9600/12000/14400/ 16800/19200/21600/24000/26400/28800/ 31200/ 33600 bps
	Data reception only with V.90/V.92	
		28000/29333/30666/32000/33333/34666/ 36000/37333/38666/40000/41333/42666/ 44000/45333/46666/48000/49333/50666/ 52000/53333/54666/ 56000 bps
	Fax:	
		2400/4800/7200/9600/12000/14400 bps
Error correcting	MNP class 4 and ITU-T V.42	
Data compression	MNP class 5 and ITU-T V.42bis	

Appendix B

Display Modes

This appendix contains a table listing all the display modes when the display is set to an external monitor.



If you are running some applications (for example a 3D application or video playback and so on), you may see some disturbance, flickering or frame dropping on your screen. If that occurs, adjust the resolution of display, lowering it until the screen is displayed properly. You could also disable Windows Aero™. to help correct this situation.

CRT Display Resolution	Color Depth (bit)	Refresh Rate (Hz)
800 x 600	16 bit	60, 75, 85, 100
	32 bit	60, 75, 85, 100
1024 x 768	16 bit	60, 75, 85, 100
	32 bit	60, 75, 85, 100
1280 x 800	16 bit	60
	32 bit	60
1280 x 1024	16 bit	60, 75, 85, 100
	32 bit	60, 75, 85, 100
1440 x 900	16 bit	60
	32 bit	60
1600 x 1200	16 bit	60, 75, 85, 100
	32 bit	60, 75, 85, 100
1920 x 1440	16 bit	60, 75
	32 bit	60, 75

CRT Display Resolution	Color Depth (bit)	Refresh Rate (Hz)
2048 x 1536	16 bit	60
	32 bit	60



Some of display mode might not be supported depending on the external monitor which you use.

Displaying movies on a TV or CRT

This section describes how to set up your system to display movies simultaneously on your computer's LCD and on an external TV or CRT monitor.

To connect a television, follow the steps below.

1. Turn the computer off.
2. Use a video cable (not supplied) to connect the television to the video out port.
3. Turn the television on.
4. Turn the computer on.

You can use the hotkeys **Fn + F5** or use the **TV-Out** button to change the display device. Refer to Chapter 5, *The Keyboard*.

If a television is connected to the computer, set the TV type in Display Properties. Follow the steps below, based on the configuration of your computer:

For Intel

1. Click **Start > Control Panel > Appearance and Personalization > Personalization**.
2. Choose **Display settings**.



- Click the **Advanced Setting** button. The **(Multiple Monitors) and Mobile Intel® 945GM/PM, 943GML Express Chips Family** dialogue box opens.



- Click the **Graphics Properties** button.



- In the subsequent dialogue box, click **Display Devices** and then set up your television and notebook displays.



For nVidia

- Click **Start > Control Panel > Appearance and Personalization > Personalization**.
- Choose **Display Settings**.

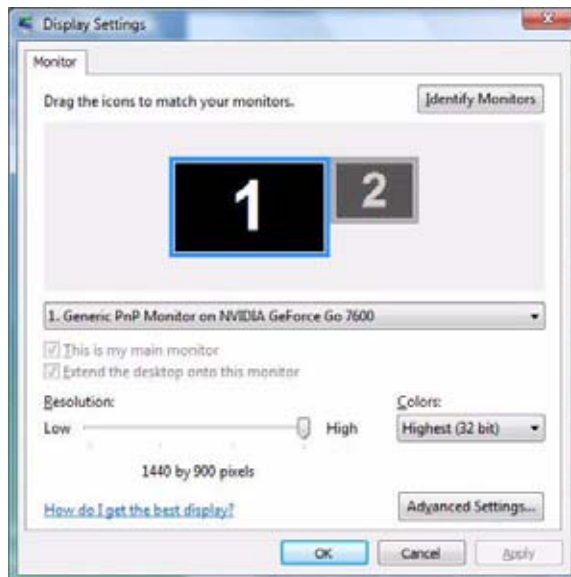

3. Click the **Advanced Settings** button. The **Generic PnP Monitor and NVIDIA GeForce Go 7600 Properties** dialogue box opens.



4. Click **Start the NVIDIA Control Panel**.

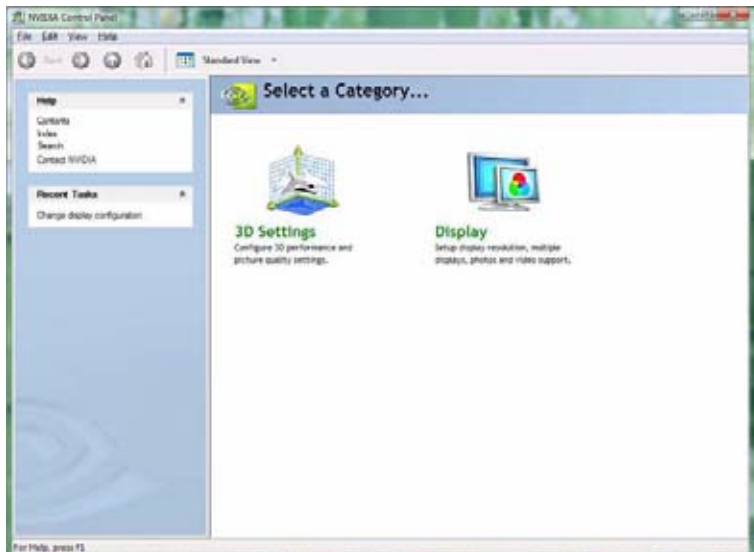

- Click **Display** item.

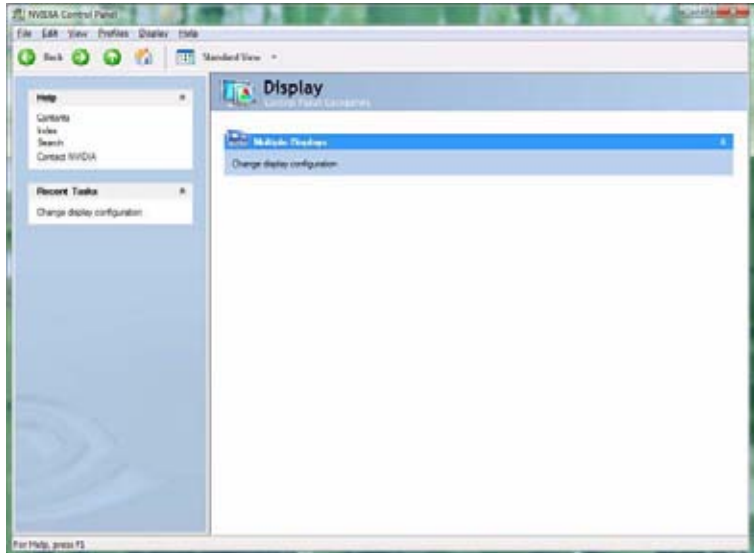

- Click **Change Display Configuration** item.

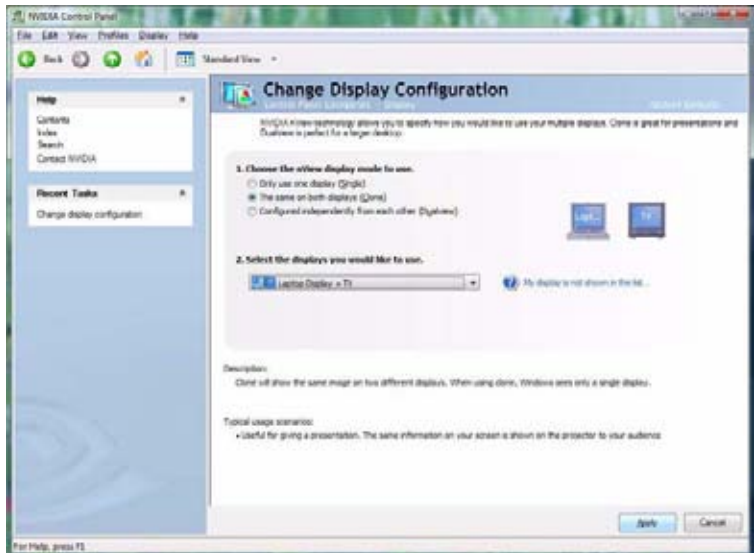

- Setup your television and notebook display.

Appendix C

AC Power Cord and Connectors

The power cord's AC input plug must be compatible with the various international AC power outlets and the cord must meet the standards for the country/region in which it is used. All cords must meet the following specifications:

Length:	Minimum 1.7 meters
Wire size:	Minimum 0.75 mm ²
Current rating:	Minimum 2.5 amperes
Voltage rating:	125 or 250 VAC (depending on country/region's power standards)

Certification agencies

U.S. and Canada:	UL listed and CSA certified No. 18 AWG, Type SVT or SPT-2		
Australia:	AS		
<i>Europe:</i>			
Austria:	OVE	Italy:	IMQ
Belgium:	CEBEC	The Netherlands:	KEMA
Denmark:	DEMKO	Norway:	NEMKO
Finland:	FIMKO	Sweden:	SEMKO
France:	LCIE	Switzerland:	SEV
Germany:	VDE	United Kingdom:	BSI

In Europe, two conductors power cord must be VDE type, H05VVH2-F or H03VVH2-F and for three conductors power cord must be VDE type, H05VV-F.

For the United States and Canada, two pin plug configuration must be a 2-15P (250V) or 1-15P (125V) and three pin plug configuration must be 6-15P (250V) or 5-15P (125V) as designated in the U. S. National Electrical code handbook and the Canadian Electrical Code Part II.

The following illustrations show the plug shapes for the U. S. A. and Canada, the United Kingdom, Australia and Europe.

USA



UL approved

United Kingdom

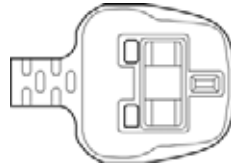

BS approved

Australia

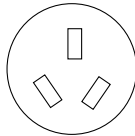

AS approved

Europe

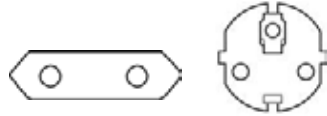

Approved by the appropriate agency

Canada



CSA approved

China

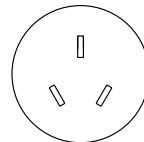

CCC approved

Glossary

The terms in this glossary cover topics related to this manual. Alternate naming is included for reference.

Abbreviations

AC: alternating current

AGP: accelerated graphics port

BIOS: basic input output system

CD-ROM: Compact Disc-Read Only Memory

CD-RW: Compact Disc-Read/Write

CMOS: complementary metal-oxide semiconductor

CPU: central processing unit

CRT: cathode ray tube

DC: direct current

DDC: display data channel

DMA: direct memory access

DOS: disk operating system

DVD: digital versatile disc

ECP: extended capabilities port

FDD: floppy disk drive

HDD: hard disk drive

IDE: integrated drive electronics

I/O: input/output

IRQ: interrupt request

KB: kilobyte

LCD: liquid crystal display

LED: light emitting diode

LSI: large scale integration

MS-DOS: Microsoft Disk Operating System

PCI: peripheral component interconnect

RAM: random access memory

ROM: read only memory

RTC: real time clock

SCSI: small computer system interface

TFT: thin-film transistor

USB: Universal Serial Bus

VESA: Video Electronic Standards Association

VGA: video graphics array

WXGA+: wide extended graphics array

A

adaptor: A device that provides an interface between two dissimilar electronic devices. For example, the AC adaptor modifies the power from a wall outlet for use by the computer. This term also refers to the add-in circuit cards that control external devices, such as video monitors and magnetic tape devices.

application: A group of programs that together are used for a specific task such as accounting, financial planning, spreadsheets, word processing and games.

B

BIOS: Basic Input Output System. The firmware that controls data flow within the computer. *See also* firmware.

bit: Derived from "binary digit," the basic unit of information used by the computer. It is either zero or one. Eight bits is one byte. *See also* byte.

boot: Short for bootstrap. A program that starts or restarts the computer. The program reads instructions from a storage device into the computer's memory.

bps: Bits per second. Typically used to describe the data transmission speed of a modem.

buffer: The portion of the computer's memory where data is temporarily stored. Buffers often compensate for differences in the rate of flow from one device to another.

bus: An interface for transmission of signals, data or electric power.

byte: The representation of a single character. A sequence of eight bits treated as a single unit; also the smallest addressable unit within the system.

C

cache memory: High speed memory which stores data that increases processor speed and data transfer rate. When the CPU reads data from main memory, it stores a copy of this data in cache memory. The next time the CPU needs that same data, it looks for it in the cache memory rather than the main memory, which saves time. The computer has two cache levels. Level one is incorporated into the processor and level two resides in external memory.

- capacity:** The amount of data that can be stored on a magnetic storage device such as a floppy disk or hard disk. It is usually described in terms of kilobytes (KB), where one KB = 1024 bytes and megabytes (MB), where one MB = 1024 KB.
- CD-ROM:** A Compact Disc-Read Only Memory is a high capacity disc that can be read from but not written to. The CD-ROM drive uses a laser, rather than magnetic heads, to read data from the disc.
- CD-R:** A Compact Disc-Recordable disc can be written once and read many times. See also CD-ROM.
- CD-RW:** A Compact Disc-Read/Write disc can be rewritten many times. See also CD-ROM.
- character:** Any letter, number, punctuation mark, or symbol used by the computer. Also synonymous with byte.
- chip:** A small semiconductor containing computer logic and circuitry for processing, memory, input/output functions and controlling other chips.
- CMOS:** Complementary Metal-Oxide Semiconductor. An electronic circuit fabricated on a silicon wafer that requires very little power. Integrated circuits implemented in CMOS technology can be tightly packaged and are highly reliable.
- compatibility:** 1) The ability of one computer to accept and process data in the same manner as another computer without modifying the data or the media upon which it is being transferred.
2) the ability of one device to connect to or communicate with another system or component.
- components:** Elements or parts (of a system) which make up the whole (system).
- configuration:** The specific components in your system (such as the terminal, printer, and disk drives) and the settings that define how your system works. You use the HW Setup program to control your system configuration.
- control keys:** A key or sequence of keys you enter from the keyboard to initiate a particular function within a program.
- controller:** Built-in hardware and software that controls the functions of a specific internal or peripheral device (e.g. keyboard controller).
- CPU:** Central Processing Unit. The portion of the computer that interprets and executes instructions.
- CRT:** Cathode Ray Tube. A vacuum tube in which beams projected on a fluorescent screen-producing luminous spots. An example is the television set.
- cursor:** A small, blinking rectangle or line that indicates the current position on the display screen.

D

DC: Direct Current. Electric current that flows in one direction. This type of power is usually supplied by batteries.

default: The parameter value automatically selected by the system when you or the program do not provide instructions. Also called a preset value.

device driver: A program that controls communication between a specific peripheral device and the computer. The CONFIG.SYS file contains device drivers that MS-DOS loads when you turn the computer on.

dialog box: A window that accepts user input to make system settings or record other information.

disk drive: The device that randomly accesses information on a disk and copies it to the computer's memory. It also writes data from memory to the disk. To accomplish these tasks, the unit physically rotates the disk at high speed past a read-write head.

display: A CRT, LCD, or other image producing device used to view computer output.

DOS: Disk Operating System. See operating system.

driver: A software program, generally part of the operating system, that controls a specific piece of hardware (frequently a peripheral device such as a printer or mouse).

DVD-RAM: A Digital Versatile Disc Random Access Memory is a high-capacity, high performance disc that lets you store large volumes of data. The DVD-ROM drive uses a laser to read data from the disc.

DVD-ROM: A Digital Versatile Disc Read Only Memory is a high capacity, high performance disc suitable for play back of video and other high-density files. The DVD-ROM drive uses a laser to read data from the disc.

E

execute: To interpret and execute an instruction.

F

floppy disk: A removable disk that stores magnetically encoded data.

floppy disk drive (FDD): An electromechanical device that reads and writes to floppy disks.

folder: An icon in Windows used to store documents or other folders.

format: The process of readying a blank disk for its first use. Formatting establishes the structure of the disk that the operating system expects before it writes files or programs onto the disk.

function keys: The keys labeled **F1** through **F12** that tell the computer to perform certain functions.

G

gigabyte (GB): A unit of data storage equal to 1024 megabytes. *See also* megabyte.

graphics: Drawings, pictures, or other images, such as charts or graphs, to present information.

H

hard disk: A non-removable disk usually referred to as drive C. The factory installs this disk and only a trained engineer can remove it for servicing. Also called fixed disk.

hard disk drive (HDD): An electromechanical device that reads and writes a hard disk. *See also* hard disk.

hertz: A unit of wave frequency that equals one cycle per second.

hot key: The computer's feature in which certain keys in combination with the extended function key, **Fn**, can be used to set system parameters, such as speaker volume.

I

input: The data or instructions you provide to a computer, communication device or other peripheral device from the keyboard or external or internal storage devices. The data sent (or output) by the sending computer is input for the receiving computer.

I/O: Input/output. Refers to acceptance and transfer of data to and from a computer.

I/O devices: Equipment used to communicate with the computer and transfer data to and from it.

J

jumper: A small clip or wire that allows you to change the hardware characteristics by electrically connecting two points of a circuit.

K

K: Taken from the Greek word kilo, meaning 1000; often used as equivalent to 1024, or 2 raised to the 10th power. *See also* byte and kilobyte.

KB: *See* kilobyte.

L

Light Emitting Diode (LED): A semiconductor device that emits light when a current is applied.

Liquid Crystal Display (LCD): Liquid crystal sealed between two sheets of glass coated with transparent conducting material. The viewing-side coating is etched into character forming segments with leads that extend to the edge of the glass. Applying a voltage between the glass sheets alters the brightness of the liquid crystal.

LSI: Large Scale Integration.

- 1) A technology that allows the inclusion of up to 100,000 simple logic gates on a single chip.
- 2) An integrated circuit that uses large scale integration.

M

megabyte (MB): A unit of data storage equal to 1024 kilobytes. See also kilobyte.

mode: A method of operation, for example, the boot mode, Sleep mode or the hibernation mode.

modem: Derived from modulator/demodulator, a device that converts (modulates) digital data for transmission over telephone lines and then converts modulated data (demodulates) to digital format where received.

monitor: A device that uses rows and columns of pixels to display alphanumeric characters or graphic images. See also CRT.

MP3: An audio compression standard that enables high-quality transmission and real-time playback of sound files.

N

numeric keypad overlay: A feature that allows you to use certain keys on the keyboard to perform numeric entry, or to control cursor and page movement.

O

operating system: A group of programs that controls the basic operation of a computer. Operating system functions include interpreting programs, creating data files, and controlling the transmission and receipt (input/output) of data to and from memory and peripheral devices.

output: The results of a computer operation. Output commonly indicates data.

- 1) printed on paper, 2) displayed at a terminal, 3) sent through the serial port of internal modem, or 4) stored on some magnetic media.

P

- parity:** 1) The symmetrical relationship between two parameter values (integers) both of which are either on or off; odd or even; 0 or 1.
2) In serial communications, an error detection bit that is added to a group of data bits making the sum of the bits even or odd. Parity can be set to none, odd, or even.
- peripheral device:** An I/O device that is external to the central processor and/or main memory such as a printer or a mouse.
- pixel:** A picture element. The smallest dot that can be made on a display or printer. Also called a pel.
- plug and play:** A capability with Windows that enables the system to automatically recognize connections of external devices and make the necessary configurations in the computer.
- port:** The electrical connection through which the computer sends and receives data to and from devices or other computers.
- prompt:** A message the computer provides indicating it is ready for or requires information or an action from you.

R

- Random Access Memory (RAM):** High speed memory within the computer circuitry that can be read or written to.
- restart:** Resetting a computer without turning it off (also called “warm boot” or “soft reset”). See *also* boot.
- RJ11:** A modular telephone jack.
- RJ45:** A modular LAN jack.
- ROM:** Read Only Memory: A nonvolatile memory chip manufactured to contain information that controls the computer’s basic operation. You cannot access or change information stored in ROM.

S

- SCSI:** Small Computer System Interface is an industry standard interface for connection of a variety of peripheral devices.
- soft key:** Key combinations that emulate keys on the IBM keyboard, change some configuration options, stop program execution, and access the numeric keypad overlay.
- stop bit:** One or more bits of a byte that follow the transmitted character or group codes in asynchronous serial communications.
- system disk:** A disk that has been formatted with an operating system. For MS-DOS the operating system is contained in two hidden files and the COMMAND.COM file. You can boot a computer using a system disk. Also called an operating system disk.

T

terminal: A typewriter-like keyboard and CRT display screen connected to the computer for data input/output.

TFT display: A liquid crystal display (LCD) made from an array of liquid crystal cells using active-matrix technology with thin film transistor (TFT) to drive each cell.

TouchPad/Dual Mode Pad: A pointing device integrated into the TOSHIBA computer palm rest.

U

Universal Serial Bus: This serial interface lets you communicate with several devices connected in a chain to a single port on the computer.

V

VGA: Video Graphics Array is an industry standard video adaptor that lets you run any popular software.

W

warm start: Restarting or resetting a computer without turning it off.

write protection: A method for protecting a floppy disk from accidental erasure.