

Dell G3 15 3500

Service Manual



Notes, cautions, and warnings

 **NOTE:** A NOTE indicates important information that helps you make better use of your product.

 **CAUTION:** A CAUTION indicates either potential damage to hardware or loss of data and tells you how to avoid the problem.

 **WARNING:** A WARNING indicates a potential for property damage, personal injury, or death.

Chapter 1: Working inside your computer	6
Before working inside your computer.....	6
Safety instructions.....	6
Electrostatic discharge—ESD protection.....	7
ESD field service kit	7
Transporting sensitive components.....	8
After working inside your computer.....	8
Chapter 2: Removing and installing components	9
Recommended tools.....	9
Screw list.....	9
Major components of Dell G3 15 3500.....	10
Base cover.....	12
Removing the base cover module.....	12
Installing the base cover.....	14
Memory module.....	16
Removing the memory modules.....	16
Installing the memory module.....	17
Solid-state drive—M.2 slot one.....	17
Removing the 2230 solid-state drive in M.2 slot one.....	17
Installing the 2230 solid-state drive in M.2 slot one.....	18
Removing the 2280 solid-state drive/Intel Optane memory module in M.2 slot one.....	20
Installing the 2280 solid-state drive/Intel Optane memory module in M.2 slot one.....	20
Solid-state drive—M.2 slot two.....	21
Removing the 2280 solid-state drive/Intel Optane memory module in M.2 slot two.....	21
Installing the 2280 solid-state drive/Intel Optane memory module in M.2 slot two.....	22
Hard drive.....	23
Removing the hard drive.....	23
Installing the hard drive.....	25
Left fan.....	26
Removing the left fan.....	26
Installing the left fan.....	27
Right fan.....	28
Installing the right fan.....	28
Removing the right fan.....	29
Battery.....	30
Removing the battery.....	30
Installing the battery.....	31
Wireless card.....	32
Removing the WLAN card.....	32
Installing the WLAN card.....	33
Speakers.....	35
Removing the speakers.....	35
Installing the speakers.....	35

Coin-cell battery.....	36
Removing the coin-cell battery.....	36
Installing the coin-cell battery.....	37
Power-adapter port.....	38
Removing the power-adapter port.....	38
Installing the power-adapter port.....	39
Heat sink.....	39
Removing the heat sink.....	39
Installing the heat sink.....	40
I/O board.....	42
Removing the I/O board.....	42
Installing the I/O board.....	43
Display assembly.....	44
Removing the display assembly.....	44
Installing the display assembly.....	46
System board.....	47
Removing the system board.....	47
Installing the system board.....	49
Power button with fingerprint reader.....	51
Removing the power button with fingerprint reader.....	51
Installing the power button with fingerprint reader.....	52
Touchpad.....	53
Removing the touchpad.....	53
Installing the touchpad.....	54
Palm-rest and keyboard assembly.....	55
Removing the palm-rest and keyboard assembly.....	55
Installing the palm-rest and keyboard assembly.....	56
Chapter 3: Drivers and downloads.....	57
Chapter 4: System setup.....	58
Entering BIOS setup program.....	58
Navigation keys.....	58
One time boot menu.....	58
System setup options.....	59
Updating the BIOS in Windows	66
Updating BIOS on systems with BitLocker enabled.....	67
Updating your system BIOS using a USB flash drive.....	67
Updating the Dell BIOS in Linux and Ubuntu environments.....	68
Flashing the BIOS from the F12 One-Time boot menu.....	68
System and setup password.....	69
Assigning a system setup password.....	69
Deleting or changing an existing system setup password.....	70
Clearing CMOS settings.....	70
Clearing BIOS (System Setup) and System passwords.....	70
Chapter 5: Troubleshooting.....	71
Recovering the operating system.....	71
System diagnostic lights.....	71

Enabling Intel Optane memory.....	72
Disabling Intel Optane memory.....	72
Flea power release.....	73
WiFi power cycle.....	73
Using Game Shift.....	73
Keyboard shortcuts.....	74

Chapter 6: Getting help and contacting Dell..... 77

Working inside your computer

Before working inside your computer

About this task

 **NOTE:** The images in this document may differ from your computer depending on the configuration you ordered.

Steps

1. Save and close all open files and exit all open applications.

2. Shut down your computer. Click **Start** >  **Power** > **Shut down**.

 **NOTE:** If you are using a different operating system, see the documentation of your operating system for shut-down instructions.

3. Disconnect your computer and all attached devices from their electrical outlets.

4. Disconnect all attached network devices and peripherals, such as keyboard, mouse, and monitor from your computer.

 **CAUTION:** To disconnect a network cable, first unplug the cable from your computer and then unplug the cable from the network device.

5. Remove any media card and optical disc from your computer, if applicable.

Safety instructions

Use the following safety guidelines to protect your computer from potential damage and to ensure your personal safety. Unless otherwise noted, each procedure included in this document assumes that you have read the safety information that shipped with your computer.

 **WARNING:** Before working inside your computer, read the safety information that is shipped with your computer. For more safety best practices, see the Regulatory Compliance home page at www.dell.com/regulatory_compliance.

 **WARNING:** Disconnect your computer from all power sources before opening the computer cover or panels. After you finish working inside the computer, replace all covers, panels, and screws before connecting your computer to an electrical outlet.

 **CAUTION:** To avoid damaging the computer, ensure that the work surface is flat, dry and clean.

 **CAUTION:** To avoid damaging the components and cards, handle them by their edges, and avoid touching the pins and the contacts.

 **CAUTION:** You should only perform troubleshooting and repairs as authorized or directed by the Dell technical assistance team. Damage due to servicing that is not authorized by Dell is not covered by your warranty. See the safety instructions that is shipped with the product or at www.dell.com/regulatory_compliance.

 **CAUTION:** Before touching anything inside your computer, ground yourself by touching an unpainted metal surface, such as the metal at the back of the computer. While you work, periodically touch an unpainted metal surface to dissipate static electricity which could harm internal components.

 **CAUTION:** When you disconnect a cable, pull it by its connector or its pull tab, not the cable itself. Some cables have connectors with locking tabs or thumb-screws that you must disengage before disconnecting the cable. When disconnecting cables, keep them evenly-aligned to avoid bending the connector pins. When connecting cables, ensure that the ports and the connectors are correctly oriented and aligned.

 **CAUTION:** Press and eject any installed card from the media-card reader.

 **NOTE:** The color of your computer and certain components may appear differently than shown in this document.

Electrostatic discharge—ESD protection

ESD is a major concern when you handle electronic components, especially sensitive components such as expansion cards, processors, memory DIMMs, and system boards. Very slight charges can damage circuits in ways that may not be obvious, such as intermittent problems or a shortened product life span. As the industry pushes for lower power requirements and increased density, ESD protection is an increasing concern.

Due to the increased density of semiconductors used in recent Dell products, the sensitivity to static damage is now higher than in previous Dell products. For this reason, some previously approved methods of handling parts are no longer applicable.

Two recognized types of ESD damage are catastrophic and intermittent failures.

- **Catastrophic** – Catastrophic failures represent approximately 20 percent of ESD-related failures. The damage causes an immediate and complete loss of device functionality. An example of catastrophic failure is a memory DIMM that has received a static shock and immediately generates a "No POST/No Video" symptom with a beep code emitted for missing or nonfunctional memory.
- **Intermittent** – Intermittent failures represent approximately 80 percent of ESD-related failures. The high rate of intermittent failures means that most of the time when damage occurs, it is not immediately recognizable. The DIMM receives a static shock, but the tracing is merely weakened and does not immediately produce outward symptoms related to the damage. The weakened trace may take weeks or months to melt, and in the meantime may cause degradation of memory integrity, intermittent memory errors, etc.

The more difficult type of damage to recognize and troubleshoot is the intermittent (also called latent or "walking wounded") failure.

Perform the following steps to prevent ESD damage:

- Use a wired ESD wrist strap that is properly grounded. The use of wireless anti-static straps is no longer allowed; they do not provide adequate protection. Touching the chassis before handling parts does not ensure adequate ESD protection on parts with increased sensitivity to ESD damage.
- Handle all static-sensitive components in a static-safe area. If possible, use anti-static floor pads and workbench pads.
- When unpacking a static-sensitive component from its shipping carton, do not remove the component from the anti-static packing material until you are ready to install the component. Before unwrapping the anti-static packaging, ensure that you discharge static electricity from your body.
- Before transporting a static-sensitive component, place it in an anti-static container or packaging.

ESD field service kit

The unmonitored Field Service kit is the most commonly used service kit. Each Field Service kit includes three main components: anti-static mat, wrist strap, and bonding wire.

Components of an ESD field service kit

The components of an ESD field service kit are:

- **Anti-Static Mat** – The anti-static mat is dissipative and parts can be placed on it during service procedures. When using an anti-static mat, your wrist strap should be snug and the bonding wire should be connected to the mat and to any bare metal on the system being worked on. Once deployed properly, service parts can be removed from the ESD bag and placed directly on the mat. ESD-sensitive items are safe in your hand, on the ESD mat, in the system, or inside a bag.
- **Wrist Strap and Bonding Wire** – The wrist strap and bonding wire can be either directly connected between your wrist and bare metal on the hardware if the ESD mat is not required, or connected to the anti-static mat to protect hardware that is temporarily placed on the mat. The physical connection of the wrist strap and bonding wire between your skin, the ESD mat, and the hardware is known as bonding. Use only Field Service kits with a wrist strap, mat, and bonding wire. Never use wireless wrist straps. Always be aware that the internal wires of a wrist strap are prone to damage from normal wear and tear, and must be checked regularly with a wrist strap tester in order to avoid accidental ESD hardware damage. It is recommended to test the wrist strap and bonding wire at least once per week.
- **ESD Wrist Strap Tester** – The wires inside of an ESD strap are prone to damage over time. When using an unmonitored kit, it is a best practice to regularly test the strap prior to each service call, and at a minimum, test once per week. A wrist strap tester is the best method for doing this test. If you do not have your own wrist strap tester, check with your regional office to find out if they have one. To perform the test, plug the wrist-strap's bonding-wire into the tester while it is strapped to your wrist and push the button to test. A green LED is lit if the test is successful; a red LED is lit and an alarm sounds if the test fails.

- **Insulator Elements** – It is critical to keep ESD sensitive devices, such as plastic heat sink casings, away from internal parts that are insulators and often highly charged.
- **Working Environment** – Before deploying the ESD Field Service kit, assess the situation at the customer location. For example, deploying the kit for a server environment is different than for a desktop or portable environment. Servers are typically installed in a rack within a data center; desktops or portables are typically placed on office desks or cubicles. Always look for a large open flat work area that is free of clutter and large enough to deploy the ESD kit with additional space to accommodate the type of system that is being repaired. The workspace should also be free of insulators that can cause an ESD event. On the work area, insulators such as Styrofoam and other plastics should always be moved at least 12 inches or 30 centimeters away from sensitive parts before physically handling any hardware components
- **ESD Packaging** – All ESD-sensitive devices must be shipped and received in static-safe packaging. Metal, static-shielded bags are preferred. However, you should always return the damaged part using the same ESD bag and packaging that the new part arrived in. The ESD bag should be folded over and taped shut and all the same foam packing material should be used in the original box that the new part arrived in. ESD-sensitive devices should be removed from packaging only at an ESD-protected work surface, and parts should never be placed on top of the ESD bag because only the inside of the bag is shielded. Always place parts in your hand, on the ESD mat, in the system, or inside an anti-static bag.
- **Transporting Sensitive Components** – When transporting ESD sensitive components such as replacement parts or parts to be returned to Dell, it is critical to place these parts in anti-static bags for safe transport.

ESD protection summary

It is recommended that all field service technicians use the traditional wired ESD grounding wrist strap and protective anti-static mat at all times when servicing Dell products. In addition, it is critical that technicians keep sensitive parts separate from all insulator parts while performing service and that they use anti-static bags for transporting sensitive components.

Transporting sensitive components

When transporting ESD sensitive components such as replacement parts or parts to be returned to Dell, it is critical to place these parts in anti-static bags for safe transport.

Lifting equipment

Adhere to the following guidelines when lifting heavy weight equipment:

 **CAUTION: Do not lift greater than 50 pounds. Always obtain additional resources or use a mechanical lifting device.**

1. Get a firm balanced footing. Keep your feet apart for a stable base, and point your toes out.
2. Tighten stomach muscles. Abdominal muscles support your spine when you lift, offsetting the force of the load.
3. Lift with your legs, not your back.
4. Keep the load close. The closer it is to your spine, the less force it exerts on your back.
5. Keep your back upright, whether lifting or setting down the load. Do not add the weight of your body to the load. Avoid twisting your body and back.
6. Follow the same techniques in reverse to set the load down.

After working inside your computer

About this task

 **CAUTION: Leaving stray or loose screws inside your computer may severely damage your computer.**

Steps

1. Replace all screws and ensure that no stray screws remain inside your computer.
2. Connect any external devices, peripherals, or cables you removed before working on your computer.
3. Replace any media cards, discs, or any other parts that you removed before working on your computer.
4. Connect your computer and all attached devices to their electrical outlets.
5. Turn on your computer.

Removing and installing components

Recommended tools

The procedures in this document may require the following tools:

- Phillips screwdriver #1
- Phillips screwdriver #0
- Plastic scribe

Screw list

- NOTE:** When removing screws from a component, it is recommended to note the screw type, the quantity of screws, and then place them in a screw storage box. This is to ensure that the correct number of screws and correct screw type is restored when the component is replaced.
- NOTE:** Some computers have magnetic surfaces. Ensure that the screws are not left attached to such surface when replacing a component.
- NOTE:** Screw color may vary with the configuration ordered.

Table 1. Screw list

















Component	Secured to	Screw type	Quantity	Screw image
Base cover	Palm-rest and keyboard assembly	M2 x 7	6	 <p>NOTE: Screw color may vary depending on the configuration ordered.</p>
Battery	Palm-rest and keyboard assembly	M2 x 3	2	
Solid-state drive	Solid-state drive bracket	M2 x 3	1	
Hard-drive assembly	Palm-rest and keyboard assembly	M2 x 3	3	
Hard-drive bracket	Hard-drive assembly	M3 x 3	4	
Left fan	Palm-rest and keyboard assembly	M2 x 3	2	
Right fan	Palm-rest and keyboard assembly	M2 x 3	2	
Wireless-card bracket	System board	M2 x 3	1	
Touchpad bracket	Palm-rest and keyboard assembly	M2 x 2 (big head)	7	

Table 1. Screw list (continued)

Component	Secured to	Screw type	Quantity	Screw image
Power button with fingerprint reader (optional)	Palm-rest and keyboard assembly	M2 x 3	2	
USB 3.1 Type-C port bracket	System board	M2 x 3	2	
Hinge brackets	Palm-rest and keyboard assembly	M2.5 x 5	4	
Hinge brackets	Display panel	M2.5 x 2.5 (big head)	12	
Hinge brackets	Display panel	M2 x 2.5	2	
I/O board	Palm-rest and keyboard assembly	M2 x 3	2	
System board	KB Support	M2 x 2 (big head)	2	

Major components of Dell G3 15 3500

The following image shows the major components of Dell G3 15 3500.

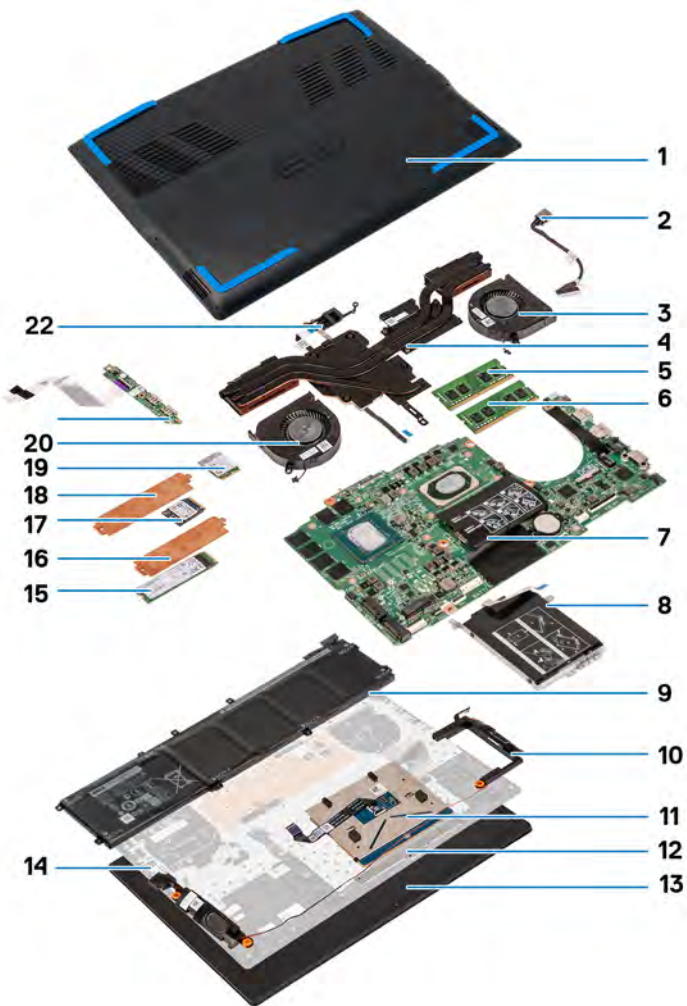

1. Base cover
2. Power-adaptor port
3. Right Fan
4. Heat sink
5. Memory module (DIMM1)
6. Memory module (DIMM2)
7. System board
8. Hard drive
9. Battery
10. Speakers
11. Touchpad
12. Touchpad bracket
13. Display assembly
14. Palm-rest and keyboard assembly
15. M.2 2280 Solid-state drive in M.2 slot two
16. Solid-state drive thermal shield
17. M.2 2230 Solid-state drive in M.2 slot one
18. Solid-state drive thermal shield
19. Wireless card
20. Left Fan
21. I/O board
22. Power button with fingerprint reader

Base cover

Removing the base cover module

Prerequisites

1. Follow the procedure in [Before working inside your computer](#).

About this task

The following image indicates the location of the base cover and provides a visual representation of the removal procedure.



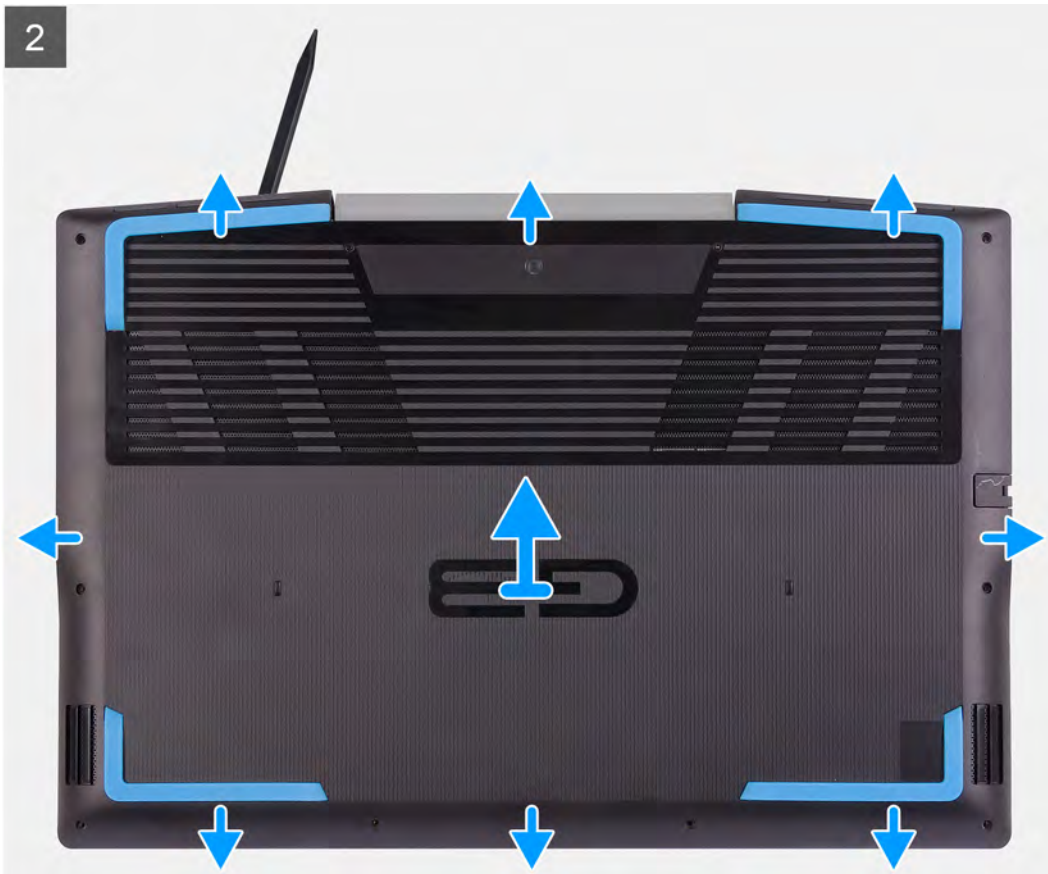

Steps

1. Loosen the four captive screws that secure the base cover to the palm-rest and keyboard assembly.
2. Remove the six screws (M2x7) that secure the base cover to the palm-rest and keyboard assembly.
3. Using a plastic scribe, pry the base cover beside the display hinges, and then continue to work on the sides to open the base cover.
4. Disconnect the battery cable from the system board.

NOTE: Disconnect the battery cable only when you are continuing to remove other components from your computer.

5. Press and hold the power button for 5 seconds to ground the computer and drain the flea power.

Installing the base cover

Prerequisites

If you are replacing a component, remove the existing component before performing the installation procedure.

About this task

The following image indicates the location of the base cover and provides a visual representation of the installation procedure.



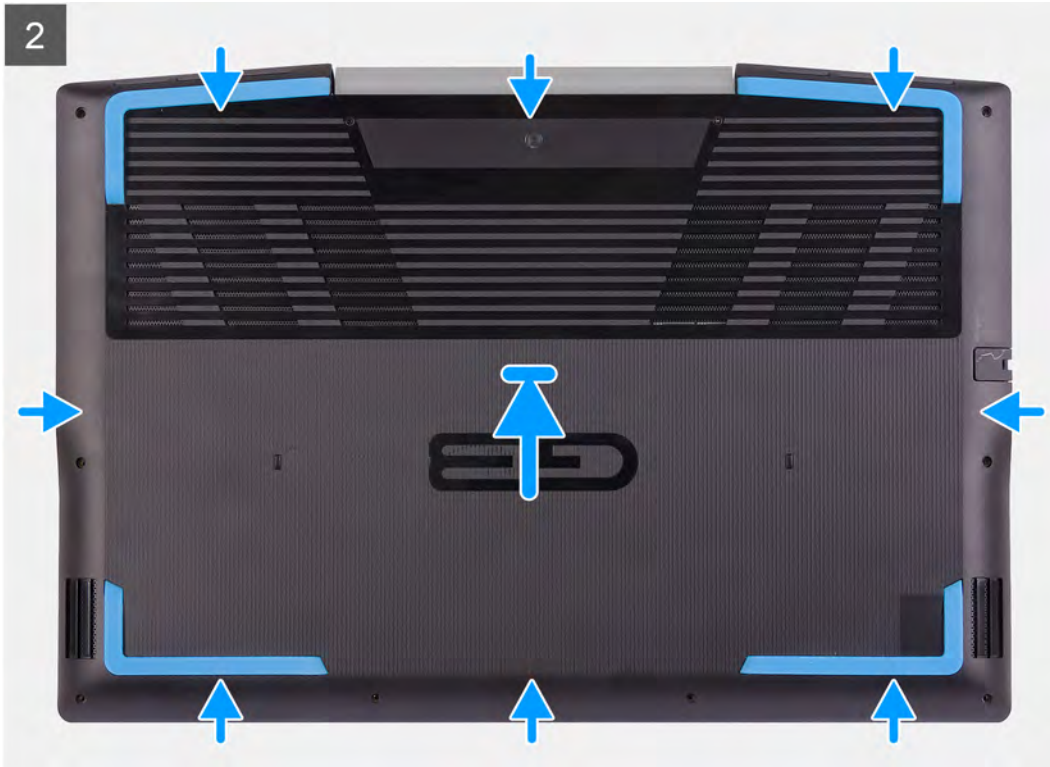

Steps

1. Connect the battery cable to the system board, if applicable.

2. Place the base cover on top of the palm-rest and keyboard assembly.
3. Align the screw holes on the base cover with the screw holes on the palm-rest and keyboard assembly, and then snap the base cover into place.
4. Tighten the four captive screws that secure the base cover to the palm-rest and keyboard assembly.
5. Replace the six (M2x7) screws that secure the base cover to the palm-rest and keyboard assembly.

Next steps

1. Follow the procedure in [After working inside your computer](#).

Memory module

Removing the memory modules

Prerequisites

1. Follow the procedure in [Before working inside your computer](#).
2. Remove the [base cover](#).

About this task

The following image indicates the location of the memory modules and provides a visual representation of the removal procedure.

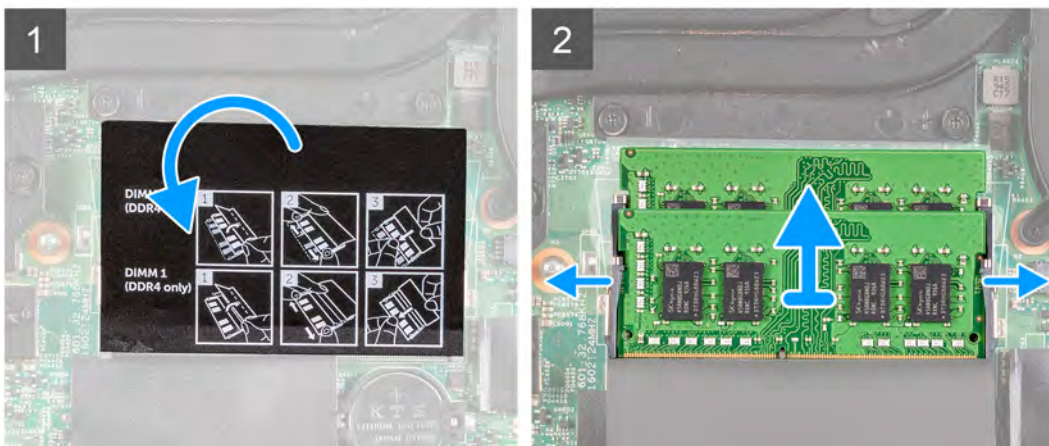
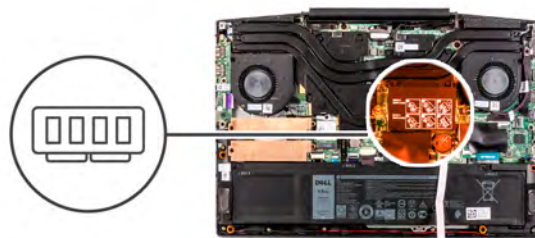

Steps

1. Lift the mylar to uncover the memory module.
2. Use your fingertips to carefully spread apart the securing-clips on each end of the memory-module slot until the memory module pops up.
3. Remove the memory module from the memory-module slot.

Installing the memory module

Prerequisites

If you are replacing a component, remove the existing component before performing the installation procedure.

About this task

The following image indicates the location of the memory module and provides a visual representation of the installation procedure.

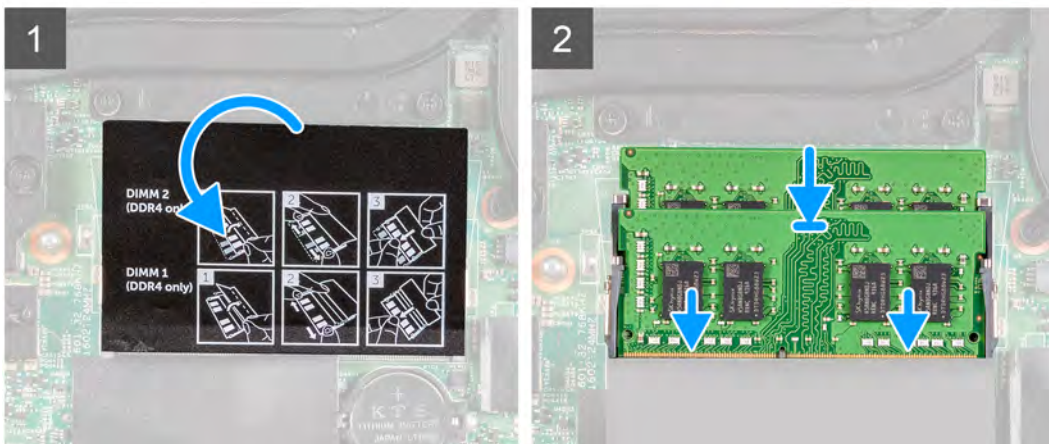
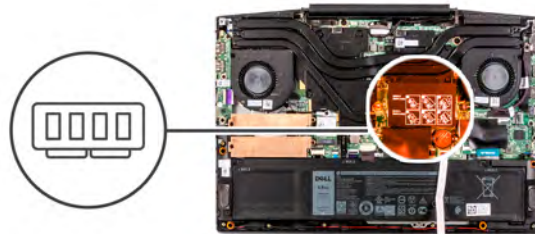

Steps

1. Lift the mylar to find the memory-module slot.
2. Align the notch on the memory module with the tab on the memory-module slot.
3. Slide the memory module firmly into the slot at an angle.
4. Press the memory module down until it clicks into place.

NOTE: If you do not hear the click, remove the memory module and reinstall it.

Next steps

1. Install the [base cover](#).
2. Follow the procedure in [After working inside your computer](#).

Solid-state drive—M.2 slot one

Removing the 2230 solid-state drive in M.2 slot one

Prerequisites

1. Follow the procedure in [Before working inside your computer](#).
2. Remove the [base cover](#).

About this task

- NOTE:** This procedure applies only to computers shipped with a 2230 solid-state drive installed in M.2 slot one.
- NOTE:** Depending on the configuration ordered, your computer may support either 2230 solid-state drive or 2280 solid-state drive in M.2 slot one.

The following image indicates the location of the 2230 solid-state drive that is installed in M.2 slot one and provides a visual representation of the removal procedure.

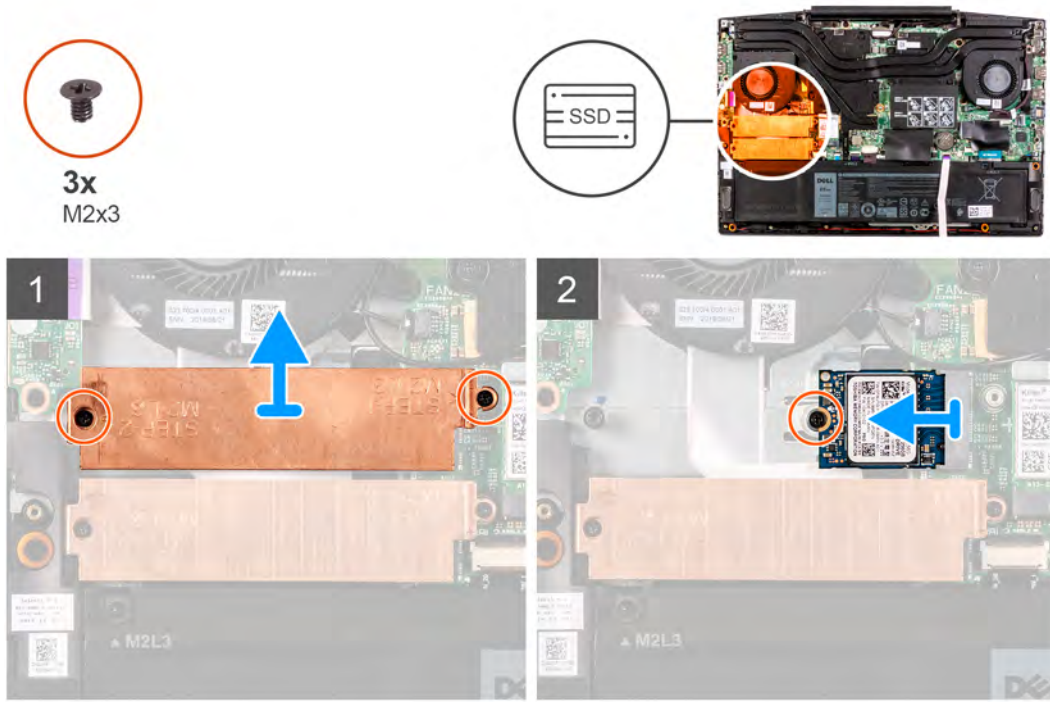

Steps

1. Remove the two screws (M2x3) that secure the solid-state drive bracket to the system board and the palm-rest and keyboard assembly.
2. Lift the solid-state drive bracket off the palm-rest and keyboard assembly.
3. Remove the screw (M2x3) that secures the solid-state drive bracket to the palm-rest and keyboard assembly.
4. Slide and lift the solid-state drive off the SSD1 slot on the system board.

Installing the 2230 solid-state drive in M.2 slot one

Prerequisites

If you are replacing a component, remove the existing component before performing the installation procedure.

About this task

- NOTE:** This procedure applies only to computers shipped with a 2230 solid-state drive installed in M.2 slot one.
- NOTE:** Depending on the configuration ordered, your computer may support either 2230 solid-state drive or 2280 solid-state drive in M.2 slot one.
- NOTE:** Install the solid-state drive mounting bracket, if it is not installed.

The following image indicates the location of the 2230 solid-state drive that is installed in M.2 slot one and provides a visual representation of the installation procedure.



3x
M2x3

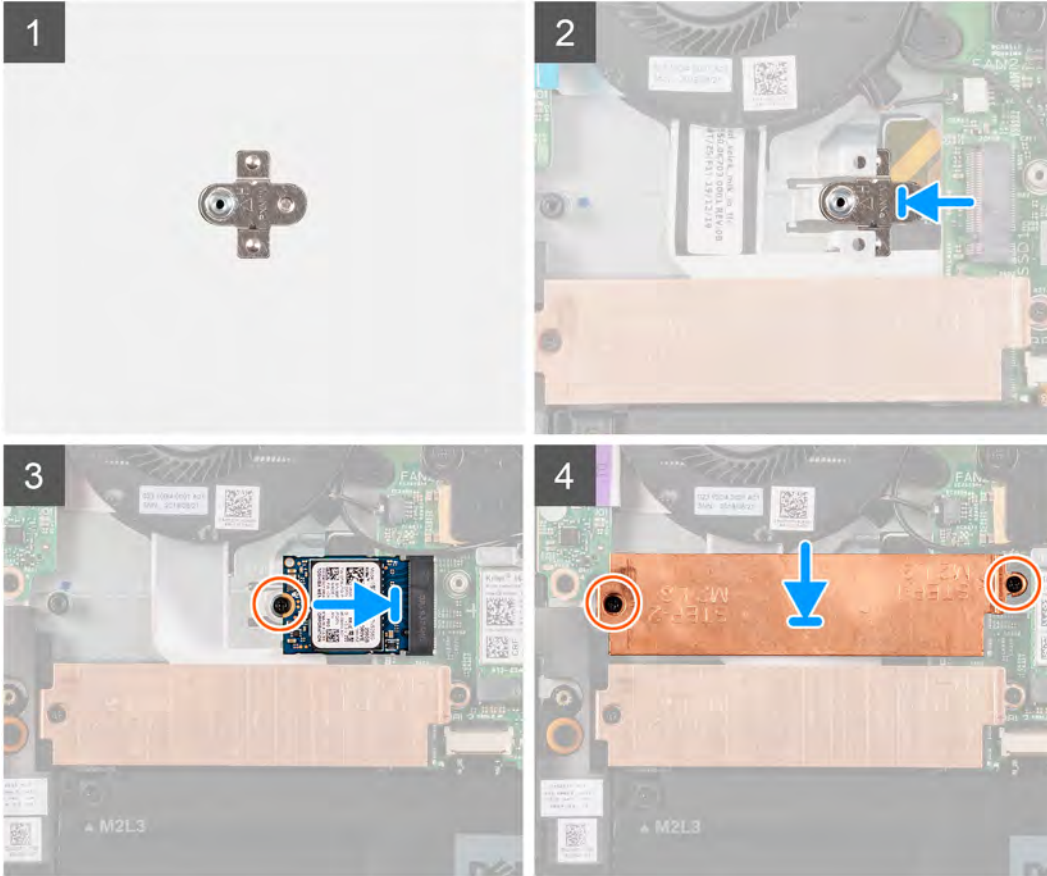

Steps

1. Slide the solid-state drive mounting bracket into the slot on the palm-rest assembly, if it is not installed.
2. Align the notches on the solid-state drive with the SSD1 slot on the system board.
3. Slide the solid-state drive into the SSD1 slot on the system board.
4. Replace the screw (M2x3) that secures the solid-state drive to the palm-rest and keyboard assembly.
5. Place the solid-state drive bracket on the solid-state drive.
6. Align the screw holes on the solid-state drive bracket with the screw holes on the system board and the palm-rest and keyboard assembly.
7. Replace the two screws (M2x3) that secure the solid-state drive bracket to the system board and the palm-rest and keyboard assembly.

Next steps

1. Install the [base cover](#).
2. Follow the procedure in [After working inside your computer](#).

Removing the 2280 solid-state drive/Intel Optane memory module in M.2 slot one

Prerequisites

1. Follow the procedure in [Before working inside your computer](#).
2. Remove the [base cover](#).

About this task

NOTE: This procedure applies only to computers shipped with a 2280 solid-state drive installed in M.2 slot one.

NOTE: Depending on the configuration ordered, your computer may support either 2230 solid-state drive or 2280 solid-state drive in M.2 slot one.

The following image indicates the location of the 2280 solid-state drive/Intel Optane memory module installed in M.2 slot one and provides a visual representation of the removal procedure.

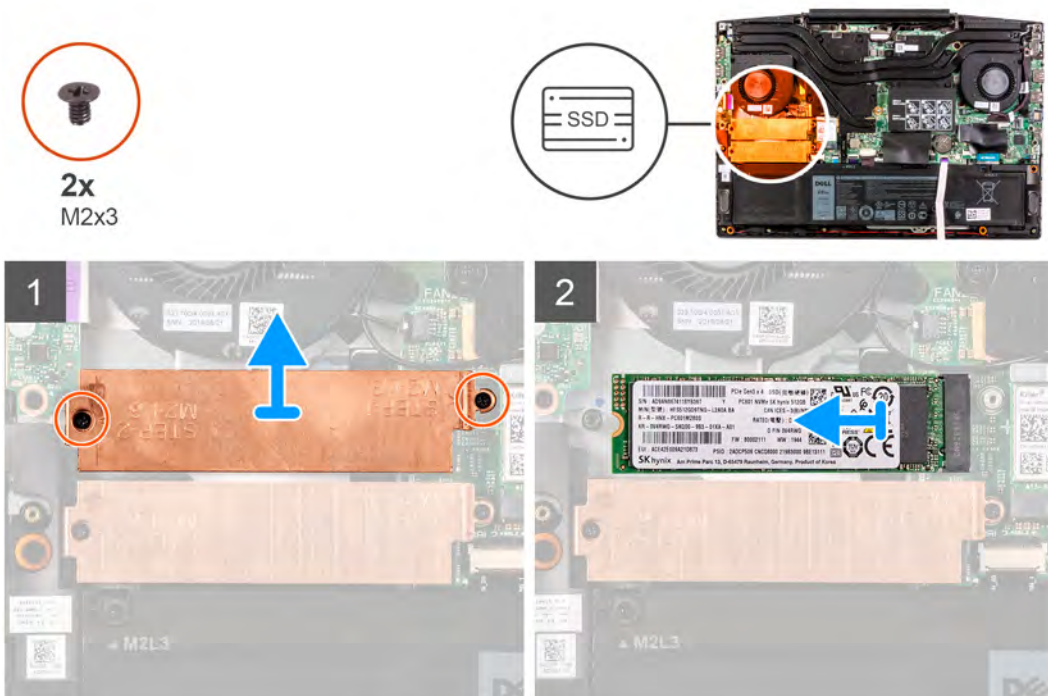

Steps

1. Remove the two screws (M2x3) that secure the solid-state drive bracket to the system board and the palm-rest and keyboard assembly.
2. Lift the solid-state drive bracket off the palm-rest and keyboard assembly.
3. Slide and lift the solid-state drive/Intel Optane memory module off the SSD1 slot on the system board.

Installing the 2280 solid-state drive/Intel Optane memory module in M.2 slot one

Prerequisites

If you are replacing a component, remove the existing component before performing the installation procedure.

About this task

- NOTE:** This procedure applies only to computers shipped with a 2280 solid-state drive installed in M.2 slot one.
- NOTE:** Depending on the configuration ordered, your computer may support either 2230 solid-state drive or 2280 solid-state drive in M.2 slot one.

The following image indicates the location of the 2280 solid-state drive/Intel Optane memory module installed in M.2 slot one and provides a visual representation of the installation procedure.

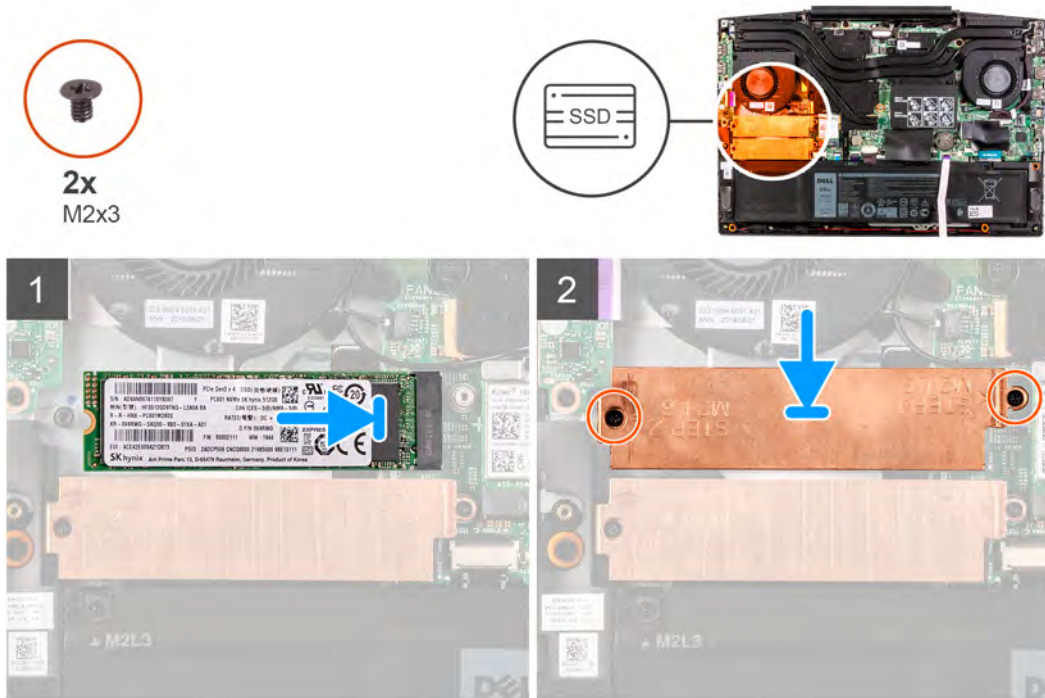

Steps

1. Align the notches on the solid-state drive/Intel Optane memory module with the SSD2 slot on the system board.
2. Slide the solid-state drive/Intel Optane memory module into the SSD2 slot on the system board.
3. Place the solid-state drive bracket on the solid-state drive/Intel Optane memory module.
4. Align the screw holes on the solid-state drive bracket with the screw holes on the system board and the palm-rest and keyboard assembly.
5. Replace the two screws (M2x3) that secure the solid-state drive/Intel Optane memory module to the system board.

Next steps

1. Install the [base cover](#).
2. Follow the procedure in [After working inside your computer](#).

Solid-state drive—M.2 slot two

Removing the 2280 solid-state drive/Intel Optane memory module in M.2 slot two

Prerequisites

If you are removing the Intel Optane memory module (optional) from your computer, disable the Intel Optane memory so that all cached system data are moved from the Intel Optane memory module to the SATA drive. For more information about disabling the Intel Optane memory, see [Disabling Intel Optane memory](#).

1. Follow the procedure in [Before working inside your computer](#).
2. Remove the [base cover](#).

About this task

The following image indicates the location of the 2280 solid-state drive/Intel Optane memory module in M.2 slot two and provides a visual representation of the removal procedure.

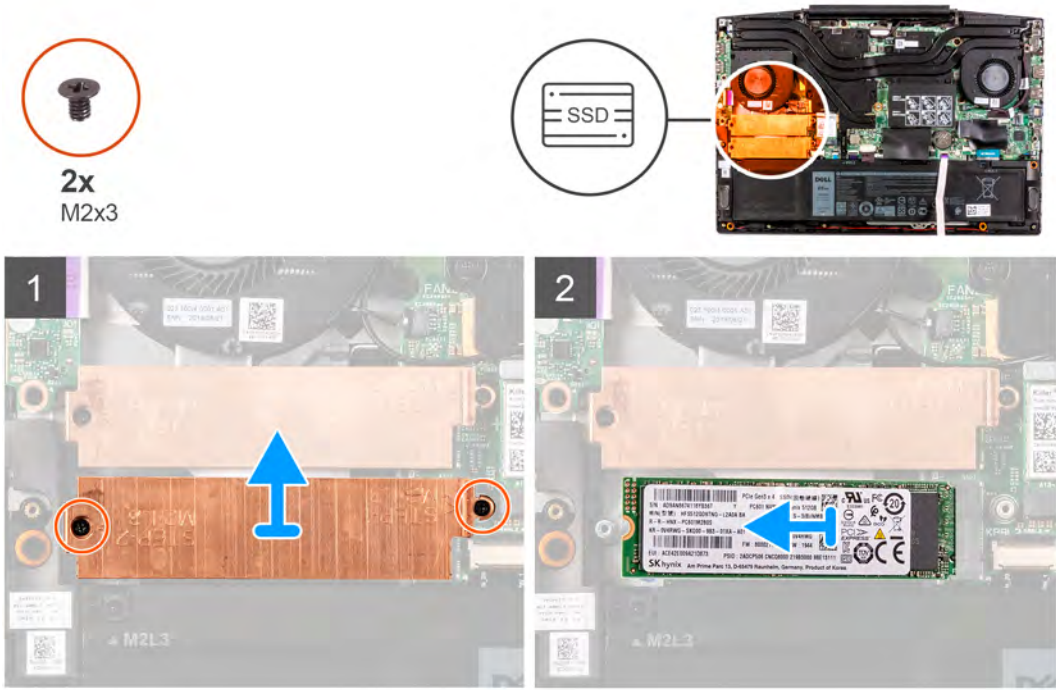

Steps

1. Remove the two screws (M2x3) that secure the solid-state drive bracket to the system board and the palm-rest and keyboard assembly.
2. Lift the solid-state drive bracket off the solid-state drive/Intel Optane memory module.
3. Slide and lift the solid-state drive/Intel Optane memory module off the SSD2 slot on the system board.

Installing the 2280 solid-state drive/Intel Optane memory module in M.2 slot two

Prerequisites

If your are replacing a component, remove the existing component before performing the installation procedure.

About this task

The following image indicates the location of the 2280 solid-state drive/Intel Optane memory module installed in M.2 slot two and provides a visual representation of the installation procedure.

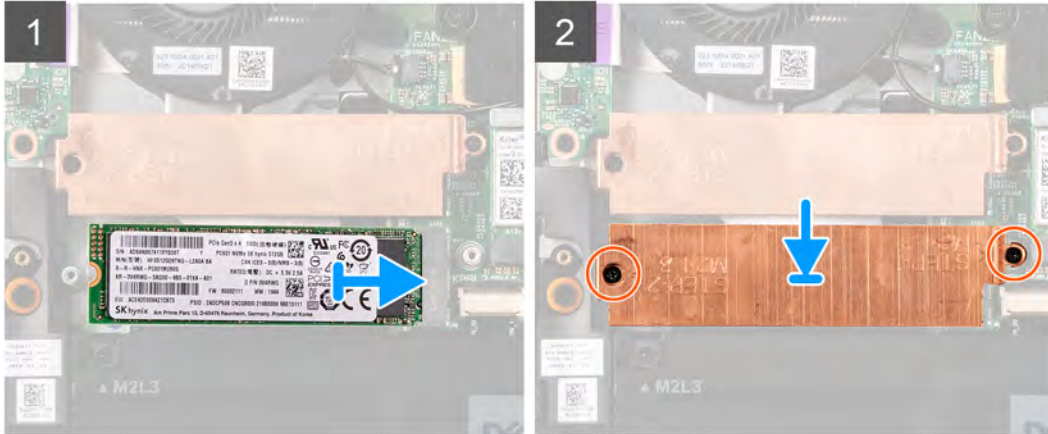

Steps

1. Align the notches on the solid-state drive/Intel Optane memory module with the SSD2 slot on the system board.
2. Slide the solid-state drive/Intel Optane memory module into the SSD2 slot on the system board.
3. Place the solid-state drive bracket on the solid-state drive/Intel Optane memory module.
4. Align the screw holes on the solid-state drive bracket with the screw holes on the system board and the palm-rest and keyboard assembly.
5. Replace the two screws (M2x3) that secure the solid-state drive/Intel Optane memory module to the system board.

Next steps

1. Install the [base cover](#).
2. Follow the procedure in [After working inside your computer](#).

Hard drive

Removing the hard drive

Prerequisites

1. Follow the procedure in [Before working inside your computer](#).
2. Remove the [base cover](#).

About this task

The following image indicates the location of the hard drive and provides a visual representation of the removal procedure.



3x
M2x3



Steps

1. Open the latch and disconnect the hard-drive cable from the system board.
2. Remove the three screws (M2x3) that secure the hard-drive assembly to the palm-rest and keyboard assembly.
3. Lift the hard-drive assembly along with its cable off the palm-rest and keyboard assembly.
4. Disconnect the interposer from the hard-drive assembly.
5. Remove the four screws (M3x3) that secure the hard-drive bracket to the hard drive.
6. Remove the hard drive from the hard-drive bracket.

Installing the hard drive

Prerequisites

If your are replacing a component, remove the existing component before performing the installation procedure.

About this task

The following image indicates the location of the hard drive and provides a visual representation of the installation procedure.

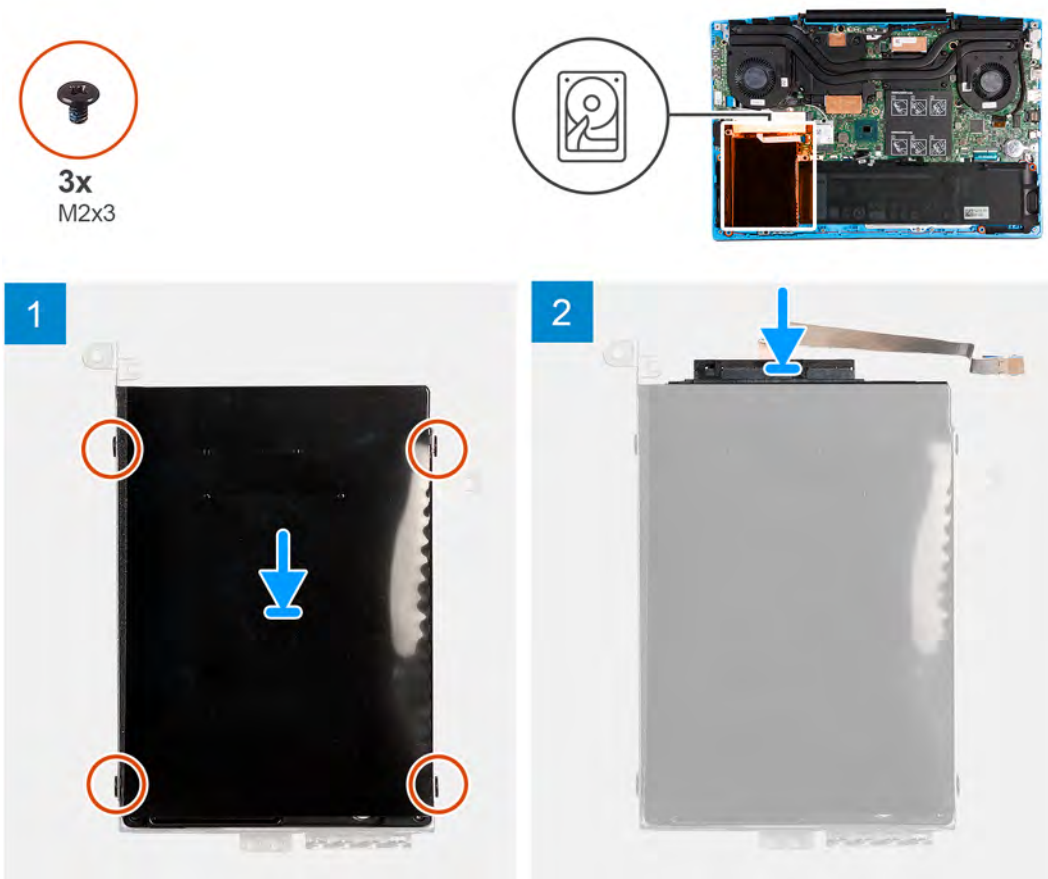

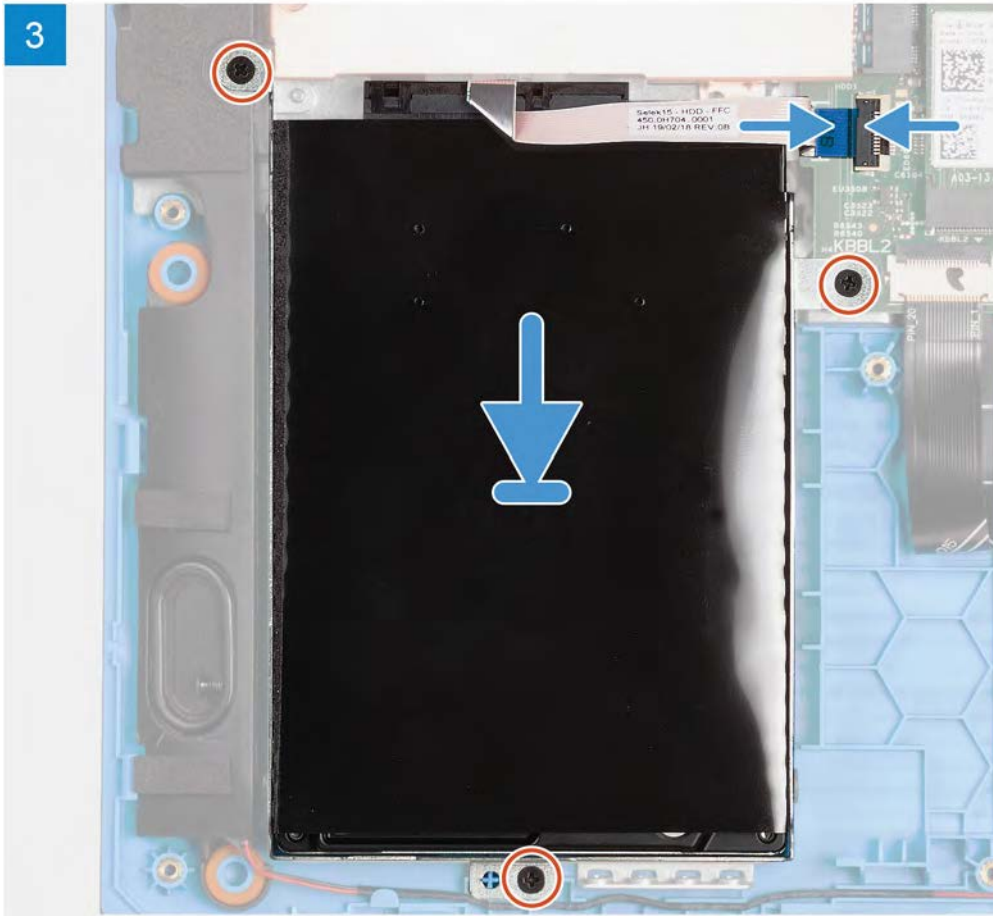

Steps

1. Align the screw holes on the hard-drive bracket with the screw holes on the hard drive.
2. Replace the four screws (M3x3) that secure the hard-drive bracket to the hard drive.
3. Connect the interposer to the hard-drive assembly.
4. Align the screw holes on the hard-drive assembly with the screw holes on the palm-rest and keyboard assembly.
5. Replace the three screws (M2x3) that secure the hard-drive assembly to the palm-rest and keyboard assembly.
6. Connect the hard-drive cable to the system board and close the latch to secure the cable.

Next steps

1. Install the [base cover](#).
2. Follow the procedure in [After working inside your computer](#).

Left fan

Removing the left fan

Prerequisites

1. Follow the procedure in [Before working inside your computer](#).
2. Remove the [base cover](#).

About this task

The following image indicates the location of the left fan and provides a visual representation of the removal procedure.



2x
M2x3

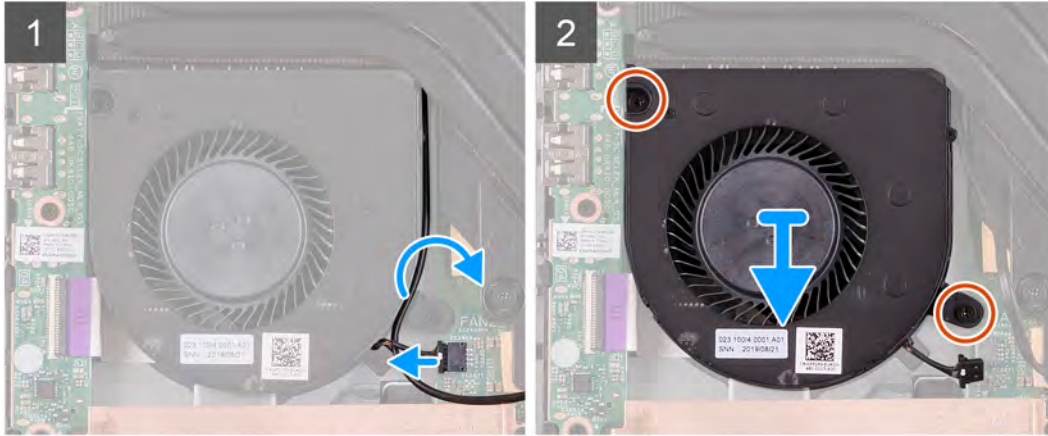
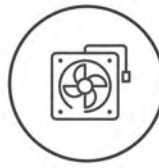

Steps

1. Disconnect the left-fan cable from the system board.
2. Remove the antenna cables from the routing guide on the left fan.
3. Remove the two (M2x3) screws that secure the left fan to the palm-rest and keyboard assembly.
4. Lift the left fan off the palm-rest and keyboard assembly.

Installing the left fan

Prerequisites

If you are replacing a component, remove the existing component before performing the installation procedure.

About this task

The following image indicates the location of the left fan and provides a visual representation of the installation procedure.



2x
M2x3

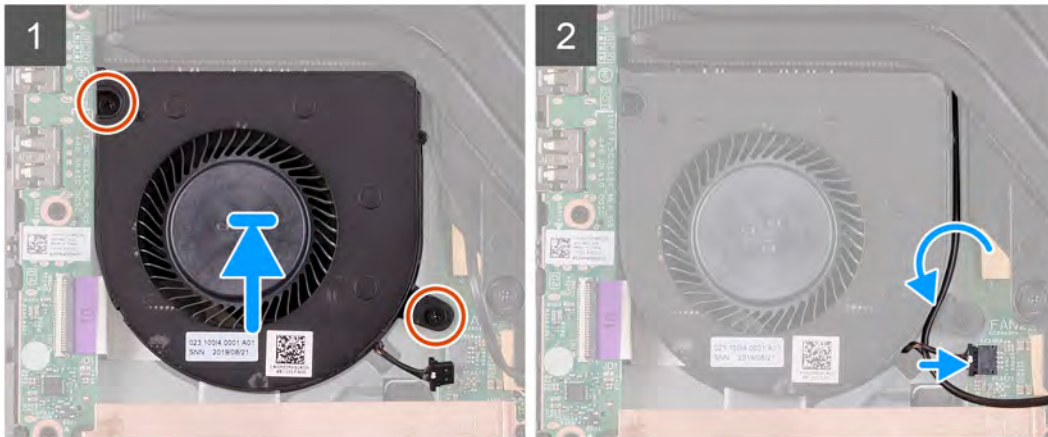
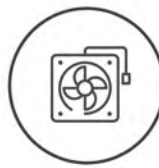

Steps

1. Align and place the left fan on the palm-rest and keyboard assembly.
2. Replace the two (M2x3) screws to secure the left fan to the palm-rest and keyboard assembly.
3. Route the antenna cables through the routing guides on the left fan.
4. Connect the left-fan cable to the system board.

Next steps

1. Install the [base cover](#).
2. Follow the procedure in [After working inside your computer](#).

Right fan

Installing the right fan

Prerequisites

If you are replacing a component, remove the existing component before performing the installation procedure.

About this task

The following image indicates the location of the right fan and provides a visual representation of the installation procedure.

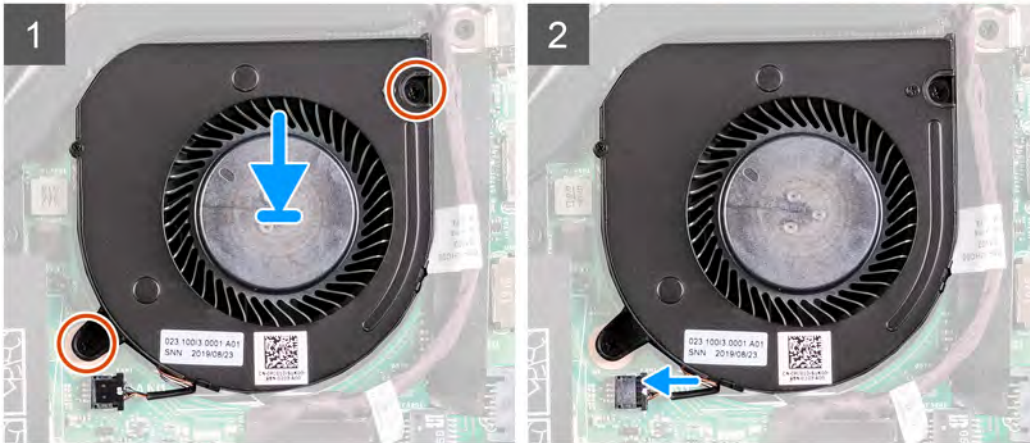
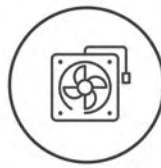

Steps

1. Align and place the right fan on the palm-rest and keyboard assembly.
2. Replace the two (M2x3) screws to secure the right fan to the palm-rest and keyboard assembly.
3. Connect the right-fan cable to the system board.

Next steps

1. Install the [base cover](#).
2. Follow the procedure in [After working inside your computer](#).

Removing the right fan

Prerequisites

1. Follow the procedure in [Before working inside your computer](#).
2. Remove the [base cover](#).

About this task

The following image indicates the location of the right fan and provides a visual representation of the removal procedure.

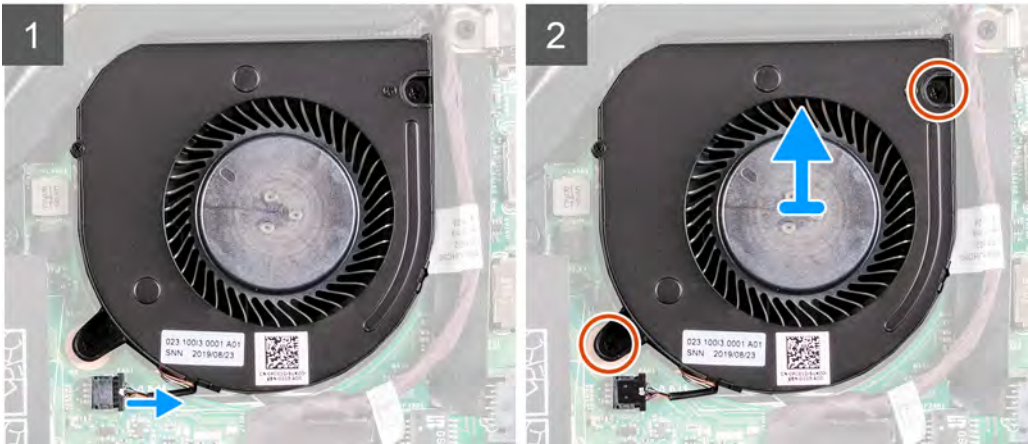
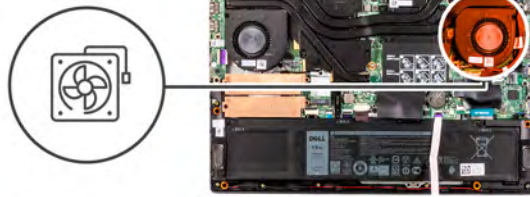

Steps

1. Disconnect the right-fan cable from the system board.
2. Remove the two (M2x3) screws that secure the right fan to the palm-rest and keyboard assembly.
3. Lift the right fan off the palm-rest and keyboard assembly.

Battery

Removing the battery

Prerequisites

1. Follow the procedure in [Before working inside your computer](#).
2. Remove the [base cover](#).

About this task

The following image indicates the location of the battery and provides a visual representation of the removal procedure.

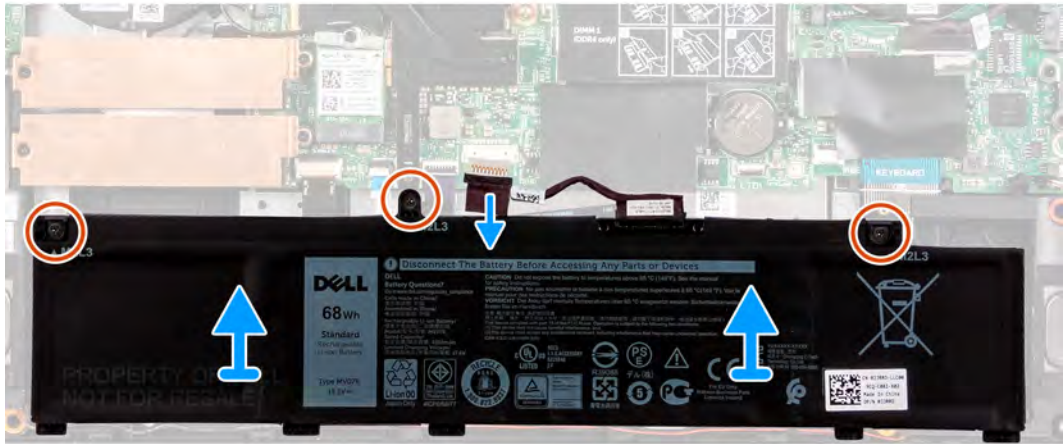
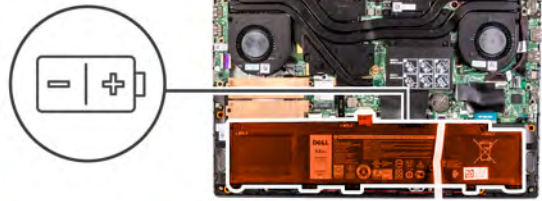

Steps

1. Disconnect the battery cable, if applicable.
2. Remove the three screws (M2x3) that secure the battery to the palm-rest and keyboard assembly.
3. Lift the battery, along with its cable off the palm-rest and keyboard assembly.

Installing the battery

Prerequisites

If you are replacing a component, remove the existing component before performing the installation procedure.

About this task

The following image indicates the location of the battery and provides a visual representation of the installation procedure.



3x
M2X3

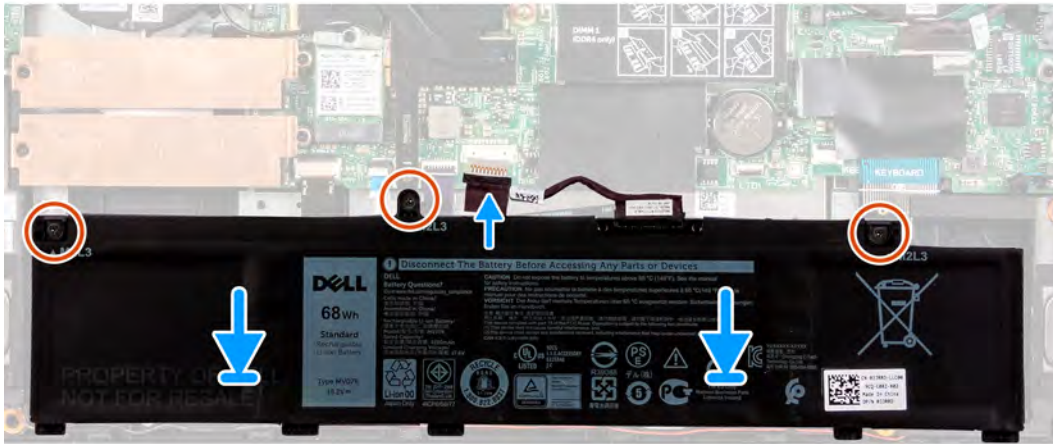
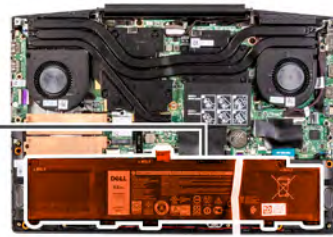
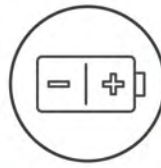

Steps

1. Place the battery on the palm-rest and keyboard assembly.
2. Align the screw holes on the battery with the screw holes on the palm-rest and keyboard assembly.
3. Replace the three screws (M2x3) that secure the battery to the palm-rest and keyboard assembly.
4. Connect the battery cable to the system board.

Next steps

1. Install the [base cover](#).
2. Follow the procedure in [After working inside your computer](#).

Wireless card

Removing the WLAN card

Prerequisites

1. Follow the procedure in [Before working inside your computer](#).
2. Remove the [base cover](#).

About this task

The following image indicates the location of the WLAN card and provides a visual representation of the removal procedure.



1x
M2x3

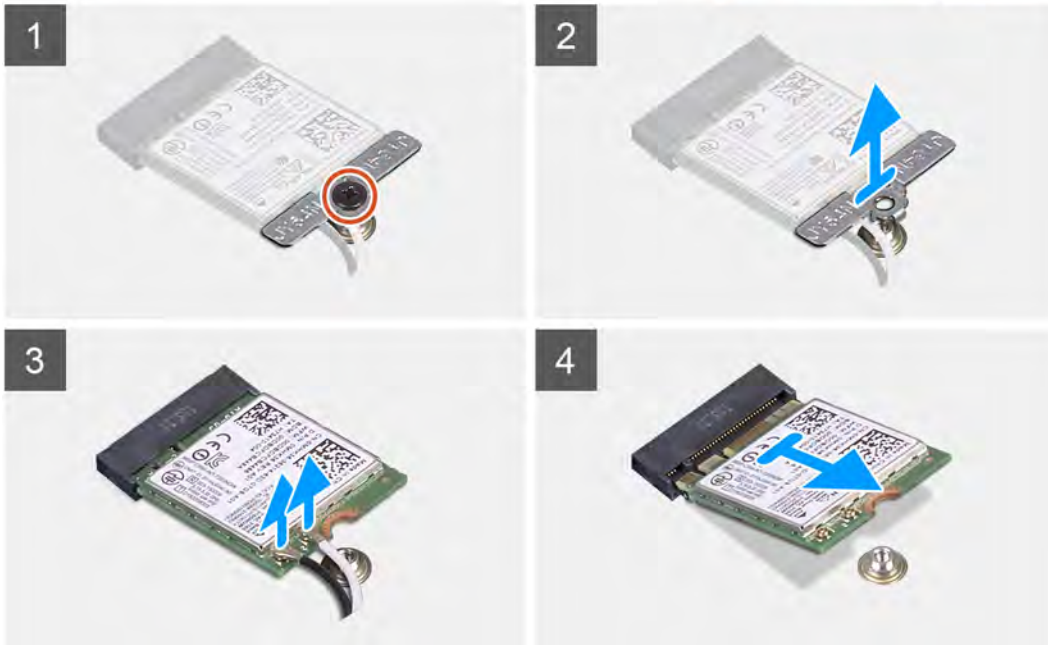

Steps

1. Remove the screw (M2x3) that secures the WLAN card to the system board.
2. Remove the bracket that secures the WLAN card to the system board.
3. Disconnect the antenna cables from the WLAN card.
4. Slide and remove the WLAN card from the WLAN-card slot.

Installing the WLAN card

Prerequisites

If you are replacing a component, remove the existing component before performing the installation procedure.

About this task

The following image indicates the location of the WLAN card and provides a visual representation of the installation procedure.



1x
M2x3

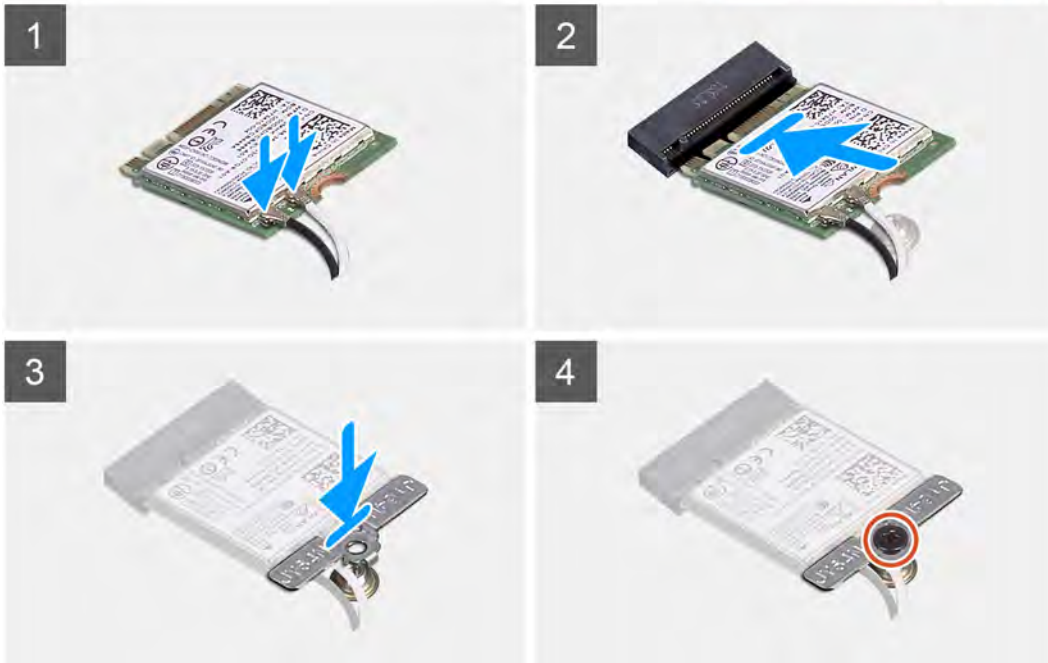

Steps

1. Connect the antenna cables to the WLAN card.

The following table provides the antenna-cable color scheme for the wireless card that is supported by your computer.

Table 2. Antenna-cable color scheme

Connectors on the wireless card	Antenna-cable color
Main (white triangle)	White
Auxiliary (black triangle)	Black

2. Align the notch on the WLAN card with the tab on the WLAN-card slot and insert the WLAN card at an angle into the WLAN-card slot.
3. Place the WLAN-card bracket on the WLAN card.
4. Align the screw hole on the WLAN-card bracket and the screw hole on the system board.
5. Replace the screw (M2x3) that secures the WLAN card to the system board.

Next steps

1. Install the [base cover](#).
2. Follow the procedure in [After working inside your computer](#).

Speakers

Removing the speakers

Prerequisites

1. Follow the procedure in [Before working inside your computer](#).
2. Remove the [base cover](#).

About this task

The following image indicates the location of the speakers and provides a visual representation of the removal procedure.

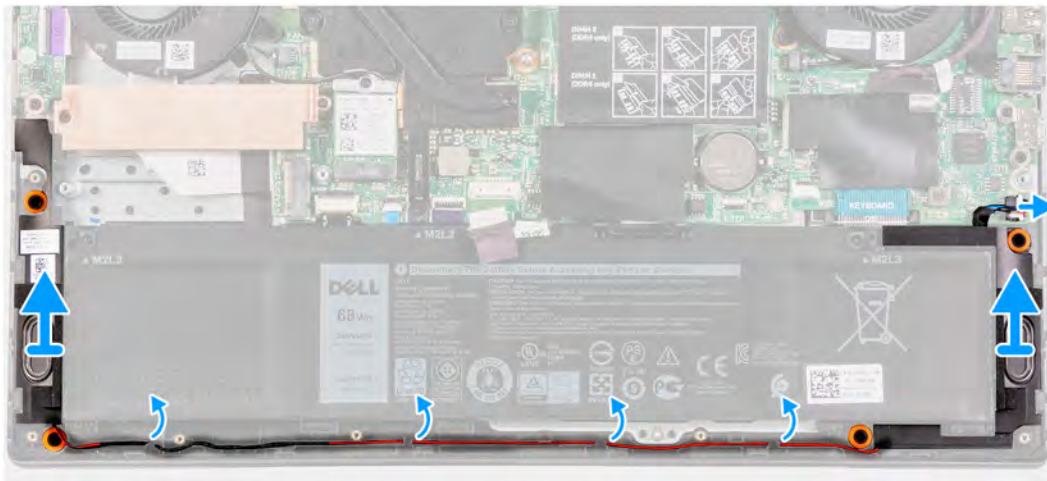
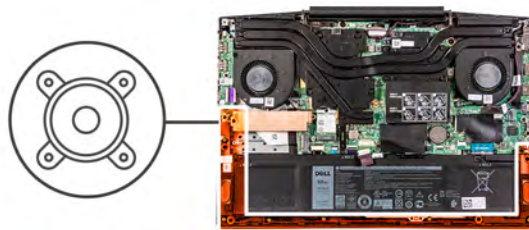

Steps

1. Disconnect the speaker cable from the system board.
2. Note the routing of the speaker cable, and remove the speaker cable from the routing guides on the palm-rest and keyboard assembly.
NOTE: Note the position of the rubber grommets before lifting the speakers.
3. Lift the speakers, along with the cable, off the palm-rest and keyboard assembly.

Installing the speakers

Prerequisites

If you are replacing a component, remove the existing component before performing the installation procedure.

About this task

The following image indicates the location of the speakers and provides a visual representation of the installation procedure.

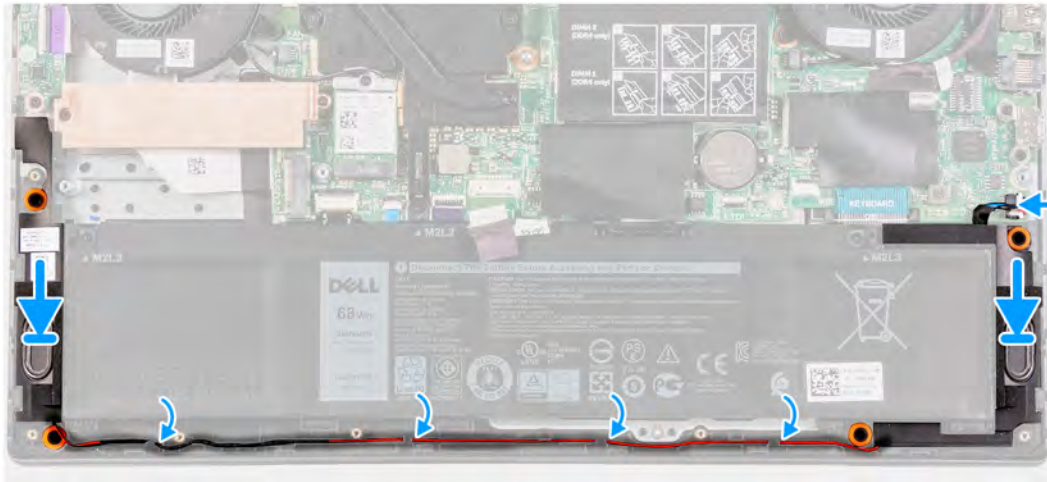
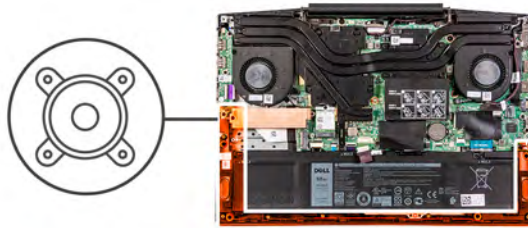

Steps

1. Using the alignment posts and rubber grommets, place the speakers in the slots on the palm-rest and keyboard assembly.

NOTE: If the rubber grommets are pushed out of the speakers when removing the speakers, push them back in place before replacing the speakers.

2. Route the speaker cable through the routing guides on the palm-rest and keyboard assembly.
3. Connect the speaker cable to the system board.

Next steps

1. Install the [base cover](#).
2. Follow the procedure in [After working inside your computer](#).

Coin-cell battery

Removing the coin-cell battery

Prerequisites

1. Follow the procedure in [Before working inside your computer](#).
2. Remove the [base cover](#).

About this task

The following image indicates the location of the coin-cell battery and provides a visual representation of the removal procedure.

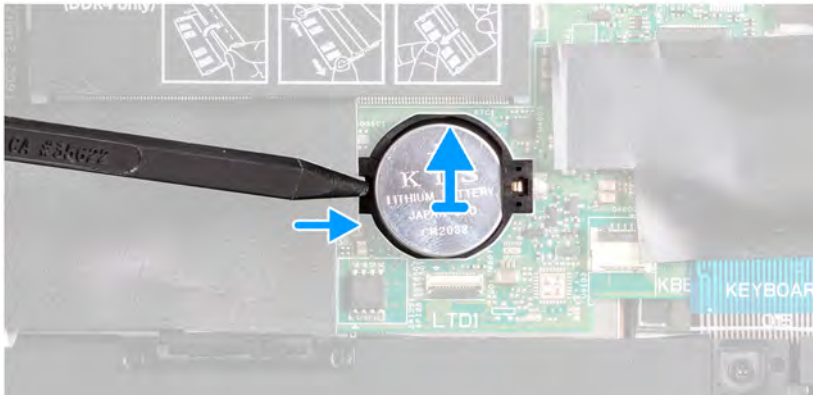
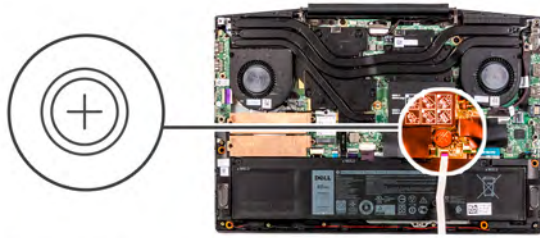

Steps

Using a plastic scribe, pry the coin-cell battery out of the coin-cell battery slot on the system board.

Installing the coin-cell battery

Prerequisites

If you are replacing a component, remove the existing component before performing the installation procedure.

About this task

The following image indicates the location of the coin-cell battery and provides a visual representation of the installation procedure.

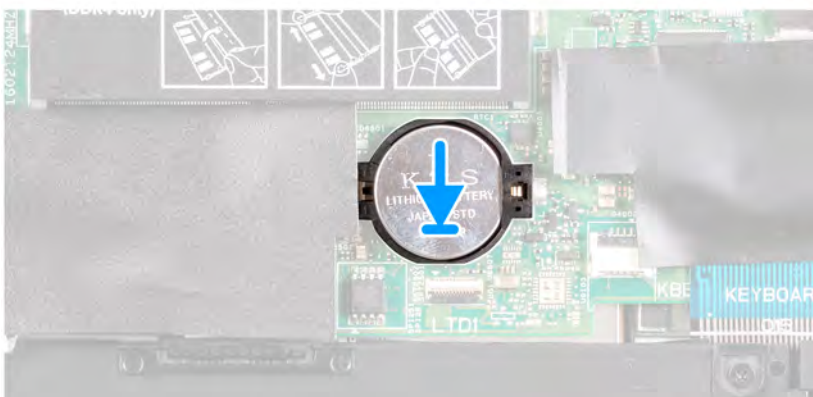
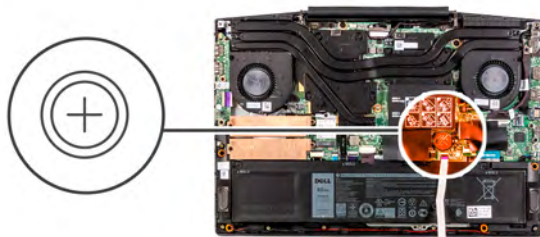

Steps

1. Place the coin-cell battery in the coin-cell battery slot with the positive side facing up.
2. Snap the coin-cell battery into place.

Next steps

1. Install the [base cover](#).
2. Follow the procedure in [After working inside your computer](#).

Power-adapter port

Removing the power-adapter port

Prerequisites

1. Follow the procedure in [Before working inside your computer](#).
2. Remove the [base cover](#).

About this task

The following image indicates the location of the power-adapter port and provides a visual representation of the removal procedure.

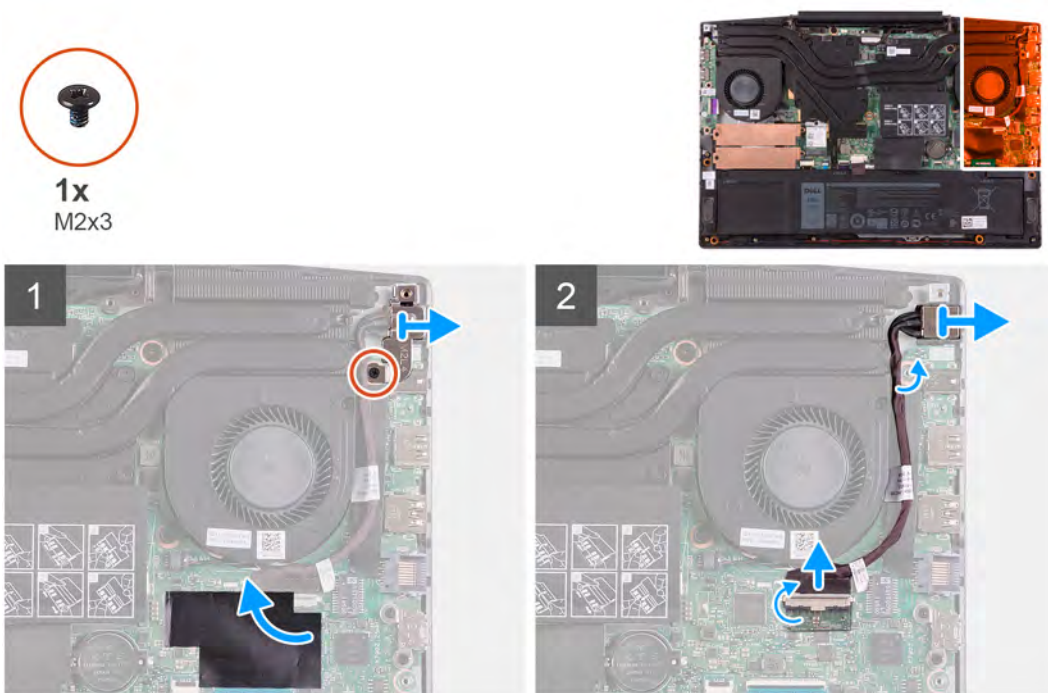

Steps

1. Remove the screw (M2x4) that secures the power-adapter port bracket to the system board.
2. Remove the power-adapter port bracket from the system board.
3. Peel away the mylar that covers the power-adapter port cable connector on the system board.
4. Peel away the tape that secures the power-adapter port cable on the system board.
5. Disconnect the power-adapter port cable from the system board.
6. Lift the power-adapter port, along with its cable, off the palm-rest and keyboard assembly.

Installing the power-adapter port

Prerequisites

If you are replacing a component, remove the existing component before performing the installation procedure.

About this task

The following image indicates the location of the power-adapter port and provides a visual representation of the installation procedure.

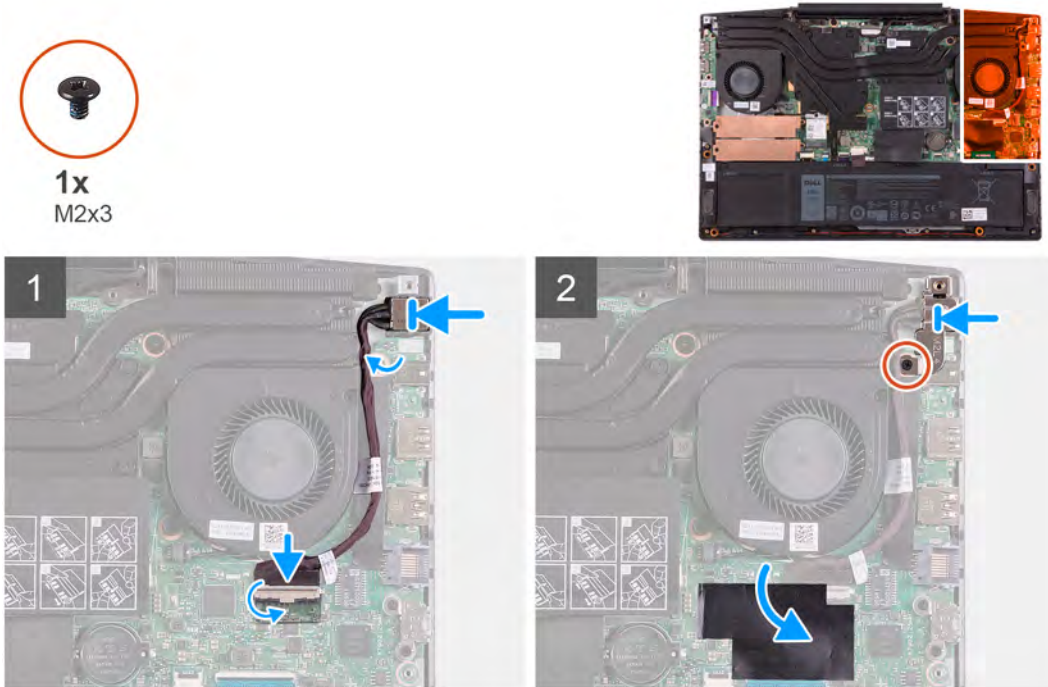

Steps

1. Place the power-adapter port into the slot on the palm rest and keyboard assembly.
2. Route the power-adapter port cable around the fan.
3. Connect the power-adapter port cable to the system board.
4. Align and place the power-adapter port bracket over the power-adapter port.
5. Replace the screw (M2x4) that secures the power-adapter port bracket to the system board.

Next steps

1. Install the [base cover](#).
2. Follow the procedure in [After working inside your computer](#).

Heat sink

Removing the heat sink

Prerequisites

1. Follow the procedure in [Before working inside your computer](#).

CAUTION: For maximum cooling of the processor, do not touch the heat transfer areas on the heat sink. The oils in our skin can reduce the heat transfer capability of the thermal grease.

NOTE: The heat sink may become hot during normal operation. Allow sufficient time for the heat sink to cool before you touch it.

2. Remove the [base cover](#).

About this task

The following image indicates the location of the heat sink and provides a visual representation of the removal procedure.

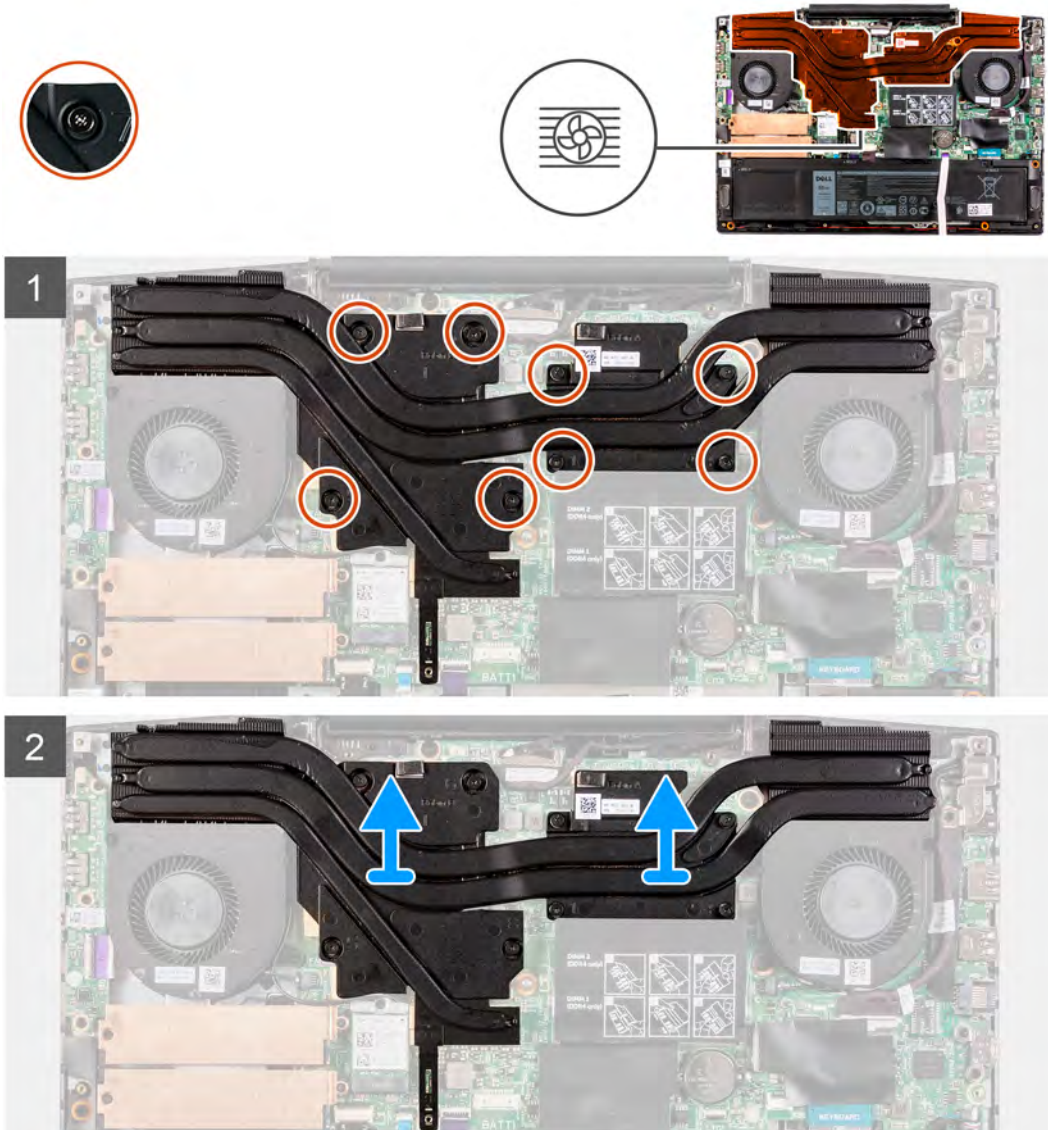

Steps

1. In the sequential order (1>2>3>4>5>6>7>8), loosen the eight captive screws that secure the heat sink to the system board.
2. Lift the heat sink off the system board.

Installing the heat sink

Prerequisites

If you are replacing a component, remove the existing component before performing the installation procedure.

About this task

The following image indicates the location of the heat sink and provides a visual representation of the installation procedure.

CAUTION: Incorrect alignment of the heat sink can damage the system board and processor.

NOTE: If either the system board or the heat sink is replaced, use the thermal pad/paste provided in the kit to ensure that the thermal conductivity is achieved.

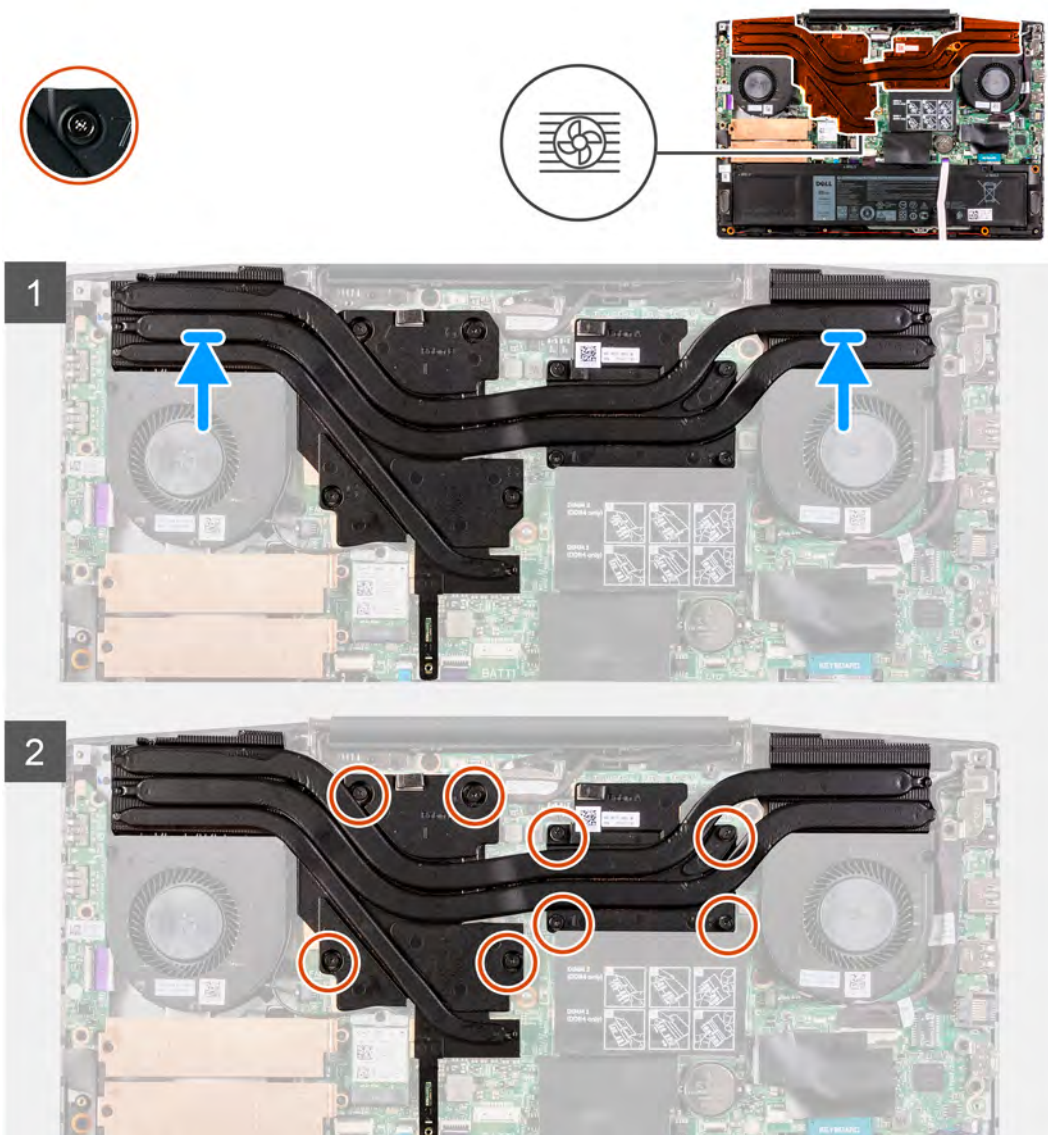

Steps

1. Place the heat sink on the system board and align the screw holes on the heat sink with the screw holes on the system board.
2. In reverse sequential order (8>7>6>5>4>3>2>1), tighten the eight captive screws that secure the heat sink to the system board.

Next steps

1. Install the [base cover](#).
2. Follow the procedure in [After working inside your computer](#).

I/O board

Removing the I/O board

Prerequisites

1. Follow the procedure in [Before working inside your computer](#).
2. Remove the [base cover](#).
3. Remove the [left fan](#).

About this task

The following image indicates the location of the I/O board and provides a visual representation of the removal procedure.



3x
M2x3

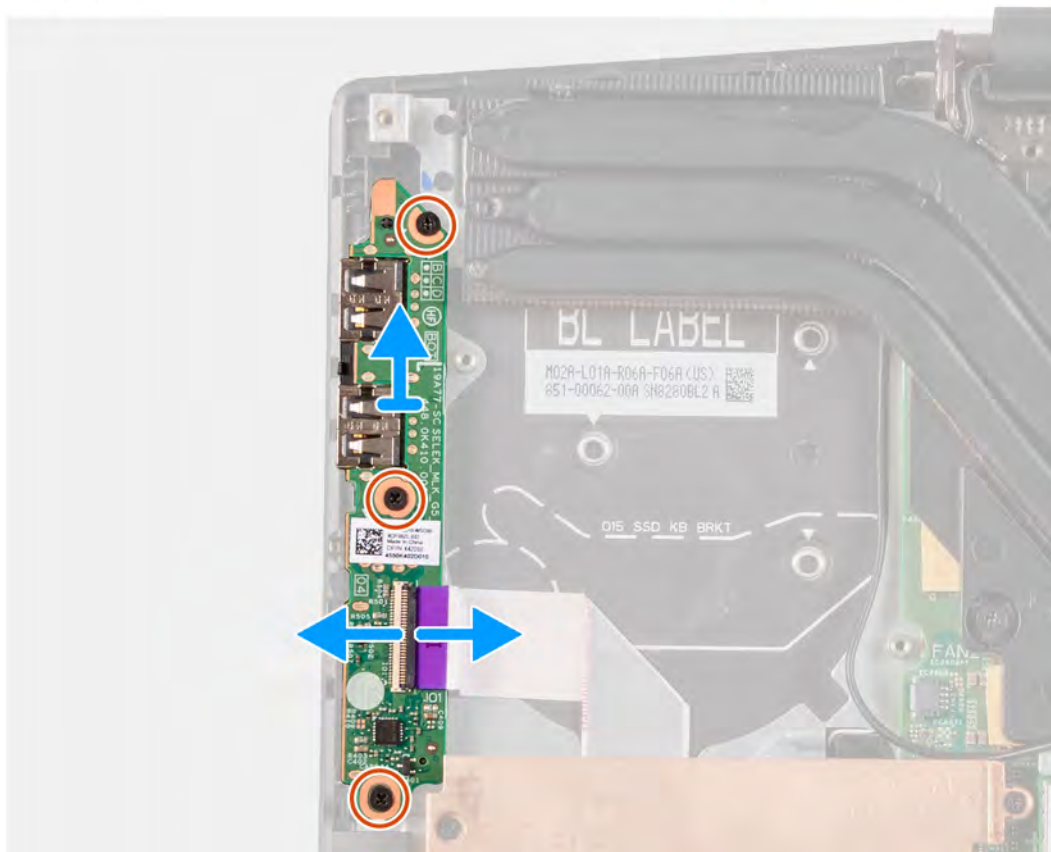

Steps

1. Open the latch, and disconnect the I/O-board cable from the I/O board.
2. Remove the three screws (M2x4) that secure the I/O board to the palm-rest and keyboard assembly.
3. Lift the I/O board off the palm-rest and keyboard assembly.

Installing the I/O board

Prerequisites

If you are replacing a component, remove the existing component before performing the installation procedure.

About this task

The following image indicates the location of the I/O board and provides a visual representation of the installation procedure.



3x
M2x3

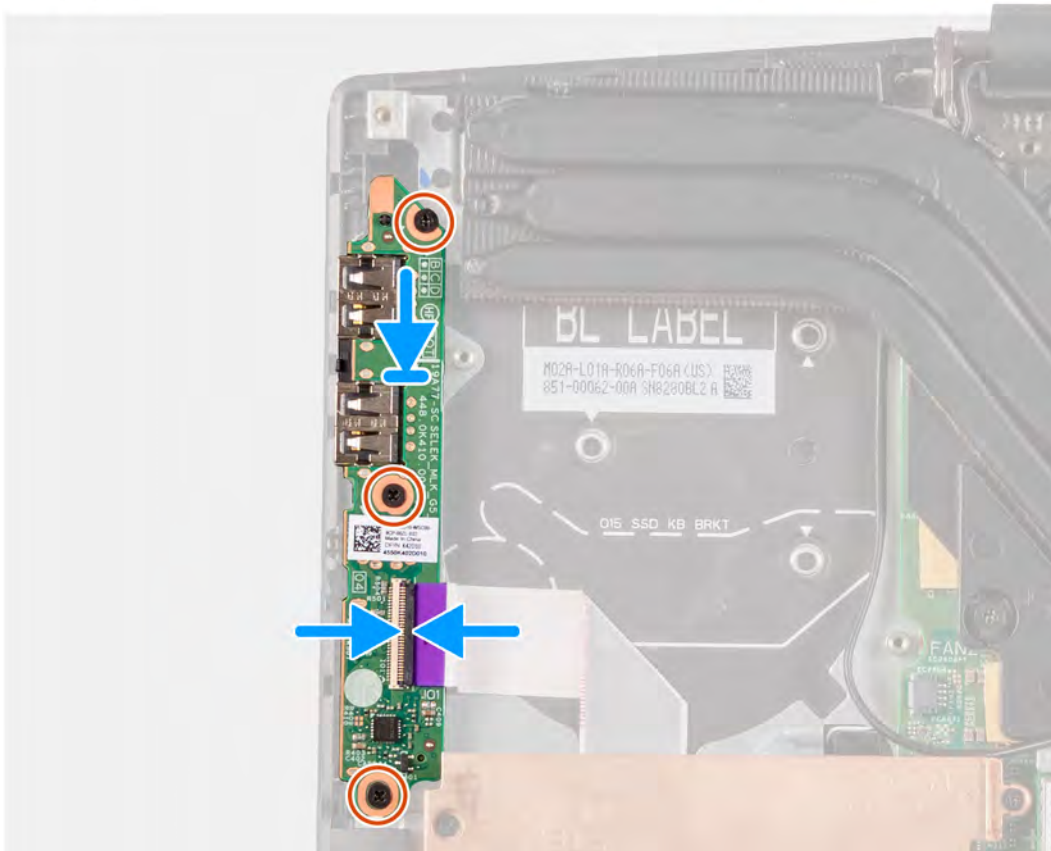

Steps

1. Place the I/O board on the palm-rest and keyboard assembly.
2. Align the screw holes on the I/O board with the screw holes on the palm-rest and keyboard assembly.
3. Replace the three screws (M2x4) that secure the I/O board to the palm-rest and keyboard assembly.
4. Connect the I/O-board cable to the I/O board and close the latch.

Next steps

1. Install the [left fan](#).
2. Install the [base cover](#).
3. Follow the procedure in [After working inside your computer](#).

Display assembly

Removing the display assembly

Prerequisites

1. Follow the procedure in [Before working inside your computer](#).
2. Remove the [base cover](#).

About this task

The following image indicates the location of the display assembly and provides a visual representation of the removal procedure.



4x
M2.5x5

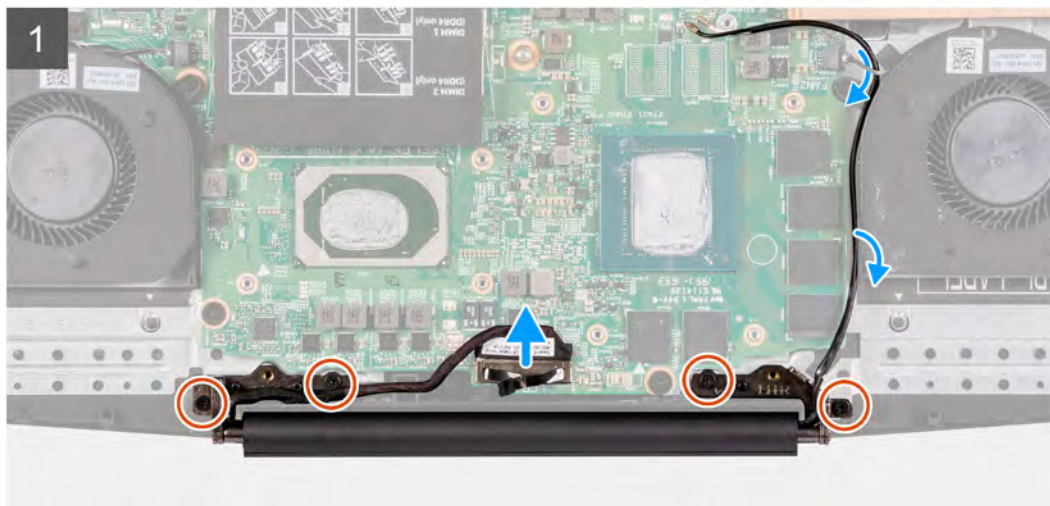
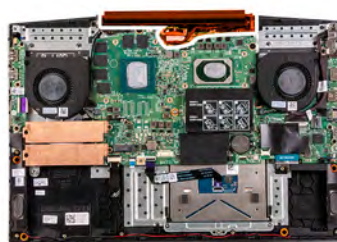



Steps

1. Using the pull tab, gently pull upwards to disconnect the display cable from the system board.
2. Remove the four screws (M2.5x5) that secure the display assembly to the palm-rest and keyboard assembly.
3. Slowly lift the palm-rest and keyboard assembly at an angle.
4. Slide the palm-rest and keyboard assembly off the display assembly.
5. After performing the above steps, you are left with the display assembly.



Installing the display assembly

Prerequisites

If you are replacing a component, remove the existing component before performing the installation procedure.

About this task

The following image indicates the location of the display assembly and provides a visual representation of the installation procedure.



4x
M2.5x5

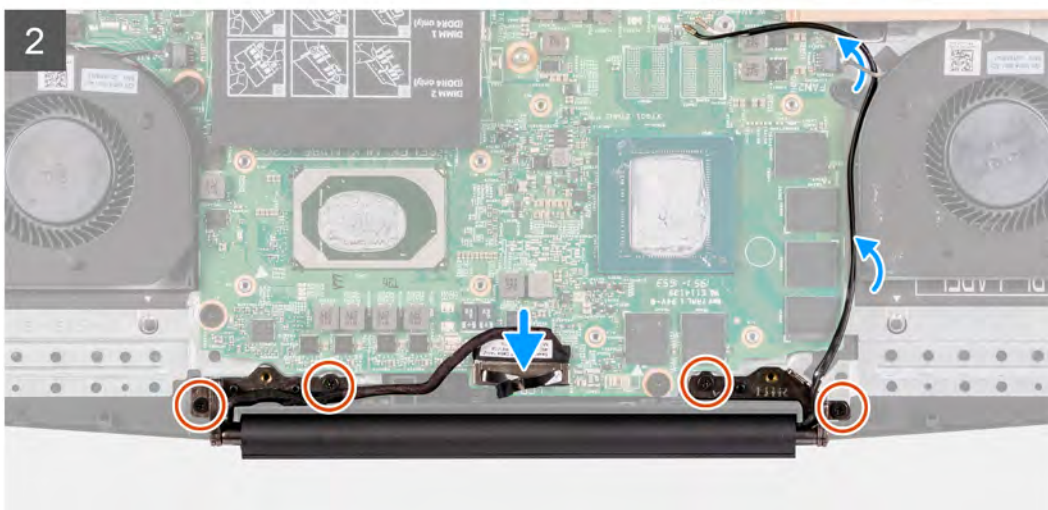

Steps

1. Place the display assembly on a clean and flat surface with the display panel facing up.
2. Slide the palm-rest and keyboard assembly under the display hinges.
3. Press down the display hinges and align the screw holes on the display hinges with the screw holes on the palm-rest and keyboard assembly.
4. Replace the four screws (M2.5x5) that secure the display assembly to the palm-rest and keyboard assembly.
5. Align the display-cable connector on the system board, then firmly press into position.

Next steps

1. Install the [base cover](#).
2. Follow the procedure in [After working inside your computer](#).

System board

Removing the system board

Prerequisites

1. Follow the procedure in [Before working inside your computer](#).
2. Remove the [base cover](#).
3. Remove the [memory module](#).
4. Remove the [WLAN card](#).
5. Remove the [solid-state drive in M.2 slot one](#).
6. Remove the [solid-state drive in M.2 slot two](#).
7. Remove the [battery](#).
8. Remove the [coin-cell battery](#).
9. Remove the [left fan](#).
10. Remove the [right fan](#).
11. Remove the [heat sink](#).
12. Remove the [power-adapter port](#).

About this task

The following image indicates the location of the system board and provides a visual representation of the removal procedure.

NOTE:

The I/O board connector is located underneath the system board. Turn the system board over, and disconnect the I/O board cable from the system board.



2x
M2x2

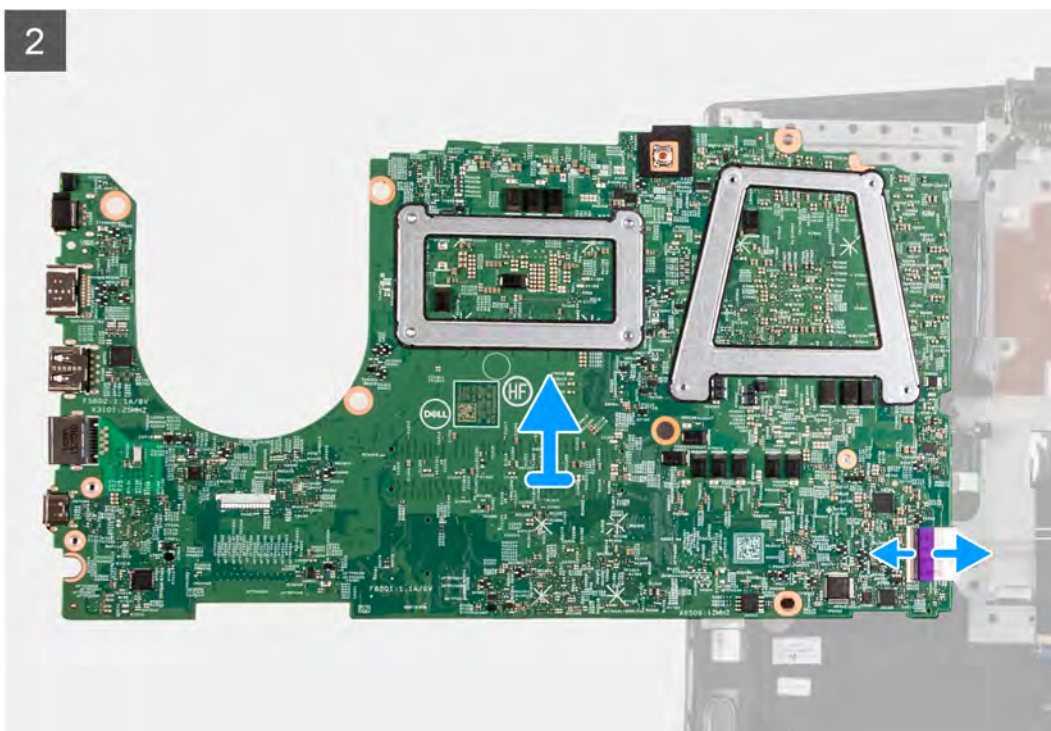
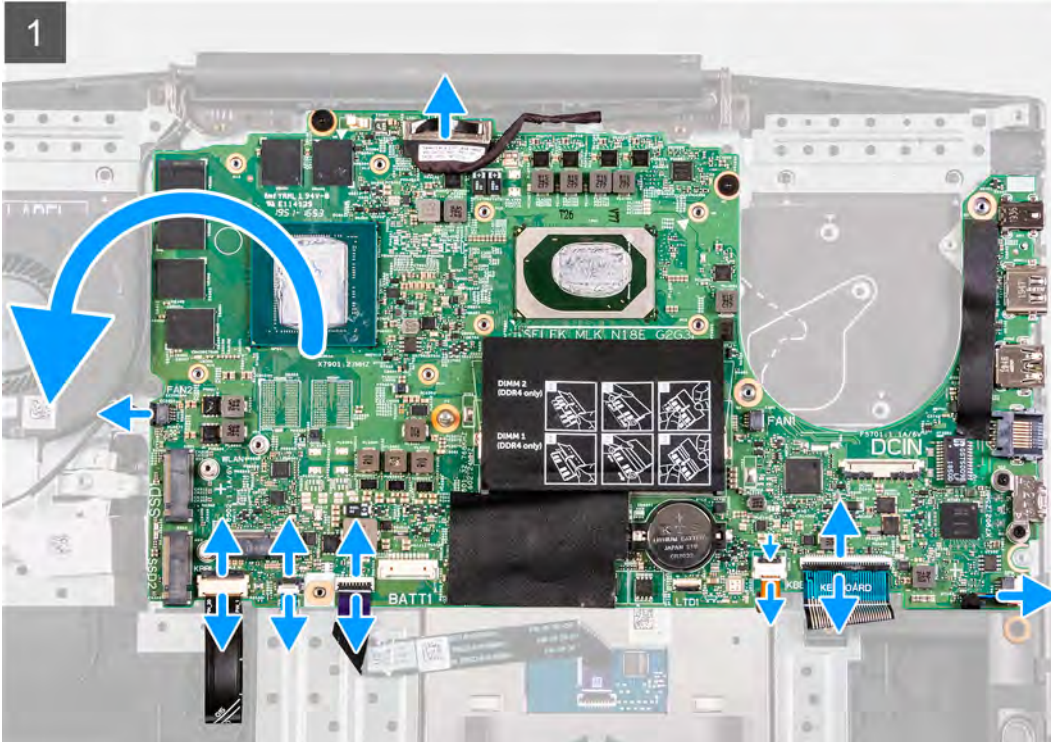

Steps

1. Open the latch, and disconnect the display cable from the system board.
2. Open the latch, and disconnect the keyboard-backlight cable (optional) from the system board.
3. Open the latch, and disconnect the fingerprint-reader cable (optional) from the system board.
4. Open the latch, and disconnect the touchpad cable from the system board.
5. Open the latch, and disconnect the battery cable from the system board.
6. Open the latch, and disconnect the keyboard-backlight cable (optional) from the system board.
7. Open the latch, and disconnect the keyboard cable from the system board.
8. Disconnect the speaker cable from the system board.
9. Remove the two (M2x2) screws that secure the system board to the palm-rest and keyboard assembly.
10. Turn the system board over, and disconnect the I/O board cable from the system board.

Installing the system board

Prerequisites

If you are replacing a component, remove the existing component before performing the installation procedure.

About this task

The following image indicates the location of the system board and provides a visual representation of the installation procedure.

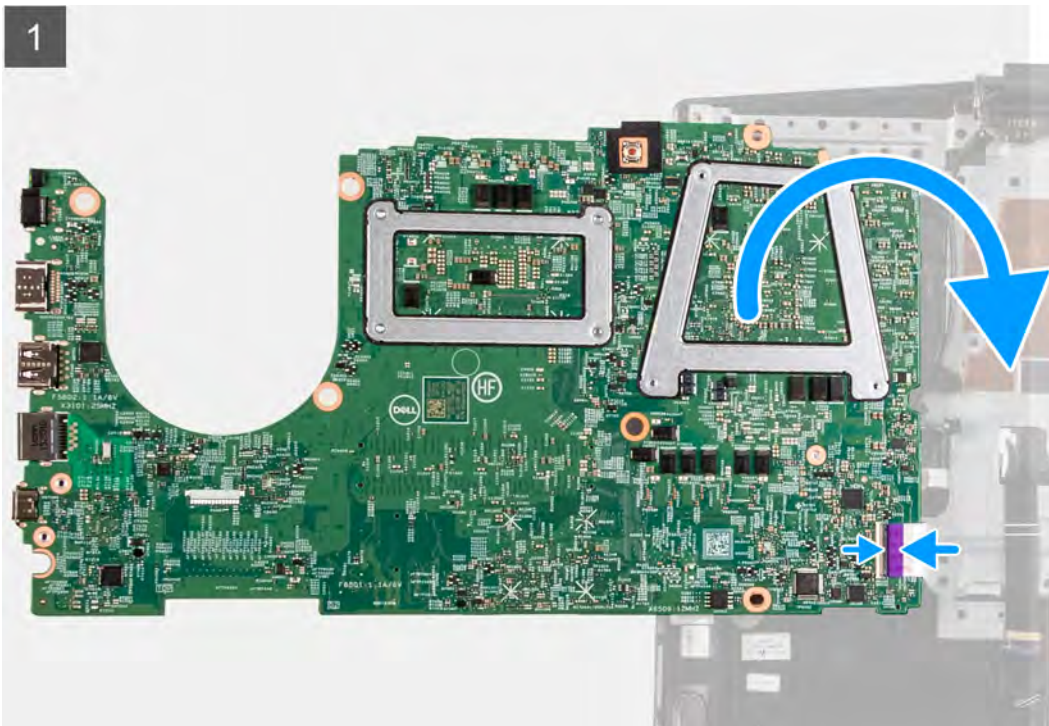



2x
M2x2

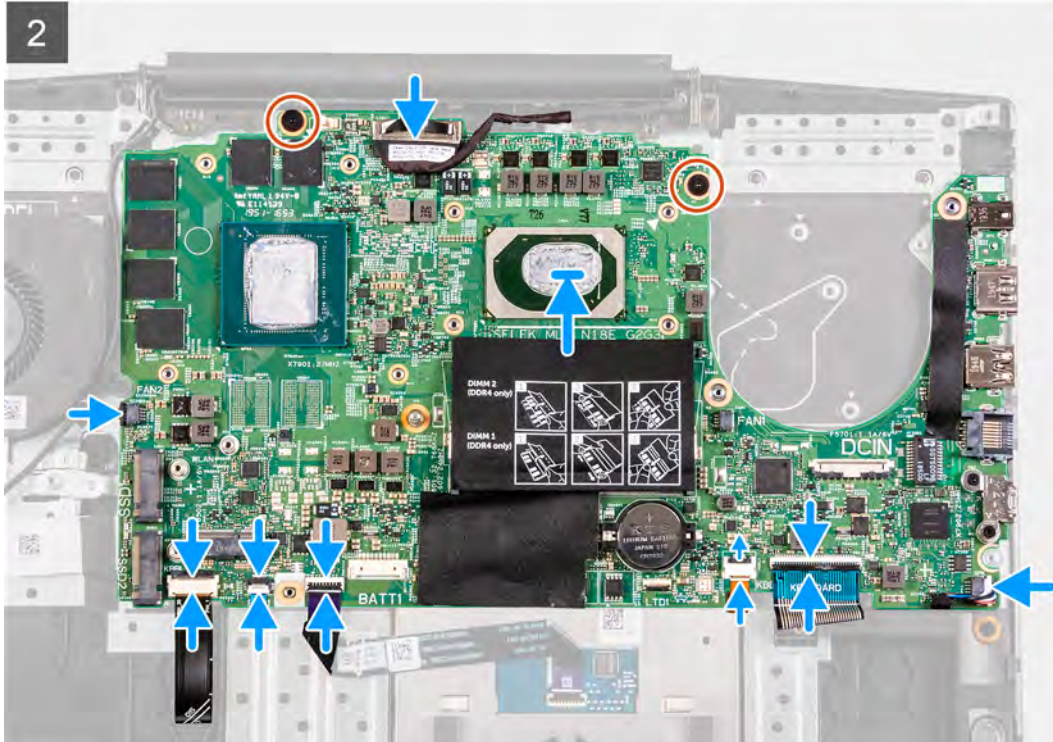

Steps

1. Connect the I/O-board cable to the back of the system board.
2. Turn the system board over, align and place the system board on the palm-rest and keyboard assembly.
3. Connect the display cable to the system board.
4. Connect the keyboard-backlight cable (optional) to the system board, and close the latch.
5. Connect the fingerprint-reader cable (optional) to the system board, and close the latch.
6. Connect the touchpad cable to the system board, and close the latch.
7. Connect the keyboard-backlight cable (optional) to the system board, and close the latch.
8. Connect the keyboard cable to the system board, and close the latch.
9. Connect the speaker cable to the system board.
10. Replace the two (M2x2) screws that secure the system board to the palm-rest and keyboard assembly.

Next steps

1. Install the [power-adaptor port](#).
2. Install the [heat sink](#).
3. Install the [left fan](#).
4. Install the [right fan](#).
5. Install the [coin-cell battery](#).
6. Install the [battery](#).
7. Install the [solid-state drive in M.2 slot two](#).
8. Install the [solid-state drive in M.2 slot one](#).
9. Install the [WLAN card](#).
10. Install the [memory module](#).
11. Install the [base cover](#).

12. Follow the procedure in [After working inside your computer](#).

Power button with fingerprint reader

Removing the power button with fingerprint reader

Prerequisites

1. Follow the procedure in [Before working inside your computer](#).
2. Remove the [base cover](#).
3. Remove the [memory module](#).
4. Remove the [WLAN card](#).
5. Remove the [solid-state drive in M.2 slot one](#).
6. Remove the [solid-state drive in M.2 slot two](#).
7. Remove the [battery](#).
8. Remove the [coin-cell battery](#).
9. Remove the [left fan](#).
10. Remove the [right fan](#).
11. Remove the [heat sink](#).
12. Remove the [power-adaptor port](#).
13. Remove the [system board](#).

 **NOTE:** The system board can be removed along with the heat sink.

Steps

1. Locate the power button with fingerprint reader on your computer.

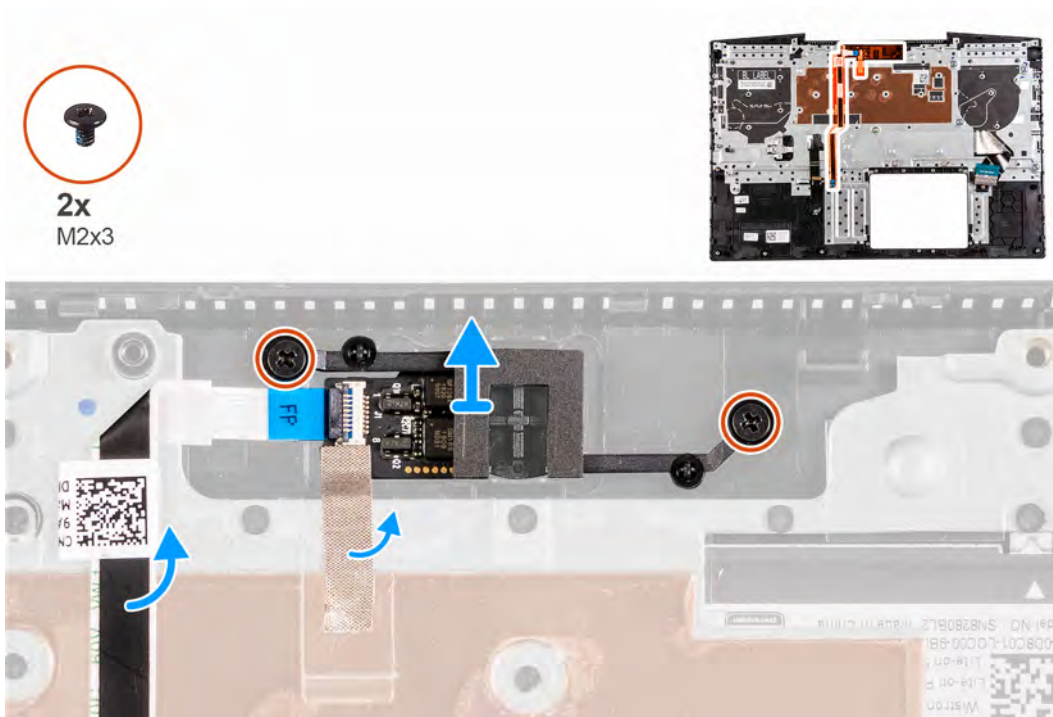

2. Remove the two screws (M2x3) that secure the power button with fingerprint reader to the palm-rest and keyboard assembly.
3. Lift the power button with fingerprint-reader, along with the fingerprint-reader cable, off the palm-rest and keyboard assembly.

Installing the power button with fingerprint reader

Prerequisites

If you are replacing a component, remove the existing component before performing the installation procedure.

Steps

1. Locate the power button with fingerprint reader slot on your computer.

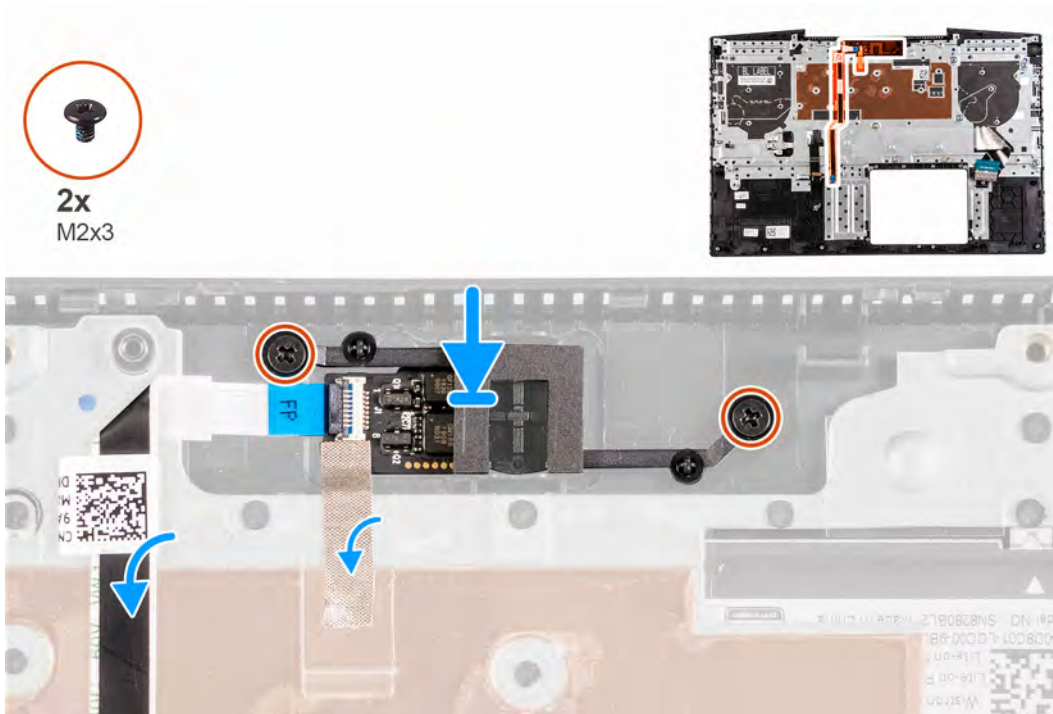

2. Align and place the power button with fingerprint reader on the palm-rest and keyboard assembly.
3. Replace the two screws (M2x3) that secure the power button with fingerprint reader to the palm-rest and keyboard assembly.

Next steps

1. Install the [system board](#).
2. Install the [power-adaptor port](#).
3. Install the [heat sink](#).
4. Install the [left fan](#).
5. Install the [right fan](#).
6. Install the [coin-cell battery](#).
7. Install the [battery](#).
8. Install the [solid-state drive in M.2 slot two](#).
9. Install the [solid-state drive in M.2 slot one](#).
10. Install the [WLAN card](#).
11. Install the [memory module](#).
12. Install the [base cover](#).
13. Follow the procedure in [After working inside your computer](#).

Touchpad

Removing the touchpad

Prerequisites

1. Follow the procedure in [Before working inside your computer](#).
2. Remove the [base cover](#).
3. Remove the [memory module](#).
4. Remove the [WLAN card](#).
5. Remove the [solid-state drive in M.2 slot one](#).
6. Remove the [solid-state drive in M.2 slot two](#).
7. Remove the [battery](#).
8. Remove the [coin-cell battery](#).
9. Remove the [left fan](#).
10. Remove the [right fan](#).
11. Remove the [heat sink](#).
12. Remove the [power-adapter port](#).
13. Remove the [system board](#).

 **NOTE:** The system board can be removed along with the heat sink.

About this task

The following image indicates the location of the touchpad and provides a visual representation of the removal procedure.

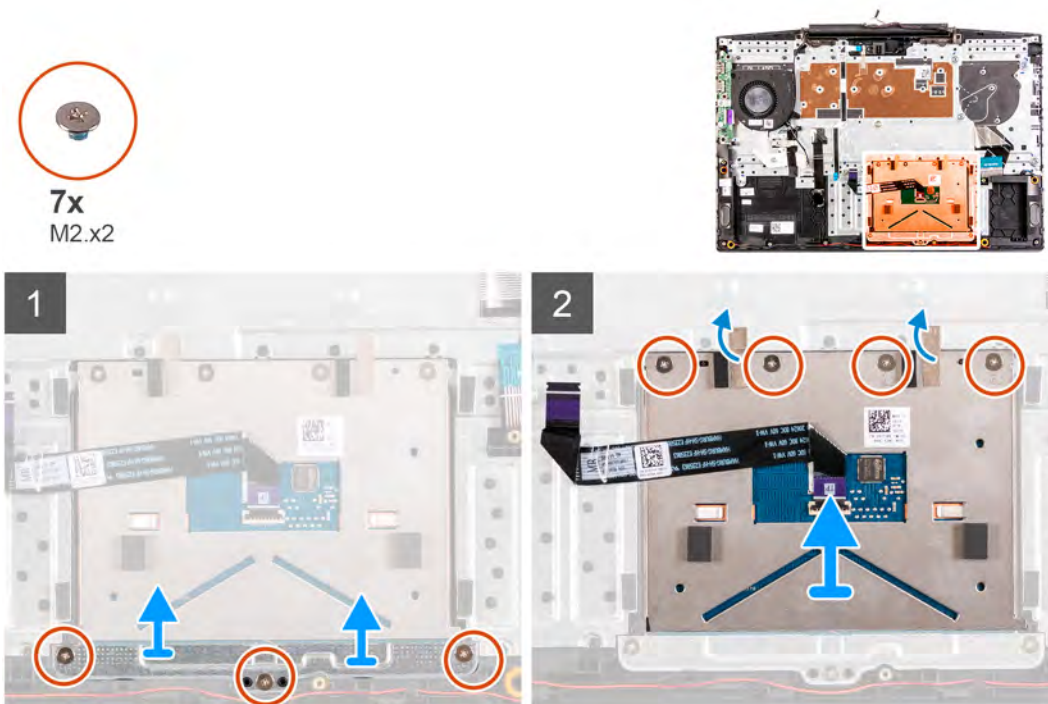

Steps

1. Remove the three (M2x2) screws that secure the touchpad bracket to the palm-rest and keyboard assembly.
2. Lift the touchpad bracket off the palm-rest and keyboard assembly.
3. Peel off the tape from the touchpad.
4. Remove the four (M2x2) screws that secure the touchpad to the palm-rest and keyboard assembly.
5. Lift the touchpad off the palm-rest and keyboard assembly.

Installing the touchpad

Prerequisites

If you are replacing a component, remove the existing component before performing the installation procedure.

About this task

The following image indicates the location of the touchpad and provides a visual representation of the installation procedure.

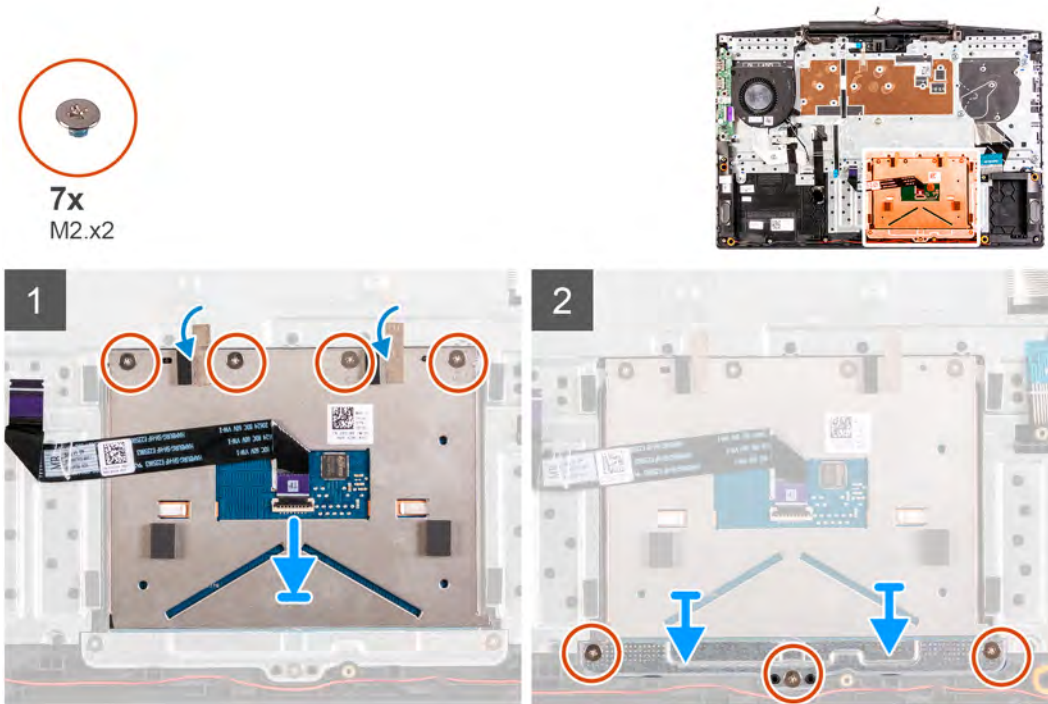

Steps

1. Align and place the touchpad into the slot on the palm-rest and keyboard assembly.
2. Replace the four (M2x2) screws and adhere the tape that secures the touchpad to the palm-rest and keyboard assembly.
3. Align and place the touchpad bracket into the slot on the palm-rest and keyboard assembly.
4. Replace the three (M2x2) screws that secure the touchpad bracket to the palm-rest and keyboard assembly.

Next steps

1. Install the [system board](#).
2. Install the [power-adapter port](#).
3. Install the [heat sink](#).
4. Install the [left fan](#).
5. Install the [right fan](#).
6. Install the [coin-cell battery](#).
7. Install the [battery](#).
8. Install the [solid-state drive in M.2 slot two](#).
9. Install the [solid-state drive in M.2 slot one](#).
10. Install the [WLAN card](#).
11. Install the [memory module](#).
12. Install the [base cover](#).
13. Follow the procedure in [After working inside your computer](#).

Palm-rest and keyboard assembly

Removing the palm-rest and keyboard assembly

Prerequisites

1. Follow the procedure in [Before working inside your computer](#).
2. Remove the [base cover](#).
3. Remove the [memory module](#).
4. Remove the [WLAN card](#).
5. Remove the [solid-state drive in M.2 slot one](#).
6. Remove the [solid-state drive in M.2 slot two](#).
7. Remove the [battery](#).
8. Remove the [display assembly](#).
9. Remove the [coin-cell battery](#).
10. Remove the [left fan](#).
11. Remove the [right fan](#).
12. Remove the [heat sink](#).
13. Remove the [speakers](#).
14. Install the [I/O board](#).
15. Remove the [power-adapter port](#).
16. Remove the [system board](#).
- i** **NOTE:** The system board can be removed along with the heat sink.
17. Remove the [touchpad](#).
18. Remove the [fingerprint reader](#).

About this task

After performing the steps in the pre-requisites, we are left with the palm-rest and keyboard assembly.

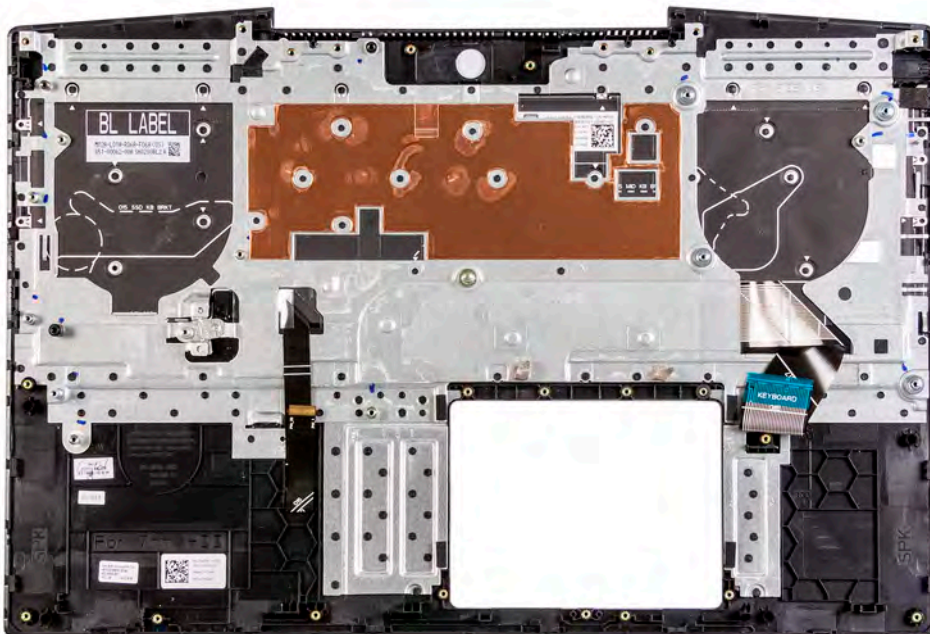

Installing the palm-rest and keyboard assembly

Prerequisites

If you are replacing a component, remove the existing component before performing the installation procedure.

About this task

Place the palm-rest and keyboard assembly on a flat surface.

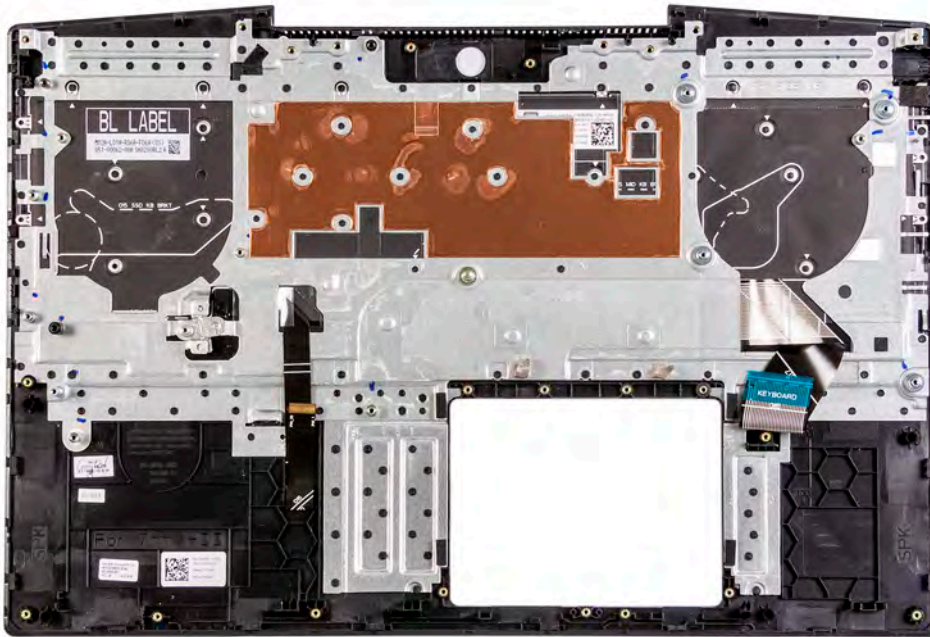

Next steps

1. Install the [fingerprint reader](#).
2. Install the [touchpad](#).
3. Install the [system board](#).
4. Install the [power-adaptor port](#).
5. Install the [I/O board](#).
6. Install the [speakers](#).
7. Install the [heat sink](#).
8. Install the [left fan](#).
9. Install the [right fan](#).
10. Install the [coin-cell battery](#).
11. Install the [display assembly](#).
12. Install the [battery](#).
13. Install the [solid-state drive in M.2 slot two](#).
14. Install the [solid-state drive in M.2 slot one](#).
15. Install the [WLAN card](#).
16. Install the [memory module](#).
17. Install the [base cover](#).
18. Follow the procedure in [After working inside your computer](#).

Drivers and downloads

When troubleshooting, downloading or installing drivers it is recommended that you read the Dell Knowledge Based article, Drivers and Downloads FAQ [SLN128938](#).

System setup

CAUTION: Unless you are an expert computer user, do not change the settings in the BIOS Setup program. Certain changes can make your computer work incorrectly.

NOTE: Depending on the computer and its installed devices, the items listed in this section may or may not be displayed.

NOTE: Before you change BIOS Setup program, it is recommended that you write down the BIOS Setup program screen information for future reference.

Use the BIOS Setup program for the following purposes:

- Get information about the hardware installed in your computer, such as the amount of RAM and the size of the hard drive.
- Change the system configuration information.
- Set or change a user-selectable option, such as the user password, type of hard drive installed, and enabling or disabling base devices.

Entering BIOS setup program

Steps

1. Turn on your computer.
2. Press F2 immediately to enter the BIOS setup program.

NOTE: If you wait too long and the operating system logo appears, continue to wait until you see the desktop. Then, turn off your computer and try again.

Navigation keys

NOTE: For most of the System Setup options, changes that you make are recorded but do not take effect until you restart the system.

Table 3. Navigation keys

Keys	Navigation
Up arrow	Moves to the previous field.
Down arrow	Moves to the next field.
Enter	Selects a value in the selected field (if applicable) or follow the link in the field.
Spacebar	Expands or collapses a drop-down list, if applicable.
Tab	Moves to the next focus area. NOTE: For the standard graphics browser only.
Esc	Moves to the previous page until you view the main screen. Pressing Esc in the main screen displays a message that prompts you to save any unsaved changes and restarts the system.

One time boot menu

To enter **one time boot menu**, turn on your computer, and then press F2 immediately.

NOTE: It is recommended to shutdown the computer if it is on.

The one-time boot menu displays the devices that you can boot from including the diagnostic option. The boot menu options are:

- Removable Drive (if available)
- STXXXX Drive (if available)

NOTE: XXX denotes the SATA drive number.

- Optical Drive (if available)
- SATA Hard Drive (if available)
- Diagnostics

NOTE: Choosing Diagnostics, will display the ePSA diagnostics screen.

The boot sequence screen also displays the option to access the System Setup screen.

System setup options

NOTE: Depending on this computer and its installed devices, the items that are listed in this section may or may not be displayed.

Table 4. System setup options—System information menu

Overview	
BIOS Version	Displays the BIOS version number.
Service Tag	Displays the Service Tag of the computer.
Asset Tag	Displays the Asset Tag of the computer.
Ownership Tag	Displays the ownership tag of the computer.
Manufacture Date	Displays the manufacture date of the computer.
Ownership Date	Displays the ownership date of the computer.
Express Service Code	Displays the express service code of the computer.
Ownership Tag	Displays the ownership tag of the computer.
Signed Firmware Update	Displays whether the signed firmware update is enabled.
Battery	Displays the battery health information.
Primary	Displays the primary battery.
Battery Level	Displays the battery level.
Battery State	Displays the battery state.
Health	Displays the battery health.
AC Adapter	Displays whether an AC adapter is installed.
Processor Information	
Processor Type	Displays the processor type.
Maximum Clock Speed	Displays the maximum processor clock speed.
Core Count	Displays the number of cores on the processor.
Processor L2 Cache	Displays the processor L2 Cache size.
Processor ID	Displays the processor identification code.
Processor L3 Cache	Displays the processor L3 Cache size.
Current Clock Speed	Displays the current processor clock speed.
Minimum Clock Speed	Displays the minimum processor clock speed.
Microcode Version	Displays the microcode version.

Table 4. System setup options—System information menu (continued)

Overview	
Intel Hyper-Threading Capable	Displays whether the processor is Hyper-Threading (HT) capable.
64-Bit Technology	Displays whether 64-bit technology is used.
Memory Information	
Memory Installed	Displays the total computer memory installed.
Memory Available	Displays the total computer memory available.
Memory Speed	Displays the memory speed.
Memory Channel Mode	Displays single or dual channel mode.
Memory Technology	Displays the technology that is used for the memory.
Device Information	
Video Controller	Displays the integrate graphics information of the computer.
dGPU Video Controller	Displays the discrete graphics information of the computer.
Video BIOS Version	Displays the video BIOS version of the computer.
Video Memory	Displays the video memory information of the computer.
Panel Type	Displays the Panel Type of the computer.
Native Resolution	Displays the native resolution of the computer.
Audio Controller	Displays the audio controller information of the computer.
Wi-Fi Device	Displays the wireless device information of the computer.
Bluetooth Device	Displays the Bluetooth device information of the computer.

Table 5. System setup options—Boot options menu

Boot options	
Advanced Boot Options	
Enable UEFI Network Stack	Enables or disables UEFI Network Stack. Default: OFF.
Boot Mode	
Boot Mode: UEFI only	Displays the boot mode of this computer.
Enable Boot Devices	Enables or disables boot devices for this computer.
Boot Sequence	Displays the boot sequence.
BIOS Setup Advanced Mode	Enables or disables advanced BIOS settings. Default: ON.
UEFI Boot Path Security	Enables or disables the system to prompt the user to enter the Admin password when booting a UEFI boot path from the F12 boot menu. Default: Always Except Internal HDD.

Table 6. System setup options—System Configuration menu

System Configuration	
Date/Time	
Date	Sets the computer date in MM/DD/YYYY format. Changes to the date take effect immediately.
Time	Sets the computer time in HH/MM/SS 24-hour format. You can switch between 12-hour and 24-hour clock. Changes to the time take effect immediately.

Table 6. System setup options—System Configuration menu (continued)

System Configuration	
Enable SMART Reporting	Enables or disables SMART (Self-Monitoring, Analysis, and Reporting Technology) during computer startup to report hard drive errors. Default: OFF.
Enable Audio	Enables or disables all integrated audio controller. Default: ON.
Enable Microphone	Enables or disables microphone. Default: ON.
Enable Internal Speaker	Enables or disables internal speaker. Default: ON.
USB Configuration	
Enable Boot Support	Enables or disables booting from USB mass storage devices such as external hard drive, optical drive, and USB drive.
Enable External USB Ports	Enables or disables USB ports to be functional in an operating system environment.
SATA Operation	
	Configures operating mode of the integrated SATA hard drive controller. Default: RAID. SATA is configured to support RAID (Intel Rapid Restore Technology).
Drives	
M.2 PCIe SSD-0/SATA-2	Enables or disables various onboard drives. Default: ON.
SATA-0	Default: ON.
Drive Information	Displays the information of various onboard drives.
Miscellaneous Devices	
Enable Camera	Enables or disables the camera. Default: ON.
Keyboard Illumination	Configures the operating mode of the keyboard illumination feature. Default: Disabled. The keyboard illumination will always be off.
Keyboard Backlight Timeout on AC	Configures the timeout value for the keyboard when an AC adapter is connected to the computer. The keyboard backlight timeout value is only effect when the backlight is enabled. Default: 10 seconds.
Keyboard Backlight Timeout on Battery	Configures the timeout value for the keyboard when the computer is running on battery. The keyboard backlight timeout value is only effect when the backlight is enabled. Default: 10 seconds.
Touchscreen	Enables or disables the touchscreen for the operating system. NOTE: Touchscreen will always work in the BIOS setup irrespective of this setting. Default: ON.

Table 7. System setup options—Video menu

Video	
LCD Brightness	
Brightness on battery power	Sets the screen brightness when the computer is running on battery power.

Table 7. System setup options—Video menu (continued)

Video	
Brightness on AC power	Sets the screen brightness when the computer is running on AC power.
EcoPower	Enables or disables EcoPower which increases the battery life by reducing the screen brightness when appropriate. Default: ON.

Table 8. System setup options—Security menu

Security	
Enable Admin Setup Lockout	Enables or disables the user from entering BIOS Setup when an Admin Password is set. Default: OFF.
Password Bypass	Bypass the System (Boot) Password and the internal hard drive password prompts during a system restart. Default: Disabled.
Enable Non-Admin Password Changes	Enables or disables the user to change the system and hard drive password without the need for admin password. Default: ON.
Non-Admin Setup Changes	
Allow Wireless Switch Changes	Enables or disables changes to the setup option when an Administrator password is set. Default: OFF.
Enable UEFI Capsule Firmware Updates	Enables or disables BIOS updates through UEFI capsule update packages.
Computrace	Enable or disable the BIOS module interface of the optional Computrace(R) Service from Absolute Software.
Intel Platform Trust Technology On	Enables or disables Platform Trust Technology (PTT) visibility to the operating system. Default: ON.
PPI Bypass for Clear Commands	Enables or disables the operating system to skip BIOS Physical Presence Interface (PPI) user prompts when issuing the Clear command. Default: OFF.
Clear	Enables or disables the computer to clear the PTT owner information, and returns the PTT to the default state. Default: OFF.
Intel SGX	Enables or disables the Intel Software Guard Extensions (SGX) to provide a secured environment for running code/storing sensitive information. Default: Software Control
SMM Security Mitigation	Enables or disables additional UEFI SMM Security Mitigation protections. Default: OFF.
	NOTE: This feature may cause compatibility issues or loss of functionality with some legacy tools and applications.
Enable Strong Passwords	Enables or disables strong passwords. Default: OFF.
Password Configuration	Control the minimum and maximum number of characters that are allowed for Admin and System passwords.

Table 8. System setup options—Security menu (continued)

Security	
Admin Password	Sets, Changes, or deletes the administrator (admin) password (sometimes called the "setup" password).
System Password	Sets, Changes, or deletes the system password.
Enable Master Password Lockout	Enables or disables the master password support. Default: OFF.

Table 9. System setup options—Secure Boot menu

Secure Boot	
Enable Secure Boot	Enables or disables the computer to boots using only validated boot software. Default: OFF. i NOTE: For Secure Boot to be enabled, the computer needs to be in UEFI boot mode and the Enable Legacy Option ROMs option needs to be turned off.
Secure Boot Mode	Selects the Secure Boot operation mode. Default: Deployed Mode. i NOTE: Deployed Mode should be selected for normal operation of Secure Boot.

Table 10. System setup options—Expert Key Management menu

Expert Key Management	
Enable Custom Mode	Enables or disables the keys in the PK, KEK, db, and dbx security key databases to be modified. Default: OFF.
Custom Mode Key Management	Selects the custom values for expert key management. Default: PK.

Table 11. System setup options—Performance menu

Performance	
Intel Hyper-Threading Technology	Enables or disables the Intel Hyper-Threading Technology to use processor resources more efficiently. Default: ON.
Intel SpeedStep	Enables or disables the Intel SpeedStep Technology to dynamically adjust processor voltage and core frequency, decreasing average power consumption and heat production. Default: ON.
Intel TurboBoost Technology	Enabled or disabled the Intel TurboBoost mode of the processor. If enabled, the Intel TurboBoost driver increases the performance of the CPU or graphics processor. Default: ON.
Multi-Core Support	Changes the number of CPU cores available to the operating system. The default value is set to the maximum number of cores. Default: All Cores.
Enable C-State Control	Enables or disables the CPU's ability to enter and exit low-power states. Default: ON.

Table 12. System setup options—Power Management menu

Power Management	
Wake on AC	Enables the computer to turn on and go to boot when AC power is supplied to the computer. Default: OFF.
Auto on Time	Enables the computer to automatically power on for defined days and times. Default: Disabled. The system will not automatically power up.
Battery Charge Configuration	Enables the computer to run on battery during power usage hours. Use the below options to prevent AC power usage between certain times of each day. Default: Adaptive. Battery settings are adaptively optimized based on your typical battery usage pattern.
Enable Advanced Battery Charge Configuration	Enables Advanced Battery Charge Configuration from the beginning of the day to a specified work period. Advanced Battery Charged maximizes battery health while still supporting heavy use during the work day. Default: OFF.
Block Sleep	Blocks the computer from entering Sleep (S3) mode in the operating system. Default: OFF. NOTE: If enabled, the computer will not go to sleep, Intel Rapid Start will be disabled automatically, and the operating system power option will be blank if it was set to Sleep.
Enable USB Wake Support	Enables the USB devices to wake the computer from Standby mode. Default: OFF.
Enable Intel Speed Shift Technology	Enables or disables Intel Speed Shift Technology support which enables the operating system to select the appropriate processor performance automatically. Default: ON.
Lid Switch	Enables the computer to power up from the off state whenever the lid is opened. Default: ON.

Table 13. System setup options—Wireless menu

Wireless	
Wireless Switch	Determines which wireless devices can be controlled by the Wireless Switch. For Windows 8 systems, this is controlled by an operating system drive directly. As a result, the setting does not affect the Wireless Switch behavior. NOTE: When both WLAN and WiGig are present, enable/disable controls are tied together. Thus, they cannot be enabled or disabled independently.
WLAN	Default: ON.
Bluetooth	Default: ON.
Wireless Device Enable	Enable or disable internal WLAN/Bluetooth devices.
WLAN	Default: ON.
Bluetooth	Default: ON.

Table 14. System setup options—POST Behavior menu

POST Behavior	
Numlock Enable	Enables or disables Numlock when the computer boots. Default: ON.
Enable Adapter Warnings	Enables the computer to display adapter warning messages during boot. Default: ON.
Extend BIOS POST Time	Configures the BIOS POST (Power-On Self-Test) load time. Default: 0 seconds.
Fastboot	Configures the speed of the UEFI boot process. Default: Thorough. Performs complete hardware and configuration initialization during boot.
Fn Lock Options	Enables or disables the Fn lock mode. Default: ON.
Lock Mode	Default: Lock Mode Secondary. Lock Mode Secondary = If this option is selected, the F1-F12 keys scan the code for their secondary functions.
Pull Screen Logo	Enabled or disabled the computer to display full screen logo if the image match screen resolution. Default: OFF.
Warnings and Errors	Selects an action on encountering a warning or error during boot. Default: Prompt on Warnings and Errors. Stop, prompt and wait for user input when warnings or errors are detected.
<p>NOTE: Errors deemed critical to the operation of the computer hardware will always halt the computer.</p>	

Table 15. System setup options—Virtualization menu

Virtualization	
Intel Virtualization Technology	Enables the computer to run a virtual machine monitor (VMM). Default: ON.
VT for Direct I/O	Enables the computer to perform Virtualization Technology for Direct I/O (VT-d). VT-d is an Intel method that provides virtualization for memory map I/O. Default: ON.

Table 16. System setup options—Maintenance menu

Maintenance	
Asset Tag	Creates a system Asset Tag that can be used by an IT administrator to uniquely identify a particular system. Once set in BIOS, the Asset Tag cannot be changed.
Service Tag	Displays the Service Tag of the computer.
BIOS Recovery from Hard Drive	Enables the computer to recover from a bad BIOS image, as long as the Boot Block portion is intact and functioning. Default: ON.
<p>NOTE: BIOS recovery is designed to fix the main BIOS block and cannot work if the Boot Block is damaged. In addition, this feature cannot work in the event of EC corruption, ME corruption, or a hardware issue. The recovery image must exist on an unencrypted partition on the drive.</p>	

Table 16. System setup options—Maintenance menu (continued)

Maintenance	
BIOS Auto-Recovery	Enables the computer to automatically recover the BIOS without user actions. This feature requires BIOS Recovery from Hard Drive to be set to Enabled. Default: OFF.
Start Data Wipe	 CAUTION: This Secure Wipe Operation will delete information in a way that it cannot be reconstructed. If enabled, the BIOS will queue up a data wipe cycle for storage devices that are connected to the motherboard on the next reboot. Default: OFF.
Allow BIOS Downgrade	Controls flashing of the system firmware to previous revisions. Default: ON.

Table 17. System setup options—System Logs menu

System Logs	
Power Event Log	Displays Power events. Default: Keep.
BIOS Event Log	Displays BIOS events. Default: Keep.
Thermal Event Log	Displays Thermal events. Default: Keep.

Table 18. System setup options—SupportAssist menu

SupportAssist	
Dell Auto operating system Recovery Threshold	Controls the automatic boot flow for SupportAssist System Resolution Console and for Dell operating system Recovery tool. Default: 2.
SupportAssist operating system Recovery	Enables or disables the boot flow for SupportAssist operating system Recovery tool in the even of certain system errors. Default: ON.

Updating the BIOS in Windows

Prerequisites

It is recommended to update your BIOS (System Setup), when you replace the system board or if an update is available. For laptops, ensure that your computer battery is fully charged and connected to a power outlet.

About this task

 **NOTE: If BitLocker is enabled, it must be suspended before updating the system BIOS, and then re-enabled after the BIOS update is completed.**

Steps

1. Restart the computer.
2. Go to www.dell.com/support.
 - Enter the **Service Tag** or **Express Service Code** and click **Submit**.

- Click **Detect Product** and follow the on-screen instructions.
3. If you are unable to detect or find the Service Tag, click **Choose from all products**.
 4. Choose the **Products** category from the list.

 **NOTE:** Choose the appropriate category to reach the product page.

5. Select your computer model and the **Product Support** page of your computer appears.
6. Click **Get drivers**, and then click **Drivers and Downloads**.
The Drivers and Downloads section is displayed.
7. Click **Find it myself**.
8. Click **BIOS** to view the BIOS versions.
9. Identify the latest BIOS file and click **Download**.
10. Select your preferred download method in the **Please select your download method below** window, and then click **Download File**.
The **File Download** window appears.
11. Click **Save** to save the file on your computer.
12. Click **Run** to install the updated BIOS settings on your computer.
Follow the on-screen instructions.

Updating BIOS on systems with BitLocker enabled

 **CAUTION:** If BitLocker is not suspended before updating the BIOS, the next time you reboot the system it will not recognize the BitLocker key. You will then be prompted to enter the recovery key to progress and the system will ask for this on each reboot. If the recovery key is not known this can result in data loss or an unnecessary operating system re-install. For more information on this subject, see Knowledge Article: <https://www.dell.com/support/article/sln153694>

Updating your system BIOS using a USB flash drive

About this task

If the computer cannot load into Windows but there is still a need to update the BIOS, download the BIOS file using another computer and save it to a bootable USB flash drive.

 **NOTE:** You must use a bootable USB flash drive. For more information, see the knowledge base article [SLN143196](#).

Steps

1. Download the BIOS update .exe file to another computer.
2. Copy the .exe file onto the bootable USB flash drive.
3. Insert the USB flash drive into the computer that requires the BIOS update.
4. Restart the computer and press F12 when the Dell logo appears to display the One Time Boot Menu.
5. Using arrow keys, select **USB Storage Device** and press Enter.
6. The computer restarts to a Diag C:\> prompt.
7. Run the file by typing the complete filename and press Enter.
8. The BIOS Update Utility is displayed. Follow the on-screen instructions.

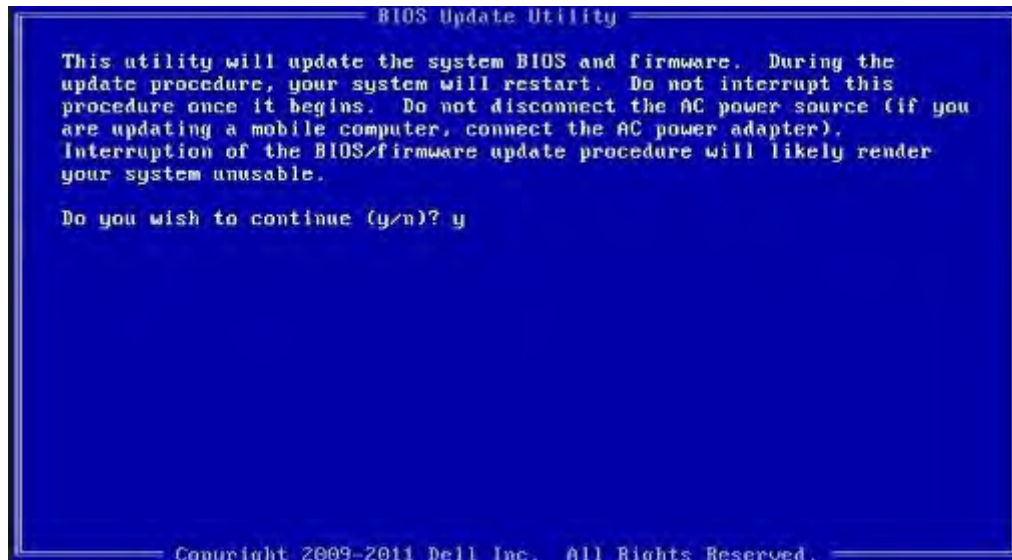

Figure 1. DOS BIOS Update Screen

Updating the Dell BIOS in Linux and Ubuntu environments

If you want to update the system BIOS in a Linux environment such as Ubuntu, see <https://www.dell.com/support/article/sln171755/>.

Flashing the BIOS from the F12 One-Time boot menu

Update your computer BIOS using the BIOS update.exe file that is copied to a FAT32 USB drive and booting from the F12 One-Time boot menu.

About this task

BIOS Update

You can run the BIOS update file from Windows using a bootable USB drive or you can also update the BIOS from the F12 One-Time boot menu on the computer.

Most of the Dell computers built after 2012 have this capability, and you can confirm by booting your computer to the F12 One-Time Boot Menu to see if BIOS FLASH UPDATE is listed as a boot option for your computer. If the option is listed, then the BIOS supports this BIOS update option.

NOTE: Only computers with BIOS Flash Update option in the F12 One-Time boot menu can use this function.

Updating from the One-Time boot menu

To update your BIOS from the F12 One-Time boot menu, you need the following:

- USB drive formatted to the FAT32 file system (key does not have to be bootable)
- BIOS executable file that you downloaded from the Dell Support website and copied to the root of the USB drive
- AC power adapter that is connected to the computer
- Functional computer battery to flash the BIOS

Perform the following steps to perform the BIOS update flash process from the F12 menu:

CAUTION: Do not turn off the computer during the BIOS update process. The computer may not boot if you turn off your computer.

Steps

1. From a turn off state, insert the USB drive where you copied the flash into a USB port of the computer.
2. Turn on the computer and press F12 to access the One-Time Boot Menu, select BIOS Update using the mouse or arrow keys then press Enter.
The flash BIOS menu is displayed.
3. Click **Flash from file**.
4. Select external USB device.
5. Select the file and double-click the flash target file, and then click **Submit**.
6. Click **Update BIOS**. The computer restarts to flash the BIOS.
7. The computer will restart after the BIOS update is completed.

System and setup password

Table 19. System and setup password

Password type	Description
System password	Password that you must enter to log in to your system.
Setup password	Password that you must enter to access and make changes to the BIOS settings of your computer.

You can create a system password and a setup password to secure your computer.

 **CAUTION:** The password features provide a basic level of security for the data on your computer.

 **CAUTION:** Anyone can access the data that is stored on your computer if it is not locked and left unattended.

 **NOTE:** System and setup password feature is disabled.

Assigning a system setup password

Prerequisites

You can assign a new **System or Admin Password** only when the status is in **Not Set**.

About this task

To enter the system setup, press F12 immediately after a power-on or reboot.

Steps

1. In the **System BIOS** or **System Setup** screen, select **Security** and press Enter.
The **Security** screen is displayed.
2. Select **System/Admin Password** and create a password in the **Enter the new password** field.
Use the following guidelines to assign the system password:
 - A password can have up to 32 characters.
 - The password can contain the numbers 0 through 9.
 - Only lower case letters are valid, upper case letters are not valid.
 - Only the following special characters are valid: Space, ("), (+), (,), (-), (.), (/), (:), ([), (\), (]), (`).
3. Type the system password that you entered earlier in the **Confirm new password** field and click **OK**.
4. Press Esc and a message prompt's you to save the changes.
5. Press Y to save the changes.
The computer restarts.

Deleting or changing an existing system setup password

Prerequisites

Ensure that the **Password Status** is Unlocked (in the System Setup) before attempting to delete or change the existing System and/or Setup password. You cannot delete or change an existing System or Setup password, if the **Password Status** is Locked.

About this task

To enter the System Setup, press F12 immediately after a power-on or reboot.

Steps

1. In the **System BIOS** or **System Setup** screen, select **System Security** and press Enter.
The **System Security** screen is displayed.
2. In the **System Security** screen, verify that **Password Status** is **Unlocked**.
3. Select **System Password**, update, or delete the existing system password, and press Enter or Tab.
4. Select **Setup Password**, update, or delete the existing setup password, and press Enter or Tab.

 **NOTE:** If you change the System and/or Setup password, reenter the new password when prompted. If you delete the System and/or Setup password, confirm the deletion when prompted.

5. Press Esc and a message prompts you to save the changes.
6. Press Y to save the changes and exit from System Setup.
The computer restarts.

Clearing CMOS settings

About this task

 **CAUTION:** Clearing CMOS settings will reset the BIOS settings on your computer.

Steps

1. Remove the [base cover](#).
2. Remove the [coin-cell battery](#).
3. Wait for one minute.
4. Replace the [coin-cell battery](#).
5. Replace the [base cover](#).

Clearing BIOS (System Setup) and System passwords

About this task

To clear the system or BIOS passwords, contact Dell technical support as described at www.dell.com/contactdell.

 **NOTE:** For information on how to reset Windows or application passwords, refer to the documentation accompanying Windows or your application.

Troubleshooting

Recovering the operating system

When your computer is unable to boot to the operating system even after repeated attempts, it automatically starts Dell SupportAssist OS Recovery.

Dell SupportAssist OS Recovery is a standalone tool that is preinstalled in all Dell computers installed with Windows 10 operating system. It consists of tools to diagnose and troubleshoot issues that may occur before your computer boots to the operating system. It enables you to diagnose hardware issues, repair your computer, back up your files, or restore your computer to its factory state.

You can also download it from the Dell Support website to troubleshoot and fix your computer when it fails to boot into their primary operating system due to software or hardware failures.

For more information about the Dell SupportAssist OS Recovery, see *Dell SupportAssist OS Recovery User's Guide* at www.dell.com/support.

System diagnostic lights

Battery-status light

Indicates the power and battery-charge status.

Solid white — Power adapter is connected and the battery has more than 5 percent charge.

Amber — Computer is running on battery and the battery has less than 5 percent charge.

Off

- Power adapter is connected and the battery is fully charged.
- Computer is running on battery and the battery has more than 5 percent charge.
- Computer is in sleep state, hibernation, or turned off.

The power and battery-status light blinks amber along with beep codes indicating failures.

For example, the power and battery-status light blinks amber two times followed by a pause, and then blinks white three times followed by a pause. This 2,3 pattern continues until the computer is turned off indicating no memory or RAM is detected.

The following table shows different power and battery-status light patterns and associated problems.

Table 20. LED codes

Diagnostic light codes	Problem description
2,1	Processor failure
2,2	System board: BIOS or ROM (Read-Only Memory) failure
2,3	No memory or RAM (Random-Access Memory) detected
2,4	Memory or RAM (Random-Access Memory) failure
2,5	Invalid memory installed
2,6	System-board or chipset error
2,7	Display failure
2,8	LCD power rail failure. Replace system board
3,1	Coin-cell battery failure
3,2	PCI, video card/chip failure

Table 20. LED codes (continued)

Diagnostic light codes	Problem description
3,3	Recovery image not found
3,4	Recovery image found but invalid
3,5	Power-rail failure
3,6	System BIOS Flash incomplete
3,7	Management Engine (ME) error

Camera status light: Indicates whether the camera is in use.

- Solid white — Camera is in use.
- Off — Camera is not in use.

Caps Lock status light: Indicates whether Caps Lock is enabled or disabled.

- Solid white — Caps Lock enabled.
- Off — Caps Lock disabled.

Enabling Intel Optane memory

Steps

1. On the taskbar, click the search box, and then type **Intel Rapid Storage Technology**.
2. Click **Intel Rapid Storage Technology**.
The **Intel Rapid Storage Technology** window is displayed.
3. On the **Status** tab, click **Enable** to enable the Intel Optane memory.
4. On the warning screen, select a compatible fast drive, and then click **Yes** to continue enabling Intel Optane memory.
5. Click **Intel Optane memory > Reboot** to complete enabling your Intel Optane memory.

 **NOTE:** Applications may take up to three subsequent launches after enablement to see the full performance benefits.

Disabling Intel Optane memory

About this task

 **CAUTION:** After disabling Intel Optane memory, do not uninstall the driver for Intel Rapid Storage Technology as it will result in a blue screen error. The Intel Rapid Storage Technology user interface can be removed without uninstalling the driver.

 **NOTE:** Disabling Intel Optane memory is required before removing the SATA storage device accelerated by the Intel Optane memory module from the computer.

Steps

1. On the taskbar, click the search box, and then type **Intel Rapid Storage Technology**.
2. Click **Intel Rapid Storage Technology**.
The **Intel Rapid Storage Technology** window is displayed.
3. On the **Intel Optane memory** tab, click **Disable** to disable the Intel Optane memory.

 **NOTE:** For computers in which Intel Optane memory acts as a primary storage, do not disable the Intel Optane memory. The Disable option will be grayed out.

4. Click **Yes** if you accept the warning.
The disabling progress is displayed.
5. Click **Reboot** to complete disabling your Intel Optane memory and restart your computer.

Flea power release

About this task

Flea power is the residual static electricity that remains on the computer even after it has been powered off and the battery has been removed. The following procedure provides the instructions on how to conduct flea power release:

Steps

1. Turn off your computer.
2. Remove the [base cover](#).
3. Remove the [battery](#).
4. Press and hold the power button for 15 seconds to drain the flea power.
5. Replace the [battery](#).
6. Replace the [base cover](#).
7. Turn on your computer.

WiFi power cycle

About this task

If your computer is unable to access the internet due to WiFi connectivity issues a WiFi power cycle procedure may be performed. The following procedure provides the instructions on how to conduct a WiFi power cycle:

 **NOTE: Some ISPs (Internet Service Providers) provide a modem/router combo device.**

Steps

1. Turn off your computer.
2. Turn off the modem.
3. Turn off the wireless router.
4. Wait for 30 seconds.
5. Turn on the wireless router.
6. Turn on the modem.
7. Turn on your computer.

Using Game Shift

Game Shift improves gaming performance by increasing the fan speed for optimal thermal cooling of the processor.

Enabling Game Shift

To enable Game Shift, press **F7** (if **fn** default is enabled; otherwise, press **fn + F7**). For more information, see [Keyboard shortcuts](#).

Alienware Command Center displays a blue G icon, a notification pops up to indicate that Game Shift is enabled.

Disabling Game Shift

When you are not using the computer for gaming, disable Game Shift by pressing **F7** (if **fn** default is enabled; otherwise, press **fn + F7**).

Game Shift is also disabled when:

- You set your computer to a sleep state.
- You restart your computer.
- Game Shift has been active for 24 consecutive hours.
- You start a new game.
- You terminate the game that has been running on Game Shift.
- You change power plans or thermal profiles of the computer.

Installing Game Shift after reinstalling the operating system

Alienware Command Center and Alienware OC Controls are installed at the factory. If you reinstall the operating system, you have to reinstall Alienware Command Center and Alienware OC Controls before you can use Game Shift.

NOTE: Ensure that the Windows operating system and all the compatible drivers are reinstalled in your computer. Windows update is also required.

After you have reinstalled the operating system, Alienware Command Center, and Alienware OC Controls, install Game Shift:

1. Go to Dell support site www.dell.com/support.
2. Enter Dell G3 15 3500 and click **Search**.
3. Click **Drivers & downloads**.
4. Download and install **Alienware Command Center**.
5. Download and install **Alienware OC Controls**.
6. Restart your computer. You can now enable Game Shift (see [Enabling Game Shift](#)).

Keyboard shortcuts

NOTE: Keyboard characters may differ depending on the keyboard language configuration. Keys used for shortcuts remain the same across all language configurations.

Some keys on your keyboard have two symbols on them. These keys can be used to type alternate characters or to perform secondary functions. The symbol shown on the lower part of the key refers to the character that is typed out when the key is pressed. If you press **Shift** and the key, the symbol shown on the upper part of the key is typed out. For example, if you press **2**, **2** is typed out; if you press **Shift + 2**, **@** is typed out.

The keys **F1** to **F12** at the top row of the keyboard are function keys for multi-media control, as indicated by the icon at the bottom of the key. Press the function key to invoke the task represented by the icon. For example, pressing **F1** mutes the audio (refer to the table below).

However, if the function keys **F1** to **F12** are needed for specific software applications, multi-media functionality can be disabled by pressing **fn + Esc**. Subsequently, multi-media control can be invoked by pressing **fn** and the respective function key. For example, mute audio by pressing **fn + F1**.

NOTE: You can also define the primary behavior of the function keys (**F1** to **F12**) by changing **Function Key Behavior** in the BIOS setup program.

Table 21. List of keyboard shortcuts





































Function key	Redefined key (for multimedia control)	Behavior
	 + 	Mute audio
	 + 	Decrease volume
	 + 	Increase volume
	 + 	Play previous track/chapter
	 + 	Play/Pause
	 + 	Play next track/chapter

Table 21. List of keyboard shortcuts (continued)

Function key	Redefined key (for multimedia control)	Behavior
	 + 	Enable/disable Game Shift
	 + 	Switch to external display
	 + 	Search
	 + 	Toggle keyboard backlight (optional) NOTE: Non-backlight keyboards have the F10 function key without the backlight icon. In this case, the function key does not toggle the keyboard backlight function.
	 + 	Decrease brightness
	 + 	Increase brightness

The **Fn** key is also used with selected keys on the keyboard to invoke other secondary functions.

Table 22. List of keyboard shortcuts





















Function key	Behavior
 + 	Turn off/on wireless
 + 	Pause/Break
 + 	Sleep
 + 	Toggle scroll lock
 + 	Toggle between power and battery-status light/hard-drive activity light
 + 	System request
 + 	Open application menu
 + 	Toggle fn-key lock

Table 22. List of keyboard shortcuts (continued)



Function key	Behavior
 The image shows two dark grey keyboard keys. The left key is labeled 'fn' and the right key is labeled 'pg up'. They are separated by a plus sign.	Page up
 The image shows two dark grey keyboard keys. The left key is labeled 'fn' and the right key is labeled 'pg dn'. They are separated by a plus sign.	Page down
 The image shows two dark grey keyboard keys. The left key is labeled 'fn' and the right key is labeled 'home'. They are separated by a plus sign.	Home
 The image shows two dark grey keyboard keys. The left key is labeled 'fn' and the right key is labeled 'end'. They are separated by a plus sign.	End

Getting help and contacting Dell

Self-help resources

You can get information and help on Dell products and services using these self-help resources:

Table 23. Self-help resources

Self-help resources	Resource location
Information about Dell products and services	www.dell.com
My Dell	
Tips	
Contact Support	In Windows search, type <code>Contact Support</code> , and press Enter.
Online help for operating system	www.dell.com/support/windows www.dell.com/support/linux
Troubleshooting information, user manuals, setup instructions, product specifications, technical help blogs, drivers, software updates, and so on.	www.dell.com/support
Dell knowledge base articles for a variety of computer concerns.	<ol style="list-style-type: none"> 1. Go to https://www.dell.com/support/home/?app=knowledgebase. 2. Type the subject or keyword in the Search box. 3. Click Search to retrieve the related articles.
Learn and know the following information about your product: <ul style="list-style-type: none"> · Product specifications · Operating system · Setting up and using your product · Data backup · Troubleshooting and diagnostics · Factory and system restore · BIOS information 	See <i>Me and My Dell</i> at www.dell.com/support/manuals . To locate the <i>Me and My Dell</i> relevant to your product, identify your product through one of the following: <ul style="list-style-type: none"> · Select Detect Product. · Locate your product through the drop-down menu under View Products. · Enter the Service Tag number or Product ID in the search bar.

Contacting Dell

To contact Dell for sales, technical support, or customer service issues, see www.dell.com/contactdell.

 **NOTE: Availability varies by country and product, and some services may not be available in your country.**

 **NOTE: If you do not have an active internet connection, you can find contact information on your purchase invoice, packing slip, bill, or Dell product catalog.**