

# **RS200-E9 Series**

**RS200-E9-PS2**

**RS200-E9-PS2-F**

## **1U Rackmount Server User Guide**

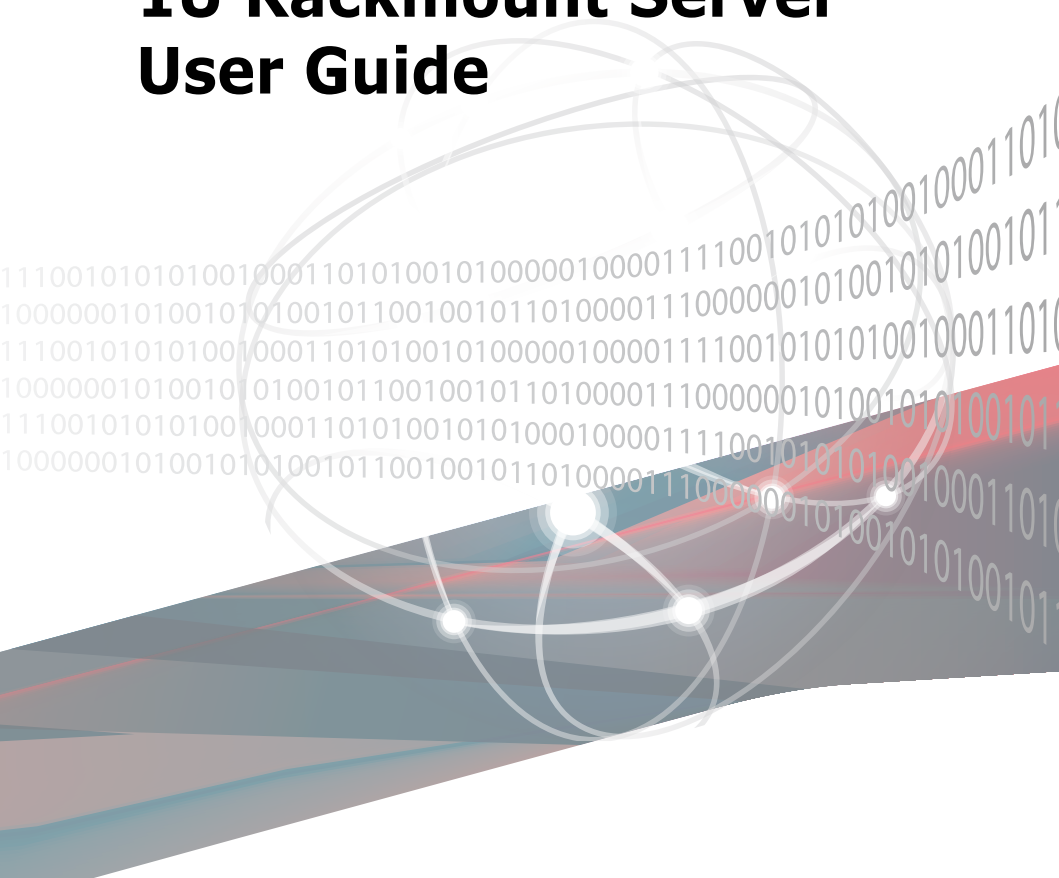

**Copyright © 2017 ASUSTeK COMPUTER INC. All Rights Reserved.**

No part of this manual, including the products and software described in it, may be reproduced, transmitted, transcribed, stored in a retrieval system, or translated into any language in any form or by any means, except documentation kept by the purchaser for backup purposes, without the express written permission of ASUSTeK COMPUTER INC. ("ASUS").

ASUS provides this manual "as is" without warranty of any kind, either express or implied, including but not limited to the implied warranties or conditions of merchantability or fitness for a particular purpose. In no event shall ASUS, its directors, officers, employees, or agents be liable for any indirect, special, incidental, or consequential damages (including damages for loss of profits, loss of business, loss of use or data, interruption of business and the like), even if ASUS has been advised of the possibility of such damages arising from any defect or error in this manual or product.

Specifications and information contained in this manual are furnished for informational use only, and are subject to change at any time without notice, and should not be construed as a commitment by ASUS. ASUS assumes no responsibility or liability for any errors or inaccuracies that may appear in this manual, including the products and software described in it.

Product warranty or service will not be extended if: (1) the product is repaired, modified or altered, unless such repair, modification or alteration is authorized in writing by ASUS; or (2) the serial number of the product is defaced or missing.

Products and corporate names appearing in this manual may or may not be registered trademarks or copyrights of their respective companies, and are used only for identification or explanation and to the owners' benefit, without intent to infringe.

# Contents

<b>Notices</b> .....	<b>vii</b>
REACH .....	vii
<b>Safety information</b> .....	<b>viii</b>
Australia statement notice.....	ix
<b>About this guide</b> .....	<b>x</b>

## **Chapter 1: Product Introduction**

<b>1.1</b>	<b>System package contents</b> .....	<b>1-2</b>
<b>1.2</b>	<b>Serial number label</b> .....	<b>1-3</b>
<b>1.3</b>	<b>System specifications</b> .....	<b>1-4</b>
<b>1.4</b>	<b>Front panel features</b> .....	<b>1-6</b>
<b>1.5</b>	<b>Rear panel features</b> .....	<b>1-7</b>
<b>1.6</b>	<b>Internal features</b> .....	<b>1-9</b>
<b>1.7</b>	<b>LED information</b> .....	<b>1-12</b>
1.7.1	Front panel LEDs .....	1-12
1.7.2	LAN (RJ-45) LEDs .....	1-13
1.7.3	Dedicated Management LAN LED .....	1-13
1.7.4	HDD status LED.....	1-13

## **Chapter 2 Hardware Information**

<b>2.1</b>	<b>Chassis cover</b> .....	<b>2-2</b>
<b>2.2</b>	<b>Central Processing Unit (CPU)</b> .....	<b>2-4</b>
2.2.1	Installing the CPU .....	2-4
2.2.2	Installing the CPU heatsink.....	2-7
<b>2.3</b>	<b>System memory</b> .....	<b>2-8</b>
2.3.1	Overview .....	2-8
2.3.2	Memory configurations.....	2-8
2.3.3	Installing a DIMM on a single clip DIMM socket.....	2-9
<b>2.4</b>	<b>Hard disk drives</b> .....	<b>2-10</b>
<b>2.5</b>	<b>Expansion slot</b> .....	<b>2-14</b>
2.5.1	Installing an expansion card to the riser card bracket.....	2-14
2.5.2	Installing M.2 (NGFF) cards .....	2-16
2.5.3	Configuring an expansion card .....	2-17
<b>2.6</b>	<b>Cable connections</b> .....	<b>2-19</b>
<b>2.7</b>	<b>Removable/optional components</b> .....	<b>2-20</b>
2.7.1	System fans .....	2-20
2.7.2	Installing ASUS PIKE II RAID card (optional) .....	2-23
2.7.3	Installing the SSD cage (optional).....	2-25

# Contents

## Chapter 3: Installation Options

3.1	Tool-less Friction Rail Kit.....	3-2
-----	----------------------------------	-----

## Chapter 4: Motherboard Information

4.1	Motherboard layout.....	4-2
4.2	Onboard LEDs.....	4-5
4.3	Jumpers.....	4-8
4.4	Connectors.....	4-12
4.4.1	Rear panel connectors.....	4-12
4.4.2	Q-Code table.....	4-13
4.4.3	Internal connectors.....	4-15

## Chapter 5: BIOS Setup

5.1	Managing and updating your BIOS.....	5-2
5.1.1	ASUS CrashFree BIOS 3 utility.....	5-2
5.1.2	ASUS EzFlash Utility.....	5-3
5.1.3	BUPDATER utility.....	5-4
5.2	BIOS setup program.....	5-6
5.2.1	BIOS menu screen.....	5-7
5.2.2	Menu bar.....	5-7
5.2.3	Menu items.....	5-8
5.2.4	Submenu items.....	5-8
5.2.5	Navigation keys.....	5-8
5.2.6	General help.....	5-8
5.2.7	Configuration fields.....	5-8
5.2.8	Pop-up window.....	5-8
5.2.9	Scroll bar.....	5-8
5.3	Main menu.....	5-9
5.3.1	System Date.....	5-9
5.3.2	System Time.....	5-9
5.4	Advanced menu.....	5-10
5.4.1	Trusted Computing.....	5-10
5.4.2	Chipset Configuration.....	5-11
5.4.3	Platform Configuration.....	5-20
5.4.4	CPU Configuration.....	5-30
5.4.5	SATA Configuration.....	5-33
5.4.6	Network Stack Configuration.....	5-35
5.4.7	CSM Configuration.....	5-36
5.4.8	iSCSI Configuration.....	5-37

# Contents

5.5	Security menu .....	5-37
5.6	Boot menu .....	5-40
5.7	Monitor menu .....	5-41
5.8	Tool menu.....	5-41
5.9	Save & Exit menu.....	5-42
5.10	Server Mgmt menu.....	5-43
5.11	Event Logs menu .....	5-46

## Chapter 6: RAID Configuration

6.1	Setting up RAID.....	6-2
6.1.1	RAID definitions .....	6-2
6.1.2	Installing hard disk drives.....	6-3
6.1.3	Setting the RAID item in BIOS .....	6-3
6.1.4	RAID configuration utilities.....	6-3
6.2	<b>Intel® Rapid Storage Technology enterprise SATA Option ROM Utility.....</b>	<b>6-4</b>
6.2.1	Creating a RAID set .....	6-5
6.2.2	Deleting a RAID set.....	6-7
6.2.3	Resetting disks to Non-RAID .....	6-8
6.2.4	Exiting the Intel® Rapid Storage Technology enterprise SATA Option ROM utility.....	6-9
6.2.5	Rebuilding the RAID.....	6-9
6.2.6	Setting the Boot array in the BIOS Setup Utility.....	6-11
6.3	<b>Intel® Rapid Storage Technology enterprise (Windows).....</b>	<b>6-12</b>
6.3.1	Creating a RAID set .....	6-13
6.3.2	Changing a Volume Type.....	6-15
6.3.3	Deleting a volume .....	6-16
6.3.4	Preferences.....	6-17

# Contents

## Chapter 7: Driver Installation

7.1	RAID driver installation .....	7-2
7.1.1	Creating a USB flash drive with RAID driver.....	7-2
7.1.2	Installing the RAID controller driver.....	7-2
7.2	Management applications and utilities installation .....	7-5
7.3	Running the Support DVD .....	7-5
7.4	Installing the Intel® Chipset device Software driver .....	7-8
7.5	Installing the Intel® I210 Gigabit Adapters driver .....	7-11
7.6	Installing the VGA driver .....	7-13

## Appendix

P10S-C/4L/SYS block diagram.....	A-2
ASUS contact information.....	A-3

# Notices

## Federal Communications Commission Statement

This device complies with Part 15 of the FCC Rules. Operation is subject to the following two conditions:

- This device may not cause harmful interference, and
- This device must accept any interference received including interference that may cause undesired operation.

This equipment has been tested and found to comply with the limits for a Class A digital device, pursuant to part 15 of the FCC Rules. These limits are designed to provide reasonable protection against harmful interference when the equipment is operated in a commercial environment. This equipment generates, uses, and can radiate radio frequency energy and, if not installed and used in accordance with the instruction manual, may cause harmful interference to radio communications. Operation of this equipment in a residential area is likely to cause harmful interference in which case the user will be required to correct the interference at his own expense.



---

The use of shielded cables for connection of the monitor to the graphics card is required to assure compliance with FCC regulations. Changes or modifications to this unit not expressly approved by the party responsible for compliance could void the user's authority to operate this equipment.

---

## Compliance Statement of Innovation, Science and Economic Development Canada (ISED)

This device complies with Innovation, Science and Economic Development Canada licence exempt RSS standard(s). Operation is subject to the following two conditions: (1) this device may not cause interference, and (2) this device must accept any interference, including interference that may cause undesired operation of the device.

CAN ICES-3(A)/NMB-3(A)

## Déclaration de conformité de Innovation, Sciences et Développement économique Canada (ISED)

Le présent appareil est conforme aux CNR d'Innovation, Sciences et Développement économique Canada applicables aux appareils radio exempts de licence. L'exploitation est autorisée aux deux conditions suivantes : (1) l'appareil ne doit pas produire de brouillage, et (2) l'utilisateur de l'appareil doit accepter tout brouillage radioélectrique subi, même si le brouillage est susceptible d'en compromettre le fonctionnement.

CAN ICES-3(A)/NMB-3(A)

## REACH

Complying with the REACH (Registration, Evaluation, Authorization, and Restriction of Chemicals) regulatory framework, we publish the chemical substances in our products at ASUS REACH website at <http://csr.asus.com/english/REACH.htm>.

# Safety information

## Electrical Safety

- Before installing or removing signal cables, ensure that the power cables for the system unit and all attached devices are unplugged.
- To prevent electrical shock hazard, disconnect the power cable from the electrical outlet before relocating the system.
- When adding or removing any additional devices to or from the system, ensure that the power cables for the devices are unplugged before the signal cables are connected. If possible, disconnect all power cables from the existing system before you add a device.
- If the power supply is broken, do not try to fix it by yourself. Contact a qualified service technician or your dealer.

## Operation Safety

- Any mechanical operation on this server must be conducted by certified or experienced engineers.
- Before operating the server, carefully read all the manuals included with the server package.
- Before using the server, ensure all cables are correctly connected and the power cables are not damaged. If any damage is detected, contact your dealer as soon as possible.
- To avoid short circuits, keep paper clips, screws, and staples away from connectors, slots, sockets and circuitry.
- Avoid dust, humidity, and temperature extremes. Place the server on a stable surface.



This product is equipped with a three-wire power cable and plug for the user's safety. Use the power cable with a properly grounded electrical outlet to avoid electrical shock.

### Lithium-Ion Battery Warning

**CAUTION!** Danger of explosion if battery is incorrectly replaced. Replace only with the same or equivalent type recommended by the manufacturer. Dispose of used batteries according to the manufacturer's instructions.

**CLASS 1 LASER PRODUCT**

### Heavy System

**CAUTION!** This server system is heavy. Ask for assistance when moving or carrying the system.



---

**DO NOT** throw the motherboard in municipal waste. This product has been designed to enable proper reuse of parts and recycling. This symbol of the crossed out wheeled bin indicates that the product (electrical and electronic equipment) should not be placed in municipal waste. Check local regulations for disposal of electronic products.

---



---

**DO NOT** throw the mercury-containing button cell battery in municipal waste. This symbol of the crossed out wheeled bin indicates that the battery should not be placed in municipal waste.

---

## Australia statement notice

From 1 January 2012 updated warranties apply to all ASUS products, consistent with the Australian Consumer Law. For the latest product warranty details please visit <https://www.asus.com/support>. Our goods come with guarantees that cannot be excluded under the Australian Consumer Law. You are entitled to a replacement or refund for a major failure and compensation for any other reasonably foreseeable loss or damage. You are also entitled to have the goods repaired or replaced if the goods fail to be of acceptable quality and the failure does not amount to a major failure.

If you require assistance please call ASUS Customer Service 1300 2787 88 or visit us at <https://www.asus.com/support/>

# About this guide

## Audience

This user guide is intended for system integrators, and experienced users with at least basic knowledge of configuring a server.

## Contents

This guide contains the following parts:

**1. Chapter 1: Product Introduction**

This chapter describes the general features of the server, including sections on front panel and rear panel specifications.

**2. Chapter 2: Hardware Information**

This chapter lists the hardware setup procedures that you have to perform when installing or removing system components.

**3. Chapter 3: Installation Options**

This chapter describes how to install optional components into the barebone server.

**4. Chapter 4: Motherboard Information**

This chapter gives information about the motherboard that comes with the server. This chapter includes the motherboard layout, jumper settings, and connector locations.

**5. Chapter 5: BIOS Setup**

This chapter tells how to change system settings through the BIOS Setup menus and describes the BIOS parameters.

**6. Chapter 6: RAID Configuration**

This chapter tells how to change system settings through the BIOS Setup menus. Detailed descriptions of the BIOS parameters are also provided.

**7. Chapter 7: Driver Installation**

This chapter provides instructions for installing the necessary drivers for different system components.

## Conventions

To ensure that you perform certain tasks properly, take note of the following symbols used throughout this manual.



**DANGER/WARNING:** Information to prevent injury to yourself when trying to complete a task.



**CAUTION:** Information to prevent damage to the components when trying to complete a task.



**IMPORTANT:** Instructions that you **MUST** follow to complete a task.



**NOTE:** Tips and additional information to help you complete a task.

## Typography

### **Bold text**

Indicates a menu or an item to select.

### *Italics*

Used to emphasize a word or a phrase.

### <Key>

Keys enclosed in the less-than and greater-than sign means that you must press the enclosed key.

Example: <Enter> means that you must press the Enter or Return key.

### <Key1>+<Key2>+<Key3>

If you must press two or more keys simultaneously, the key names are linked with a plus sign (+).

Example: <Ctrl>+<Alt>+<Del>

### Command

Means that you must type the command exactly as shown, then supply the required item or value enclosed in brackets.

Example: At the DOS prompt, type the command line: **format A:/S**

## References

Refer to the following sources for additional information, and for product and software updates.

### 1. **ASUS Server Web-based Management (ASWM) user guide**

This manual tells how to set up and use the proprietary ASUS server management utility.

### 2. **ASUS websites**

The ASUS websites worldwide provide updated information for all ASUS hardware and software products. Refer to the ASUS contact information.



# Product Introduction

# 1

This chapter describes the motherboard features and the new technologies it supports.

## 1.1 System package contents

Check your system package for the following items.

Model Name	RS200-E9-PS2, RS200-E9-PS2-F
Chassis	ASUS R9D 1U Rackmount Chassis
Motherboard	ASUS P10S-C/4L/SYS Server Board
Component	1 x 250W Single Power Supply
	2 x Hot-swap 2.5-inch HDD Trays
	1 x Internal SSD Cage
	1 x 2-ports Backplane for SSD
	1 x PCI-E Riser Card
	1 x I/O Board
	4 x System Fans (40 mm x 28 mm) (for RS200-E9-PS2)
	3 x System Fans (40 mm x 28 mm) (for RS200-E9-PS2-F)
Accessories	1 x RS200-E9 Series Support DVD
	1 x ASWM* DVD
	1 x CPU Heatsink
	1 x Bag of Screws
Optional Items	1 x AC Power Cable
	1 x ASMB8-iKVM
	1 x COM port
	1 x Tool-less Friction Rail Kit

\*ASUS System Web-based Management



If any of the above items is damaged or missing, contact your retailer.

# 1.2 Serial number label

Before requesting support from the ASUS Technical Support team, you must take note of the product's serial number containing 12 characters such as xxS0xxxxxxx shown as the figure below. With the correct serial number of the product, ASUS Technical Support team members can then offer a quicker and satisfying solution to your problems.



## 1.3 System specifications

The ASUS RS200-E9-PS2, RS200-E9-PS2-F is a 1U barebone server system featuring the ASUS P10S-C/4L/SYS Server Board. The server supports Intel® LGA1151 Intel® Xeon® E3-1200 Processor v5 plus other latest technologies through the chipsets onboard.

Model Name		RS200-E9-PS2	RS200-E9-PS2-F
Processor Support / System Bus		1 x Socket LGA1151 Intel® Xeon® processor E3-1200 v5 product family	
Core Logic		Intel® C232 Chipset	
Memory	Total Slots	4 (2-Channels)	
	Capacity	Maximum up to 64 GB UDIMM	
	Memory Type	DDR4 2133 UDIMM non ECC and with ECC	
	Memory Size	16GB, 8GB and 4GB (UDIMM) * Refer to <a href="http://www.asus.com">www.asus.com</a> for the latest memory AVL update.	
Expansion Slots	Total PCI/PCI-E/PIKE Slots	2	
	Slot Type	1 x PCI-E x16 (x8 Gen3 link) 1 x PCI-E x8 (x8 Gen3 link)	
Storage	SATA Controller	Intel® C232 6 x SATA3 6Gb/s ports (4 by miniSAS HD + 2 x SATA) 2 x M.2 connectors (2280/2260/2242) Intel® Rapid Storage Technology Enterprise(RSTe) (For Windows; Support Software RAID 0, 1, 5, 10)	
	SAS Controller	ASUS PIKE II 3008-8i 8-port SAS 12G RAID card (Optional) ASUS PIKE II 3108-8i 8-port SAS 12G HW RAID card (Optional)	
HDD Bays	I = internal A or S = hot-swappable	2 x Hot-swap 2.5-inch SSD Bays 2 x 2.5-inch Internal Disk Bays (optional) 2 x M.2 (NGFF 2280/2260/2242)	
Networking	LAN	4 x Intel® I210T + 1 x Management LAN	
System Fans		4 x System Fan (40 mm x 28 mm)	3 x System Fan (40 mm x 28 mm)
Graphic	VGA	ASPEED AST2400 32MB	

(continued on the next page)

Model Name		RS200-E9-PS2	RS200-E9-PS2-F
Onboard I/O Connectors		1 x External Serial Port (optional) 4 x RJ-45 GbE port 1 x RJ-45 management port (for optional ASMB8 i-KVM only) 2 x USB 2.0 ports 2 x USB 3.0 ports 1 x VGA port 1 x PS/2 keyboard/mouse combo port	
Switch / LED indicators		<b>Front Switch / LED</b> 1 x Power switch / LED 1 x Location switch / LED 1 x HDD access LED 1 x Message LED LAN 1-4 LED  <b>Rear Switch / LED</b> 1 x Q-Code / Port 80 LED indicators panel 1 x Power switch	<b>Front Switch / LED</b> 1 x Q-Code / Port 80 LED indicators panel 1 x Power switch  <b>Rear Switch / LED</b> 1 x Power switch / LED 1 x Location switch / LED 1 x HDD access LED 1 x Message LED LAN 1-4 LED
OS Support		Windows® Server 2012 R2 Windows® Server 2012 RedHat® Enterprise Linux SuSE® Linux Enterprise Server CentOS VMWare Citrix XenServer  * Refer to <a href="http://www.asus.com">www.asus.com</a> for updates.	
Management Solution	Software	ASWM Enterprise	
	Out of Band Remote Management (optional)	ASMB8-iKVM for KVM-over-Internet	
Dimension (DD x WW x HH)		383 mm x 444 mm x 44 mm (1U)	
Net Weight Kg (CPU, DRAM & HDD not included)		6.15 Kg	
Power Supply		Single 250W 80 PLUS Bronze Power Supply	
Power Rating		100-240V, 4A, 50-60Hz, Class I	
Environment		Operating temperature: 10°C – 35°C Non operation temperature: -40°C – 70°C Non operation humidity: 20% – 90% (Non condensing)	

\*Specifications are subject to change without notice.

## 1.4 Front panel features

The barebone server displays a simple yet stylish front panel with easily accessible features. The power and reset buttons, LED indicators, and USB ports for each Node are located on the front panel.



Refer to the 1.7.1 Front panel LEDs section for the LED descriptions.



Turn off the system power and detach the power supply before removing or replacing any system component.

### RS200-E9-PS2

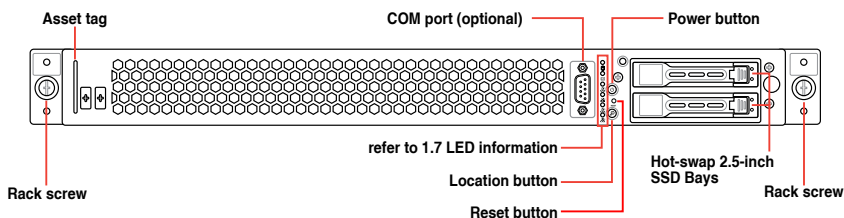

### RS200-E9-PS2-F



The ports for the USB, VGA, and Gigabit LANs do not appear on the front panel if the motherboard is not present.

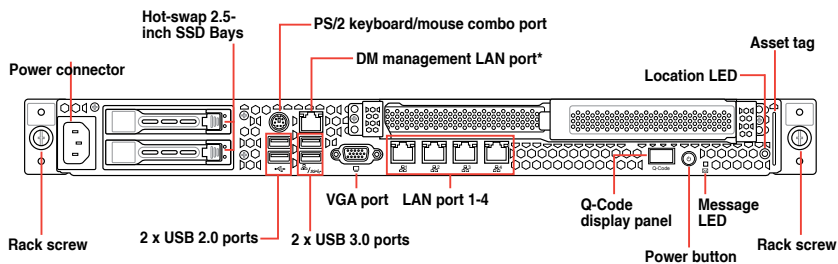

\* This port is for ASUS ASMB8-iKVM controller and for technicians only.

# 1.5 Rear panel features

The rear panel includes the expansion slots, system power sockets, and rear fans. The I/O shields with openings for the rear panel connectors on the motherboard are also placed in the rear panel.



The ports for the USB, VGA, and Gigabit LANs do not appear on the rear panel if the motherboard is not present.

## RS200-E9-PS2

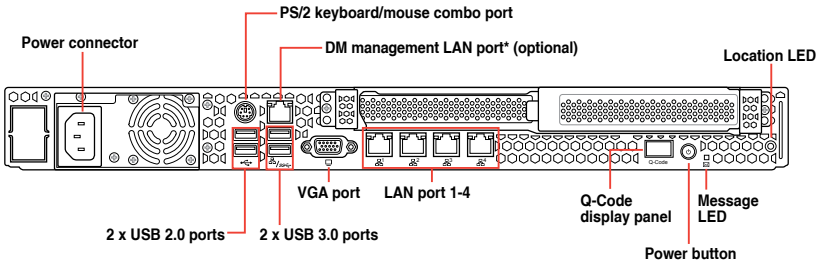

\* This port is for ASUS ASMB8-iKVM controller and for technicians only.

## RS200-E9-PS2-F

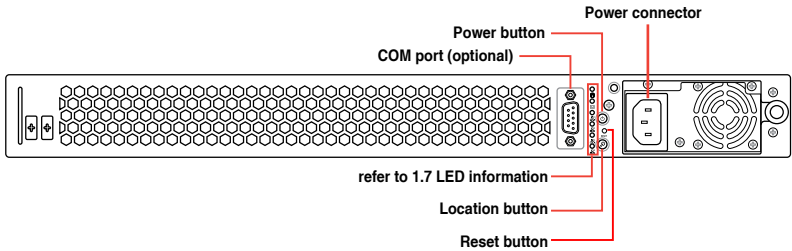

**Asset tag**

The Asset tag is a simple but useful device that is conveniently located on the front panel of the server that you can pull out or easily slide back in. It has a piece of paper that allows you to write down important information about to the server.

**RS200-E9-PS2**

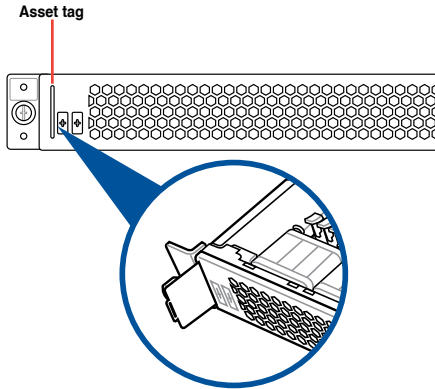

**RS200-E9-PS2-F**

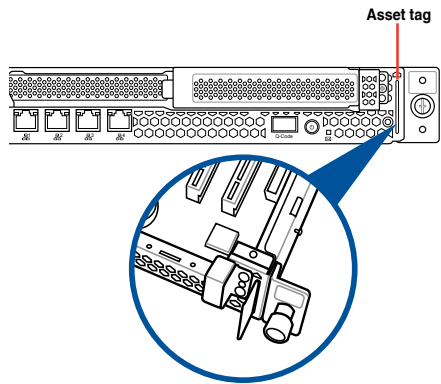

## 1.6 Internal features

The barebone server includes the basic components as shown.

### RS200-E9-PS2

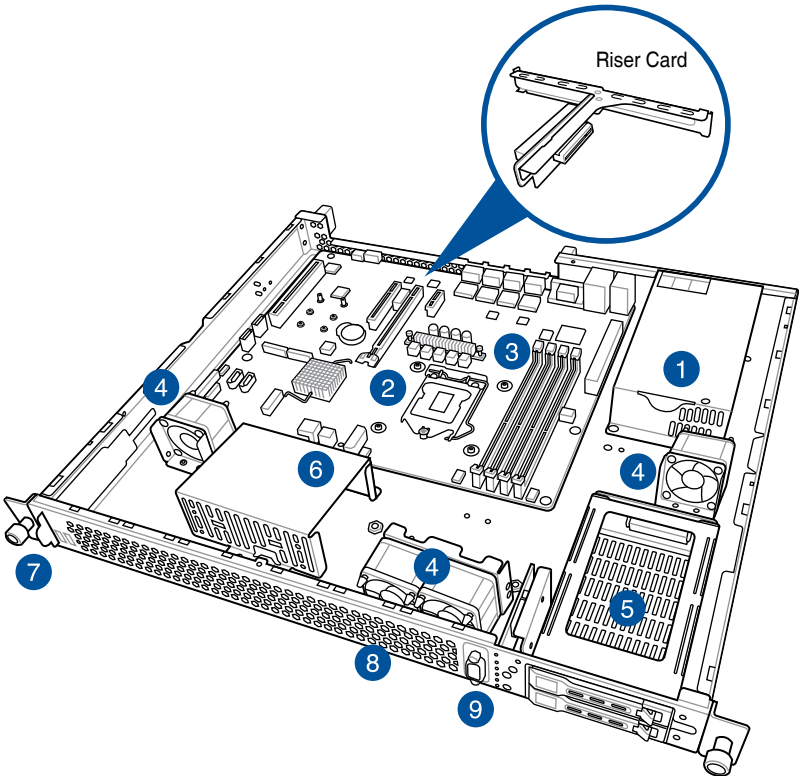

1. Power supply and power fan
2. PCI Express slot (with Riser Card installed by factory default)
3. ASUS P10S-C/4L/SYS Server Board
4. System fans (40mm x 28mm)
5. 2.5-inch SSD Bays
6. Internal SSD Cage
7. Asset Tag
8. Front I/O panel
9. COM port (optional)

# RS200-E9-PS2-F

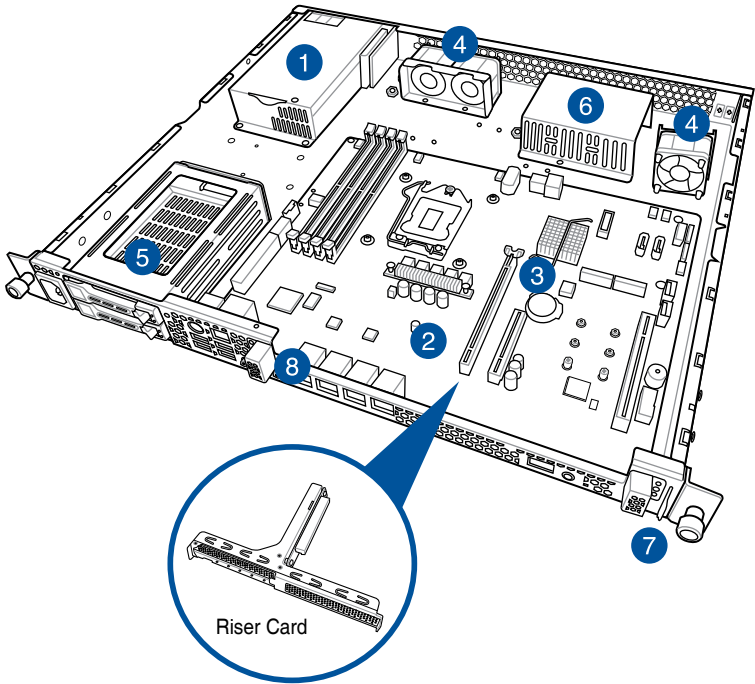

1. Power supply and power fan
2. PCI Express slot (with Riser Card installed by factory default)
3. ASUS P10S-C/4L/SYS Server Board
4. System fans (40mm x 28mm)
5. 2.5-inch SSD Bays
6. Internal SSD Cage
7. Asset Tag
8. Front I/O panel



---

Turn off the system power and detach the power supply before removing or replacing any system component.

---



---

The barebone server does not include a floppy disk drive. Connect a USB floppy disk drive to any of the USB ports on the front or rear panel if you need to use a floppy disk.

---

**WARNING**  
**HAZARDOUS MOVING PARTS**  
**KEEP FINGERS AND OTHER BODY PARTS AWAY**

# 1.7 LED information

## 1.7.1 Front panel LEDs

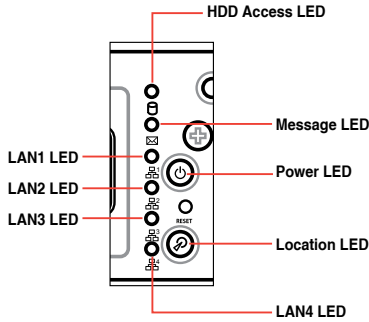

LED	Icon	Display status	Description
Power LED		ON	System power ON
HDD Access LED		OFF	No activity
		Blinking	Read/write data into the HDD
Message LED		OFF	System is normal; no incoming event
		ON	With the onboard ASMB8-iKVM: a hardware monitor event is indicated
LAN LEDs		OFF	No LAN connection
		Blinking	LAN is transmitting or receiving data
		ON	LAN connection is present
Location LED		ON	Location switched is pressed
		OFF	Normal status (Press the location switch again to turn off)

## 1.7.2 LAN (RJ-45) LEDs

Activity/Link LED		Speed LED	
Status	Description	Status	Description
OFF	No link	OFF	10 Mbps connection
GREEN	Linked	ORANGE	100 Mbps connection
BLINKING	Data activity	GREEN	1 Gbps connection

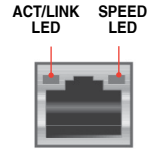

## 1.7.3 Dedicated Management LAN LED

Activity/Link LED		Speed LED	
Status	Description	Status	Description
OFF	No link	OFF	10 Mbps connection
ORANGE	Linked	ORANGE	100 Mbps connection
BLINKING	Data activity	GREEN	1 Gbps connection

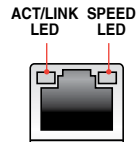

## 1.7.4 HDD status LED

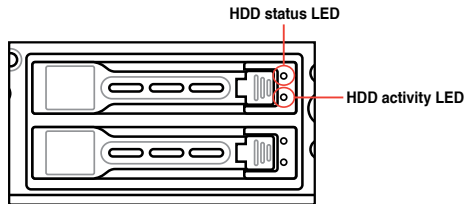

HDD LED Description		
HDD Status LED	GREEN	Power ON (HDD detected)
	RED	RAID disk has failed and should be swapped immediately (Error detected in the installed HDD)
	Blinking GREEN/RED	RAID rebuilding
	OFF	No HDD installed
HDD Activity LED	Blinking GREEN	Read/write data from/to HDD



# Hardware Information

# 2

This chapter lists the hardware setup procedures that you have to perform when installing or removing system components.

## 2.1 Chassis cover

### 2.1.1 Removing the rear cover



- Unplug the power cord from the power connector before removing the cover.
- Be careful when removing the chassis cover. When removing any system component, be careful with the CPU fan, chassis fan and other sharp edge to avoid hurting your fingers.
- The illustrations in this chapter are for reference only. The appearance may vary depending on the model, but the installation steps are basically the same.

#### To open the chassis cover:

1. Loosen the six (6) thumbscrews on the cover with a Phillips screwdriver to release the cover from the chassis, then lift the cover to remove the chassis cover.

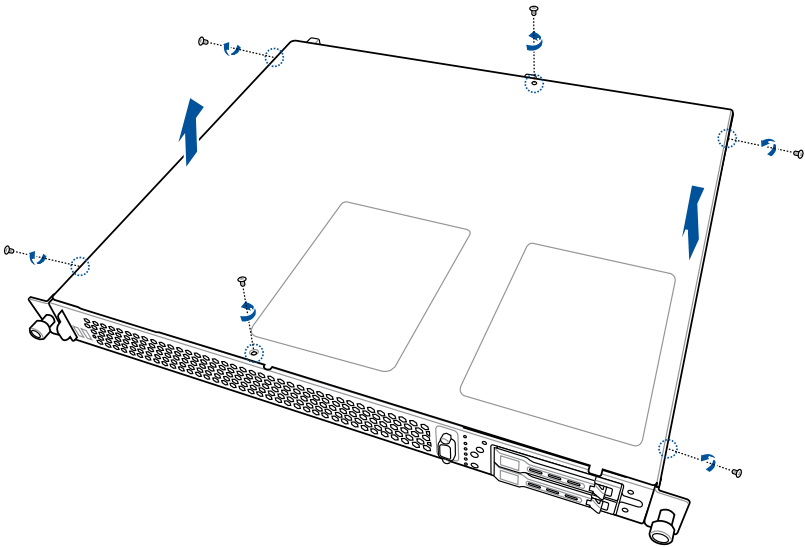

## 2.1.2 Recovering the rear cover

1. Place the cover onto the chassis then secure the cover to the chassis with the screws you removed earlier.

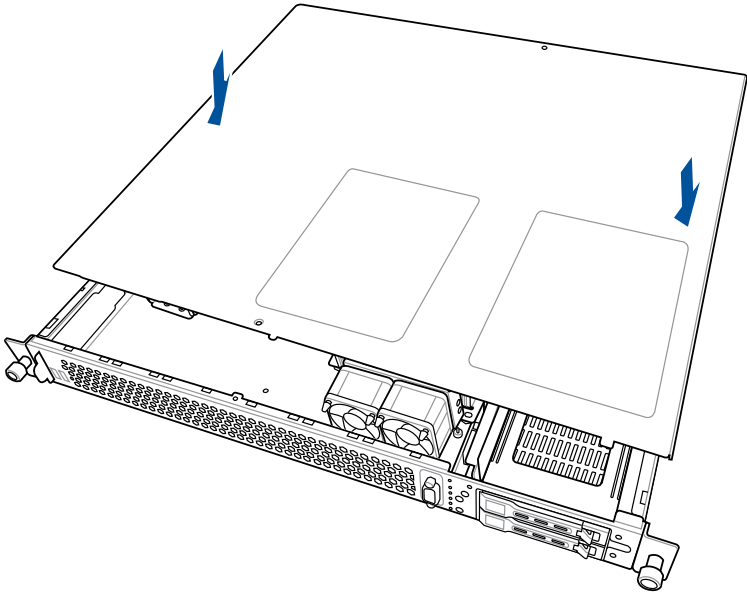

## 2.2 Central Processing Unit (CPU)

The motherboard comes with two surface mount LGA 1151 sockets designed for the Intel® Xeon® E5-1200 v5 processor family.



---

Ensure that all power cables are unplugged before installing the CPU.

---



- Upon purchase of the motherboard, ensure that the PnP cap is on the socket and the socket contacts are not bent. Contact your retailer immediately if the PnP cap is missing, or if you see any damage to the PnP cap/socket contacts/motherboard components. ASUS shoulders the repair cost only if the damage is shipment/transit-related.
  - Keep the cap after installing the motherboard. ASUS will process Return Merchandise Authorization (RMA) requests only if the motherboard comes with the cap on the LGA 1151 socket.
  - The product warranty does not cover damage to the socket contacts resulting from incorrect CPU installation/removal, or misplacement/loss/incorrect removal of the PnP cap.
- 

### 2.2.1 Installing the CPU

To install a CPU:

1. Locate the CPU socket on the motherboard.

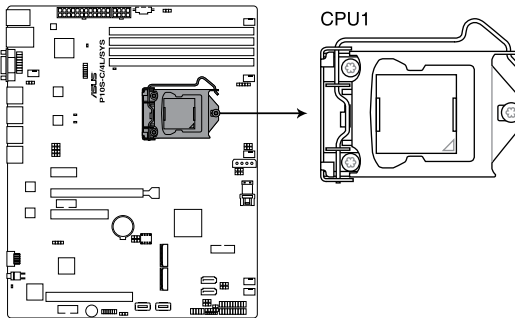

**P10S-C/4L/SYS CPU LGA1151**



---

Before installing the CPU, ensure that the socket box is facing toward you and the load lever is on your right.

---

2. Press the load lever with your thumb (A), then move it to the right (B) until it is released from the retention tab.



Do not remove the PnP cap yet from the CPU socket. Doing so may bend the pins of the socket.

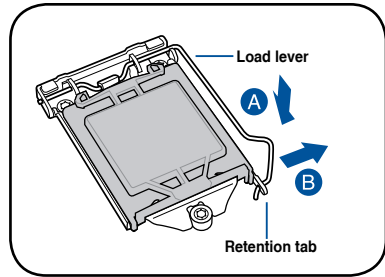

3. Lift the load lever until the load plate is completely lifted.

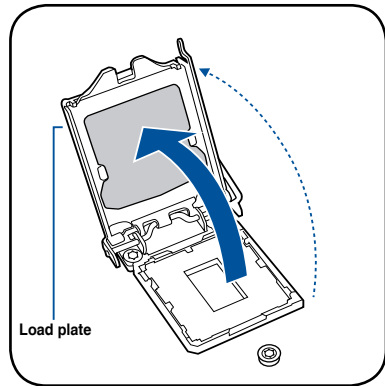

4. Position the CPU above the socket, ensuring that the gold triangle mark is on the bottom-left corner of the socket, then fit the CPU notches to the socket's alignment keys.



The CPU fits in only one orientation. DO NOT force the CPU into the socket to prevent bending the pins on the socket and damaging the CPU.

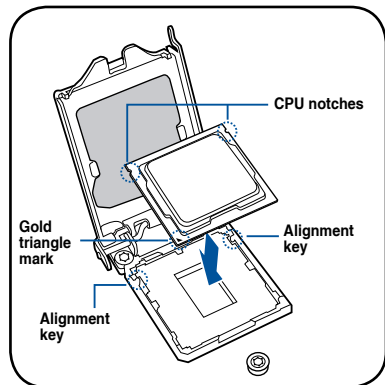

5. Close the load plate (A), ensuring that the front edge of the load plate slides under the retention lock (B) then push down the load lever (C).

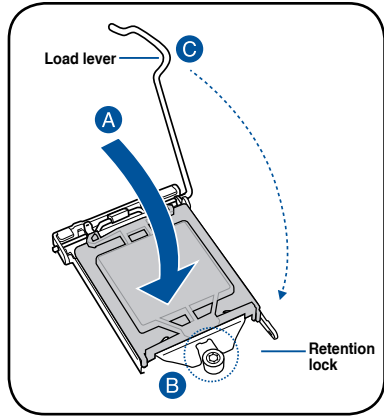

6. Insert the load lever under the retention tab to remove the PnP cap from the CPU socket.

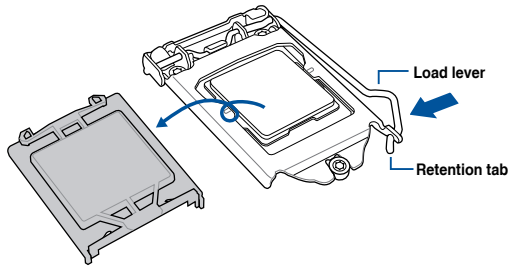

7. Apply some Thermal Interface Material to the exposed area of the CPU that the heatsink will be in contact with, ensuring that it is evenly spread in a thin layer.



Some heatsinks come with pre-applied Thermal Interface Material. If so, skip this step.



The Thermal Interface Material is toxic and inedible. DO NOT eat it. If it gets into your eyes or touches your skin, wash it off immediately and seek professional medical help.

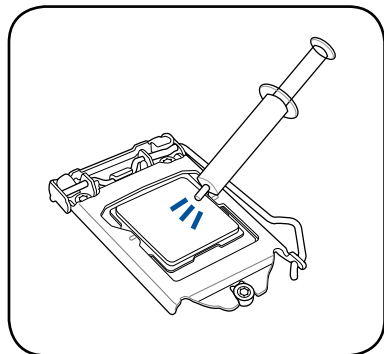

## 2.2.2 Installing the CPU heatsink

To install the CPU heatsink:

1. Remove the protection sticker on the back of the CPU heatsink.

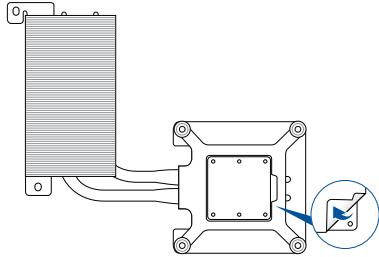

2. Place the heatsink on top of the installed CPU, ensuring that the four fasteners match the holes on the motherboard.

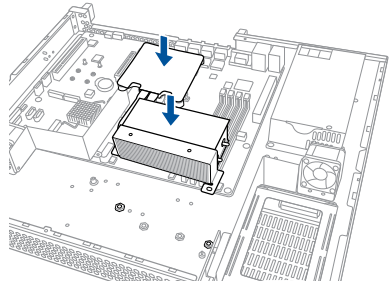

3. Twist each of the six (6) screws with a Phillips (cross) screwdriver just enough to attach the heatsink and air duct to the motherboard. When the six (6) screws are attached, tighten them one by one to completely secure the heatsink and air duct.

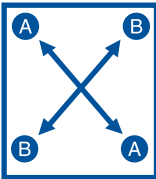
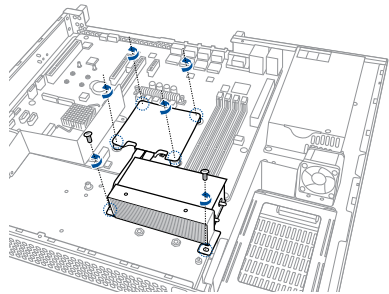

- Tighten the four heatsink screws in a diagonal sequence.
- Do not remove the mylar on the heatsink.

## 2.3 System memory

### 2.3.1 Overview

The motherboard comes with four Double Data Rate 4 (DDR4) Dual Inline Memory Modules (DIMM) sockets.



A DDR4 module is notched differently from a DDR, DDR2, or DDR3 module. DO NOT install a DDR, DDR2, or DDR3 memory module to the DDR4 slot.

The figure illustrates the location of the DDR4 DIMM sockets:

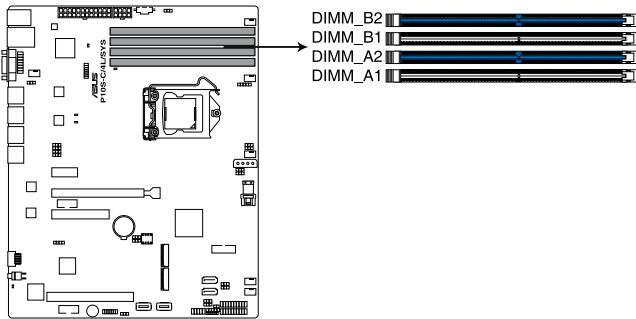

**P10S-C/4L/SYS 288-pin DDR4 DIMM sockets**

### 2.3.2 Memory configurations

You may install Unbuffered DDR4 DIMMs into the DIMM sockets using the memory configurations in this section.

UDIMM				
DIMM Slot Per Channel	DIMM Populated per Channel	DIMM Type	Speed	Rank per DIMM
2	1	Unbuffered DDR4	2133	Single Rank, Dual Rank
2	2	Unbuffered DDR4	2133	Single Rank, Dual Rank



- Always install DIMMs with the same CAS latency. For optimum compatibility, it is recommended that you obtain memory modules from the same vendor.
- Start installing the DIMMs in slots A2 and B2 (Blue).

### 2.3.3 Installing a DIMM on a single clip DIMM socket

1. Unlock a DIMM socket by pressing the retaining clip outward.
2. Align a DIMM on the socket such that the notch on the DIMM matches the DIMM slot key on the socket.

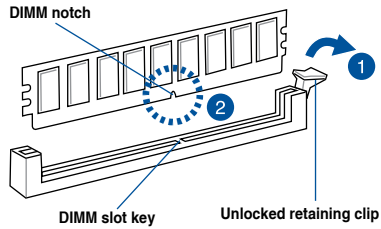

A DIMM is keyed with a notch so that it fits in only one direction. **DO NOT** force a DIMM into a socket in the wrong direction to avoid damaging the DIMM.

3. Hold the DIMM by both of its ends then insert the DIMM vertically into the socket. Apply force to both ends of the DIMM simultaneously until the retaining clip snaps back into place and the DIMM cannot be pushed in any further to ensure proper sitting of the DIMM.

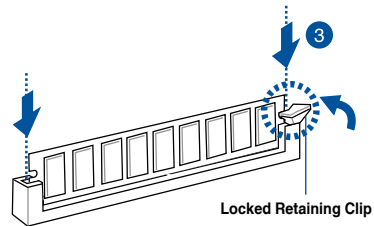

Always insert the DIMM into the socket vertically to prevent DIMM notch damage.



- To install two or more DIMMs, refer to the user guide bundled in the motherboard package.
- Refer to the user guide for qualified vendor lists of the memory modules.

### Removing a DIMM from a single clip DIMM socket

1. Press the retaining clip outward to unlock the DIMM.
2. Remove the DIMM from the socket.

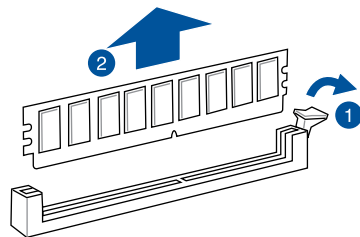

Support the DIMM lightly with your fingers when pressing the retaining clips. The DIMM might get damaged when it flips out with extra force.

## 2.4 Hard disk drives

The system supports two 2.5-inch SSD.

### Installing a 2.5-inch SSD

To install a 2.5-inch SSD:

1. Switch the secure tab to the right to release the tray lever.

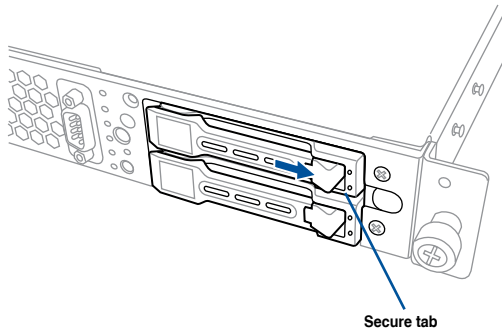

2. Pull the tray lever outward. The drive tray ejects slightly after you pull out the lever.

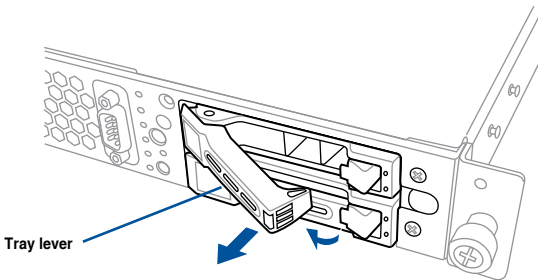

3. Firmly hold the tray lever and pull the drive tray out of the bay and put it on a flat surface.

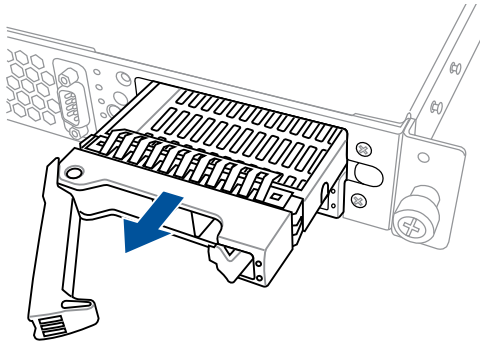

4. Remove two screws on the two sides of the support bar at the back of the drive tray.



---

The support bar supports the drive tray horizontally to prevent the drive tray from bending or deforming.

---

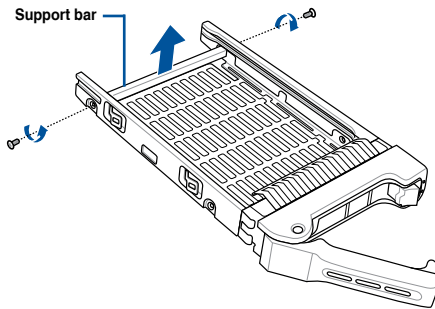

5. Place a SSD into the tray with the screw holes on the SSD fit the ones on the drive tray.

Ensure to fit the four screw holes on the SSD to the screw holes on the drive tray.

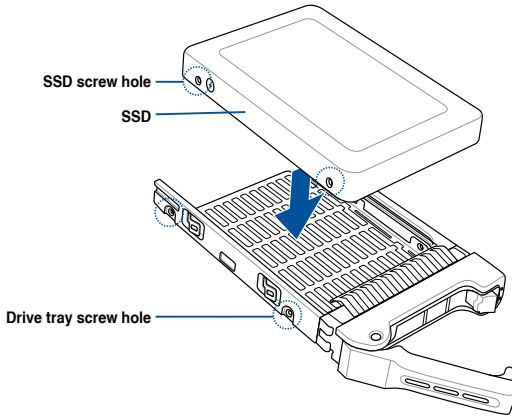

6. Then secure it with four screws (2 screws on each side).

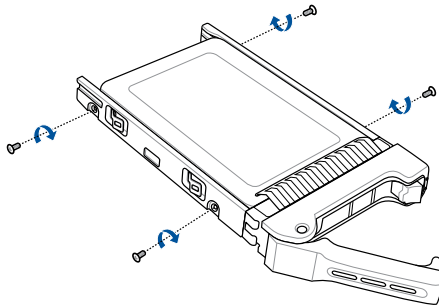

7. Carefully insert the drive tray and push it all the way to the depth of the bay.

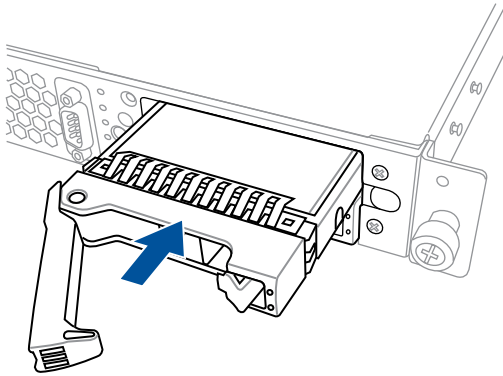

8. Lock the secure tab to secure the drive tray in place.

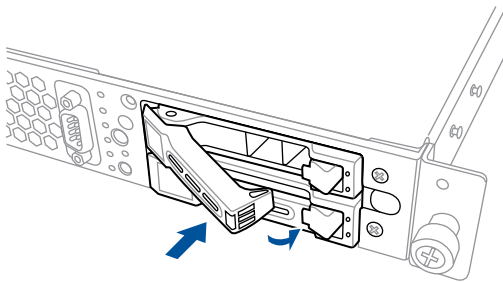

---

When installed, the connector on the SSD connects to the interface on the backplane.

---

9. Repeat steps 1 to 8 if you wish to install a second 2.5-inch SSD.

## 2.5 Expansion slot

### 2.5.1 Installing an expansion card to the riser card bracket

The barebone server comes with two riser card brackets allowing you to install PCI Express x8 or x16 expansion cards.

#### Open the secure lock

Before removing the riser card bracket, follow the steps below to open the secure lock:

1. Remove the screws on the secure lock of the riser card bracket using a screw driver (one on each side).
2. Push the right secure lock to the right and the left secure lock to the left to release the riser card bracket.

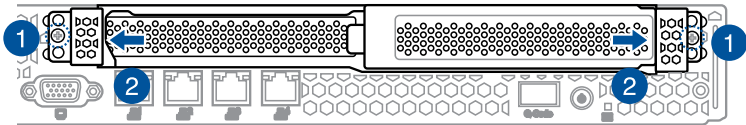

3. Lift and remove the riser card bracket.

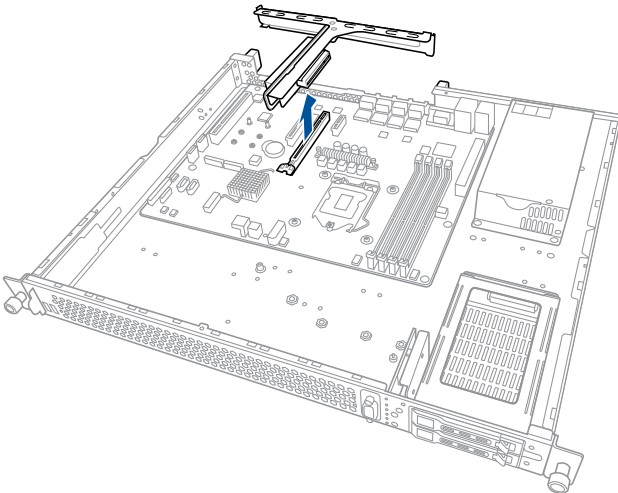

4. Place the riser card bracket on a flat and stable surface, then remove the screw from the slot bay.

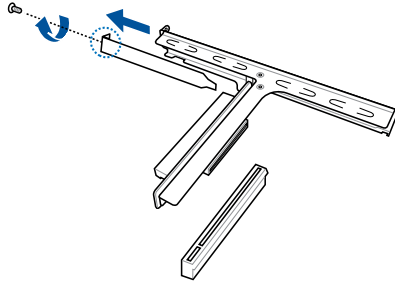

5. Install a PCI Express x8 or x16 card to the bracket as shown.
6. Secure the card with a screw.

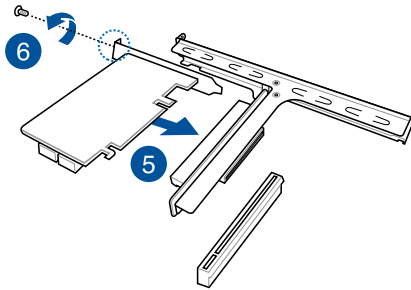

7. Install the riser card bracket and PCI Express card assembly back into the PCI Express x16 slot on the motherboard.

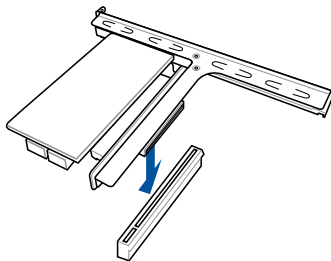

## 2.5.2 Installing M.2 (NGFF) cards

To install an M.2 card:

1. Locate the M.2 connector (NGFF1) on the motherboard.
2. Remove the screw on the stand screw.
3. Prepare the M.2 card.
4. Align and insert the M.2 card into the M.2 connector (NGFF1).
5. Secure the M.2 card with the screw you removed in step 2.

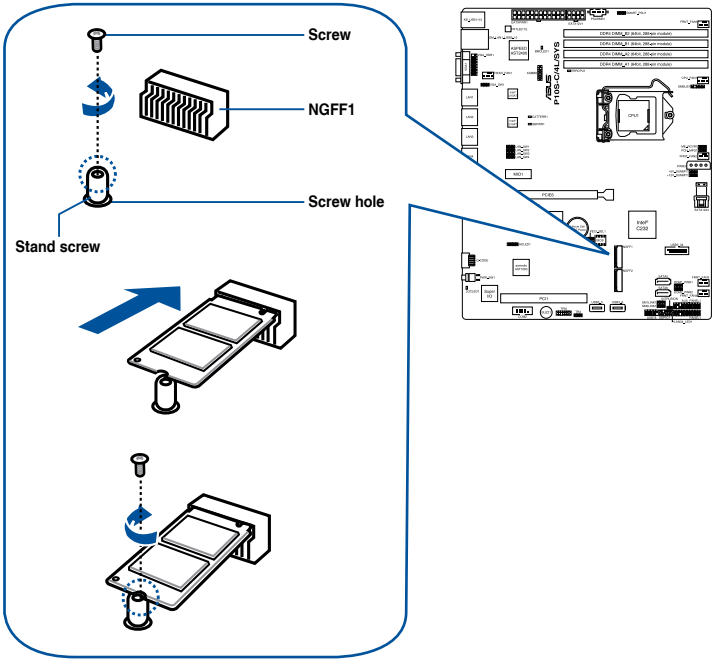

- Please pay attention when removing the screw, the stand screw might be removed together with it.
- Ensure that the M.2 card is positioned between the screw and the stand screw before securing it.

## 2.5.3 Configuring an expansion card

After installing the expansion card, configure the it by adjusting the software settings.

1. Turn on the system and change the necessary BIOS settings, if any. See Chapter 5 for information on BIOS setup.
2. Assign an IRQ to the card. Refer to the following tables.
3. Install the software drivers for the expansion card.

### Standard Interrupt assignments

IRQ	Priority	Standard function
0	1	System Timer
1	2	Keyboard Controller
2	-	Programmable Interrupt
3*	11	Communications Port (COM2)
4*	12	Communications Port (COM1)
5*	13	--
6	14	Floppy Disk Controller
7*	15	--
8	3	System CMOS/Real Time Clock
9*	4	ACPI Mode when used
10*	5	IRQ Holder for PCI Steering
11*	6	IRQ Holder for PCI Steering
12*	7	PS/2 Compatible Mouse Port
13	8	Numeric Data Processor
14*	9	Primary IDE Channel
15*	10	Secondary IDE Channel

\* These IRQs are usually available for ISA or PCI devices.

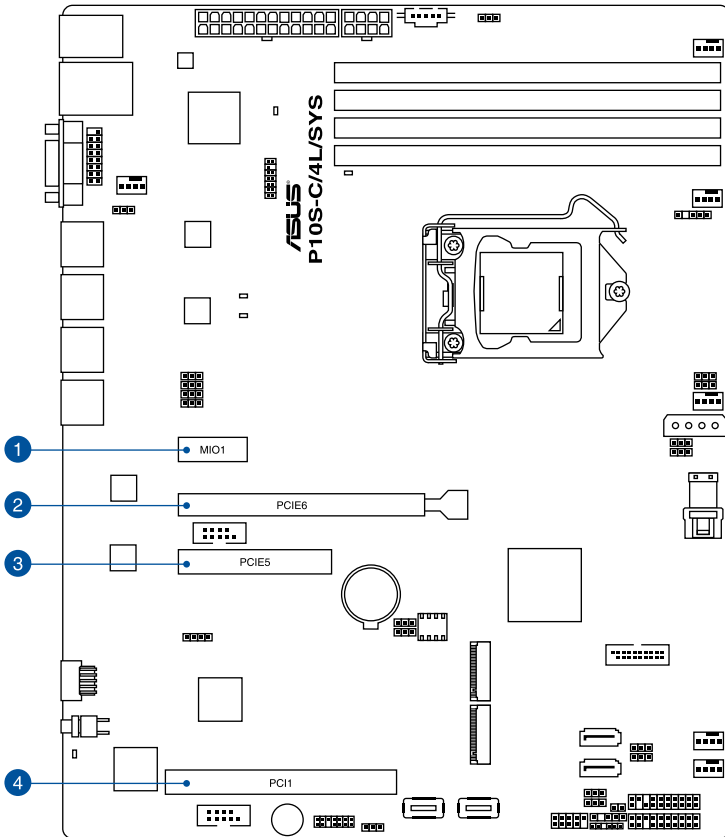

No.(Slot location)		Short Description
1 (slot 7)	MIO1	MIO slot
2 (slot 6)	PCIe6	PCI-E x16 (x16 Gen3 link) (Auto switch to x8 link if slot 5 is occupied)
3 (slot 5)	PCIe5	PCI-E x8 (x8 Gen3 link)
4 (slot 1)	PCI1	PCI 32 bit / 33 MHz

## 2.6 Cable connections



- The bundled system cables are pre-connected before shipment. You do not need to disconnect these cables unless you will remove pre-installed components to install additional devices.
- Refer to Chapter 4 for detailed information on the connectors.

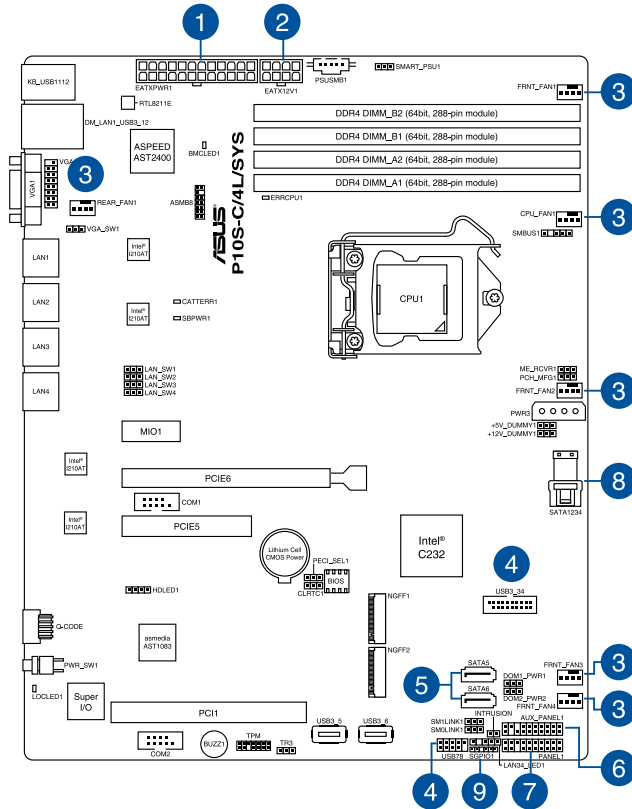

### Standard cables connected to the motherboard

1. 24-pin ATX power connector (from power supply to motherboard)
2. 8-pin 12V power connector (from power supply to motherboard)
3. System fan connector (from system fan to motherboard)
4. USB connector
5. SATA ports connectors
6. System auxiliary panel connector (from motherboard to rear I/O board)
7. System panel connector (from motherboard to rear I/O board)
8. Mini-SAS HD connector (from motherboard to SATA backplane)
9. Serial General Purpose Input/Output connectors

## 2.7 Removable/optional components

You may need to remove previously installed system components when installing or removing system devices. Or you may need to install the optional components into the system. This section tells how to remove/install the system fans:



---

Ensure that the system is turned off before removing any components from your system.

---



---

The position of the components may vary per model, but the steps to remove or install them are the same.

---

### 2.7.1 System fans

To uninstall the different system fans, follow the steps below

#### System Fan 1

1. Remove the screws located on the bottom of the system.

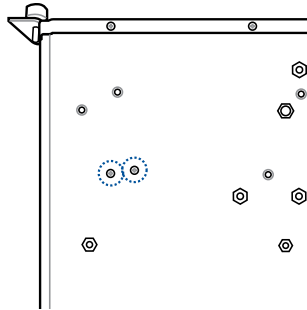

2. Disconnect the system fan cable from the fan connector on the motherboard, then lift the fan and set it aside.

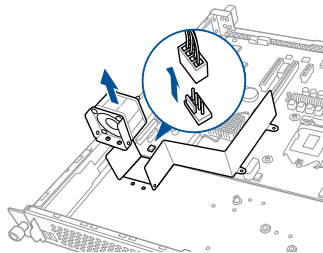

## System Fan 2 and 3

1. Remove the two (2) screws securing the system fans, then disconnect the cable from the fan connector on the motherboard.

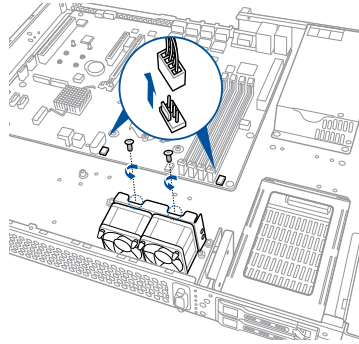

2. Lift the fan and set it aside.

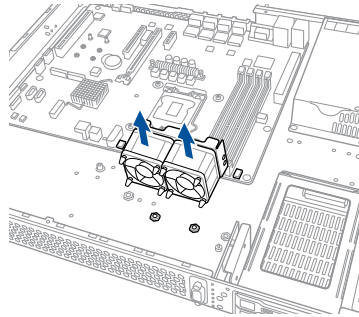

## System Fan 4 (only for RS200-E9-PS2)

1. Remove the screws located on the bottom of the system.

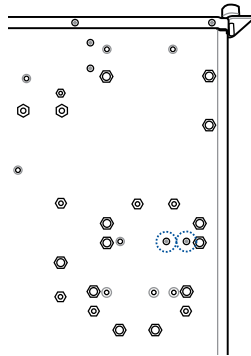

2. Disconnect the system fan cable from the fan connector on the motherboard, then lift the fan and mylar and set them aside.

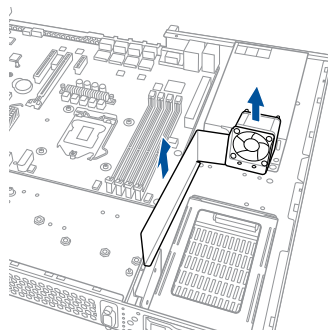

To reinstall the system fans:

1. Align the system fans to the screw holes.
2. Secure the system fans to the system using the screws you removed earlier.
3. Connect the system fan cable to the fan connector on the motherboard.



---

Ensure that the fans are installed in the correct direction. For RS200-E9-PS2, the airflow directional arrow on the fan side should point to the inner part of the chassis; for RS200-E9-PS2-F, the airflow directional arrow on the fan side should point to the outer part of the chassis

---

## 2.7.2 Installing ASUS PIKE II RAID card (optional)

Follow the steps below to install an optional ASUS RAID card on your motherboard.

1. Remove the default mini-SAS HD cable from the motherboard.

### RS200-E9-PS2

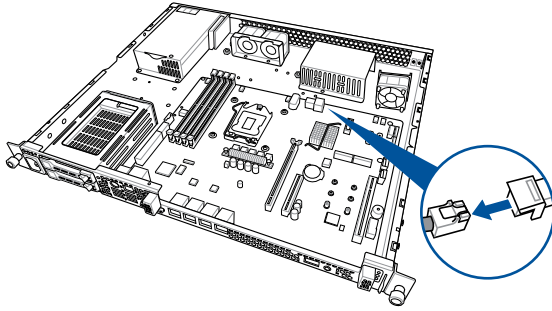

### RS200-E9-PS2-F

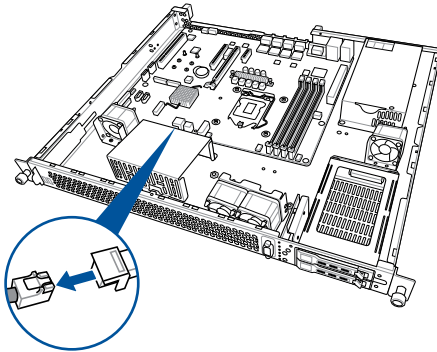

2. Connect the mini-SAS HD cable to the ASUS PIKE II card.

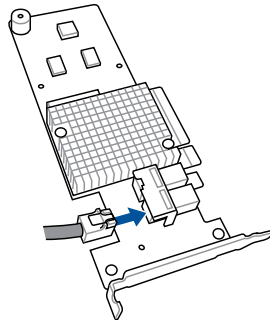

3. Firmly hold the riser card bracket, then pull it up to detach it from the PCI Express x16 slot on the motherboard.

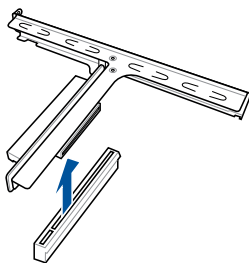

4. Place the riser card bracket on a flat and stable surface, then remove the screw from the slot bay.

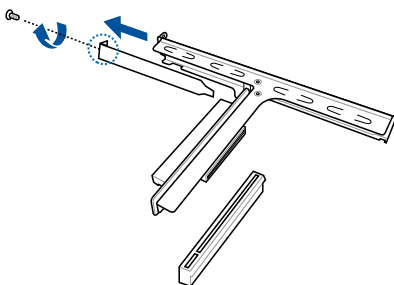

5. Install the ASUS PIKE II card x8 or x16 card to the bracket as shown.

6. Secure the card with a screw.

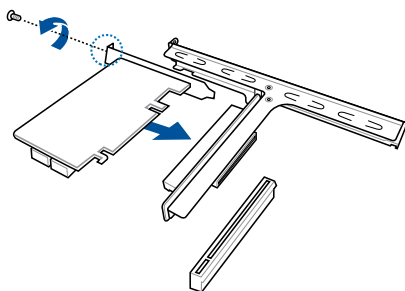

7. Install the riser card bracket and PCI Express card assembly back into the PCI Express x16 slot on the motherboard.

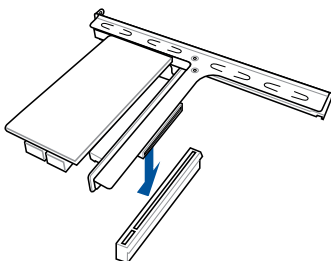

### 2.7.3 Installing the SSD cage (optional)

Follow the steps below to install the optional SSD cage on your server module.

1. Remove the three screws on the side of the SSD cage.

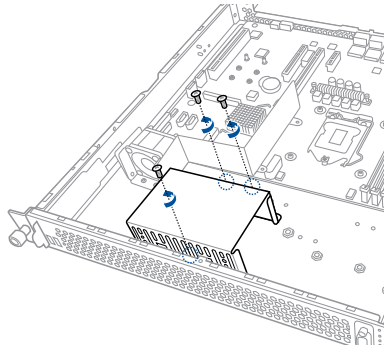

2. Lift the SSD cage and set aside.

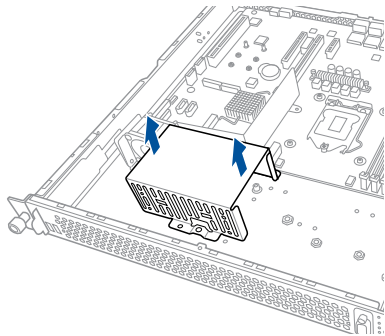

3. With the SSD cage resting on a flat surface, insert the SSD card into the SSD cage.



- The SSD Card fits in one orientation only.
- You can place two SSD cards into the SSD cage.

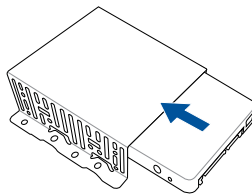

- 4. Secure the SSD card into the SSD cage with the bundled screws.

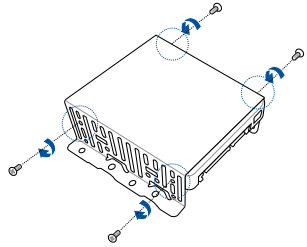

- 5. Connect the SATA power cable and the SATA connector to the SSD card.

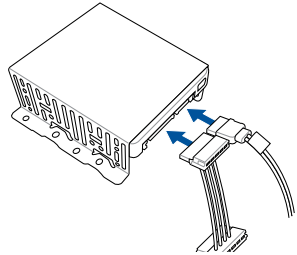

- 6. Secure the SDD cage to the server module using the bundled screws.

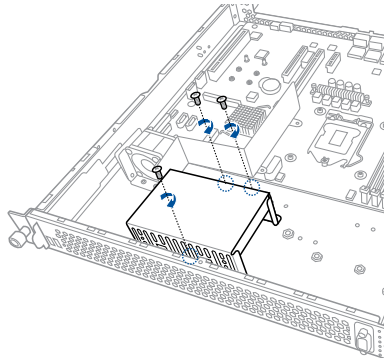

# **Installation Options**

# 3

This chapter describes how to install the optional components and devices into the barebone server.

### 3.1 Tool-less Friction Rail Kit

The tool less design of the rail kit allows you to easily install the rack rails into the server rack without the need for additional tools. The kit also comes with a metal stopping bracket that can be installed to provide additional support and stability to the server.

The tool-less rail kit package includes:

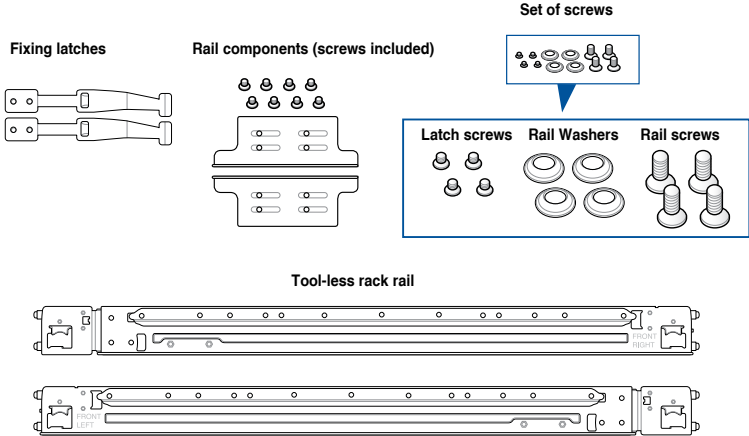

#### Installing the tool-less rack rail

To install the tool-less rack rails into the rack:

1. Secure the two fixing latches to the two sides of the server using the set of latch screws.



The locations of the screw holes vary with different server models. Refer to your server user manual for details.

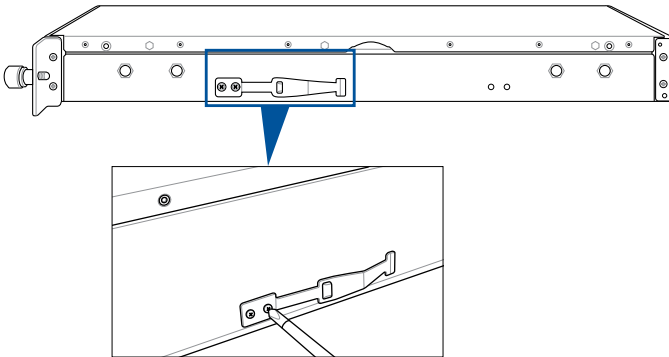

2. Select a desired space and place the appropriate rack rail (left and right) on opposite positions on the rack.



A 1U space consists of three square mounting holes with two thin lips on the top and the bottom.

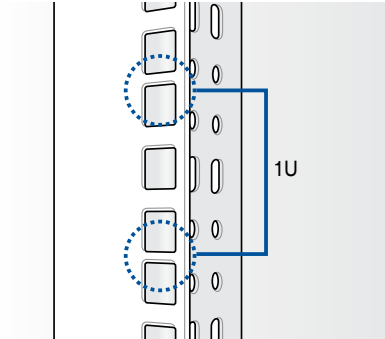

3. Secure the rail components to the rail using the bundled screws.
4. Press the spring lock (A) then insert the studs into the selected square mounting holes on the rack post.
5. Press the spring lock on the other end of rail then insert the stud into the mounting hole on the rack post. Extend the rack rail, if necessary.
6. (Optional) Use the rail screw and rail washer (B) that comes with the kit to secure the rack rail to the rack post.
7. Perform steps 3 to 5 for the other rack rail.



Ensure that the installed rack rails (left and right) are aligned, secured, and stable in place.

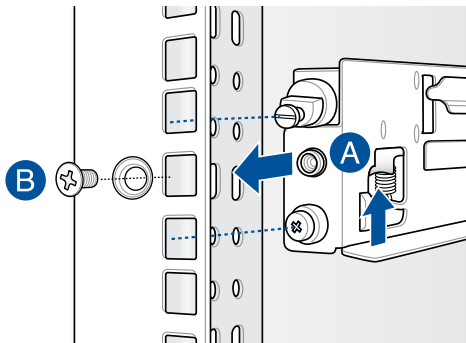

- Lift the server chassis and insert into the rack rail.



Ensure that the rack rail cabinet and the rack posts are stable and standing firmly on a level surface.

### RS200-E9-PS2 Front View

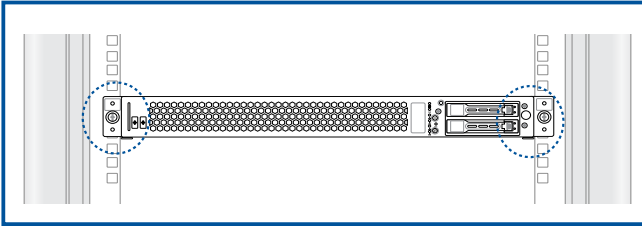

### RS200-E9-PS2-F Front View

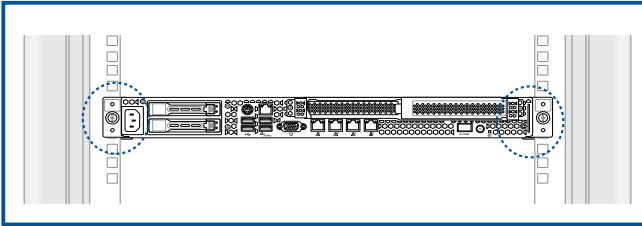

# Motherboard Information

# 4

This chapter includes the motherboard layout and brief descriptions of the jumpers and internal connectors.

# 4.1 Motherboard layout

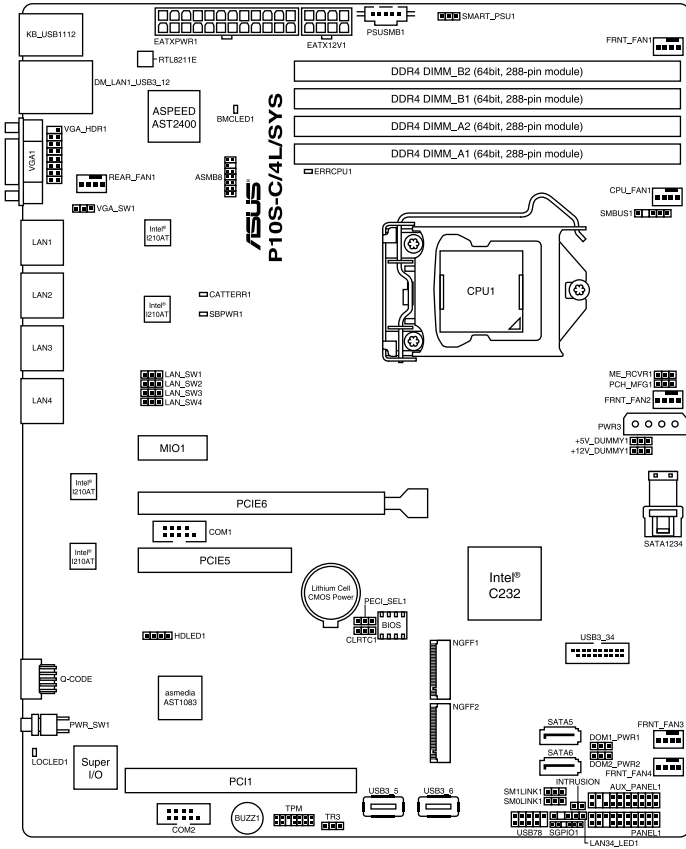

## Layout contents

Onboard LEDs		Page
1.	Standby Power LED (SB_PWR1)	4-5
2.	Baseboard Management Controller LED (BMC_LED1)	4-5
3.	CPU Warning LED (ERR_CPU1)	4-6
4.	Message LED (LOCLED1)	4-6
5.	CATT ERR LED (CATTERR1)	4-7

Jumpers		Page
1.	Clear RTC RAM (3-pin CLRTC1)	4-8
2.	VGA controller setting (3-pin VGA_SW1)	4-9
3.	LAN controller setting (3-pin LAN_SW1-4)	7-6
4.	ME firmware force recovery setting (3-pin ME_RCVR1)	4-10
5.	PCH_MFG1 setting (3-pin PCH_MFG1)	4-10
6.	SATA DOM power setting (3-pin DOM1_PWR1, DOM2_PWR2)	4-11
7.	Smart Ride Through setting (3-pin SMART_PSU1)	4-11

Rear panel connectors		Page
1.	PS/2 keyboard/mouse port	4-12
2.	RJ-45 port for iKVM	4-12
3.	Video Graphics Adapter port	4-12
4.	RJ-45 ports for LAN	4-12
5.	Power-on Button	4-12
6.	Message LED	4-12
7.	USB 2.0 ports 1 and 2	4-12
8.	USB 3.0 ports 1 and 2	4-12

Internal connectors		Page
1.	Serial ATA 6 Gbps connectors (7-pin SATA 6 Gbps_5-6 connector [Gray])	4-15
2.	Mini-SAS HD connector (SATA1234)	4-15
3.	Hard disk activity LED connector (4-pin HDLED1)	4-16
4.	USB 2.0 connector (10-1 pin USB78)	4-16
5.	USB 3.0 connector (20-1 pin USB3_34)	4-17
6.	CPU, front and rear fan connectors (4-pin FRNT_FAN1-4, REAR_FAN1, CPU_FAN1)	4-17
7.	Serial General Purpose Input/Output connector (6-1 pin SGPIO1)	4-18
8.	Serial port connectors (10-1 pin COM1/COM2)	4-18
9.	Power Supply SMBus connector (5-pin PSUSMB1)	4-19
10.	Trusted Platform Module connector (14-1 pin TPM)	4-19
11.	SATA DOM power connector (4-pin PWR3)	4-20
12.	LAN34_LED connector (5-1 pin LAN34_LED1)	4-21
13.	VGA connector (16-1 pin VGA_HDR1)	4-21
14.	ATX power connectors (24-pin EATXPWR1, 8-pin EATX12V1)	4-22
15.	System panel connector (20-1 pin PANEL1)	4-22
16.	Auxiliary panel connector (20-2 pin AUX_PANEL1)	4-24
17.	M.2 (NGFF) card connector (NGFF1 & NGFF2)	4-25
18.	System Management Bus (SMBUS) connector (5-1 pin SMBUS1)	4-25
19.	Chassis intrusion connector (2-pin INTRUSION)	4-26

## 4.2 Onboard LEDs

### 1. Standby Power LED (SB\_PWR1)

The motherboard comes with a standby power LED. The green LED lights up to indicate that the system is ON, in sleep mode, or in soft-off mode. This is a reminder that you should shut down the system and unplug the power cable before removing or plugging in any motherboard component. The illustration below shows the location of the onboard LED.

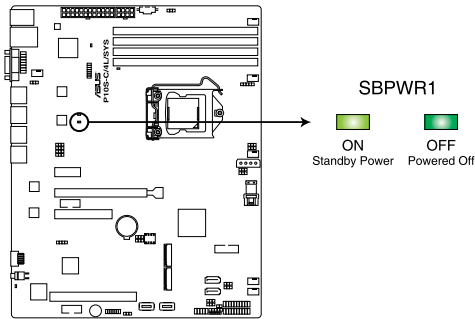

**P10S-C/4L/SYS Standby Power LED**

### 2. Baseboard Management Controller LED (BMC\_LED1)

The green heartbeat LED blinks per second to indicate that the ASMB8 is working normally. The BMC LED works with the ASUS ASMB8 management device and indicates its initiation status. When the PSU is plugged and the system is OFF, ASUS ASMB8 management device starts system initiation for about one (1) minute. The BMC LED blinks after system initiation finishes.

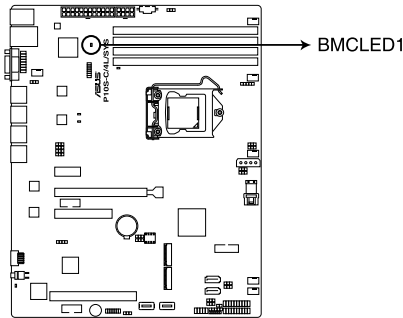

**P10S-C/4L/SYS BMC LED**



- The heartbeat LED functions only when you install the ASUS ASMB8 Management card.
- Everytime after the AC power is replugged, you have to wait for about 60 seconds for the system to power up.

### 3. CPU Warning LED (ERR\_CPU1)

The CPU warning LED lights up to indicate that a CPU error or failure has occurred.

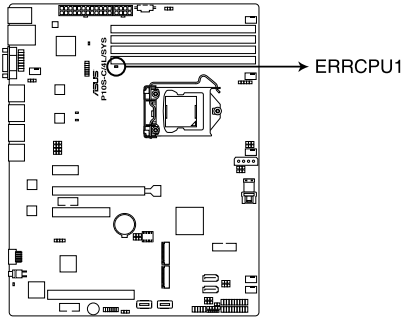

**P10S-C/4L/SYS ERRCPU1 LED**



---

The warning LED functions only when you install the ASUS ASMB8 Management card.

---

### 4. Location LED (LOCLED1)

This onboard LED lights up when the Location button on the server is pressed or when triggered by a system management software. The Location LED helps visually locate and quickly identify the server in error on a server rack.

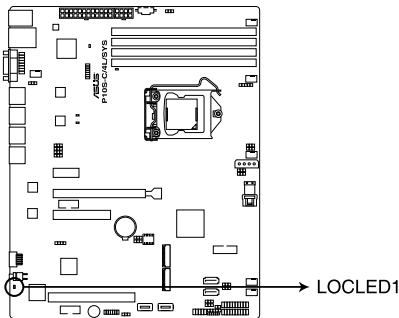

**P10S-C/4L/SYS Location LED**

**5. CATT ERR LED (CATTERR1)**

The CATT ERR LED indicates that the system has experienced a fatal or catastrophic error and cannot continue to operate.

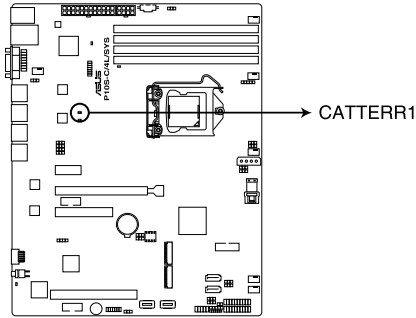

**P10S-C/4L/SYS CATTERR1 LED**

## 4.3 Jumpers

### 1. Clear RTC RAM (3-pin CLRTC1)

This jumper allows you to clear the CMOS memory system setup parameters by erasing the CMOS Real Time Clock (RTC) RAM data. The onboard button cell battery powers the RAM data in CMOS, which include system setup information such as system passwords.

To erase the RTC RAM:

1. Turn OFF the computer and unplug the power cord.
2. Move the jumper cap from pins 1–2 (default) to pins 2–3. Keep the cap on pins 2–3 for about 5–10 seconds, then move the cap back to pins 1–2.
3. Plug the power cord and turn ON the computer.
4. Hold down the <Del> key during the boot process and enter BIOS setup to re-enter data.



---

Except when clearing the RTC RAM, never remove the cap on CLRTC jumper default position. Removing the cap will cause system boot failure!

---



---

If the steps above do not help, remove the onboard battery and move the jumper again to clear the CMOS RTC RAM data. After the CMOS clearance, reinstall the battery.

---

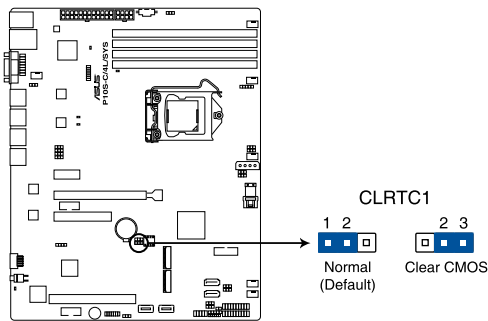

## 2. VGA controller setting (3-pin VGA\_SW1)

This jumper allows you to enable or disable the onboard VGA controller. Set to pins 1–2 to activate the VGA feature.

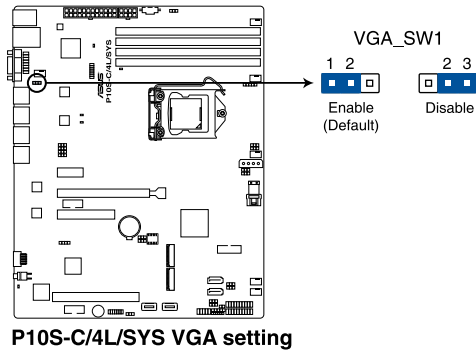

## 3. LAN controller setting (3-pin LAN\_SW1-4)

These jumpers allow you to enable or disable the onboard Intel® I210 Gigabit LAN controllers. Set to pins 1-2 to activate the Gigabit LAN feature.

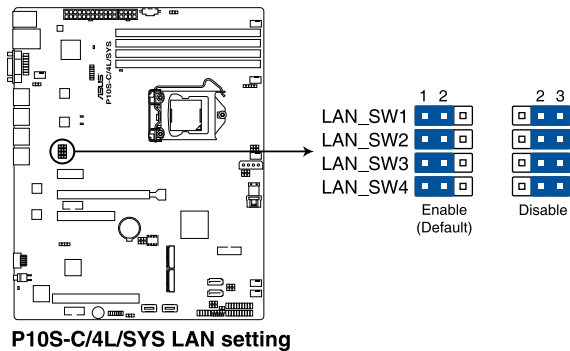

**4. ME firmware force recovery setting (3-pin ME\_RCVR1)**

This jumper allows you to force Intel Management Engine (ME) boot from recovery mode when ME become corrupted.

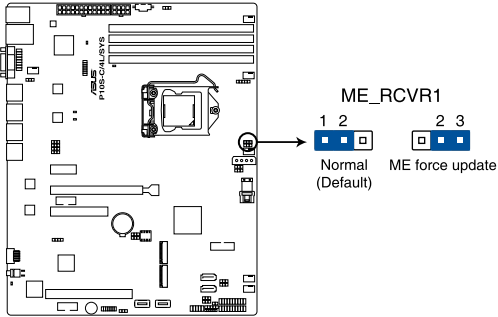

**P10S-C/4L/SYS ME recovery setting**

**5. PCH\_MFG1 setting (3-pin PCH\_MFG1)**

This jumper allows you to update the BIOS ME block select.

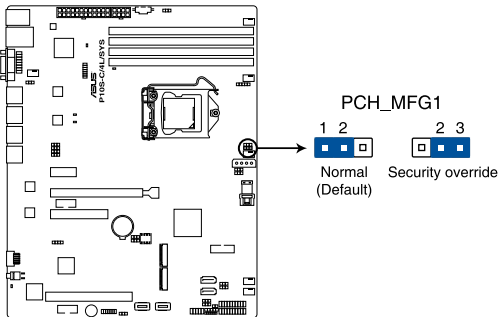

**P10S-C/4L/SYS PCH\_MFG setting**

6. **SATA DOM power setting (3-pin DOM1\_PWR1, DOM2\_PWR2)**

This jumper allows you to configure the DOM power setting.

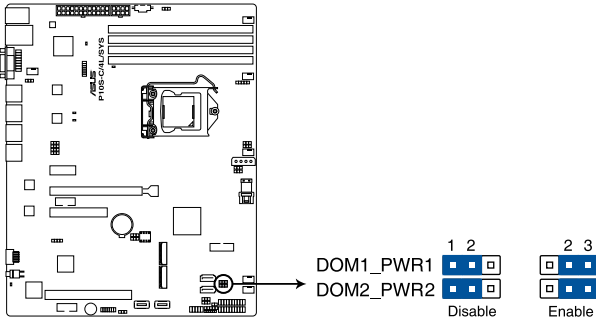

**P10S-C/4L/SYS DOM\_PWR setting**

7. **Smart Ride Through (SmaRT) setting (3-pin SMART\_PSU1)**

This jumper allows you to enable or disable the Smart Ride Through (SmaRT) function. This feature is disabled by default. Set to pins 1-2 to enable it. When enabled, SmaRT allows uninterrupted operation of the system during an AC loss event.

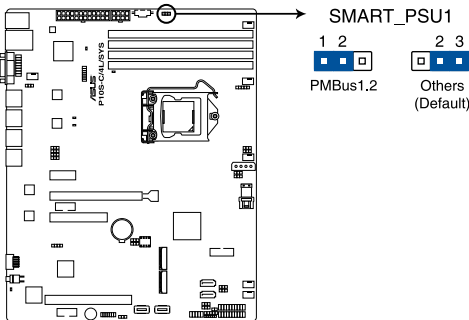

**P10S-C/4L/SYS PMBus 1.2 PSU setting**

## 4.4 Connectors

### 4.4.1 Rear panel connectors

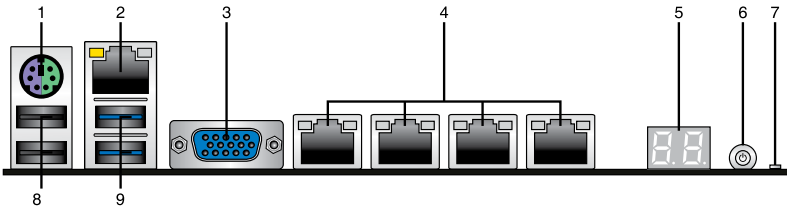

1. **PS/2 keyboard/mouse port (purple/green):** This port is for a PS/2 keyboard or mouse.
2. **RJ-45 port for iKVM:** This RJ-45 port functions only when you install ASMB8 management card.
3. **Video Graphics Adapter port:** This port is for a VGA monitor or other VGA-compatible devices.
4. **RJ-45 ports for LAN:** These ports allows Gigabit connection to a LAN (Local Area Network) through a network hub. Refer to the table below for the LAN port LED indications.
5. **Q-Code LED:** The Q-Code LED provides a 2-digit display that shows the status of your system. Refer to the **Q-Code table** of this user guide for more information about the 2-digit codes.
6. **Power-on Button:** Press this button to turn on the system.
7. **Message LED:** The Message LED is an onboard LED that lights up to indicate an abnormal event occurrence.
8. **USB 2.0 ports 1 and 2:** These two 4-pin USB (Universal Serial Bus) ports are available for connecting USB 2.0 devices.
9. **USB 3.0 ports 1 and 2:** These two 4-pin USB (Universal Serial Bus) ports are available for connecting USB 3.0 devices.

#### LAN port LED indications

Activity/Link LED		Speed LED	
Status	Description	Status	Description
OFF	No link	OFF	10 Mbps connection
GREEN	Linked	ORANGE	100 Mbps connection
BLINKING	Data activity	GREEN	1 Gbps connection

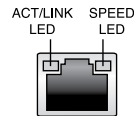

## 4.4.2 Q-Code table

Action	PHASE	POST CODE	TYPE	DESCRIPTION
Security Phase		1	Progress	First post code(POWER_ON_POST_CODE)
		2	Progress	Load BSP microcode(MICROCODE_POST_CODE)
		3	Progress	Perform early platform initialization
		4	Progress	Set cache as ram for PEI phase(CACHE_ENABLED_POST_CODE)
		5	Progress	Establish Stack
		6	Progress	CPU Early init.(CPU_EARLY_INIT_POST_CODE)
Normal boot	PEI(Pre-EFI initialization) phase	10	Progress	PEI Core Entry
		11	Progress	PEI cache as ram CPU initial
		15	Progress	NB initialize before installed memory
		19	Progress	SB initialize before installed memory
		0	MRC Progress	MRC_INITIALIZATION_START
		10	MRC Progress	MRC_CMD_PLOT_2D
		1B	MRC Progress	MRC_FAST_BOOT_PERMITTED
		1C	MRC Progress	MRC_RESTORE_NON_TRAINING
		1D	MRC Progress	MRC_PRINT_INPUT_PARAMS
		1E	MRC Progress	MRC_SET_OVERRIDES_PSPD
		20	MRC Progress	MRC_SPD_PROCESSING
		21	MRC Progress	MRC_SET_OVERRIDES
		22	MRC Progress	MRC_MC_CAPABILITY
		23	MRC Progress	MRC_MC_CONFIG
		24	MRC Progress	MRC_MC_MEMORY_MAP
		25	MRC Progress	MRC_JEDEC_INIT_LPDDR3
		26	MRC Progress	MRC_RESET_SEQUENCE
		27	MRC Progress	MRC_PRE_TRAINING
		28	MRC Progress	MRC_EARLY_COMMAND
		29	MRC Progress	MRC_SENSE_AMP_OFFSET
		2A	MRC Progress	MRC_READ_MPR
		2B	MRC Progress	MRC_RECEIVE_ENABLE
		2C	MRC Progress	MRC_JEDEC_WRITE_LEVELING
		2D	MRC Progress	MRC_LPDDR_LATENCY_SET_B
		2E	MRC Progress	MRC_WRITE_TIMING_1D
		2F	MRC Progress	MRC_READ_TIMING_1D
		30	MRC Progress	MRC_DIMM_ODT
		31	MRC Progress	MRC_EARLY_WRITE_TIMING_2D
		32	MRC Progress	MRC_WRITE_DS
		33	MRC Progress	MRC_WRITE_EQ
		34	MRC Progress	MRC_EARLY_READ_TIMING_2D
		35	MRC Progress	MRC_READ_ODT
		36	MRC Progress	MRC_READ_EQ
		37	MRC Progress	MRC_READ_AMP_POWER
		38	MRC Progress	MRC_WRITE_TIMING_2D
		39	MRC Progress	MRC_READ_TIMING_2D
		3A	MRC Progress	MRC_CMD_VREF
		3B	MRC Progress	MRC_WRITE_VREF_2D
		3C	MRC Progress	MRC_READ_VREF_2D
		3D	MRC Progress	MRC_POST_TRAINING
		3E	MRC Progress	MRC_LATE_COMMAND
		3F	MRC Progress	MRC_ROUND_TRIP_LAT
		40	MRC Progress	MRC_TURN_AROUND
		41	MRC Progress	MRC_CMP_OPT
		42	MRC Progress	MRC_SAVE_MC_VALUES
		43	MRC Progress	MRC_RESTORE_TRAINING
		44	MRC Progress	MRC_RMT_TOOL
		45	MRC Progress	MRC_WRITE_SR
		46	MRC Progress	MRC_DIMM_RON
		47	MRC Progress	MRC_RCVEN_TIMING_1D
48	MRC Progress	MRC_MR_FILL		
49	MRC Progress	MRC_PWR_MTR		
4A	MRC Progress	MRC_DDR4_MAPPING		
4B	MRC Progress	MRC_WRITE_VOLTAGE_1D		
4C	MRC Progress	MRC_EARLY_RDMPR_TIMING_2D		
4D	MRC Progress	MRC_FORCE_OLTM		
50	MRC Progress	MRC_MC_ACTIVATE		

(continued on the next page)

Action	PHASE	POST CODE	TYPE	DESCRIPTION		
Normal boot	PEI(Pre-EFI initialization) phase	51	MRC Progress	MRC_RH_PREVENTION		
		52	MRC Progress	MRC_GET_MRC_DATA		
		58	MRC Progress	MRC_RETRAIN_CHECK		
		5A	MRC Progress	MRC_SA_GV_SWITCH		
		5B	MRC Progress	MRC_ALIAS_CHECK		
		5C	MRC Progress	MRC_ECC_CLEAN_START		
		5D	MRC Progress	MRC_DONE		
		5F	MRC Progress	MRC_CPGC_MEMORY_TEST		
		60	MRC Progress	MRC_TXT_ALIAS_CHECK		
		61	MRC Progress	MRC_ENG_PERF_GAIN		
		68	MRC Progress	MRC_MEMORY_TEST		
		69	MRC Progress	MRC_FILL_RMT_STRUCTURE		
		70	MRC Progress	MRC_SELF_REFRESH_EXIT		
		71	MRC Progress	MRC_NORMAL_MODE		
		7D	MRC Progress	MRC_SSA_PRE_STOP_POINT		
		7E	MRC Progress	MRC_NO_MEMORY_DETECTED		
		7F	MRC Progress	MRC_SSA_STOP_POINT		
		55	MRC Progress	MRC_MEM_INIT_DONE		
				32	Progress	CPU Init.
				34	Progress	CPU Init.
			36	Progress	CPU Init.	
			4F	Progress	DXE Initial Program Load(PL)	
		DXE(Driver Execution Environment) phase	60	Progress	DXE Core Started	
			61	Progress	DXE NVRAM Init.	
			62	Progress	SB run-time init.	
			63	Progress	DXE CPU Init	
			68	Progress	NB Init.	
			69	Progress	NB Init.	
			6A	Progress	NB Init.	
			70	Progress	SB Init.	
			71	Progress	SB Init.	
			72	Progress	SB Init.	
			78	Progress	ACPI Init.	
			79	Progress	CSM Init.	
		BDS(Boot Device Selection) phase	90	Progress	BDS started	
			91	Progress	Connect device event	
			92	Progress	PCI Bus Enumeration.	
			93	Progress	PCI Bus Enumeration.	
			94	Progress	PCI Bus Enumeration.	
			95	Progress	PCI Bus Enumeration.	
			96	Progress	PCI Bus Enumeration.	
			97	Progress	Console output connect event	
			98	Progress	Console input connect event	
			99	Progress	AMI Super IO start	
			9A	Progress	AMI USB Driver Init.	
			9B	Progress	AMI USB Driver Init.	
			9C	Progress	AMI USB Driver Init.	
			9D	Progress	AMI USB Driver Init.	
			b2	Progress	Legacy Option ROM Init.	
			b3	Progress	Reset system	
			b4	Progress	USB hotplug	
			b6	Progress	NVRAM clean up	
			b7	Progress	NVRAM configuration reset	
			A0	Progress	IDE, AHCI Init.	
			A1	Progress	IDE, AHCI Init.	
	A2		Progress	IDE, AHCI Init.		
	A3		Progress	IDE, AHCI Init.		
	FF-00		Progress	Wait BMC ready(duration: 120 seconds).		
	A8		Progress	BIOS Setup Utility password verify		
	A9		Progress	BIOS Setup Utility start		
	AB		Progress	BIOS Setup Utility input wait		
	AD		Progress	Ready to boot event		
	AE		Progress	Legacy boot event		
	Operating system phase		AA	Progress	APIC mode	
		AC	Progress	PIC mode		

## 4.4.3 Internal connectors

### 1. Serial ATA 6.0 Gbps connectors (7-pin SATA 6 Gbps\_5-6 connector [Gray])

Supported by the Intel® C232 chipset, these connectors are for the Serial ATA signal cables for Serial ATA hard disk drives that allows up to 6Gb/s of data transfer rate. If you installed Serial ATA hard disk drives, you can create a RAID 0, RAID 1, RAID 10, or RAID 5 configuration.

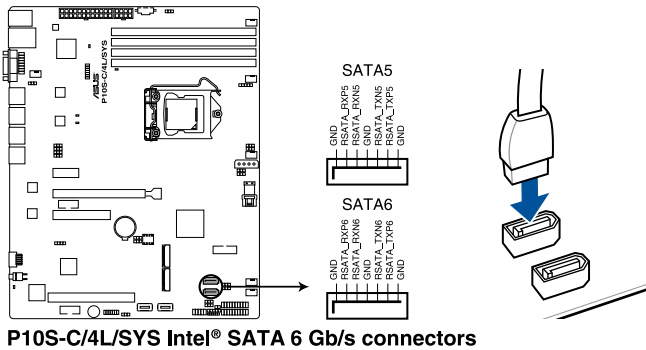

**P10S-C/4L/SYS Intel® SATA 6 Gb/s connectors**



- The actual data transfer rate depends on the speed of Serial ATA hard disks installed.
- When the M.2 connector is operating in SATA mode, SATA connector 5 and 6 (SATA 6 Gbps\_5-6) will be disabled.

### 2. Mini-SAS HD connector (SATA1234)

This motherboard comes with a mini Serial Attached SCSI (SAS) HD connector, the storage technology that supports Serial ATA. The connector supports up to four devices.

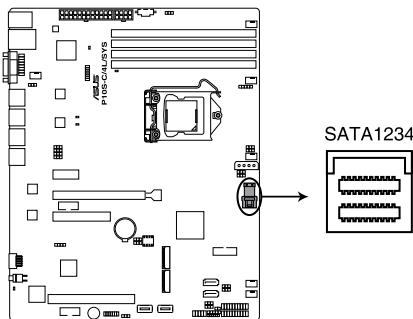

**P10S-C/4L/SYS SATA1234 connector**

**3. Hard disk activity LED connector (4-pin HDLED1)**

This LED connector is for the storage add-on card cable connected to the SATA or SAS add-on card. The read or write activities of any device connected to the SATA or SAS add-on card causes the front panel LED to light up.

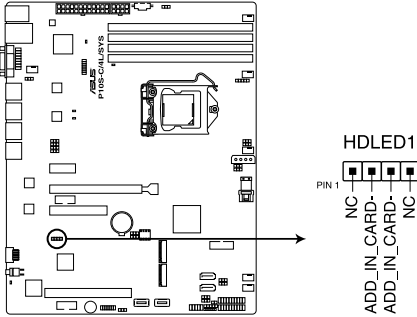

**P10S-C/4L/SYS Hard disk activity LED connector**

**4. USB 2.0 connector (10-pin USB78)**

These connectors are for USB 2.0 ports. Connect the USB module cables to these connectors. These USB connectors comply with USB 2.0 specification that supports up to 480 Mbps connection speed.

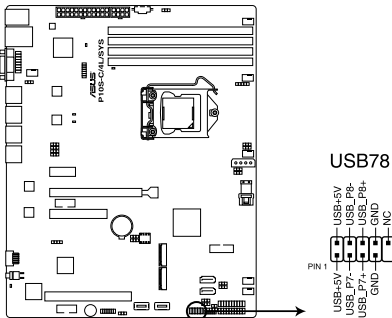

**P10S-C/4L/SYS USB2.0 connector**

## 5. USB 3.0 connector (20-pin USB3\_34)

These connectors allow you to connect a USB 3.0 module for additional USB 3.0 front or rear panel ports. With an installed USB 3.0 module, you can enjoy all the benefits of USB 3.0 including faster data transfer speeds of up to 5 Gbps, faster charging time for USB-chargeable devices, optimized power efficiency, and backward compatibility with USB 2.0.

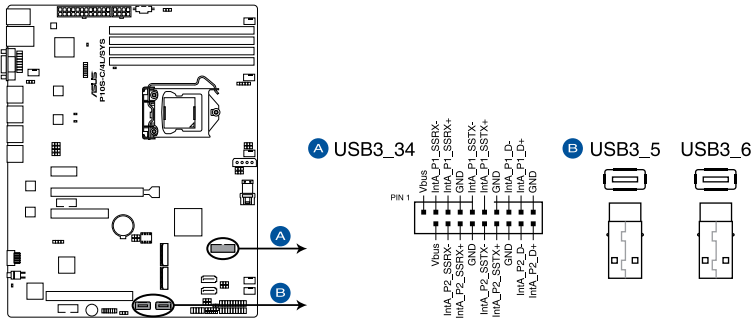

**P10S-C/4L/SYS USB3.0 connectors**

## 6. CPU, front, and rear fan connectors (4-pin FRNT\_FAN1-4, REAR\_FAN1, CPU\_FAN1)

The fan connectors support cooling fans. Connect the fan cables to the fan connectors on the motherboard, ensuring that the black wire of each cable matches the ground pin of the connector.



- DO NOT forget to connect the fan cables to the fan connectors. Insufficient air flow inside the system may damage the motherboard components.
- These are not jumpers! DO NOT place jumper caps on the fan connectors!
- All fans feature the ASUS Smart Fan technology.

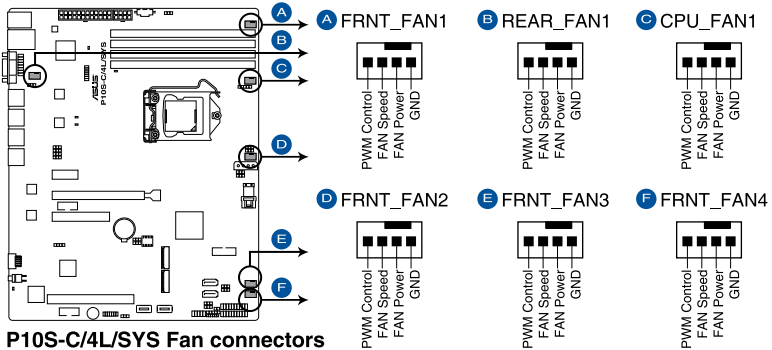

**P10S-C/4L/SYS Fan connectors**

**7. Serial General Purpose Input/Output connector (6-1 pin SGPIO1)**

The SGPIO 1 connector is used for the Intel Rapid Storage Technology Enterprise SGPIO interface that controls the LED pattern generation, device information, and general purpose data.

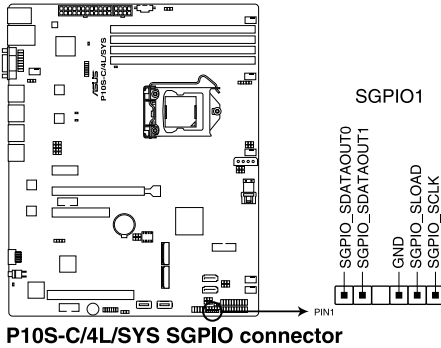

**8. Serial port connectors (10-1 pin COM1/COM2)**

These connectors are for the serial COM ports. Connect the serial port module cable to one of these connectors, then install the module to a slot opening at the back of the system chassis.

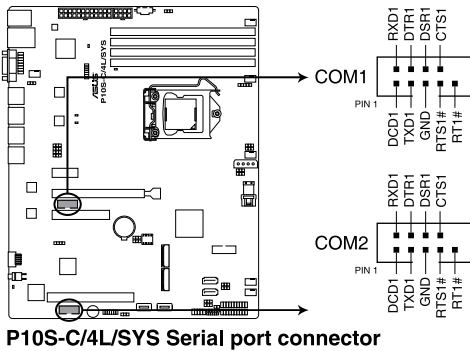

### 9. Power Supply SMBus connector (5-pin PSUSMB1)

This connector allows you to connect SMBus (System Management Bus) to the power supply unit to read PSU information. Devices communicate with an SMBus host and/or other SMBus devices using the SMBus interface.

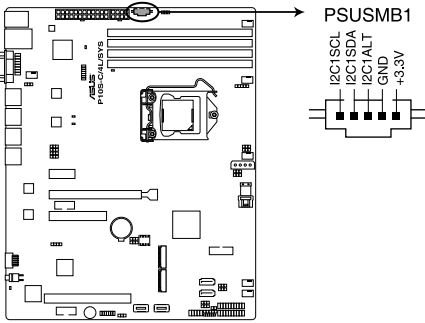

**P10S-C/4L/SYS Power supply SMBus connector**



This connector functions only when you install the ASUS ASMB8.

### 10. Trusted Platform Module connector (14-1 pin TPM)

This connector supports a TPM (Trusted Platform Module) system, which can securely store keys, digital certificates, passwords, and data. A TPM system also helps enhance network security, protects digital identities, and ensures platform integrity.

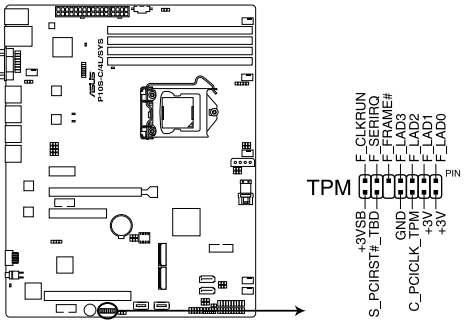

**P10S-C/4L/SYS TPM connector**

### 11. SATA DOM power connector (4-pin PWR3)

This 4-pin connector is for 5V power of a certain SATA DOM (Disk on Module) device when using an appropriate cable.

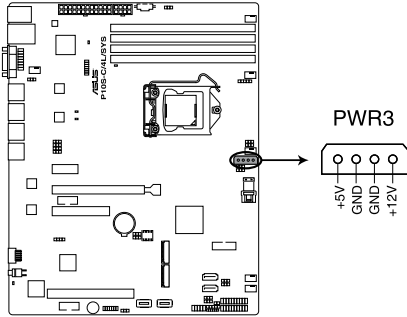

**P10S-C/4L/SYS Power connector**



- The SATA DOM power connector is for output power only. It has a maximum output current of 1A.
- Ensure that the power of the SATA DOM device that you will use is less than 1A.

## 12. LAN34\_LED connector (5-1 pin LAN34\_LED1)

These LEDs are for Gigabit LAN activity LEDs on the front panel. Connect the LAN LED cable to the backplane for LAN activity indication.

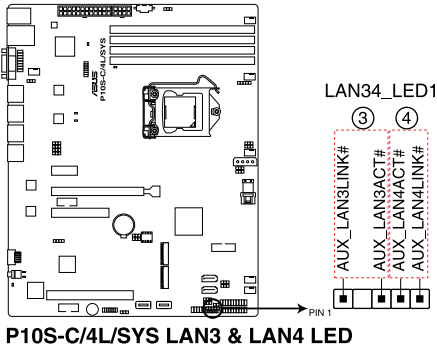

## 13. VGA connector (16-1 pin VGA\_HDR1)

This connector supports the VGA High Dynamic-Range interface.

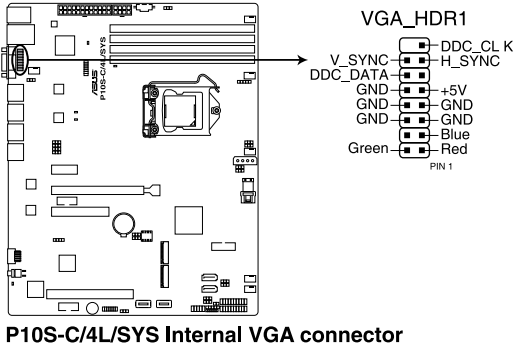

## 14. ATX power connectors (24-pin EATXPWR1, 8-pin EATX12V1)

These connectors are for the ATX power supply plugs. The power supply plugs are designed to fit these connectors in only one orientation. Find the proper orientation and push down firmly until the connectors completely fit.



- DO NOT forget to connect the 24-pin and the 8-pin power plugs; otherwise, the system will not boot up.
- Use of a power supply unit (PSU) with a higher power output is recommended when configuring a system with more power-consuming devices. The system may become unstable or may not boot up if the power is inadequate.
- This motherboard supports ATX2.0 PSU or later version.
- Ensure that your PSU can provide at least the minimum power required by your system.

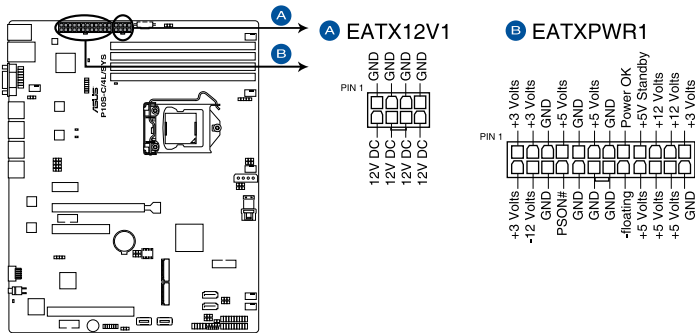

**P10S-C/4L/SYS ATX power connectors**

## 15. System panel connector (20-1 pin PANEL1)

This connector supports several chassis-mounted functions.

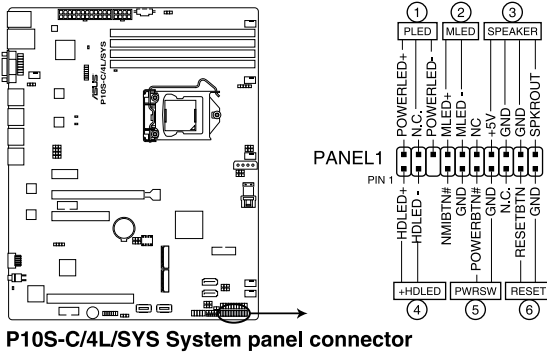

**P10S-C/4L/SYS System panel connector**

### 1. System power LED (3-pin PLED)

This 3-pin connector is for the system power LED. Connect the chassis power LED cable to this connector. The system power LED lights up when you turn on the system power, and blinks when the system is in sleep mode.

### 2. Message LED (2-pin MLED)

This 2-pin connector is for the message LED cable that connects to the front message LED. The message LED is controlled by Hardware monitor to indicate an abnormal event occurrence.

### 3. System warning speaker (4-pin SPEAKER)

This 4-pin connector is for the chassis-mounted system warning speaker. The speaker allows you to hear system beeps and warnings.

### 4. Hard disk drive activity LED (2-pin +HDLED)

This 2-pin connector is for the HDD Activity LED. Connect the HDD Activity LED cable to this connector. The IDE LED lights up or flashes when data is read from or written to the HDD.

### 5. Power button/soft-off button (2-pin PWRSW)

This connector is for the system power button. Pressing the power button turns the system on or puts the system in sleep or soft-off mode depending on the BIOS settings. Pressing the power switch for more than four seconds while the system is ON turns the system OFF.

### 6. Reset button (2-pin RESET)

This 2-pin connector is for the chassis-mounted reset button for system reboot without turning off the system power.

## 16. Auxiliary panel connector (20-2 pin AUX\_PANEL1)

This connector is for additional front panel features including front panel SMB, locator LED and switch, chassis intrusion, and LAN LEDs.

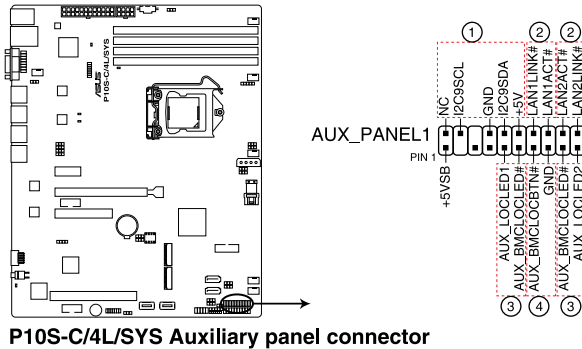

### 1. Front panel SMB (6-1 pin FPSMB)

These connectors are for the front panel SMBus cable.

### 2. LAN activity LED (2-pin LAN1LINK and 2-pin LAN2LINK)

These connectors are for Gigabit LAN activity LEDs on the front panel.

### 3. Locator LED (2-pin AUX\_LOCLEDD1 and 2-pin AUX\_LOCLEDD2)

These connectors are for the locator LED1 and LED2 on the front panel. Connect the Locator LED cables to these 2-pin connectors. The LEDs will light up when the Locator button is pressed.

### 4. Locator Button/Switch (2-pin AUX\_BMCLOCBTN)

These connectors are for the locator button on the front panel. This button queries the state of the system locator.

## 17. M.2 (NGFF) card connector (NGFF1 & NGFF2)

This connector allows you to install an M.2 device.

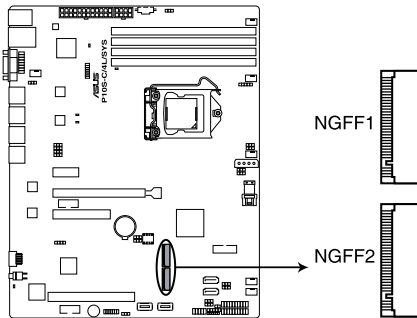

**P10S-C/4L/SYS NGFF1 & NGFF2 connectors**



- This connector supports type 2242/2260/2280 devices on both PCI-E and SATA interface.
- When the M.2 connector is operating in SATA mode, SATA connector 5 and 6 (SATA 6 Gbps\_5-6) will be disabled.



The M.2 (NGFF) device is purchased separately.

## 18. System Management Bus (SMBUS) connector (5-1 pin SMBUS1)

This connector controls the system and power management-related tasks. This connector processes the messages to and from devices rather than tripping the individual control lines.

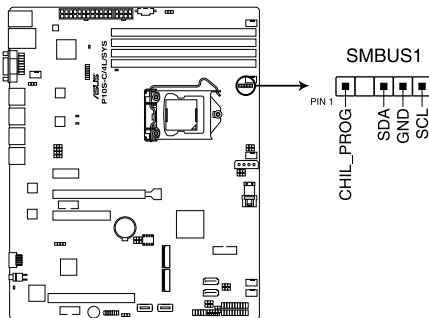

**P10S-C/4L/SYS SMBUS connector**

## 19. Chassis intrusion connector (2-pin INTRUSION)

This connector is for a chassis-mounted intrusion detection sensor or switch. Connect one end of the chassis intrusion sensor or switch cable to this connector. The chassis intrusion sensor or switch sends a high-level signal to this connector when a chassis component is removed or replaced. The signal is then generated as a chassis intrusion event.

By default, the pin labeled “Chassis Signal” and “Ground” are shorted with a jumper cap. Remove the jumper caps only when you intend to use the chassis intrusion detection feature.

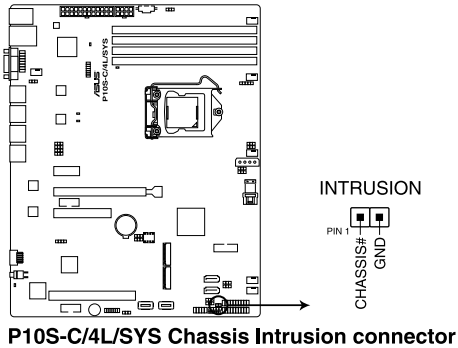

# **BIOS Setup**

# 5

This chapter tells how to change the system settings through the BIOS Setup menus. Detailed descriptions of the BIOS parameters are also provided.

## 5.1 Managing and updating your BIOS

The following utilities allow you to manage and update the motherboard Basic Input/Output System (BIOS) setup:

### 1. ASUS CrashFree BIOS 3

To recover the BIOS using a bootable USB flash disk drive when the BIOS file fails or gets corrupted.

### 2. ASUS EzFlash

Updates the BIOS using a USB flash disk.

### 3. BUPDATER

Updates the BIOS in DOS mode using a bootable USB flash disk drive.

Refer to the corresponding sections for details on these utilities.



---

Save a copy of the original motherboard BIOS file to a bootable USB flash disk drive in case you need to restore the BIOS in the future. Copy the original motherboard BIOS using the BUPDATER utility.

---

### 5.1.1 ASUS CrashFree BIOS 3 utility

The ASUS CrashFree BIOS 3 is an auto recovery tool that allows you to restore the BIOS file when it fails or gets corrupted during the updating process. You can update a corrupted BIOS file using a USB flash drive that contains the updated BIOS file.



---

Prepare a USB flash drive containing the updated motherboard BIOS before using this utility.

---

### Recovering the BIOS from a USB flash drive

To recover the BIOS from a USB flash drive:

1. Insert the USB flash drive with the original or updated BIOS file to one USB port on the system.
2. The utility will automatically recover the BIOS. It resets the system when the BIOS recovery finished.



---

**DO NOT** shut down or reset the system while recovering the BIOS! Doing so would cause system boot failure!

---



---

The recovered BIOS may not be the latest BIOS version for this motherboard. Visit the ASUS website at [www.asus.com](http://www.asus.com) to download the latest BIOS file.

---

## 5.1.2 ASUS EzFlash Utility

The ASUS EzFlash Utility feature allows you to update the BIOS using a USB flash disk without having to use a DOS-based utility.



Download the latest BIOS from the ASUS website at [www.asus.com](http://www.asus.com) before using this utility.



The succeeding BIOS screens are for reference only. The actual BIOS screen displays may not be the same as shown.

To update the BIOS using EzFlash Utility:

1. Insert the USB flash disk that contains the latest BIOS file to the USB port.
2. Enter the BIOS setup program. Go to the **Tool** menu to select ASUS EzFlash Utility and press <Enter> to enable it.

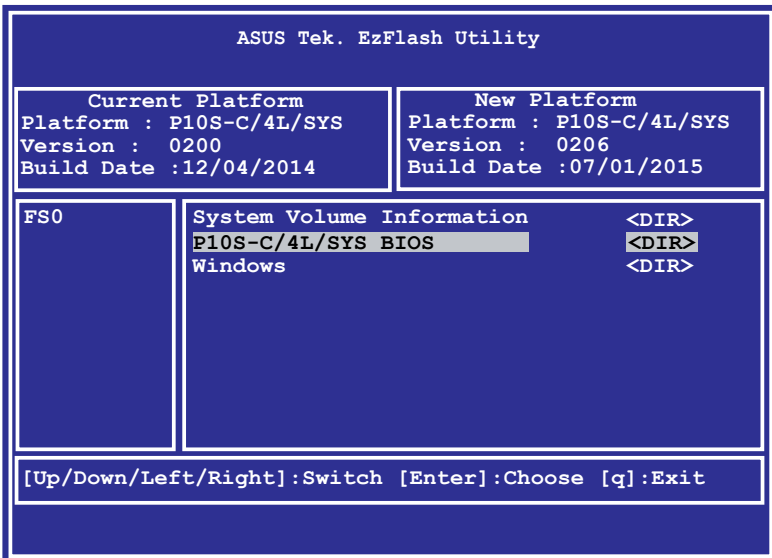

3. Press <Tab> to switch to the **Drive** field.
4. Press the Up/Down arrow keys to find the USB flash disk that contains the latest BIOS then press <Enter>.
5. Press <Tab> to switch to the **Folder Info** field.
6. Press the Up/Down arrow keys to find the BIOS file then press <Enter>.
7. Reboot the system when the update process is done.



- 
- This function can support devices such as a USB flash disk with FAT 32/16 format and single partition only.
  - DO NOT shut down or reset the system while updating the BIOS to prevent system boot failure!
- 



---

Ensure to load the BIOS default settings to ensure system compatibility and stability. Press <F5> and select **Yes** to load the BIOS default settings.

---

### 5.1.3 BUPDATER utility



---

The succeeding BIOS screens are for reference only. The actual BIOS screen displays may not be the same as shown.

---

The BUPDATER utility allows you to update the BIOS file in DOS environment using a bootable USB flash disk drive with the updated BIOS file.

#### Updating the BIOS file

To update the BIOS file using the BUPDATER utility:

1. Visit the ASUS website at [www.asus.com](http://www.asus.com) and download the latest BIOS file for the motherboard. Save the BIOS file to a bootable USB flash disk drive.
2. Download the BUPDATER utility (BUPDATER.exe) from the ASUS support website at [support.asus.com](http://support.asus.com) to the bootable USB flash disk drive you created earlier.
3. Boot the system in DOS mode, then at the prompt, type:

```
BUPDATER /i [filename] .CAP
```

where [filename] is the latest or the original BIOS file on the bootable USB flash disk drive, then press <Enter>.

```
A:\>BUPDATER /i[file name]CAP
```

The utility verifies the file, then starts updating the BIOS file.

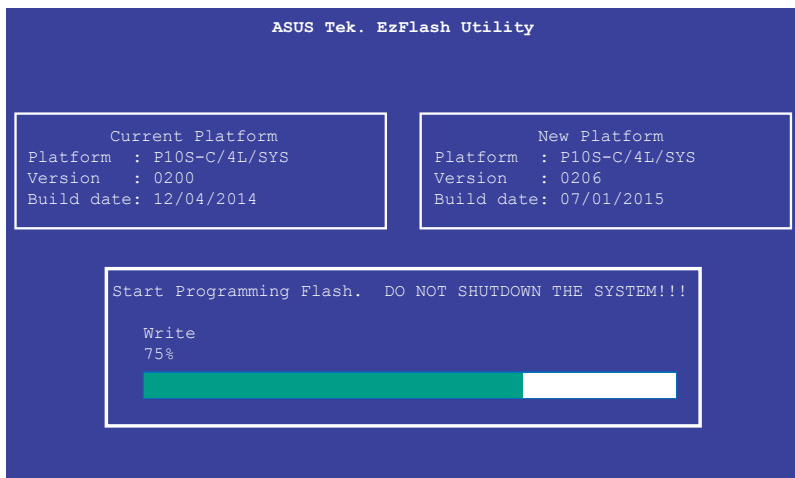

DO NOT shut down or reset the system while updating the BIOS to prevent system boot failure!

The utility returns to the DOS prompt after the BIOS update process is completed.

4. Reboot the system from the hard disk drive.



## 5.2 BIOS setup program

This motherboard supports a programmable firmware chip that you can update using the provided utility described in section 4.1 **Managing and updating your BIOS**.

Use the BIOS Setup program when you are installing a motherboard, reconfiguring your system, or prompted to "Run Setup." This section explains how to configure your system using this utility.

Even if you are not prompted to use the Setup program, you can change the configuration of your computer in the future. For example, you can enable the security password feature or change the power management settings. This requires you to reconfigure your system using the BIOS Setup program so that the computer can recognize these changes and record them in the CMOS RAM of the firmware chip.

The firmware chip on the motherboard stores the Setup utility. When you start up the computer, the system provides you with the opportunity to run this program. Press <Del> during the Power-On Self-Test (POST) to enter the Setup utility; otherwise, POST continues with its test routines.

If you wish to enter Setup after POST, restart the system by pressing <Ctrl>+<Alt>+<Del>, or by pressing the reset button on the system chassis. You can also restart by turning the system off then back on. Do this last option only if the first two failed.

The Setup program is designed to make it as easy to use as possible. Being a menu-driven program, it lets you scroll through the various sub-menus and make your selections from the available options using the navigation keys.



- 
- The default BIOS settings for this motherboard apply for most conditions to ensure optimum performance. If the system becomes unstable after changing any BIOS settings, load the default settings to ensure system compatibility and stability. Press <F5> and select **Yes** to load the BIOS default settings.
  - The BIOS setup screens shown in this section are for reference purposes only, and may not exactly match what you see on your screen.
  - Visit the ASUS website ([www.asus.com](http://www.asus.com)) to download the latest BIOS file for this motherboard.
-

## 5.2.1 BIOS menu screen

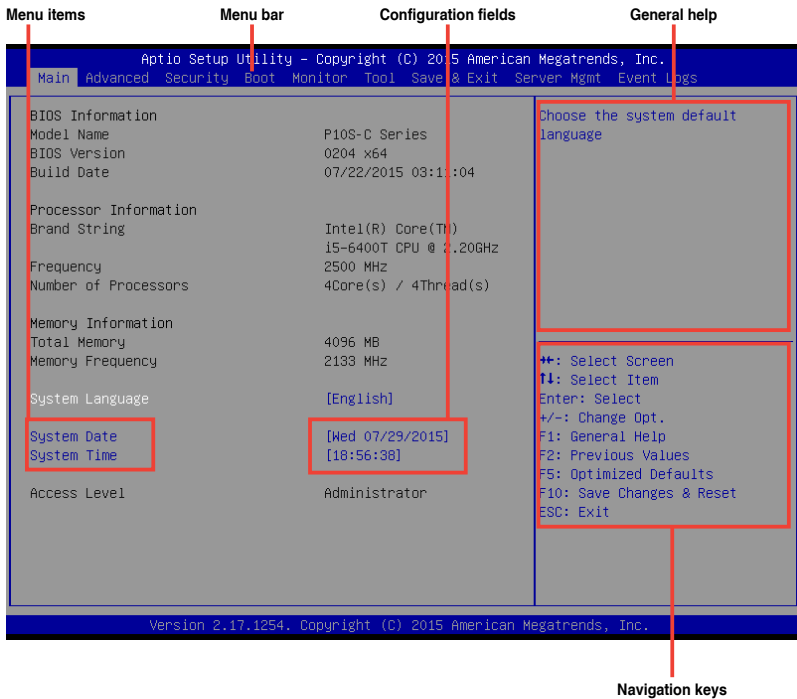

## 5.2.2 Menu bar

The menu bar on top of the screen has the following main items:

- Main** For changing the basic system configuration
- Advanced** For changing the advanced system settings
- Security** For changing the security settings
- Boot** For changing the system boot configuration
- Monitor** For displaying the system temperature, power status, and changing the fan settings
- Tool** For configuring options for special functions
- Save & Exit** For selecting the save & exit options
- Server Mgmt** For changing the server mgmt settings
- Event Logs** For changing the event log settings

To select an item on the menu bar, press the right or left arrow key on the keyboard until the desired item is highlighted.

### 5.2.3 Menu items

The highlighted item on the menu bar displays the specific items for that menu. For example, selecting **Main** shows the Main menu items. The other items (Advanced, Security, Boot, Monitor, Tool, Save & Exit, Server Mgmt, and Event Logs) on the menu bar have their respective menu items.

### 5.2.4 Submenu items

A solid triangle before each item on any menu screen means that the item has a submenu. To display the submenu, select the item and press <Enter>.

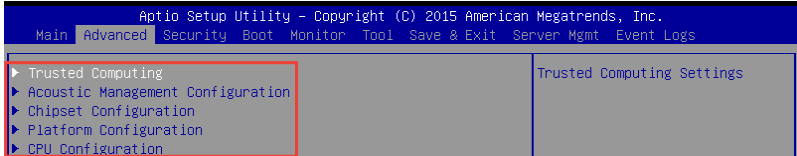

### 5.2.5 Navigation keys

At the bottom right corner of a menu screen are the navigation keys for the BIOS setup program. Use the navigation keys to select items in the menu and change the settings.

### 5.2.6 General help

At the top right corner of the menu screen is a brief description of the selected item.

### 5.2.7 Configuration fields

These fields show the values for the menu items. If an item is user-configurable, you can change the value of the field opposite the item. You cannot select an item that is not user-configurable. A configurable field is enclosed in brackets, and is highlighted when selected. To change the value of a field, select it and press <Enter> to display a list of options.

### 5.2.8 Pop-up window

Select a menu item and press <Enter> to display a pop-up window with the configuration options for that item.

### 5.2.9 Scroll bar

A scroll bar appears on the right side of a menu screen when there are items that do not fit on the screen. Press the Up/Down arrow keys or <Page Up> / <Page Down> keys to display the other items on the screen.

## 5.3 Main menu

When you enter the BIOS Setup program, the Main menu screen appears. The Main menu provides you an overview of the basic system information, and allows you to set the system date and time.

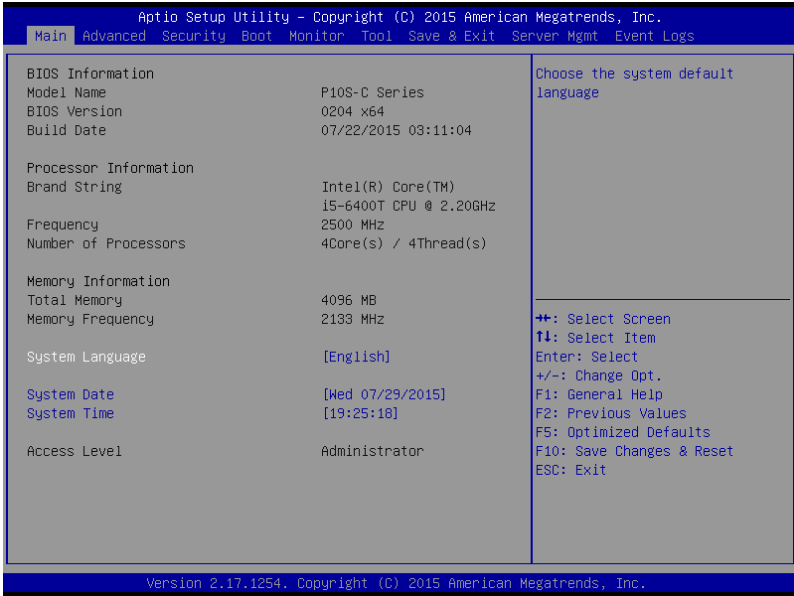

### 5.3.1 System Date

Allows you to set the system date to **[Day mm/dd/yyyy]**.

Day = Day of the week

mm = month (numeric value)

dd = day (numeric value)

yyyy = year (numeric value)

### 5.3.2 System Time

Allows you to set the system time to **[hh/mm/ss]**.

hh = hour (numeric value)

mm = minutes (numeric value)

ss = seconds (numeric value)

## 5.4 Advanced menu

The Advanced menu items allow you to change the settings for the CPU and other system devices.



Take caution when changing the settings of the Advanced menu items. Incorrect field values can cause the system to malfunction.

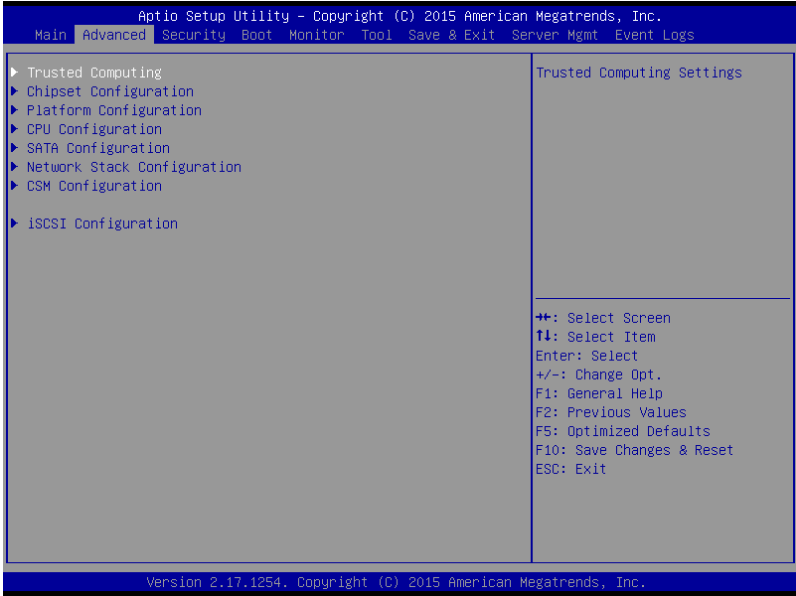

### 5.4.1 Trusted Computing

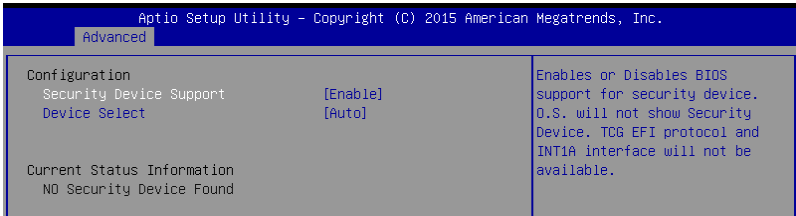

#### Security Device Support [Enable]

Allows you to enable or disable the BIOS support for security device.

Configuration options: [Disable] [Enable]

## Device Select [Auto]

Allows you to restrict support to selected device. Auto will support both devices.  
Configuration options: [TPM 1.2] [TPM 2.0] [Auto]

## 5.4.2 Chipset Configuration

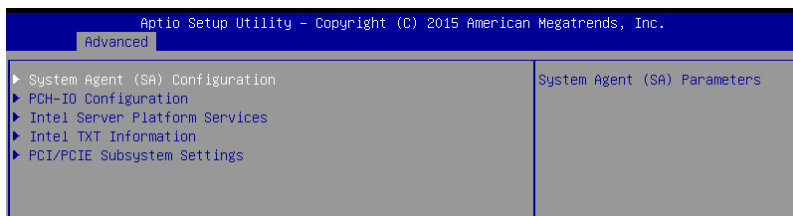

### System Agent (SA) Configuration

This allows you to change System Agent (SA) parameters.

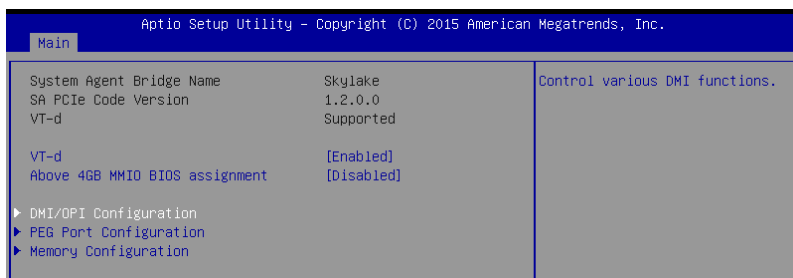

#### VT-d [Enabled]

Allows you to enable virtualization technology function on memory control hub.  
Configuration options: [Enabled] [Disabled]

#### Above 4GB MMIO BIOS assignment [Disabled]

Allows you to enable or disable above 4GB MemoryMappedIO BIOS assignment. When aperture size is set to 2048 MB, this is disabled automatically.  
Configuration options: [Enabled] [Disabled]

## DMI/OPI Configuration

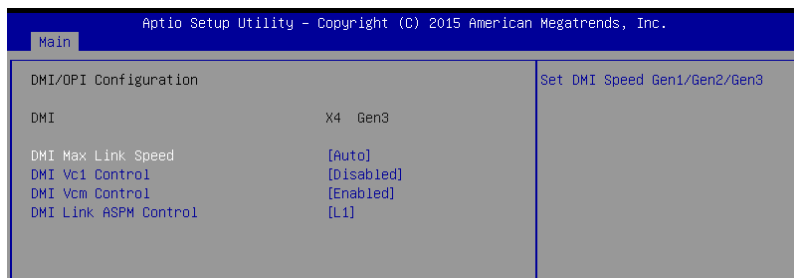

### **DMI Max Link Speed [Auto]**

Allows you to set the DMI speed.

Configuration options: [Auto] [Gen1] [Gen2] [Gen3]

### **DMI Vc1 Control [Disabled]**

Allows you to enable or disable DMI Vc1.

Configuration options: [Enabled] [Disabled]

### **DMI Vcm Control [Enabled]**

Allows you to enable or disable DMI Vcm.

Configuration options: [Enabled] [Disabled]

### **DMI Link ASPM Control [Disabled]**

This item is for the control of the Active State Power Management on SA side of the DMI link.

Configuration options: [L1] [Disabled]

## PEG Port Configuration

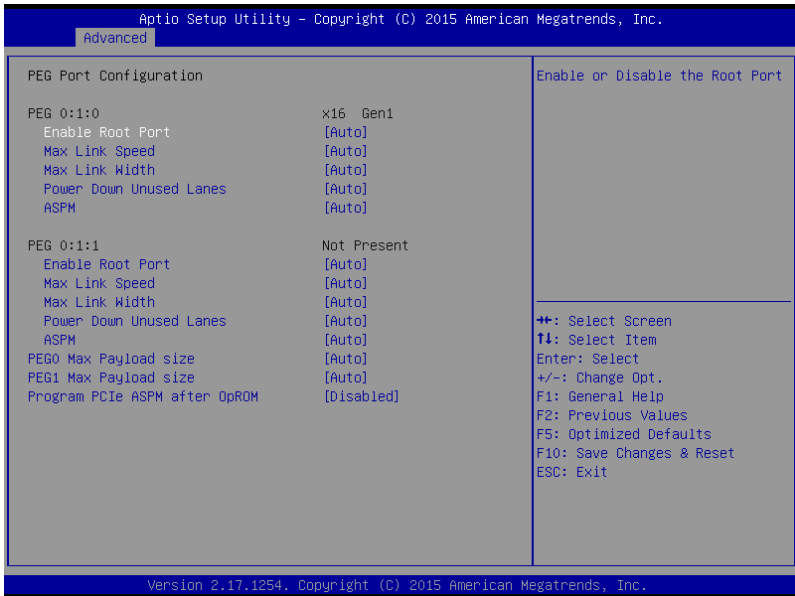

### PEG 0:1:0

#### **Enable Root Port [Auto]**

Allows you to enable or disable the root port.

Configuration options: [Disabled] [Enabled] [Auto]

#### **Max Link Speed [Auto]**

Allows you to configure PEG 0:1:0 Max Speed.

Configuration options: [Auto] [Gen1] [Gen2] [Gen3]

#### **Max Link Width [Auto]**

Allows you to force PEG link to retrain to X1/2/4/8.

Configuration options: [Auto] [Force X1] [Force X2] [Force X4] [Force X8]

#### **Power Down Unused Lanes [Auto]**

Allows you to power down unused lanes. When set to [Auto], Bios will power down unused lanes based on the max possible link width.

Configuration options: [Disabled] [Auto]

#### **ASPM [Auto]**

Allows you to control ASPM support for the PEG 0. This has no effect if PEG is not the currently active device.

Configuration options: [Disabled] [Auto] [ASPM L0s] [ASPM L1]  
[ASPM L0sL1]

## PEG 0:1:1

### **Enable Root Port [Auto]**

Allows you to enable or disable the root port.

Configuration options: [Disabled] [Enabled] [Auto]

### **Max Link Speed [Auto]**

Allows you to configure PEG 0:1:1 Max Speed.

Configuration options: [Auto] [Gen1] [Gen2] [Gen3]

### **Max Link Width [Auto]**

Allows you to force PEG link to retrain to X1/2/4/8.

Configuration options: [Auto] [Force X1] [Force X2] [Force X4]

### **Power Down Unused Lanes [Auto]**

Allows you to power down unused lanes. When set to [Auto], Bios will power down unused lanes based on the max possible link width.

Configuration options: [Disabled] [Auto]

### **ASPM [Auto]**

Allows you to control ASPM support for the PEG 1. This has no effect if PEG is not the currently active device.

Configuration options: [Disabled] [Auto] [ASPM L0s] [ASPM L1]  
[ASPM L0sL1]

## **PEG0 Max Payload size [Auto]**

Allows you to set the PEG0 max payload size.

Configuration options: [Auto] [128 TLP] [256 TLP]

## **PEG1 Max Payload size [Auto]**

Allows you to set the PEG1 max payload size.

Configuration options: [Auto] [128 TLP] [256 TLP]

## **Program PCIe ASPM after OpRom [Disabled]**

Allows you to select when to program the PCIe ASPM.

[Disabled]                    PCIe ASPM will be programmed before OpROM.

[Enabled]                    PCIe ASPM will be programmed after OpROM.

## Memory Configuration

Allows you to change memory information settings.

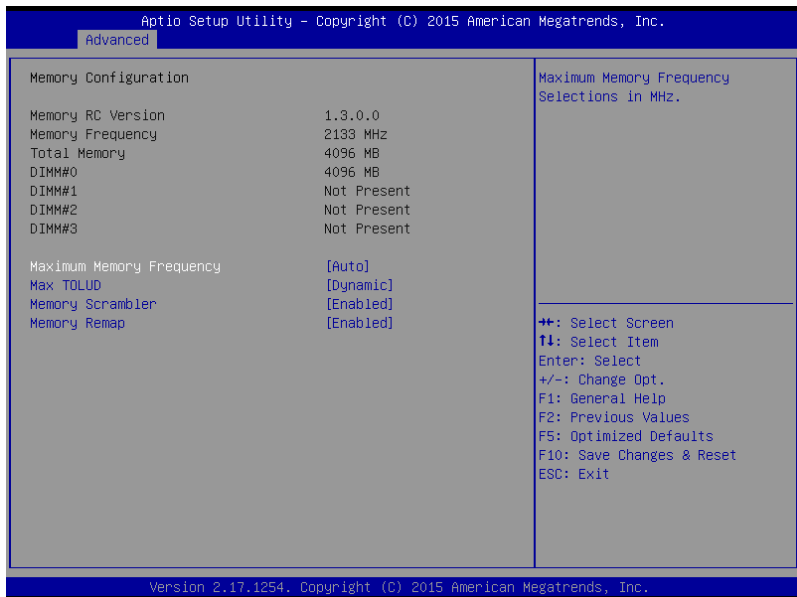

### Maximum Memory Frequency [Auto]

Allows you to set the maximum memory frequency.

Configuration options: [Auto] [1067] [1333] [1600] [1867] [2133]

### Max TOLUD [Dynamic]

Allows you to set the maximum value of TOLUD. Dynamic assignment would adjust TOLUD automatically based on largest MMIO length of installed graphic controller.

Configuration options: [Dynamic] [1 GB] [1.25 GB] [1.5 GB] [1.75 GB] [2 GB] [2.25 GB] [2.5 GB] [2.75 GB] [3 GB] [3.25 GB] [3.5 GB]

### Memory Scrambler [Enabled]

Set this item to enable or disable memory scrambler support.

Configuration options: [Disabled] [Enabled]

### Memory Remap [Enabled]

Allows you to enable or disable memory remap above 4GB.

Configuration options: [Enabled] [Disabled]

## PCH-IO Configuration

Allows you to set PCH-IO parameters.

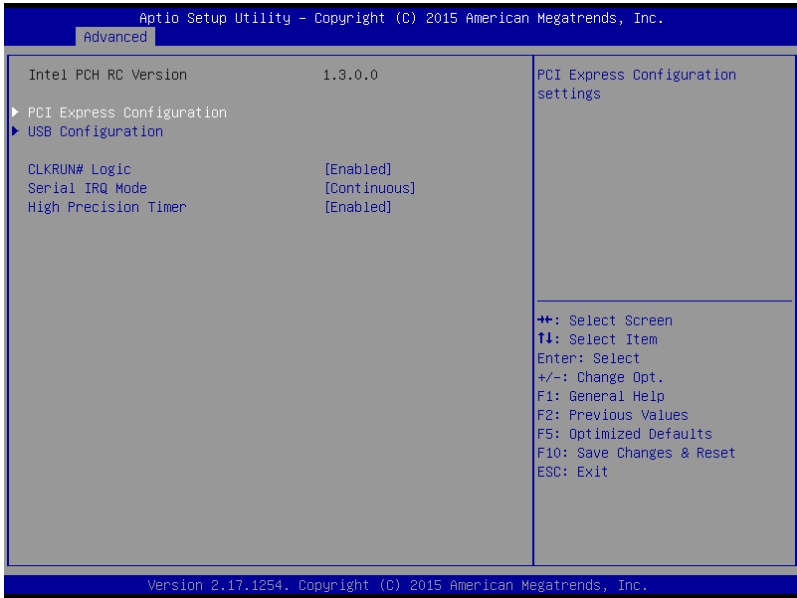

## PCI Express Configuration

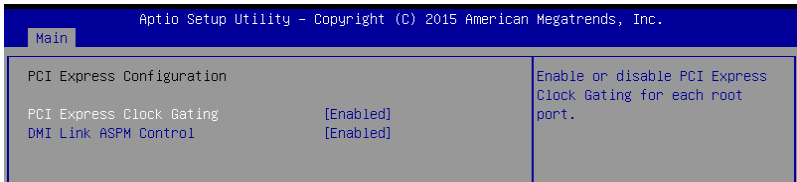

### PCI Express Clock Gating [Enabled]

Allows you to enable or disable PCI Express Clock Gating for each root port.

Configuration options: [Disabled] [Enabled]

### DMI Link ASPM Control [Enabled]

Allows you to enable or disable the control of Active State Power Management on SA side of the DMI link.

Configuration options: [Disabled] [Enabled]

## USB Configuration

Allows you to set the USB Configuration settings.

Aptio Setup Utility - Copyright (C) 2015 American Megatrends, Inc.	
Main	
USB Configuration	
USB Precondition	[Disabled]
xDCI Support	[Disabled]
USB Port Disable Override	[Disabled]

### USB Precondition [Disabled]

Allows you to precondition work on USB host controller and root ports for faster enumeration.

Configuration options: [Enabled] [Disabled]

### xDCI Support [Disabled]

Allows you to enable or disable xDCI (USB OTG Device).

Configuration options: [Disabled] [Enabled]

### USB Port Disable Override [Disabled]

Allows you to enable or disable the corresponding USB port from reporting a Device Connection to the controller.

Configuration options: [Disabled] [Select Per-Pin]

### CLKRUN# Logic [Enabled]

Allows you to enable or disable the CLKRUN# logic to stop the PCI clocks.

Configuration options: [Disabled] [Enabled]

### Serial IRQ Mode [Continuous]

Allows you to configure Serial IRQ mode.

Configuration options: [Quiet] [Continuous]

### High Precision Timer [Enabled]

Allows you to enable or disable the High Precision Event Timer.

Configuration options: [Disabled] [Enabled]

## Intel Server Platform Services

Aprio Setup Utility - Copyright (C) 2015 American Megatrends, Inc.

Advanced

Intel Server Platform Services Configuration	
ME BIOS Interface Ver	1.2
SPS Version	2308.0.3.36
ME FW Status Value	: 0xF0345
ME FW State	: SPS ME FW Active
ME FW Operation State	: M0 without UMA
ME FW Error Code	: No Error
ME NM FW Status Value	: 0x80000001
BIOS Booting Mode	: Performance Optimized mode
Cores Disabled	: 0
ME FW SKU Information	: NM + SiEn
End-of-POST Status	: EOP set during POST

++: Select Screen  
!l: Select Item  
Enter: Select  
+/-: Change Opt.  
F1: General Help  
F2: Previous Values  
F5: Optimized Defaults  
F10: Save Changes & Reset  
ESC: Exit

Version 2.17.1254. Copyright (C) 2015 American Megatrends, Inc.

## Intel TXT Information

Aprio Setup Utility - Copyright (C) 2015 American Megatrends, Inc.

Advanced

Intel TXT Information	
Chipset	Production Fused
BiosAcM	Production Fused
Chipset Txt	Supported
Cpu Txt	Supported
Error Code	None
Class Code	None
Major Code	None
Minor Code	None

## PCI/PCIE Subsystem Settings

Allows you to configure PCI, PCI-X, and PCI Express Settings.

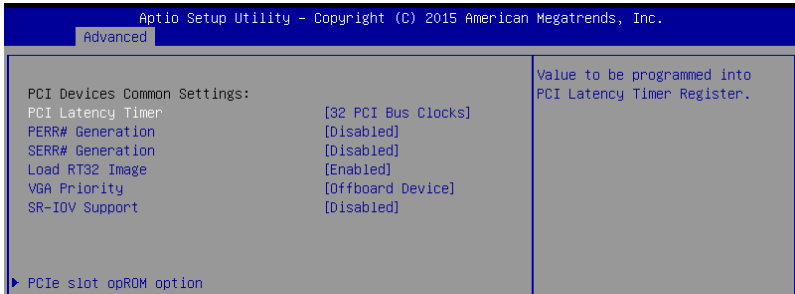

### PCI Latency Timer [32 PCI Bus Clocks]

Allows you to set the value to be programmed into PCI Latency Timer Register.

Configuration options: [32 PCI Bus Clocks] [64 PCI Bus Clocks] [96 PCI Bus Clocks]  
[128 PCI Bus Clocks] [160 PCI Bus Clocks] [192 PCI Bus Clocks]  
[224 PCI Bus Clocks] [248 PCI Bus Clocks]

### PERR# Generation [Disabled]

Allows you to enable or disable PCI Device to Generate PERR#.

Configuration options: [Disabled] [Enabled]

### SERR# Generation [Disabled]

Allows you to enable or disable PCI Device to Generate SERR#.

Configuration options: [Disabled] [Enabled]

### Load RT32 Image [Enabled]

Allows you to enable or disable RT32 Image Loading.

Configuration options: [Disabled] [Enabled]

### VGA Priority [Offboard Device]

This allows you to prioritize between onboard and the first offboard video device found.

Configuration options: [Onboard Device] [Offboard Device]

### SR-IOV Support [Disabled]

If system has SR-IOV capable PCIe devices, this option allows you to enable or disable Single Root IO Virtualization Support.

Configuration options: [Disabled] [Enabled]

## PCIe slot opROM option

Aptio Setup Utility - Copyright (C) 2015 American Megatrends, Inc.		
Advanced		
PCIe Slot Option Rom Setting		Enabled/Disabled PCIe6 Option Rom
PCIe6 Option Rom	[Enabled]	
PCIe5 Option Rom	[Enabled]	

### PCIe6/PCIe5 Option ROM [Enabled]

Allows you to enable or disable PCIe6/PCIe5/PCIe4 Option ROM.

Configuration options: [Disabled] [Enabled]

## 5.4.3 Platform Configuration

Aptio Setup Utility - Copyright (C) 2015 American Megatrends, Inc.	
Advanced	
▶ USB Configuration	USB Configuration Parameters
▶ NVMe Configuration	
▶ Onboard LAN Configuration	
▶ Super ID Configuration	
▶ Serial Port Console Redirection	
▶ ACPI Settings	
▶ APM	
▶ SMART Settings	
▶ WHEA Configuration	

## USB Configuration

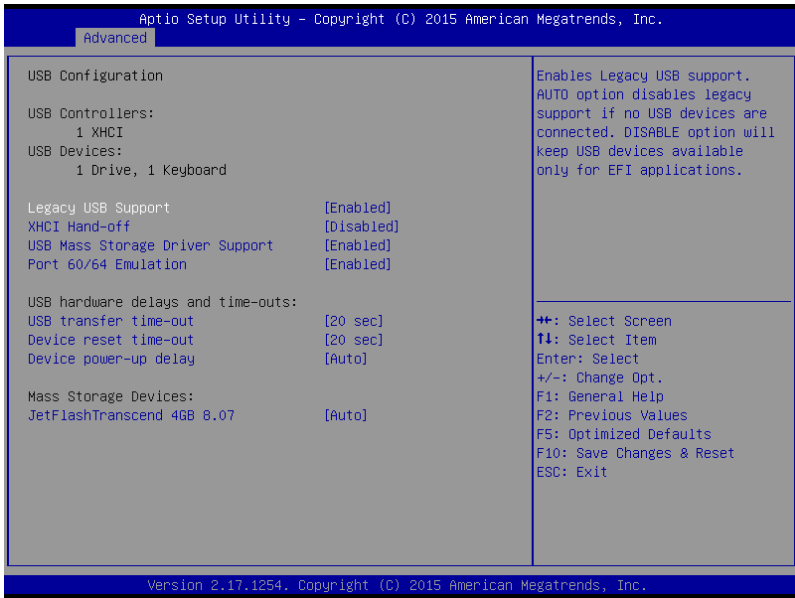

### Legacy USB Support [Enabled]

Allows you to enable or disable the support for legacy USB devices. If no USB device are connected, the legacy USB support is disabled.

Configuration options: [Enabled] [Disabled] [Auto]

### XHCI Hand-off [Disabled]

This functions as a workaround for OSes without XHCI hand-off support.

Configuration options: [Enabled] [Disabled]

### USB Mass Storage Driver Support [Enabled]

This allows you to enable or disable the USB Mass Storage driver support.

Configuration options: [Disabled] [Enabled]

### Port 60/64 Emulation [Enabled]

This allows you to enable the I/O port 60h/64h emulation support. This should be enabled for the complete USB keyboard legacy support for non-USB aware OSes.

Configuration options: [Disabled] [Enabled]

### USB transfer time-out [20 sec]

Allows you to select the USB transfer time-out value.  
Configuration options: [1 sec] [5 sec] [10 sec] [20 sec]

### Device reset time-out [20 sec]

Allows you to select the USB device reset time-out value.  
Configuration options: [10 sec] [20 sec] [30 sec] [40 sec]

### Device power-up delay [Auto]

This allows you to set the maximum time the device will take before it properly reports itself to the Host Controller.  
Configuration options: [Auto] [Manual]

## NVMe Configuration

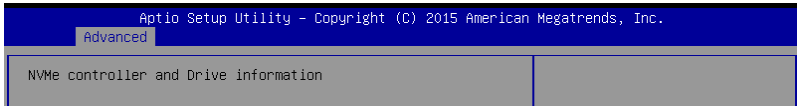

## Onboard LAN Configuration

This allows you to enable or disable the onboard LAN.

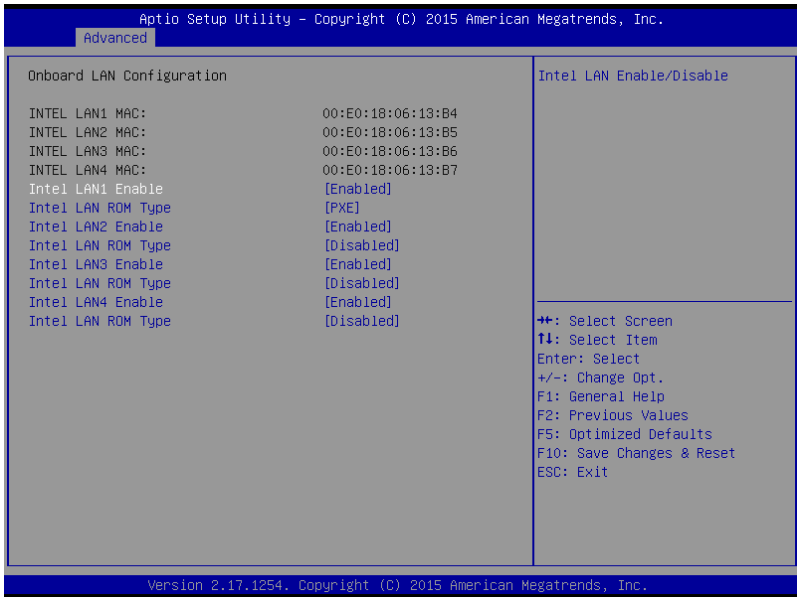

### Intel LAN1–4 Enable [Enabled]

Allows you to enable or disable the Intel LAN.  
Configuration options: [Disabled] [Enabled]

### Intel LAN ROM Type [PXE]/[Disabled]

Allows you to select the Intel LAN ROM type.  
Configuration options: [Disabled] [PXE] [iSCSI]

## Super IO Configuration

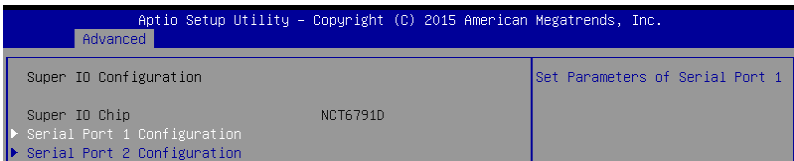

### Serial Port 1 Configuration

Allows you to set the parameters of Serial Port 1.

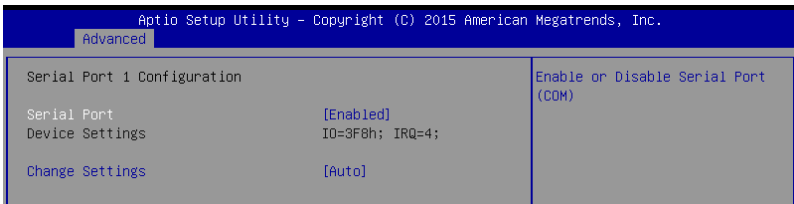

### Serial Port [Enabled]

Allows you to enable or disable Serial Port (COM).  
Configuration options: [Disabled] [Enabled]

### Change Settings [Auto]

Allows you to choose the setting for Super IO device.  
Configuration options: [Auto] [IO=3F8h; IRQ=4;]

[IO=3F8h; IRQ=3, 4, 5, 6, 7, 9, 10, 11, 12;]

[IO=2F8h; IRQ=3, 4, 5, 6, 7, 9, 10, 11, 12;]

[IO=3E8h; IRQ=3, 4, 5, 6, 7, 9, 10, 11, 12;]

[IO=2E8h; IRQ=3, 4, 5, 6, 7, 9, 10, 11, 12;]

## Serial Port 2 Configuration

Allows you to set the parameters of Serial Port 2.

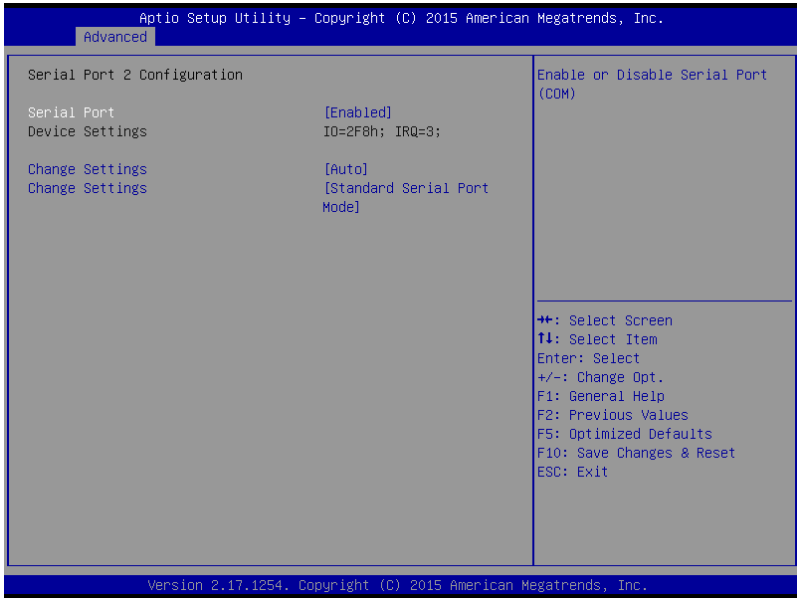

### Serial Port [Enabled]

Allows you to enable or disable Serial Port (COM).

Configuration options: [Disabled] [Enabled]

### Change Settings [Auto]

Allows you to choose the setting for Super IO device.

Configuration options: [Auto] [IO=2F8h; IRQ=3;]

[IO=3F8h; IRQ=3, 4, 5, 6, 7, 9, 10, 11, 12;]

[IO=2F8h; IRQ=3, 4, 5, 6, 7, 9, 10, 11, 12;]

[IO=3E8h; IRQ=3, 4, 5, 6, 7, 9, 10, 11, 12;]

[IO=2E8h; IRQ=3, 4, 5, 6, 7, 9, 10, 11, 12;]

### Change Settings [Standard Serial Port Mode]

Allows you to choose the setting for Super IO device.

Configuration options: [Standard Serial Port Mode] [IrDA Active pulse 1.6 uS]

[IrDA Active pulse 3/16 bit time] [ASKIR Mode]

## Serial Port Console Redirection

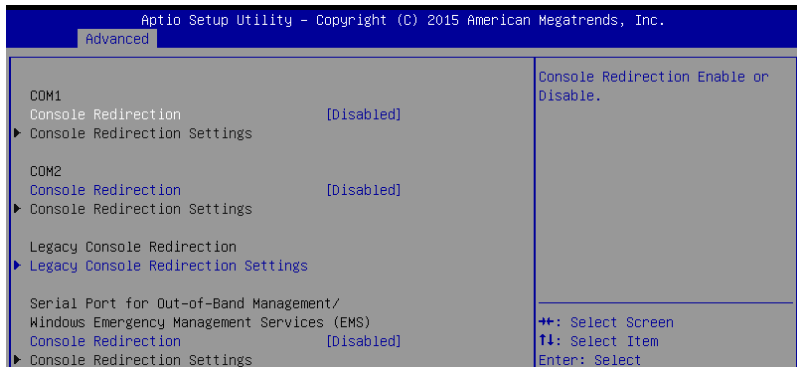

### COM1/COM2 Console Redirection [Disabled]

Allows you to enable or disable the console redirection feature.

Configuration options: [Disabled] [Enabled]



The **Console Redirection Settings** becomes configurable when **Console Redirection** is set to [Enabled].

### Console Redirection Settings

The settings specify how the host computer and the remote computer (which the user is using) will exchange data. Both computers should have the same or compatible settings.

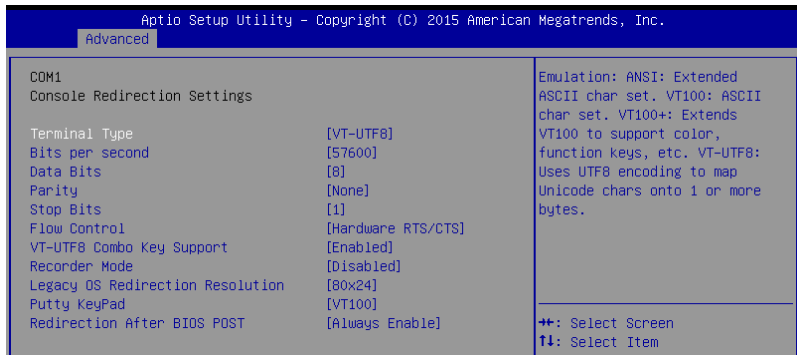

**Terminal Type [VT-UTF8]**

Allows you to set the terminal type.

- [VT100] ASCII char set.
- [VT100+] Extends VT100 to support color, function keys, etc.
- [VT-UTF8] Uses UTF8 encoding to map Unicode chars onto 1 or more bytes.
- [ANSI] Extended ASCII char set.

**Bits per second [57600]**

Selects serial port transmission speed. The speed must be matched on the other side. Long or noisy lines may require lower speeds.

Configuration options: [9600] [19200] [38400] [57600] [115200]

**Data Bits [8]**

Allows you to set the data bits.

Configuration options: [7] [8]

**Parity [None]**

Allows you to select the parity bit. A parity bit is sent with the data bits to detect transmission errors.

Configuration options: [None] [Even] [Odd] [Mark] [Space]

**Stop Bits [1]**

Stop bits indicate the end of a serial data packet (a start bit indicates the beginning). The standard setting is 1 stop bit. Communication with slow devices may require more than 1 stop bit.

Configuration options: [1] [2]

**Flow Control [Hardware RTS/CTS]**

Flow control can prevent data loss from buffer overflow. When sending data, if the receiving buffers are full, a “stop” signal can be sent to stop the data flow. Once the buffers are empty, a “start” signal can be sent to re-start the flow. Hardware flow control uses two wires to send start/stop signals.

Configuration options: [None] [Hardware RTS/CTS]

**VT-UTF8 Combo Key Support [Enabled]**

This allows you to enable the VT-UTF8 Combination Key Support for ANSI/VT100 terminals.

Configuration options: [Disabled] [Enabled]

**Recorder Mode [Disabled]**

This allows you to enable or disable the Recorder Mode to capture Terminal data.

Configuration options: [Disabled] [Enabled]

**Legacy OS Redirection Resolution [80x24]**

This allows you to set the number of rows and columns supported on the Legacy OS.

Configuration options: [80x24] [80x25]

**Putty Keypad [VT100]**

This allows you to select the FunctionKey and Keypad on Putty.

Configuration options: [VT100] [LINUX] [XTERMR6] [SCO] [ESCN] [VT400]

**Redirection After BIOS POST [Always Enable]**

This setting allows you to specify if BootLoader is selected then Legacy console redirection.

Configuration options: [Always Enable] [BootLoader]

## Legacy Console Redirection Settings

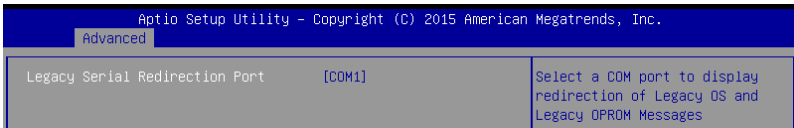

### Legacy Serial Redirection Port [COM1]

Allows you to select a COM port to display redirection of Legacy OS and Legacy OPROM Messages.

Configuration options: [COM1] [COM2]

### Console Redirection [Disabled]

Allows you to enable or disable the console redirection feature.

Configuration options: [Disabled] [Enabled]



The following item appears only when you set **Console Redirection** to [Enabled].

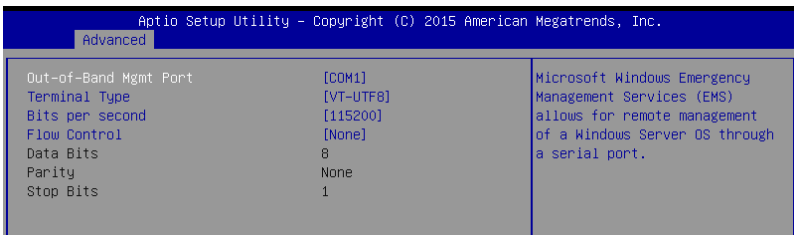

### Console Redirection Settings

#### **Out-of-Band Mgmt Port [COM1]**

Allows remote management of a Windows Server OS through a serial port.

Configuration options: [COM1] [COM2]

#### **Terminal Type [VT-UTF8]**

Allows you to set the terminal type for out-of-band management.

Configuration options: [VT100] [VT100+] [VT-UTF8] [ANSI]

#### **Bits per second [115200]**

Selects serial port transmission speed. The speed must be matched on the other side. Long or noisy lines may require lower speeds.

Configuration options: [9600] [19200] [57600] [115200]

#### **Flow Control [None]**

Allows you to set the flow control to prevent data loss from buffer overflow.

Configuration options: [None] [Hardware RTS/CTS] [Software Xon/Xoff]

## ACPI Settings

Aptio Setup Utility - Copyright (C) 2015 American Megatrends, Inc.		
Advanced		
ACPI Settings		Enables or Disables System ability to Hibernate (OS/S4 Sleep State). This option may be not effective with some OS.
Enable Hibernation	[Enabled]	
ACPI Sleep State	[S3 (Suspend to RAM)]	

### Enable Hibernation [Enabled]

Allows you to enable or disable the ability of the system to hibernate (OS/S4 Sleep State).  
Configuration options: [Disabled] [Enabled]



This option may not be effective with some OS.

### ACPI Sleep State [S3 (Suspend to RAM)]

Allows you to select the highest ACPI sleep state the system will enter when the SUSPEND button is pressed.

Configuration options: [Suspend Disabled] [S3 (Suspend to RAM)]

## APM

Allows you to configure the Advance Power Management (APM) settings.

Aptio Setup Utility - Copyright (C) 2015 American Megatrends, Inc.		
Advanced		
Restore AC Power Loss	[Last State]	Specify what state to go to when power is re-applied after a power failure (G3 state).
Power On By PCI	[Disabled]	
Power On By PCIE	[Disabled]	
Power On By Ring	[Disabled]	
Power On By RTC	[Disabled]	

### Restore AC Power Loss [Last State]

Allows you to set the state the system will go to after an AC power loss.

Configuration options: [Power Off] [Power On] [Last State]

### Power On By PCI [Disabled]

You can use this option to enable or disable the Wake-on-LAN feature of the Intel LAN.

Configuration options: [Disabled] [Enabled]

### Power On By PCIE [Disabled]

This allows you to enable or disable the PCIE devices to generate a wake event.

Configuration options: [Disabled] [Enabled]

### Power On By Ring [Disabled]

This allows you to enable or disable the Ring devices to generate a wake event.  
Configuration options: [Disabled] [Enabled]



This item functions only if there is a serial port (COM1) connector on a motherboard.

### Power On By RTC [Disabled]

This item allows you to enable or disable RTC to generate a wake event. When set to [Enabled], the items **RTC Alarm Date (Days)** and **Hour/Minute/Second** becomes user-configurable where you can set values.

Configuration options: [Disabled] [Enabled]

## SMART Settings

Aptio Setup Utility - Copyright (C) 2015 American Megatrends, Inc.	
Advanced	
SMART Settings	Run SMART Self Test on all HDDs during POST.
SMART Self Test	[Enabled]

### SMART Self Test [Enabled]

Allows you to run SMART Self Test on all HDDs during POST.

Configuration options: [Disabled] [Enabled]

## WHEA Configuration

Aptio Setup Utility - Copyright (C) 2015 American Megatrends, Inc.	
Advanced	
WHEA Support	Enable or disable Windows Hardware Error Architecture.
	[Enabled]

### WHEA Support [Enabled]

Allows you to enable or disable the WHEA (Windows Hardware Error Architecture) support.

Configuration options: [Disabled] [Enabled]

## 5.4.4 CPU Configuration

The items in this menu show the CPU-related information that the BIOS automatically detects. Some items may not appear if your CPU does not support the related functions.

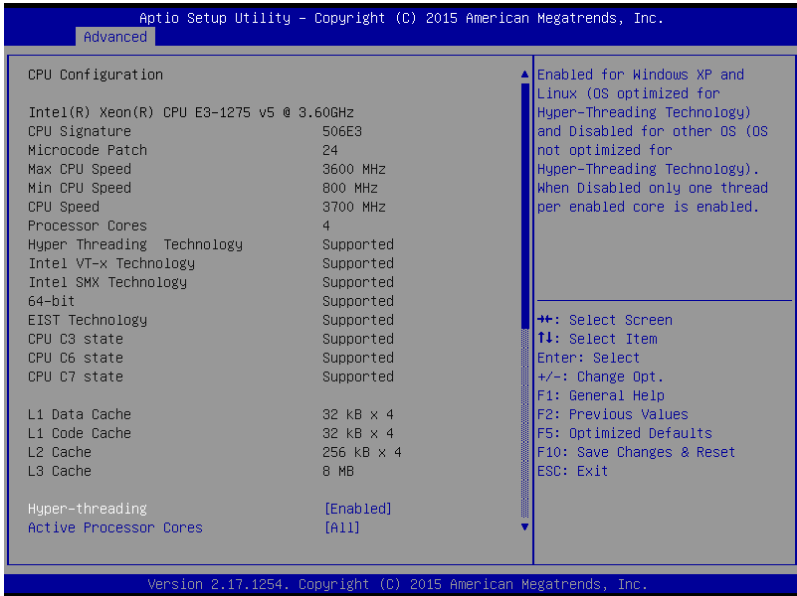

Navigate to the second page of the screen to see the rest of items in this menu by pressing the Up or Down arrow keys.



To quickly go to the last item of the second page, press the **Page Down** button. Press the **Page Up** button to go back to the first item in the first page.

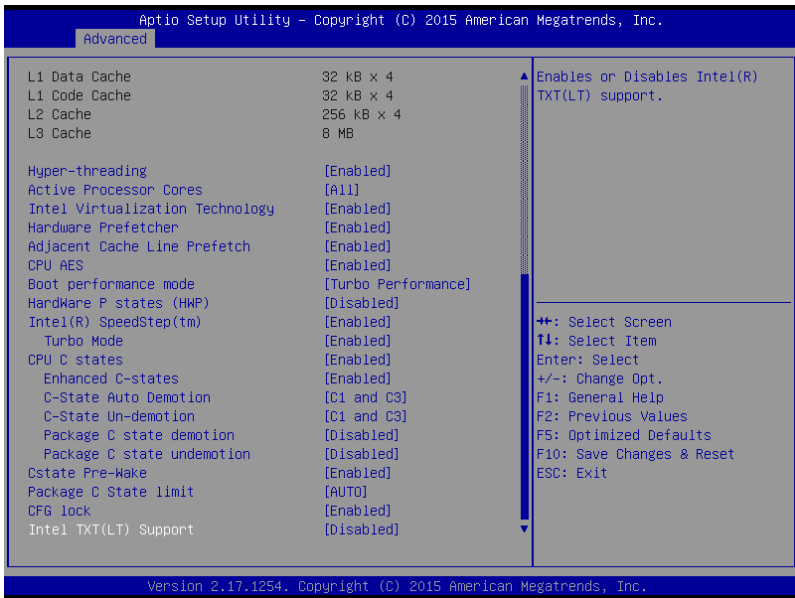

### Hyper-threading [Enabled]

This item allows a hyper-threading processor to appear as two logical processors, allowing the operating system to schedule two threads or processors simultaneously.

Configuration options: [Disabled] [Enabled]

### Active Processor Cores [All]

Allows you to choose the number of CPU cores to activate in each processor package.

Configuration options: [All] [1] [2] [3]

### Intel Virtualization Technology [Enabled]

When enabled, a VMM can utilize the additional hardware capabilities provided by Vanderpool Technology.

Configuration options: [Disabled] [Enabled]

### Hardware Prefetcher [Enabled]

Allows you to enable or disable the MLC streamer prefetcher.

Configuration options: [Disabled] [Enabled]

### Adjacent Cache Line Prefetch [Enabled]

Allows you to enable or disable prefetching of adjacent cache lines.

Configuration options: [Disabled] [Enabled]

### CPU AES [Enabled]

Allows you to enable or disable the CPU Advance Encryption Standard instructions.

Configuration options: [Disabled] [Enabled]

### **Boot performance mode [Turbo Performance]**

This item allows you to select the performance state that the BIOS will set before OS handoff.  
Configuration options: [Max Non-Turbo Performance] [Turbo Performance]

### **HardWare P states (HWP) [Disabled]**

Allows you to enable or disable HWP support.  
Configuration options: [Disabled] [Enabled]

### **Intel(R) SpeedStep(tm) [Enabled]**

Allows your system to adjust the CPU's voltage and cores frequency, resulting in decreased power consumption and heat production.  
Configuration options: [Disabled] [Enabled]



---

The following item appear only when you set the Intel(R) SpeedStep(tm) to **[Enabled]**.

---

### **Turbo Mode [Enabled]**

This item allows you to automatically set the CPU cores to run faster than the base operating frequency when it is below the operating power, current and temperature specification limit.  
Configuration options: [Disabled] [Enabled]

### **CPU C states [Enabled]**

Allows you to enable or disable the CPU C states.  
Configuration options: [Disabled] [Enabled]



---

The following items appear only when you set the CPU C states to **[Enabled]**.

---

### **Enhanced C-States [Enabled]**

This item allows you to enable or disable C1E. When enabled, CPU will switch to minimum speed when all cores enter C-State.  
Configuration options: [Disabled] [Enabled]

### **C-State Auto Demotion [C1 and C3]**

Allows you to enable or disable the Auto Demotion of C-State.  
Configuration options: [Disabled] [C1] [C3] [C1 and C3]

### **C-State Un-demotion [C1 and C3]**

Allows you to enable or disable the Un-demotion of C-State.  
Configuration options: [Disabled] [C1] [C3] [C1 and C3]

### **Package C state demotion [Disabled]**

Allows you to enable or disable the Package C state demotion.  
Configuration options: [Disabled] [Enabled]

### **Package C state undemotion [Disabled]**

Allows you to enable or disable the Package C state undemotion.  
Configuration options: [Disabled] [Enabled]

### CState Pre-Wake [Enabled]

Allows you to enable or disable the CState Pre-Wake. Selecting **[Disabled]** will set bit 30 of POWER\_CTL MSR(0x1FC) to 1 to disable the CState Pre-Wake.

Configuration options: [Disabled] [Enabled]

### Package C State limit [AUTO]

Allows you set the Package C State limit.

Configuration options: [C0/C1] [C2] [C3] [C6] [C7] [C7s] [C8] [AUTO]

### CFG lock [Enabled]

Allows you to configure MSR 0xE2[15], CFG lock bit.

Configuration options: [Disabled] [Enabled]

### Intel TXT(LT) Support [Disabled]

Allows you to enable or disable the Intel(R) TXT(LT) support.

Configuration options: [Disabled] [Enabled]

## 5.4.5 SATA Configuration

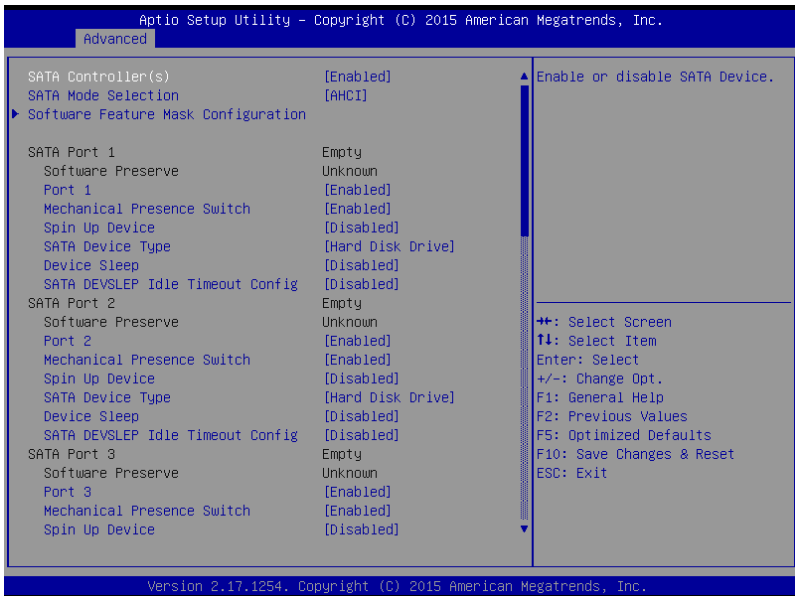

### SATA Controller(s) [Enabled]

Allows you to enable or disable the SATA Device.

Configuration options: [Enabled] [Disabled]

### SATA Mode Selection [AHCI]

This allows you to choose how SATA controller(s) should operate.

Configuration options: [AHCI] [RAID]

## Software Feature Mask Configuration

Aptio Setup Utility - Copyright (C) 2015 American Megatrends, Inc.		
Advanced		
RAID0	[Enabled]	Enable or disable RAID0 feature.
RAID1	[Enabled]	
RAID10	[Enabled]	
RAID5	[Enabled]	
Intel Rapid Recovery Technology	[Enabled]	
OROM UI and BANNER	[Enabled]	
HDD Unlock	[Enabled]	
LED Locate	[Enabled]	
IRRT Only on eSATA	[Enabled]	
Smart Response Technology	[Enabled]	
OROM UI Normal Delay	[4 sec]	
RST Force Form	[Disabled]	

### **RAID0 [Enabled]**

Allows you to enable or disable the RAID0 feature.

Configuration options: [Disabled] [Enabled]

### **RAID1 [Enabled]**

Allows you to enable or disable the RAID1 feature.

Configuration options: [Disabled] [Enabled]

### **RAID10 [Enabled]**

Allows you to enable or disable the RAID10 feature.

Configuration options: [Disabled] [Enabled]

### **RAID5 [Enabled]**

Allows you to enable or disable the RAID5 feature.

Configuration options: [Disabled] [Enabled]

### **Intel Rapid Recovery Technology [Enabled]**

Allows you to enable or disable the Intel Rapid Recovery Technology.

Configuration options: [Disabled] [Enabled]

### **OROM UI and BANNER [Enabled]**

[Disabled] No OROM banner or information will be displayed if all disks and RAID volumes are Normal.

[Enabled] OROM UI is shown.

### **HDD Unlock [Enabled]**

Selecting [Enabled] will indicate that the HDD password unlock in the OS is enabled.

Configuration options: [Disabled] [Enabled]

### **LED Locate [Enabled]**

Selecting [Enabled] will indicate that the LED/SGPIO hardware is attached and ping to locate feature is enabled on the OS.

Configuration options: [Disabled] [Enabled]

### **IRRT Only on eSATA [Enabled]**

[Disabled] Any RAID volume can span internal and eSATA drives.

[Enabled] Only IRRT volumes can span internal and eSATA drives.

### **Smart Response Technology [Enabled]**

Allows you to enable or disable the Smart Response Technology.

Configuration options: [Disabled] [Enabled]

**OROM UI Normal Delay [4 sec]**

Allows you to select the delay time of the OROM UI Splash Screen in a normal status.

Configuration options: [2 sec] [4 sec] [6 sec] [8 sec]

**RST Force Form [Disabled]**

Allows you to enable or disable Form for Intel Rapid Storage Technology.

Configuration options: [Disabled] [Enabled]

**SATA Port 1–6****Port 1–6 [Enabled]**

Allows you to enable or disable the SATA port.

Configuration options: [Disabled] [Enabled]

**Mechanical Presence Switch [Enabled]**

Allows you to enable or disable reporting if the port has an Mechanical Presence Switch.

Configuration options: [Disabled] [Enabled]

**Spin Up Device [Disabled]**

Enable this option to start a COMERSET initialization sequence to the device on an edge detect from 0 to 1.

Configuration options: [Disabled] [Enabled]

**SATA Device Type [Hard Disk Drive]**

Allows you to set whether the SATA port is connected to Solid State Drive or Hard Disk Drive.

Configuration options: [Hard Disk Drive] [Solid State Drive]

**Device Sleep [Disabled]**

Allows you to enable or disable the mSata for RTD3.

Configuration Options: [Disabled] [Enabled]

**SATA DEVSLEP Idle Timeout Config [Disabled]**

Allows you to enable or disable SATA DTIO Config.

Configuration options: [Disabled] [Enabled]

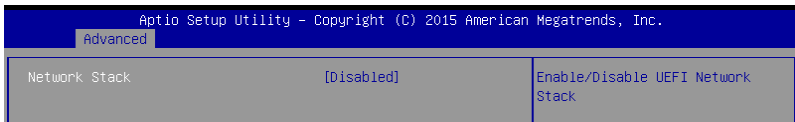
**5.4.6 Network Stack Configuration****Network Stack [Disabled]**

Allows you to enable or isable UEFI Network Stack.

Configuration options: [Disabled] [Enabled]

## 5.4.7 CSM Configuration

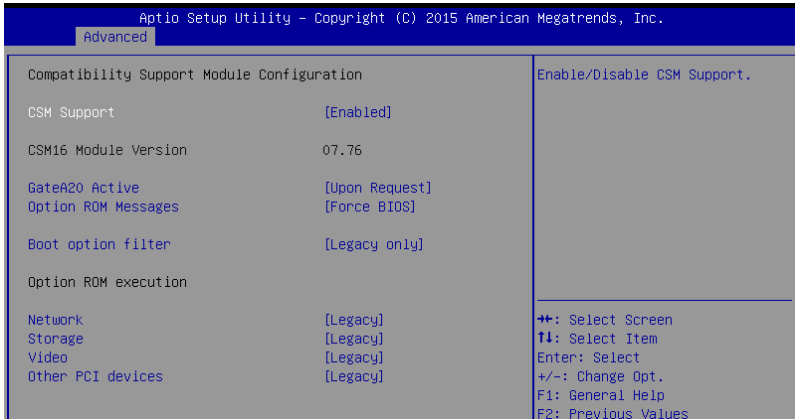

### CSM Support [Enabled]

This option allows you to enable or disable CSM Support.

Configuration options: [Disabled] [Enabled]

### GateA20 Active [Upon Request]

This allows you to set the GA20 option.

[Upon Request] GA20 can be disabled using BIOS services.

[Always] Do not allow disabling GA20; this option is useful when any RT code is executed above 1MB

### Option ROM Messages [Force BIOS]

This allows you to set the display mode for Option ROM.

Configuration options: [Force BIOS] [Keep Current]

### Boot Option filter [Legacy only]

This option allows you to control the Legacy/UEFI ROMs priority.

Configuration options: [UEFI and Legacy] [Legacy only] [UEFI only]

### Network / Storage / Video [Legacy]

This option allows you to control the execution of UEFI and Legacy PXE/Storage/Video OpROM.

Configuration options: [UEFI ] [Legacy]

### Other PCI devices [Legacy]

This item determines the OpROM execution policy for devices other than Network, Storage, or Video.

Configuration options: [UEFI ] [Legacy]

## 5.4.8 iSCSI Configuration

Allows you to configure the iSCSI parameters.

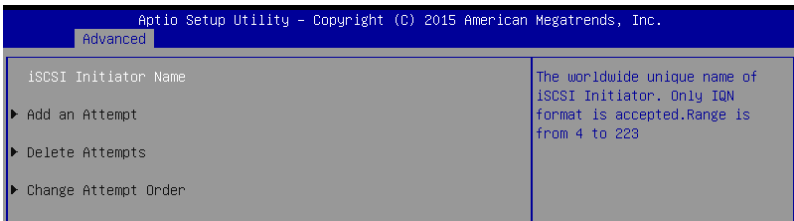

## 5.5 Security menu

This menu allows a new password to be created or a current password to be changed. The menu also enables or disables the Secure Boot state and lets the user configure the System Mode state.

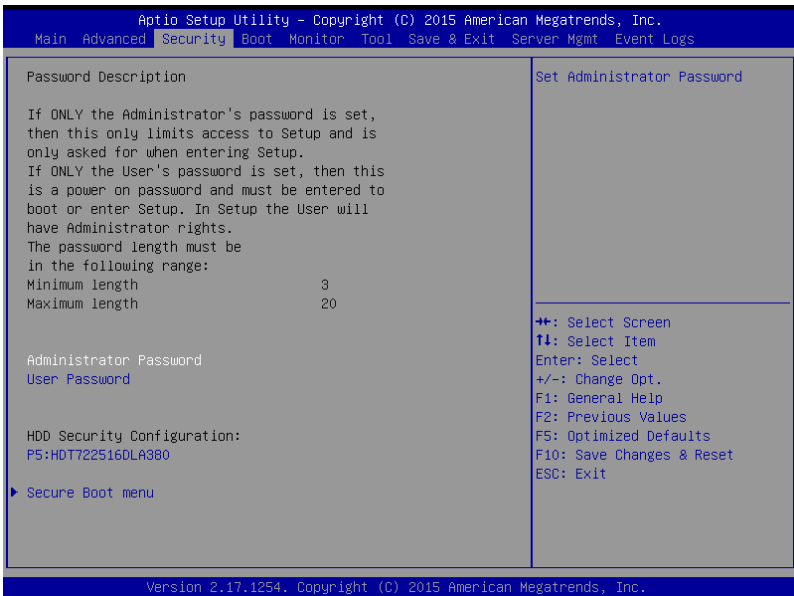

## Administrator Password

To set an Administrator Password:

1. Select the Administrator Password item and press <Enter>.
2. From the Create New Administrator Password box, key in a password, then press <Enter>.
3. Confirm the password when prompted.

To change an administrator password:

1. Select the Administrator Password item and press <Enter>.
2. From the Enter Current Administrator Password box, key in the current password, then press <Enter>.
3. From the Create New Administrator Password box, key in a new password, then press <Enter>.
4. Confirm the password when prompted.



---

To clear the Administrator Password, follow the same steps as in changing an Administrator Password, but press <Enter> when prompted to create/confirm the password.

---

## User Password

To set a User Password:

1. Select the User Password item and press <Enter>.
2. From the Create New User Password box, key in a password, then press <Enter>.
3. Confirm the password when prompted.

To change a user password:

1. Select the User Password item and press <Enter>.
2. From the Enter Current User Password box, key in the current password, then press <Enter>.
3. From the Create New User Password box, key in a new password, then press <Enter>.
4. Confirm the password when prompted.



---

To clear the User Password, follow the same steps as in changing a User Password, but press <Enter> when prompted to create/confirm the password.

---

## Secure Boot Menu

This item allows you to customize the Secure Boot settings.

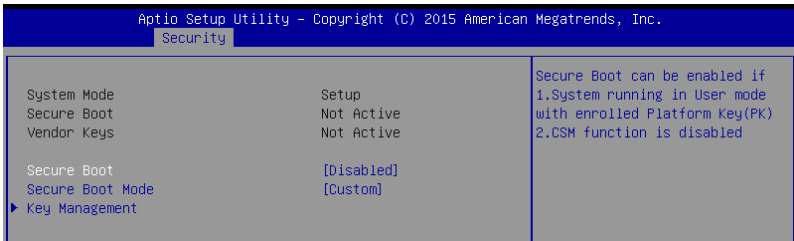

### Secure Boot [Disabled]

This item allows you to enable or disable the Secure Boot flow control.

Configuration options: [Disabled] [Enabled]

### Secure Boot Mode [Custom]

This item allows you to select the mode of the Secure Boot to change Image Execution policy and manage Secure Boot Keys.

Configuration options: [Standard] [Custom]

## Key Management

This item only appears when you set the Secure Boot Mode to **[Custom]**. This allows you to modify Secure Boot variables and set Key Management page.

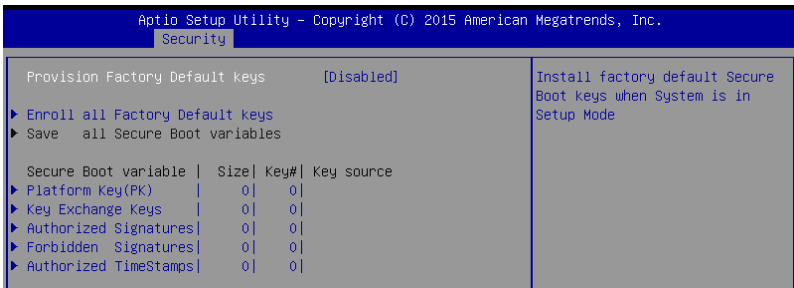

### Provision Factory Default Keys [Disabled]

Configuration options: [Disabled] [Enabled]

### Enroll All Factory Default Keys

This item will ask you if you want to install all Factory Default secure variables. Select Yes if you want to load the default secure variables, otherwise select No.

### Platform Key (PK) / Key Exchange Keys / Authorized Signatures / Forbidden Signatures / Authorized TimeStamps

Configuration options: [Set New Key] [Append Key]

# 5.6 Boot menu

The Boot menu items allow you to change the system boot options.

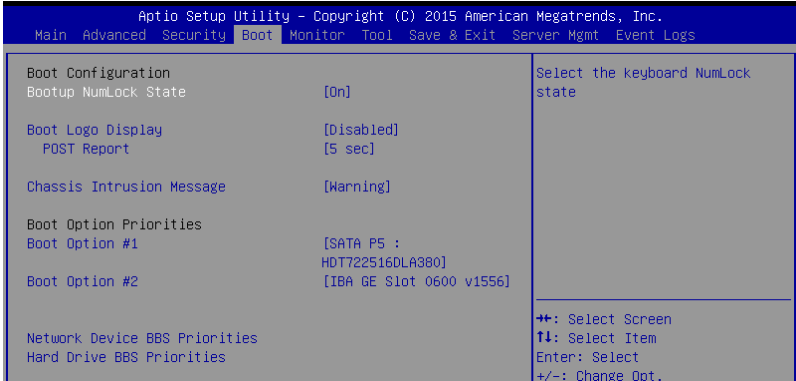

## Bootup NumLock State [On]

Allows you to select the power-on state for the NumLock.

Configuration options: [On] [Off]

## Boot Logo Display [Disabled]

Allows you to enable or disable the full screen logo display feature.

- [Auto] Auto adjustment for Windows requirements.
- [Full Screen] Maximize the boot logo size.
- [Disabled] Hide the logo during POST.

### POST Report [5 sec]

Allows you to set the desired POST Report waiting time from 1 to 10 seconds.

Configuration options: [1 sec] – [10 sec] [Until Press ESC]

## Chassis Intrusion Message [Warning]

Allows you to set an action when chassis intrusion has occurred.

- [Warning] Warning beep and pause at intrusion message for 3 seconds.
- [Halt] Halt at intrusion message.

## Boot Option Priorities

These items specify the boot device priority sequence from the available devices. The number of device items that appears on the screen depends on the number of devices installed in the system.



- To select the boot device during system startup, press <F8> when ASUS Logo appears.
- To access Windows OS in Safe Mode, please press <F8> after POST.

## Boot Option #1–2 [IBA GE Slot 0600 v1556]

Configuration options: [IBA GE Slot 0600 v1566] [Disabled]

## Network Device BBS Priorities

These items appear only when you connect SATA ODD or hard drive to the SATA ports and allow you to set the booting order of the SATA devices.

## Hard Drive BBS Priorities

These items appear only when you connect SATA ODD or hard drive to the SATA ports and allow you to set the booting order of the SATA devices.

## 5.7 Monitor menu

The Monitor menu displays the system temperature/power status, and allows you to change the fan settings.

Aptio Setup Utility - Copyright (C) 2015 American Megatrends, Inc.		
Main Advanced Security Boot Monitor <b>Tool</b> Save & Exit Server Mgmt Event Logs		
CPU1 Temperature	: +45°C / 138°F	Low Speed/Generic/High Speed/Full Speed
CPU_FAN1 Speed	: N/A	
FRNT_FAN1 Speed	: 1670 RPM	
FRNT_FAN2 Speed	: N/A	
FRNT_FAN3 Speed	: N/A	
FRNT_FAN4 Speed	: N/A	
REAR_FAN1 Speed	: N/A	
+V CORE1 Voltage	: +1.192 V	
+V DDDQ_AB_CPU1 Voltage	: +1.248 V	
+V CCO1 Voltage	: +0.968 V	
+12V Voltage	: +11.904 V	
+5V Voltage	: +4.720 V	
+3V Voltage	: +2.992 V	
+5VSB Voltage	: +4.760 V	
+3VSB Voltage	: +3.312 V	
VBAT Voltage	: +3.232 V	
+V CCSA	: +1.064 V	
FAN Speed Control	[Generic Mode]	
		<b>+</b> : Select Screen <b>↑↓</b> : Select Item Enter: Select +/-: Change Opt. F1: General Help F2: Previous Values F5: Optimized Defaults

### Fan Speed Control [Generic Mode]

Allows you to configure the ASUS Smart Fan feature that smartly adjusts the fan speeds for more efficient system operation.

Configuration options: [Generic Mode] [High Speed Mode] [Full Speed Mode]

## 5.8 Tool menu

The Tool menu items allow you to configure options for special functions. Select an item then press <Enter> to display the submenu.

Aptio Setup Utility - Copyright (C) 2015 American Megatrends, Inc.	
Main Advanced Security Boot Monitor <b>Tool</b> Save & Exit Event Logs	
Start EzFlash	Press ENTER to run the utility to select and update BIOS.

### ASUS EZ Flash

Allows you to run the Start EzFlash utility. For more information, see section

#### 5.1.2 ASUS EzFlash Utility.

## 5.9 Save & Exit menu

The Exit menu items allow you to save or discard your changes to the BIOS items.

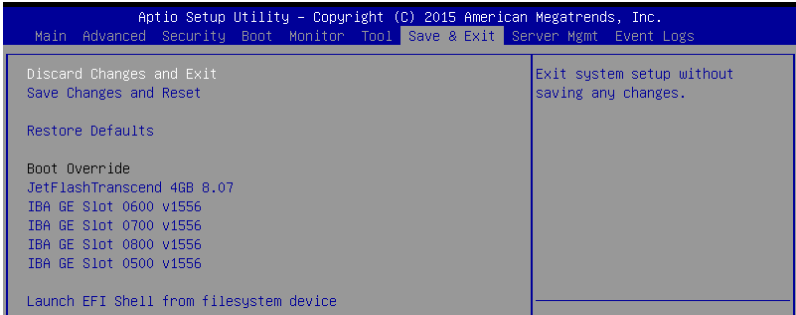

Pressing <Esc> does not immediately exit this menu. Select one of the options from this menu or <F10> from the legend bar to exit.

### Discard Changes and Exit

Exit System setup without saving any changes.

### Save Changes and Reset

Reset the system setup after saving the changes.

### Restore Defaults

Restore/Load default values for all the setup options.

### Boot Override

These items display the available devices. The device items that appear on the screen depend on the number of devices installed in the system. Click an item to start booting from the selected device.

### Launch EFI Shell from filesystem device

Attempts to launch EFI Shell application (Shell.efi) from one of the available filesystem devices.

## 5.10 Server Mgmt menu

The Server Management menu displays the server management status and allows you to change the settings.

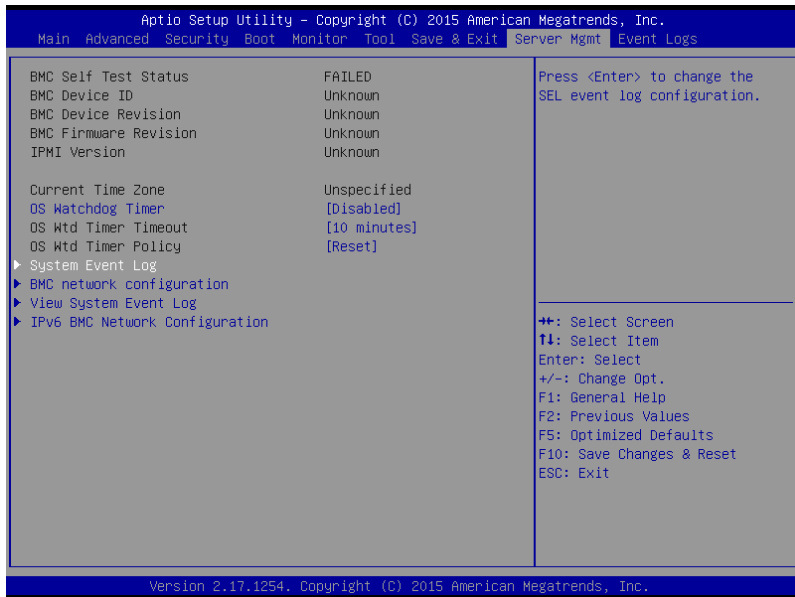

### OS Watchdog Timer [Disabled]

This item allows you to start a BIOS timer which can only be shut off by Management Software after the OS loads.

Configuration options: [Enabled] [Disabled]



The following items is configurable only when the OS Watchdog Timer is set to **[Enabled]**.

### OS Wtd Timer Timeout [10 minutes]

Allows you to configure the length for the OS Boot Watchdog Timer.

Configuration options: [5 minutes] [10 minutes] [15 minutes] [20 minutes]

### OS Wtd Timer Policy [Reset]

This item allows you to configure how the system should respond if the OS Boot Watch Timer expires.

Configuration options: [Do Nothing] [Reset] [Power Down] [Power Cycle]

## System Event Log

Allows you to change the SEL event log configuration.



- The following items appears only when you set SEL Components to **[Enabled]**.
- All values changed here do not take effect until computer is restarted.

### SEL Components **[Enabled]**

Allows you to enable or disable all features of system Event Logging during boot.

Configuration options: [Disabled] [Enabled]

### Erase SEL **[No]**

Allows you to choose options for erasing SEL.

Configuration options: [No] [Yes, On next reset] [Yes, On every reset]

### When SEL is Full **[Do Nothing]**

Allows you to choose options for reactions to a full SEL.

Configuration options: [Do Nothing] [Erase Immediately]

### Log EFI Status Codes **[Error code]**

Disable the logging of EFI Status Codes, or log only error code, or only progress code, or both.

Configuration options: [Disabled] [Both] [Error code] [Progress code]

## BMC network configuration

The sub-items in this configuration allow you to configure the BMC network parameters.

The screenshot shows the 'Aptio Setup Utility - Copyright (C) 2015 American Megatrends, Inc.' interface. The title bar indicates 'Server Mgmt'. The main window is titled 'BMC network configuration' and is split into two panes. The left pane lists configuration options for 'DM\_LAN1' and 'Shared LAN', each with a 'Config Address source' set to '[Previous State]'. The right pane contains instructions: 'Select to configure LAN channel parameters statically or dynamically (by BIOS or BMC). Previous State option will not modify any BMC network parameters during BIOS phase'. Below this, a legend lists navigation keys: '++: Select Screen', '↑↓: Select Item', 'Enter: Select', '+/-: Change Opt.', 'F1: General Help', 'F2: Previous Values', 'F5: Optimized Defaults', 'F10: Save Changes & Reset', and 'ESC: Exit'. The bottom status bar shows 'Version 2.17.1254. Copyright (C) 2015 American Megatrends, Inc.'

### Configuration Address source DM\_LAN1 / Shared LAN [Previous State]

This item allows you to configure LAN channel parameters statically or dynamically (by BIOS or BMC). Previous State option will not modify any BMC network parameters during BIOS phase.

Configuration options: [Previous State] [Static] [DynamicBmcDhcp]

## View System Event Log

This item allows you to view the System Event Log Records.

## IPv6 BMC Network Configuration

This item allows you to configure the parameter settings of IPv6 BMC network.

The screenshot shows the 'Aptio Setup Utility' interface with the 'Server Mgmt' tab selected. The main window displays the 'IPv6 BMC Network Configuration' settings. On the right side, there is a legend for navigation keys.

IPv6 BMC Network Configuration		Display the Full or Brief IPv6 Field
IPv6 Display Full Field	[Enable]	
IPv6 Display Full Formula	[Enable]	
IPv6 Display Letter Case	[Upper Case]	
IPv6 BMC DM_LAN1		
IPv6 BMC Lan IP Address Source	[Previous State]	
Address Source in BMC :	-	
IP Address in BMC :	-	
->	[ ]	
Prefix Length in BMC :	-	
Gateway Address in BMC :	-	
->	[ ]	
MAC Address in BMC :	-	
IPv6 BMC Shared Lan		
IPv6 BMC Lan IP Address Source	[Previous State]	
Address Source in BMC :	-	
IP Address in BMC :	-	
->	[ ]	
Prefix Length in BMC :	-	
Gateway Address in BMC :	-	
->	[ ]	
MAC Address in BMC :	-	

Legend:

- ++: Select Screen
- T4: Select Item
- Enter: Select
- +/-: Change Opt.
- F1: General Help
- F2: Previous Values
- F5: Optimized Defaults
- F10: Save Changes & Reset
- ESC: Exit

Version 2.17.1254. Copyright (C) 2015 American Megatrends, Inc.

### IPv6 Display Full Field [Enable]

Displays the Full or Brief IPv6 Field.

Configuration options: [Disable] [Enable]

### IPv6 Display Full Formula [Enable]

Displays the Full or Brief IPv6 Formula.

Configuration options: [Disable] [Enable]

### IPv6 Display Letter Case [Upper Case]

Displays the uppercase or lowercase letters of the alphabet.

Configuration options: [Lower Case] [Upper Case]

### IPv6 BMC LAN IP Address source [Previous State]

Select to configure LAN channel parameters statically or dynamically (by BIOS or BMC).

Configuration options: [Previous State] [Static] [Dynamic-Obtained by BMC running DHCP]

# 5.11 Event Logs menu

The Event Logs menu items allow you to change the event log settings and view the system event logs.

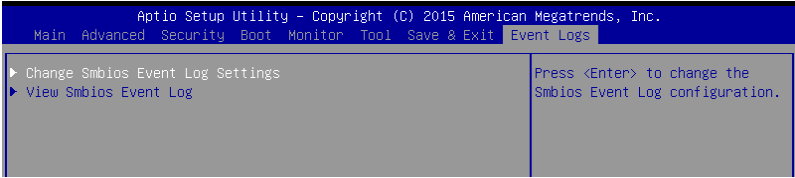

## Change Smbios Event Log Settings

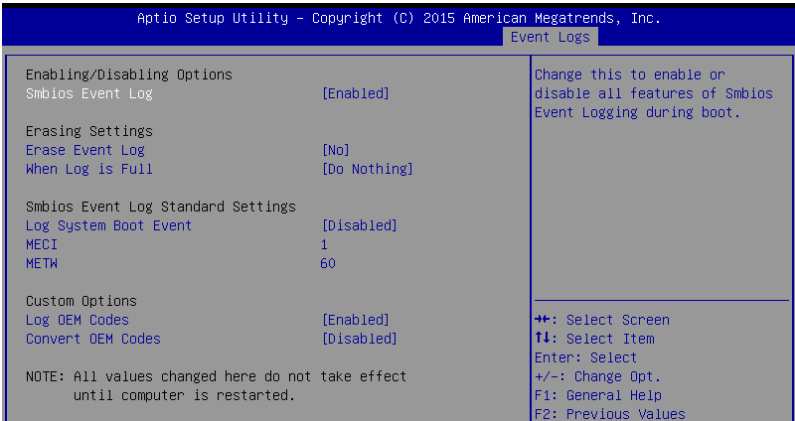

### Smbios Event Log [Enabled]

Change this to enable or disable all features of Smbios Event Logging during boot.  
Configuration options: [Disabled] [Enabled]

### Erase Event Log [No]

Choose options for erasing Smbios Event Log. Erasing is done prior to any logging activation during reset.  
Configuration options: [No] [Yes, Next reset] [Yes, Every reset]

### When Log is Full [Do Nothing]

Allows you to choose options for reactions to a full Smbios Event Log.  
Configuration options: [Do Nothing] [Erase Immediately]

### Log System Boot Event [Disabled]

Allows you to enable or disable logging of System boot event.  
Configuration options: [Enabled] [Disabled]

### MECI [1]

Allows you to set the value for the number of occurrences of a duplicate event that must pass before the multiple-event counter of log entry is updated. Use the <+> and <-> keys to adjust the value.  
Configuration options: [1] - [255]

**METW [60]**

Allows you to set the value for the number of minutes which must pass between duplicate log entries which utilize a multiple-event counter. Use the <+> and <-> keys to adjust the value.

Configuration options: [0] - [99]

**Log OEM Codes [Enabled]**

Allows you to enable or disable the logging of EFI Status Codes as OEM codes (if not already converted to legacy).

Configuration options: [Disabled] [Enabled]

**Convert OEM Codes [Disabled]**

Allows you to enable or disable the converting of EFI Status Codes to Standard Smbios Types (not all may be translated).

Configuration options: [Disabled] [Enabled]



# **RAID Configuration**

# 6

This chapter provides instructions for setting up, creating, and configuring RAID sets using the available utilities.

## 6.1 Setting up RAID

The motherboard supports the following SATA RAID solutions:

- **Intel® Rapid Storage Technology enterprise Option ROM Utility** with RAID 0, RAID 1, RAID 10, and RAID 5 support (for Windows OS only).

### 6.1.1 RAID definitions

**RAID 0** (*Data striping*) optimizes two identical hard disk drives to read and write data in parallel, interleaved stacks. Two hard disks perform the same work as a single drive but at a sustained data transfer rate, double that of a single disk alone, thus improving data access and storage. Use of two new identical hard disk drives is required for this setup.

**RAID 1** (*Data mirroring*) copies and maintains an identical image of data from one drive to a second drive. If one drive fails, the disk array management software directs all applications to the surviving drive as it contains a complete copy of the data in the other drive. This RAID configuration provides data protection and increases fault tolerance to the entire system. Use two new drives or use an existing drive and a new drive for this setup. The new drive must be of the same size or larger than the existing drive.

**RAID 10** is data striping and data mirroring combined without parity (redundancy data) having to be calculated and written. With the RAID 10 configuration you get all the benefits of both RAID 0 and RAID 1 configurations. Use four new hard disk drives or use an existing drive and three new drives for this setup.

**RAID 5** stripes both data and parity information across three or more hard disk drives. Among the advantages of RAID 5 configuration include better HDD performance, fault tolerance, and higher storage capacity. The RAID 5 configuration is best suited for transaction processing, relational database applications, enterprise resource planning, and other business systems. Use a minimum of three identical hard disk drives for this setup.



---

If you want to boot the system from a hard disk drive included in a created RAID set, copy first the RAID driver from the support DVD to a floppy disk before you install an operating system to the selected hard disk drive.

---

## 6.1.2 Installing hard disk drives

The motherboard supports Serial ATA for RAID set configuration. For optimal performance, install identical drives of the same model and capacity when creating a disk array.

To install the SATA hard disks for RAID configuration:

1. Install the SATA hard disks into the drive bays following the instructions in the system user guide.
2. Connect a SATA signal cable to the signal connector at the back of each drive and to the SATA connector on the motherboard.
3. Connect a SATA power cable to the power connector on each drive.

## 6.1.3 Setting the RAID item in BIOS

You must set the RAID item in the BIOS Setup before you can create a RAID set from SATA hard disk drives attached to the SATA connectors supported by Intel® C232 chipset. To do this:

1. Enter the BIOS Setup during POST.
2. Go to the **Advanced Menu > PCH SATA Configuration**, then press <Enter>.
3. Set **SATA Mode** to [RAID Mode]
4. Press <F10> to save your changes and exit the BIOS Setup.



---

Refer to Chapter 5 for details on entering and navigating through the BIOS Setup.

---

## 6.1.4 RAID configuration utilities

Depending on the RAID connectors that you use, you can create a RAID set using the utilities embedded in each RAID controller. For example, use the **Intel® Rapid Storage Technology** if you installed Serial ATA hard disk drives on the Serial ATA connectors supported by the Intel® C232 chipset.

Refer to the succeeding section for details on how to use the RAID configuration utility.

## 6.2 Intel® Rapid Storage Technology enterprise SATA Option ROM Utility

The Intel® Rapid Storage Technology enterprise SATA Option ROM utility allows you to create RAID 0, RAID 1, RAID 10 (RAID 1+0), and RAID 5 set from Serial ATA hard disk drives that are connected to the Serial ATA connectors supported by the Southbridge.



Before you proceed, ensure that you have installed the Serial ATA hard disk drives, and have set the correct SATA mode in the BIOS setup. You can refer to sections **6.1.2 Installing hard disk drives** and **6.1.3 Setting the RAID mode in BIOS** for more information.

To launch the Intel® Rapid Storage Technology enterprise SATA Option ROM utility:

1. Turn on the system.
2. During POST, press <Ctrl>+<I> to display the utility main menu.

```
Intel(R) Rapid Storage Technology enterprise - SATA Option ROM - 3.6.0.1023
Copyright(C) 2003-12 Intel Corporation. All Rights Reserved.

[ MAIN MENU ]
1. Create RAID Volume
2. Delete RAID Volume
3. Reset Disks to Non-RAID
4. Exit

[ DISK/VOLUME INFORMATION ]

RAID Volumes:
None defined.

Physical Disks:
ID Drive Model Serial # Size Type/Status (Vol ID)
0 ST3300656SS HWSA0000991753TR 279.3GB Non-RAID Disk
1 ST3300656SS 37VN00009846RAJ1 279.3GB Non-RAID Disk
2 ST3300656SS 397600009846UEDY 279.3GB Non-RAID Disk
3 ST3300656SS GWC50000991756G6 279.3GB Non-RAID Disk

[↑↓]-Select [ESC]-Exit [ENTER]-Select Menu
```

The navigation keys at the bottom of the screen allow you to move through the menus and select the menu options.



The RAID BIOS setup screens shown in this section are for reference only and may not exactly match the items on your screen.

## 6.2.1 Creating a RAID set

To create a RAID set:

1. From the utility main menu, select **1. Create RAID Volume** and press <Enter>.
2. Key in a name for the RAID set and press <Enter>.

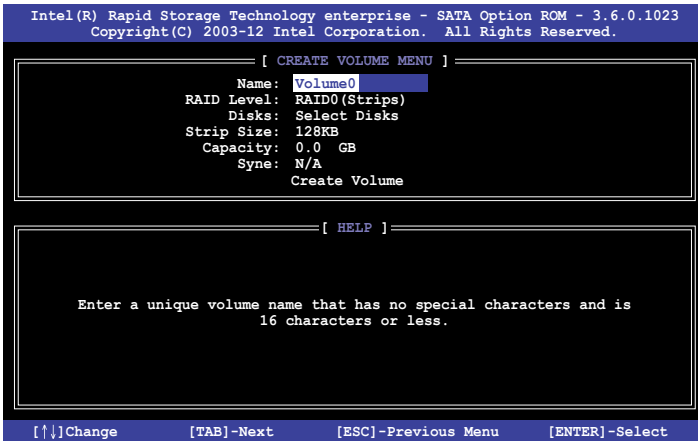

3. Press the up/down arrow keys to select a RAID Level that you wish to create then press <Enter>.
4. From the **Disks** item field, press <Enter> to select the hard disk drives that you want to include in the RAID set.

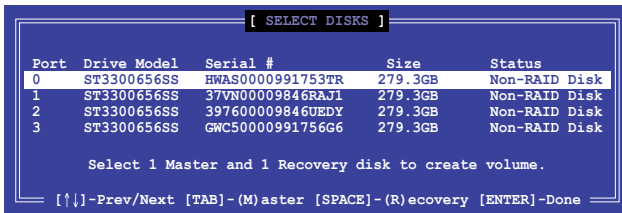

5. Use the up/down arrow keys to move the selection bar then press <Space> to select a disk. A small triangle before the Port number marks the selected drive. Press <Enter> when you are done.

- Use the up/down arrow keys to select the stripe size for the RAID array (for RAID 0, 10 and 5 only) then press <Enter>. The available stripe size values range from 4 KB to 128 KB. The following are typical values:  
RAID 0: 128KB  
RAID 10: 64KB  
RAID 5: 64KB



---

We recommend a lower stripe size for server systems, and a higher stripe size for multimedia computer systems used mainly for audio and video editing.

---

- In the **Capacity** field item, key in the RAID volume capacity that you want to use and press <Enter>. The default value field indicates the maximum allowed capacity.
- Press <Enter> to start creating the RAID volume.
- From the following warning message, press <Y> to create the RAID volume and return to the main menu, or press <N> to go back to the **CREATE VOLUME** menu.

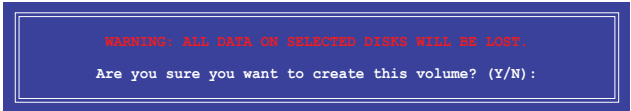

## 6.2.2 Deleting a RAID set



Take caution when deleting a RAID set. You will lose all data on the hard disk drives when you delete a RAID set.

To delete a RAID set:

1. From the utility main menu, select **2. Delete RAID Volume** and press <Enter>.
2. From the Delete Volume Menu, press the up/down arrow keys to select the RAID set you want to delete then press <Del>.

```
Intel(R) Rapid Storage Technology enterprise - SATA Option ROM - 3.6.0.1023
Copyright(C) 2003-12 Intel Corporation. All Rights Reserved.

[ DELETE VOLUME MENU ]

Name      Level      Drives    Capacity  Status    Bootable
Volume0   RAID0 (Stripe)  2         298.0GB   Normal    Yes

[ HELP ]

Deleting a volume will reset the disks to non-RAID

WARNING: ALL DISK DATA WILL BE DELETED.
(This does not apply to Recovery volumes)

[↑,↓]-Select      [ESC]-Previous Menu      [DEL]-Delete Volume
```

3. Press <Y> to confirm deletion of the selected RAID set and return to the utility main menu, or press <N> to return to the **DELETE VOLUME** menu.

```
[ DELETE VOLUME VERIFICATION ]

ALL DATA IN THE VOLUME WILL BE LOST!
(This does not apply to Recovery volumes)

Are you sure you want to delete volume "Volume0"? (Y/N):
```

## 6.2.3 Resetting disks to Non-RAID



Take caution before you reset a RAID volume hard disk drive to non-RAID. Resetting a RAID volume hard disk drive deletes all internal RAID structure on the drive.

To reset a RAID set:

1. From the utility main menu, select **3. Reset Disks to Non-RAID** and press <Enter>.
2. Press the up/down arrow keys to select the drive(s) or disks of the RAID set you want to reset, then press <Space>. A small triangle before the Port number marks the selected drive. Press <Enter> when you are done.

```
[ RESET RAID DATA ]
Resetting RAID disk will remove its RAID structures
and revert it to a non-RAID disk.
WARNING: Resetting a disk causes all data on the disk to be lost.
(This does not apply to Recovery volumes)
Port  Drive Model  Serial #      Size      Status
---  -
0     ST3300656SS   HWAS0000991753TR  279.3GB  Member Disk
1     ST3300656SS   37VN00009846RAJ1  279.3GB  Member Disk
Select the disks that should be reset.
[↑↓]-Previous/Next [SPACE]-Selects [ENTER]-Selection Complete
```

3. Press <Y> in the confirmation window to reset the drive(s) or press <N> to return to the utility main menu.

## 6.2.4 Exiting the Intel® Rapid Storage Technology enterprise SATA Option ROM utility

To exit the utility:

1. From the utility main menu, select **4. Exit** then press <Enter>.
2. Press <Y> to exit or press <N> to return to the utility main menu.

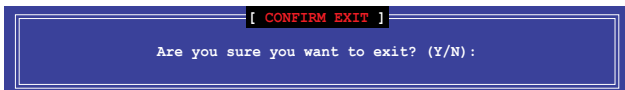

## 6.2.5 Rebuilding the RAID



This option is only for the RAID 1 set.

### Rebuilding the RAID with other non-RAID disk

If any of the SATA hard disk drives included in the RAID 1 array failed, the system displays the status of the RAID volume as **"Degraded"** during POST. You can rebuild the RAID array with other installed non-RAID disks.

To rebuild the RAID with other non-RAID disk:

1. During POST, press <Ctrl>+<l> at the prompt to enter the Intel Rapid Storage Technology option ROM utility.
2. If there is a non-RAID SATA Hard Disk available, the utility will prompt you to rebuild the RAID. Press the up/down arrow keys to select the destination disk then Press <Enter> to start the rebuilding process, or press <ESC> to exit.

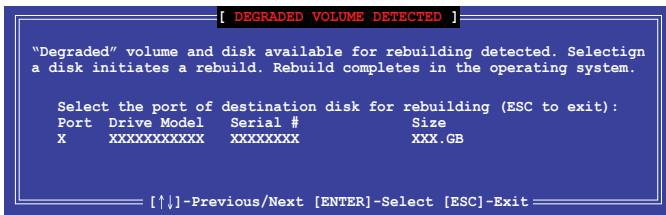

Select a destination disk with the same size as the original hard disk.

- The utility immediately starts rebuilding after the disk is selected. When done, the status of the degraded RAID volume is changed to **“Rebuild”**.

```

Intel(R) Rapid Storage Technology enterprise - SATA Option ROM - 3.6.0.1023
Copyright(C) 2003-12 Intel Corporation. All Rights Reserved.

[ MAIN MENU ]
1. Create RAID Volume
2. Delete RAID Volume
3. Reset Disks to Non-RAID
4. Exit

[ DISK/VOLUME INFORMATION ]

RAID Volumes:
ID Name Level Strip Size Status Bootable
1 Volume0 RAID1(Mirror) N/A 149.0GB Rebuild Yes

Physical Devices:
Port Drive Model Serial # Size Type/Status (Vol ID)
1 ST3160812AS 9LS0F4HL 149.0GB Member Disk(0)
2 ST3160812AS 3LS0JVL8 149.0GB Member Disk(0)

Volumes with "Rebuild" status will be rebuilt within the operating system.

[↑↓]-Select [ESC]-Exit [ENTER]-Select Menu

```

- Press <Esc> to exit Intel Rapid Storage Technology and reboot the system.
- Select **Start > Programs > Intel Rapid Storage > Intel Rapid Storage Console** or click the **Intel Rapid Storage Technology** tray icon to load the Intel Rapid Storage Manager utility.
- From the **View** menu, select **Advanced Mode** to display the details of the Intel Rapid Storage Console.
- From the **Volumes view** option, select **RAID volume** to view the rebuilding status. When finished, the status is changed to **“Normal”**.

### Rebuilding the RAID with a new hard disk

If any of the SATA hard disk drives included in the RAID array failed, the system displays the status of the RAID volume as **“Degraded”** during POST. You may replace the disk drive and rebuild the RAID array.

To rebuild the RAID with a new hard disk:

- Remove the failed SATA hard disk and install a new SATA hard disk of the same specification into the same SATA Port.



---

Select a destination disk with the same size as the original hard disk.

---

- Reboot the system then follow the steps in section **Rebuilding the RAID with other non-RAID disk**.

## 6.2.6 Setting the Boot array in the BIOS Setup Utility

You can set the boot priority sequence in the BIOS for your RAID arrays when creating multi-RAID using the Intel® Rapid Storage Technology enterprise SATA Option ROM utility.

To set the boot array in the BIOS:



---

Set at least one of the arrays bootable to boot from the hard disk.

---

1. Reboot the system and press <Del> to enter the BIOS setup utility during POST.
2. Go to the **Boot** menu and select the boot option priority.
3. Use up/down arrow keys to select the boot priority and press <Enter>. See the **Boot menu** section of Chapter 4 for more details.
4. From the **Exit** menu, select **Save Changes & Exit**, then press <Enter>.
5. When the confirmation window appears, select **Yes**, then press <Enter>.

## 6.3 Intel® Rapid Storage Technology enterprise (Windows)

The Intel® Rapid Storage Technology enterprise allows you to create RAID 0, RAID 1, RAID 10 (RAID 1+0), and RAID 5 set(s) from Serial ATA hard disk drives that are connected to the Serial ATA connectors supported by the Southbridge.



You need to manually install the Intel® Rapid Storage Technology enterprise utility on a Windows® operating system. Please refer to the installation instructions in Chapter 7.

To enter the Intel® Rapid Storage Technology enterprise utility under Windows operating system:

1. Turn on the system and go to the windows desktop.
2. Click the **Intel® Rapid Storage Technology enterprise** icon to display the main menu.

Your storage system is configured for data protection, increased performance and optimal data storage capacity. You can create additional volumes to further optimize your storage system.

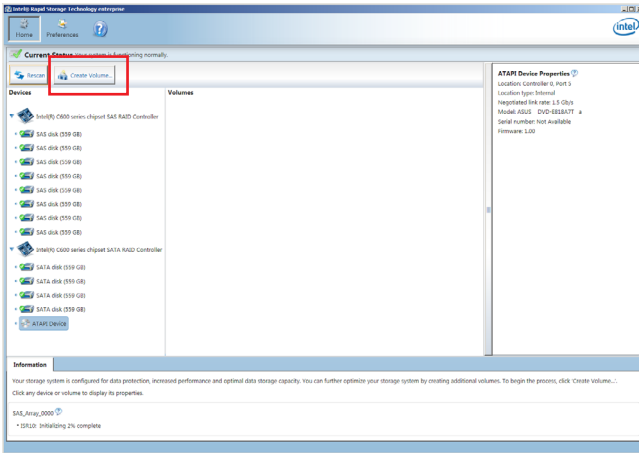

You can click **Rescan** to re-scan any attached hard disks.

## 6.3.1 Creating a RAID set

To create a RAID set:

1. From the utility main menu, select **Create Volume** and select volume type.
2. Click **Next**.

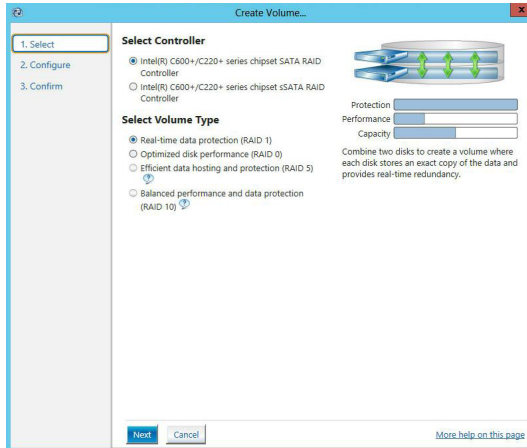

3. Enter a name for the RAID set, then select the array disks.
4. Select **Volume Size** tab, you can drag the bar to decide the volume size.
5. Click **Next**.

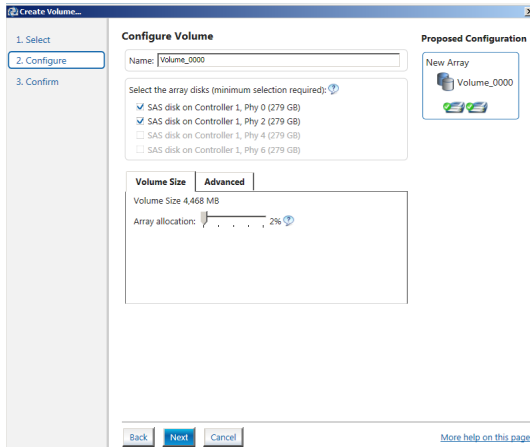

- If you do not want to keep the data on one of the selected disks, select **NO** when prompted.
- If you want to **Enable volume write-back cache** or **Initialize volume**, click **Advanced**.

6. Confirm the volume creation, then click **Create Volume** to continue.



This process could take a while depending on the number and size of the disks. You can continue using other applications during this time.

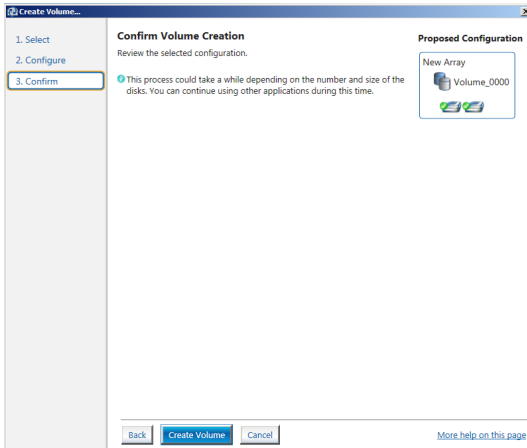

7. Wait until the process is completed, then click **OK** when prompted.

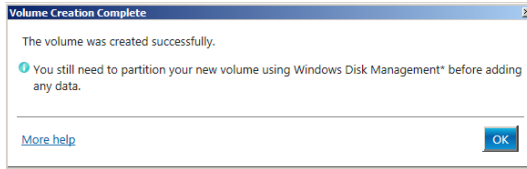

You still need to partition your new volume using Windows Disk Management before adding any data.

The RAID set is displayed in the **Volumes** list and you can change the settings in **Volume Properties**.

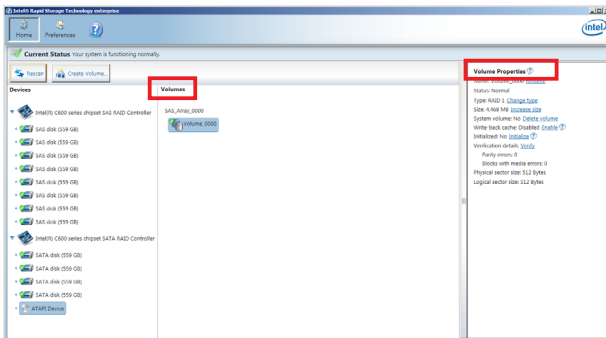

## 6.3.2 Changing a Volume Type

To change the volume type in **Volume Properties**:

1. Click the SATA array items you want to change in **Volumes** field.
2. From the **Volume Properties** field, select **Type:RAID 1 Change type**.

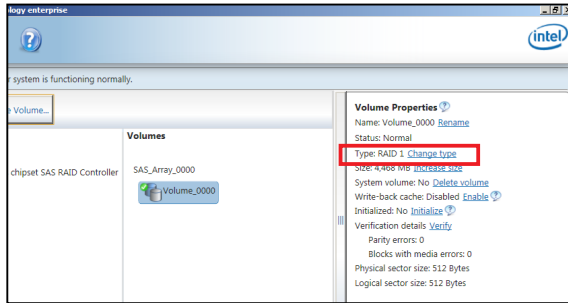

3. You can change the **Name**, **Select the new volume type**, and **Select additional disks to include in the new volume** if needed.
4. Select the **Data stripe size** for the RAID array (for RAID 0, 10 and 5 only), and click **OK**. The available stripe size values range from 4 KB to 128 KB. The following are typical values:  
RAID 0: 128KB  
RAID 10: 64KB  
RAID 5: 64KB

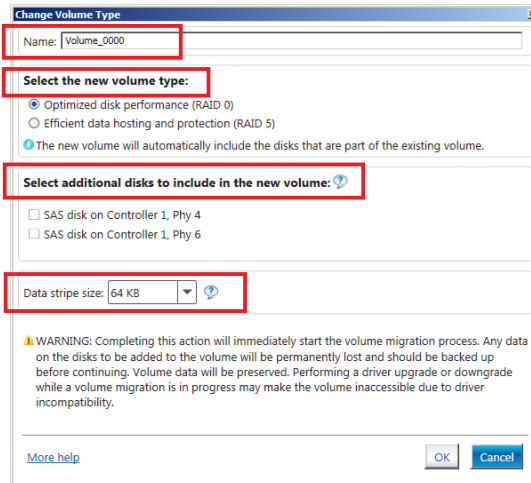

We recommend a lower stripe size for server systems, and a higher stripe size for multimedia computer systems used mainly for audio and video editing.

### 6.3.3 Deleting a volume



Be cautious when deleting a volume. You will lose all data on the hard disk drives. Before you proceed, ensure that you back up all your important data from your hard drives.

To delete a volume:

1. From the utility main menu, select the volume (exp. Volume\_0000) in **Volumes** field you want to delete.

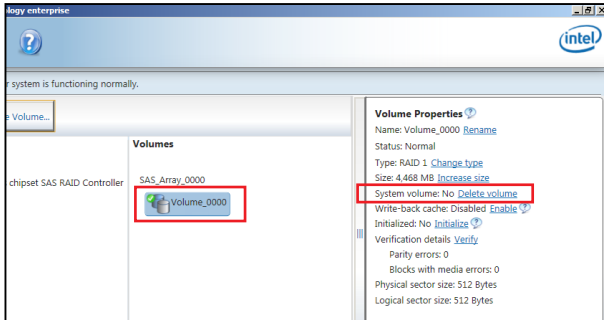

2. Select **Delete volume** in **Volume Properties** field. The following screen appears.

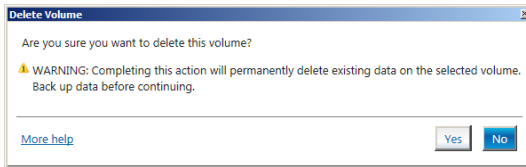

3. Click **Yes** to delete the volume and return to the utility main menu, or click **No** to return to the main menu.

## 6.3.4 Preferences

### System Preferences

Allow you to set to show the notification area icon and show system information, warning, or errors here.

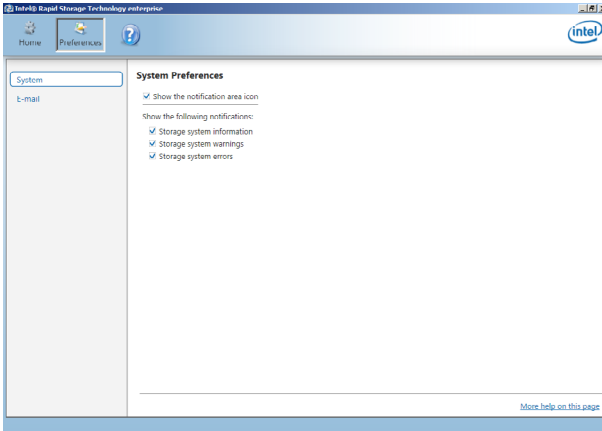

### E-Mail Preferences

Allow you to set to sent e-mail of the following events:

- Storage system information
- Storage system warnings
- Storage system errors

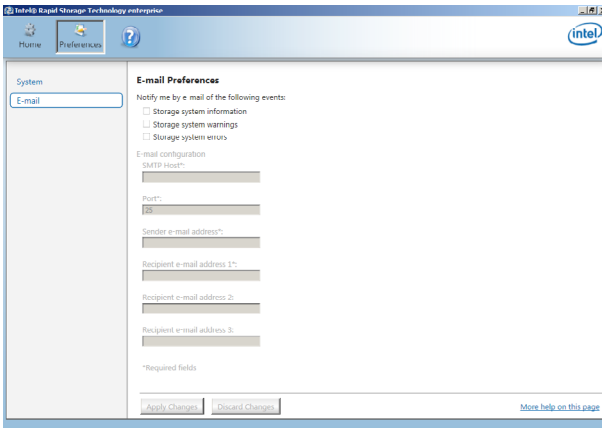



# Driver Installation

# 7

This chapter provides the instructions for installing the necessary drivers for different system components in both Linux<sup>®</sup> and Windows<sup>®</sup> Operating Systems.

## 7.1 RAID driver installation

After creating the RAID sets for your server system, you are now ready to install an operating system to the independent hard disk drive or bootable array. This part provides the instructions on how to install the RAID controller drivers during OS installation.

### 7.1.1 Creating a USB flash drive with RAID driver

When installing Windows® Server OS, you can load the RAID driver from a USB flash drive. You can create a USB flash drive with RAID driver in Windows by copying the files from the support DVD to the USB flash drive.

To copy the RAID driver to a USB flash drive in Windows environment:

1. Place the motherboard support DVD in the optical drive.
2. Connect a USB flash drive to your system.
3. Click on the optical drive to browse the contents of the support DVD.
4. Click **Drivers > C23x INTEL RAID > Driver > Windows** and then copy the **SATA\_RAID** driver folder to the USB flash drive.

### 7.1.2 Installing the RAID controller driver

#### During Windows® Server 2012 OS installation

To install the RAID controller driver when installing Windows® Server 2012 OS

1. Boot the computer using the Windows® Server 2012 OS installation disc. Follow the screen instructions to start installing Windows Server 2012.
2. When prompted to choose a type of installation, click **Custom (advanced)**.

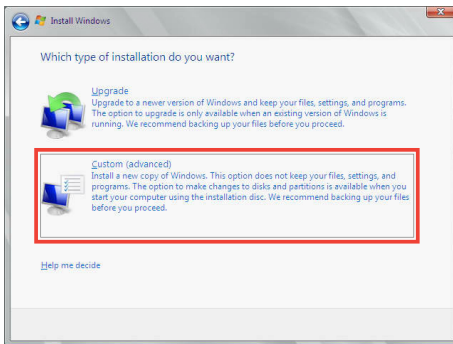

3. Click **Load Driver**.

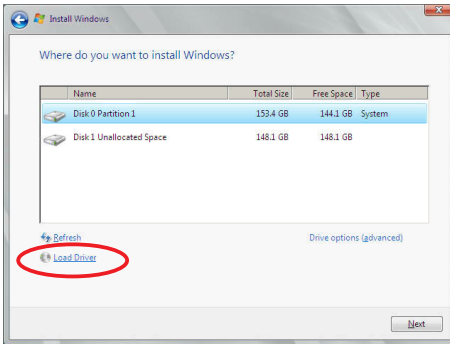

4. A message appears reminding you to insert the installation media containing the driver of the RAID controller driver (the installation media can be a CD, DVD, or USB flash drive).
- If you have only one optical drive installed in your system, eject the Windows OS installation disc and replace with the motherboard Support DVD into the optical drive.
  - Or you may connect a USB flash drive containing the RAID controller driver.

Click **Browse** to continue.



5. Locate the driver in the corresponding folder of the Support DVD or USB flash drive and then click **OK** to continue.
6. Select the RAID controller driver you need from the list and click **Next**.

7. When the system finishes loading the RAID driver,
  - Replace the motherboard Support DVD with the Windows Server installation disc.
  - Remove the USB flash drive.

Select the drive to install Windows and click Next.

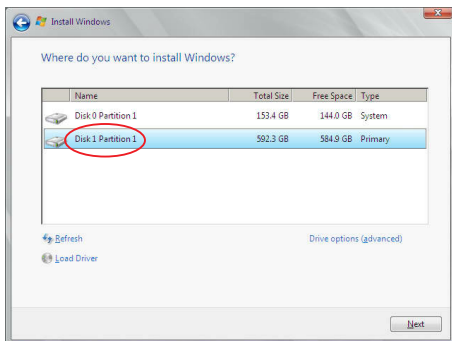

8. Follow succeeding screen instructions to continue.

## 7.2 Management applications and utilities installation

The support DVD that is bundled with your motherboard contains drivers, management applications, and utilities that you can install to maximize the features of your motherboard.



- The contents of the support DVD are subject to change at any time without notice. Visit the ASUS website ([www.asus.com](http://www.asus.com)) for the latest updates on software and utilities.
- The support DVD is supported on Windows® Server 2012.

## 7.3 Running the Support DVD

When you place the support DVD into the optical drive, the DVD automatically displays the main screen if Autorun is enabled in your computer. By default, the Drivers tab is displayed.



If Autorun is NOT enabled in your computer, browse the contents of the support DVD to locate the file **ASSETUP.EXE** from the **BIN** folder. Double-click the **ASSETUP.EXE** to run the support DVD.

The main screen of the Support DVD contains the following tabs:

1. Drivers
2. Utilities
3. Manual
4. Contact

### 7.3.1 Drivers menu tab

The Drivers Menu shows the available device drivers if the system detects installed devices. Install the necessary drivers to activate the devices.

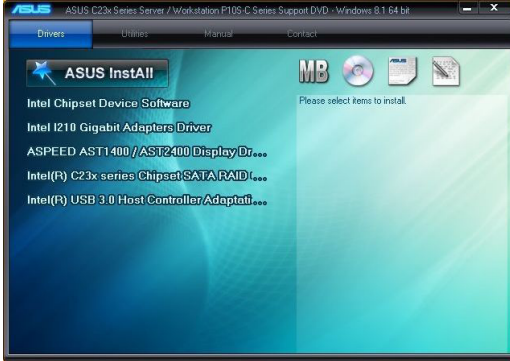

### 7.3.2 Utilities menu tab

The Utilities menu displays the software applications and utilities that the motherboard supports.



### 7.3.3 Manual menu tab



You need an internet browser installed in your OS to view the User Guide.



### 7.3.4 Contact information menu

The Contact menu displays the ASUS contact information, e-mail addresses, and useful links if you need more information or technical support for your motherboard.

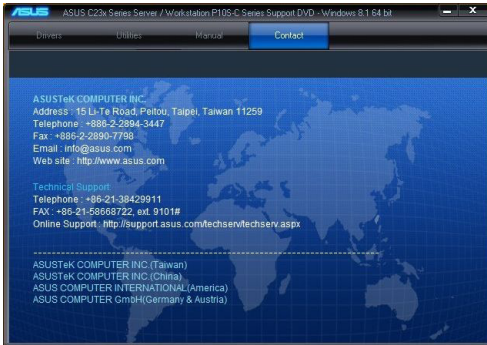

## 7.4 Installing the Intel® Chipset device Software driver

This section provides the instructions on how to install the Intel® chipset device software on the system. You need to manually install the Intel® chipset device software on a Windows® Operating System. To install the Intel® chipset device software on Windows® Server 2008 R2:

1. Restart the computer.
2. Log in with **Administrator** privileges.
3. Insert the Motherboard Support DVD to the optical drive.

The support DVD automatically displays the **Drivers** menu if Autorun is enabled in your computer.



---

If Autorun is NOT enabled in your computer, browse the contents of the support DVD to locate the file **ASSETUP.EXE** from the **BIN** folder. Double-click the **ASSETUP.EXE** to run the support DVD.

---

4. Click **Intel® Chipset Device Software** from the Drivers menu to start the installation.
5. The **Intel® Chipset Device Software** window appears. Click **Next** to start installation.

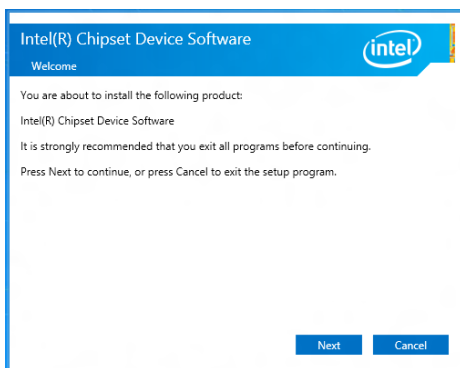

6. Select **Yes** to accept the terms of the **License Agreement** and continue the process.

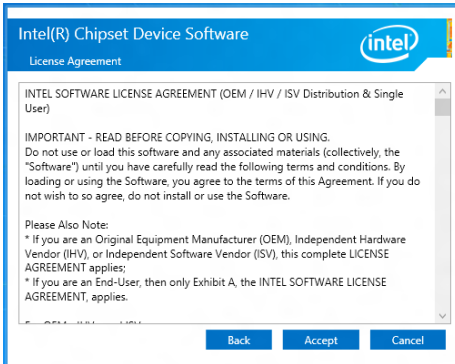

7. Read the **Readme File Information** and press **Install** to continue the installation.

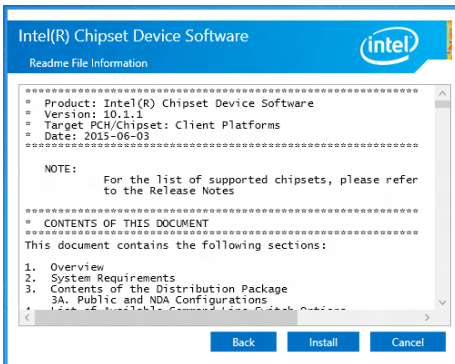

8. Press **Restart Now** to complete the setup process.

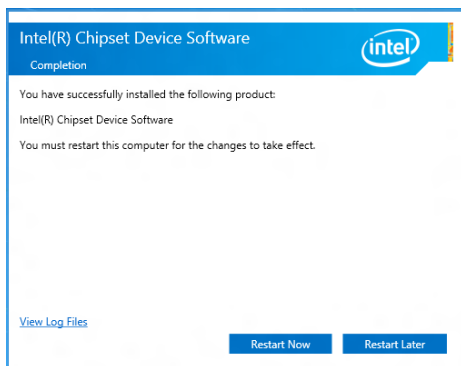

## 7.5 Installing the Intel® I210 Gigabit Adapters driver

This section provides the instructions on how to install the **Intel® I210 Gigabits Adapter Driver** on the system.

To install the **Intel® I210 Gigabit Adapters Driver** on the Windows® operating system:

1. Restart the computer.
2. Log on with **Administrator** privileges.
3. Insert the motherboard/system support DVD to the optical drive.



If Autorun is NOT enabled in your computer, browse the contents of the support DVD to locate the file **ASSETUP.EXE** from the **BIN** folder. Double-click the **ASSETUP.EXE** to run the support DVD.

4. Click **Intel® I210 Gigabit Adapters Drivers** in the **Drivers** menu of the main screen to start the installation.

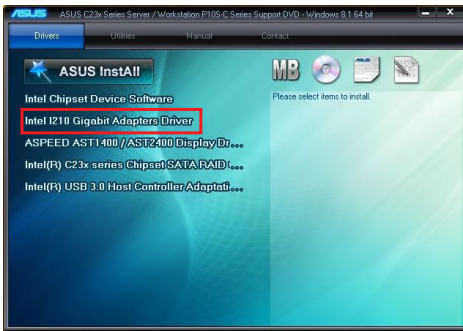

5. Click **Install Drivers and Software** option to begin installation.

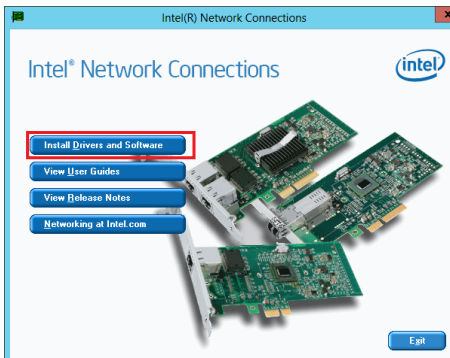

6. Click **Next** when the **Intel(R) Network Connections–InstallShield Wizard** window appears.

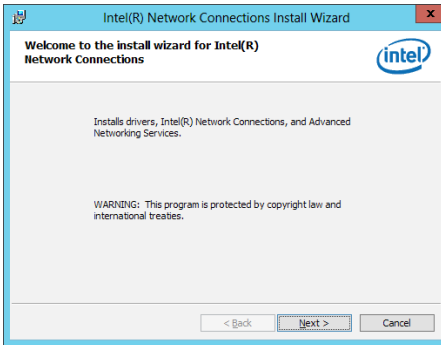

7. Tick **I accept the terms in the license agreement** and click **Next** to continue.

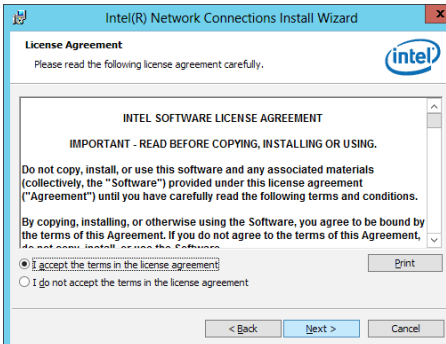

8. From the **Setup Options** window, click **Next** to start the installation.



By default, **Intel(R) PROSet for Windows Device Manager** and **Windows PowerShell Module** are ticked.

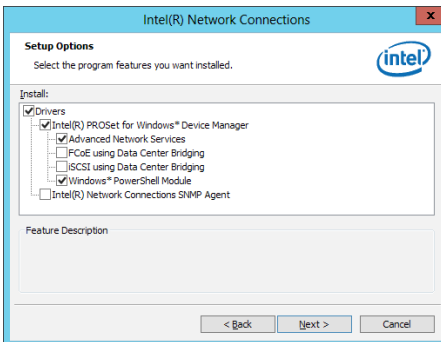

## 7.6 Installing the VGA driver

This section provides the instructions on how to install the **ASPEED Video Graphics Adapter (VGA)** driver.

To install the **ASPEED VGA** driver:

1. Restart the computer.
2. Log in with **Administrator** privileges.
3. Insert the Motherboard Support DVD to the optical drive.

The support DVD automatically displays the **Drivers** menu if Autorun is enabled in your computer.



If Autorun is NOT enabled in your computer, browse the contents of the support DVD to locate the file **ASSETUP.EXE** from the **BIN** folder. Double-click the **ASSETUP.EXE** to run the support DVD.

4. From the **Main Menu**, click **ASPEED AST1400/AST2400 Display Driver** on the **Drivers** tab to start the installation.

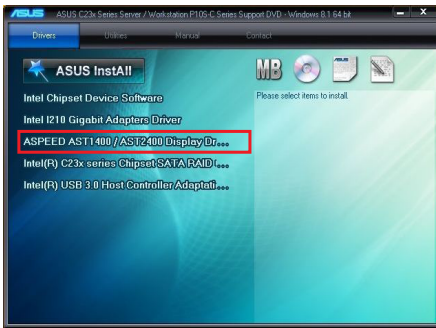

5. From the installation window, click **Next** to start the installation.

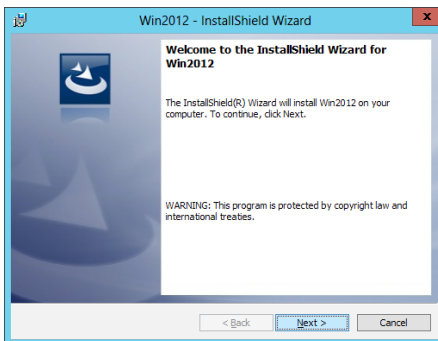

6. Click **Install** to proceed with the installation.

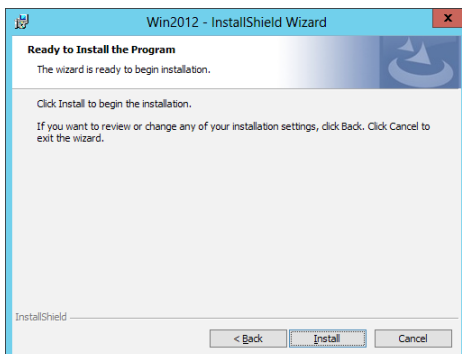

7. Click **Finish** to complete the installation.

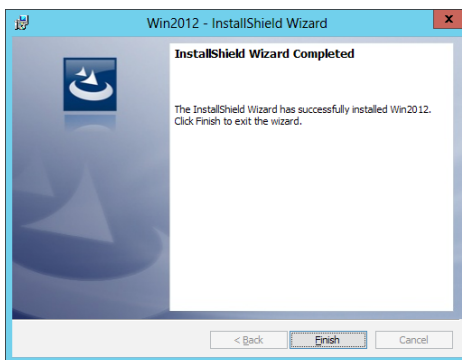

# **Appendix**

# P10S-C/4L/SYS block diagram

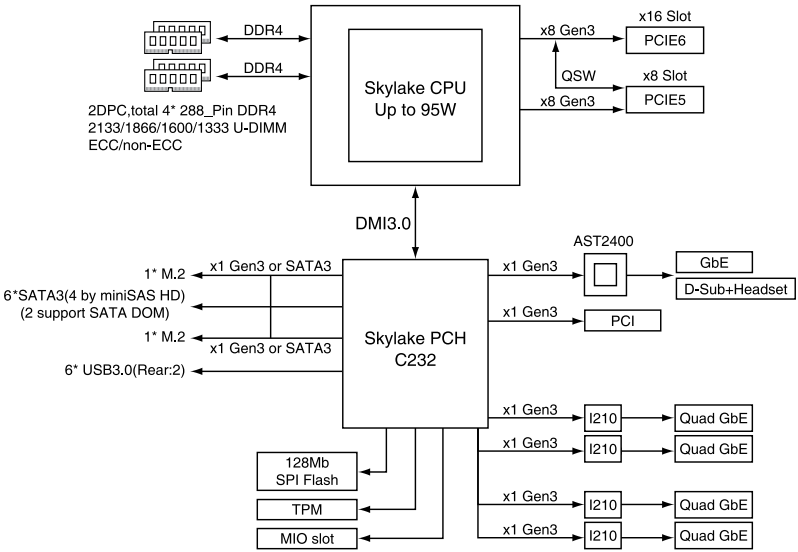

## ASUS contact information

### ASUSTeK COMPUTER INC.

Address 4F, No. 150, Li-Te Rd., Peitou, Taipei 112, Taiwan  
Telephone +886-2-2894-3447  
Fax +886-2-2890-7798  
Web site <https://www.asus.com>

#### **Technical Support**

Telephone +86-21-38429911  
Fax +86-21-58668722 ext: 9101  
Online Support <https://www.asus.com/support/Product/ContactUs/Services/questionform/?lang=en>

### ASUSTeK COMPUTER INC. (Taiwan)

Address 4F, No. 150, Li-Te Rd., Peitou, Taipei 112, Taiwan  
Telephone +886-2-2894-3447  
Fax +886-2-2890-7798  
Web site <https://www.asus.com/tw/>

#### **Technical Support**

Telephone +886-2-2894-3447 (0800-093-456)  
Online Support <https://www.asus.com/support/Product/ContactUs/Services/questionform/?lang=zh-tw>

### ASUSTeK COMPUTER INC. (China)

Address No. 5077, Jindu Road, Minhang District, Shanghai, China  
Telephone +86-21-5442-1616  
Fax +86-21-5442-0099  
Web site <https://www.asus.com.cn>

#### **Technical Support**

Telephone +86-20-2804-7506 (400-620-6655)  
Online Support <https://www.asus.com/support/Product/ContactUs/Services/questionform/?lang=zh-cn>

## ASUS contact information

### ASUS COMPUTER INTERNATIONAL (America)

Address 800 Corporate Way, Fremont, CA 94539, USA  
Fax +1-510-608-4555  
Web site <https://www.asus.com/us/>

#### **Technical Support**

Support fax +1-812-284-0883  
General support +1-812-282-2787  
Online support <https://www.asus.com/support/Product/ContactUs/Services/questionform/?lang=en-us>

### ASUS COMPUTER GmbH (Germany and Austria)

Address Harkort Str. 21-23, 40880 Ratingen, Germany  
Fax +49-2102-959911  
Web site <https://www.asus.com/de/>

#### **Technical Support**

Telephone +49-1805-010923  
Support Fax +49-2102-959911  
Online support <https://www.asus.com/support/Product/ContactUs/Services/questionform/?lang=de-de>

### ASUS Czech Service s.r.o. (Europe)

Address Na Rovince 887, 720 00 Ostrava – Hrabová,  
Czech Republic  
Telephone +420-596766888  
Web site <https://www.asus.com/cz/>

#### **Technical Support**

Telephone +420-596-766-891  
Fax +420-596-766-329  
E-mail [advance.rma.eu@asus.com](mailto:advance.rma.eu@asus.com)  
Online Support <https://www.asus.com/support/Product/ContactUs/Services/questionform/?lang=cs-cz>

## ASUS contact information

### ASUS Holland BV (The Netherlands)

Address Marconistraat 2, 7825GD EMMEN, The Netherlands  
Web site <https://www.asus.com/nl/>

#### **Technical Support**

Telephone +31-(0)591-5-70292  
Fax +31-(0)591-666853  
E-mail [advance.rma.eu@asus.com](mailto:advance.rma.eu@asus.com)  
Online Support <https://www.asus.com/support/Product/ContactUs/Services/questionform/?lang=nl-nl>

### ASUS Polska Sp. z o.o. (Poland)

Address Ul. Postępu 6, 02-676 Warszawa, Poland  
Web site <https://www.asus.com/pl/>

#### **Technical Support**

Telephone +48-225718033  
Online Support <https://www.asus.com/support/Product/ContactUs/Services/questionform/?lang=pl-pl>

### ASK-Service (Russia and CIS)

Address г.Москва, ул. Орджоникидзе, д.10, Россия  
Telephone (495) 640-32-75  
Web site <https://www.asus.com/ru/>

#### **Technical Support**

Telephone 008-800-100-ASUS (008-800-100-2787)  
Online Support <https://www.asus.com/support/Product/ContactUs/Services/questionform/?lang=ru-ru>

