



Maintenance and Service Guide

HP Stream 11 Laptop PC

IMPORTANT! This document is intended for HP authorized service providers only.

© Copyright 2018, 2019 HP Development Company, L.P.

Bluetooth is a trademark owned by its proprietor and used by HP Inc. under license. Intel, Atom, Celeron, and Pentium are trademarks of Intel Corporation in the U.S. and other countries. SDHC, SDXC, and microSD are trademarks or registered trademarks of SD-3C LLC. Windows is either a registered trademark or trademark of Microsoft Corporation in the United States and/or other countries.

The information contained herein is subject to change without notice. The only warranties for HP products and services are set forth in the express warranty statements accompanying such products and services. Nothing herein should be construed as constituting an additional warranty. HP shall not be liable for technical or editorial errors or omissions contained herein.

Second Edition: May 2019

First Edition: December 2018

Document Part Number: L41717-002

Product notice

This guide describes features that are common to most models. Some features may not be available on your computer.

Not all features are available in all editions or versions of Windows. Systems may require upgraded and/or separately purchased hardware, drivers, software or BIOS update to take full advantage of Windows functionality. Windows 10 is automatically updated, which is always enabled. ISP fees may apply and additional requirements may apply over time for updates. Go to <http://www.microsoft.com> for details.

To access the latest user guides, go to <http://www.hp.com/support>, and follow the instructions to find your product. Then select **User Guides**.

Software terms

By installing, copying, downloading, or otherwise using any software product preinstalled on this computer, you agree to be bound by the terms of the HP End User License Agreement (EULA). If you do not accept these license terms, your sole remedy is to return the entire unused product (hardware and software) within 14 days for a full refund subject to the refund policy of your seller.

For any further information or to request a full refund of the price of the computer, please contact your seller.

Safety warning notice

 **WARNING!** To reduce the possibility of heat-related injuries or of overheating the device, do not place the device directly on your lap or obstruct the device air vents. Use the device only on a hard, flat surface. Do not allow another hard surface, such as an adjoining optional printer, or a soft surface, such as pillows or rugs or clothing, to block airflow. Also, do not allow the AC adapter to contact the skin or a soft surface, such as pillows or rugs or clothing, during operation. The device and the AC adapter comply with the user-accessible surface temperature limits defined by applicable safety standards.

Table of contents

1 Product description	1
2 Getting to know your computer	4
Right side	4
Left side	5
Display	6
Keyboard area	7
Touchpad	7
Lights	8
Button and speakers	9
Special keys	10
Labels	11
3 Illustrated parts catalog	12
Computer major components	12
Display assembly subcomponents	15
Miscellaneous parts	16
4 Removal and replacement procedures preliminary requirements	17
Tools required	17
Service considerations	17
Plastic parts	17
Cables and connectors	17
Drive handling	18
Workstation guidelines	18
Electrostatic discharge information	18
Generating static electricity	19
Preventing electrostatic damage to equipment	19
Personal grounding methods and equipment	20
Grounding the work area	20
Recommended materials and equipment	20
Packaging and transporting guidelines	21
5 Removal and replacement procedures for authorized service provider parts	22
Component replacement procedures	22
Preparation for disassembly	22

Keyboard/top cover	22
Touchpad board	26
Power button board	28
Keyboard hook	29
Battery	30
WLAN module	31
Speakers	33
USB/audio board	34
Heat sink/thermal plate	35
Display assembly	37
System board	45
Power connector	47

6 Using Setup Utility (BIOS) 48

Starting Setup Utility (BIOS)	48
Updating Setup Utility (BIOS)	48
Determining the BIOS version	48
Downloading a BIOS update	49

7 Using HP PC Hardware Diagnostics 50

Using HP PC Hardware Diagnostics Windows (select products only)	50
Downloading HP PC Hardware Diagnostics Windows	50
Downloading the latest HP PC Hardware Diagnostics Windows version	51
Downloading HP Hardware Diagnostics Windows by product name or number (select products only)	51
Installing HP PC Hardware Diagnostics Windows	51
Using HP PC Hardware Diagnostics UEFI	51
Starting HP PC Hardware Diagnostics UEFI	52
Downloading HP PC Hardware Diagnostics UEFI to a USB flash drive	52
Downloading the latest HP PC Hardware Diagnostics UEFI version	52
Downloading HP PC Hardware Diagnostics UEFI by product name or number (select products only)	52
Using Remote HP PC Hardware Diagnostics UEFI settings (select products only)	53
Downloading Remote HP PC Hardware Diagnostics UEFI	53
Downloading the latest Remote HP PC Hardware Diagnostics UEFI version	53
Downloading Remote HP PC Hardware Diagnostics UEFI by product name or number	53
Customizing Remote HP PC Hardware Diagnostics UEFI settings	53

8 Backing up, restoring, and recovering 55

Backing up information and creating recovery media	55
--	----

Using Windows tools	55
Using the HP Cloud Recovery Download Tool to create recovery media (select products only)	55
Restoring and recovery	56
Restoring, resetting, and refreshing using Windows tools	56
Recovering using HP Recovery media	56
Changing the computer boot order	56
9 Specifications	57
10 Power cord set requirements	58
Requirements for all countries	58
Requirements for specific countries and regions	59
11 Recycling	61
Index	62

1 Product description

Table 1-1 Product components and their descriptions

Category	Description
Product Name	HP Stream 11 Laptop PC Model numbers: 11-ak0xxx, 11-ak1xxx
Processor	Intel® Pentium® Silver N5000 1.10 GHz (turbo up to 2.70 GHz) quad core processor, 2400 MHz FSB, 4 MB L2 cache, 6 W Intel Celeron® N4000 1.10 GHz (turbo up to 2.60 GHz) dual core processor, 2400 MHz FSB, 4 MB L2 cache, 6 W Intel Atom® x5-E8000 1.04 GHz (turbo up to 2.00 GHz) quad core processor, 1600 MHz FSB, 2 MB L2 cache, 5 W
Graphics	Internal graphics Intel UHD Graphics 605 (N5000 processor) Intel UHD Graphics 600 (N4000 processor) Intel HD Graphics 400 (x5-E8000 processor) Supports HD decode, DX12, and HDMI
Panel	11.6 in, high-definition (HD), antiglare (1366 × 768), SVA 45, white light-emitting diode (WLED), eDP, slim (3.0 mm), 16:9 aspect ratio; typical brightness: 220 nits
Memory	On-board system memory, customer non-accessible/non-upgradeable DDR4-2400 single channel support (N5000/N4000 processors) DDR3L-1600 single channel support (x5-E8000 processor with 2048 MB system memory) DDR3L-1600 dual channel support (x5-E8000 processor with 4096 MB system memory) Supports up to 4096 MB maximum on-board system memory in the following configurations: <ul style="list-style-type: none">• 4096 MB• 2048 MB
Storage	On-board embedded MultiMedia Controller (eMMC v4.51) configurations (MLC/TLC) <ul style="list-style-type: none">• 64 GB• 32 GB
Audio and video	HP Webcam - VGA camera, USB 2.0, f2.4, fixed (no tilt) integrated activity light, 640 × 480 by 30 frames per second, non-touch Single digital microphone Dual speakers HP Audio Control
Wireless	Integrated wireless local area network (WLAN) options with dual antennas (M2/PCIe), supports the following WLAN module:

Table 1-1 Product components and their descriptions (continued)

Category	Description
	<ul style="list-style-type: none"> • Realtek RTL8822BE 802.11ac 2 × 2 Wi-Fi + Bluetooth® 5.0 (MU-MIMO supported) (models with Atom processor) • Realtek RTL8822BE 802.11ac 2 × 2 Wi-Fi + Bluetooth® 4.2 (MU-MIMO supported) (models with Pentium or Celeron processors)
	Integrated wireless local area network (WLAN) options with single antenna (M2/PCIe), supports the following WLAN module:
	<ul style="list-style-type: none"> • Realtek RTL8821CE 802.11ac 1 × 1 Wi-Fi + Bluetooth 4.2 (MU-MIMO supported) (all models)
	Compatible with Wi-Fi CERTIFIED Miracast™
	Turbo Lite WLAN SVTP
Ports	HP Smart Plug AC adapter (4.5 mm barrel)
	Audio-out (headphone)/Audio-in (microphone) combo jack
	High-definition multimedia interface (HDMI) v.1.4, supporting up to 1920 × 1080 at 60 Hz*
	*Hot plug/unplug and auto detect for correct output to wide-aspect vs. standard aspect video (auto adjust panel resolution to fit embedded panel and external monitor connected)
	USB 3.1 Gen 1 Type A ports (2)
	USB 3.1 Gen 1 Type-C port (supports data transfer)
Media card reader	Supports microSD™/SDHC™/SDXC™
Internal card expansion	One M.2 slot for WLAN
Keyboard/pointing devices	Keyboard
	Full-sized, textured, island-style, keyboard (jet black and snow white)
	Touchpad requirements
	ClickPad with image sensor
	Multitouch gestures enabled
	Support for modern trackpad gestures
	Taps enabled as default
Power requirements	Battery
	Supports a 2-cell, 37.69 Whr, polymer battery
	AC adapter
	45 W HP Smart AC adapter (non-PFC, standard barrel [4.5 mm], right angle)
	Power cord
	1 m conventional power cord (C5)
Security	Trusted platform module (TPM) 2.0
	Nano security lock
Operating system	Preinstalled
	Windows® 10 Home in S Mode Value

Table 1-1 Product components and their descriptions (continued)

Category	Description
	Windows 10 Home in S Mode Entry
	Windows 10 Home in S Mode Entry ML
	Windows 10 Home Entry NB EM/SL
Serviceability	End-user replaceable part
	AC adapter

2 Getting to know your computer

Your computer features top-rated components. This chapter provides details about your components, where they are located, and how they work.

Right side

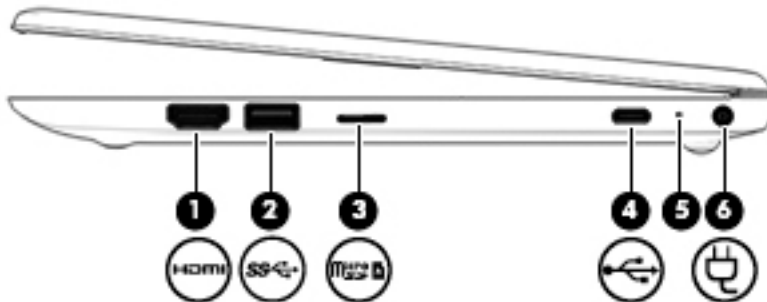







Table 2-1 Right-side components and their descriptions

Component	Description
(1)  HDMI port	Connects an optional video or audio device, such as a high-definition television, any compatible digital or audio component, or a high-speed High-Definition Multimedia Interface (HDMI) device.
(2)  USB SuperSpeed port	Connects a USB device, such as a cell phone, camera, activity tracker, or smartwatch, and provides high-speed data transfer.
(3)  microSD memory card reader	Reads optional memory cards that enable you to store, manage, share, or access information. To insert a card: <ol style="list-style-type: none">1. Hold the card label-side up, with connectors facing the computer.2. Insert the card into the memory card reader, and then press in on the card until it is firmly seated. To remove a card: <ul style="list-style-type: none">▲ Press in on the card, and then remove it from the memory card reader.
(4)  USB Type-C port	Connects a USB device, such as a cell phone, camera, activity tracker, or smartwatch, and provides data transfer. NOTE: Cables and/or adapters (purchased separately) may be required.
(5) AC adapter and battery light	<ul style="list-style-type: none">• White: The AC adapter is connected and the battery is fully charged.• Blinking white: The AC adapter is disconnected and the battery has reached a low battery level.• Amber: The AC adapter is connected and the battery is charging.• Off: The battery is not charging.
(6)  Power connector	Connects an AC adapter.

Left side

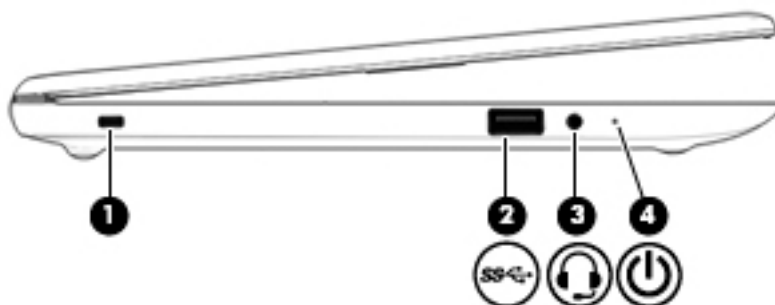





Table 2-2 Left-side components and their descriptions

Component	Description
(1)	<p>Security cable slot</p> <p>Attaches an optional security cable to the computer.</p> <p>NOTE: The security cable is designed to act as a deterrent, but it may not prevent the computer from being mishandled or stolen.</p>
(2)	<p>  USB SuperSpeed port </p> <p>Connects a USB device, such as a cell phone, camera, activity tracker, or smartwatch, and provides high-speed data transfer.</p>
(3)	<p>  Audio-out (headphone)/Audio-in (microphone) combo jack </p> <p>Connects optional powered stereo speakers, headphones, earbuds, a headset, or a television audio cable. Also connects an optional headset microphone. This jack does not support optional standalone microphones.</p> <p>WARNING! To reduce the risk of personal injury, adjust the volume before putting on headphones, earbuds, or a headset. For additional safety information, see the <i>Regulatory, Safety, and Environmental Notices</i>.</p> <p>To access this guide:</p> <ul style="list-style-type: none"> ▲ Select the Start button, select HP Help and Support, and then select HP Documentation. <p>NOTE: When a device is connected to the jack, the computer speakers are disabled.</p>
(4)	<p>  Power light </p> <ul style="list-style-type: none"> ● On: The computer is on. ● Blinking: The computer is in the Sleep state, a power-saving state. The computer shuts off power to the display and other unneeded components. ● Off: The computer is off or in Hibernation. Hibernation is a power-saving state that uses the least amount of power.

Display

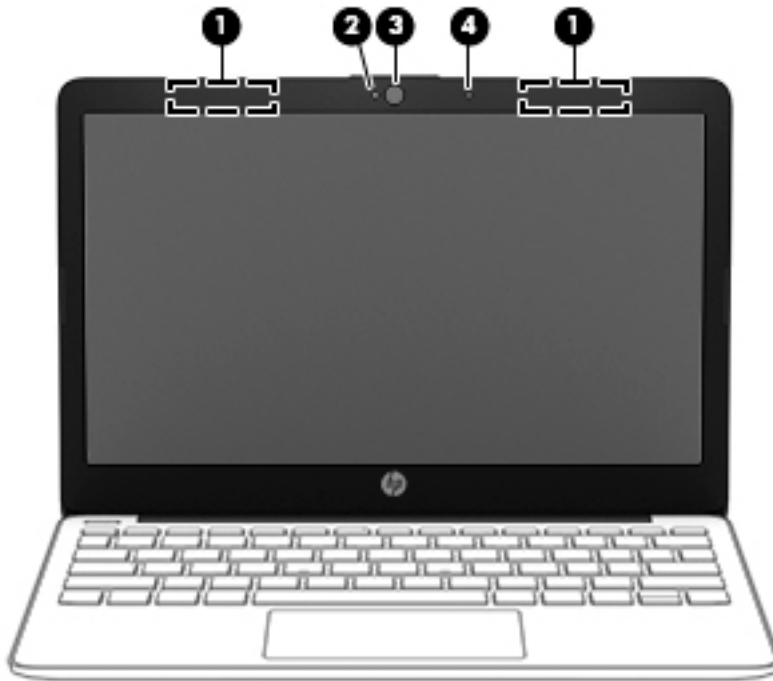

Table 2-3 Display components and their descriptions

Component	Description
(1) WLAN antennas* (select products only)	Send and receive wireless signals to communicate with wireless local area networks (WLANs).
(2) Camera light	On: The camera is in use.
(3) Camera	Allows you to video chat, record video, and record still images. Some cameras also allow a facial recognition logon to Windows, instead of a password logon. NOTE: Camera functions vary depending on the camera hardware and software installed on your product.
(4) Internal microphone	Records sound.

*The antennas are not visible from the outside of the computer. For optimal transmission, keep the areas immediately around the antennas free from obstructions.

For wireless regulatory notices, see the section of the *Regulatory, Safety, and Environmental Notices* that applies to your country or region.

To access this guide:

- ▲ Select the **Start** button, select **HP Help and Support**, and then select **HP Documentation**.

Keyboard area

Touchpad

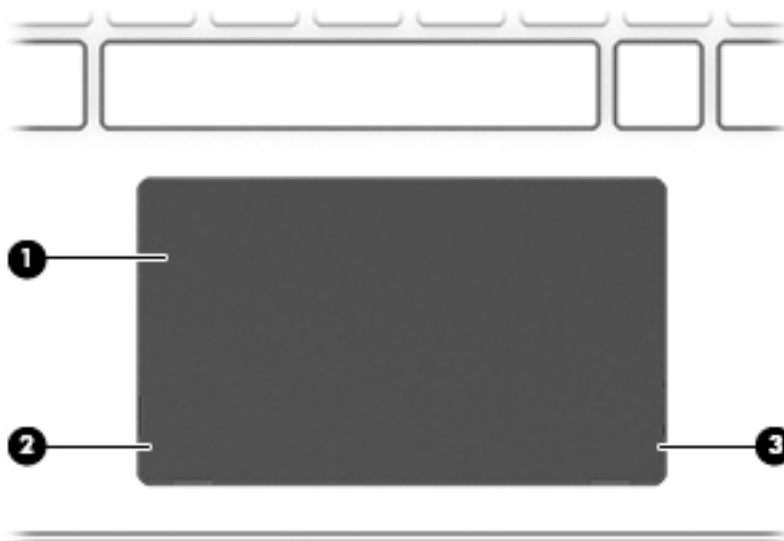

Table 2-4 Touchpad components and their descriptions

Component	Description
(1) Touchpad zone	Reads your finger gestures to move the pointer or activate items on the screen.
(2) Left control zone	Textured area that allows you to perform additional gestures.
(3) Right control zone	Textured area that allows you to perform additional gestures.

Lights

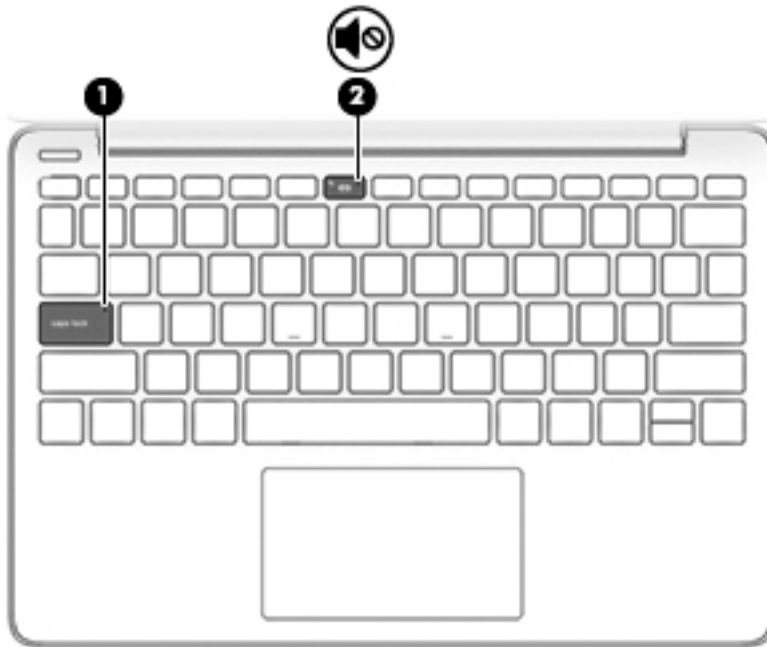



Table 2-5 Lights and their descriptions

Component		Description
(1)	Caps lock light	On: Caps lock is on, which switches the key input to all capital letters.
(2)	 Mute light	<ul style="list-style-type: none">• On: Computer sound is off.• Off: Computer sound is on.

Button and speakers

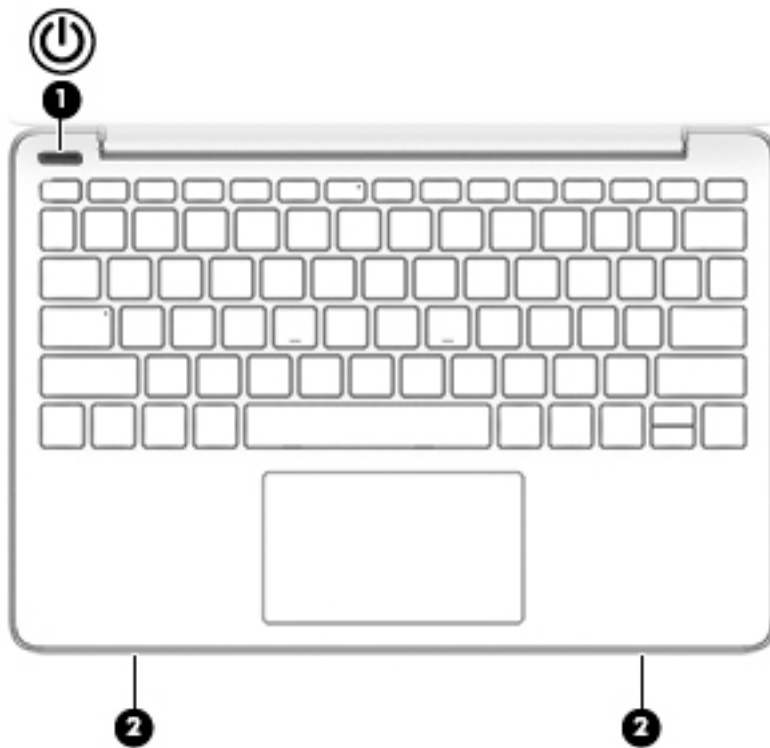



Table 2-6 Buttons and speakers and their descriptions

Component	Description
(1)  Power button	<ul style="list-style-type: none"> • When the computer is off, press the button to turn on the computer. • When the computer is on, press the button briefly to initiate Sleep. • When the computer is in the Sleep state, press the button briefly to exit Sleep (select products only). • When the computer is in Hibernation, press the button briefly to exit Hibernation. <p>IMPORTANT: Pressing and holding down the power button results in the loss of unsaved information.</p> <p>If the computer has stopped responding and shutdown procedures are ineffective, press and hold the power button down for at least 5 seconds to turn off the computer.</p> <p>To learn more about your power settings, see your power options:</p> <ul style="list-style-type: none"> ▲ Right-click the Power icon , and then select Power Options.
(2) Speakers (2)	Produce sound.

Special keys

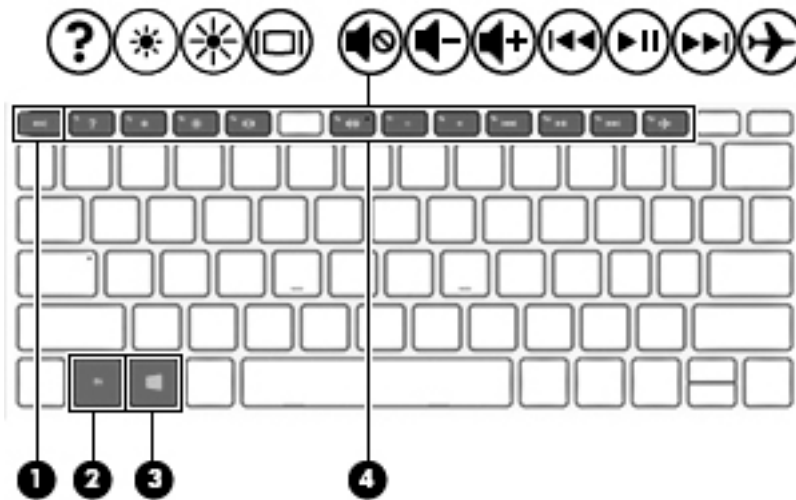



Table 2-7 Special keys and their descriptions

Component	Description
(1) <code>esc</code> key	Displays system information when pressed in combination with the <code>fn</code> key.
(2) <code>fn</code> key	Executes specific functions when pressed in combination with another key.
(3)  Windows key	Opens the Start menu. NOTE: Pressing the Windows key again will close the Start menu.
(4) Action keys	Execute frequently used system functions. NOTE: On select products, the <code>f5</code> action key turns the keyboard backlight feature off or on.

Labels

The labels affixed to the computer provide information you may need when you troubleshoot system problems or travel internationally with the computer. Labels may be in paper form or imprinted on the product.

IMPORTANT: Check the following locations for the labels described in this section: the bottom of the computer, inside the battery bay, under the service door, on the back of the display, or on the bottom of a tablet kickstand.

- Service label—Provides important information to identify your computer. When contacting support, you may be asked for the serial number, the product number, or the model number. Locate this information before you contact support.

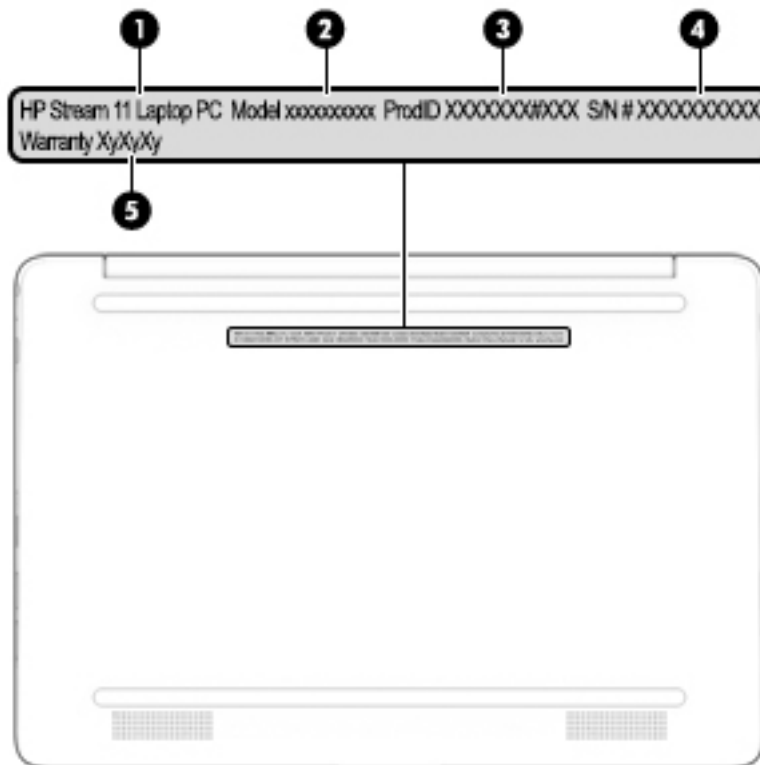

Table 2-8 Service label components

Component
(1) HP product name
(2) Model number
(3) Product ID
(4) Serial number
(5) Warranty period

- Regulatory label(s)—Provide(s) regulatory information about the computer.
- Wireless certification label(s)—Provide(s) information about optional wireless devices and the approval markings for the countries or regions in which the devices have been approved for use.

3 Illustrated parts catalog

NOTE: HP continually improves and changes product parts. For complete and current information on supported parts for your computer, go to <http://partsurfer.hp.com>, select your country or region, and then follow the on-screen instructions.

NOTE: Details about your computer, including model, serial number, product key, and length of warranty, are on the service tag at the bottom of your computer. See [Labels on page 11](#) for details.

Computer major components

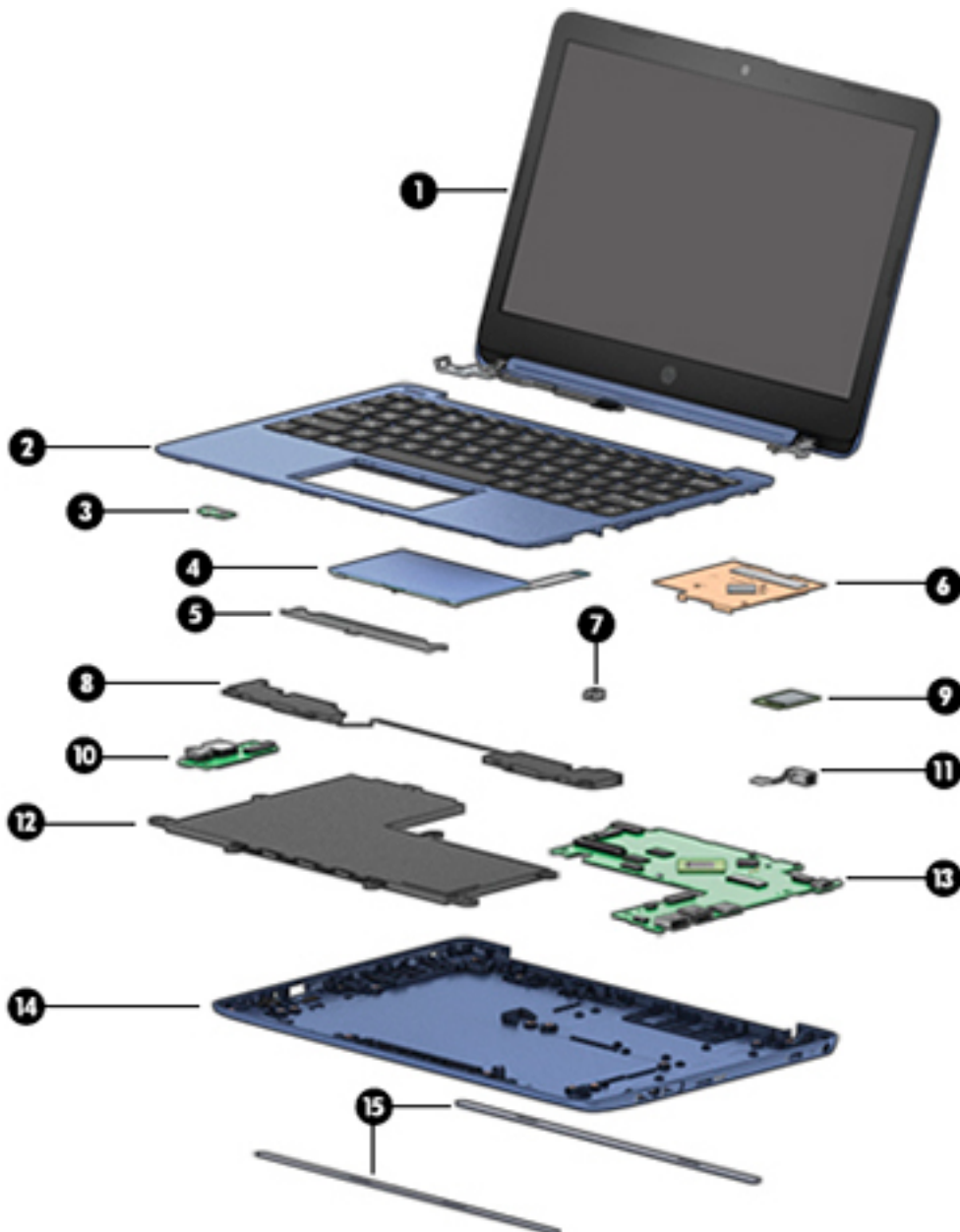

Table 3-1 Computer major components and their descriptions

Item	Component	Spare part number
(1)	Display assembly: The display assembly is spared at the subcomponent level only. For more display assembly spare part information, see Display assembly subcomponents on page 15 .	
(2)	Keyboard/top cover (includes keyboard cable) For a detailed list of country codes, see Keyboard/top cover on page 22 .	
	Royal blue	L44441-xx1
	Diamond white	L44642-xx1
	Rose pink	L45168-xx1
(3)	Power button board NOTE: The power button board spare part kit does not include the power button board cable. The power button board cable is available as spare part number L44445-001.	
	For use in models with a Pentium or Celeron processor	L44444-001
	For use in models with an Atom processor	L62793-001
(4)	Touchpad board (includes bracket) NOTE: The touchpad board spare part kit does not include the touchpad board cable. The touchpad board cable is available as spare part number L44450-001.	
	Royal blue	L44447-001
	Diamond white	L44448-001
	Rose pink	L44449-001
(5)	Touchpad bracket	included with touchpad board
(6)	Heat sink/thermal plate (includes replacement thermal material)	
	For use in models with a Pentium or Celeron processor	L44446-001
	For use in models with an Atom processor	L61326-001
(7)	Keyboard hook	L48424-001
(8)	Speakers (include left and right speakers and cable)	L44458-001
(9)	WLAN module	
	Realtek RTL8822BE 802.11ac 2 × 2 Wi-Fi + Bluetooth 4.2	924813-855
	Realtek RTL8821CE 802.11ac 1 × 1 Wi-Fi + Bluetooth 4.2	L17365-005
	Realtek RTL8822CE 802.11ac 2 × 2 Wi-Fi + Bluetooth 5.0 (MU-MIMO supported)	L44796-005
(10)	USB/audio board (includes audio jack and USB port) NOTE: The connector board spare part kit does not include the connector board cable. The connector board cable is available as spare part number L44443-001.	
	For use in models with a Pentium or Celeron processor	L44442-001
	For use in models with an Atom processor	L62794-001
(11)	Power connector cable	L44451-001
(12)	Battery (2-cell, 37 Whr, 4.96 Ahr, Li-ion; includes cable)	824536-850

Table 3-1 Computer major components and their descriptions (continued)

Item	Component	Spare part number
(13)	System board (includes processor)	
	NOTE: All system board spare part kits include replacement thermal material.	
	System boards listed with a -xx1 part number suffix use the following part numbers:	
	xxxxxx-001: Non-Windows operating systems	
	xxxxxx-601: Windows operating system	
	Pentium N5000 processor, 4 GB of system memory, and 32 GB of eMMC memory	L44438-xx1
	Celeron N4000 processor, 4 GB of system memory, and 64 GB of eMMC memory	L44437-xx1
	Celeron N4000 processor, 4 GB of system memory, and 32 GB of eMMC memory	L44436-xx1
	Celeron N4000 processor, 2 GB of system memory, and 32 GB of eMMC memory	L44435-xx1
	Atom x5-E8000 processor, 4 GB of system memory, and 64 GB of eMMC memory	L59930-601
	Atom x5-E8000 processor, 4 GB of system memory, and 32 GB of eMMC memory	L59929-601
	Atom x5-E8000 processor, 2 GB of system memory, and 32 GB of eMMC memory	L59928-601
(14)	Base enclosure	
	Royal blue	L44452-001
	Diamond white	L44453-001
	Rose pink	L44454-001
(15)	Rubber Feet Kit	
	Royal blue	L44455-001
	Diamond white	L44456-001
	Rose pink	L44457-001

Display assembly subcomponents

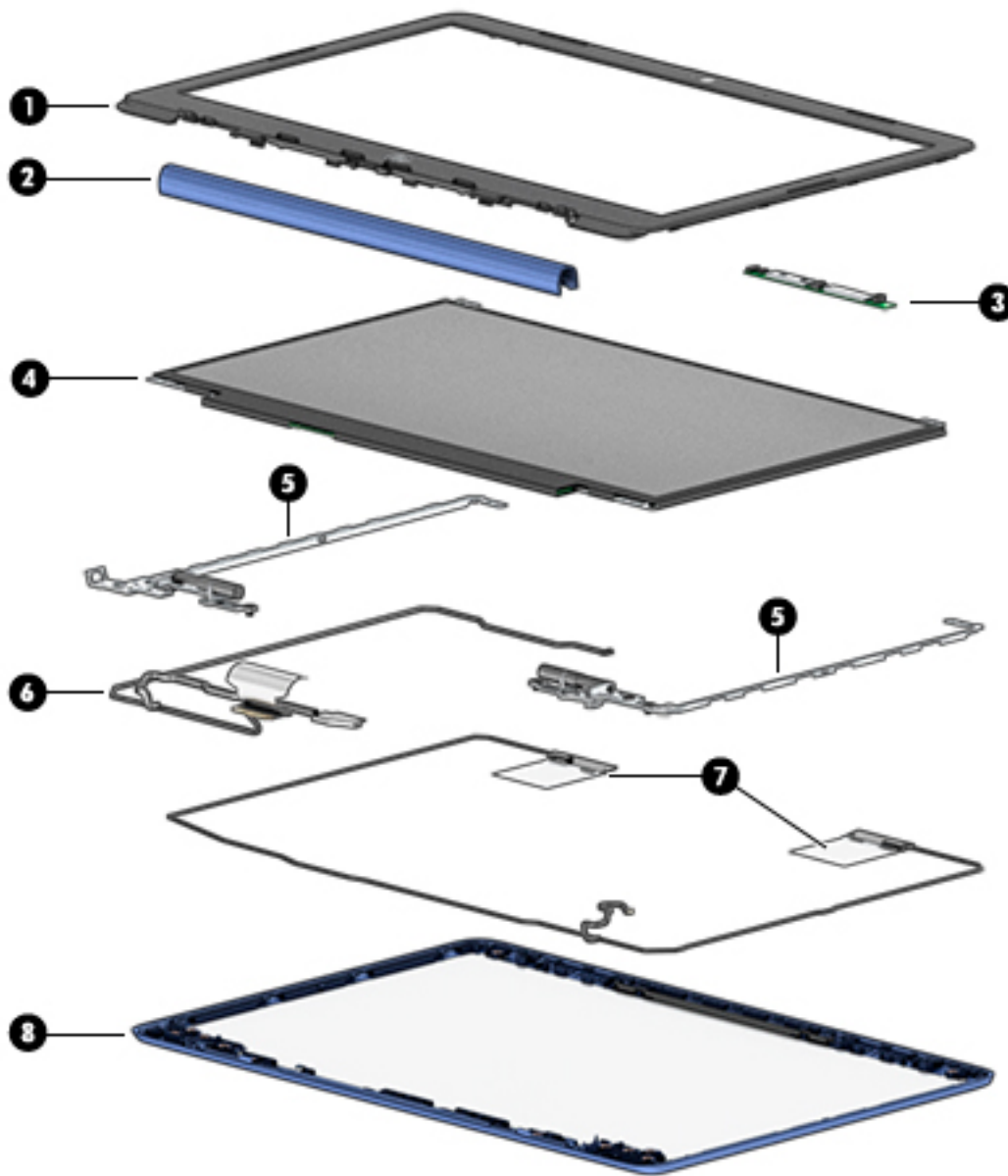

Table 3-2 Display components and their descriptions

Item	Component	Spare part number
(1)	Display bezel	L44464-001
(2)	Hinge cover	
	Royal blue	L44468-001
	Diamond white	L44469-001
	Rose pink	L44470-001
(3)	Camera/microphone module (includes double-sided adhesive)	L44439-001
(4)	Raw display panel	L44440-001

Table 3-2 Display components and their descriptions (continued)

Item	Component	Spare part number
(5)	Display Hinge Kit (includes left and right display hinges)	L44467-001
(6)	Display panel cable (includes camera/microphone module cable)	L44466-001
(7)	WLAN antenna	
	Single	L44462-001
	Dual	L44463-001
(8)	Display enclosure (includes rubber padding and shielding)	
	Royal blue	L44459-001
	Diamond white	L44460-001
	Rose pink	L44461-001

Miscellaneous parts

Table 3-3 Miscellaneous parts and their descriptions

Component	Spare part number
AC adapter (45 W HP Smart adapter)	741727-001
Power cord , (C5, 1.00 m)	
For use in Denmark	L19360-001
For use in Europe	L19361-001
For use in North America	L19367-001
For use in the United Kingdom	L19373-001
HP USB External DVD-RW Drive	747080-001
HP HDMI-to-VGA adapter	701943-001
HP USB-to-Gigabit RJ-45 adapter	829941-001
HP USB-C-to-RJ-45 adapter	855560-001
Screw Kit	L44471-001

4 Removal and replacement procedures preliminary requirements

Tools required

You will need the following tools to complete the removal and replacement procedures:

- Non-conductive, non-marking tool
- Magnetic Phillips P1 screwdriver

Service considerations

The following sections include some of the considerations that you must keep in mind during disassembly and assembly procedures.

 **NOTE:** As you remove each subassembly from the computer, place the subassembly (and all accompanying screws) away from the work area to prevent damage.

Plastic parts

 **IMPORTANT:** Using excessive force during disassembly and reassembly can damage plastic parts.

Cables and connectors

 **IMPORTANT:** When servicing the computer, be sure that cables are placed in their proper locations during the reassembly process. Improper cable placement can damage the computer.

Cables must be handled with extreme care to avoid damage. Apply only the tension required to unseat or seat the cables during removal and insertion. Handle cables by the connector whenever possible. In all cases, avoid bending, twisting, or tearing cables. Be sure that cables are routed in such a way that they cannot be caught or snagged by parts being removed or replaced. Handle flex cables with extreme care; these cables tear easily.

Drive handling



IMPORTANT: Drives are fragile components that must be handled with care. To prevent damage to the computer, damage to a drive, or loss of information, observe these precautions:

Before removing or inserting a hard drive, shut down the computer. If you are unsure whether the computer is off or in Hibernation, turn the computer on, and then shut it down through the operating system.

Before handling a drive, be sure that you are discharged of static electricity. While handling a drive, avoid touching the connector.

Before removing an optical drive, be sure that a disc is not in the drive and be sure that the optical drive tray is closed.

Handle drives on surfaces covered with at least 2.54 cm (1 inch) of shock-proof foam.

Avoid dropping drives from any height onto any surface.

After removing a hard drive or an optical drive, place it in a static-proof bag.

Avoid exposing an internal hard drive to products that have magnetic fields, such as monitors or speakers.

Avoid exposing a drive to temperature extremes or liquids.

If a drive must be mailed, place the drive in a bubble pack mailer or other suitable form of protective packaging and label the package “FRAGILE.”

Workstation guidelines

Follow these grounding workstation guidelines:

- Cover the workstation with approved static-shielding material.
- Use a wrist strap connected to a properly grounded work surface and use properly grounded tools and equipment.
- Use conductive field service tools, such as cutters, screw drivers, and vacuums.
- When fixtures must directly contact dissipative surfaces, use fixtures made only of static-safe materials.
- Keep the work area free of nonconductive materials, such as ordinary plastic assembly aids and Styrofoam.
- Handle ESD-sensitive components, parts, and assemblies by the case or PCM laminate. Handle these items only at static-free workstations.
- Avoid contact with pins, leads, or circuitry.
- Turn off power and input signals before inserting or removing connectors or test equipment.

Electrostatic discharge information

A sudden discharge of static electricity from your finger or other conductor can destroy static-sensitive devices or microcircuitry. Often the spark is neither felt nor heard, but damage occurs. An electronic device exposed to electrostatic discharge (ESD) might not appear to be affected at all and can work perfectly throughout a normal cycle. The device might function normally for a while, but it has been degraded in the internal layers, reducing its life expectancy.

Networks built into many integrated circuits provide some protection, but in many cases, the discharge contains enough power to alter device parameters or melt silicon junctions.



IMPORTANT: To prevent damage to the device when you are removing or installing internal components, observe these precautions:

Keep components in their electrostatic-safe containers until you are ready to install them.

Before touching an electronic component, discharge static electricity by using the guidelines described in this section.

Avoid touching pins, leads, and circuitry. Handle electronic components as little as possible.

If you remove a component, place it in an electrostatic-safe container.

Generating static electricity

Note the following:

- Different activities generate different amounts of static electricity.
- Static electricity increases as humidity decreases.

Table 4-1 Static electricity occurrence based on activity and humidity

Event	Relative humidity		
	55%	40%	10%
Walking across carpet	7,500 V	15,000 V	35,000 V
Walking across vinyl floor	3,000 V	5,000 V	12,000 V
Motions of bench worker	400 V	800 V	6,000 V
Removing DIPs from plastic tube	400 V	700 V	2,000 V
Removing DIPs from vinyl tray	2,000 V	4,000 V	11,500 V
Removing DIPs from Styrofoam	3,500 V	5,000 V	14,500 V
Removing bubble pack from PCB	7,000 V	20,000 V	26,500 V
Packing PCBs in foam-lined box	5,000 V	11,000 V	21,000 V

Electronic components can be packaged together in plastic tubes, trays, or Styrofoam.



NOTE: As little as 700 volts can degrade a product.

Preventing electrostatic damage to equipment

Many electronic components are sensitive to ESD. Circuitry design and structure determine the degree of sensitivity. The following packaging and grounding precautions are necessary to prevent static electricity damage to electronic components.

- To avoid hand contact, transport products in static-safe containers such as tubes, bags, or boxes.
- Protect all electrostatic parts and assemblies with conductive or approved containers or packaging.
- Keep electrostatic-sensitive parts in their containers until they arrive at static-free stations.
- Place items on a grounded surface before removing them from their container.
- Always be properly grounded when touching a sensitive component or assembly.

- Avoid contact with pins, leads, or circuitry.
- Place reusable electrostatic-sensitive parts from assemblies in protective packaging or conductive foam.

Personal grounding methods and equipment

Use the following equipment to prevent static electricity damage to electronic components:

- **Wrist straps** are flexible straps with a maximum of $1\text{ M}\Omega \pm 10\%$ resistance in the ground cords. To provide proper ground, a strap must be worn snug against bare skin. The ground cord must be connected and fit snugly into the banana plug connector on the grounding mat or workstation.
- **Heel straps/Toe straps/Boot straps** can be used at standing workstations and are compatible with most types of shoes or boots. On conductive floors or dissipative floor mats, use them on both feet with a maximum of $1\text{ M}\Omega \pm 10\%$ resistance between the operator and ground.

Table 4-2 Static shielding protection levels

Static shielding protection levels	
Method	Voltage
Antistatic plastic	1,500
Carbon-loaded plastic	7,500
Metallized laminate	15,000

Grounding the work area

To prevent static damage at the work area, take the following precautions:

- Cover the work surface with approved static-dissipative material. Provide a wrist strap connected to the work surface and properly grounded tools and equipment.
- Use static-dissipative mats, foot straps, or air ionizers to give added protection.
- Handle electrostatic sensitive components, parts, and assemblies by the case or PCB laminate. Handle them only at static-free work areas.
- Turn off power and input signals before inserting and removing connectors or test equipment.
- Use fixtures made of static-safe materials when fixtures must directly contact dissipative surfaces.
- Keep work area free of nonconductive materials such as ordinary plastic assembly aids and Styrofoam.
- Use field service tools, such as cutters, screwdrivers, and vacuums, that are conductive.

Recommended materials and equipment

HP recommends the following materials and equipment to prevent static electricity:

- Antistatic tape
- Antistatic smocks, aprons, or sleeve protectors
- Conductive bins and other assembly or soldering aids
- Conductive foam
- Conductive tabletop workstations with ground cord of $1\text{ M}\Omega \pm 10\%$ resistance
- Static-dissipative table or floor mats with hard tie to ground

- Field service kits
- Static awareness labels
- Wrist straps and footwear straps providing $1\text{ M}\Omega \pm 10\%$ resistance
- Material handling packages
- Conductive plastic bags
- Conductive plastic tubes
- Conductive tote boxes
- Opaque shielding bags
- Transparent metallized shielding bags
- Transparent shielding tubes

Packaging and transporting guidelines

Follow these grounding guidelines when packaging and transporting equipment:

- To avoid hand contact, transport products in static-safe tubes, bags, or boxes.
- Protect ESD-sensitive parts and assemblies with conductive or approved containers or packaging.
- Keep ESD-sensitive parts in their containers until the parts arrive at static-free workstations.
- Place items on a grounded surface before removing items from their containers.
- Always be properly grounded when touching a component or assembly.
- Store reusable ESD-sensitive parts from assemblies in protective packaging or nonconductive foam.
- Use transporters and conveyors made of antistatic belts and roller bushings. Be sure that mechanized equipment used for moving materials is wired to ground and that proper materials are selected to avoid static charging. When grounding is not possible, use an ionizer to dissipate electric charges.

5 Removal and replacement procedures for authorized service provider parts

 **IMPORTANT:** Components described in this chapter should only be accessed by an authorized service provider. Accessing these parts can damage the computer or void the warranty.

 **NOTE:** HP continually improves and changes product parts. For complete and current information on supported parts for your computer, go to <http://partsurfer.hp.com>, select your country or region, and then follow the on-screen instructions.

Component replacement procedures

There are as many as 50 screws that must be removed, replaced, and/or loosened when servicing the computer. Make special note of each screw size and location during removal and replacement.

Preparation for disassembly

See [Removal and replacement procedures preliminary requirements on page 17](#) for initial safety procedures.

1. Turn off the computer. If you are unsure whether the computer is off or in Hibernation, turn the computer on, and then shut it down through the operating system.
2. Disconnect the power from the computer by unplugging the power cord from the computer.
3. Disconnect all external devices from the computer

Keyboard/top cover

In this section, the first table provides the main spare part number for the keyboards. The second table provides the country codes.

Table 5-1 Keyboard/top cover and Rubber Foot Kit descriptions and part numbers

Description	Spare part number
Keyboard/top cover	
<ul style="list-style-type: none">• For use in royal blue models	L44441-xx1
<ul style="list-style-type: none">• For use in diamond white models	L44642-xx1
<ul style="list-style-type: none">• For use in rose pink models	L45168-xx1
Rubber Foot Kit	
<ul style="list-style-type: none">• For use in royal blue models	L44455-001
<ul style="list-style-type: none">• For use in diamond white models	L44456-001
<ul style="list-style-type: none">• For use in rose pink models	L44457-001

Table 5-2 Spare part country codes

For use in country or region	Spare part number	For use in country or region	Spare part number	For use in country or region	Spare part number
Belgium	-A41	Italy	-061	Saudi Arabia	-171
Denmark, Finland, and Norway	-DH1	The Netherlands	-B31	Spain	-071
France	-051	Portugal	-131	Ukraine	-BD1
Germany	-041	Romania	-271	United Kingdom	-031
Greece	-151	Russia	-251	United States	-001

Before removing the keyboard/top cover, follow these steps:

- ▲ Prepare the computer for disassembly ([Preparation for disassembly on page 22](#)).

 **NOTE:** When replacing the keyboard/top cover, be sure that the touchpad board (see [Touchpad board on page 26](#)), power button board (see [Power button board on page 28](#)), and keyboard hook (see [Keyboard hook on page 29](#)) are removed from the defective keyboard/top cover and installed on the replacement keyboard/top cover.

Remove the keyboard/top cover:

1. Position the computer upside down.
2. Peel the upper rubber foot (1) and lower rubber foot (2) off the bottom of the computer.
3. Remove the seven Phillips M2.0 × 5.0 screws (3) that secure the keyboard/top cover to the bottom cover.

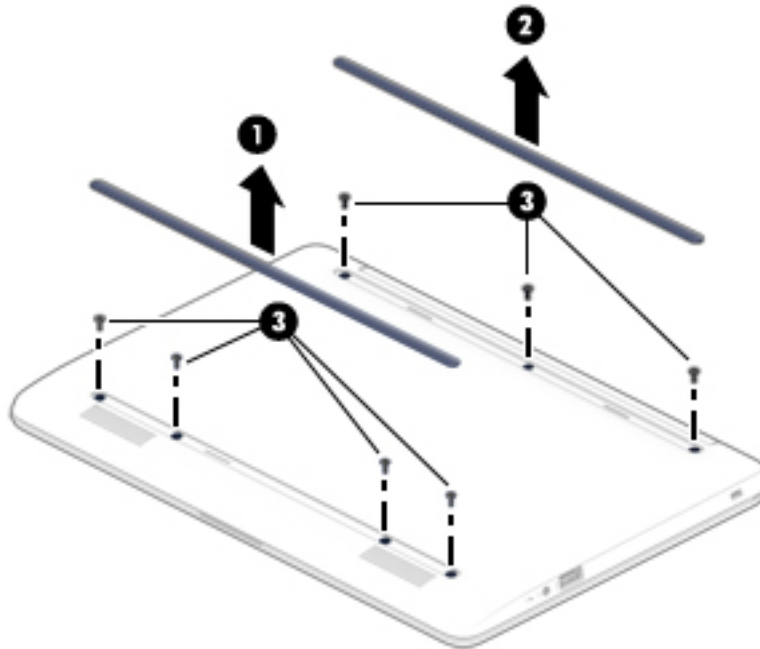

4. Position the computer right side up with the front toward you.
5. Open the computer as far as it will open.

6. Starting near display, flex the chassis to loosen the top cover **(1)**.
7. Work around the edges to the bottom of the top cover **(2)**, and then lift the bottom of the keyboard/top cover until it separates from the bottom cover **(3)**.

 **TIP:** Cables connect from the bottom of the keyboard/top cover to the system board. Be sure not to accidentally pull the cables out of the connectors when removing the keyboard/top cover.

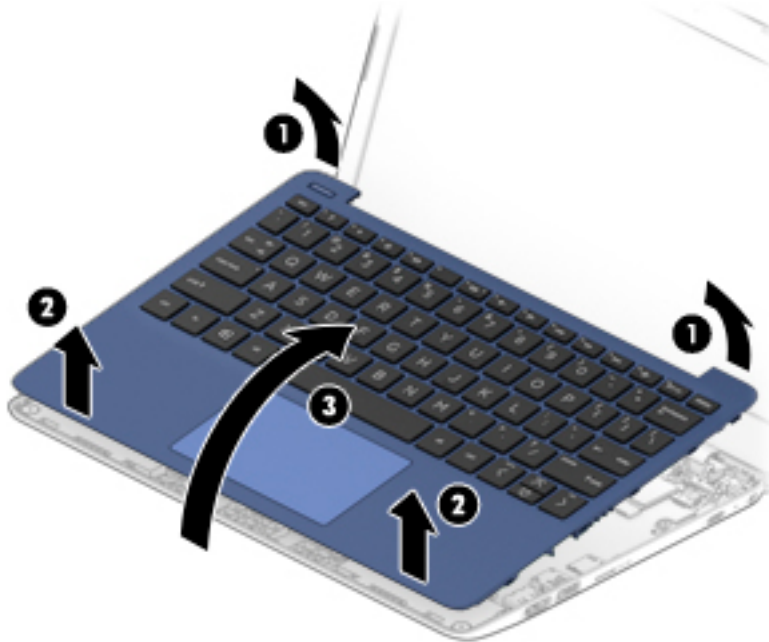

8. While holding the front keyboard/top cover up, disconnect the keyboard cable from the reverse ZIF connector on the system board **(1)**.
9. Disconnect the power button board cable from the ZIF connector on the system board **(2)**.

10. Remove the keyboard/top cover (3).

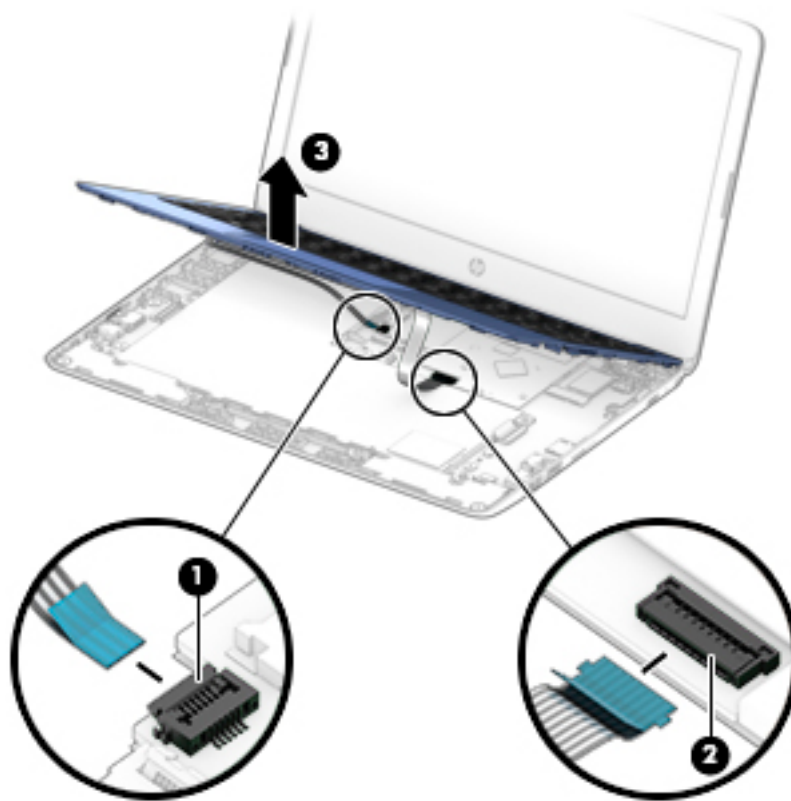

Reverse this procedure to install the keyboard/top cover.

Touchpad board

 **NOTE:** The touchpad board spare part kit does not include the touchpad board cable. The touchpad board cable is available as spare part number L44450-001.

Table 5-3 Touchpad board descriptions and part numbers

Description	Spare part number
Touchpad for use in royal blue models	L44447-001
Touchpad for use in diamond white models	L44448-001
Touchpad for use in rose pink models	L44449-001

Before removing the touchpad board, follow these steps:

1. Prepare the computer for disassembly ([Preparation for disassembly on page 22](#)).
2. Remove the keyboard/top cover (see [Keyboard/top cover on page 22](#)).

Remove the touchpad board:

1. Position the keyboard/top cover upside down with the front toward you.
2. Remove the three Phillips M2.0 × 1.6 screws **(1)** that secure the touchpad bracket to the top cover.
3. Remove the touchpad bracket from the computer **(2)**.

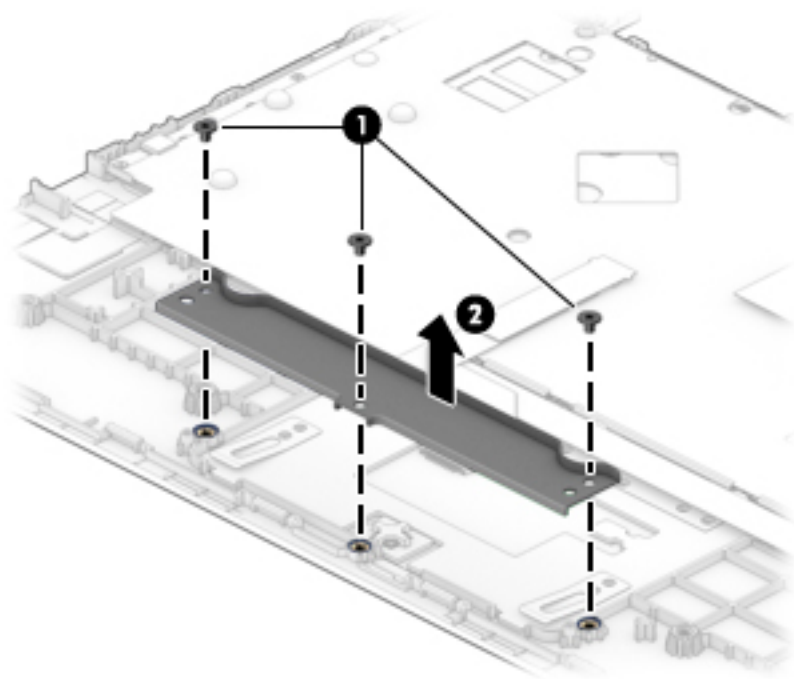

4. Lift the clear protective tape from the touchpad board screws **(1)**.
5. Remove the three Phillips M2.0 × 2.5 screws **(2)** that secure the touchpad board to the top cover.

6. Lift the right side of the touchpad (3), and then pull the touchpad to the right (4) to pull the tab (5) out from under the metal of the top cover.

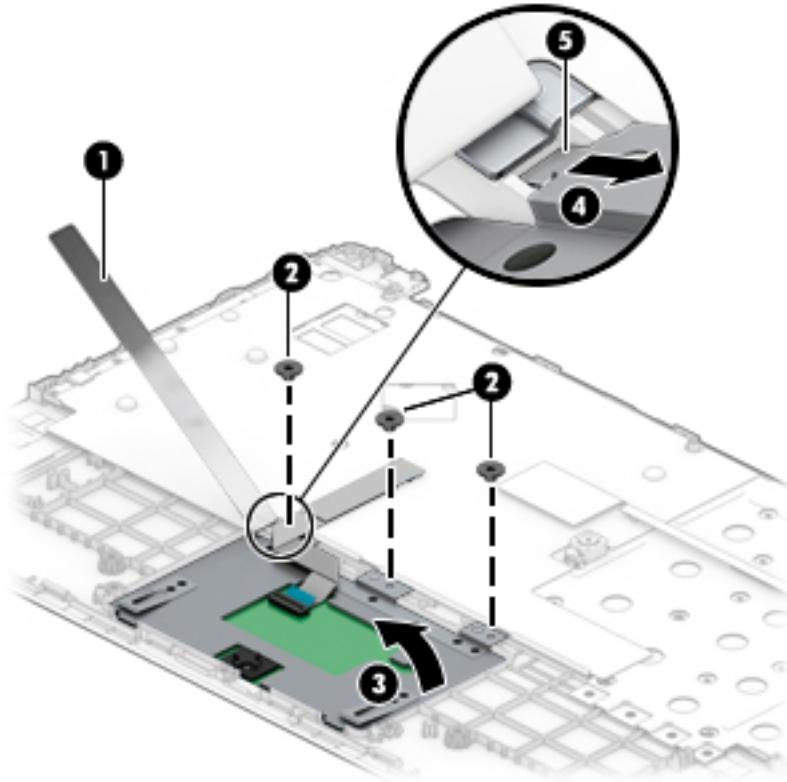

Reverse this procedure to install the touchpad board.

Power button board

 **NOTE:** The power button board spare part kit does not include the power button board cable. The power button board cable is available as spare part number L44445-001.

Table 5-4 Power button board description and part number

Description	Spare part number
Power button board for use in models with a Pentium or Celeron processor	L44444-001
Power button board for use in models with an Atom processor	L62793-001

Before removing the power button board, follow these steps:

1. Prepare the computer for disassembly ([Preparation for disassembly on page 22](#)).
2. Remove the keyboard/top cover (see [Keyboard/top cover on page 22](#)).

Remove the power button board:

1. Position the top cover upside down with the front toward you.
2. Disconnect the cable from the ZIF connector on the power button board **(1)**.
3. Remove the Phillips M2.0 × 2.6 screw **(2)** that secures the power button board to the top cover.
4. Remove the power button board **(3)**.

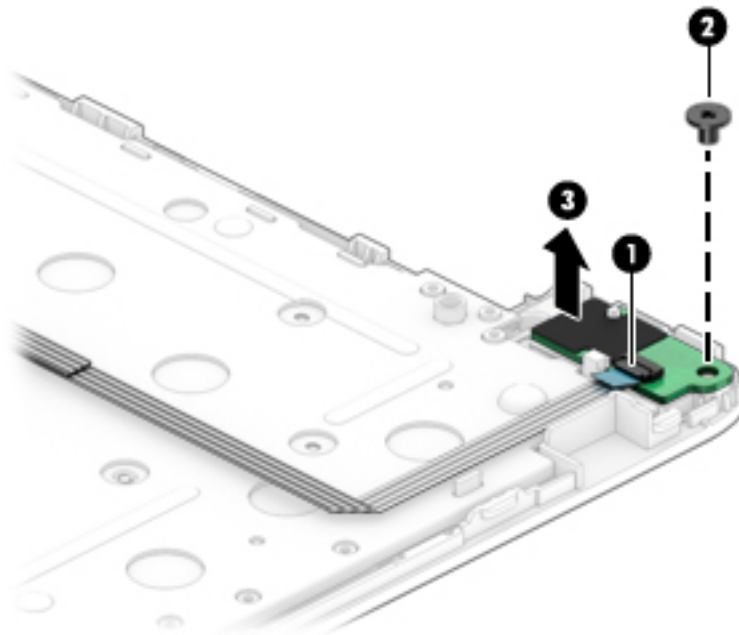

Reverse this procedure to install the power button board.

Keyboard hook

Table 5-5 Keyboard hook description and part number

Description	Spare part number
Keyboard hook	L48424-001

Before removing the keyboard hook, follow these steps:

1. Prepare the computer for disassembly ([Preparation for disassembly on page 22](#)).
2. Remove the keyboard/top cover (see [Keyboard/top cover on page 22](#)).

Remove the keyboard hook:

1. Position the keyboard/top cover upside down with the front toward you.
2. Remove the Phillips M2.0 × 2.5 screw **(1)** that secures the keyboard hook to the top cover.
3. Remove the keyboard hook from the top cover **(2)**.

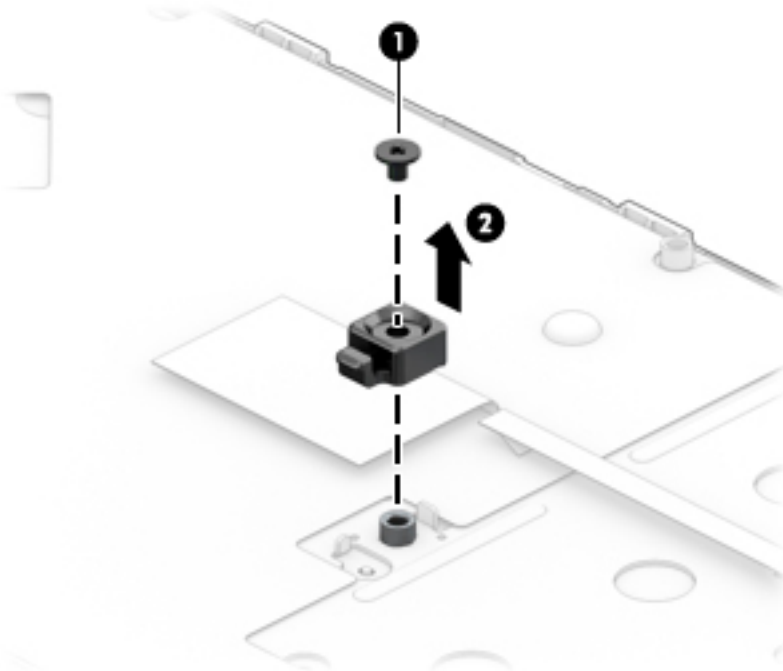

Reverse this procedure to install the keyboard hook.

Battery

Table 5-6 Battery description and part number

Description	Spare part number
Battery (2-cell, 37 Whr, 4.96 Ahr, polymer; includes cable)	824536-850

Before removing the battery, follow these steps:

1. Prepare the computer for disassembly ([Preparation for disassembly on page 22](#)).
2. Remove the keyboard/top cover (see [Keyboard/top cover on page 22](#)).

Remove the battery:

1. Disconnect the battery cable from the system board (**1**).
2. Remove the eight Phillips M2.0 × 2.5 screws (**2**) that secure the battery to the computer.
3. Remove the battery from the computer (**3**).

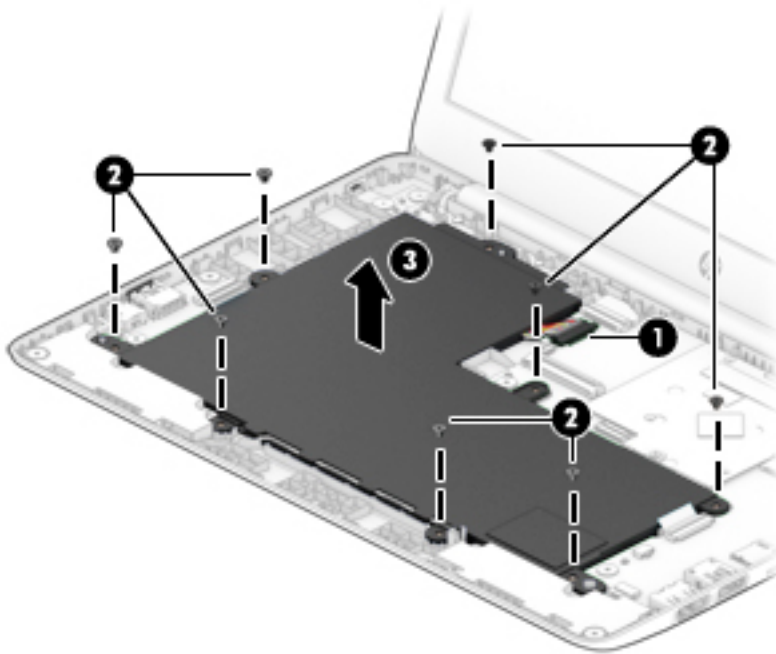

Reverse this procedure to install the battery.

WLAN module

Table 5-7 WLAN module descriptions and part numbers

Description	Spare part number
Realtek RTL8821CE 802.11ac 1 × 1 Wi-Fi + Bluetooth 4.2	L17365-005
Realtek RTL8822BE 802.11ac 2 × 2 Wi-Fi + Bluetooth 4.2	924813-855
Realtek RTL8822CE 802.11ac 2 × 2 Wi-Fi + Bluetooth 5.0 (MU-MIMO supported)	L44796-005

 **IMPORTANT:** To prevent an unresponsive system, replace the wireless module only with a wireless module authorized for use in the computer by the governmental agency that regulates wireless devices in your country or region. If you replace the module and then receive a warning message, remove the module to restore device functionality, and then contact technical support.

Before removing the WLAN module, follow these steps:

1. Prepare the computer for disassembly ([Preparation for disassembly on page 22](#)).
2. Remove the keyboard/top cover (see [Keyboard/top cover on page 22](#)).
3. Disconnect the battery (see [Battery on page 30](#)).

Remove the WLAN module:

1. Disconnect the WLAN antenna cables (**1**) from the terminals on the WLAN module.



NOTE: The #1/white WLAN antenna cable connects to the WLAN module #1/Main terminal. The #2/black WLAN antenna cable connects to the WLAN module #1/Aux terminal.

2. Remove the Phillips M2.0 × 2.5 screw (**2**) that secures the WLAN module to the bottom cover. (The WLAN module tilts up.)

3. Remove the WLAN module (3) by pulling the module away from the slot at an angle.

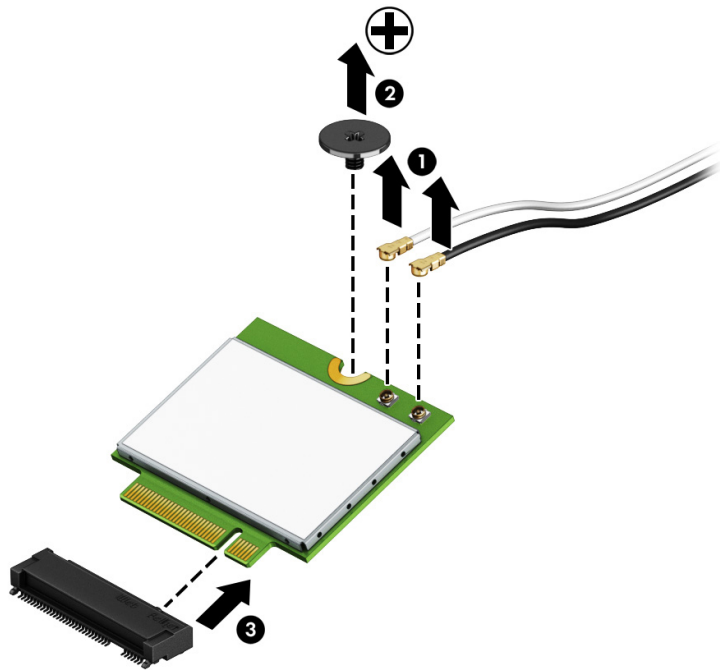

NOTE: If the WLAN antenna is not connected to the terminal on the WLAN module, a protective sleeve must be installed on the antenna connector, as shown in the following illustration.

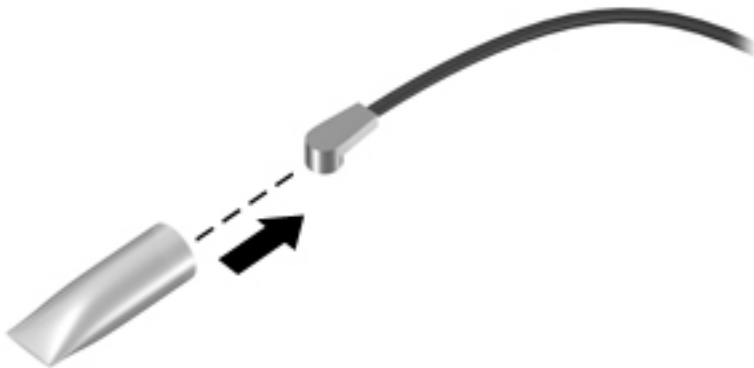

Reverse this procedure to install the WLAN module.

Speakers

Table 5-8 Speaker description and part number

Description	Spare part number
Speakers (include left and right speakers and cables)	L44458-001

Before removing the speakers, follow these steps:

1. Prepare the computer for disassembly ([Preparation for disassembly on page 22](#)).
2. Remove the keyboard/top cover (see [Keyboard/top cover on page 22](#)).
3. Disconnect the battery (see [Battery on page 30](#)).

Remove the speakers:

1. Disconnect the speaker cable from the system board **(1)**.
2. Release the speaker cable from the routing clips **(2)** built into the battery.
3. Remove the two Phillips M2.0 × 2.5 screws **(3)** that secure the speakers to the computer.
4. Remove the speakers **(4)**.

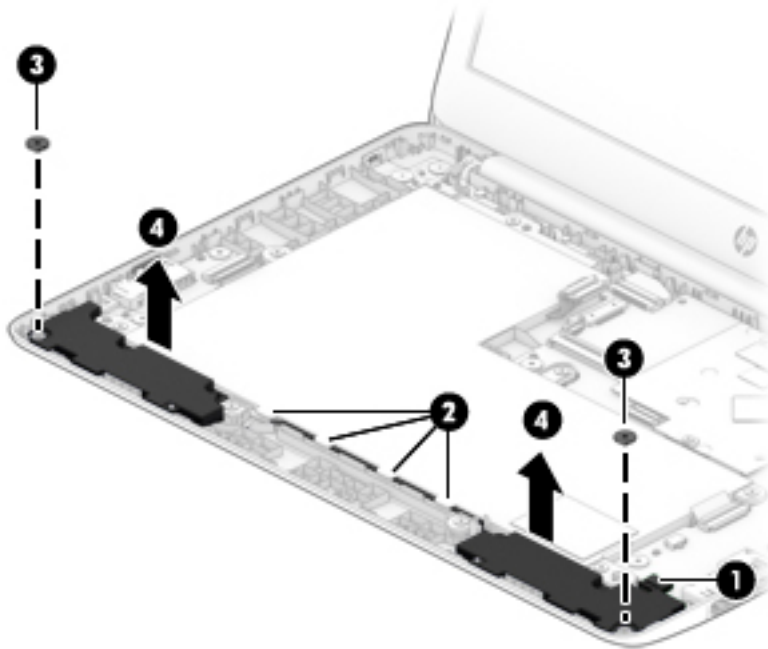

Reverse this procedure to install the speakers.

USB/audio board

 **NOTE:** The USB/audio board spare part kit does not include the audio/USB board cable. The cable is available as spare part number L44443-001.

Table 5-9 USB/audio description and part number

Description	Spare part number
USB/audio board for use in models with a Pentium or Celeron processor	L44442-001
USB/audio board for use in models with an Atom processor	L62794-001

Before removing the USB/audio board, follow these steps:

1. Prepare the computer for disassembly ([Preparation for disassembly on page 22](#)).
2. Remove the keyboard/top cover (see [Keyboard/top cover on page 22](#)).
3. Disconnect the battery (see [Battery on page 30](#)).

Remove the USB/audio board

1. Disconnect the cable from the ZIF connector on the audio/USB board **(1)**.
2. Remove the two Phillips M2.0 × 2.5 screws **(2)** that secure the board to the computer.
3. Remove the board from the computer **(3)**.

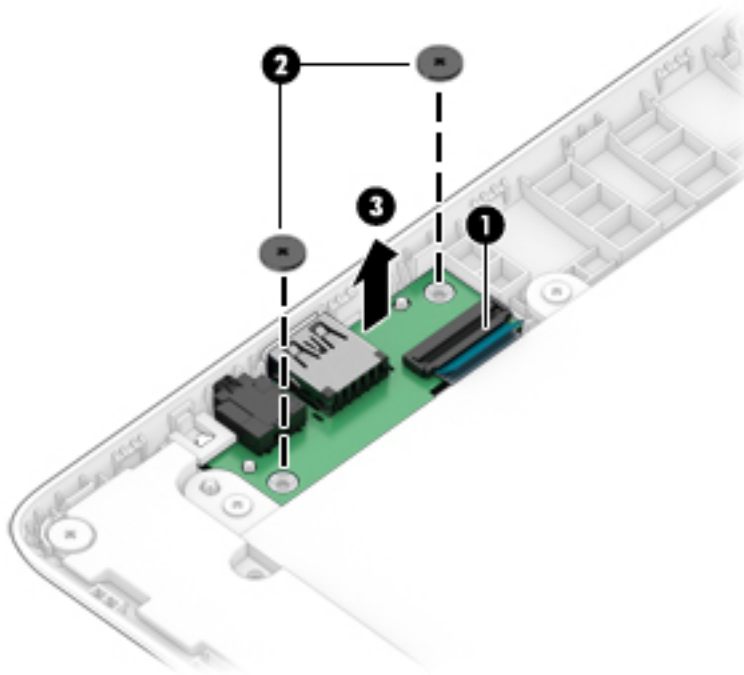

Reverse this procedure to install the USB/audio board

Heat sink/thermal plate

Table 5-10 Heat sink/thermal plate description and part number

Description	Spare part number
Heat sink/thermal plate for use in models with a Pentium or Celeron processor (includes replacement thermal material)	L44446-001
Heat sink/thermal plate for use in models with an Atom processor (includes replacement thermal material)	L61326-001

Before removing the heat sink, follow these steps:

1. Prepare the computer for disassembly ([Preparation for disassembly on page 22](#)).
2. Remove the keyboard/top cover (see [Keyboard/top cover on page 22](#)).
3. Disconnect the battery (see [Battery on page 30](#)).

Remove the heat sink:

1. Remove the two Phillips M2.0 × 2.5 screws (**1**) that secure the heat sink to the system board.
2. Remove the heat sink (**2**).

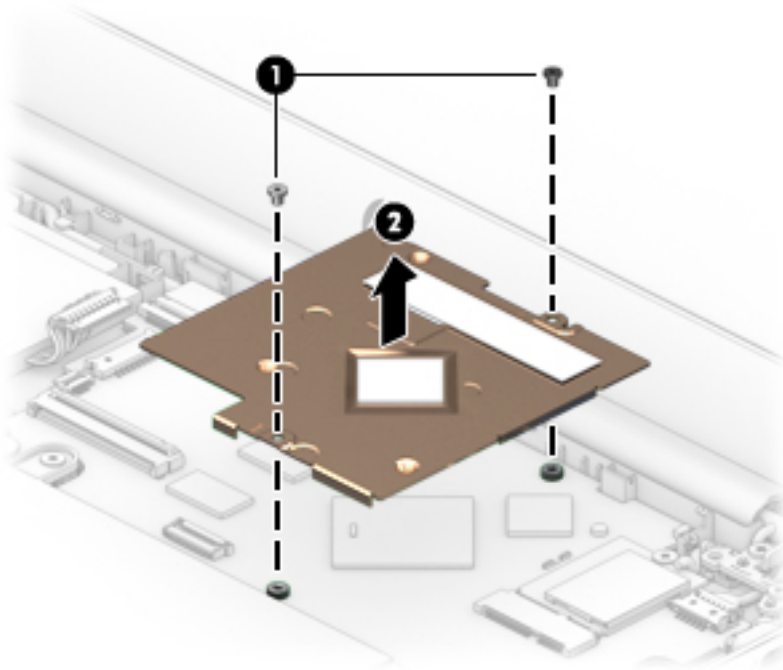

 **NOTE:** The thermal material must be thoroughly cleaned from the surfaces of the heat sink and the system board components each time the heat sink is removed. Thermal paste is used on the heat sink (**1**) and the processor component on the system board (**2**).

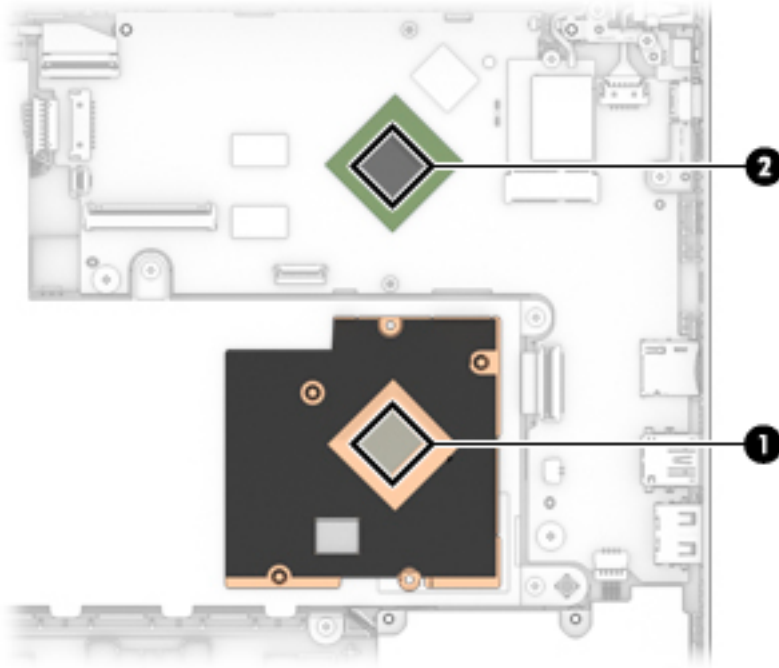

Reverse this procedure to install the heat sink.

Display assembly

 **NOTE:** The display assembly is spared at the subcomponent level only. For more display assembly spare part information, see the individual removal subsections.

Before removing the display assembly, follow these steps:

1. Prepare the computer for disassembly ([Preparation for disassembly on page 22](#)).
2. Remove the keyboard/top cover (see [Keyboard/top cover on page 22](#)).
3. Disconnect the battery (see [Battery on page 30](#)).

Remove the display assembly:

1. Disconnect the display cable from the ZIF connector on the system board **(1)**.
2. Remove the display cable from the clips in the chassis **(2)**.
3. Disconnect the antenna cables from the WLAN module **(3)**.
4. Remove the antenna cables from the clip on the side of the display hinge bracket **(4)**.

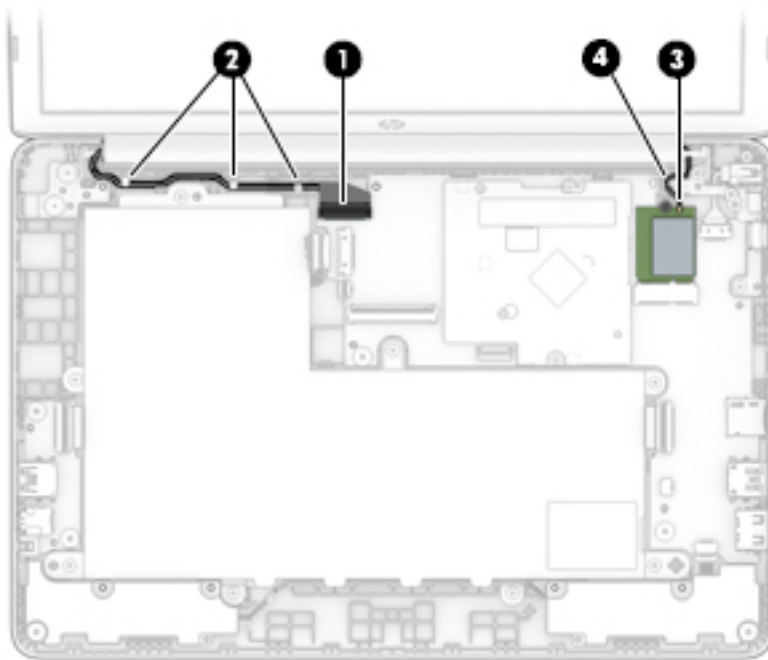

5. Remove the two Phillips M2.5 × 2.0 screws **(1)** from the left hinge.
6. Remove the two Phillips M2.5 × 3.0 screws **(2)** from the right hinge.

7. Separate the display from the computer by pulling the display up and away from the chassis (3).

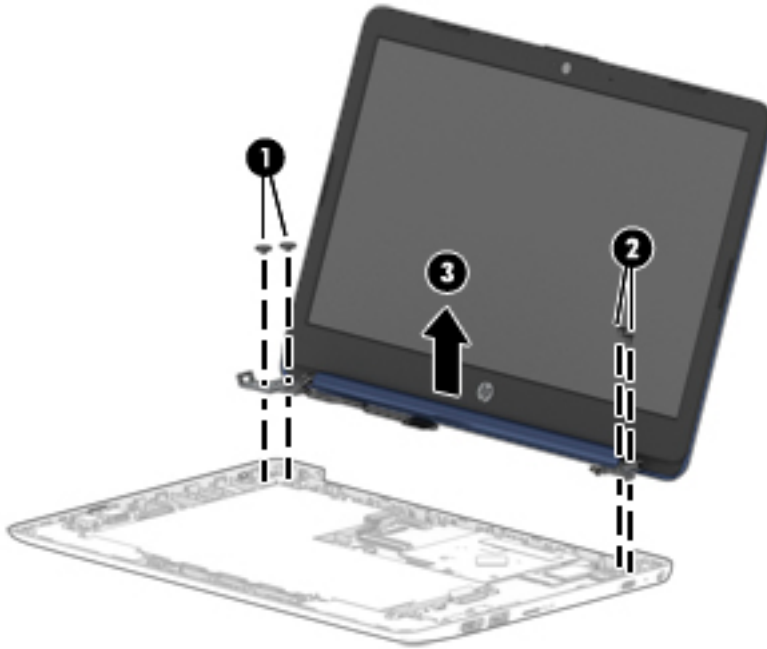

8. If it is necessary to replace the display bezel or any of the display assembly subcomponents:
 - a. Flex the inside edges (1), the left and right sides (2), and the bottom edge (3) of the display bezel until the bezel comes loose from the display back cover.
 - b. Remove the display bezel (4).

The display bezel is available as spare part number L44464-001.

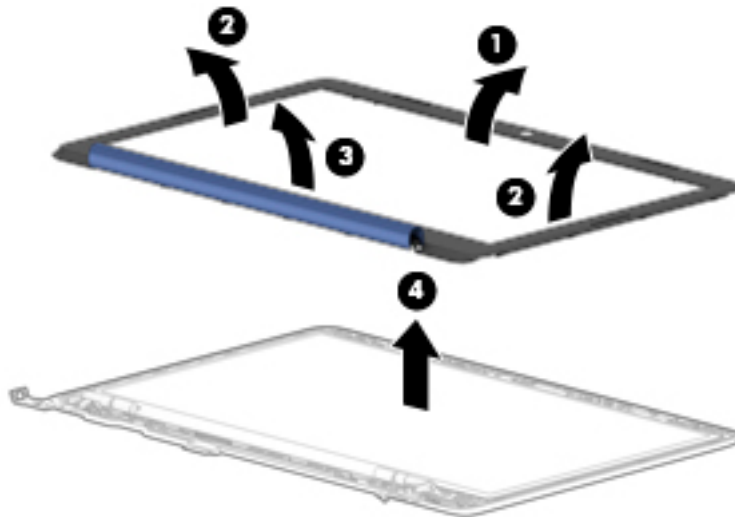

9. If it is necessary to remove the hinge cover, rotate the cover downward **(1)**, and then remove it from the display enclosure **(2)**.

Hinge covers are available as spare part number L44468-001 for royal blue models, L44469-001 for diamond white models, and L44470-001 for rose pink models.

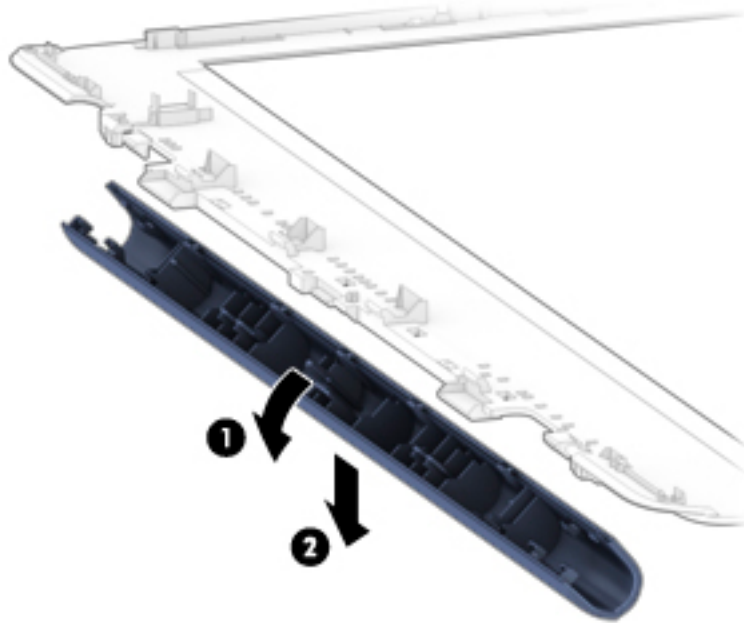

10. If it is necessary to replace the camera/microphone module:
 - a. Disconnect the cable **(1)** from the camera/microphone module.

- b. Detach the camera/microphone module from the display back cover (**2**). The camera/microphone module is attached to the display back cover with double-sided adhesive.

The camera/microphone module is available as spare part number L44439-001.

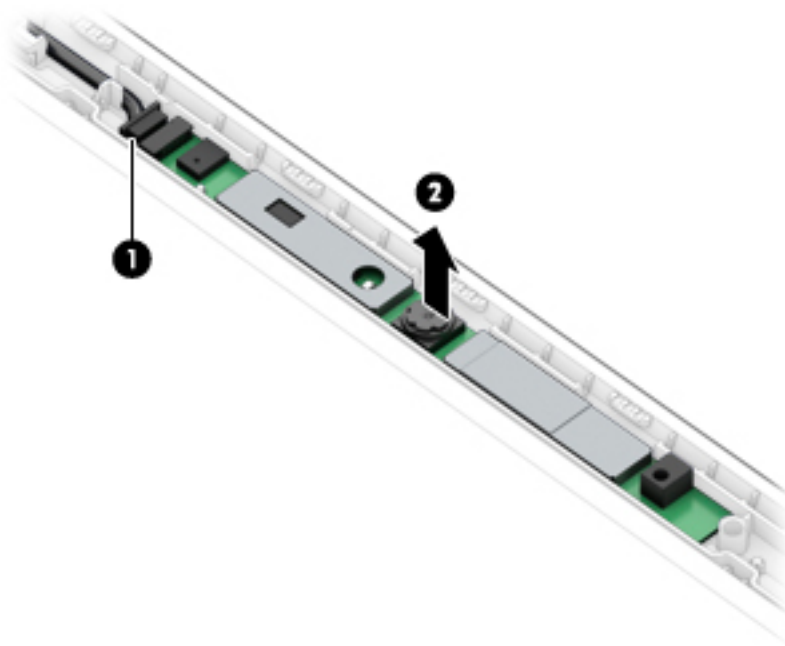

11. If it is necessary to replace the display panel:

- a. Remove the four Phillips M2.0 × 2.5 screws (**1**) that secure the display panel to the display back cover.

- b. Lift the top edge of the display panel **(2)** and swing it up and forward until it rests upside down in front of the display back cover.

 **IMPORTANT:** Before turning the display panel upside down, make sure the work surface is clear of tools, screws, and any other foreign objects. Failure to follow this caution can result in damage to the display panel.

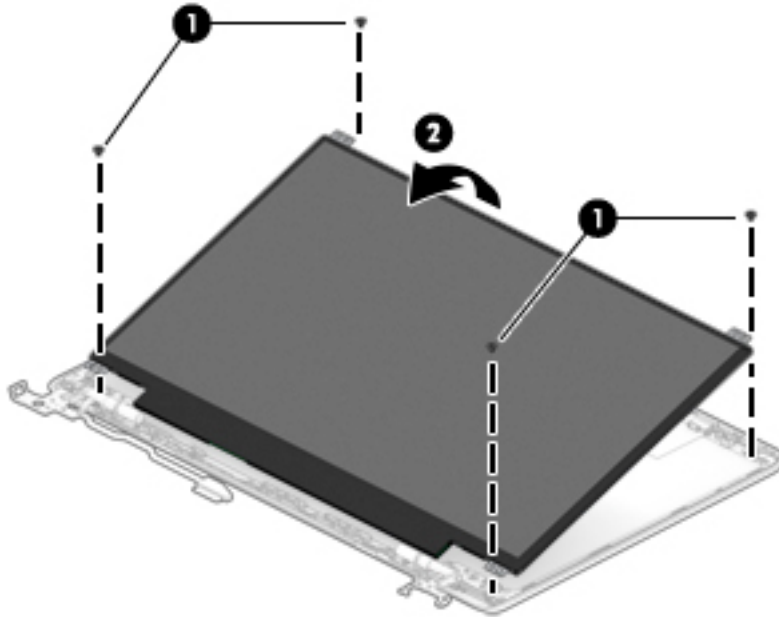

- c. Release the adhesive strip **(1)** that secures the display panel cable connector to the display panel, and then disconnect the display cable from the display panel **(2)**.

- d. Remove the display panel (3).

The raw display panel is available as spare part number L44440-001.

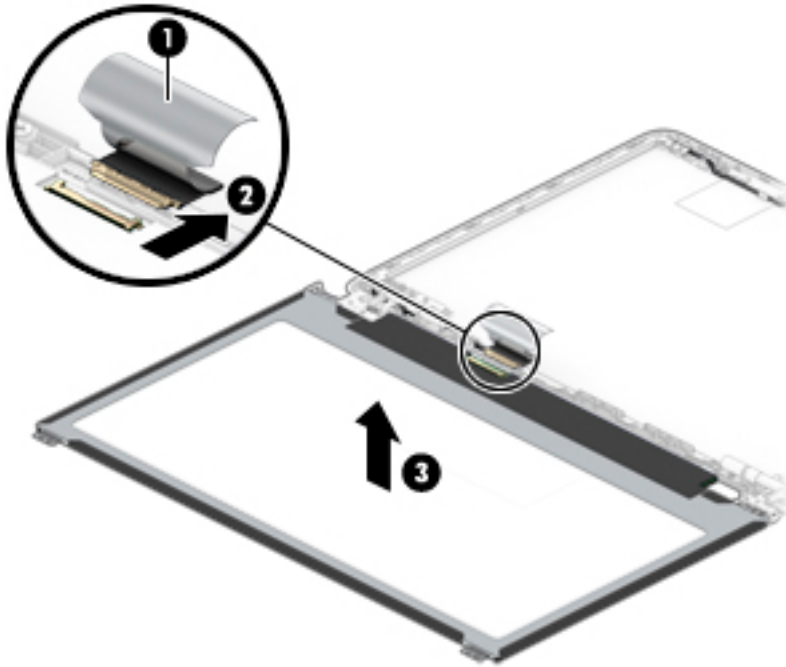

12. If it is necessary to replace the display hinges:

- a. Remove the four Phillips M2.5 × 3.0 screws (1) that secure each display hinge to the display back cover.
- b. Remove the display hinges (2).

The display hinges are included in the Display Hinge Kit, spare part number L44467-001.

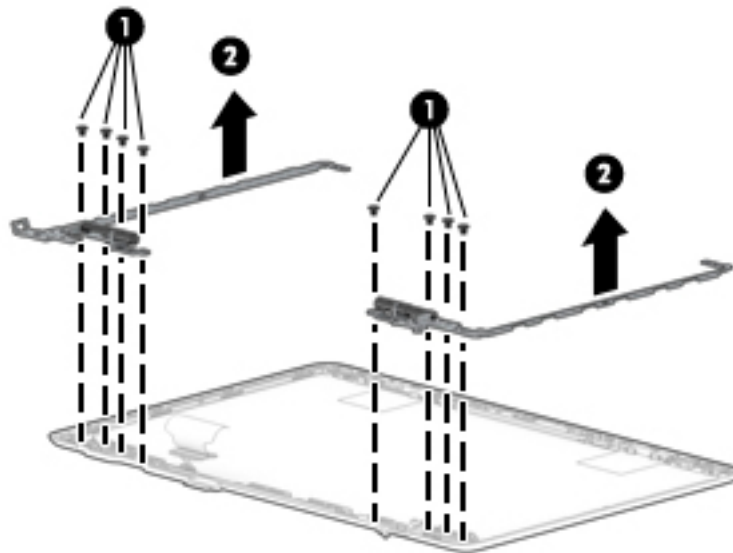

13. If it is necessary to replace the display panel cable:

- a. Disconnect the display panel cable (1) from the camera/microphone module.
- b. Release the display panel cable from the retention clips (2) and routing channel built into the left and top sides of the display back cover.
- c. Remove the display panel cable (3).

The display panel cable is available as spare part number L44466-001.

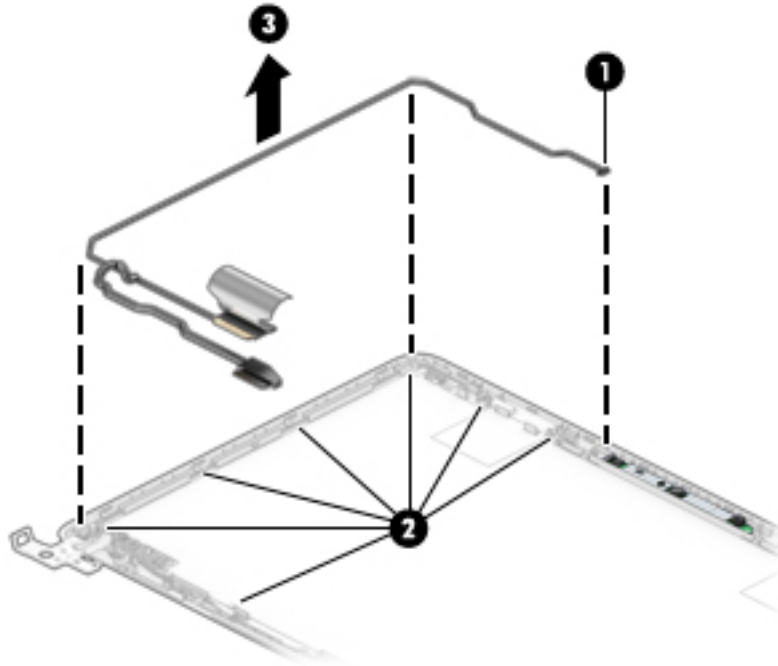

14. If it is necessary to replace the WLAN antennas and cables:

- a. Detach the WLAN antennas (1) from the display back cover. (The antennas are attached to the display back cover with double-sided adhesive.)
- b. Release the cables from the clips and routing channel built into the bottom, left, and right edges of the display back cover (2).

- c. Remove the antennas and cables (3).

The WLAN antennas and cables are available as spare part number L44462-001 for a models that use a single antenna and L44463-001 for models that use dual antennas.

 **NOTE:** The following illustration shows dual antennas.

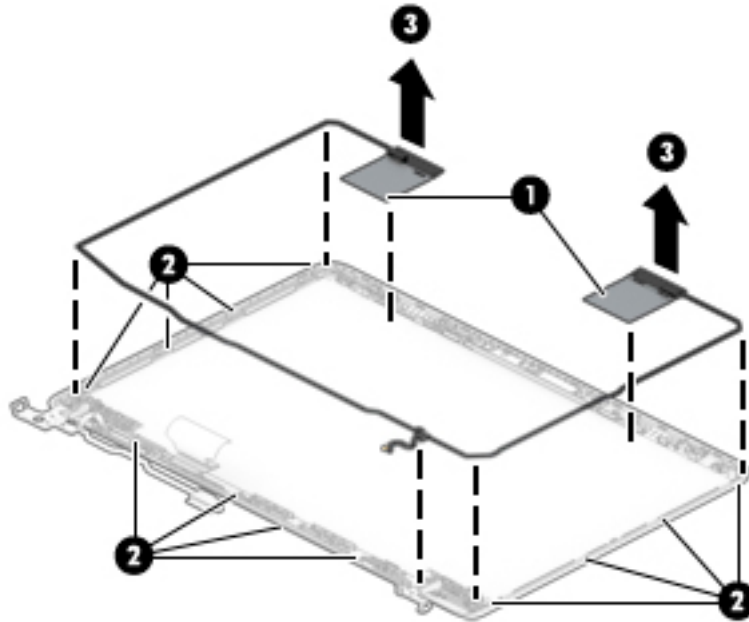

Display enclosure is available as spare part number L44459-001 for royal blue models, L44460-001 for diamond white models, and L44461-001 for rose pink models.

15. Use the following image to determine proper display cable (1) and antenna cable (1) and (2) routing in the display back cover.

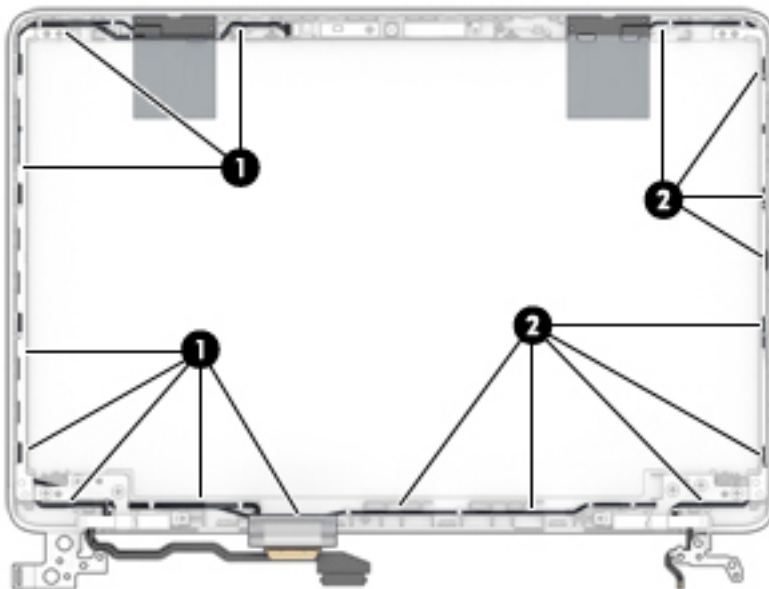

Reverse this procedure to reassemble install the display assembly.

System board



NOTE: All system board spare part kits include replacement thermal material.

All system boards use the following part numbers:

xxxxxx-001: Non-Windows operating systems

xxxxxx-601: Windows operating system

Table 5-11 System board descriptions and part numbers

Description	Spare part number
System board with Pentium N5000 processor, 4 GB of system memory, and 32 GB of eMMC memory	L44438-xx1
System board with Celeron N4000 processor, 4 GB of system memory, and 64 GB of eMMC memory	L44437-xx1
System board with Celeron N4000 processor, 4 GB of system memory, and 32 GB of eMMC memory	L44436-xx1
System board with Celeron N4000 processor, 2 GB of system memory, and 32 GB of eMMC memory	L44435-xx1
System board with Atom x5-E8000 processor, 4 GB of system memory, and 64 GB of eMMC memory	L59930-601
System board with Atom x5-E8000 processor, 4 GB of system memory, and 32 GB of eMMC memory	L59929-601
System board with Atom x5-E8000 processor, 2 GB of system memory, and 32 GB of eMMC memory	L59928-601

Before removing the system board, follow these steps:

1. Prepare the computer for disassembly ([Preparation for disassembly on page 22](#)).
2. Remove the keyboard/top cover (see [Keyboard/top cover on page 22](#)).
3. Disconnect the battery (see [Battery on page 30](#)).
4. Remove the WLAN module (see [WLAN module on page 31](#)).
5. Remove the display (see [Display assembly on page 37](#)).

Remove the system board:

1. Disconnect the following cables from the system board:
 - (1) Power connector cable
 - (2) USB/audio board cable (ZIF)
 - (3) Speaker cable

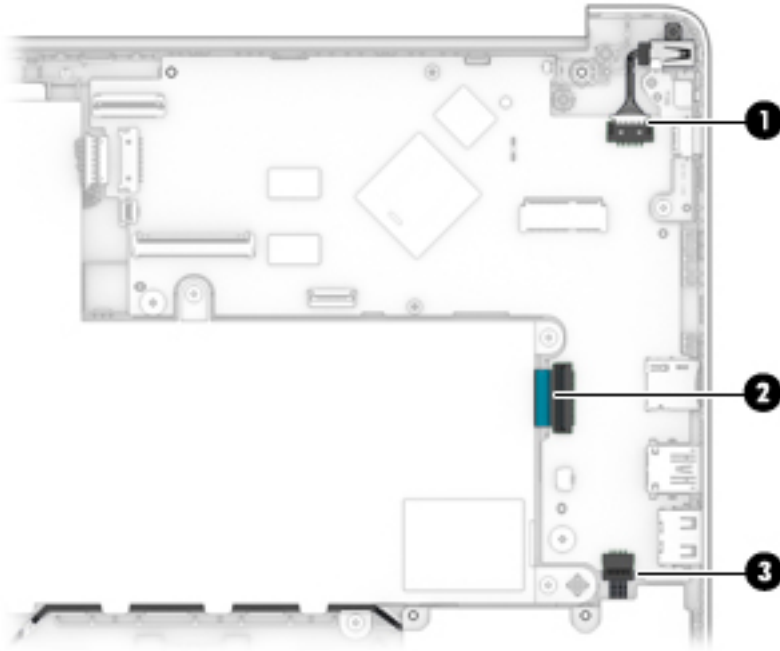

2. Remove the Phillips M2.0 × 2.5 screw **(1)** that secures the USB bracket.
3. Remove the USB bracket that from the system board **(2)**.
4. Remove the two broad head Phillips M2.0 × 2.5 screws **(3)** that secure the system board to the computer.
5. Lift the left side of the system board until it rests at an angle **(4)**, and then remove the system board by pulling it up and to the left and out of the computer **(5)**.

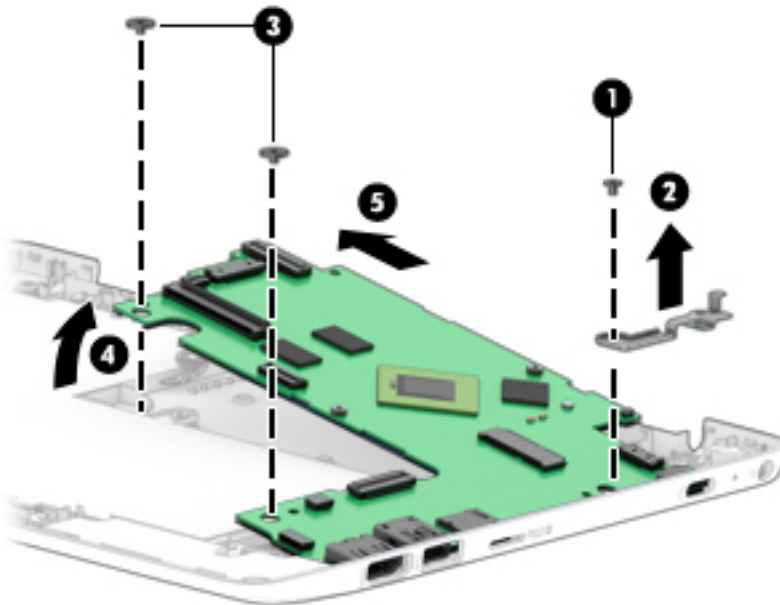

Reverse this procedure to install the system board.

Power connector

Table 5-12 Power connector description and part number

Description	Spare part number
Power connector	L44451-001

Before removing the power connector, follow these steps:

1. Prepare the computer for disassembly ([Preparation for disassembly on page 22](#)).
2. Remove the keyboard/top cover (see [Keyboard/top cover on page 22](#)).
3. Disconnect the battery (see [Battery on page 30](#)).
4. Remove the display (see [Display assembly on page 37](#)).
5. Remove the USB bracket (see [System board on page 45](#)).

Remove the power connector cable:

1. Disconnect the power connector cable from the system board **(1)**.
2. Remove the Phillips M2.0 × 2.6 screw **(2)** that secures the power connector to the computer.
3. Remove the power connector and cable from the computer **(3)**.

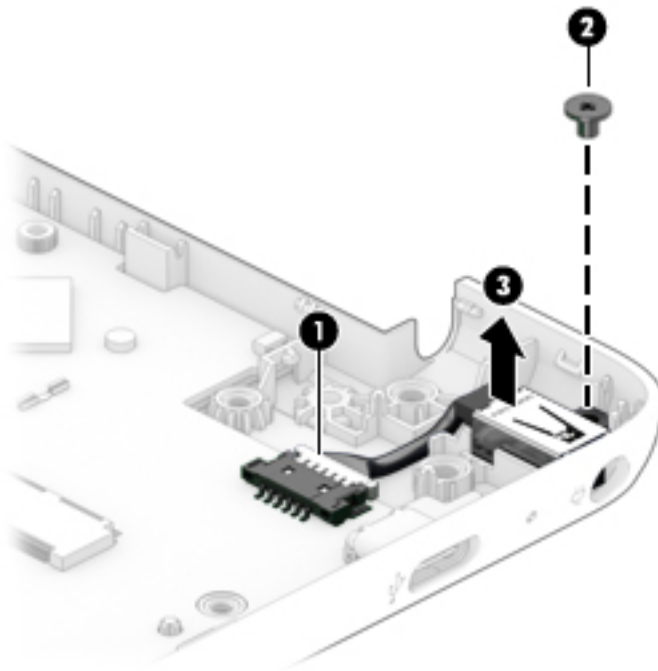

Reverse this procedure to install the power connector cable.

6 Using Setup Utility (BIOS)

Setup Utility, or Basic Input/Output System (BIOS), controls communication between all the input and output devices on the system (such as disk drives, display, keyboard, mouse, and printer). Setup Utility (BIOS) includes settings for the types of devices installed, the startup sequence of the computer, and the amount of system and extended memory.

 **NOTE:** To start Setup Utility on convertible computers, your computer must be in notebook mode and you must use the keyboard attached to your notebook.

Starting Setup Utility (BIOS)

 **CAUTION:** Use extreme care when making changes in Setup Utility (BIOS). Errors can prevent the computer from operating properly.

▲ Turn on or restart the computer and quickly press **f10**.

– or –

Turn on or restart the computer, quickly press **esc**, and then press **f10** when the Start menu is displayed.

Updating Setup Utility (BIOS)

Updated versions of Setup Utility (BIOS) may be available on the HP website.

Most BIOS updates on the HP website are packaged in compressed files called *SoftPaqs*.

Some download packages contain a file named *Readme.txt*, which contains information regarding installing and troubleshooting the file.

Determining the BIOS version

To decide whether you need to update Setup Utility (BIOS), first determine the BIOS version on your computer.

To reveal the BIOS version information (also known as *ROM date* and *System BIOS*), use one of these options.

- HP Support Assistant
 1. Type `support` in the taskbar search box, and then select the **HP Support Assistant** app.

– or –

Select the question mark icon in the taskbar.

 2. Select **My notebook**, and then select **Specifications**.
- Setup Utility (BIOS)
 1. Start Setup Utility (BIOS) (see [Starting Setup Utility \(BIOS\) on page 48](#)).
 2. Select **Main**, and then make note of the BIOS version.
 3. Select **Exit**, select one of the options, and then follow the on-screen instructions.
- In Windows, press **CTRL+Alt+S**.

To check for later BIOS versions, see [Downloading a BIOS update on page 49](#).

Downloading a BIOS update

 **CAUTION:** To reduce the risk of damage to the computer or an unsuccessful installation, download and install a BIOS update only when the computer is connected to reliable external power using the AC adapter. Do not download or install a BIOS update while the computer is running on battery power, docked in an optional docking device, or connected to an optional power source. During the download and installation, follow these instructions:

- Do not disconnect power from the computer by unplugging the power cord from the AC outlet.
- Do not shut down the computer or initiate Sleep.
- Do not insert, remove, connect, or disconnect any device, cable, or cord.

 **NOTE:** If your computer is connected to a network, consult the network administrator before installing any software updates, especially system BIOS updates.

1. Type `support` in the taskbar search box, and then select the **HP Support Assistant** app.
– or –
Select the question mark icon in the taskbar.
2. Select **Updates**, and then select **Check for updates and messages**.
3. Follow the on-screen instructions.
4. At the download area, follow these steps:
 - a. Identify the most recent BIOS update and compare it to the BIOS version currently installed on your computer. If the update is more recent than your BIOS version, make a note of the date, name, or other identifier. You may need this information to locate the update later, after it has been downloaded to your hard drive.
 - b. Follow the on-screen instructions to download your selection to the hard drive.

Make a note of the path to the location on your hard drive where the BIOS update is downloaded. You will need to access this path when you are ready to install the update.

BIOS installation procedures vary. Follow any instructions that appear on the screen after the download is complete. If no instructions appear, follow these steps:

1. Type `file` in the taskbar search box, and then select **File Explorer**.
2. Select your hard drive designation. The hard drive designation is typically Local Disk (C:).
3. Using the hard drive path you recorded earlier, open the folder that contains the update.
4. Double-click the file that has an `.exe` extension (for example, `filename.exe`).

The BIOS installation begins.
5. Complete the installation by following the on-screen instructions.

 **NOTE:** After a message on the screen reports a successful installation, you can delete the downloaded file from your hard drive.

7 Using HP PC Hardware Diagnostics

Using HP PC Hardware Diagnostics Windows (select products only)

HP PC Hardware Diagnostics Windows is a Windows-based utility that allows you to run diagnostic tests to determine whether the computer hardware is functioning properly. The tool runs within the Windows operating system in order to diagnose hardware failures.

If HP PC Hardware Diagnostics Windows is not installed on your computer, first you must download and install it. To download HP PC Hardware Diagnostics Windows, see [Downloading HP PC Hardware Diagnostics Windows on page 50](#).

After HP PC Hardware Diagnostics Windows is installed, follow these steps to access it from HP Help and Support or HP Support Assistant.

1. To access HP PC Hardware Diagnostics Windows from HP Help and Support:

- a. Select the **Start** button, and then select **HP Help and Support**.
- b. Select **HP PC Hardware Diagnostics Windows**.

– or –

To access HP PC Hardware Diagnostics Windows from HP Support Assistant:

- a. Type `support` in the taskbar search box, and then select the **HP Support Assistant** app.

– or –

Select the question mark icon in the taskbar.

- b. Select **Troubleshooting and fixes**.
- c. Select **Diagnostics**, and then select **HP PC Hardware Diagnostics Windows**.

2. When the tool opens, select the type of diagnostic test you want to run, and then follow the on-screen instructions.



NOTE: If you need to stop a diagnostic test at any time, select **Cancel**.

When HP PC Hardware Diagnostics Windows detects a failure that requires hardware replacement, a 24-digit Failure ID code is generated. The screen displays one of the following options:

- A Failure ID link is displayed. Select the link and follow the on-screen instructions.
- A Quick Response (QR) code is displayed. With a mobile device, scan the code and then follow the on-screen instructions.
- Instructions for calling support are displayed. Follow those instructions.

Downloading HP PC Hardware Diagnostics Windows

- The HP PC Hardware Diagnostics Windows download instructions are provided in English only.
- You must use a Windows computer to download this tool because only .exe files are provided.

Downloading the latest HP PC Hardware Diagnostics Windows version

To download HP PC Hardware Diagnostics Windows, follow these steps:

1. Go to <http://www.hp.com/go/techcenter/pcdiags>. The HP PC Diagnostics home page is displayed.
2. Select **Download HP Diagnostics Windows**, and then select a location on your computer or a USB flash drive.

The tool is downloaded to the selected location.

Downloading HP Hardware Diagnostics Windows by product name or number (select products only)

 **NOTE:** For some products, it may be necessary to download the software to a USB flash drive by using the product name or number.

To download HP PC Hardware Diagnostics Windows by product name or number, follow these steps:

1. Go to <http://www.hp.com/support>.
2. Select **Get software and drivers**, select your type of product, and then enter the product name or number in the search box that is displayed.
3. In the **Diagnostics** section, select **Download**, and then follow the on-screen instructions to select the specific Windows diagnostics version to be downloaded to your computer or USB flash drive.

The tool is downloaded to the selected location.

Installing HP PC Hardware Diagnostics Windows

To install HP PC Hardware Diagnostics Windows, follow these steps:

- ▲ Navigate to the folder on your computer or the USB flash drive where the .exe file was downloaded, double-click the .exe file, and then follow the on-screen instructions.

Using HP PC Hardware Diagnostics UEFI

 **NOTE:** For Windows 10 S computers, you must use a Windows computer and a USB flash drive to download and create the HP UEFI support environment because only .exe files are provided. For more information, see [Downloading HP PC Hardware Diagnostics UEFI to a USB flash drive on page 52](#).

HP PC Hardware Diagnostics UEFI (Unified Extensible Firmware Interface) allows you to run diagnostic tests to determine whether the computer hardware is functioning properly. The tool runs outside the operating system so that it can isolate hardware failures from issues that are caused by the operating system or other software components.

If your PC will not boot into Windows, you can use HP PC Hardware Diagnostics UEFI to diagnose hardware issues.

When HP PC Hardware Diagnostics Windows detects a failure that requires hardware replacement, a 24-digit Failure ID code is generated. For assistance in solving the problem:

- ▲ Select **Get Support**, and then use a mobile device to scan the QR code that displays on the next screen. The HP Customer Support - Service Center page displays, with your Failure ID and product number automatically filled in. Follow the on-screen instructions.

– or –

Contact support, and provide the Failure ID code.

 **NOTE:** To start diagnostics on a convertible computer, your computer must be in notebook mode, and you must use the attached keyboard.

 **NOTE:** If you need to stop a diagnostic test, press `esc`.

Starting HP PC Hardware Diagnostics UEFI

To start HP PC Hardware Diagnostics UEFI, follow these steps:

1. Turn on or restart the computer, and quickly press `esc`.
2. Press `f2`.

The BIOS searches three places for the diagnostic tools, in the following order:

- a. Connected USB flash drive

 **NOTE:** To download the HP PC Hardware Diagnostics UEFI tool to a USB flash drive, see [Downloading the latest HP PC Hardware Diagnostics UEFI version on page 52](#).

- b. Hard drive

- c. BIOS

3. When the diagnostic tool opens, select a language, select the type of diagnostic test you want to run, and then follow the on-screen instructions.

Downloading HP PC Hardware Diagnostics UEFI to a USB flash drive

Downloading HP PC Hardware Diagnostics UEFI to a USB flash drive can be useful in the following situations:

- HP PC Hardware Diagnostics UEFI is not included in the preinstall image.
- HP PC Hardware Diagnostics UEFI is not included in the HP Tool partition.
- The hard drive is damaged.

 **NOTE:** The HP PC Hardware Diagnostics UEFI download instructions are provided in English only, and you must use a Windows computer to download and create the HP UEFI support environment because only `.exe` files are provided.

Downloading the latest HP PC Hardware Diagnostics UEFI version

To download the latest HP PC Hardware Diagnostics UEFI version to a USB flash drive:

1. Go to <http://www.hp.com/go/techcenter/pcdiags>. The HP PC Diagnostics home page is displayed.
2. Select **Download HP Diagnostics UEFI**, and then select **Run**.

Downloading HP PC Hardware Diagnostics UEFI by product name or number (select products only)

 **NOTE:** For some products, it may be necessary to download the software to a USB flash drive by using the product name or number.

To download HP PC Hardware Diagnostics UEFI by product name or number (select products only) to a USB flash drive:

1. Go to <http://www.hp.com/support>.
2. Enter the product name or number, select your computer, and then select your operating system.
3. In the **Diagnostics** section, follow the on-screen instructions to select and download the specific UEFI Diagnostics version for your computer.

Using Remote HP PC Hardware Diagnostics UEFI settings (select products only)

Remote HP PC Hardware Diagnostics UEFI is a firmware (BIOS) feature that downloads HP PC Hardware Diagnostics UEFI to your computer. It can then execute the diagnostics on your computer, and it may upload results to a preconfigured server. For more information about Remote HP PC Hardware Diagnostics UEFI, go to <http://www.hp.com/go/techcenter/pcdiags>, and then select **Find out more**.

Downloading Remote HP PC Hardware Diagnostics UEFI



NOTE: HP Remote PC Hardware Diagnostics UEFI is also available as a Softpaq that can be downloaded to a server.

Downloading the latest Remote HP PC Hardware Diagnostics UEFI version

To download the latest Remote HP PC Hardware Diagnostics UEFI version, follow these steps:

1. Go to <http://www.hp.com/go/techcenter/pcdiags>. The HP PC Diagnostics home page is displayed.
2. Select **Download Remote Diagnostics**, and then select **Run**.

Downloading Remote HP PC Hardware Diagnostics UEFI by product name or number



NOTE: For some products, it may be necessary to download the software by using the product name or number.

To download HP Remote PC Hardware Diagnostics UEFI by product name or number, follow these steps:

1. Go to <http://www.hp.com/support>.
2. Select **Get software and drivers**, select your type of product, enter the product name or number in the search box that is displayed, select your computer, and then select your operating system.
3. In the **Diagnostics** section, follow the on-screen instructions to select and download the **Remote UEFI** version for the product.

Customizing Remote HP PC Hardware Diagnostics UEFI settings

Using the Remote HP PC Hardware Diagnostics setting in Computer Setup (BIOS), you can perform the following customizations:

- Set a schedule for running diagnostics unattended. You can also start diagnostics immediately in interactive mode by selecting **Execute Remote HP PC Hardware Diagnostics**.
- Set the location for downloading the diagnostic tools. This feature provides access to the tools from the HP website or from a server that has been preconfigured for use. Your computer does not require the traditional local storage (such as a disk drive or USB flash drive) to run remote diagnostics.

- Set a location for storing the test results. You can also set the user name and password settings used for uploads.
- Display status information about the diagnostics run previously.

To customize Remote HP PC Hardware Diagnostics UEFI settings, follow these steps:

1. Turn on or restart the computer, and when the HP logo appears, press **f10** to enter Computer Setup.
2. Select **Advanced**, and then select **Settings**.
3. Make your customization selections.
4. Select **Main**, and then **Save Changes and Exit** to save your settings.

Your changes take effect when the computer restarts.

8 Backing up, restoring, and recovering

This chapter provides information about the following processes, which are standard procedure for most products:

- **Backing up your personal information**—You can use Windows tools to back up your personal information (see [Using Windows tools on page 55](#)).
- **Creating a restore point**—You can use Windows tools to create a restore point (see [Using Windows tools on page 55](#)).
- **Creating recovery media** (select products only)—You can use the HP Cloud Recovery Download Tool (select products only) to create recovery media (see [Using the HP Cloud Recovery Download Tool to create recovery media \(select products only\) on page 55](#)).
- **Restoring and recovery**—Windows offers several options for restoring from backup, refreshing the computer, and resetting the computer to its original state (see [Using Windows tools on page 55](#)).

 **IMPORTANT:** If you will be performing recovery procedures on a tablet, the tablet battery must be at least 70% charged before you start the recovery process.

IMPORTANT: For a tablet with a detachable keyboard, connect the tablet to the keyboard base before beginning any recovery process.

Backing up information and creating recovery media

Using Windows tools

 **IMPORTANT:** Windows is the only option that allows you to back up your personal information. Schedule regular backups to avoid information loss.

You can use Windows tools to back up personal information and create system restore points and recovery media.

 **NOTE:** If computer storage is 32 GB or less, Microsoft System Restore is disabled by default.

For more information and steps, see the Get Help app.

1. Select the **Start** button, and then select the **Get Help** app.
2. Enter the task you want to perform.

 **NOTE:** You must be connected to the Internet to access the Get Help app.

Using the HP Cloud Recovery Download Tool to create recovery media (select products only)

You can use the HP Cloud Recovery Download Tool to create HP Recovery media on a bootable USB flash drive.

To download the tool:

- ▲ Go to the Microsoft Store and search for HP Cloud Recovery.

For details, go to <http://www.hp.com/support>, search for HP Cloud Recovery, and then select "HP PCs – Using the Cloud Recovery Tool (Windows 10, 7)."



NOTE: If you cannot create recovery media yourself, contact support to obtain recovery discs. Go to <http://www.hp.com/support>, select your country or region, and then follow the on-screen instructions.

Restoring and recovery

Restoring, resetting, and refreshing using Windows tools

Windows offers several options for restoring, resetting, and refreshing the computer. For details, see [Using Windows tools on page 55](#).

Recovering using HP Recovery media

HP Recovery media is used to recover the original operating system and software programs that were installed at the factory. On select products, it can be created on a bootable USB flash drive using the HP Cloud Recovery Download Tool. For details, see [Using the HP Cloud Recovery Download Tool to create recovery media \(select products only\) on page 55](#).



NOTE: If you cannot create recovery media yourself, contact support to obtain recovery discs. Go to <http://www.hp.com/support>, select your country or region, and then follow the on-screen instructions.

To recover your system:

- ▲ Insert the HP Recovery media, and then restart the computer.

Changing the computer boot order

If your computer does not restart using the HP Recovery media, you can change the computer boot order. This is the order of devices listed in BIOS where the computer looks for startup information. You can change the selection to an optical drive or a USB flash drive, depending on the location of your HP Recovery media.

To change the boot order:



IMPORTANT: For a tablet with a detachable keyboard, connect the tablet to the keyboard base before beginning these steps.

1. Insert the HP Recovery media.
2. Access the system **Startup** menu.

For computers or tablets with keyboards attached:

- ▲ Turn on or restart the computer or tablet, quickly press **esc**, and then press **f9** for boot options.

For tablets without keyboards:

- ▲ Turn on or restart the tablet, quickly hold down the volume up button, and then select **f9**.

– or –

Turn on or restart the tablet, quickly hold down the volume down button, and then select **f9**.

3. Select the optical drive or USB flash drive from which you want to boot, and then follow the on-screen instructions.

9 Specifications

Table 9-1 Specifications

	Metric	U.S.
Computer dimensions		
Width	28.15 cm	11.08 in
Depth	19.28 cm	7.59 in
Height	1.68 cm	0.66 in
Weight	1.08 kg	2.38 lbs
Input power		
	Rating	
Operating voltage and current	19.5 V dc @ 2.31 A – 45 W 19.5 V dc @ 3.33 A – 65 W	
Temperature		
Operating	5°C to 35°C	41°F to 95°F
Nonoperating	-20°C to 60°C	-4°F to 140°F
Relative humidity (noncondensing)		
Operating	10% to 90%	
Nonoperating	5% to 95%	
Maximum altitude (unpressurized)		
Operating	-15 m to 3,048 m	-50 ft to 10,000 ft
Nonoperating	-15 m to 12,192 m	-50 ft to 40,000 ft
NOTE: Applicable product safety standards specify thermal limits for plastic surfaces. The device operates well within this range of temperatures.		

10 Power cord set requirements

The wide-range input feature of the computer permits it to operate from any line voltage from 100 to 120 V ac, or from 220 to 240 V ac.

The 3-conductor power cord set included with the computer meets the requirements for use in the country or region where the equipment is purchased.

Power cord sets for use in other countries or regions must meet the requirements of the country and region where the computer is used.

Requirements for all countries

The following requirements are applicable to all countries and regions:

- The length of the power cord set must be at least **1.0 m** (3.3 ft) and no more than **2.0 m** (6.5 ft).
- All power cord sets must be approved by an acceptable accredited agency responsible for evaluation in the country or region where the power cord set will be used.
- The power cord sets must have a minimum current capacity of 10 A and a nominal voltage rating of 125 or 250 V ac, as required by the power system of each country or region.
- The appliance coupler must meet the mechanical configuration of an EN 60 320/IEC 320 Standard Sheet C13 connector for mating with the appliance inlet on the back of the computer.

Requirements for specific countries and regions

Table 10-1 Power cord requirements for specific countries and regions

Country/region	Accredited agency	Applicable note number
Argentina	IRAM	1
Australia	SAA	1
Austria	OVE	1
Belgium	CEBEC	1
Brazil	ABNT	1
Canada	CSA	2
Chile	IMQ	1
Denmark	DEMKO	1
Finland	FIMKO	1
France	UTE	1
Germany	VDE	1
India	BIS	1
Israel	SII	1
Italy	IMQ	1
Japan	JIS	3
The Netherlands	KEMA	1
New Zealand	SANZ	1
Norway	NEMKO	1
The People's Republic of China	CCC	4
Saudi Arabia	SASO	7
Singapore	PSB	1
South Africa	SABS	1
South Korea	KTL	5
Sweden	SEMKO	1
Switzerland	SEV	1
Taiwan	BSMI	6
Thailand	TISI	1
The United Kingdom	ASTA	1
The United States	UL	2

1. The flexible cord must be Type H05VV-F, 3-conductor, 0.75 mm² conductor size. Power cord set fittings (appliance coupler and wall plug) must bear the certification mark of the agency responsible for evaluation in the country or region where it will be used.

Table 10-1 Power cord requirements for specific countries and regions (continued)

Country/region	Accredited agency	Applicable note number
		2. The flexible cord must be Type SVT/SJT or equivalent, No. 18 AWG, 3-conductor. The wall plug must be a two-pole grounding type with a NEMA 5-15P (15 A, 125 V ac) or NEMA 6-15P (15 A, 250 V ac) configuration. CSA or C-UL mark. UL file number must be on each element.
		3. The appliance coupler, flexible cord, and wall plug must bear a “T” mark and registration number in accordance with the Japanese Dentori Law. The flexible cord must be Type VCTF, 3-conductor, 0.75 mm ² or 1.25 mm ² conductor size. The wall plug must be a two-pole grounding type with a Japanese Industrial Standard C8303 (7 A, 125 V ac) configuration.
		4. The flexible cord must be Type RVV, 3-conductor, 0.75 mm ² conductor size. Power cord set fittings (appliance coupler and wall plug) must bear the CCC certification mark.
		5. The flexible cord must be Type H05VV-F 3-conductor, 0.75 mm ² conductor size. KTL logo and individual approval number must be on each element. Corset approval number and logo must be printed on a flag label.
		6. The flexible cord must be Type HVCTF 3-conductor, 1.25 mm ² conductor size. Power cord set fittings (appliance coupler, cable, and wall plug) must bear the BSMI certification mark.
		7. For 127 V ac, the flexible cord must be Type SVT or SJT 3-conductor, 18 AWG, with plug NEMA 5-15P (15 A, 125 V ac), with UL and CSA or C-UL marks. For 240 V ac, the flexible cord must be Type H05VV-F 3-conductor, 0.75 mm ² or 1.00 mm ² conductor size, with plug BS 1363/A with BSI or ASTA marks.

11 Recycling

When a non-rechargeable or rechargeable battery has reached the end of its useful life, do not dispose of the battery in general household waste. Follow the local laws and regulations in your area for battery disposal.

HP encourages customers to recycle used electronic hardware, HP original print cartridges, and rechargeable batteries. For more information about recycling programs, see the HP Web site at <http://www.hp.com/recycle>.

Index

- A**
 - AC adapter and battery light, identifying 4
 - AC adapter, spare part numbers 16
 - action keys
 - identifying 10
 - antenna
 - removal 43
 - spare part numbers 16, 44
 - audio, product description 1
 - audio-out (headphone)/audio-in (microphone) combo jack, identifying 5
- B**
 - backup, creating 55
 - backups 55
 - base enclosure, spare part numbers 14
 - battery
 - removal 30
 - spare part number 13, 30
 - BIOS
 - determining version 48
 - downloading an update 49
 - starting the Setup Utility 48
 - updating 48
 - Bluetooth label 11
 - boot order, changing 56
 - buttons
 - power 9
- C**
 - camera
 - identifying 6
 - camera light, identifying 6
 - caps lock light, identifying 8
 - cautions
 - electrostatic discharge 18
 - components
 - display 6
 - keyboard area 7
 - left side 5
 - right side 4
 - computer major components 12
 - connector board cable, spare part number 13
 - connector, power 4
 - control zone 7
- D**
 - display assembly
 - removal 37
 - subcomponents 15
 - display bezel
 - removal 38
 - spare part numbers 15, 38
 - display components 6
 - display enclosure, spare part number 16
 - display hinge
 - removal 42
 - Display Hinge Kit, spare part number 16, 42
 - display panel
 - product description 1
 - removal 40
 - spare part numbers 15, 42
 - display panel cable
 - removal 42
 - spare part number 16, 43
- E**
 - electrostatic discharge (ESD) 18
 - preventing damage 19
 - esc key, identifying 10
- F**
 - fn key, identifying 10
- G**
 - graphics, product description 1
 - grounding methods 20
 - guidelines
 - packaging 21
 - transporting 21
 - workstation 18
- H**
 - HDMI port
 - identifying 4
 - heat sink
 - removal 35
 - spare part number 13, 35
 - hinge
 - spare part number 16, 42
 - hinge cover
 - spare part numbers 15
 - HP PC Hardware Diagnostics UEFI
 - downloading 52
 - starting 52
 - using 51
 - HP PC Hardware Diagnostics Windows
 - downloading 50
 - installing 51
 - using 50
 - HP Recovery media
 - recovery 56
- I**
 - internal card expansion, product description 2
 - internal microphones, identifying 6
- J**
 - jacks
 - audio-out (headphone)/audio-in (microphone) 5
- K**
 - keyboard hook
 - removal 29
 - spare part number 29
 - keyboard/top cover
 - removal 22
 - spare part numbers 13, 22
 - keys
 - action 10
 - esc 10
 - fn 10
 - Windows 10

L

labels

- Bluetooth 11
- regulatory 11
- serial number 11
- service 11
- wireless certification 11
- WLAN 11

left control zone, identifying 7

left side components 5

lights

- AC adapter and battery light 4
- camera 6
- caps lock 8
- mute 8
- power 5

M

media card reader, product description 2

memory, product description 1

microphone

product description 1

microSD memory card reader, identifying 4

microSD memory card, identifying 4

model name 1

mute light, identifying 8

O

operating system, product description 2

P

packaging guidelines 21

ports

- HDMI 4
- product description 2
- USB SuperSpeed 4, 5
- USB Type-C 4

power button board

- removal 28
- spare part number 13, 28

power button board cable, spare part number 13, 28

power button, identifying 9

power connector cable

- removal 47
- spare part number 13, 47

power connector, identifying 4

power cord

requirements for all countries 58

requirements for specific countries and regions 59

set requirements 58

spare part numbers 16

power lights, identifying 5

power requirements, product description 2

processor, product description 1

product description

- audio 1
- display panel 1
- graphics 1
- internal card expansion 2
- media card reader 2
- memory 1
- microphone 1
- operating system 2
- ports 2
- power requirements 2
- processors 1
- product name 1
- serviceability 3
- storage 1
- video 1
- wireless 1

product name 1

product name and number, computer 11

R

recovery 55

discs 56

HP Recovery partition 56

media 56

USB flash drive 56

recovery media

- creating using HP Cloud Recovery Download Tool 55
- creating using Windows tools 55

regulatory information

- regulatory label 11
- wireless certification labels 11

Remote HP PC Hardware Diagnostics

UEFI settings

- customizing 53
- using 53

removal/replacement procedures 22

restoring 55

right control zone, identifying 7

right side components 4

Rubber Kit, spare part numbers 14

S

Screw Kit, spare part number 16

security cable slot, identifying 5

serial number, computer 11

service labels, locating 11

serviceability, product description 3

slots

- microSD memory card reader 4
- security cable 5

speakers

- identifying 9
- removal 33
- spare part number 13, 33

special keys, using 10

static electricity 19

storage, product description 1

system board

- removal 45
 - spare part numbers 45
- system restore point, creating 55

T

thermal plate

- removal 35
- spare part number 13, 35

touchpad board

- removal 26
- spare part numbers 13, 26

touchpad board cable, spare part number 13, 26

touchpad zone, identifying 7

transporting guidelines 21

traveling with the computer 11

U

USB SuperSpeed port, identifying 4, 5

USB Type-C port, identifying 4

USB/audio board

- removal 34
- spare part numbers 13, 34

USB/audio board cable, spare part number 34

V

video, product description 1

W

webcam/microphone module

removal 39

spare part number 15, 40

Windows

backup 55

recovery media 55

system restore point 55

Windows key, identifying 10

Windows tools, using 55

wireless antenna

removal 43

spare part numbers 16, 44

wireless certification label 11

wireless, product description 1

WLAN antenna

removal 43

spare part number 16, 44

WLAN antennas, identifying 6

WLAN device 11

WLAN label 11

WLAN module

removal 31

spare part numbers 13, 31

workstation guidelines 18