

Inspiron 7380

Service Manual



Notes, cautions, and warnings

 | **NOTE:** A NOTE indicates important information that helps you make better use of your product.

 | **CAUTION:** A CAUTION indicates either potential damage to hardware or loss of data and tells you how to avoid the problem.

 | **WARNING:** A WARNING indicates a potential for property damage, personal injury, or death.

© 2018 Dell Inc. or its subsidiaries. All rights reserved. Dell, EMC, and other trademarks are trademarks of Dell Inc. or its subsidiaries. Other trademarks may be trademarks of their respective owners.

Contents

1 Before working inside your computer	7
Before you begin	7
Safety instructions.....	7
Recommended tools.....	7
Screw list.....	8
2 After working inside your computer	9
3 Removing the base cover	10
Procedure.....	10
4 Replacing the base cover	12
Procedure.....	12
5 Removing the battery	14
Prerequisites.....	14
Procedure.....	14
6 Replacing the battery	15
Procedure.....	15
Post-requisites.....	16
7 Removing the coin-cell battery	17
Prerequisites.....	17
Procedure.....	17
8 Replacing the coin-cell battery	18
Procedure.....	18
Post-requisites.....	18
9 Removing the heat sink	19
Prerequisites.....	19
Procedure.....	19
10 Replacing the heat sink	20
Procedure.....	20
Post-requisites.....	20
11 Removing the fan	21
Prerequisites.....	21
Procedure.....	21
12 Replacing the fan	22
Procedure.....	22

Post-requisites.....	22
13 Removing the speakers.....	23
Prerequisites.....	23
Procedure.....	23
14 Replacing the speakers.....	24
Procedure.....	24
Post-requisites.....	24
15 Removing the power-adapter port.....	25
Prerequisites.....	25
Procedure.....	25
16 Replacing the power-adapter port.....	26
Procedure.....	26
Post-requisites.....	26
17 Removing the wireless card.....	27
Prerequisites.....	27
Procedure.....	27
18 Replacing the wireless card.....	29
Procedure.....	29
Post-requisites.....	29
19 Removing the display assembly.....	30
Prerequisites.....	30
Procedure.....	30
20 Replacing the display assembly.....	32
Procedure.....	32
Post-requisites.....	33
21 Removing the I/O board.....	34
Prerequisites.....	34
Procedure.....	34
22 Replacing the I/O board.....	36
Procedure.....	36
Post-requisites.....	37
23 Removing the solid-state drive.....	38
Prerequisites.....	38
Procedure.....	38
24 Replacing the solid-state drive.....	39
Procedure.....	39

Post-requisites.....	39
25 Removing the system board.....	40
Prerequisites.....	40
Procedure.....	40
26 Replacing the system board.....	43
Procedure.....	43
Post-requisites.....	45
27 Removing the status-light board.....	46
Prerequisites.....	46
Procedure.....	46
28 Replacing the status-light board.....	47
Procedure.....	47
Post-requisites.....	47
29 Removing the touchpad.....	48
Prerequisites.....	48
Procedure.....	48
30 Replacing the touchpad.....	50
Procedure.....	50
Post-requisites.....	51
31 Removing the power button with fingerprint reader.....	52
Prerequisites.....	52
Procedure.....	52
32 Replacing the power button with fingerprint reader.....	54
Procedure.....	54
Post-requisites.....	55
33 Removing the keyboard.....	56
Prerequisites.....	56
Procedure.....	56
34 Replacing the keyboard.....	58
Procedure.....	58
Post-requisites.....	59
35 Removing the palm-rest assembly.....	60
Prerequisites.....	60
Procedure.....	60
36 Replacing the palm-rest assembly.....	61
Procedure.....	61

Post-requisites.....	61
37 Downloading drivers.....	62
Downloading the audio driver.....	62
Downloading the graphics driver.....	62
Downloading the USB 3.0 driver.....	62
Downloading the Wi-Fi driver.....	63
Downloading the media-card reader driver.....	63
Downloading the chipset driver.....	63
Downloading the network driver.....	63
38 System setup.....	65
Boot Sequence.....	65
Navigation keys.....	65
BIOS overview.....	65
Entering BIOS setup program.....	66
System setup options.....	66
System and setup password.....	71
Assigning a system setup password.....	71
Deleting or changing an existing system setup password.....	72
Clearing CMOS settings.....	72
Clearing BIOS (System Setup) and System passwords.....	72
39 Troubleshooting.....	73
Flashing the BIOS.....	73
Enhanced Pre-Boot System Assessment (ePSA) diagnostics.....	73
Running the ePSA Diagnostics.....	73
Diagnostics.....	74
Flea power release.....	75
Wi-Fi power cycle.....	75
40 Getting help and contacting Dell.....	76
Self-help resources.....	76
Contacting Dell.....	76

Before working inside your computer

NOTE: The images in this document may differ from your computer depending on the configuration you ordered.

Before you begin

- 1 Save and close all open files and exit all open applications.
- 2 Shut down your computer. Click **Start** > **Power** > **Shut down**.

NOTE: If you are using a different operating system, see the documentation of your operating system for shut-down instructions.

- 3 Disconnect your computer and all attached devices from their electrical outlets.
- 4 Disconnect all attached network devices and peripherals, such as keyboard, mouse, and monitor from your computer.
- 5 Remove any media card and optical disc from your computer, if applicable.

Safety instructions

Use the following safety guidelines to protect your computer from potential damage and ensure your personal safety.

- WARNING:** Before working inside your computer, read the safety information that shipped with your computer. For more safety best practices, see the Regulatory Compliance home page at www.dell.com/regulatory_compliance.
- WARNING:** Disconnect all power sources before opening the computer cover or panels. After you finish working inside the computer, replace all covers, panels, and screws before connecting to the electrical outlet.
- CAUTION:** To avoid damaging the computer, ensure that the work surface is flat and clean.
- CAUTION:** To avoid damaging the components and cards, handle them by their edges, and avoid touching pins and contacts.
- CAUTION:** You should only perform troubleshooting and repairs as authorized or directed by the Dell technical assistance team. Damage due to servicing that is not authorized by Dell is not covered by your warranty. See the safety instructions that shipped with the product or at www.dell.com/regulatory_compliance.
- CAUTION:** Before touching anything inside your computer, ground yourself by touching an unpainted metal surface, such as the metal at the back of the computer. While you work, periodically touch an unpainted metal surface to dissipate static electricity, which could harm internal components.
- CAUTION:** When you disconnect a cable, pull on its connector or on its pull tab, not on the cable itself. Some cables have connectors with locking tabs or thumb-screws that you must disengage before disconnecting the cable. When disconnecting cables, keep them evenly aligned to avoid bending any connector pins. When connecting cables, ensure that the ports and connectors are correctly oriented and aligned.
- CAUTION:** Press and eject any installed card from the media-card reader.

Recommended tools

















The procedures in this document may require the following tools:

- Philips screwdriver
- Torx #8 (T8) screwdriver
- Plastic scribe

Screw list

NOTE: Screw color may vary with the configuration ordered.

Table 1. Screw list

Component	Secured to	Screw type	Quantity	Screw image
Bottom cover	Palm-rest assembly	M2.5x5	9	
Battery	Palm-rest assembly	M2x3	4	
Fan	Keyboard bracket	M2x3	2	
Wireless card	Keyboard bracket	M2x3	1	
Power-adaptor port	Palm-rest assembly	M2x3	1	
Display assembly	Palm-rest assembly	M2.5x5	6	
I/O Board	Keyboard bracket	M2x2	2	
Power button with fingerprint reader (if installed)	Palm-rest assembly	M2x2.5	2	
Solid-state drive	Keyboard bracket	M2x3	1	
Type-C port bracket	System board	M2x3	1	
	Palm-rest assembly	M2x3	1	
Touchpad	Palm-rest assembly	M2x2.5	4	
Touchpad bracket	Palm-rest assembly	M2x2.5	3	
System board	Keyboard bracket	M2x2	2	
Keyboard bracket	Keyboard Palm-rest assembly	M1.4x2	27	
Keyboard	Palm-rest assembly	M1.2x1.5	6	

After working inside your computer

 **CAUTION:** Leaving stray or loose screws inside your computer may severely damage your computer.

- 1 Replace all screws and ensure that no stray screws remain inside your computer.
- 2 Connect any external devices, peripherals, or cables you removed before working on your computer.
- 3 Replace any media cards, discs, or any other parts that you removed before working on your computer.
- 4 Connect your computer and all attached devices to their electrical outlets.
- 5 Turn on your computer.

Removing the base cover

⚠ WARNING: Before working inside your computer, read the safety information that shipped with your computer and follow the steps in [Before working inside your computer](#). After working inside your computer, follow the instructions in [After working inside your computer](#). For more safety best practices, see the Regulatory Compliance home page at www.dell.com/regulatory_compliance.

Procedure

- 1 Loosen the captive screw that secures the base cover to the palm-rest assembly.
- 2 Remove the nine screws (M2.5x5) that secure the base cover to the palm-rest assembly.

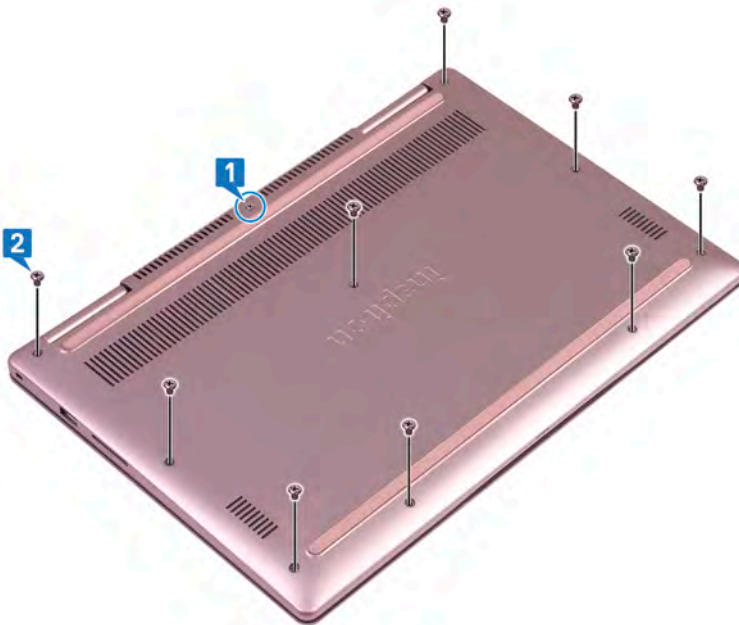

- 3 Using a plastic scribe, pry the base cover off the palm-rest assembly.
- 4 Lift the base cover off the palm-rest assembly.

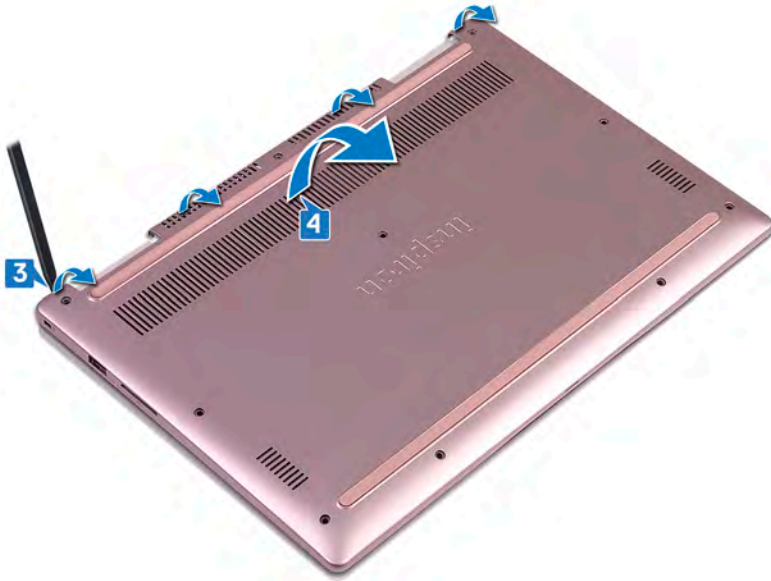

- 5 Using the pull tab, disconnect the battery cable from the system board.
- 6 Turn the computer over, open the display, then press and hold the power button for 15 seconds to ground the system board.

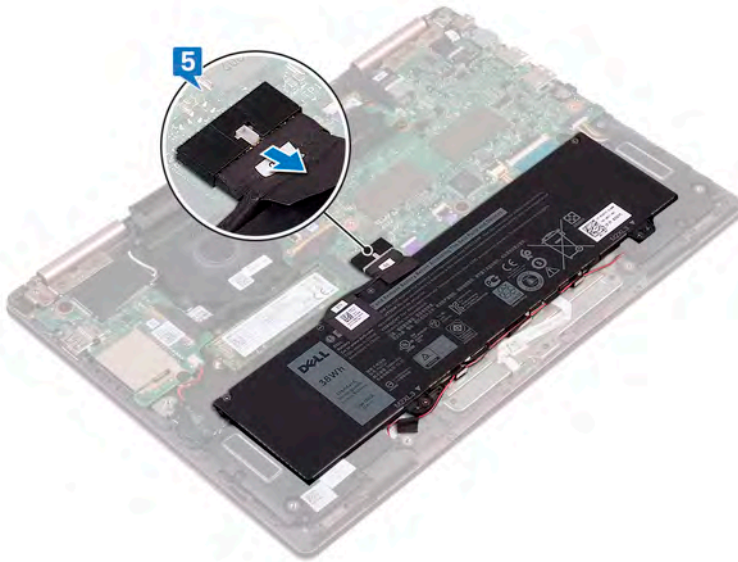

Replacing the base cover

⚠ WARNING: Before working inside your computer, read the safety information that shipped with your computer and follow the steps in [Before working inside your computer](#). After working inside your computer, follow the instructions in [After working inside your computer](#). For more safety best practices, see the Regulatory Compliance home page at www.dell.com/regulatory_compliance.

Procedure

- 1 Ensure that the battery cable is connected to the system board.

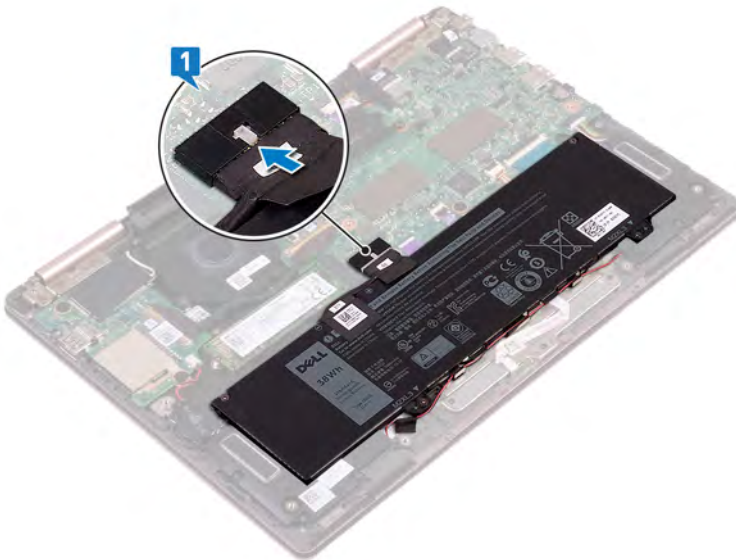

- 2 Align the tabs on the base cover with the slots on the palm-rest assembly and snap the base cover into place.

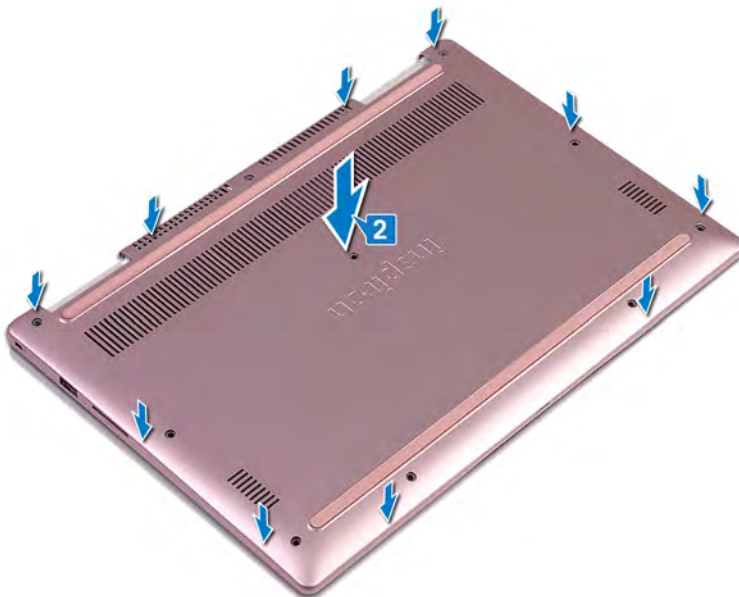

- 3 Replace the nine screws (M2.5x5) that secure the base cover to the palm-rest assembly.
- 4 Tighten the captive screw that secures the base cover to the palm-rest assembly.

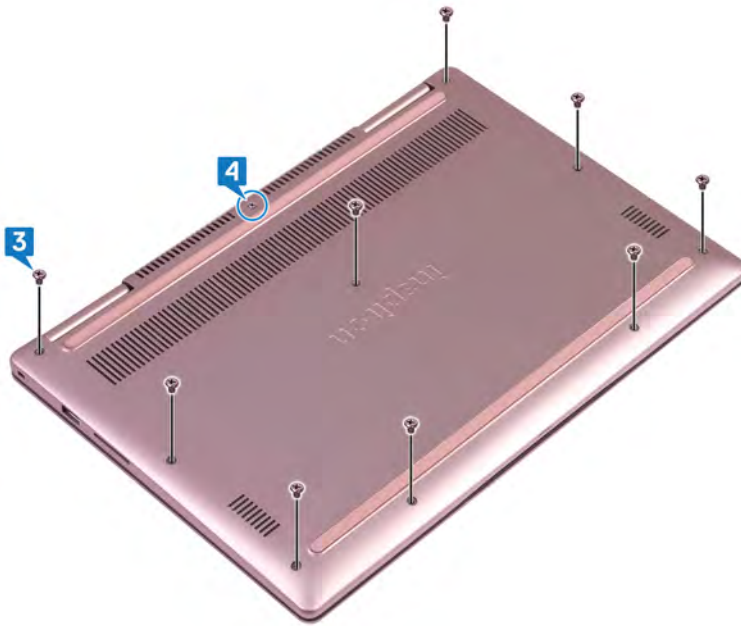

Removing the battery

⚠ WARNING: Before working inside your computer, read the safety information that shipped with your computer and follow the steps in [Before working inside your computer](#). After working inside your computer, follow the instructions in [After working inside your computer](#). For more safety best practices, see the Regulatory Compliance home page at www.dell.com/regulatory_compliance.

Prerequisites

Remove the [base cover](#).

Procedure

- 1 Remove the speaker cable from the routing guides on the battery.
- 2 Remove the four screws (M2x3) that secure the battery to the palm-rest assembly.
- 3 Lift the battery off the palm-rest assembly.

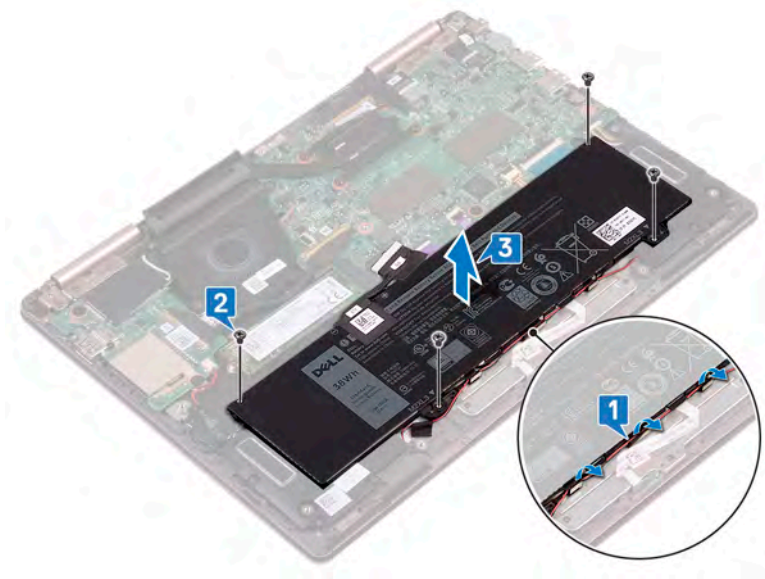

Replacing the battery

⚠ WARNING: Before working inside your computer, read the safety information that shipped with your computer and follow the steps in [Before working inside your computer](#). After working inside your computer, follow the instructions in [After working inside your computer](#). For more safety best practices, see the Regulatory Compliance home page at www.dell.com/regulatory_compliance.

Procedure

- 1 Align the screw holes on the battery with the screw holes on the palm-rest assembly.
- 2 Replace the four screws (M2x3) that secure the battery to the palm-rest assembly.
- 3 Route the speaker cable through the routing guides on the battery.

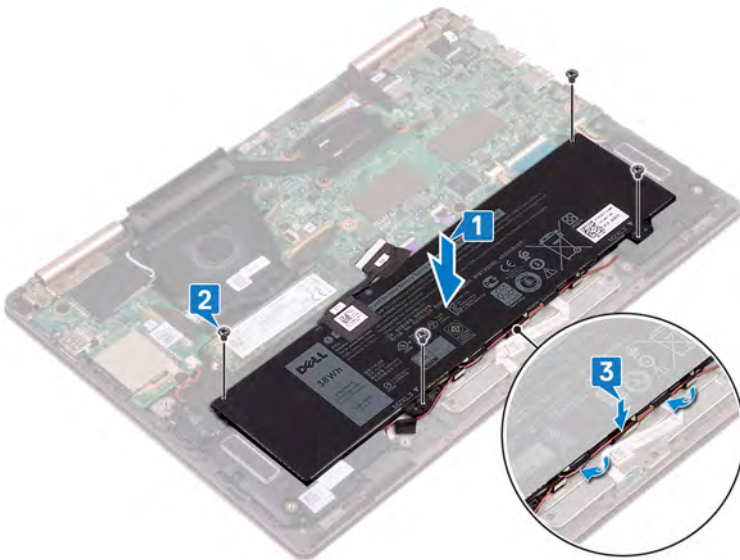

- 4 Reconnect the battery cable to the system board..

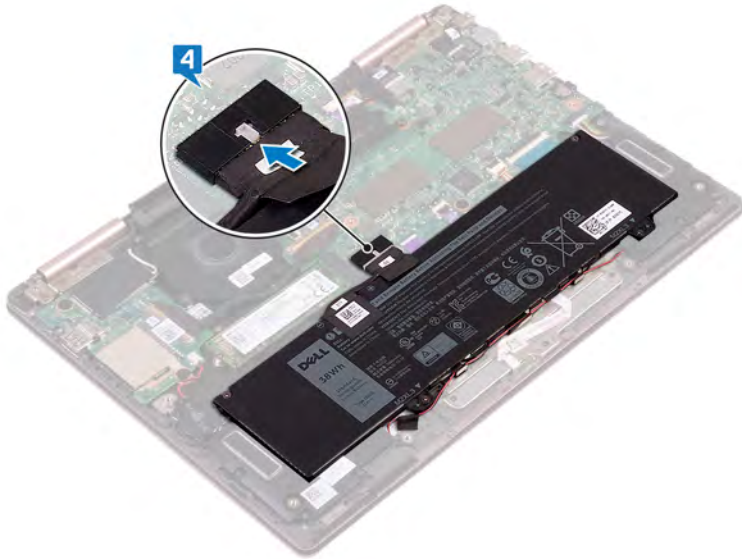

Post-requisites

Replace the [base cover](#).

Removing the coin-cell battery

⚠ WARNING: Before working inside your computer, read the safety information that shipped with your computer and follow the steps in [Before working inside your computer](#). After working inside your computer, follow the instructions in [After working inside your computer](#). For more safety best practices, see the Regulatory Compliance home page at www.dell.com/regulatory_compliance.

⚠ CAUTION: Removing the coin-cell battery resets the BIOS setup program's settings to default. It is recommended that you note the BIOS setup program's settings before removing the coin-cell battery.

Prerequisites

Remove the [base cover](#).

Procedure

- 1 Disconnect the coin-cell battery cable from the I/O board.
- 2 Peel the coin-cell battery off the keyboard bracket.

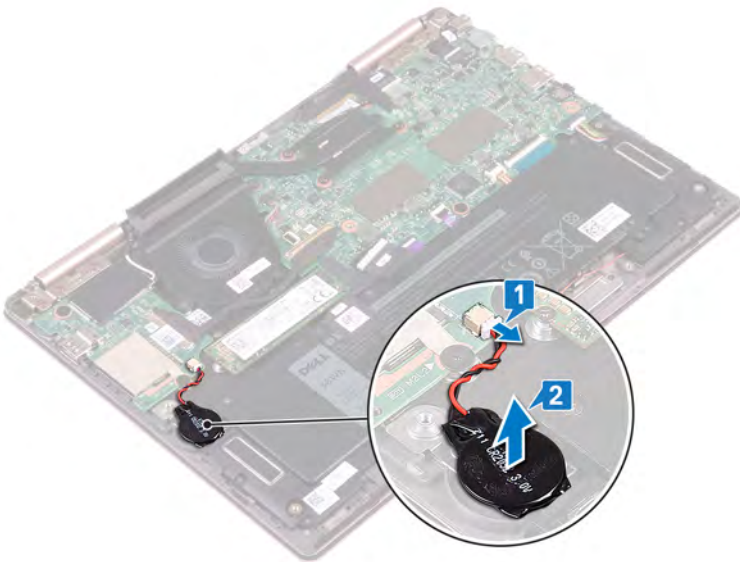

Replacing the coin-cell battery

⚠ WARNING: Before working inside your computer, read the safety information that shipped with your computer and follow the steps in [Before working inside your computer](#). After working inside your computer, follow the instructions in [After working inside your computer](#). For more safety best practices, see the Regulatory Compliance home page at www.dell.com/regulatory_compliance.

Procedure

- 1 Adhere the coin-cell battery to the keyboard bracket.
- 2 Connect the coin-cell battery cable to the I/O board.

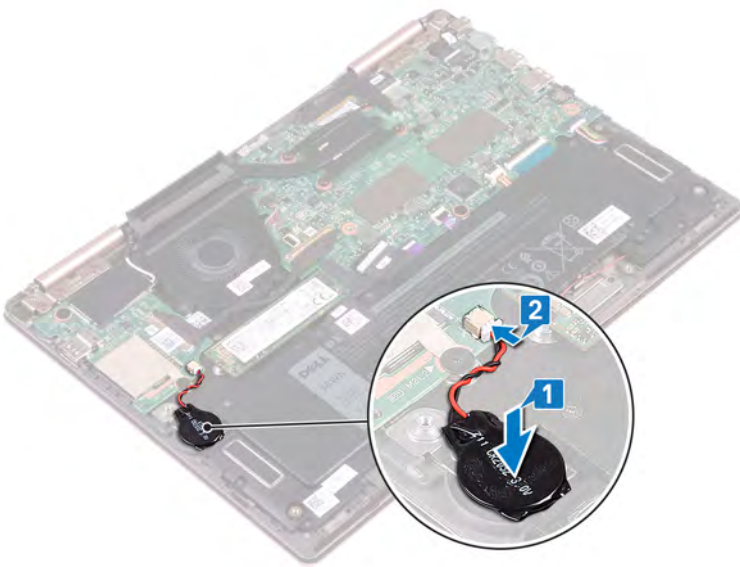

Post-requisites

Replace the [base cover](#).

Removing the heat sink

- ⚠ WARNING:** Before working inside your computer, read the safety information that shipped with your computer and follow the steps in [Before working inside your computer](#). After working inside your computer, follow the instructions in [After working inside your computer](#). For more safety best practices, see the Regulatory Compliance home page at www.dell.com/regulatory_compliance.
- ⚠ WARNING:** The heat sink may become hot during normal operation. Allow sufficient time for the heat sink to cool before you touch it.
- ⚠ CAUTION:** For maximum cooling of the processor, do not touch the heat transfer areas on the heat sink. The oils in your skin can reduce the heat transfer capability of the thermal grease.

Prerequisites

Remove the [base cover](#).

Procedure

- 1 In sequential order (indicated on the heat-sink), loosen the four captive screws that secure the heat sink to the system board.
- 2 Lift the heat sink off the system board.

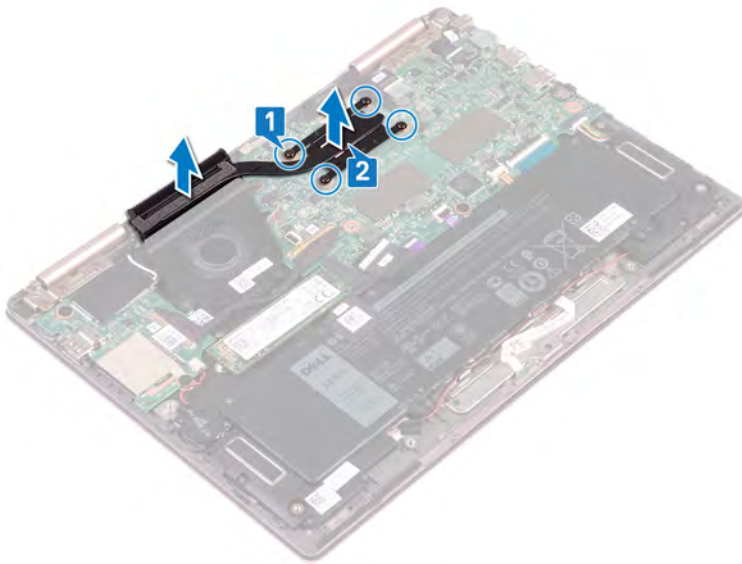

Replacing the heat sink

⚠ WARNING: Before working inside your computer, read the safety information that shipped with your computer and follow the steps in [Before working inside your computer](#). After working inside your computer, follow the instructions in [After working inside your computer](#). For more safety best practices, see the Regulatory Compliance home page at www.dell.com/regulatory_compliance.

⚠ CAUTION: Incorrect alignment of the heat sink can damage the system board and processor.

ⓘ NOTE: If either the system board or the heat sink is replaced, use the thermal pad provided in the kit to ensure that thermal conductivity is achieved.

Procedure

- 1 Align the screw holes on the heat sink with the screw holes on the system board.
- 2 In sequential order (indicated on the heat-sink), tighten the four captive screws that secure the heat sink to the system board.

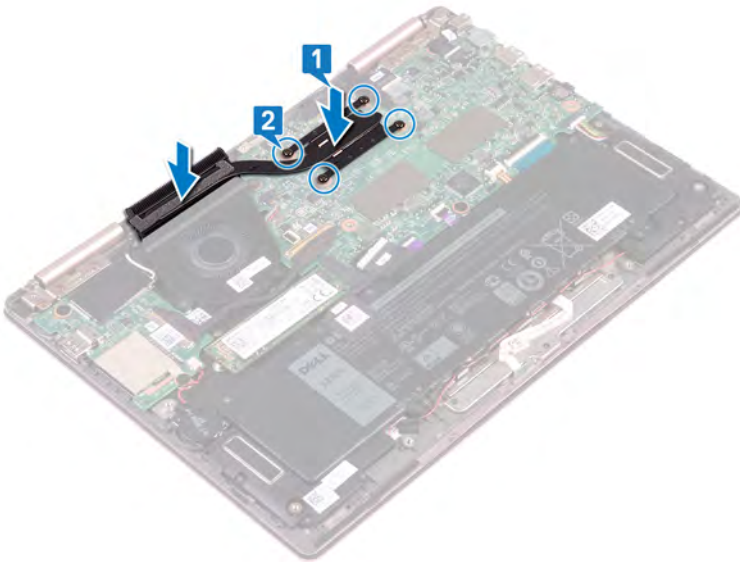

Post-requisites

Replace the [base cover](#).

Removing the fan

⚠ WARNING: Before working inside your computer, read the safety information that shipped with your computer and follow the steps in [Before working inside your computer](#). After working inside your computer, follow the instructions in [After working inside your computer](#). For more safety best practices, see the Regulatory Compliance home page at www.dell.com/regulatory_compliance.

Prerequisites

- 1 Remove the [base cover](#).
- 2 Follow the procedure from step 1 to step 3 in [Removing the power button with fingerprint reader](#). (if installed)

Procedure

- 1 Disconnect the fan cable from the system board.
- 2 Remove the I/O-board cable from the routing guides on the fan.
- 3 Remove the two screws (M2x3) that secure the fan to the keyboard bracket.
- 4 Lift the fan off the keyboard bracket.

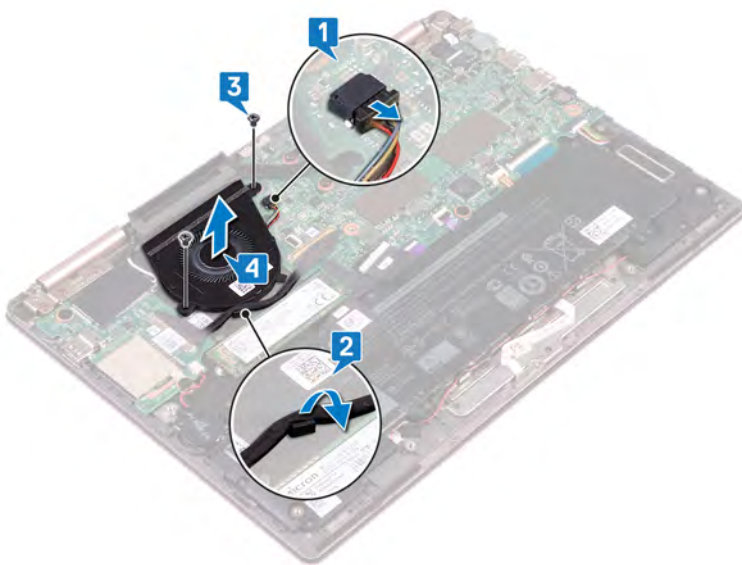

Replacing the fan

⚠ WARNING: Before working inside your computer, read the safety information that shipped with your computer and follow the steps in [Before working inside your computer](#). After working inside your computer, follow the instructions in [After working inside your computer](#). For more safety best practices, see the Regulatory Compliance home page at www.dell.com/regulatory_compliance.

Procedure

- 1 Align the screw holes on the fan with the screw holes on the keyboard bracket.
- 2 Replace the two screws (M2x3) securing the fan to the keyboard bracket.
- 3 Route the I/O-board cables through the routing guides on the fan.
- 4 Connect the fan cable to the system board.

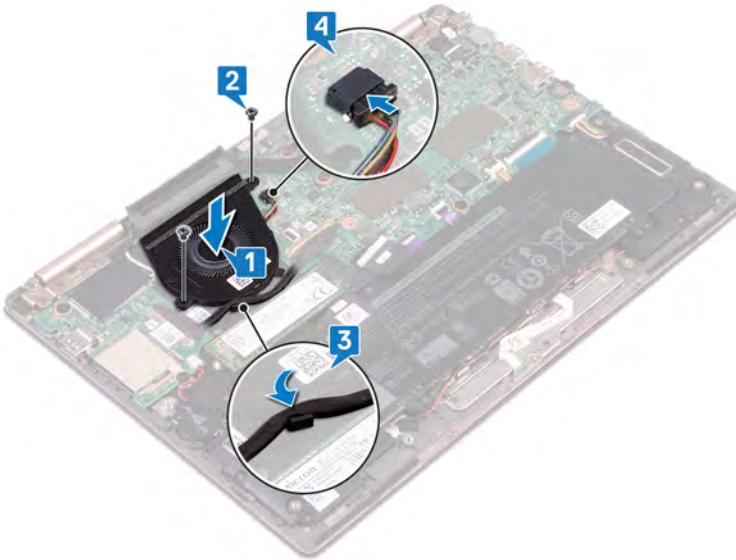

Post-requisites

- 1 Follow the procedure from step 3 to step 5 in [Replacing the power button with fingerprint reader](#). (if installed)
- 2 Replace the [base cover](#).

Removing the speakers

⚠ WARNING: Before working inside your computer, read the safety information that shipped with your computer and follow the steps in [Before working inside your computer](#). After working inside your computer, follow the instructions in [After working inside your computer](#). For more safety best practices, see the Regulatory Compliance home page at www.dell.com/regulatory_compliance.

Prerequisites

Remove the [base cover](#).

Procedure

- 1 Disconnect the speaker cable from the system board.
- 2 Lift the left speaker off the palm-rest assembly.
- 3 Remove the speaker cable from the routing guides on the battery.
- 4 Peel off the tape that secures the speaker cable to the palm-rest assembly.
- 5 Lift the right speaker off the palm-rest assembly.

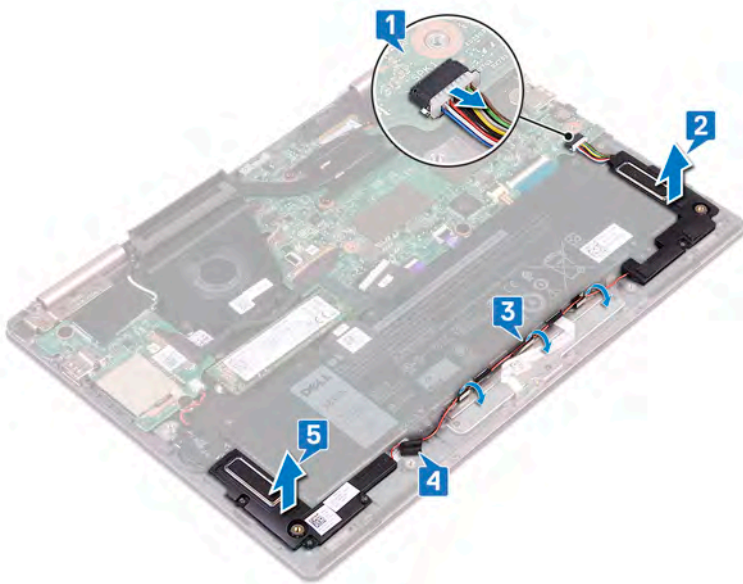

Replacing the speakers

⚠ WARNING: Before working inside your computer, read the safety information that shipped with your computer and follow the steps in [Before working inside your computer](#). After working inside your computer, follow the instructions in [After working inside your computer](#). For more safety best practices, see the Regulatory Compliance home page at www.dell.com/regulatory_compliance.

Procedure

- 1 Using the alignment posts, align and place the right speaker on the palm-rest assembly.
- 2 Adhere the tape that secures the speaker cable to the palm-rest assembly.
- 3 Route the speaker cable through the routing guides on the battery.
- 4 Using the alignment posts, align and place the left speaker on the palm-rest assembly.
- 5 Connect the speaker cable to the system board.

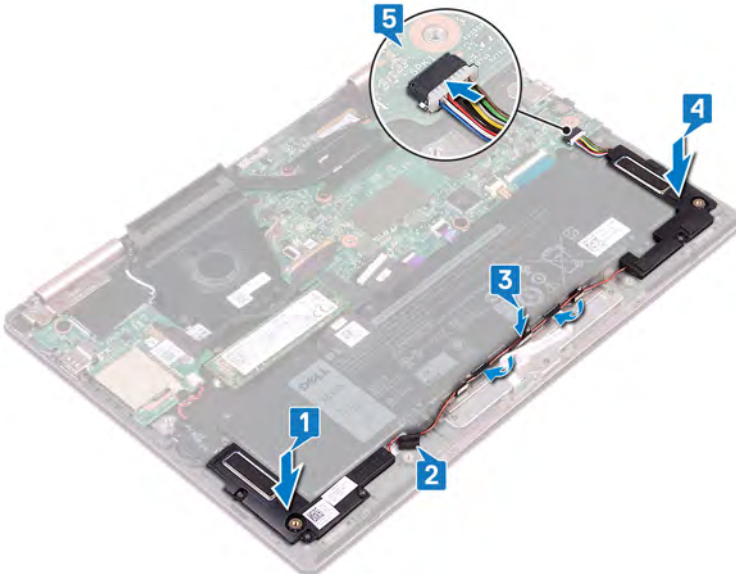

Post-requisites

Replace the [base cover](#).

Removing the power-adapter port

⚠ WARNING: Before working inside your computer, read the safety information that shipped with your computer and follow the steps in [Before working inside your computer](#). After working inside your computer, follow the instructions in [After working inside your computer](#). For more safety best practices, see the Regulatory Compliance home page at www.dell.com/regulatory_compliance.

Prerequisites

Remove the [base cover](#).

Procedure

- 1 Disconnect the power-adapter port cable from the system board.
- 2 Remove the screw (M2x3) that secures the power-adapter port to the palm-rest assembly.
- 3 Lift the power-adapter port off the palm-rest assembly.

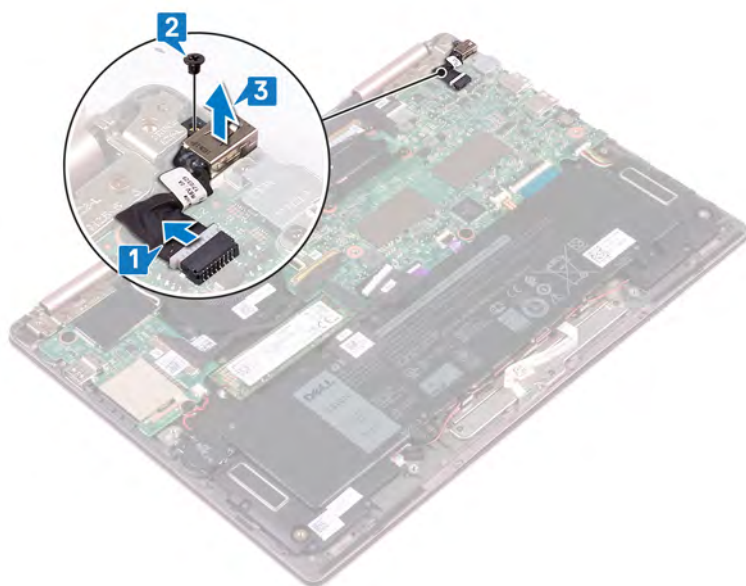

Replacing the power-adapter port

⚠ WARNING: Before working inside your computer, read the safety information that shipped with your computer and follow the steps in [Before working inside your computer](#). After working inside your computer, follow the instructions in [After working inside your computer](#). For more safety best practices, see the Regulatory Compliance home page at www.dell.com/regulatory_compliance.

Procedure

- 1 Insert the power-adapter port into the slot on the palm-rest assembly.
- 2 Replace the screw (M2x3) that secures the power adapter port to the palm-rest assembly.
- 3 Connect the power-adapter port cable to the system board.

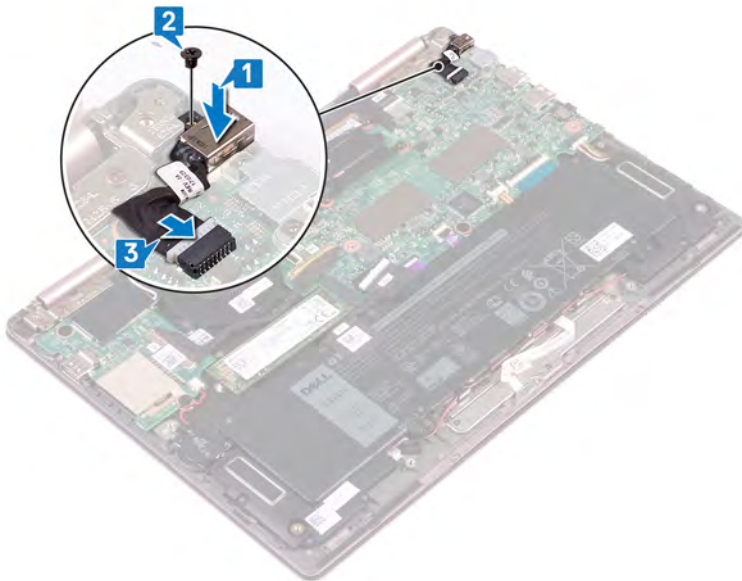

Post-requisites

Replace the [base cover](#).

Removing the wireless card

⚠ WARNING: Before working inside your computer, read the safety information that shipped with your computer and follow the steps in [Before working inside your computer](#). After working inside your computer, follow the instructions in [After working inside your computer](#). For more safety best practices, see the Regulatory Compliance home page at www.dell.com/regulatory_compliance.

Prerequisites

Remove the [base cover](#).

Procedure

- 1 Locate the wireless card on the I/O board and then lift the Mylar from the wireless card.

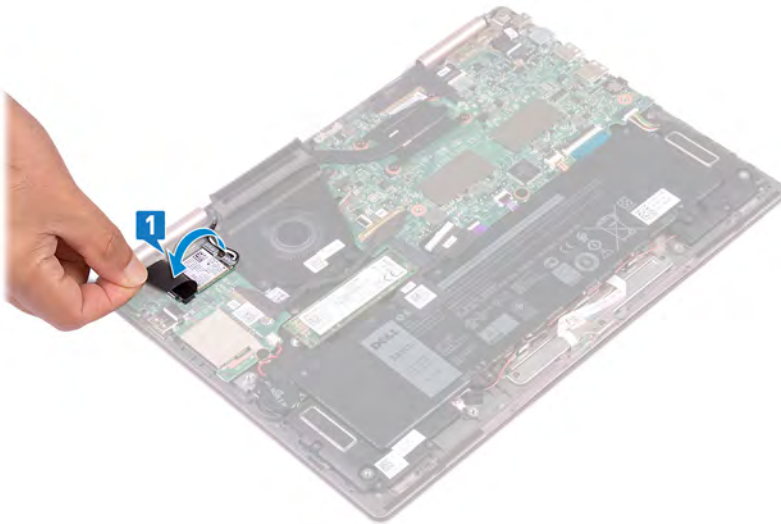

- 2 Remove the screw (M2x3) that secures the wireless-card bracket and wireless card to the keyboard bracket.
- 3 Lift the wireless-card bracket off the wireless card.
- 4 Disconnect the antenna cables from the wireless card.
- 5 Slide and remove the wireless card from the I/O board.

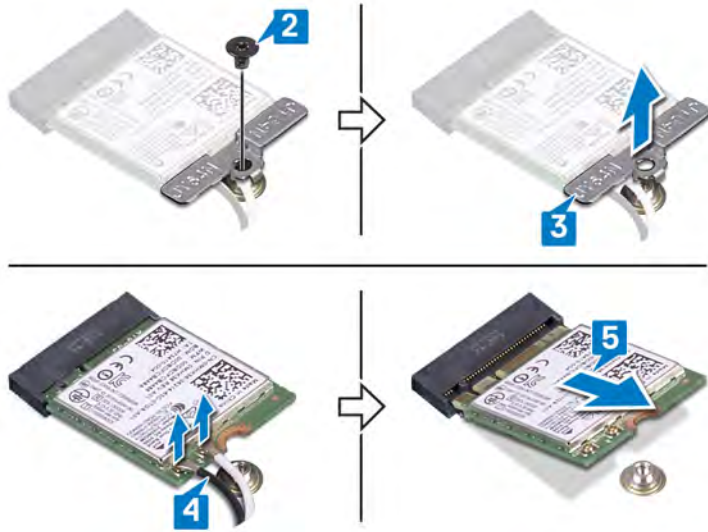

Replacing the wireless card

⚠ WARNING: Before working inside your computer, read the safety information that shipped with your computer and follow the steps in [Before working inside your computer](#). After working inside your computer, follow the instructions in [After working inside your computer](#). For more safety best practices, see the Regulatory Compliance home page at www.dell.com/regulatory_compliance.

Procedure

⚠ CAUTION: To avoid damage to the wireless card, do not place any cables under it.

- 1 Lift the Mylar to access the wireless-card slot.
- 2 Align the notch on the wireless card with the tab on the wireless-card slot and insert the wireless card at an angle into the wireless-card slot.
- 3 Connect the antenna cables to the wireless card.
The following table provides the antenna-cable color scheme for the wireless card supported by your computer.

Table 2. Antenna-cable color scheme

Connectors on the wireless card	Antenna-cable color
Main (white triangle)	White
Auxiliary (black triangle)	Black

- 4 Align the screw hole on the wireless-card bracket with the screw hole on the wireless card and the keyboard bracket.
- 5 Replace the screw (M2x3) that secures the wireless card to the keyboard bracket.

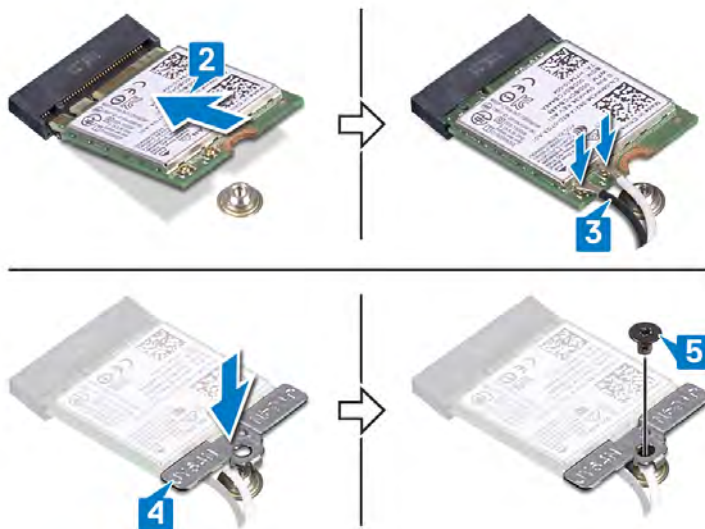

Post-requisites

Replace the [base cover](#).

Removing the display assembly

⚠ WARNING: Before working inside your computer, read the safety information that shipped with your computer and follow the steps in [Before working inside your computer](#). After working inside your computer, follow the instructions in [After working inside your computer](#). For more safety best practices, see the Regulatory Compliance home page at www.dell.com/regulatory_compliance.

Prerequisites

- 1 Remove the [base cover](#).
- 2 Follow the procedure from step 1 to step 4 in [Removing the wireless card](#).

Procedure

ⓘ NOTE: The touchscreen-board cable removal is only applicable for computers shipped with touchscreen configuration.

- 1 Remove the antenna cables from the routing guides on the palm-rest assembly.
- 2 Peel off the adhesive tapes that secure the display cable and touchscreen-board cable to the system board.
- 3 Open the latch and disconnect the display cable from the system board.
- 4 Open the latch and disconnect the touchscreen-board cable from the system board.

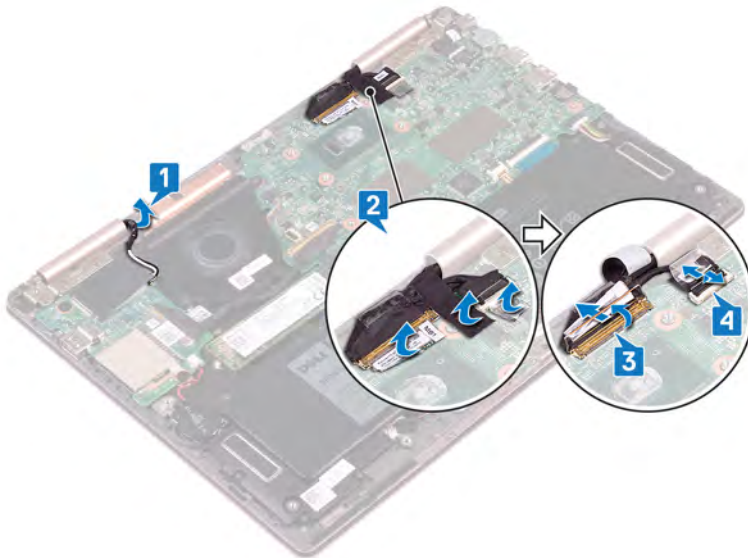

- 5 Turn the computer over and open the display as far as possible. Then place the computer face down on a flat surface.

⚠ CAUTION: Place the computer on a soft and clean surface to avoid scratching the display.

- 6 Remove the six screws (M2.5x5) that secure the display assembly to the palm-rest assembly.
- 7 Gently lift the display assembly off the palm-rest assembly.

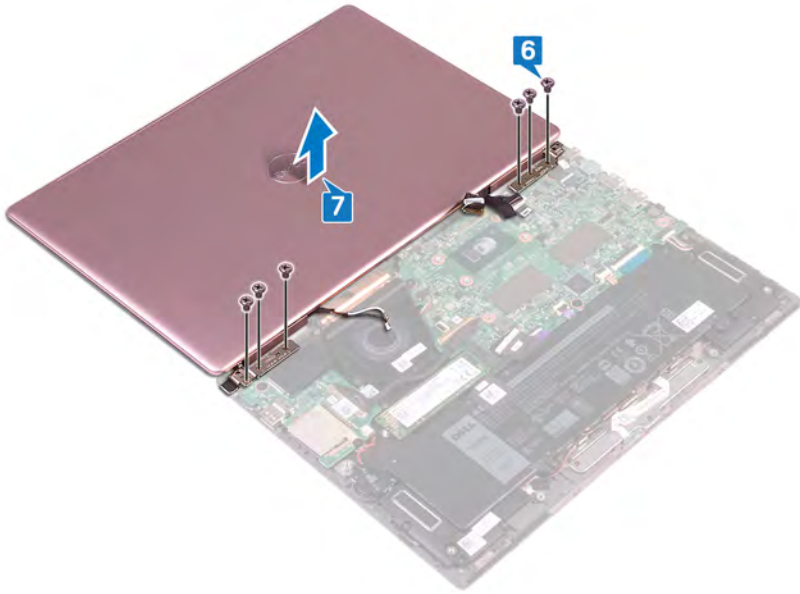

Replacing the display assembly

⚠ WARNING: Before working inside your computer, read the safety information that shipped with your computer and follow the steps in [Before working inside your computer](#). After working inside your computer, follow the instructions in [After working inside your computer](#). For more safety best practices, see the Regulatory Compliance home page at www.dell.com/regulatory_compliance.

Procedure

⚠ CAUTION: Place the display on a soft and clean surface to avoid scratching it.

- 1 Place and align the screw holes on the display assembly with the screw holes on the palm-rest assembly.
- 2 Replace the six screws (M2.5x5) that secure the display assembly to the palm-rest assembly.

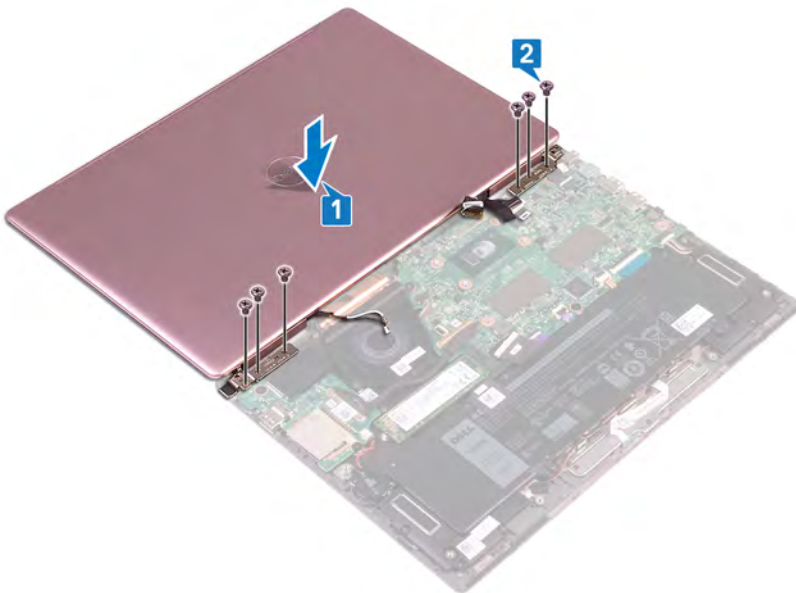

- 3 Close the display and turn the computer over.
- 4 Slide the display cable and touchscreen-board cable into their slots and then close the latches to secure the cables.
- 5 Adhere the tapes that secure the display cable and touchscreen-board cable to the system board.
- 6 Lift the Mylar to access the wireless-card slot.

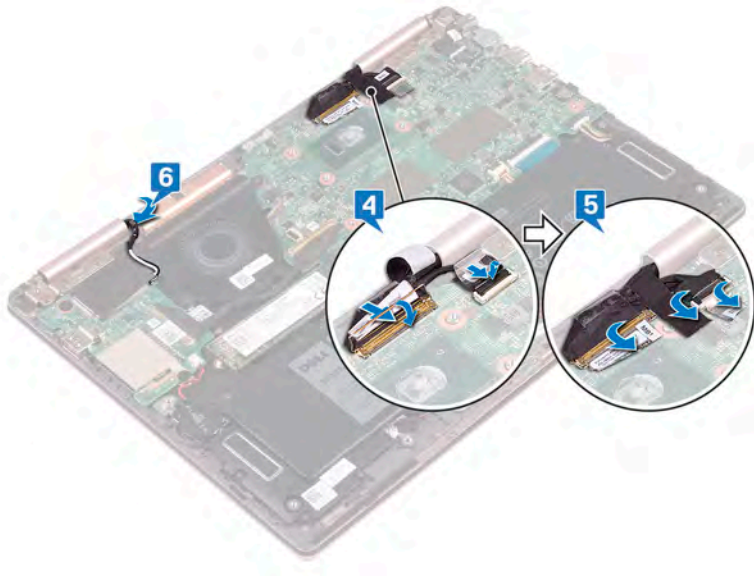

Post-requisites

- 1 Follow the procedure from step 3 to step 5 in [Replacing the wireless card](#).
- 2 Replace the [base cover](#).

Removing the I/O board

⚠ WARNING: Before working inside your computer, read the safety information that shipped with your computer and follow the steps in [Before working inside your computer](#). After working inside your computer, follow the instructions in [After working inside your computer](#). For more safety best practices, see the Regulatory Compliance home page at www.dell.com/regulatory_compliance.

Prerequisites

- 1 Remove the [base cover](#).
- 2 Remove the [wireless card](#).

Procedure

- 1 Peel the tape that secures the I/O-board cable to the I/O board.
- 2 Open the latch and disconnect the I/O-board cable from the I/O board.
- 3 Disconnect the coin-cell battery cable from the I/O board.

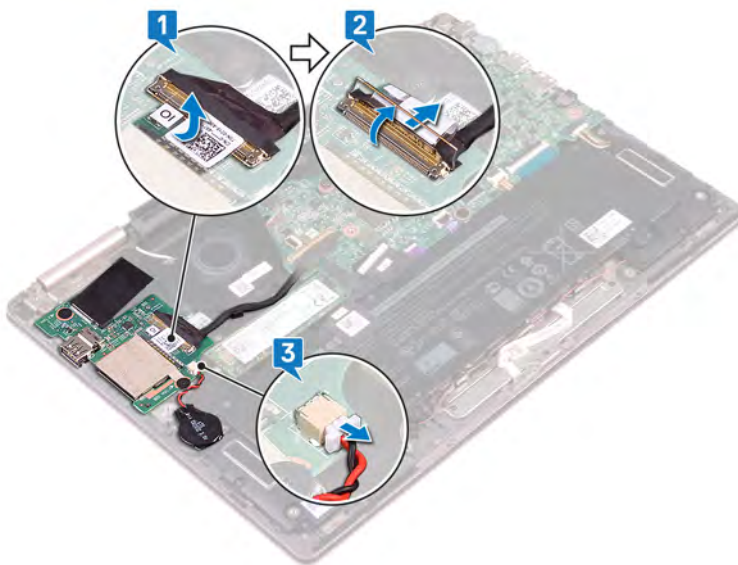

- 4 Remove the two screws (M2x2) that secure the I/O board to the keyboard bracket.
- 5 Lift the I/O board off the palm-rest assembly.

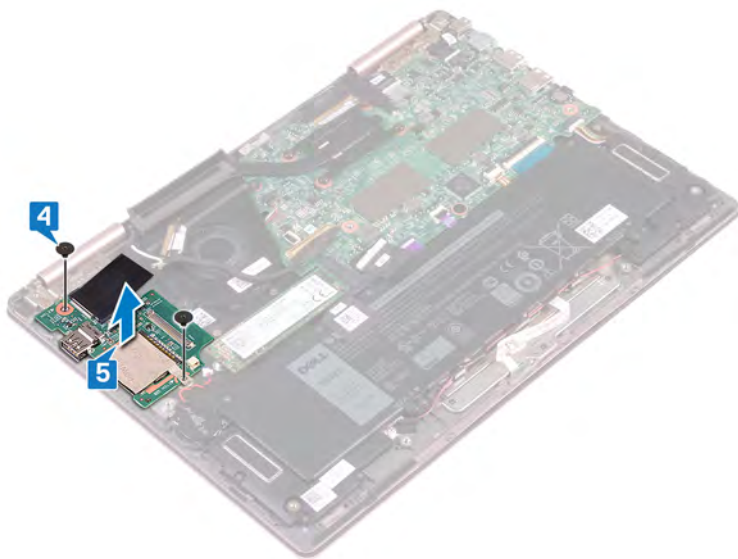

Replacing the I/O board

⚠ WARNING: Before working inside your computer, read the safety information that shipped with your computer and follow the steps in [Before working inside your computer](#). After working inside your computer, follow the instructions in [After working inside your computer](#). For more safety best practices, see the Regulatory Compliance home page at www.dell.com/regulatory_compliance.

Procedure

- 1 Place and align the screw holes on the I/O board with the screw hole on the palm-rest assembly and the screw hole on the keyboard bracket.
- 2 Replace the two screws (M2x2) that secure the I/O board to the keyboard bracket.

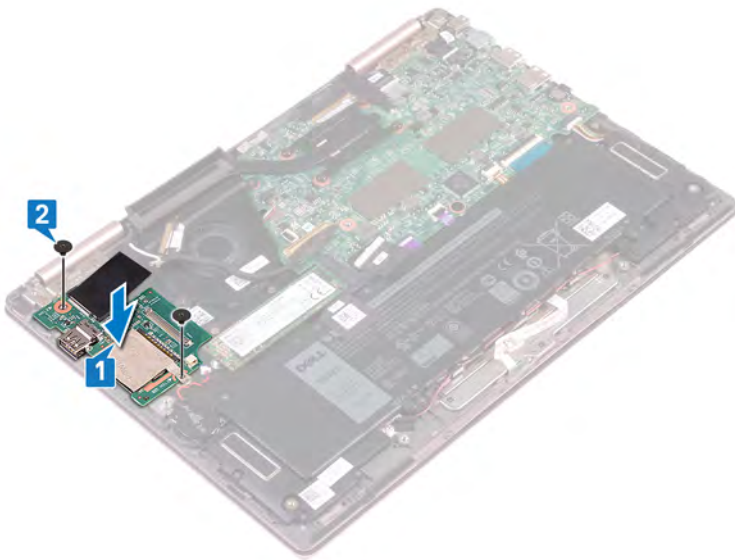

- 3 Connect the coin-cell battery cable to the I/O board.
- 4 Slide the I/O-board cable into the connector on the I/O board and close the latch to secure the cable.
- 5 Adhere the adhesive tape covering the I/O-board cable connector on the I/O board.

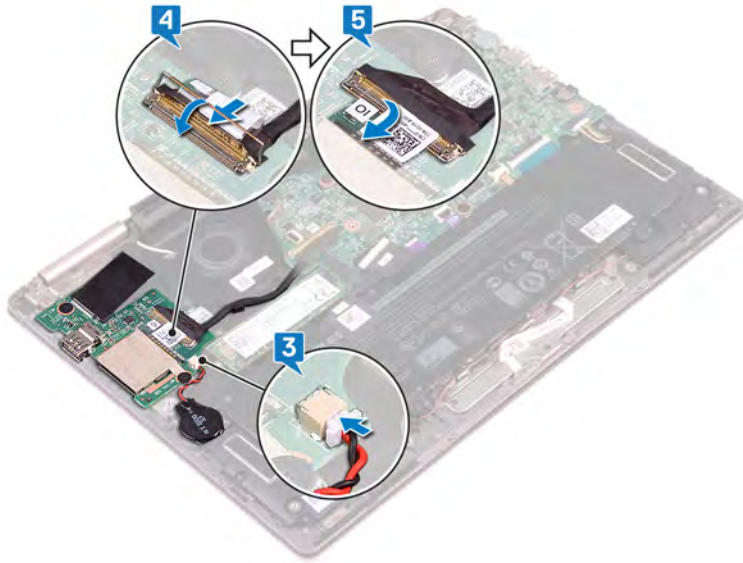

Post-requisites

- 1 Replace the [wireless card](#).
- 2 Replace the [base cover](#).

Removing the solid-state drive

⚠ WARNING: Before working inside your computer, read the safety information that shipped with your computer and follow the steps in [Before working inside your computer](#). After working inside your computer, follow the instructions in [After working inside your computer](#). For more safety best practices, see the Regulatory Compliance home page at www.dell.com/regulatory_compliance.

⚠ CAUTION: Solid-state drives are fragile. Exercise care when handling the solid-state drive.

⚠ CAUTION: To avoid data loss, do not remove the solid-state drive while the computer is in sleep or on state.

Prerequisites

Remove the [base cover](#).

Procedure

- 1 Locate the solid-state drive on the system board.

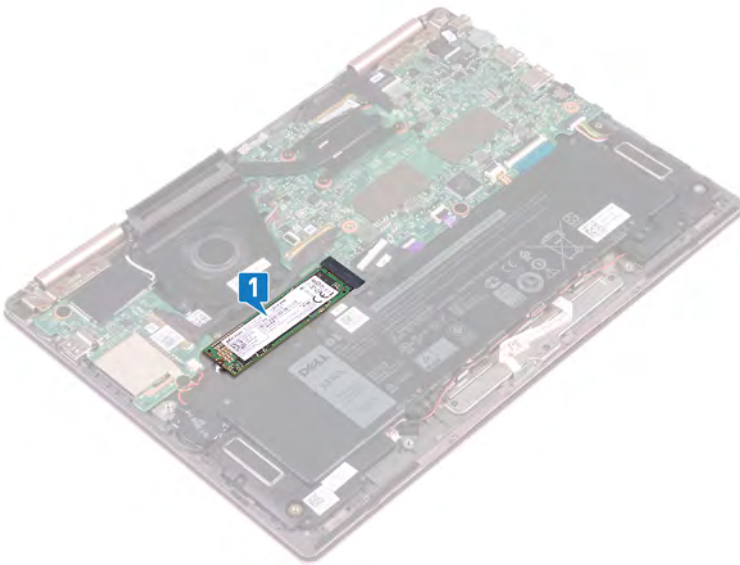

- 2 Remove the screw (M2x3) that secures the solid-state drive to the keyboard bracket.
- 3 Slide and remove the solid-state drive from the solid-state drive slot on the system board.

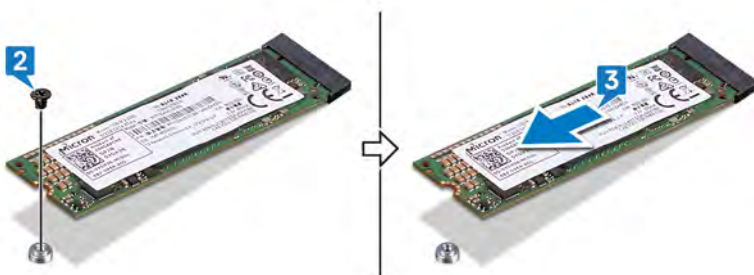

Replacing the solid-state drive

⚠ WARNING: Before working inside your computer, read the safety information that shipped with your computer and follow the steps in [Before working inside your computer](#). After working inside your computer, follow the instructions in [After working inside your computer](#). For more safety best practices, see the Regulatory Compliance home page at www.dell.com/regulatory_compliance.

⚠ CAUTION: Solid-state drives are fragile. Exercise care when handling the solid-state drive.

Procedure

- 1 Align the notch on the solid-state drive with the tab on the solid-state drive slot. Then slide the solid-state drive into the solid-state drive slot at an angle.
- 2 Align the screw hole on the solid-state drive with the screw hole on the keyboard bracket.
- 3 Replace the screw (M2x3) that secures the solid-state drive to the keyboard bracket.

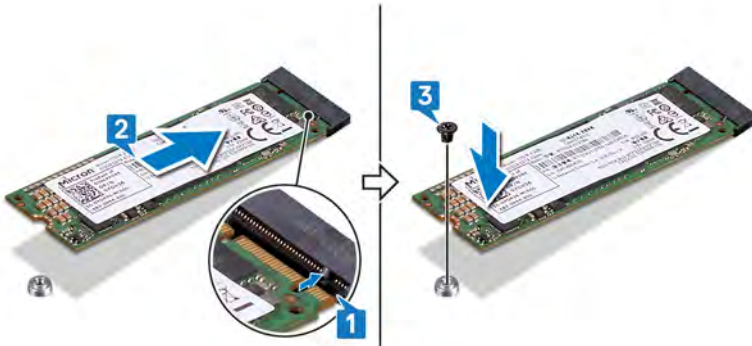

Post-requisites

Replace the [base cover](#).

Removing the system board

⚠ WARNING: Before working inside your computer, read the safety information that shipped with your computer and follow the steps in [Before working inside your computer](#). After working inside your computer, follow the instructions in [After working inside your computer](#). For more safety best practices, see the Regulatory Compliance home page at www.dell.com/regulatory_compliance.

- ⓘ NOTE:** Your computer's Service Tag is stored in the system board. You must enter the Service Tag in the BIOS setup program after you replace the system board.
- ⓘ NOTE:** Replacing the system board removes any changes you have made to the BIOS using the BIOS setup program. You must make the appropriate changes again after you replace the system board.
- ⓘ NOTE:** Before disconnecting the cables from the system board, note the location of the connectors so that you can reconnect the cables correctly after you replace the system board.

Prerequisites

- 1 Remove the [base cover](#).
- 2 Remove the [battery](#).
- 3 Remove the [solid-state drive](#).
- 4 Remove the [heat sink](#).

Procedure

ⓘ NOTE: The touchscreen board cable removal is only applicable for computers shipped with touchscreen configuration.

- 1 Peel the adhesive tape that cover the display cable and touchscreen-board cable connectors on the system board.
- 2 Open the latches and disconnect the display cable and touchscreen-board cable from the system board.
- 3 Disconnect the power-adaptor port cable from the system board.
- 4 Peel the adhesive tape that secures the latch on the I/O-board cable connector.
- 5 Open the latch and disconnect the I/O-board cable from the system board.

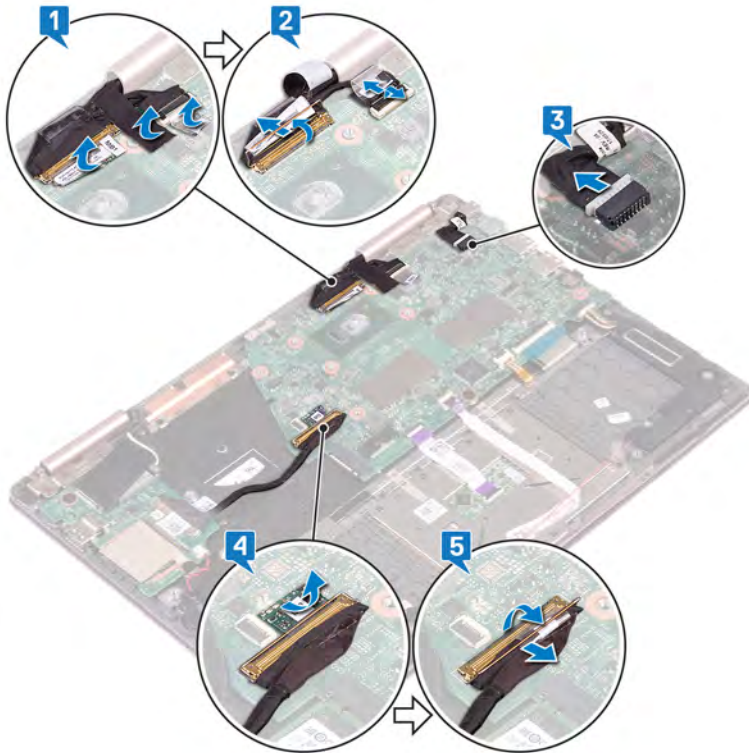

- 6 Remove the two screws (M2x3) that secure the Type-C port bracket to the system board and the palm-rest assembly.
- 7 Lift the Type-C port bracket off the system board.
- 8 Disconnect the speaker cable from the system board.
- 9 Open the latch and disconnect the keyboard cable from the system board.
- 10 Open the latch and disconnect the keyboard-backlight cable from the system board.
- 11 Open the latch and disconnect the touchpad cable from the system board.
- 12 Open the latch and disconnect the status-light board cable from the system board.

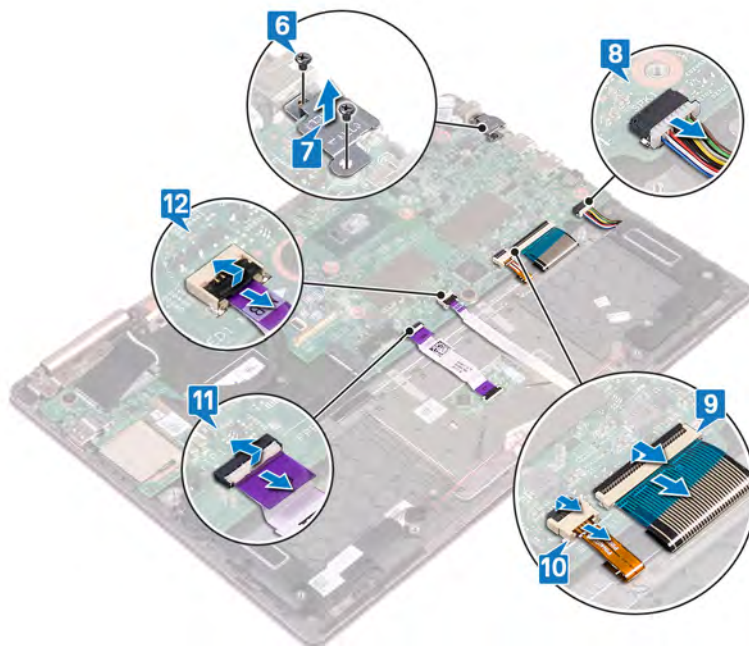

- 13 Remove the two screws (M2x2) that secure the system board to the keyboard bracket.
- 14 Lift the system board off the palm-rest assembly.



Replacing the system board

⚠ WARNING: Before working inside your computer, read the safety information that shipped with your computer and follow the steps in [Before working inside your computer](#). After working inside your computer, follow the instructions in [After working inside your computer](#). For more safety best practices, see the Regulatory Compliance home page at www.dell.com/regulatory_compliance.

ⓘ NOTE: Your computer's Service Tag is stored in the system board. You must enter the Service Tag in the BIOS setup program after you replace the system board.

ⓘ NOTE: Replacing the system board removes any changes you have made to the BIOS using the BIOS setup program. You must make the appropriate changes again after you replace the system board.

Procedure

- 1 Place the system board on the keyboard bracket and then align the screw holes on the system board with the screw holes on the keyboard bracket.
- 2 Replace the two screws (M2x2) that secure the system board to the keyboard bracket.

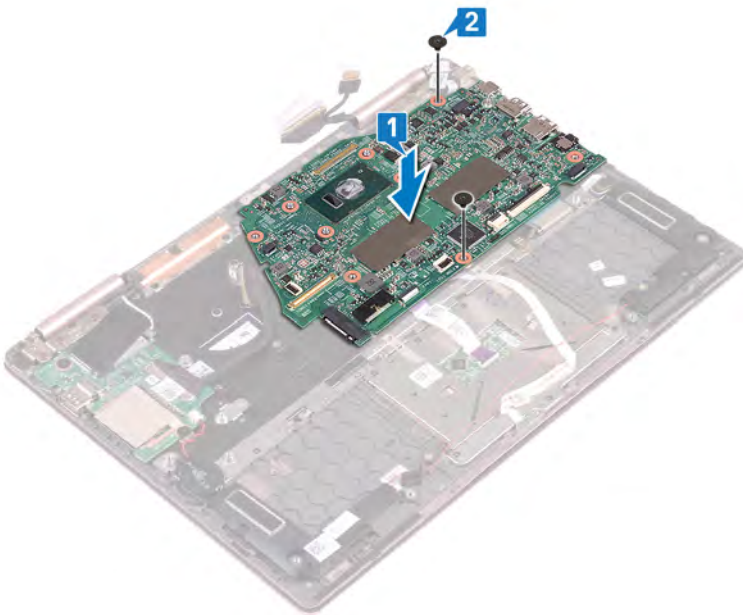

- 3 Open the latch and connect the status-light board cable to the system board.
- 4 Open the latch and connect the touchpad cable to the system board.
- 5 Open the latch and connect the keyboard-backlight cable to the system board.
- 6 Open the latch and connect the keyboard cable to the system board.
- 7 Connect the speaker cable to the system board.
- 8 Place the Type-C port bracket on the system board and align the screw holes on the Type-C port bracket to the screw holes on the system board.
- 9 Replace the two screws (M2x3) that secure the Type-C port bracket to the system board and the palm-rest assembly.

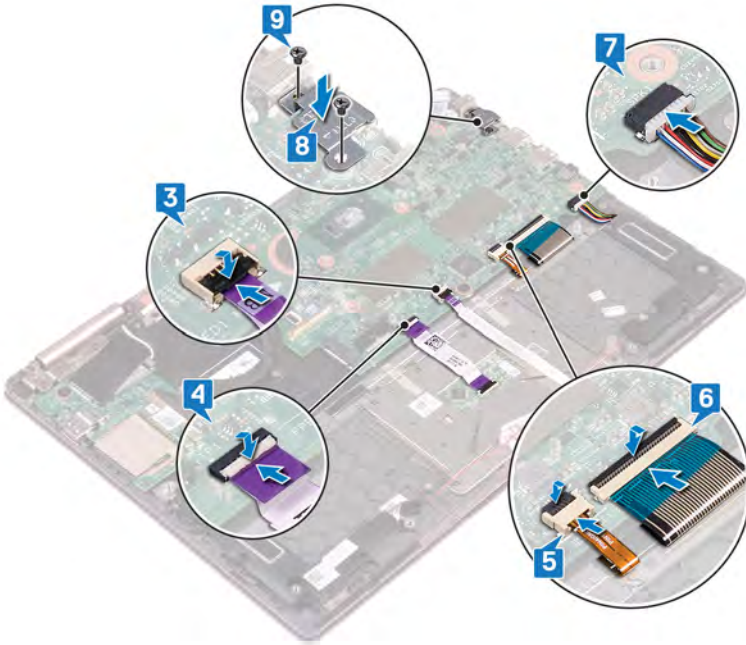

- 10 Open the latch and connect the I/O-board cable to the system board.
- 11 Adhere the adhesive tape that secures the latch on the I/O-board cable connector.
- 12 Connect the power-adaptor port cable to the system board.
- 13 Open the latches and connect the display cable and touchscreen-board cable to the system board.
- 14 Adhere the adhesive tape that cover the display cable and touchscreen-board cable connectors on the system board.

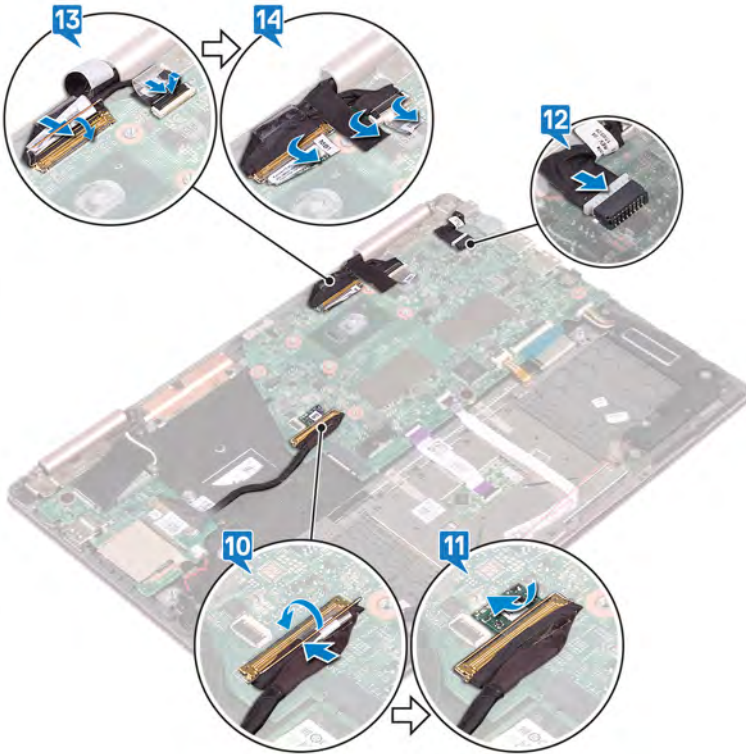

Post-requisites

- 1 Replace the [heat sink](#).
- 2 Replace the [solid-state drive](#).
- 3 Replace the [battery](#).
- 4 Replace the [base cover](#).

Removing the status-light board

⚠ WARNING: Before working inside your computer, read the safety information that shipped with your computer and follow the steps in [Before working inside your computer](#). After working inside your computer, follow the instructions in [After working inside your computer](#). For more safety best practices, see the Regulatory Compliance home page at www.dell.com/regulatory_compliance.

Prerequisites

- 1 Remove the [base cover](#).
- 2 Remove the [battery](#).

Procedure

ⓘ NOTE: The status-light board includes an LED indicator for power and battery-status light/hard-drive activity light.

- 1 Open the latch and disconnect the status-light board cable from the system board.
- 2 Press on release tab and lift the status-light board from the slot on the palm-rest assembly.
- 3 Slide the status-light board cable under the speaker cable and lift the status-light board off the palm-rest assembly.

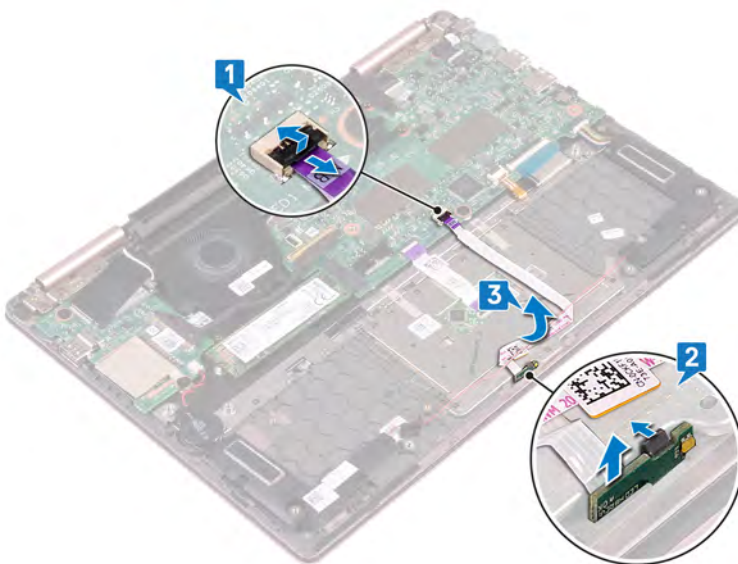

Replacing the status-light board

⚠ WARNING: Before working inside your computer, read the safety information that shipped with your computer and follow the steps in [Before working inside your computer](#). After working inside your computer, follow the instructions in [After working inside your computer](#). For more safety best practices, see the Regulatory Compliance home page at www.dell.com/regulatory_compliance.

Procedure

- 1 Place the status-light board in the slot on the palm-rest assembly and snap it into place.
- 2 Slide the status-light board cable under the speaker cable.
- 3 Connect the status-light board cable to the system board.

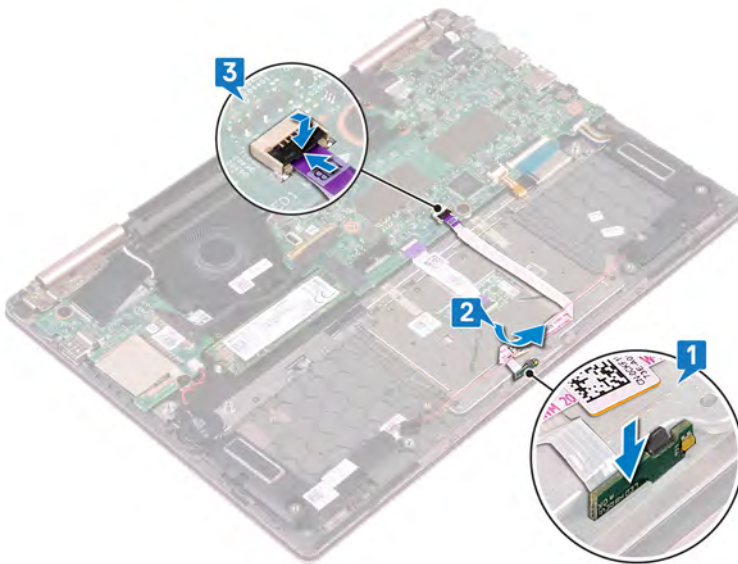

Post-requisites

- 1 Replace the [battery](#).
- 2 Replace the [base cover](#).

Removing the touchpad

⚠ WARNING: Before working inside your computer, read the safety information that shipped with your computer and follow the steps in [Before working inside your computer](#). After working inside your computer, follow the instructions in [After working inside your computer](#). For more safety best practices, see the Regulatory Compliance home page at www.dell.com/regulatory_compliance.

Prerequisites

- 1 Remove the [base cover](#).
- 2 Remove the [battery](#).
- 3 Remove the [speakers](#).
- 4 Remove the [status-light board](#).

Procedure

- 1 Open the latch and disconnect the touchpad cable from the system board.
- 2 Peel off the two adhesive tapes that secure the touchpad to the keyboard bracket.
- 3 Remove the three screws (M2x2.5) that secure the touchpad bracket to the palm-rest assembly.
- 4 Lift the touchpad bracket off the palm-rest assembly.

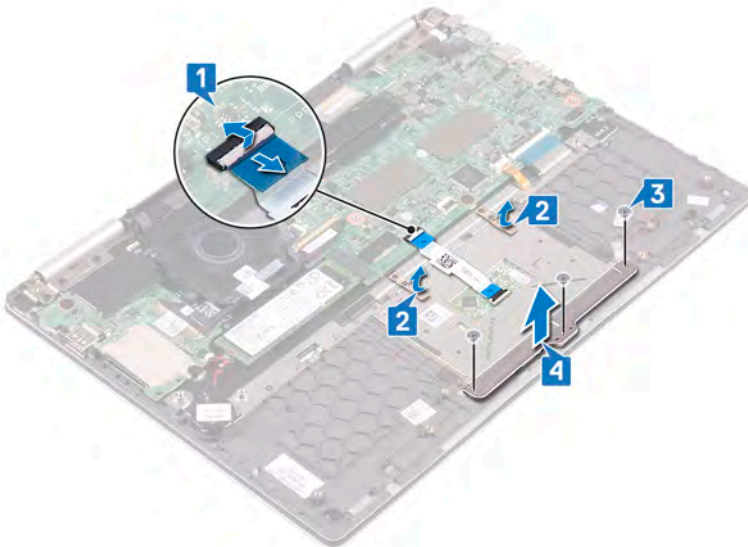

- 5 Remove the four screws (M2x2.5) securing the touchpad to the palm rest assembly.
- 6 Slide and lift the touchpad from the slot on the palm-rest assembly.

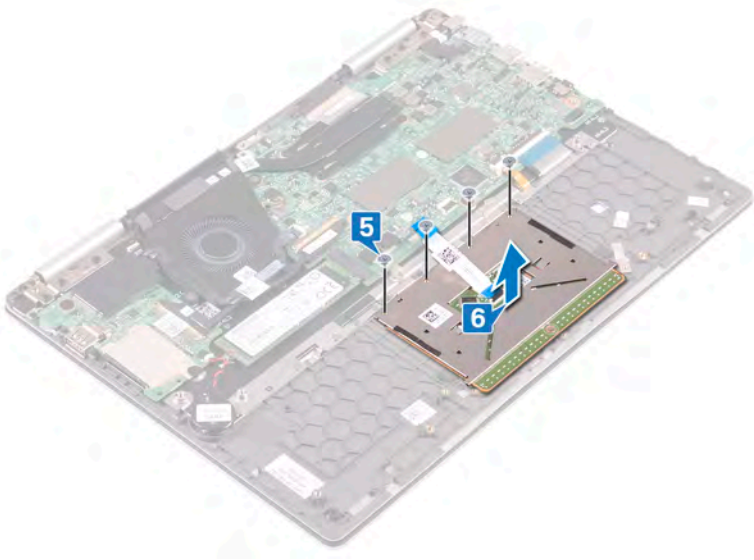

Replacing the touchpad

⚠ WARNING: Before working inside your computer, read the safety information that shipped with your computer and follow the steps in [Before working inside your computer](#). After working inside your computer, follow the instructions in [After working inside your computer](#). For more safety best practices, see the Regulatory Compliance home page at www.dell.com/regulatory_compliance.

Procedure

- 1 Align the screw holes on the touchpad with the screw holes on the palm-rest assembly.
- 2 Replace the four screws (M2x2.5) that secure the touchpad to the palm-rest assembly.

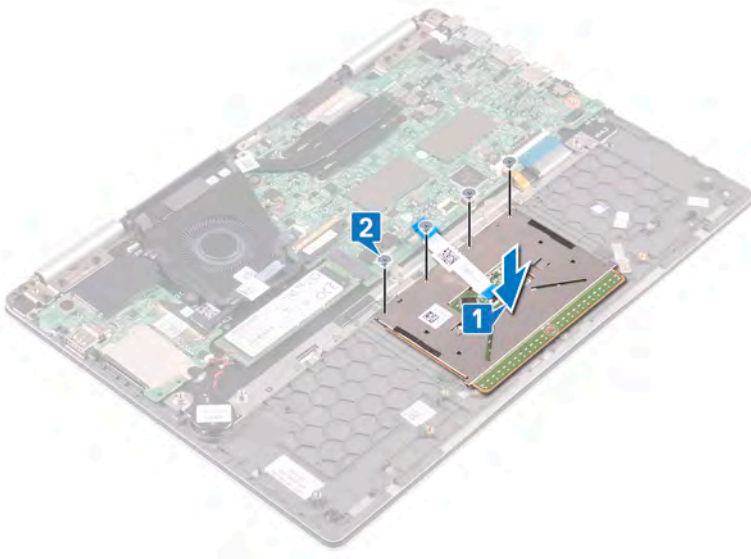

- 3 Align the screw holes on the touchpad bracket with the screw holes on the palm-rest assembly.
- 4 Replace the three screws (M2x2.5) that secure the touchpad bracket to the palm-rest assembly.
- 5 Adhere the two adhesive tapes that secure the touchpad to the keyboard bracket.
- 6 Slide the touchpad cable into the connector on the system board and close the latch to secure the touchpad cable.

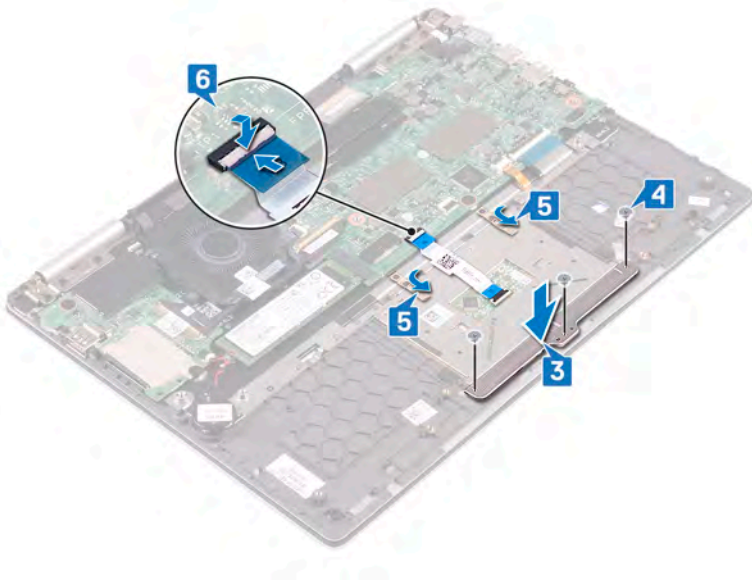

Post-requisites

- 1 Replace the [status-light board](#).
- 2 Replace the [speakers](#).
- 3 Replace the [battery](#).
- 4 Replace the [base cover](#).

Removing the power button with fingerprint reader

⚠ WARNING: Before working inside your computer, read the safety information that shipped with your computer and follow the steps in [Before working inside your computer](#). After working inside your computer, follow the instructions in [After working inside your computer](#). For more safety best practices, see the Regulatory Compliance home page at www.dell.com/regulatory_compliance.

ⓘ NOTE: Applicable only for computers that are shipped with fingerprint reader.

Prerequisites

ⓘ NOTE: The power button with fingerprint reader is shipped only with the non-touchscreen configuration of the Inspiron 7380.

- 1 Remove the [base cover](#).
- 2 Remove the [wireless card](#).
- 3 Remove the [I/O board](#).

Procedure

- 1 Open the latch and disconnect the power button with fingerprint reader cable from the system board.
- 2 Open the latch and disconnect the power button with fingerprint reader cable from the power button with fingerprint reader connector cable.
- 3 Peel off the power button with fingerprint reader cable from the fan.

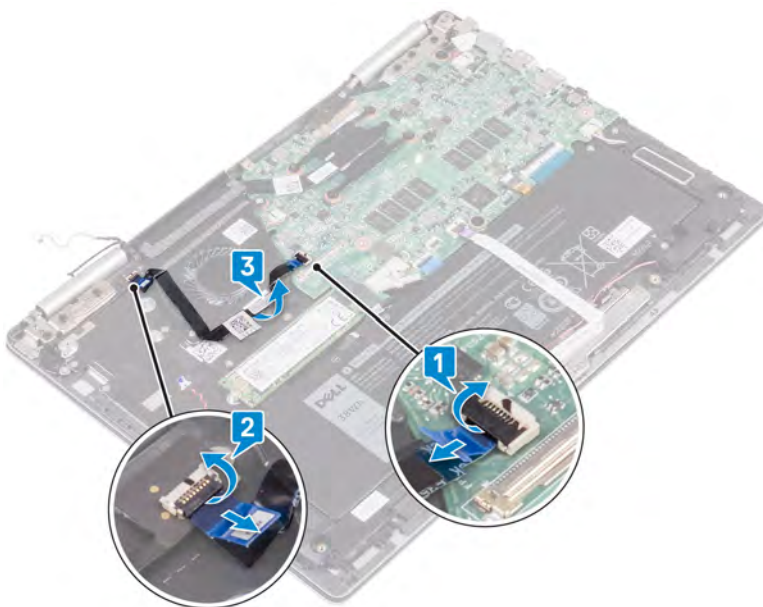

- 4 Remove the two screws (M2x2.5) securing the power button with fingerprint reader to the palm-rest assembly.
- 5 Peeling off the cable connector of the power button with fingerprint reader from the keyboard bracket. Then lift the power button with fingerprint reader from the slot on the palm-rest assembly.

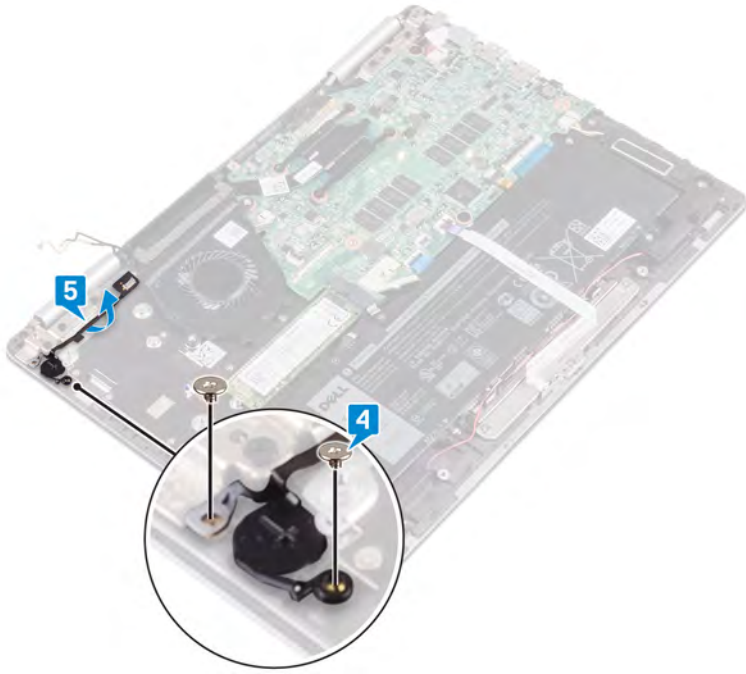

Replacing the power button with fingerprint reader

⚠ WARNING: Before working inside your computer, read the safety information that shipped with your computer and follow the steps in [Before working inside your computer](#). After working inside your computer, follow the instructions in [After working inside your computer](#). For more safety best practices, see the Regulatory Compliance home page at www.dell.com/regulatory_compliance.

ℹ NOTE: Applicable only for computers that are shipped with fingerprint reader.

Procedure

- 1 Place the power button with fingerprint reader into the slot on the palm-rest assembly. Then adhere the power button with fingerprint reader cable connector to the keyboard bracket.
- 2 Replace the two screws (M2x2.5) that secure the power button with fingerprint reader to the palm-rest assembly.

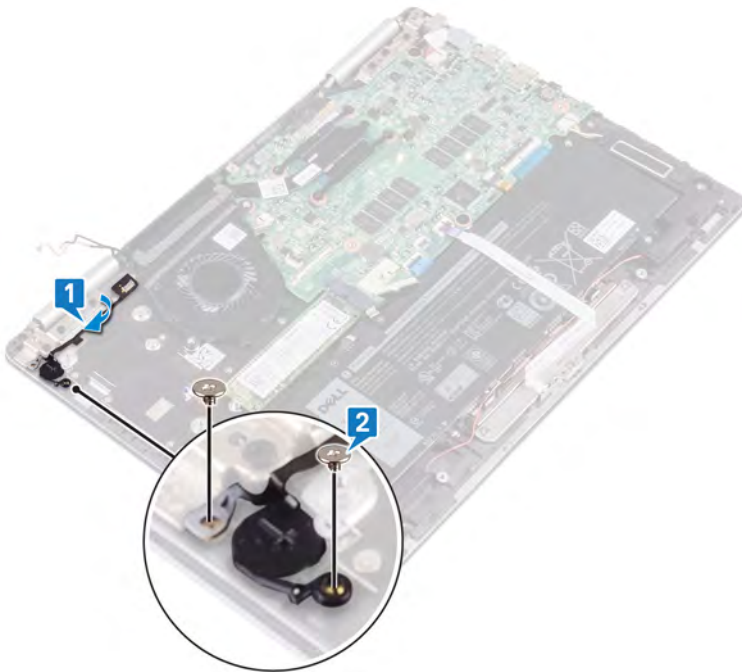

- 3 Open the power button with fingerprint reader cable connector latch and connect the power button with fingerprint reader cable to the power button with fingerprint reader.
- 4 Adhere the power button with fingerprint reader cable to the fan.
- 5 Open the system board connector latch and connect the power button with fingerprint reader cable to the system board.



Post-requisites

- 1 Replace the [I/O board](#).
- 2 Replace the [wireless card](#).
- 3 Replace the [base cover](#).

Removing the keyboard

⚠ WARNING: Before working inside your computer, read the safety information that shipped with your computer and follow the steps in [Before working inside your computer](#). After working inside your computer, follow the instructions in [After working inside your computer](#). For more safety best practices, see the Regulatory Compliance home page at www.dell.com/regulatory_compliance.

Prerequisites

- 1 Remove the [base cover](#).
- 2 Remove the [battery](#).
- 3 Remove the [coin-cell battery](#).
- 4 Remove the [wireless card](#).
- 5 Remove the [display assembly](#).
- 6 Remove the [I/O board](#).
- 7 Remove the [power button with fingerprint reader](#). (if installed)
- 8 Remove the [solid-state drive](#).
- 9 Remove the [heat sink](#).
- 10 Remove the [fan](#).
- 11 Remove the [system board](#).

Procedure

- 1 Peel off the two adhesive tapes that secure the touchpad to the keyboard bracket.
- 2 Remove the 27 screws (M1.4x2) that secure the keyboard bracket and the keyboard to the palm-rest assembly.
- 3 Lift the keyboard bracket off the keyboard.

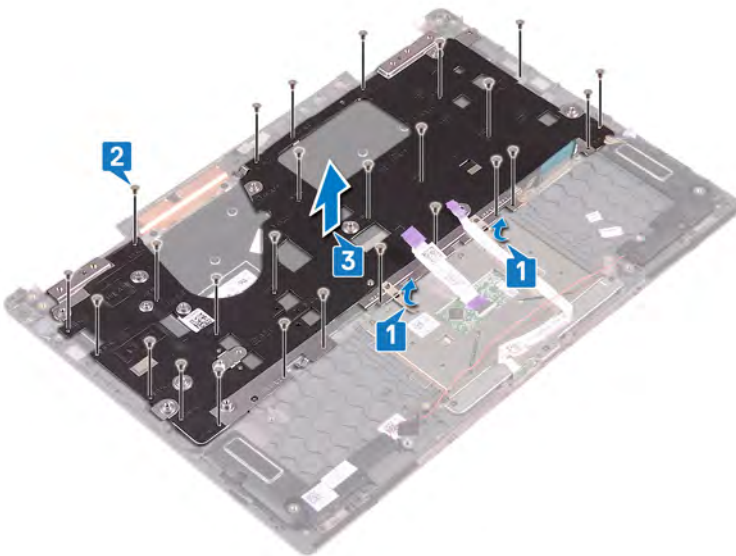

- 4 Remove the six screws (M1.2x1.5) that secure the keyboard to the palm-rest assembly.
- 5 Lift the keyboard off the palm-rest assembly.

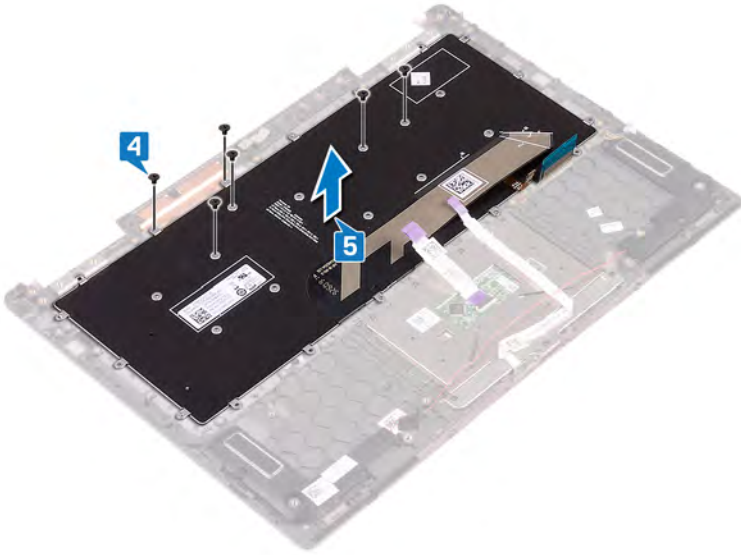

Replacing the keyboard

⚠ WARNING: Before working inside your computer, read the safety information that shipped with your computer and follow the steps in [Before working inside your computer](#). After working inside your computer, follow the instructions in [After working inside your computer](#). For more safety best practices, see the Regulatory Compliance home page at www.dell.com/regulatory_compliance.

Procedure

- 1 Place the keyboard cable on the back of the keyboard.
- 2 Align the keyboard cable along the folding line and fold the keyboard cable.

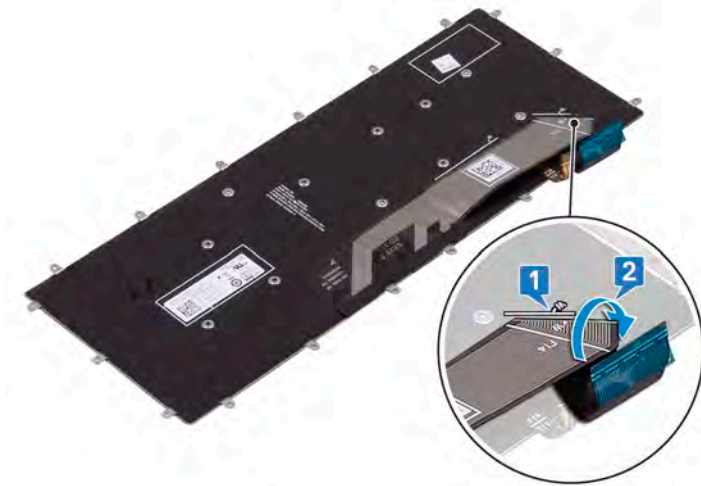

- 3 Place the keyboard on the palm-rest assembly and align the screw holes on the keyboard with the screw holes on the palm-rest assembly.
- 4 Replace the six screws (M1.2x1.5) that secure the keyboard to the palm-rest assembly.

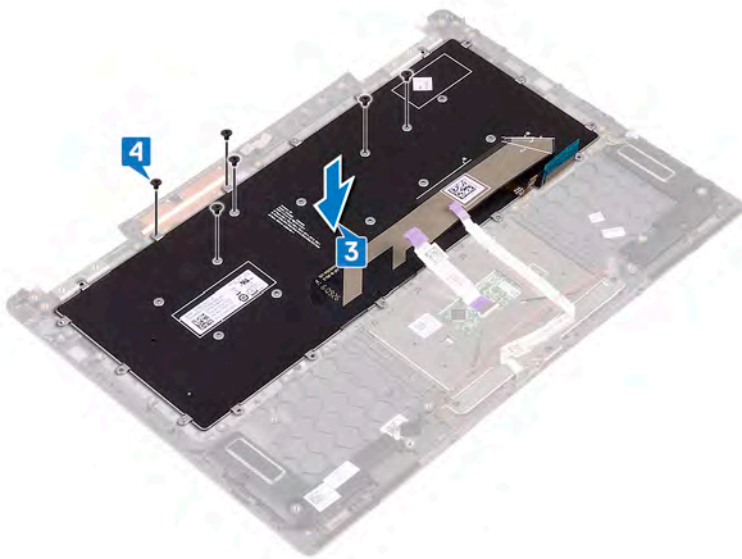

- 5 Place the keyboard bracket on the palm-rest assembly and align the screw holes on the keyboard bracket with the screw holes on the keyboard and the palm-rest assembly.
- 6 Replace the 27 screws (M1.4x2) that secure the keyboard bracket and the keyboard to the palm-rest assembly.
- 7 Replace the two adhesive tapes that secure the touchpad to the keyboard bracket.

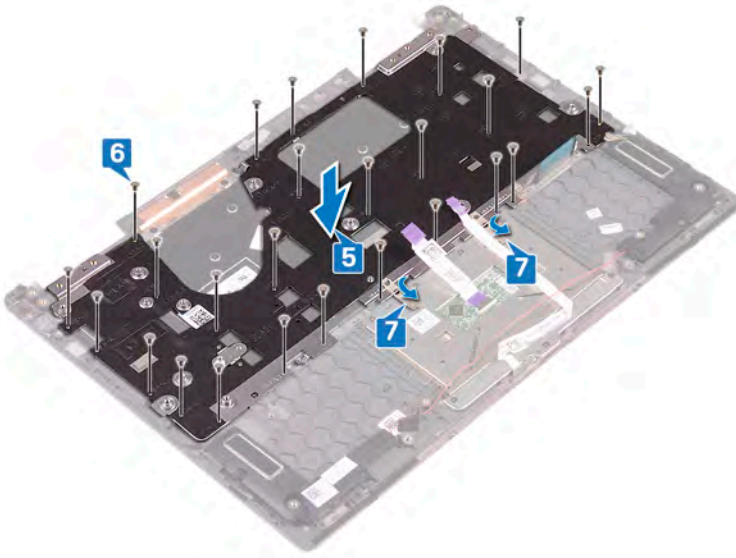

Post-requisites

- 1 Replace the [system board](#).
- 2 Replace the [fan](#).
- 3 Replace the [heat sink](#).
- 4 Replace the [solid-state drive](#).
- 5 Replace the [power button with fingerprint reader](#). (if installed)
- 6 Replace the [I/O board](#).
- 7 Replace the [display assembly](#).
- 8 Replace the [wireless card](#).
- 9 Replace the [coin-cell battery](#).
- 10 Replace the [battery](#).
- 11 Replace the [base cover](#).

Removing the palm-rest assembly

⚠ WARNING: Before working inside your computer, read the safety information that shipped with your computer and follow the steps in [Before working inside your computer](#). After working inside your computer, follow the instructions in [After working inside your computer](#). For more safety best practices, see the Regulatory Compliance home page at www.dell.com/regulatory_compliance.

Prerequisites

- 1 Remove the [base cover](#).
- 2 Remove the [battery](#).
- 3 Remove the [coin-cell battery](#).
- 4 Remove the [wireless card](#).
- 5 Remove the [display assembly](#).
- 6 Remove the [I/O board](#).
- 7 Remove the [power button with fingerprint reader](#). (if installed)
- 8 Remove the [solid-state drive](#).
- 9 Remove the [heat sink](#).
- 10 Remove the [fan](#).
- 11 Remove the [system board](#).
- 12 Remove the [status-light board](#).
- 13 Remove the [touchpad](#).
- 14 Remove the [keyboard](#).

Procedure

After performing all the prerequisites, we are left with the palm rest.



Replacing the palm-rest assembly

⚠ WARNING: Before working inside your computer, read the safety information that shipped with your computer and follow the steps in [Before working inside your computer](#). After working inside your computer, follow the instructions in [After working inside your computer](#). For more safety best practices, see the Regulatory Compliance home page at www.dell.com/regulatory_compliance.

Procedure

Place the palm rest face down on a clean and flat surface.



Post-requisites

- 1 Replace the [keyboard](#).
- 2 Replace the [touchpad](#).
- 3 Replace the [status-light board](#).
- 4 Replace the [system board](#).
- 5 Replace the [fan](#).
- 6 Replace the [heat sink](#).
- 7 Replace the [solid-state drive](#).
- 8 Replace the [power button with fingerprint reader](#). (if installed)
- 9 Replace the [I/O board](#).
- 10 Replace the [display assembly](#).
- 11 Replace the [wireless card](#).
- 12 Replace the [coin-cell battery](#).
- 13 Replace the [battery](#).
- 14 Replace the [base cover](#).

Downloading drivers

Downloading the audio driver

- 1 Turn on your computer.
- 2 Go to www.dell.com/support.
- 3 Click **Product Support**, enter the Service Tag of your computer, and then click **Submit**.
i | **NOTE: If you do not have the Service Tag, use the auto-detect feature or manually browse for your computer model.**
- 4 Click **Drivers & Downloads > Find it myself**.
- 5 Scroll down the page and expand **Audio**.
- 6 Click **Download** to download the audio driver for your computer.
- 7 After the download is complete, navigate to the folder where you saved the audio driver file.
- 8 Double-click the audio driver file icon and follow the instructions on the screen to install the driver.

Downloading the graphics driver

- 1 Turn on your computer.
- 2 Go to www.dell.com/support.
- 3 Enter the Service Tag of your computer, and then click **Submit**.
i | **NOTE: If you do not have the Service Tag, use the autodetect feature or manually browse for your computer model.**
- 4 Click **Drivers & downloads**.
- 5 Click the **Detect Drivers** button.
- 6 Review and agree to the Terms and Conditions to use **SupportAssist**, then click **Continue**.
- 7 If necessary, your computer starts to download and install **SupportAssist**.
i | **NOTE: Review on-screen instructions for browser-specific instructions.**
- 8 Click **View Drivers for My System**.
- 9 Click **Download and Install** to download and install all driver updates detected for your computer.
- 10 Select a location to save the files.
- 11 If prompted, approve requests from **User Account Control** to make changes on the system.
- 12 The application installs all drivers and updates identified.
i | **NOTE: Not all files can be installed automatically. Review the installation summary to identify if manual installation is necessary.**
- 13 For manual download and installation, click **Category**.
- 14 Click **Video** in the drop-down list.
- 15 Click **Download** to download the graphics driver for your computer.
- 16 After the download is complete, navigate to the folder where you saved the graphics driver file.
- 17 Double-click the graphics driver file icon and follow the instructions on the screen to install the driver.

Downloading the USB 3.0 driver

- 1 Turn on your computer.
- 2 Go to www.dell.com/support.

- 3 Click **Product Support**, enter the Service Tag of your computer, and then click **Submit**.

 **NOTE: If you do not have the Service Tag, use the auto-detect feature or manually browse for your computer model.**

- 4 Click **Drivers & Downloads > Find it myself**.
- 5 Scroll down the page and expand **Chipset**.
- 6 Click **Download** to download the USB 3.0 driver for your computer.
- 7 After the download is complete, navigate to the folder where you saved USB 3.0 driver file.
- 8 Double-click the USB 3.0 driver file icon and follow the instructions on screen to install the driver.

Downloading the Wi-Fi driver

- 1 Turn on the computer.
- 2 Go to www.dell.com/support.
- 3 Click **Product support**, enter the Service Tag of your computer, and then click **Submit**.

 **NOTE: If you do not have the Service Tag, use the auto-detect feature or manually browse for your computer model.**

- 4 Click **Drivers & downloads > Find it myself**.
- 5 Scroll down the page and expand **Network**.
- 6 Click **Download** to download the Wi-Fi driver for your computer.
- 7 After the download is complete, navigate to the folder where you saved the Wi-Fi driver file.
- 8 Double-click the driver file icon and follow the instructions on the screen.

Downloading the media-card reader driver

- 1 Turn on your computer.
- 2 Go to www.dell.com/support.
- 3 Click **Product support**, enter the Service Tag of your computer, and then click **Submit**.

 **NOTE: If you do not have the Service Tag, use the auto-detect feature or manually browse for your computer model.**

- 4 Click **Drivers & downloads > Find it myself**.
- 5 Scroll down the page, and expand **Chipset**.
- 6 Click **Download** to download the media-card reader driver for your computer.
- 7 After the download is complete, navigate to the folder where you saved the card reader driver file.
- 8 Double-click the card reader driver file icon, and follow the instructions on the screen.

Downloading the chipset driver

- 1 Turn on your computer.
- 2 Go to www.dell.com/support.
- 3 Click **Product Support**, enter the Service Tag of your computer, and then click **Submit**.

 **NOTE: If you do not have the Service Tag, use the auto-detect feature or manually browse for your computer model.**

- 4 Click **Drivers & downloads > Find it myself**.
- 5 Scroll down the page and expand **Chipset**.
- 6 Click **Download** to download the appropriate chipset driver for your computer.
- 7 After the download is complete, navigate to the folder where you saved the chipset driver file.
- 8 Double-click the chipset driver file icon and follow the instructions on the screen to install the driver.

Downloading the network driver

- 1 Turn on your computer.
- 2 Go to www.dell.com/support.

3 Click **Product support** enter the Service Tag of your computer and click **Submit**.

 **NOTE: If you do not have the Service Tag, use the auto-detect feature or manually browse for your computer model.**

4 Click **Drivers & downloads > Find it myself**.

5 Scroll down the page and expand **Network**.

6 Click **Download** to download the network driver for your computer.

7 Save the file, and after the download is complete, navigate to the folder where you saved the network driver file.

8 Double-click the network driver file icon and follow the instructions on screen.

System setup

NOTE: Depending on the computer and its installed devices, the items listed in this section may or may not be displayed.

Boot Sequence

Boot Sequence allows you to bypass the System Setup–defined boot device order and boot directly to a specific device (for example: optical drive or hard drive). During the Power-on Self Test (POST), when the Dell logo appears, you can:

- Access System Setup by pressing F2 key
- Bring up the one-time boot menu by pressing F12 key

The one-time boot menu displays the devices that you can boot from including the diagnostic option. The boot menu options are:

- Removable Drive (if available)
- STXXXX Drive

NOTE: XXX denotes the SATA drive number.

- Optical Drive (if available)
- SATA Hard Drive (if available)
- Diagnostics

NOTE: Choosing Diagnostics, will display the ePSA diagnostics screen.

The boot sequence screen also displays the option to access the System Setup screen.

Navigation keys

NOTE: For most of the System Setup options, changes that you make are recorded but do not take effect until you restart the system.

Keys	Navigation
Up arrow	Moves to the previous field.
Down arrow	Moves to the next field.
Enter	Selects a value in the selected field (if applicable) or follow the link in the field.
Spacebar	Expands or collapses a drop-down list, if applicable.
Tab	Moves to the next focus area.
	NOTE: For the standard graphics browser only.
Esc	Moves to the previous page until you view the main screen. Pressing Esc in the main screen displays a message that prompts you to save any unsaved changes and restarts the system.

BIOS overview

CAUTION: Unless you are an expert computer user, do not change the settings in the BIOS Setup program. Certain changes can make your computer work incorrectly.

NOTE: Before you change BIOS Setup program, it is recommended that you write down the BIOS Setup program screen information for future reference.

Use the BIOS Setup program for the following purposes:

- Get information about the hardware installed in your computer, such as the amount of RAM and the size of the hard drive.
- Change the system configuration information.
- Set or change a user-selectable option, such as the user password, type of hard drive installed, and enabling or disabling base devices.

Entering BIOS setup program

- 1 Turn on (or restart) your computer.
- 2 During POST, when the DELL logo is displayed, watch for the F2 prompt to appear, and then press F2 immediately.

NOTE: The F2 prompt indicates that the keyboard is initialized. This prompt can appear very quickly, so you must watch for it, and then press F2. If you press F2 before the F2 prompt, this keystroke is lost. If you wait too long and the operating system logo appears, continue to wait until you see the desktop. Then, turn off your computer and try again.

System setup options

NOTE: Depending on this computer and its installed devices, the items listed in this section may or may not appear.

Table 3. System setup options—System information menu

General

System Information

BIOS Version	Displays the BIOS version number.
Service Tag	Displays the Service Tag of the computer.
Asset Tag	Displays the Asset Tag of the computer.
Ownership Tag	Displays the ownership tag of the computer.
Manufacture Date	Displays the manufacture date of the computer.
Ownership Date	Displays the ownership date of the computer.
Express Service Code	Displays the express service code of the computer.

Memory Information

Memory Installed	Displays the total computer memory installed.
Memory Available	Displays the total computer memory available.
Memory Speed	Displays the memory speed.
Memory Channel Mode	Displays single or dual channel mode.
Memory Technology	Displays the technology used for the memory.
DIMM A Size	Displays the DIMM A memory size.
DIMM B Size	Displays the DIMM B memory size.

Processor Information

Processor Type	Displays the processor type.
Core Count	Displays the number of cores on the processor.
Processor ID	Displays the processor identification code.
Current Clock Speed	Displays the current processor clock speed.
Minimum Clock Speed	Displays the minimum processor clock speed.

General

Maximum Clock Speed	Displays the maximum processor clock speed.
Processor L2 Cache	Displays the processor L2 Cache size.
Processor L3 Cache	Displays the processor L3 Cache size.
HT Capable	Displays whether the processor is HyperThreading (HT) capable.
64-Bit Technology	Displays whether 64-bit technology is used.
Device Information	
SATA-0	Displays the SATA-0 device information of the computer.
SATA-2	Displays the SATA-2 device information of the computer.
M.2 PCIe SSD-0	Displays the M.2 PCIe SSD information of the computer.
LOM MAC Address	Displays the LOM MAC address of the computer.
Video Controller	Displays the video controller.
Video BIOS Version	Displays the video BIOS version.
Video Memory	Displays the video memory.
Panel Type	Displays the display panel type.
Native Resolution	Displays the display resolution.
Audio Controller	Displays the audio controller.
Wi-Fi Device	Displays the wireless device.
Bluetooth Device	Displays the bluetooth device.
Battery Information	Displays the battery health information.
Boot Sequence	
Boot Sequence	Displays the boot sequence.
Boot List Option	Displays the available boot options.
Advanced Boot Options	
Enable Legacy Option ROMs	Enable or disable the Legacy Option ROMs.
Enable Attempt Legacy Boot	Enable or disable Attempt Legacy Boot.
UEFI Boot Path Security	Controls the security level for booting a UEFI boot path.
Date/Time	Displays the current date in MM/DD/YY format and current time in HH:MM:SS AM/PM format.

Table 4. System setup options—System Configuration menu

System Configuration

Integrated NIC	Controls the on-board LAN controller.
Enable UEFI Network Stack	Enable or disable UEFI Network Stack.
SATA Operation	Configures operating mode of the integrated SATA hard drive controller.
Drives	Enable or disable various drives on board.
SMART Reporting	Enable or disable SMART Reporting during system startup.
USB Configuration	
Enable Boot Support	Enable or disable booting from USB mass storage devices such as external hard drive, optical drive, and USB drive.

System Configuration

Enable External USB Port	Enable or disable booting from USB mass storage devices connected to external USB port.
USB PowerShare	Enable or disable charging external devices through the USB PowerShare port.
Audio	Enable or disable the integrated audio controller.
Keyboard Illumination	Configures operating mode of the keyboard illumination feature.
Keyboard Backlight with AC	Enable or disable Keyboard Backlight with AC. i NOTE: This option does not affect Keyboard Illumination.
Miscellaneous Devices	Enable or disable various onboard devices.
Enable Camera	Enable or disable the camera.
Enable Secure Digital (SD) Card	Enable or disable the SD card.

Table 5. System setup options—Video menu

Video

LCD Brightness	Set the panel brightness independently for battery and AC power.
----------------	--

Table 6. System setup options—Security menu

Security

Admin Password	Set, change, or delete the administrator password.
System Password	Set, change, or delete the system password.
Internal HDD-2 Password	Set, change, or delete the system's internal hard-disk drive password.
Strong Password	Enable or disable strong passwords.
Password Configuration	Control the minimum and maximum number of characters allowed for Admin and System passwords.
Password Bypass	Bypass the System (Boot) Password and the internal HDD password prompts during a system restart.
Password Change	Enable or disable changes to the System and Hard Disk passwords when an administrator password is set.
Non-Admin Setup Changes	Enable or disable changes to the setup options when an administrator password is set.
UEFI Capsule Firmware Updates	Enable or disable BIOS updates through UEFI capsule update packages.
PTT Security	Enable or disable Platform Trust Technology (PTT) visibility to the operating system.
Computrace(R)	Enable or disable the BIOS module interface of the optional Computrace(R) Service from Absolute Software.
CPU XD Support	Enable or disable the Execute Disable mode of the Processor.
Admin Setup Lockout	Enable to prevent users from entering Setup when an Admin Password is set.
Master Password Lockout	Enable to disable master password support.

i | **NOTE: Hard Disk passwords need to be cleared before the setting can be changed.**

Table 7. System setup options—Secure Boot menu

Secure Boot

Secure Boot Enable	Enable or disable the secure boot feature.
Expert Key Management	
Expert Key Management	Enable or disable Expert Key Management.
Custom Mode Key Management	Select the custom values for expert key management.

Table 8. System setup options—Intel Software Guard Extensions menu

Intel Software Guard Extensions

Intel SGX Enable	Enable or disable Intel Software Guard Extensions.
Enclave Memory Size	Set the Intel Software Guard Extensions Enclave Reserve Memory Size.

Table 9. System setup options—Performance menu

Performance

Multi Core Support	Enable multiple cores. Default: Enabled.
Intel SpeedStep	Enable or disable Intel Speedstep Technology. Default: Enabled.
	NOTE: If enabled, the processor clock speed and core voltage are adjusted dynamically based on the processor load.
C-States Control	Enable or disable additional processor sleep states. Default: Enabled.
Intel TurboBoost	Enable or disable Intel TurboBoost mode of the processor. Default: Enabled.
HyperThread control	Enable or disable HyperThreading in the processor. Default: Enabled.

Table 10. System setup options—Power Management menu

Power Management

Enable Intel Speed Shift Technology	Enable or disable Intel Speed Shift Technology support. Enables the operating system to select the appropriate processor performance automatically.
Auto on Time	Enable to set the computer to turn on automatically every day or on a preselected date and time. This option can be configured only if the Auto On Time is set to Everyday, Weekdays or Selected Days. Default: Disabled.
USB Wake Support	Enable the USB devices to wake the computer from Standby.
Wake on LAN	Enable the LAN signal to wake the computer from the off state or hibernation.
	NOTE: This feature only works when the computer is connected to AC.
Advanced Battery Charge Configuration	Enable Advanced Battery Charge Configuration from the beginning of the day to a specified work period.

Power Management

Primary Battery Charge Configuration	Set the primary battery charge settings with a preselected custom charge start and stop. Default: Adaptive.
--------------------------------------	--

Table 11. System setup options—POST Behavior menu

POST Behavior

Adapter Warnings	Enable adapter warnings. Default: Enabled.
Fn Lock Options	Enable or disable the Fn lock mode.
Fastboot	Enable to set the speed of the boot process. Default: Thorough.
Extended BIOS POST Time	Creates an additional pre-boot delay.
Full Screen Logo	Enable to display full screen logo.
Warnings and Errors	Specify whether the boot process will continue or prompt for user input when warnings and errors are detected.

 **NOTE: Critical errors will always halt the system.**

Table 12. System setup options—Virtualization Support menu

Virtualization Support

Virtualization	Specify whether a Virtual Machine Monitor (VMM) can utilize the additional hardware capabilities provided by Intel Virtualization Technology.
VT for Direct I/O	Specify whether a Virtual Machine Monitor (VMM) can utilize the additional hardware capabilities provided by Intel Virtualization Technology for Direct I/O.

Table 13. System setup options—Wireless menu

Wireless

Wireless Switch	Determine which wireless devices can be controlled by the Wireless Switch.
Wireless Device Enable	Enable or disable internal wireless devices.

Table 14. System setup options—Maintenance menu

Maintenance

Service Tag	Display the computer's Service Tag.
Asset Tag	Create a computer Asset Tag.
BIOS Downgrade	Control flashing of the system firmware to previous revisions.
Data Wipe	Enable to securely erase data from all internal storage devices.
BIOS Recovery	Enable the user to recover from certain corrupted BIOS conditions from a recovery file on the user primary hard drive or an external USB key.

Table 15. System setup options—System Logs menu

System Logs	
BIOS Events	Display BIOS events.
Thermal Events	Display Thermal events.
Power Events	Display Power events.

Table 16. System setup options—SupportAssist System Resolution menu

SupportAssist System Resolution	
Auto OS Recovery Threshold	Control the automatic boot flow for SupportAssist System Resolution Console and for Dell OS Recovery tool.
SupportAssist OS Recovery	Enable or disable the boot flow for SupportAssist OS Recovery tool in the even of certain system errors.

System and setup password

Table 17. System and setup password

Password type	Description
System password	Password that you must enter to log on to your system.
Setup password	Password that you must enter to access and make changes to the BIOS settings of your computer.

You can create a system password and a setup password to secure your computer.

 **CAUTION:** The password features provide a basic level of security for the data on your computer.

 **CAUTION:** Anyone can access the data stored on your computer if it is not locked and left unattended.

 **NOTE:** System and setup password feature is disabled.

Assigning a system setup password

You can assign a new **System or Admin Password** only when the status is in **Not Set**.

To enter the system setup, press F2 immediately after a power-on or re-boot.

- 1 In the **System BIOS** or **System Setup** screen, select **Security** and press Enter.
The **Security** screen is displayed.
- 2 Select **System/Admin Password** and create a password in the **Enter the new password** field.
Use the following guidelines to assign the system password:
 - A password can have up to 32 characters.
 - The password can contain the numbers 0 through 9.
 - Only lower case letters are valid, upper case letters are not allowed.
 - Only the following special characters are allowed: space, ("), (+), (,), (-), (.), (/), (:), ([], (\), (]), (`).
- 3 Type the system password that you entered earlier in the **Confirm new password** field and click **OK**.
- 4 Press Esc and a message prompts you to save the changes.
- 5 Press Y to save the changes.
The computer reboots.

Deleting or changing an existing system setup password

Ensure that the **Password Status** is Unlocked (in the System Setup) before attempting to delete or change the existing System and/or Setup password. You cannot delete or change an existing System or Setup password, if the **Password Status** is Locked. To enter the System Setup, press F2 immediately after a power-on or reboot.

- 1 In the **System BIOS** or **System Setup** screen, select **System Security** and press Enter.
The **System Security** screen is displayed.
- 2 In the **System Security** screen, verify that **Password Status** is **Unlocked**.
- 3 Select **System Password**, alter or delete the existing system password and press Enter or Tab.
- 4 Select **Setup Password**, alter or delete the existing setup password and press Enter or Tab.

NOTE: If you change the System and/or Setup password, re-enter the new password when promoted. If you delete the System and/or Setup password, confirm the deletion when promoted.

- 5 Press Esc and a message prompts you to save the changes.
- 6 Press Y to save the changes and exit from System Setup.
The computer reboot.

Clearing CMOS settings

- 1 Ensure the computer has been powered down.
- 2 Plug the power adapter into the computer and ensure that there is power supplied to the computer via the adapter.
- 3 Press and hold the power button for 25 seconds to perform Real Time Clock (RTC) battery reset.
- 4 Release the power button.

Clearing BIOS (System Setup) and System passwords

Contact Dell technical support to clear the forgotten passwords. For more information, see www.dell.com/contactdell.

Troubleshooting

Flashing the BIOS

You may need to flash (update) the BIOS when an update is available or when you replace the system board.

Follow these steps to flash the BIOS:

- 1 Turn on your computer.
- 2 Go to www.dell.com/support.
- 3 Click **Product support**, enter the Service Tag of your computer, and then click **Submit**.

NOTE: If you do not have the Service Tag, use the auto-detect feature or manually browse for your computer model.

- 4 Click **Drivers & downloads > Find it myself**.
- 5 Select the operating system installed on your computer.
- 6 Scroll down the page and expand **BIOS**.
- 7 Click **Download** to download the latest version of the BIOS for your computer.
- 8 After the download is complete, navigate to the folder where you saved the BIOS update file.
- 9 Double-click the BIOS update file icon and follow the instructions on the screen.

Enhanced Pre-Boot System Assessment (ePSA) diagnostics

CAUTION: Use the ePSA diagnostics to test only your computer. Using this program with other computers may cause invalid results or error messages.

The ePSA diagnostics (also known as system diagnostics) performs a complete check of your hardware. The ePSA is embedded with the BIOS and is launched by the BIOS internally. The embedded system diagnostics provides a set of options for particular devices or device groups allowing you to:

- Run tests automatically or in an interactive mode
- Repeat tests
- Display or save test results
- Run thorough tests to introduce additional test options to provide extra information about the failed device(s)
- View status messages that inform you if tests are completed successfully
- View error messages that inform you of problems encountered during testing

NOTE: Some tests for specific devices require user interaction. Always ensure that you are present at the computer terminal when the diagnostic tests are performed.

For more information, see [Dell ePSA Diagnostic 3.0](#).

Running the ePSA Diagnostics

Invoke diagnostics boot by either of the methods that are suggested below:

- 1 Power on the computer.
- 2 As the computer boots, press the F12 key when the Dell logo is displayed.

- 3 In the boot menu screen, use Up/Down arrow key to select the **Diagnostics** option and then press **Enter**.

NOTE: The Enhanced Pre-boot System Assessment window displays, listing all devices detected in the computer. The diagnostics starts running the tests on all the detected devices.

- 4 Press the arrow in the lower-right corner to go to the page listing.
The detected items are listed and tested.
- 5 To run a diagnostic test on a specific device, press Esc and click **Yes** to stop the diagnostic test.
- 6 Select the device from the left pane and click **Run Tests**.
- 7 If there are any issues, error codes are displayed.
Note the error code and contact Dell.
or
- 8 Shut down the computer.
- 9 Press and hold the Fn key, while pressing the power button, and then release both.
- 10 Repeat steps 3–7 above.

Diagnostics

Power and battery-status light/ hard-drive activity light: Indicates the battery-charge status or the hard-drive activity.

NOTE: Press Fn+H to toggle this light between power and battery-status light and hard-drive activity light.

Hard-drive activity light

Turns on when the computer reads from or writes to the hard drive.

Power and battery-status light

Indicates the power and battery-charge status.

Solid white – Power adapter is connected and the battery has more than 5 percent charge.

Amber – Computer is running on battery and the battery has less than 5 percent charge.

Off

- Power adapter is connected and the battery is fully charged.
- Computer is running on battery and the battery has more than 5 percent charge.
- Computer is in sleep state, hibernation, or turned off.

For example, the power and battery-status light blinks amber two times followed by a pause, and then blinks white three times followed by a pause. This 2,3 pattern continues until the computer is turned off indicating no memory or RAM is detected.

The following table shows different light patterns and what they indicate.

Table 18. Diagnostics

Light pattern	Problem description
2,1	CPU failure
2,2	System board: BIOS and ROM failure
2,3	No memory or RAM detected
2,4	Memory or RAM failure
2,5	Invalid memory installed
2,6	System board or chipset error

Light pattern	Problem description
2,7	LCD failure
3,1	CMOS battery failure
3,2	PCI/video card failure
3,3	Recovery image not found
3,4	Recovery image found but invalid

Camera status light: Indicates whether the camera is in use.

- Solid white – Camera is in use.
- Off – Camera is not in use.

Caps Lock status light: Indicates whether Caps Lock is enabled or disabled.

- Solid white – Caps Lock enabled.
- Off – Caps Lock disabled.

Flea power release

Flea power is the residual static electricity that remains on the computer even after it has been powered off and the battery has been removed. The following procedure provides the instructions on how to conduct flea power release:

- 1 Turn off your computer.
- 2 Remove the [base cover](#).
- 3 Press and hold the power button for 15 seconds to drain the flea power.
- 4 Replace the [base cover](#).
- 5 Turn on your computer.

Wi-Fi power cycle

If your computer is unable to access the internet due to Wi-Fi connectivity issues a Wi-Fi power cycle procedure may be performed. The following procedure provides the instructions on how to conduct a Wi-Fi power cycle:

NOTE: Some ISPs (Internet Service Providers) provide a modem/router combo device.



- 1 Turn off your computer.
- 2 Turn off the modem.
- 3 Turn off the wireless router.
- 4 Wait for 30 seconds.
- 5 Turn on the wireless router.
- 6 Turn on the modem.
- 7 Turn on your computer.

Getting help and contacting Dell

Self-help resources

You can get information and help on Dell products and services using these self-help resources:

Table 19. Self-help resources

Information about Dell products and services	www.dell.com
Dell Help & Support app	
Tips	
Contact Support	In Windows search, type <code>Contact Support</code> , and press Enter.
Online help for operating system	www.dell.com/support/windows www.dell.com/support/linux
Troubleshooting information, user manuals, setup instructions, product specifications, technical help blogs, drivers, software updates, and so on.	www.dell.com/support
Dell knowledge base articles for a variety of computer concerns.	<ol style="list-style-type: none"> 1 Go to www.dell.com/support. 2 Type the subject or keyword in the Search box. 3 Click Search to retrieve the related articles.
Learn and know the following information about your product:	See <i>Me and My Dell</i> at www.dell.com/support/manuals .
<ul style="list-style-type: none"> • Product specifications • Operating system • Setting up and using your product • Data backup • Troubleshooting and diagnostics • Factory and system restore • BIOS information 	To locate the <i>Me and My Dell</i> relevant to your product, identify your product through one of the following: <ul style="list-style-type: none"> • Select Detect Product. • Locate your product through the drop-down menu under View Products. • Enter the Service Tag number or Product ID in the search bar.

Contacting Dell

To contact Dell for sales, technical support, or customer service issues, see www.dell.com/contactdell.

NOTE: Availability varies by country and product, and some services may not be available in your country.

NOTE: If you do not have an active internet connection, you can find contact information on your purchase invoice, packing slip, bill, or Dell product catalog.