



Alienware 17 R5 Service Manual

Computer Model: Alienware 17 R5
Regulatory Model: P31E
Regulatory Type: P31E002

A L I E N W A R E™ 

Notes, cautions, and warnings

-  **NOTE:** A NOTE indicates important information that helps you make better use of your product.
 -  **CAUTION:** A CAUTION indicates either potential damage to hardware or loss of data and tells you how to avoid the problem.
 -  **WARNING:** A WARNING indicates a potential for property damage, personal injury, or death.
-

© 2018 Dell Inc. or its subsidiaries. All rights reserved. Dell, EMC, and other trademarks are trademarks of Dell Inc. or its subsidiaries. Other trademarks may be trademarks of their respective owners.

2018 - 03

Rev. A00

Contents

Before working inside your computer.....	10
Before you begin	10
Safety instructions.....	10
Recommended tools.....	11
Screw list.....	12
After working inside your computer.....	14
Removing the base cover.....	15
Procedure.....	15
Replacing the base cover.....	18
Procedure.....	18
Removing the hard drive.....	21
Prerequisites.....	21
Procedure.....	21
Replacing the hard drive.....	24
Procedure.....	24
Post-requisites.....	26
Removing the wireless card.....	27
Prerequisites.....	27
Procedure.....	27

Replacing the wireless card.....	29
Procedure.....	29
Post-requisites.....	30
Removing the solid-state drive.....	31
Prerequisites.....	31
Procedure.....	31
Replacing the solid-state drive.....	33
Procedure.....	33
Post-requisites.....	34
Removing the memory modules.....	35
Prerequisites.....	35
Procedure.....	35
Replacing the memory modules.....	37
Procedure.....	37
Post-requisites.....	38
Removing the rear-I/O cover.....	39
Prerequisites.....	39
Procedure.....	39
Replacing the rear-I/O cover.....	41
Procedure.....	41
Post-requisites.....	42
Removing the computer base.....	43
Prerequisites.....	43
Procedure.....	43

Replacing the computer base.....	47
Procedure.....	47
Post-requisites.....	49
Removing the coin-cell battery.....	50
Prerequisites.....	50
Procedure.....	50
Replacing the coin-cell battery.....	52
Procedure.....	52
Post-requisites.....	53
Removing the speakers.....	54
Prerequisites.....	54
Procedure.....	54
Replacing the speakers.....	56
Procedure.....	56
Post-requisites.....	57
Removing the I/O board.....	58
Prerequisites.....	58
Procedure.....	58
Replacing the I/O board.....	61
Procedure.....	61
Post-requisites.....	62
Removing the subwoofer.....	63
Prerequisites.....	63
Procedure.....	63

Replacing the subwoofer.....	65
Procedure.....	65
Post-requisites.....	66
Removing the system board.....	67
Prerequisites.....	67
Procedure.....	67
Replacing the system board.....	73
Procedure.....	73
Post-requisites.....	77
Removing the heat-sink assembly.....	78
Prerequisites.....	78
Procedure.....	78
Replacing the heat-sink assembly.....	81
Procedure.....	81
Post-requisites.....	83
Removing the power-adapter port.....	84
Prerequisites.....	84
Procedure.....	84
Replacing the power-adapter port.....	86
Procedure.....	86
Post-requisites.....	87
Removing the power-button board.....	88
Prerequisites.....	88
Procedure.....	88

Replacing the power-button board.....	90
Procedure.....	90
Post-requisites.....	91
Removing the display assembly.....	92
Prerequisites.....	92
Procedure.....	93
Replacing the display assembly.....	96
Procedure.....	96
Post-requisites.....	98
Removing the battery.....	99
Prerequisites.....	99
Procedure.....	99
Replacing the battery.....	101
Procedure.....	101
Post-requisites.....	102
Removing the touchpad.....	103
Prerequisites.....	103
Procedure.....	103
Replacing the touchpad.....	106
Procedure.....	106
Post-requisites.....	107
Removing the keyboard.....	109
Prerequisites.....	109
Procedure.....	109



Replacing the keyboard.....	113
Procedure.....	113
Post-requisites.....	115
Removing the macro keys.....	117
Prerequisites.....	117
Procedure.....	118
Replacing the macro keys.....	119
Procedure.....	119
Post-requisites.....	120
Removing the palm rest.....	121
Prerequisites.....	121
Procedure.....	122
Replacing the palm rest.....	123
Procedure.....	123
Post-requisites.....	123
Downloading drivers.....	125
Downloading the audio driver.....	125
Downloading the chipset driver.....	126
Downloading the graphics driver.....	127
Downloading the network driver.....	128
Downloading the tobii driver.....	129
Downloading the USB driver.....	130
Downloading the wireless driver.....	131

System setup.....	133
Boot Sequence.....	133
Navigation keys.....	133
BIOS overview.....	134
Entering BIOS setup program.....	134
Enabling or disabling the USB in BIOS setup program.....	135
Identifying the hard drive in BIOS setup program.....	135
Checking the system memory in BIOS setup program.....	135
System setup options.....	136
Troubleshooting.....	144
Flashing the BIOS.....	144
Flashing BIOS (USB key).....	144
Reinstall Windows using a USB recovery drive.....	145
Enhanced Pre-Boot System Assessment (ePSA) diagnostics.....	146
Running the ePSA diagnostics.....	146
Diagnostics.....	147
Wi-Fi power cycle.....	148
Flea power release.....	149
Getting help and contacting Alienware.....	150
Self-help resources.....	150
Contacting Alienware.....	151

Before working inside your computer



 **NOTE:** The images in this document may differ from your computer depending on the configuration you ordered.

Before you begin

- 1 Save and close all open files and exit all open applications.
- 2 Shut down your computer. Click **Start** →  **Power** → **Shut down**.
 **NOTE:** If you are using a different operating system, see the documentation of your operating system for shut-down instructions.
- 3 Disconnect your computer and all attached devices from their electrical outlets.
- 4 Disconnect all attached network devices and peripherals, such as keyboard, mouse, and monitor from your computer.
- 5 Remove any media card and optical disc from your computer, if applicable.

Safety instructions

Use the following safety guidelines to protect your computer from potential damage and ensure your personal safety.

-  **WARNING:** Before working inside your computer, read the safety information that shipped with your computer. For more safety best practices, see the Regulatory Compliance home page at www.dell.com/regulatory_compliance.
-  **WARNING:** Disconnect all power sources before opening the computer cover or panels. After you finish working inside the computer, replace all covers, panels, and screws before connecting to the electrical outlet.
-  **CAUTION:** To avoid damaging the computer, ensure that the work surface is flat and clean.

- △ **CAUTION:** To avoid damaging the components and cards, handle them by their edges, and avoid touching pins and contacts.
- △ **CAUTION:** You should only perform troubleshooting and repairs as authorized or directed by the Dell technical assistance team. Damage due to servicing that is not authorized by Dell is not covered by your warranty. See the safety instructions that shipped with the product or at www.dell.com/regulatory_compliance.
- △ **CAUTION:** Before touching anything inside your computer, ground yourself by touching an unpainted metal surface, such as the metal at the back of the computer. While you work, periodically touch an unpainted metal surface to dissipate static electricity, which could harm internal components.
- △ **CAUTION:** When you disconnect a cable, pull on its connector or on its pull tab, not on the cable itself. Some cables have connectors with locking tabs or thumb-screws that you must disengage before disconnecting the cable. When disconnecting cables, keep them evenly aligned to avoid bending any connector pins. When connecting cables, ensure that the ports and connectors are correctly oriented and aligned.
- △ **CAUTION:** Press and eject any installed card from the media-card reader.











Recommended tools







The procedures in this document may require the following tools:

- Phillips screwdriver #1
- Plastic scribe

Screw list

Table 1. Screw list

Component	Secured to	Screw type	Quantity	Screw image
Base cover	Palm-rest assembly	M2.5x13	6	
Battery	Palm-rest assembly	M2.5x5	4	
Computer base	Palm-rest assembly	M2.5x8	14	
Display assembly	Palm-rest assembly	M2.5x5	6	
Hard-drive assembly	Computer base	M2.5x5	4	
Hard-drive bracket	Hard-drive assembly	M3x3	4	
Heat-sink assembly	System board	M2x3	7	
I/O board	Palm-rest assembly	M2.5x5	2	
Keyboard bracket	Palm-rest assembly	M2x3	17	
Power-adaptor port bracket	Palm-rest assembly	M2x3	1	
Power-button board	Palm-rest assembly	M2x3	2	

Component	Secured to	Screw type	Quantity	Screw image
Rear-I/O cover	Computer base	M2.5x7	2	
Solid-state drive	Computer base	M2x3	1	
Subwoofer	Palm-rest assembly	M2x2	2	
System-board assembly	Palm-rest assembly	M2.5x5	7	
Touchpad bracket	Palm-rest assembly	M2x3	5	
Tron-light holder	Palm-rest assembly	M2.5x5	2	
Wireless-card bracket	Computer base	M2x3	1	

After working inside your computer



CAUTION: Leaving stray or loose screws inside your computer may severely damage your computer.

- 1 Replace all screws and ensure that no stray screws remain inside your computer.
- 2 Connect any external devices, peripherals, or cables you removed before working on your computer.
- 3 Replace any media cards, discs, or any other parts that you removed before working on your computer.
- 4 Connect your computer and all attached devices to their electrical outlets.
- 5 Turn on your computer.

Removing the base cover

⚠ WARNING: Before working inside your computer, read the safety information that shipped with your computer and follow the steps in [Before working inside your computer](#). After working inside your computer, follow the instructions in [After working inside your computer](#). For more safety best practices, see the Regulatory Compliance home page at www.dell.com/regulatory_compliance.

Procedure

- 1 Remove the six screws (M2.5x13) that secure the base cover to the computer base.
- 2 Loosen the captive screw that secures the base cover to the computer base to open a gap between the two parts.

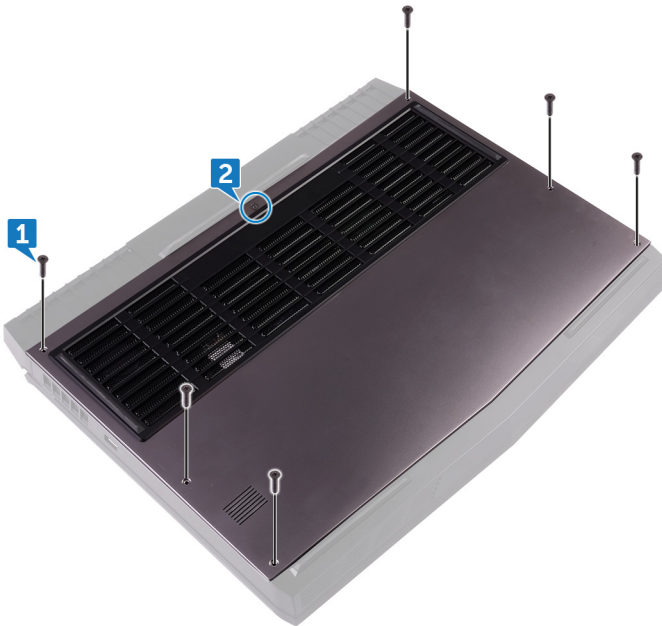

- 3 Using a plastic scribe, gently pry the base cover from the gap around the captive screw to release the clips on the base cover from the computer base.
- 4 Lift the base cover off the computer base.



- 5 Disconnect the battery cable from the system board.

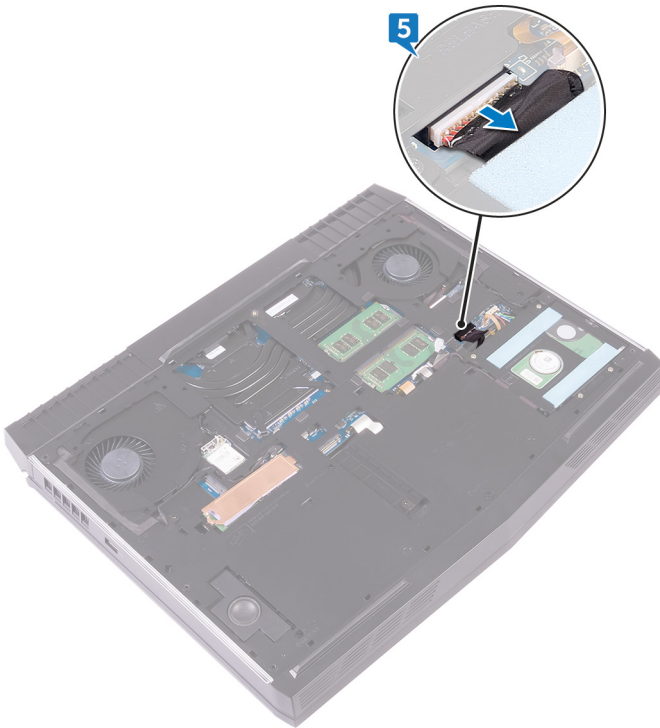

- 6 Press and hold the power button for five seconds to ground the system board.

Replacing the base cover

⚠ WARNING: Before working inside your computer, read the safety information that shipped with your computer and follow the steps in [Before working inside your computer](#). After working inside your computer, follow the instructions in [After working inside your computer](#). For more safety best practices, see the Regulatory Compliance home page at www.dell.com/regulatory_compliance.

Procedure

- 1 Connect the battery cable to the system board.

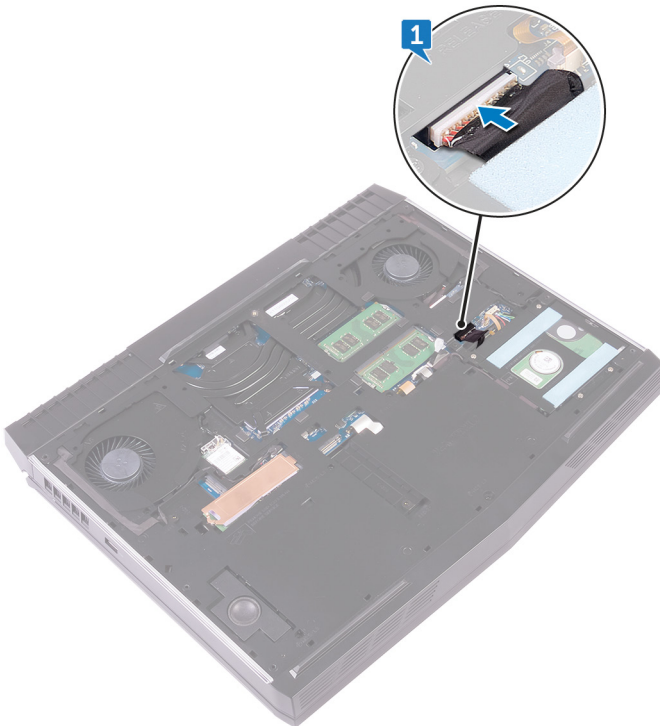

- 2 Slide the base cover into the slots on the computer base.
- 3 Snap the base cover into place.



- 4 Tighten the captive screw that secures the base cover to the computer base.

- 5 Replace the six screws (M2.5x13) that secure the base cover to the computer base.



Removing the hard drive

 **WARNING:** Before working inside your computer, read the safety information that shipped with your computer and follow the steps in [Before working inside your computer](#). After working inside your computer, follow the instructions in [After working inside your computer](#). For more safety best practices, see the Regulatory Compliance home page at www.dell.com/regulatory_compliance.

 **CAUTION:** Hard drives are fragile. Exercise care when handling the hard drive.

 **CAUTION:** To avoid data loss, do not remove the hard drive while the computer is in sleep or on state.

Prerequisites

Remove the [base cover](#).

Procedure

- 1 Using the pull-tab, disconnect the hard-drive cable from the system board.
- 2 Remove the hard-drive cable from the routing guides on the computer base.
- 3 Remove the four screws (M2.5x5) that secure the hard-drive assembly to the computer base.

- 4 Lift the hard-drive assembly along with its cable off the computer base.

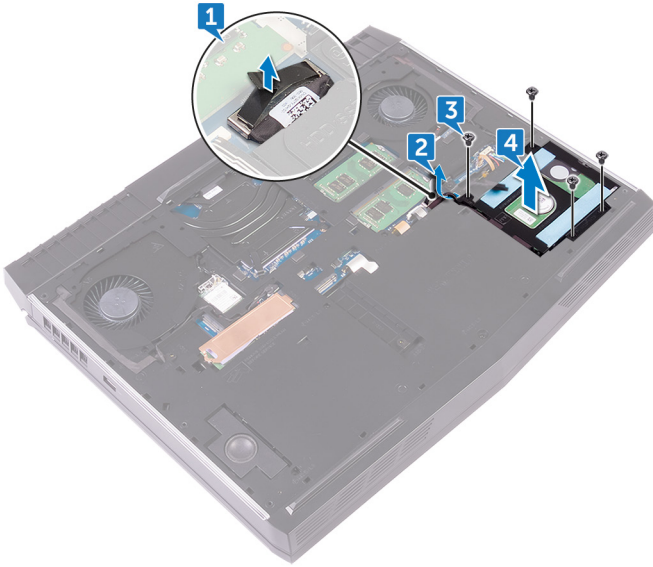

- 5 Remove the four screws (M3x3) that secure the hard-drive bracket to the hard-drive assembly.
- 6 Lift the hard-drive bracket off the hard-drive assembly.

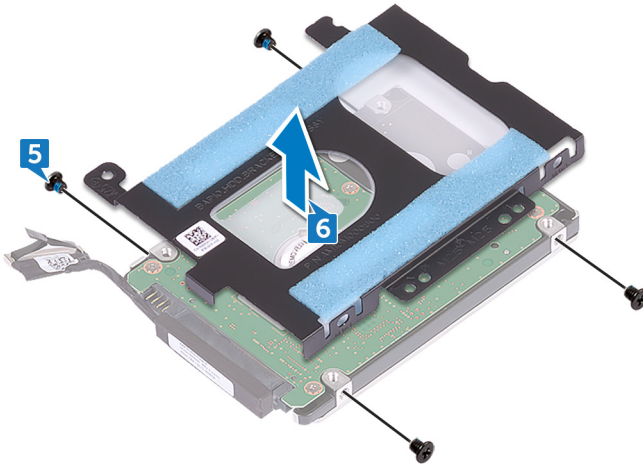

7 Disconnect the interposer from the hard drive.

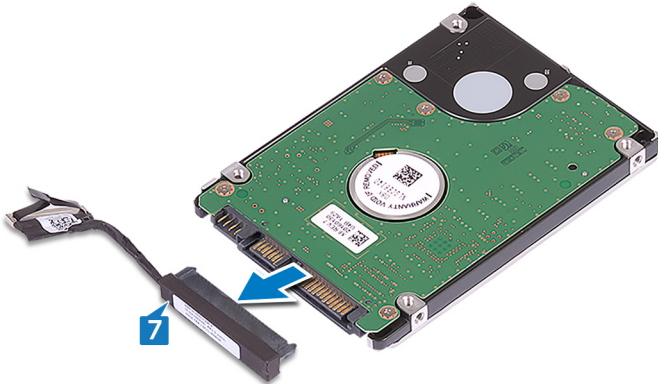

Replacing the hard drive

⚠ WARNING: Before working inside your computer, read the safety information that shipped with your computer and follow the steps in [Before working inside your computer](#). After working inside your computer, follow the instructions in [After working inside your computer](#). For more safety best practices, see the Regulatory Compliance home page at www.dell.com/regulatory_compliance.

⚠ CAUTION: Hard drives are fragile. Exercise care when handling the hard drive.

Procedure

- 1 Connect the interposer to the hard drive.

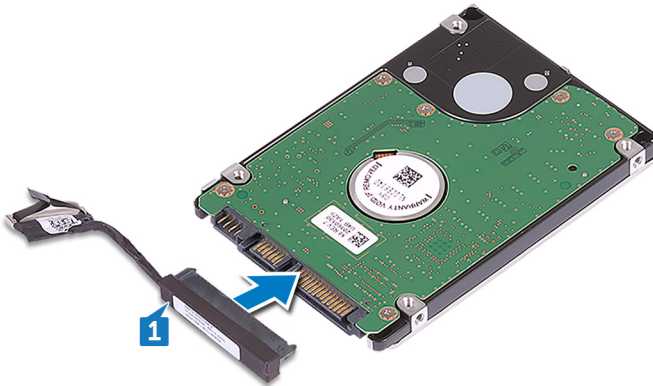

- 2 Align the screw holes on the hard-drive bracket with the screw holes on the hard-drive assembly.

- 3 Replace the four screws (M3x3) that secure the hard-drive bracket to the hard-drive assembly.

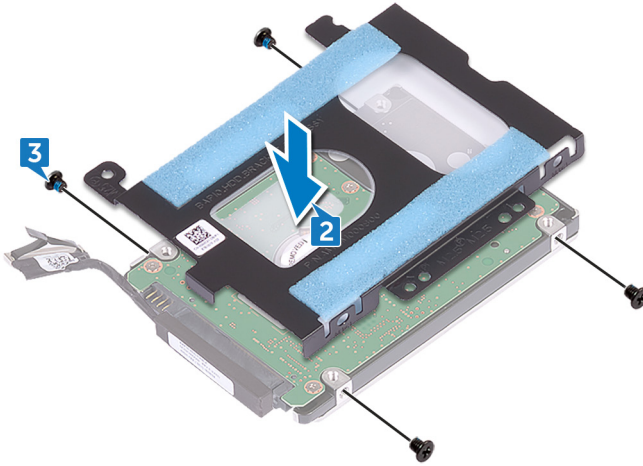

- 4 Align the screw holes on the hard-drive assembly with the screw holes on the computer base.
- 5 Replace the four screws (M2.5x5) that secure the hard-drive assembly to the computer base.
- 6 Route the hard-drive cable through the routing guides on the computer base.

- 7 Connect the hard-drive cable to the system board.

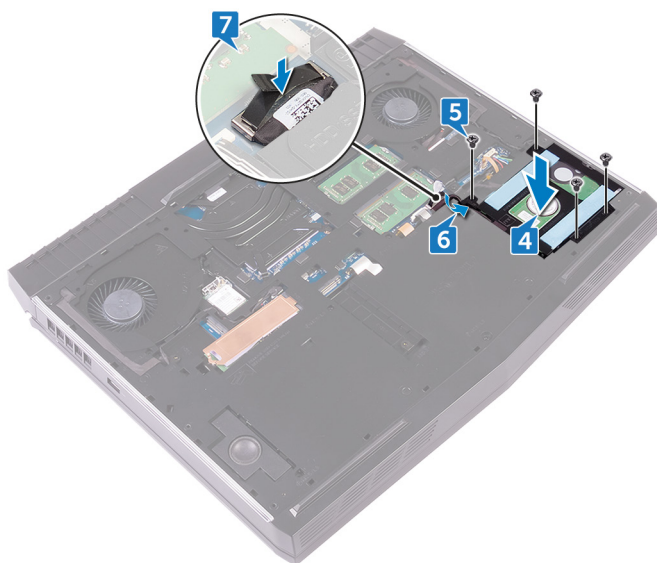

Post-requisites

Replace the [base cover](#).

Removing the wireless card

⚠ WARNING: Before working inside your computer, read the safety information that shipped with your computer and follow the steps in [Before working inside your computer](#). After working inside your computer, follow the instructions in [After working inside your computer](#). For more safety best practices, see the Regulatory Compliance home page at www.dell.com/regulatory_compliance.

Prerequisites

Remove the [base cover](#).

Procedure

- 1 Lift the flap covering the wireless card to access the wireless-card bracket and screw.



- 2 Remove the screw (M2x3) that secures the wireless-card bracket to the computer base.
- 3 Lift the wireless-card bracket off the wireless card.
- 4 Lift and slide the wireless card out of the wireless-card slot.
- 5 Disconnect the antenna cables from the wireless card.

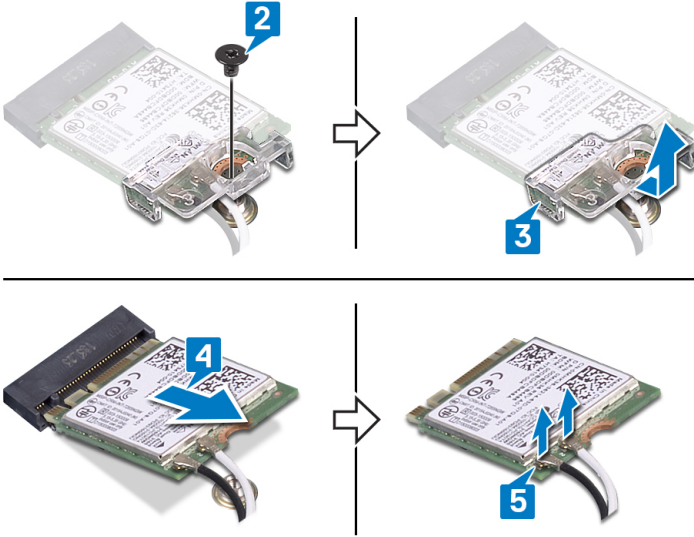

Replacing the wireless card

 **WARNING:** Before working inside your computer, read the safety information that shipped with your computer and follow the steps in [Before working inside your computer](#). After working inside your computer, follow the instructions in [After working inside your computer](#). For more safety best practices, see the Regulatory Compliance home page at www.dell.com/regulatory_compliance.

Procedure

 **CAUTION:** To avoid damaging the wireless card, do not place any cables under it.

- 1 Connect the antenna cables to the wireless card.

The following table provides the antenna-cable color scheme for the wireless card supported by your computer.

Table 2. Antenna-cable color scheme

Connectors on the wireless card	Antenna cable color
Auxiliary (black triangle)	Black
Main (white triangle)	White

- 2 Slide the wireless card bracket on to the wireless card, and align the screw hole on the wireless-card bracket with the screw hole on the wireless card.
- 3 Align the notch on the wireless card with the tab on the wireless-card slot, and then slide the wireless card at an angle into the wireless-card slot.

- 4 Press the other end of the wireless card and replace the screw (M2x3) that secures the wireless-card bracket to the computer base.

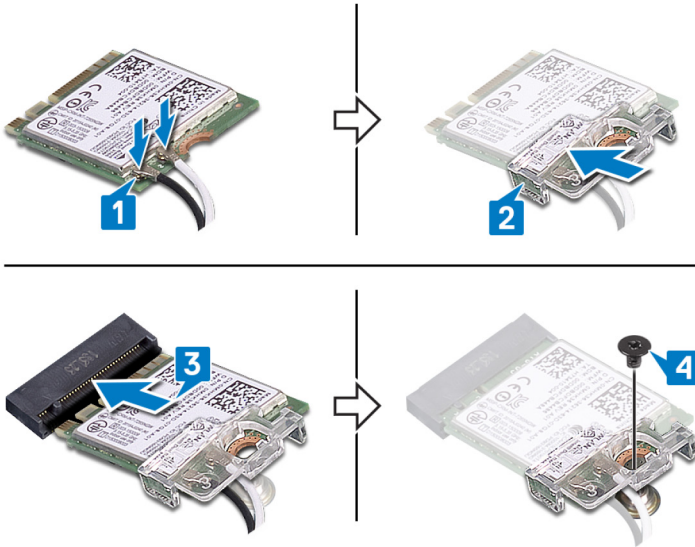

Post-requisites

Replace the [base cover](#).

Removing the solid-state drive

 **WARNING:** Before working inside your computer, read the safety information that shipped with your computer and follow the steps in [Before working inside your computer](#). After working inside your computer, follow the instructions in [After working inside your computer](#). For more safety best practices, see the Regulatory Compliance home page at www.dell.com/regulatory_compliance.

 **CAUTION:** Solid-state drives are fragile. Exercise care when handling the solid-state drive.

 **CAUTION:** To avoid data loss, do not remove the solid-state drive while the computer is in sleep or on state.

Prerequisites

Remove the [base cover](#).

Procedure

- 1 Remove the screw (M2x3) that secures the solid-state drive shield and solid-state drive to the computer base.
- 2 Peel off the solid-state drive shield from the solid-state drive.

 **NOTE:** Solid-state drive shield is applicable to computers that are shipped with 1 TB solid-state drive.

3 Slide and remove the solid-state drive from the solid-state drive slot.

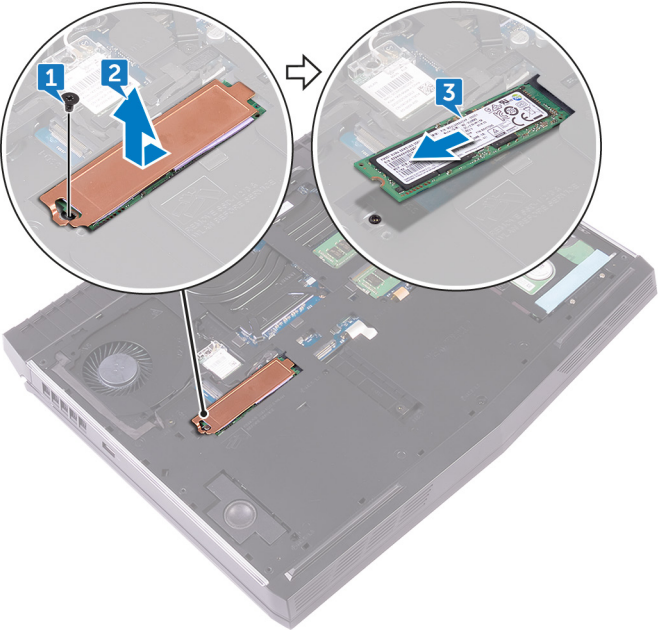

Replacing the solid-state drive

 **WARNING:** Before working inside your computer, read the safety information that shipped with your computer and follow the steps in [Before working inside your computer](#). After working inside your computer, follow the instructions in [After working inside your computer](#). For more safety best practices, see the Regulatory Compliance home page at www.dell.com/regulatory_compliance.

 **CAUTION:** Solid-state drives are fragile. Exercise care when handling the solid-state drive.

Procedure

- 1 Align the notch on the solid-state drive with the tab on the solid-state drive slot.
- 2 Slide the solid-state drive into the solid-state drive slot.
- 3 Slide and adhere the solid-state drive shield on the solid-state drive.
 -  **NOTE:** Solid-state drive shield is applicable to computers that are shipped with 1 TB solid-state drive.
- 4 Align the screw hole on the solid-state drive and solid-state drive shield with the screw hole on the computer base.

- 5 Replace the screw (M2x3) that secures the solid-state drive to the computer base.

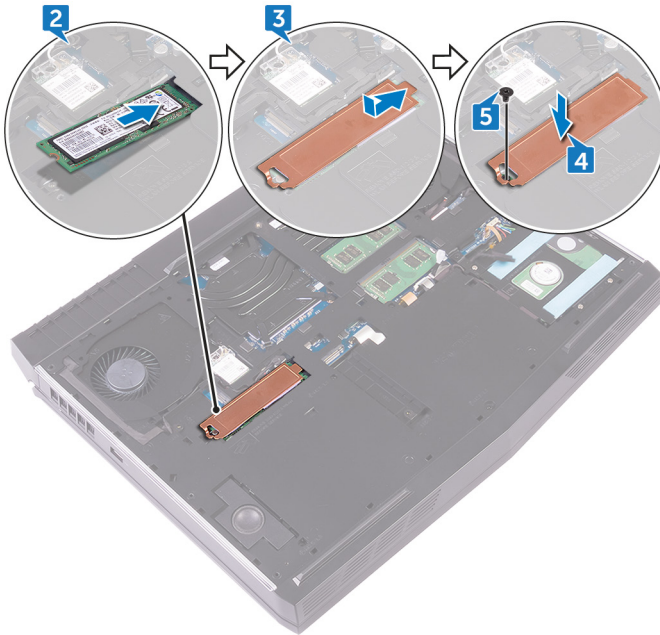

Post-requisites

Replace the [base cover](#).

Removing the memory modules

 **WARNING:** Before working inside your computer, read the safety information that shipped with your computer and follow the steps in [Before working inside your computer](#). After working inside your computer, follow the instructions in [After working inside your computer](#). For more safety best practices, see the Regulatory Compliance home page at www.dell.com/regulatory_compliance.

Prerequisites

Remove the [base cover](#).

Procedure

- 1 Using your fingertips, carefully spread apart the securing clips on each end of the memory-module slot until the memory module pops up.

2 Slide and remove the memory module from the memory-module slot.

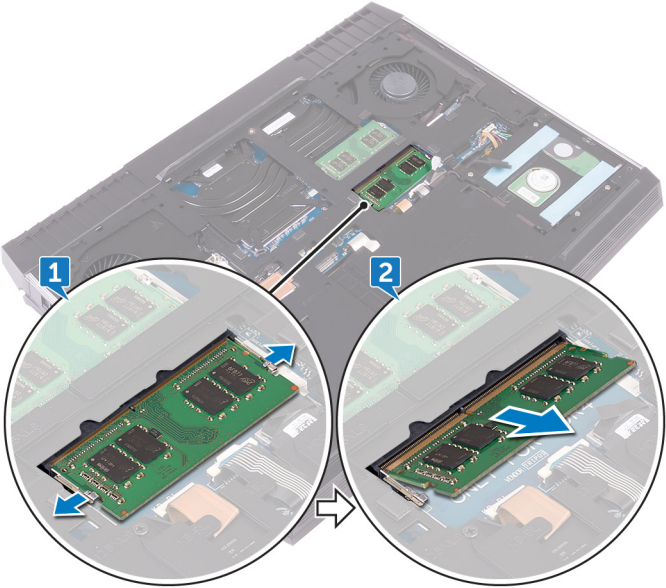

Replacing the memory modules

⚠ WARNING: Before working inside your computer, read the safety information that shipped with your computer and follow the steps in [Before working inside your computer](#). After working inside your computer, follow the instructions in [After working inside your computer](#). For more safety best practices, see the Regulatory Compliance home page at www.dell.com/regulatory_compliance.

Procedure

- 1 Align the notch on the memory module with the tab on the memory-module slot and slide the memory module firmly into the slot at an angle.
- 2 Press the memory module down until it clicks into place.

🔧 NOTE: If you do not hear the click, remove the memory module and reinstall it.

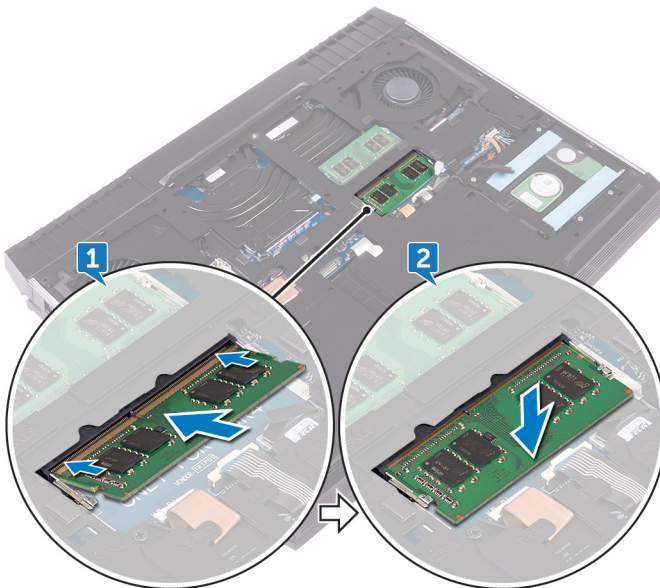

Post-requisites

Replace the [base cover](#).

Removing the rear-I/O cover

 **WARNING:** Before working inside your computer, read the safety information that shipped with your computer and follow the steps in [Before working inside your computer](#). After working inside your computer, follow the instructions in [After working inside your computer](#). For more safety best practices, see the Regulatory Compliance home page at www.dell.com/regulatory_compliance.

Prerequisites

Remove the [base cover](#).

Procedure

- 1 Remove the two screws (M2.5x7) that secure the rear-I/O cover to the palm-rest assembly.
- 2 Using a plastic scribe, disengage the rear-I/O cover from the computer base on the proper pry locations.

3 Pull the rear-I/O cover from the computer base.

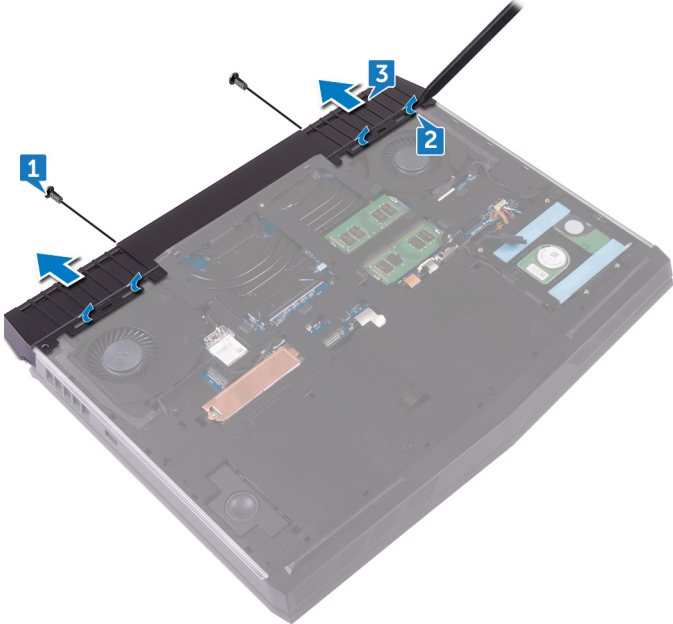

Replacing the rear-I/O cover

⚠ WARNING: Before working inside your computer, read the safety information that shipped with your computer and follow the steps in [Before working inside your computer](#). After working inside your computer, follow the instructions in [After working inside your computer](#). For more safety best practices, see the Regulatory Compliance home page at www.dell.com/regulatory_compliance.

Procedure

- 1 Align the tabs on the rear-I/O cover with the slots on the computer base and snap the rear-I/O cover into place.
- 2 Replace the two screws (M2.5x7) that secure the rear-I/O cover to the palm-rest assembly.

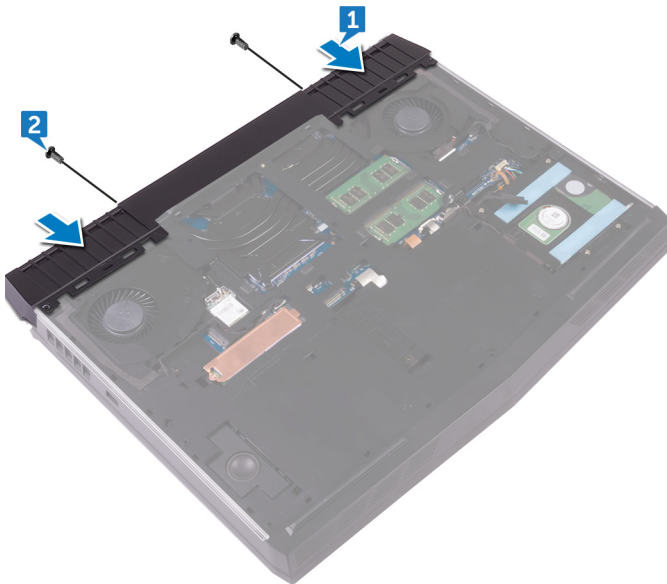

Post-requisites

Replace the [base cover](#).

Removing the computer base



WARNING: Before working inside your computer, read the safety information that shipped with your computer and follow the steps in [Before working inside your computer](#). After working inside your computer, follow the instructions in [After working inside your computer](#). For more safety best practices, see the Regulatory Compliance home page at www.dell.com/regulatory_compliance.

Prerequisites

- 1 Remove the [base cover](#).
- 2 Follow the procedure from step 1 to step 4 in "[Removing the hard drive](#)".
- 3 Remove the [wireless card](#).
- 4 Remove the [solid-state drive](#).
- 5 Remove the [rear-I/O cover](#).

Procedure

- 1 Note the antenna cables routing and remove them from the routing guides on the computer base.

- 2 Disconnect the left and right tron-light cables from the system board.

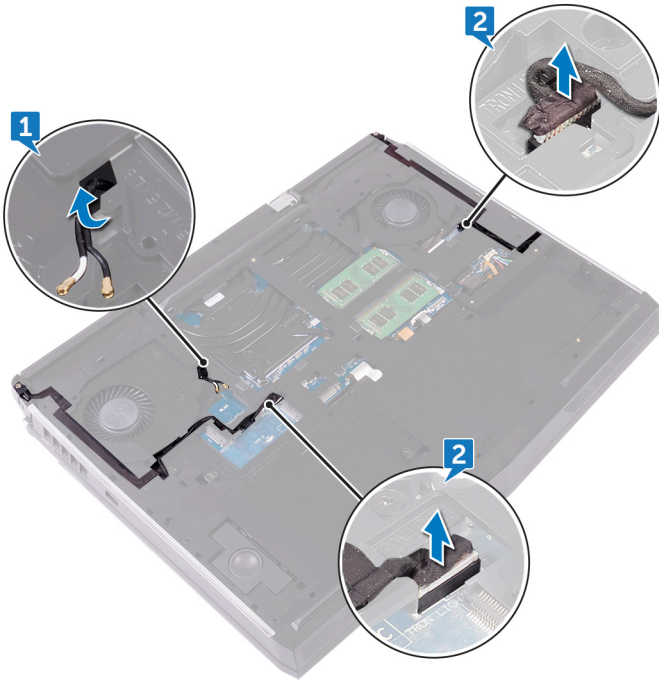

- 3 Remove the two screws (M2.5x5) that secure the tron-light holder to the palm-rest assembly.

- 4 Remove the 14 screws (M2.5x8) that secure the computer base to the palm-rest assembly.

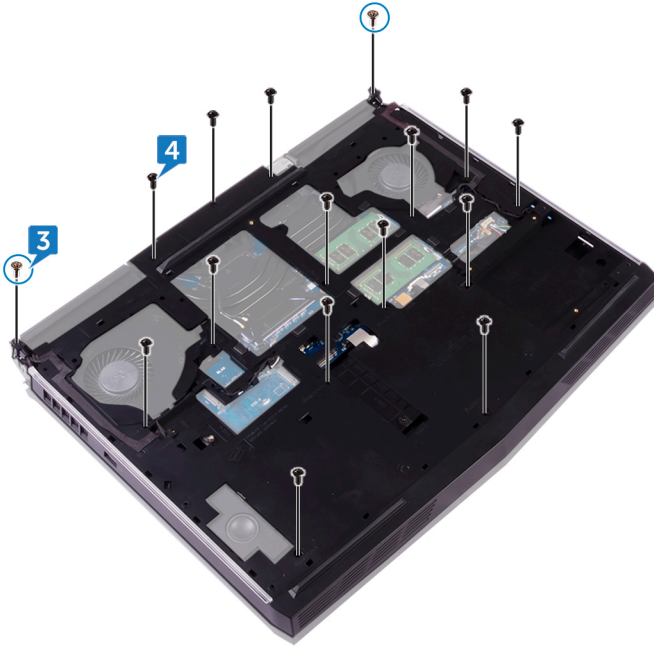

- 5 Starting from left corner, pry the computer base off the palm-rest assembly.

6 Lift the computer base off the palm-rest assembly.

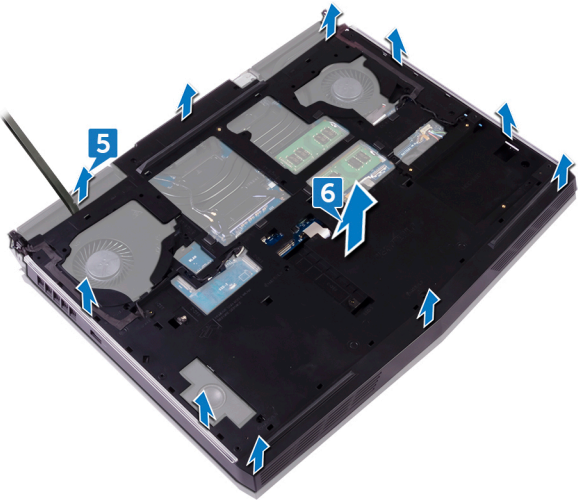

Replacing the computer base

⚠ WARNING: Before working inside your computer, read the safety information that shipped with your computer and follow the steps in [Before working inside your computer](#). After working inside your computer, follow the instructions in [After working inside your computer](#). For more safety best practices, see the Regulatory Compliance home page at www.dell.com/regulatory_compliance.

Procedure

✍ NOTE: Ensure that the antenna cables are not covered by the computer base.

- 1 Align the screw holes on the computer base with the screw holes on the palm-rest assembly.
- 2 Align the screw holes on the tron-light holder with the screws holes on the palm-rest assembly.

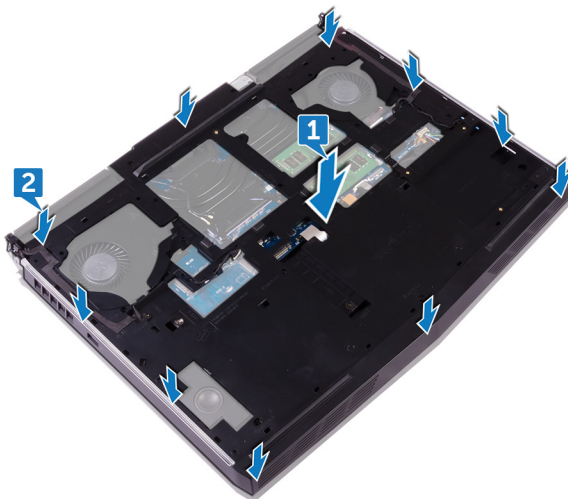

- 3 Replace the 14 screws (M2.5x8) that secure the computer base to the palm-rest assembly.

- 4 Replace the two screws (M2.5x5) that secure the tron-light holder to the palm-rest assembly.

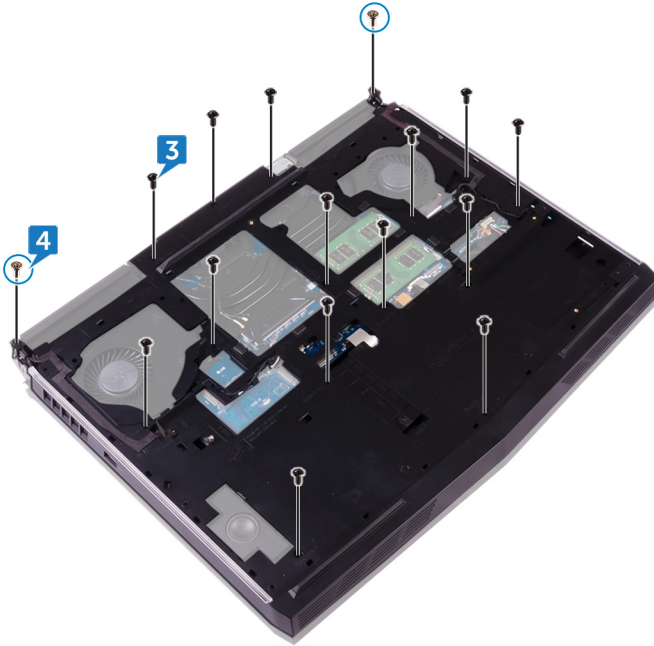

- 5 Connect the left and right tron-light cables to the system board.

- 6 Route the antenna cables through the routing guides on the computer base.

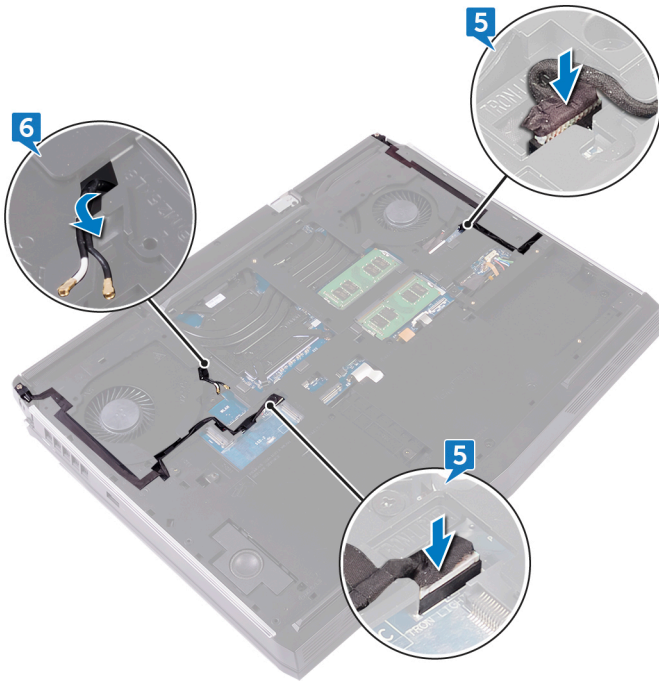

Post-requisites

- 1 Replace the [rear-I/O cover](#).
- 2 Replace the [solid-state drive](#).
- 3 Replace the [wireless card](#).
- 4 Follow the procedure from step 4 to step 7 in "[Replacing the hard drive](#)".
- 5 Replace the [base cover](#).

Removing the coin-cell battery

 **WARNING:** Before working inside your computer, read the safety information that shipped with your computer and follow the steps in [Before working inside your computer](#). After working inside your computer, follow the instructions in [After working inside your computer](#). For more safety best practices, see the Regulatory Compliance home page at www.dell.com/regulatory_compliance.

 **CAUTION:** Removing the coin-cell battery resets the BIOS setup program's settings to default. It is recommended that you note the BIOS setup program's settings before removing the coin-cell battery.

Prerequisites

- 1 Remove the [base cover](#).
- 2 Follow the procedure from step 1 to step 4 in "[Removing the hard drive](#)".
- 3 Remove the [wireless card](#).
- 4 Remove the [solid-state drive](#).
- 5 Remove the [rear-I/O cover](#).
- 6 Remove the [computer base](#).

Procedure

- 1 Disconnect the coin-cell battery cable from the system board.
- 2 Peel the tape to access the coin-cell battery cable on the system board.
- 3 Peel the tape to access the coin-cell battery on the palm-rest assembly.
- 4 Note the cable routing, and remove the coin-cell battery cable from the routing guide on the palm-rest assembly.

- 5 Gently peel the coin-cell battery along with its cable off the palm-rest assembly.

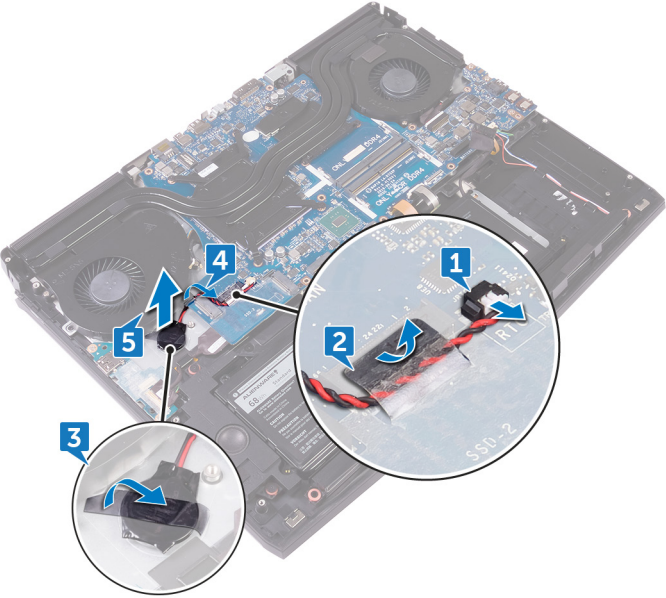

Replacing the coin-cell battery

 **WARNING:** Before working inside your computer, read the safety information that shipped with your computer and follow the steps in [Before working inside your computer](#). After working inside your computer, follow the instructions in [After working inside your computer](#). For more safety best practices, see the Regulatory Compliance home page at www.dell.com/regulatory_compliance.

Procedure

- 1 Adhere the coin-cell battery to the palm-rest assembly.
- 2 Adhere the tape that secures the coin-cell battery to the palm-rest assembly.
- 3 Route the coin-cell battery cable through the routing guide and adhere the tape that secures the coin-cell battery cable to the system board.
- 4 Adhere the tape that secures the coin-cell battery cable to the system board.

- 5 Connect the coin-cell battery cable to the system board.

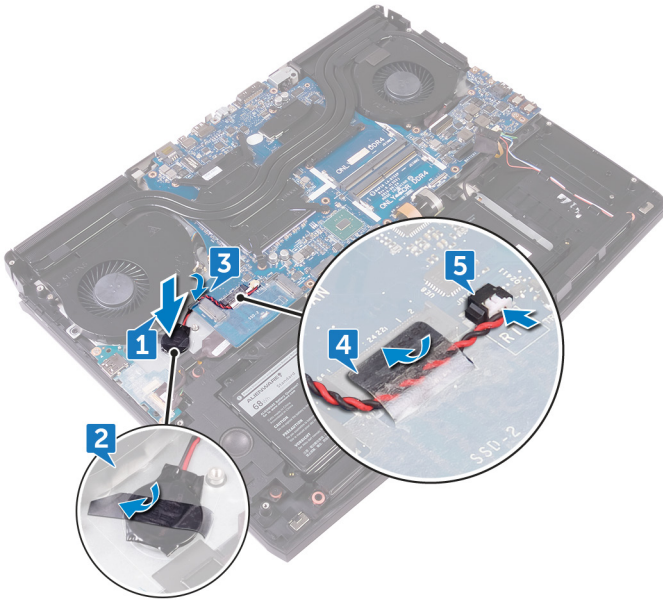

Post-requisites

- 1 Replace the [computer base](#).
- 2 Replace the [rear-I/O cover](#).
- 3 Replace the [solid-state drive](#).
- 4 Replace the [wireless card](#).
- 5 Follow the procedure from step 4 to step 7 in "[Replacing the hard drive](#)".
- 6 Replace the [base cover](#).

Removing the speakers

 **WARNING:** Before working inside your computer, read the safety information that shipped with your computer and follow the steps in [Before working inside your computer](#). After working inside your computer, follow the instructions in [After working inside your computer](#). For more safety best practices, see the Regulatory Compliance home page at www.dell.com/regulatory_compliance.

Prerequisites

- 1 Remove the [base cover](#).
- 2 Follow the procedure from step 1 to step 4 in "[Removing the hard drive](#)".
- 3 Remove the [wireless card](#).
- 4 Remove the [solid-state drive](#).
- 5 Remove the [rear-I/O cover](#).
- 6 Remove the [computer base](#).

Procedure

- 1 Disconnect the speaker cable from the system board.
- 2 Remove the speaker cable from the routing guides on the palm-rest assembly.

3 Lift the speakers along with its cable off the palm-rest assembly.

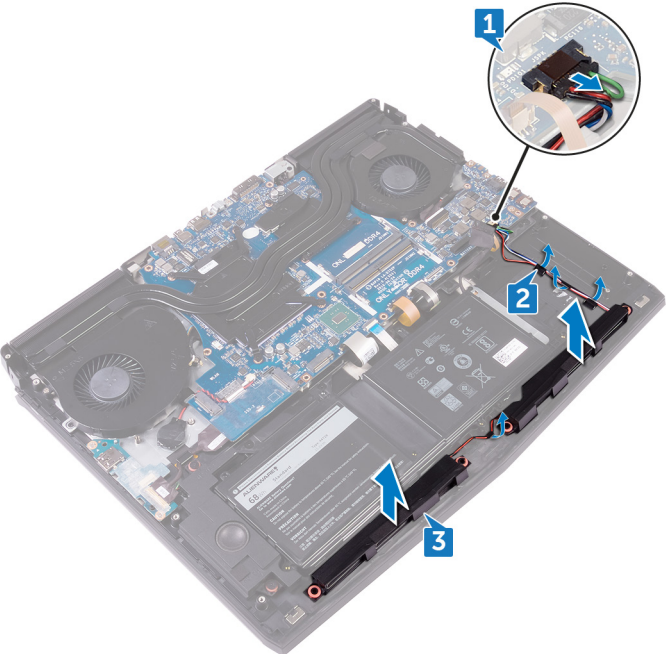

Replacing the speakers

 **WARNING:** Before working inside your computer, read the safety information that shipped with your computer and follow the steps in [Before working inside your computer](#). After working inside your computer, follow the instructions in [After working inside your computer](#). For more safety best practices, see the Regulatory Compliance home page at www.dell.com/regulatory_compliance.

Procedure

1 Using the alignment posts, place the speakers on the palm-rest assembly.



NOTE: The rubber grommets may get pushed out while replacing the speaker. Ensure that the rubber grommets are in their position after placing the speaker on the system board.

2 Route the speaker cable through the routing guides on the palm-rest assembly.

- 3 Connect the speaker cable to the system board.

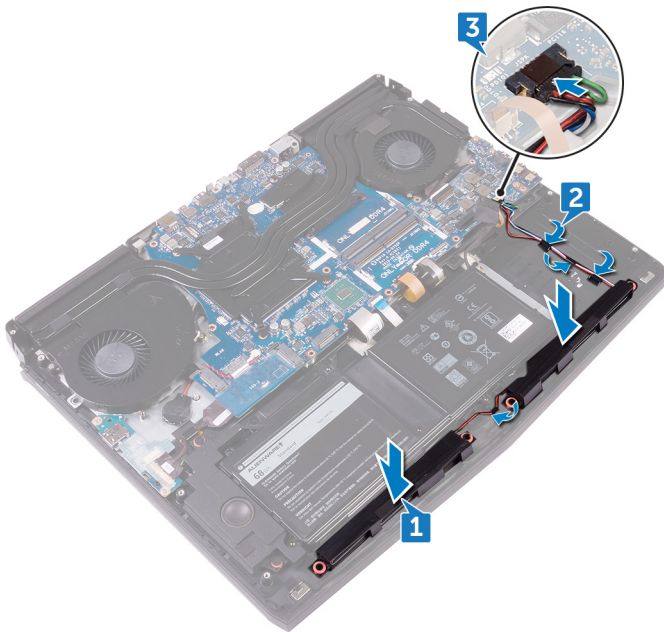

Post-requisites

- 1 Replace the [computer base](#).
- 2 Replace the [rear-I/O cover](#).
- 3 Replace the [solid-state drive](#).
- 4 Replace the [wireless card](#).
- 5 Follow the procedure from step 4 to step 7 in "[Replacing the hard drive](#)".
- 6 Replace the [base cover](#).

Removing the I/O board

 **WARNING:** Before working inside your computer, read the safety information that shipped with your computer and follow the steps in [Before working inside your computer](#). After working inside your computer, follow the instructions in [After working inside your computer](#). For more safety best practices, see the Regulatory Compliance home page at www.dell.com/regulatory_compliance.

Prerequisites

- 1 Remove the [base cover](#).
- 2 Follow the procedure from step 1 to step 4 in "[Removing the hard drive](#)".
- 3 Remove the [wireless card](#).
- 4 Remove the [solid-state drive](#).
- 5 Remove the [rear-I/O cover](#).
- 6 Remove the [computer base](#).

Procedure

- 1 Peel the tape to access the I/O-board cable on the I/O board.
- 2 Open the latch and disconnect the I/O-board cable from the I/O board.
- 3 Remove the two screws (M2.5x5) that secure the I/O board to the palm-rest assembly.

- 4 Turn the I/O board over.

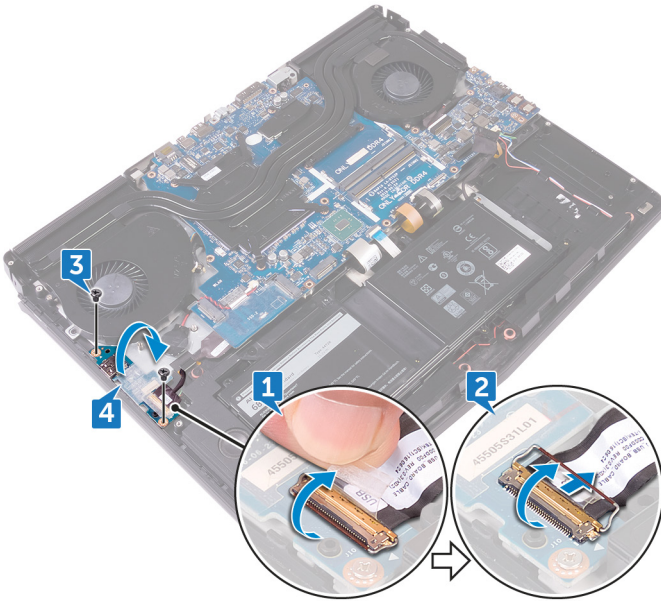

- 5 Disconnect the subwoofer cable.

6 Lift the I/O board off the palm-rest assembly.

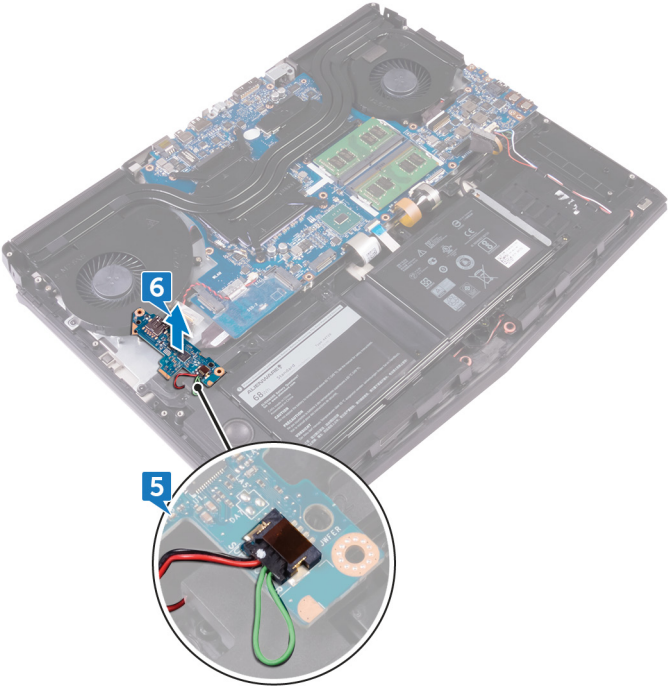

Replacing the I/O board

⚠ WARNING: Before working inside your computer, read the safety information that shipped with your computer and follow the steps in [Before working inside your computer](#). After working inside your computer, follow the instructions in [After working inside your computer](#). For more safety best practices, see the Regulatory Compliance home page at www.dell.com/regulatory_compliance.

Procedure

- 1 Connect the subwoofer cable to the I/O board.
- 2 Turn the I/O board over.

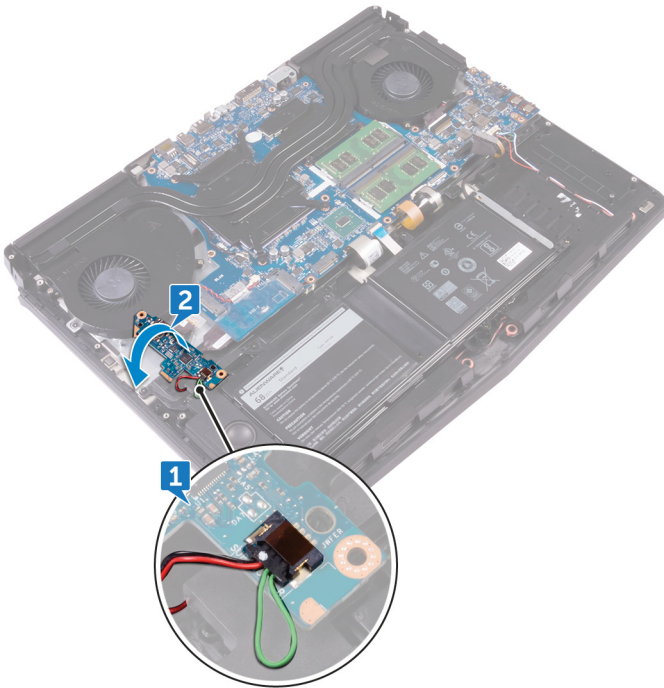

- 3 Using the alignment posts, place the I/O board on the palm-rest assembly and align the screw holes on the I/O board with the screw holes on the palm-rest assembly.
- 4 Replace the two screws (M2.5x5) that secure the I/O board to the palm-rest assembly.
- 5 Slide the I/O-board cable into the connector on the I/O board and close the latch to secure the cable.
- 6 Adhere the tape that secures the I/O-board cable to the I/O board.

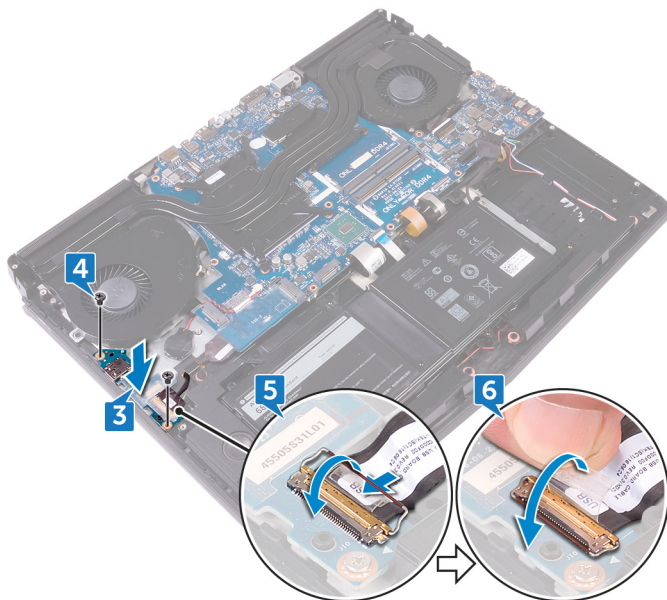

Post-requisites

- 1 Replace the [computer base](#).
- 2 Replace the [rear-I/O cover](#).
- 3 Replace the [solid-state drive](#).
- 4 Replace the [wireless card](#).
- 5 Follow the procedure from step 4 to step 7 in "[Replacing the hard drive](#)".
- 6 Replace the [base cover](#).

Removing the subwoofer

 **WARNING:** Before working inside your computer, read the safety information that shipped with your computer and follow the steps in [Before working inside your computer](#). After working inside your computer, follow the instructions in [After working inside your computer](#). For more safety best practices, see the Regulatory Compliance home page at www.dell.com/regulatory_compliance.

Prerequisites

- 1 Remove the [base cover](#).
- 2 Follow the procedure from step 1 to step 4 in "[Removing the hard drive](#)".
- 3 Remove the [wireless card](#).
- 4 Remove the [solid-state drive](#).
- 5 Remove the [rear-I/O cover](#).
- 6 Remove the [computer base](#).
- 7 Remove the [I/O board](#).

Procedure

- 1 Remove the two screws (M2x2) that secure the subwoofer to the palm-rest assembly.

2 Lift the subwoofer along with its cable off the palm-rest assembly.

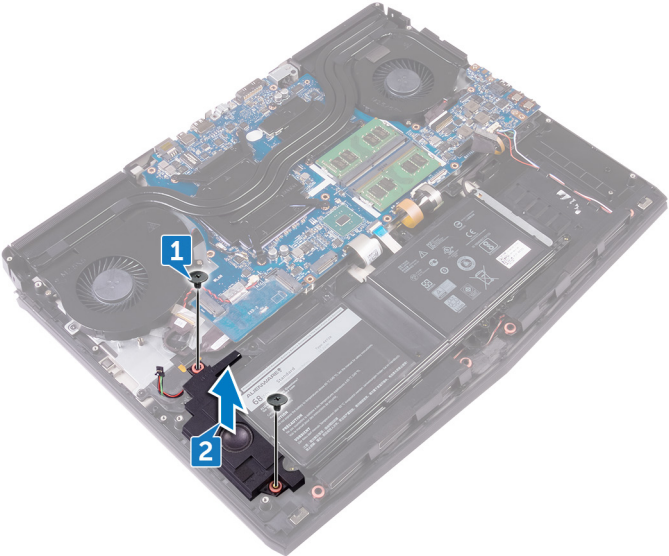

Replacing the subwoofer

⚠ WARNING: Before working inside your computer, read the safety information that shipped with your computer and follow the steps in [Before working inside your computer](#). After working inside your computer, follow the instructions in [After working inside your computer](#). For more safety best practices, see the Regulatory Compliance home page at www.dell.com/regulatory_compliance.

Procedure



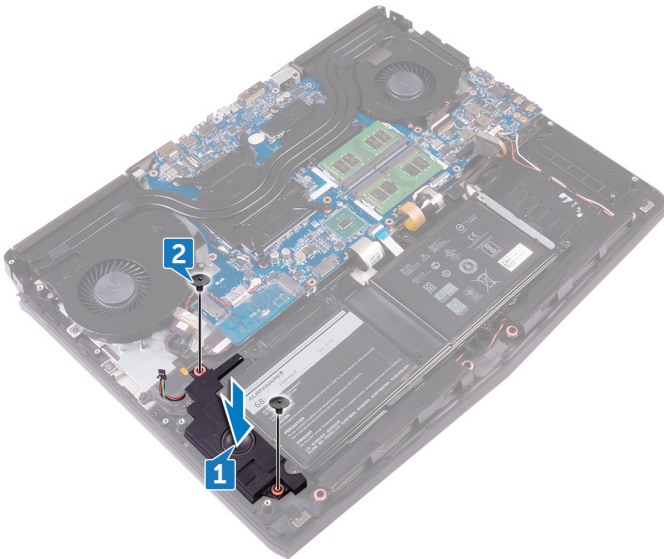

- 1 Align the screw holes on the subwoofer with the screw holes on the palm-rest assembly.
- 2 Replace the two screws (M2x2) that secure the subwoofer to the palm-rest assembly.



Post-requisites

- 1 Replace the [I/O board](#).
- 2 Replace the [computer base](#).
- 3 Replace the [rear-I/O cover](#).
- 4 Replace the [solid-state drive](#).
- 5 Replace the [wireless card](#).
- 6 Follow the procedure from step 4 to step 7 in "[Replacing the hard drive](#)".
- 7 Replace the [base cover](#).

Removing the system board

-  **WARNING:** Before working inside your computer, read the safety information that shipped with your computer and follow the steps in [Before working inside your computer](#). After working inside your computer, follow the instructions in [After working inside your computer](#). For more safety best practices, see the Regulatory Compliance home page at www.dell.com/regulatory_compliance.
-  **NOTE:** Your computer's Service Tag is stored in the system board. You must enter the Service Tag in the BIOS setup program after you replace the system board.
-  **NOTE:** Replacing the system board removes any changes you have made to the BIOS using the BIOS setup program. You must make the appropriate changes again after you replace the system board.
-  **NOTE:** Before disconnecting the cables from the system board, note the location of the connectors so that you can reconnect the cables correctly after you replace the system board.

Prerequisites

- 1 Remove the [base cover](#).
- 2 Follow the procedure from step 1 to step 4 in "[Removing the hard drive](#)".
- 3 Remove the [wireless card](#).
- 4 Remove the [solid-state drive](#).
- 5 Remove the [rear-I/O cover](#).
- 6 Remove the [computer base](#).
- 7 Remove the [memory modules](#).

Procedure

- 1 Turn the computer over.
- 2 Peel the tape to access the display cable on the system board.
- 3 Open the latch and disconnect the display cable from the system board.

- 4 Disconnect the tobii eye-tracker board cable (optional) from the system board.
- 5 Open the latch and disconnect the power-button board cable from the system board.
- 6 Disconnect the logo-board cable from the system board.

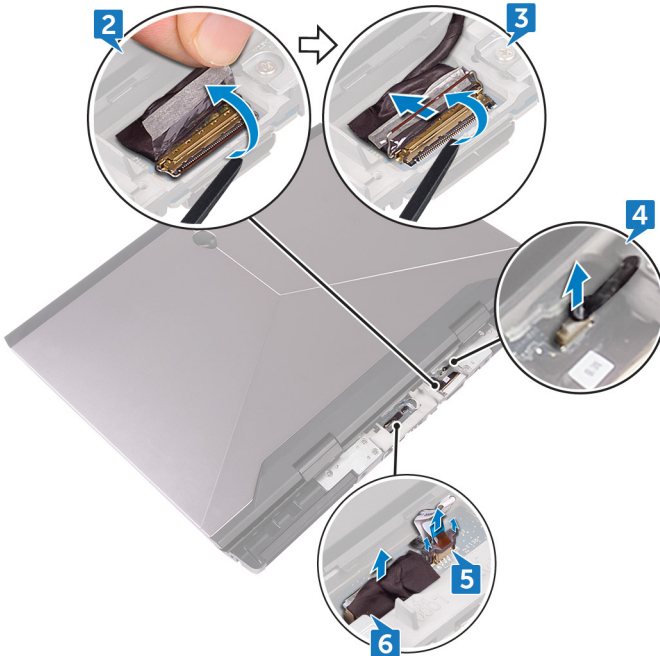

- 7 Turn the computer over.
- 8 Open the latch and disconnect the macro-keys backlight cable (optional) from the system board.
- 9 Open the latch and disconnect the macro-keys cable (optional) from the system board.
- 10 Open the latch and disconnect the keyboard-backlight cable (optional) from the system board.

- 11 Open the latch and disconnect the keyboard cable (optional) from the system board.

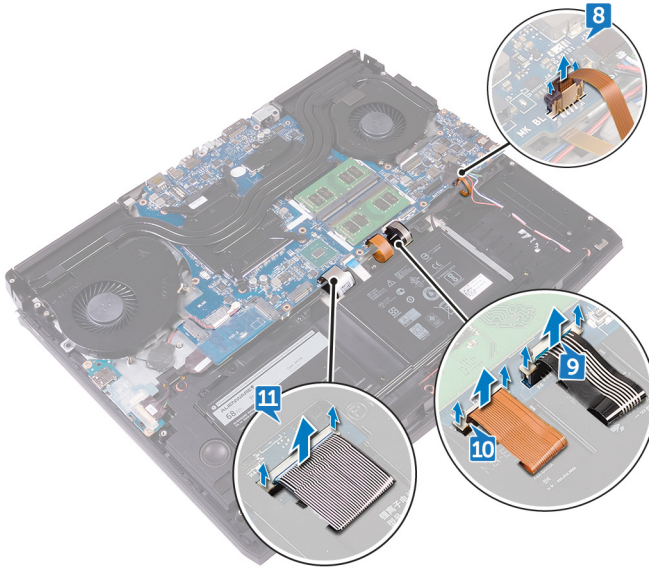

- 12 Peel the tape to access the I/O-board cable to the I/O board.
- 13 Open the latch and disconnect the I/O-board cable from the I/O board.
- 14 Open the latch and disconnect the touchpad cable from the system board.
- 15 Open the latch and disconnect the RGB per key keyboard cable (optional) from the system board.
- 16 Disconnect the speaker cable from the system board.
- 17 Disconnect the power-adapter port cable from the system board.
- 18 Disconnect the coin-cell battery cable from the system board.

19 Peel the tape that secures the coin-cell battery cable to the system board.

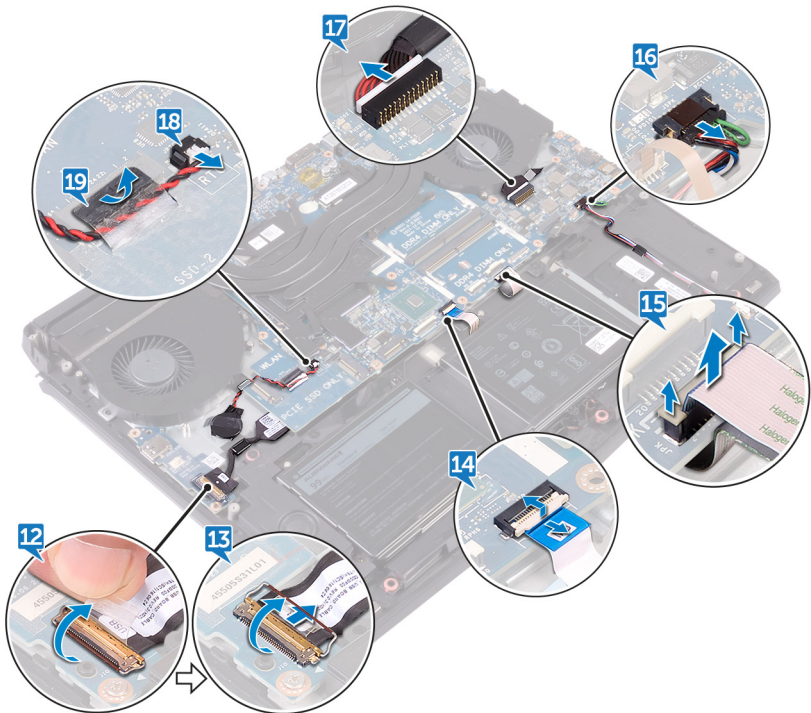

20 Remove the screw (M2.5x5) that secures the USB Type-C port bracket to the system board and lift the USB Type-C port bracket off the system board.

21 Remove the seven screws (M2.5x5) that secure the system-board assembly to the palm-rest assembly.

22 Lift the system-board assembly off the palm-rest assembly.

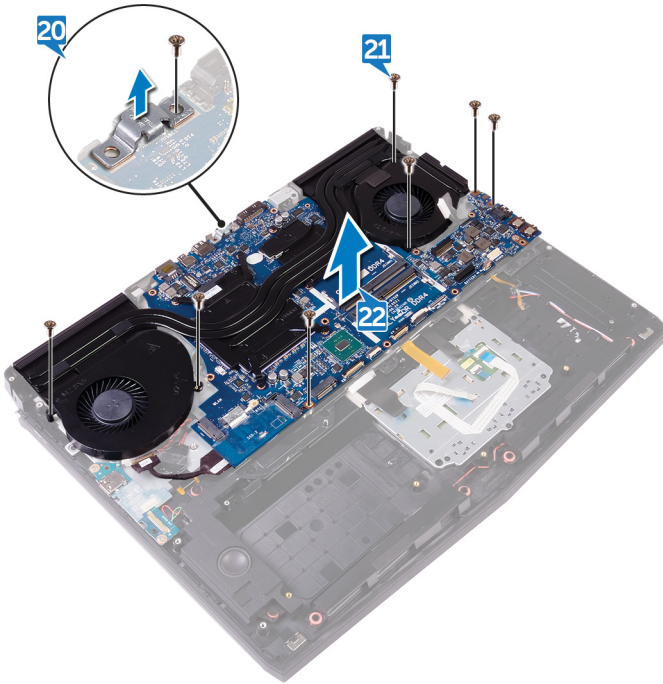

23 Remove the [heat-sink assembly](#).

24 Disconnect the I/O-board cable from the back of the system board.

25 After performing all the above steps, you are left with the system board.

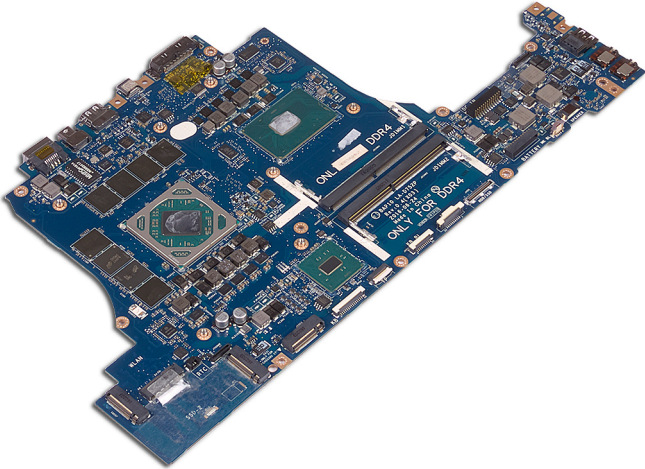

Replacing the system board

 **WARNING:** Before working inside your computer, read the safety information that shipped with your computer and follow the steps in [Before working inside your computer](#). After working inside your computer, follow the instructions in [After working inside your computer](#). For more safety best practices, see the Regulatory Compliance home page at www.dell.com/regulatory_compliance.

 **NOTE:** Your computer's Service Tag is stored in the system board. You must enter the Service Tag in the BIOS setup program after you replace the system board.

 **NOTE:** Replacing the system board removes any changes you have made to the BIOS using the BIOS setup program. You must make the appropriate changes again after you replace the system board.

Procedure

 **CAUTION:** Ensure that there are no cables under the system board.

- 1 Replace the [heat-sink assembly](#).
- 2 Connect the I/O-board cable to the back of the system board.
- 3 Align the screw holes on the system board with the screw holes on the palm-rest assembly.
- 4 Replace the seven screws (M2.5x5) that secure the system-board assembly to the palm-rest assembly.
- 5 Align the screw hole on the USB Type-C port bracket with the screw hole on the system board.

- 6 Replace the screw (M2.5x5) that secures the USB Type-C port bracket to the system board.

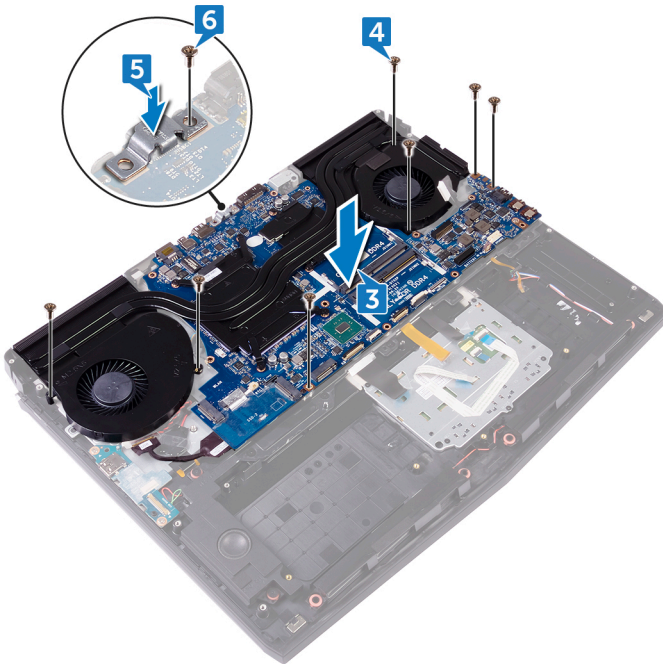

- 7 Slide the I/O-board cable into the connector on the I/O-board and close the latch to secure the cable.
- 8 Adhere the tape that secures the I/O-board cable to the I/O board.
- 9 Slide the touchpad cable into the connector on the system board and close the latch to secure the cable.
- 10 Insert the RGB per key keyboard cable (optional) into the connector and press down the latch to secure the cable.
- 11 Connect the speaker cable to the system board.
- 12 Connect the power-adaptor port cable to the system board.
- 13 Route the coin-cell battery through the routing channel and adhere the tape to secure the cable.

14 Connect the coin-cell battery cable to the system board.

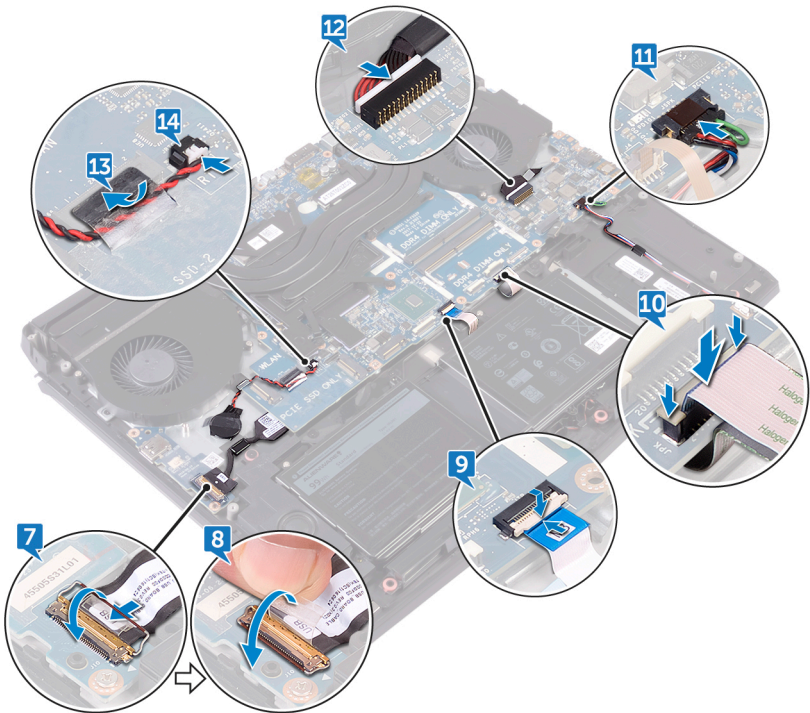

15 Slide the keyboard cable (optional) into the connector on the system board and close the latch to secure the cable.

16 Slide the keyboard-backlight cable (optional) into the connector on the system board and close the latch to secure the cable.

17 Slide the macro-keys cable (optional) into the connector on the system board and close the latch to secure the cable.

- 18** Slide the macro-keys backlight cable (optional) into the connector on the system board and close the latch to secure the cable.

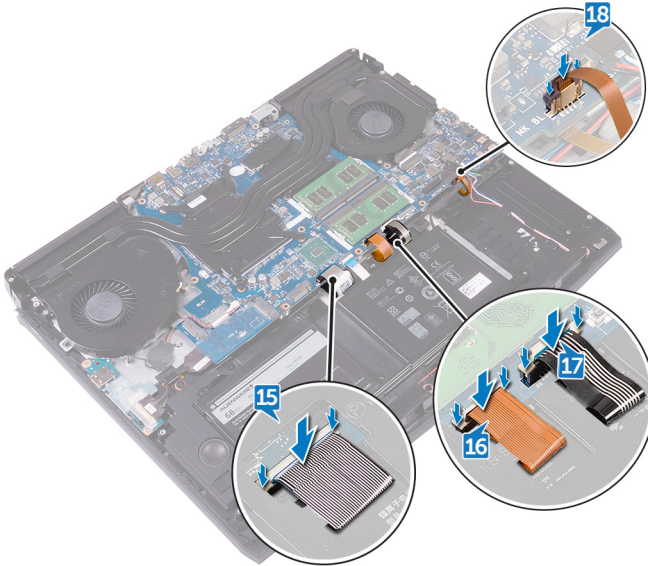

- 19** Turn the computer over.
- 20** Connect the logo-board cable to the system board.
- 21** Slide the power-button board cable into the connector on the system board and close the latch to secure the cable.
- 22** Connect the tobii eye-tracker board cable to the system board.
- 23** Slide the display cable into the connector on the system board and close the latch to secure the cable.

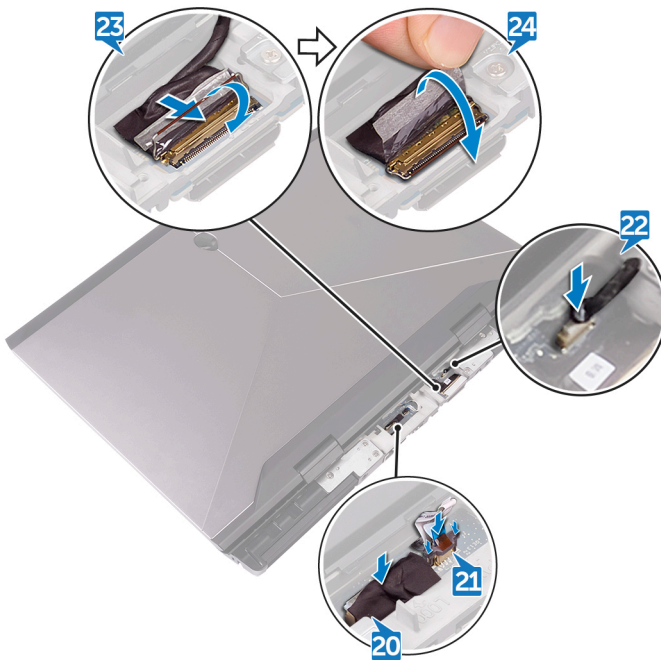

24 Adhere the tape that secures the display cable to the system board.



Post-requisites

- 1 Replace the [memory modules](#).
- 2 Replace the [computer base](#).
- 3 Replace the [rear-I/O cover](#).
- 4 Replace the [solid-state drive](#).
- 5 Replace the [wireless card](#).
- 6 Follow the procedure from step 4 to step 7 in "[Replacing the hard drive](#)".
- 7 Replace the [base cover](#).

Removing the heat-sink assembly

-  **WARNING:** Before working inside your computer, read the safety information that shipped with your computer and follow the steps in [Before working inside your computer](#). After working inside your computer, follow the instructions in [After working inside your computer](#). For more safety best practices, see the Regulatory Compliance home page at www.dell.com/regulatory_compliance.
-  **WARNING:** The heat sink may become hot during normal operation. Allow sufficient time for the heat sink to cool before you touch it.
-  **CAUTION:** For maximum cooling of the processor, do not touch the heat transfer areas on the heat sink. The oils in your skin can reduce the heat transfer capability of the thermal grease.

Prerequisites

- 1 Remove the [base cover](#).
- 2 Follow the procedure from step 1 to step 4 in "[Removing the hard drive](#)".
- 3 Remove the [wireless card](#).
- 4 Remove the [solid-state drive](#).
- 5 Remove the [memory modules](#).
- 6 Remove the [rear-I/O cover](#).
- 7 Remove the [computer base](#).
- 8 Follow the procedure from step 1 to step 22 in "[Removing the system board](#)".

Procedure

- 1 Turn the system-board assembly over.
- 2 Disconnect the fan cable from the system board.
- 3 Peel off the tape that secures the fan cable to the fan.
- 4 Disconnect the fan cable from the system board.

- 5 Peel off the tape that secures the fan cable to the fan.

 **NOTE:** For computers shipped with NVIDIA GeForce GTX 1060 graphics controller, remove the fans after disconnecting the fan cables from the system board.

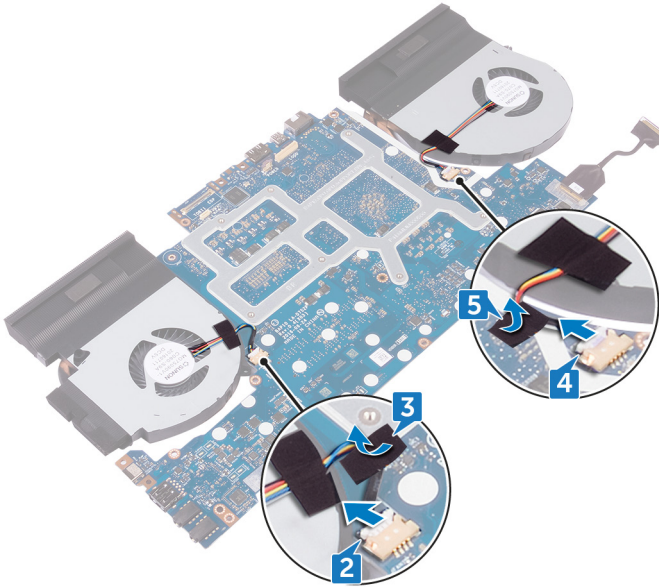

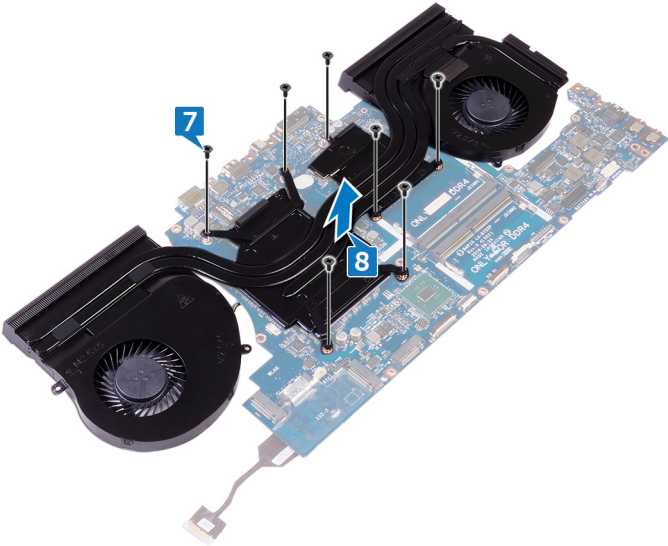

- 6 Turn the system-board assembly over.
- 7 Remove the seven screws (M2x3) that secure the heat-sink assembly to the system board.

8 Lift the heat-sink assembly off the system board.



Replacing the heat-sink assembly

-  **WARNING:** Before working inside your computer, read the safety information that shipped with your computer and follow the steps in [Before working inside your computer](#). After working inside your computer, follow the instructions in [After working inside your computer](#). For more safety best practices, see the Regulatory Compliance home page at www.dell.com/regulatory_compliance.
-  **CAUTION:** Incorrect alignment of the heat sink can damage the system board and processor.
-  **NOTE:** If either the system board or the fan and heat-sink assembly is replaced, use the thermal pad provided in the kit to ensure that thermal conductivity is achieved.

Procedure

- 1 Align the screw holes on the heat-sink assembly with the screw holes on the system board.

- 2 Replace the seven screws (M2x3) that secure the heat-sink assembly to the system board.

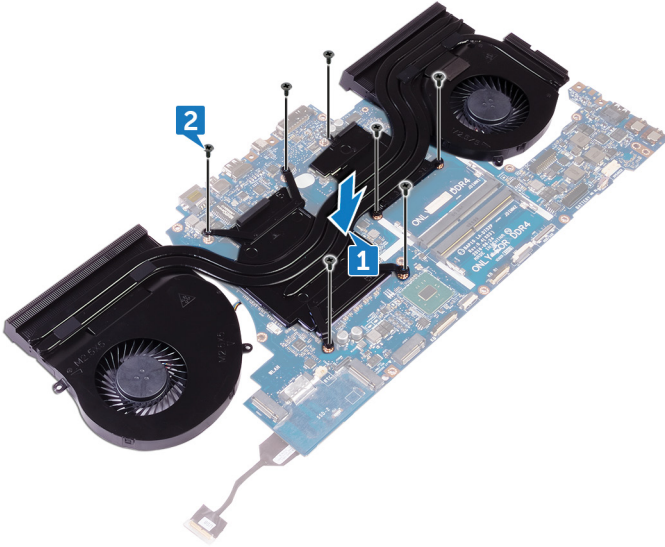

- 3 Turn the system-board assembly over.

 **NOTE: For computers shipped with NVIDIA GeForce GTX 1060 graphics controller, place the fans on the slots on the system board.**

- 4 Connect the fan cables to their respective connectors on the system board.

- 5 Adhere the tape that secures the fan cables to the fans.

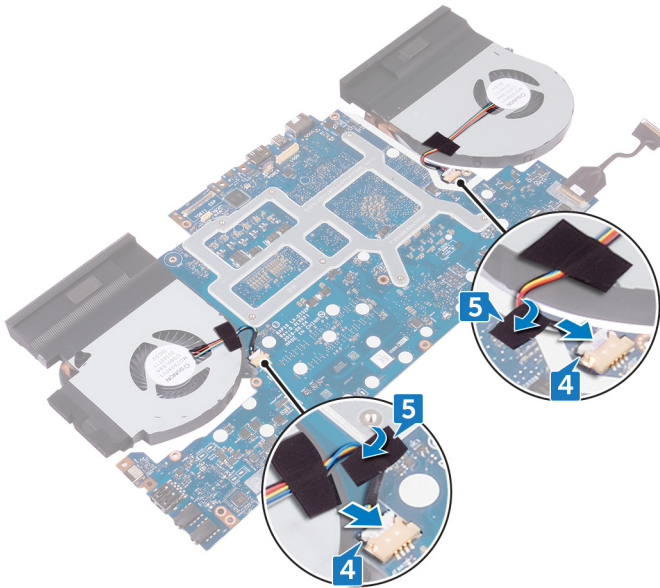

Post-requisites

- 1 Follow the procedure from step 2 to step 18 in "[Replacing the system board](#)".
- 2 Replace the [computer base](#).
- 3 Replace the [rear-I/O cover](#).
- 4 Replace the [memory modules](#).
- 5 Replace the [solid-state drive](#).
- 6 Replace the [wireless card](#).
- 7 Follow the procedure from step 4 to step 7 in "[Replacing the hard drive](#)".
- 8 Replace the [base cover](#).

Removing the power-adapter port

 **WARNING:** Before working inside your computer, read the safety information that shipped with your computer and follow the steps in [Before working inside your computer](#). After working inside your computer, follow the instructions in [After working inside your computer](#). For more safety best practices, see the Regulatory Compliance home page at www.dell.com/regulatory_compliance.

Prerequisites

- 1 Remove the [base cover](#).
- 2 Follow the procedure from step 1 to step 4 in "[Removing the hard drive](#)".
- 3 Remove the [wireless card](#).
- 4 Remove the [solid-state drive](#).
- 5 Remove the [memory modules](#).
- 6 Remove the [rear-I/O cover](#).
- 7 Remove the [computer base](#).
- 8 Follow the procedure from step 1 to step 22 in "[Removing the system board](#)".

Procedure

- 1 Remove the screw (M2x3) that secures the power-adapter port bracket to the palm-rest assembly.
- 2 Lift the power-adapter port bracket off the power-adapter port.
- 3 Lift the power-adapter port off the palm-rest assembly.
- 4 Peel the tape to access the power-adapter port cable on the palm-rest assembly.

5 Remove the cable from the routing guides on the palm-rest assembly.

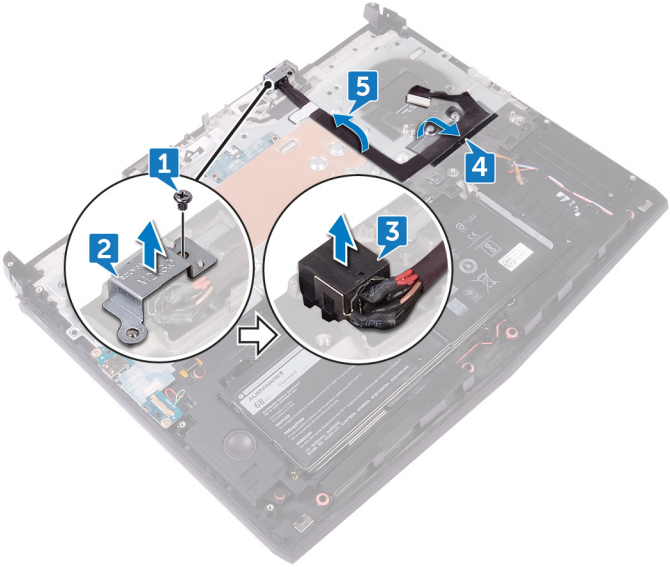

Replacing the power-adapter port



WARNING: Before working inside your computer, read the safety information that shipped with your computer and follow the steps in [Before working inside your computer](#). After working inside your computer, follow the instructions in [After working inside your computer](#). For more safety best practices, see the Regulatory Compliance home page at www.dell.com/regulatory_compliance.

Procedure

- 1 Slide the power-adapter port into the slot on the palm-rest assembly.
- 2 Using the alignment post, place the power-adapter port bracket on the power-adapter port.
- 3 Align the screw hole on the power-adapter port bracket with the screw hole on the palm-rest assembly.
- 4 Route the power-adapter port cable through the routing guides on the palm-rest assembly, and adhere it to the palm-rest assembly.

- 5 Replace the screw (M2x3) that secures the power-adaptor port bracket to the palm-rest assembly.

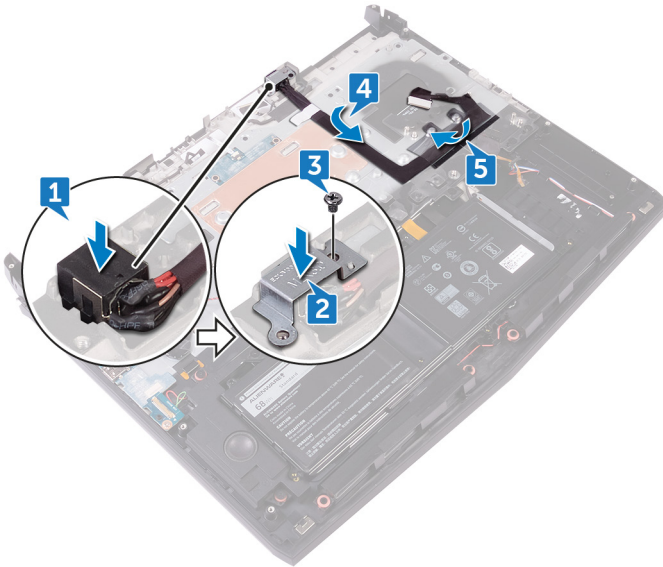

Post-requisites

- 1 Follow the procedure from step 2 to step 18 in "[Replacing the system board](#)".
- 2 Replace the [computer base](#).
- 3 Replace the [rear-I/O cover](#).
- 4 Replace the [memory modules](#).
- 5 Replace the [solid-state drive](#).
- 6 Replace the [wireless card](#).
- 7 Follow the procedure from step 4 to step 7 in "[Replacing the hard drive](#)".
- 8 Replace the [base cover](#).

Removing the power-button board

 **WARNING:** Before working inside your computer, read the safety information that shipped with your computer and follow the steps in [Before working inside your computer](#). After working inside your computer, follow the instructions in [After working inside your computer](#). For more safety best practices, see the Regulatory Compliance home page at www.dell.com/regulatory_compliance.

Prerequisites

- 1 Remove the [base cover](#).
- 2 Follow the procedure from step 1 to step 4 in "[Removing the hard drive](#)".
- 3 Remove the [wireless card](#).
- 4 Remove the [solid-state drive](#).
- 5 Remove the [memory modules](#).
- 6 Remove the [rear-I/O cover](#).
- 7 Remove the [computer base](#).
- 8 Follow the procedure from step 1 to step 22 in "[Removing the system board](#)".

Procedure

- 1 Remove the two screws (M2x3) that secure the power-button board to the palm-rest assembly.

2 Lift the power-button board along with its cable off the palm-rest assembly.

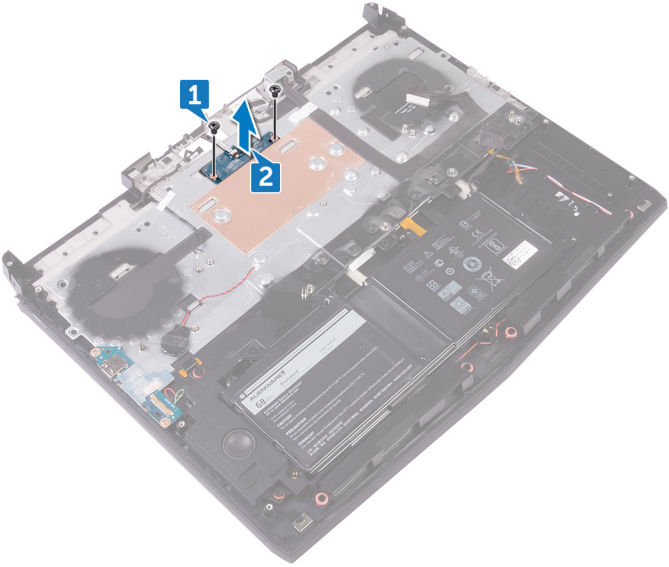

Replacing the power-button board

⚠ WARNING: Before working inside your computer, read the safety information that shipped with your computer and follow the steps in [Before working inside your computer](#). After working inside your computer, follow the instructions in [After working inside your computer](#). For more safety best practices, see the Regulatory Compliance home page at www.dell.com/regulatory_compliance.

Procedure

- 1 Place the power-button board on the palm-rest assembly, and align the screw holes on the power-button board with the screw holes on the palm-rest assembly.
- 2 Replace the two screws (M2x3) that secure the power-button board to the palm-rest assembly.

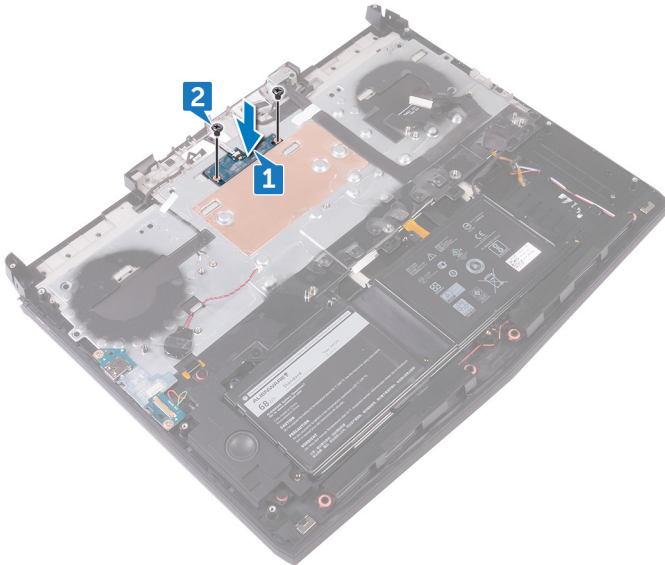

Post-requisites

- 1 Follow the procedure from step 2 to step 18 in "[Replacing the system board](#)".
- 2 Replace the [computer base](#).
- 3 Replace the [rear-I/O cover](#).
- 4 Replace the [memory modules](#).
- 5 Replace the [solid-state drive](#).
- 6 Replace the [wireless card](#).
- 7 Follow the procedure from step 4 to step 7 in "[Replacing the hard drive](#)".
- 8 Replace the [base cover](#).

Removing the display assembly

 **WARNING:** Before working inside your computer, read the safety information that shipped with your computer and follow the steps in [Before working inside your computer](#). After working inside your computer, follow the instructions in [After working inside your computer](#). For more safety best practices, see the Regulatory Compliance home page at www.dell.com/regulatory_compliance.

Prerequisites

- 1 Remove the [base cover](#).
- 2 Follow the procedure from step 1 to step 4 in "[Removing the hard drive](#)".
- 3 Remove the [wireless card](#).
- 4 Remove the [solid-state drive](#).
- 5 Remove the [memory modules](#).
- 6 Remove the [rear-I/O cover](#).
- 7 Remove the [computer base](#).
- 8 Follow the procedure from step 1 to step 22 in "[Removing the system board](#)".
- 9 Remove the [power-adaptor port](#).

Procedure

- 1 Remove the six screws (M2.5x5) that secure the display assembly to the palm-rest assembly.



- 2 Turn the computer over.
- 3 Peel the tape to remove the antenna cables from the palm-rest assembly.
- 4 Remove the logo board cable from the routing guides on the palm-rest assembly.

- 5 Remove the tobii eye-tracker cable and the display cable from the routing guides on the palm-rest assembly.

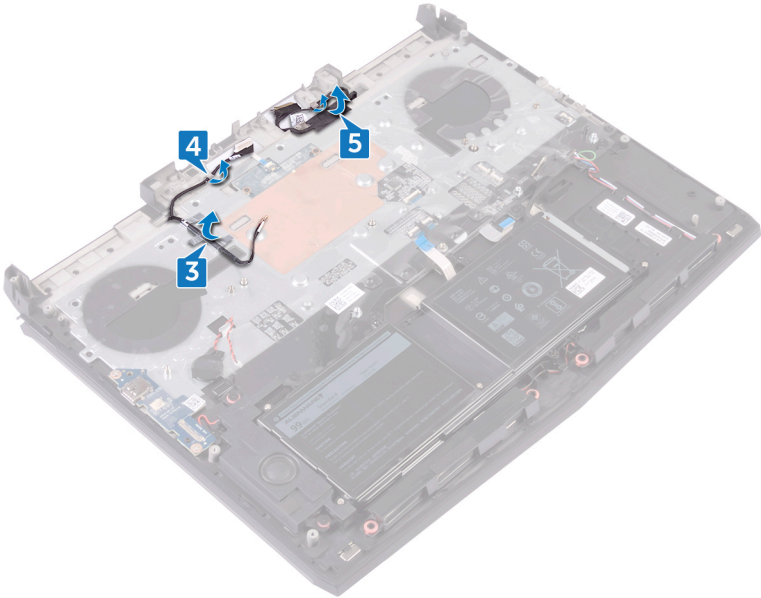

- 6 Push the antenna cables, logo board cable, tobii eye-tracker cable, and the display cable through the holes on the palm-rest assembly.

7 Lift the display assembly off the computer base.

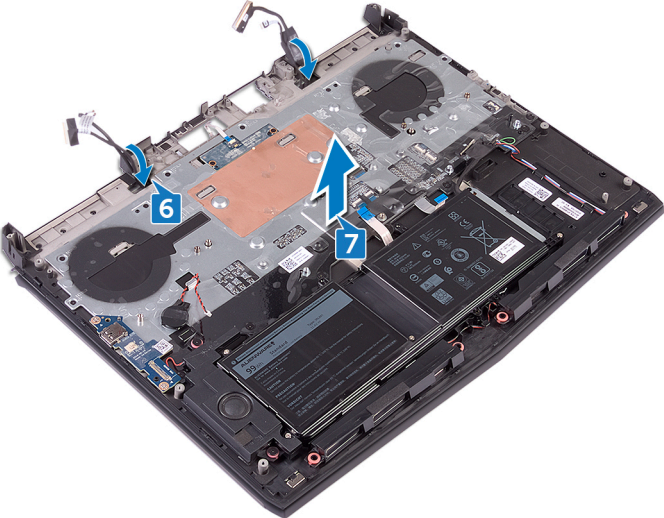

Replacing the display assembly

⚠ WARNING: Before working inside your computer, read the safety information that shipped with your computer and follow the steps in [Before working inside your computer](#). After working inside your computer, follow the instructions in [After working inside your computer](#). For more safety best practices, see the Regulatory Compliance home page at www.dell.com/regulatory_compliance.

Procedure

- 1 Place the palm-rest assembly on the display assembly.
- 2 Push the antenna cables, the logo-board cable, the tobii eye-tracker cable, and the display cable through the holes on the palm-rest assembly.

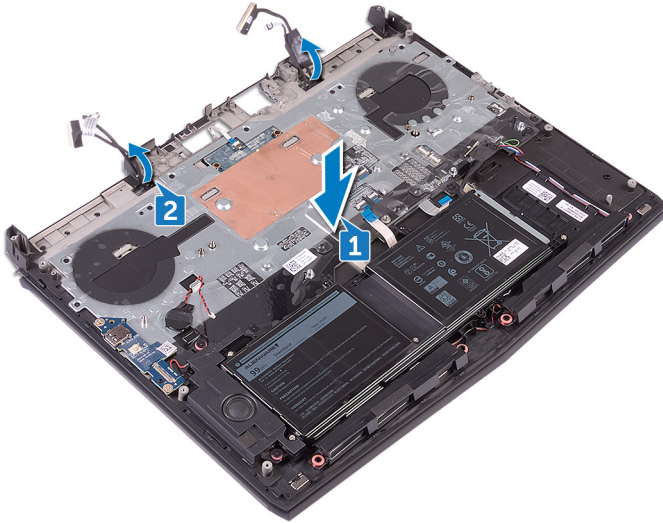

- 3 Route the tobii eye-tracker cable and the display cable through the routing guides on the palm-rest assembly.

- 4 Route the antenna cables and the logo-board cable through the routing guides on the palm-rest assembly.

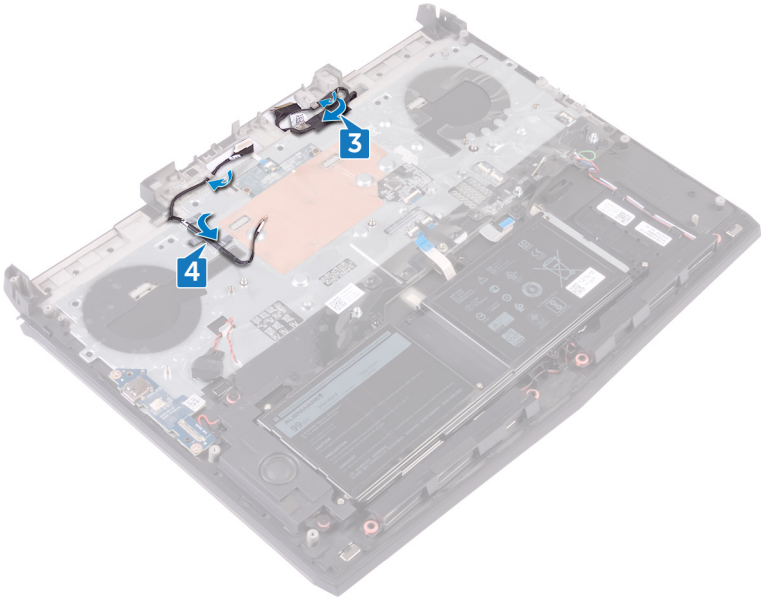

- 5 Turn the computer over.

- 6 Replace the six screws (M2.5x5) that secure the display assembly to the palm-rest assembly.



Post-requisites

- 1 Replace the [power-adapter port](#).
- 2 Follow the procedure from step 2 to step 18 in "[Replacing the system board](#)".
- 3 Replace the [computer base](#).
- 4 Replace the [rear-I/O cover](#).
- 5 Replace the [memory modules](#).
- 6 Replace the [solid-state drive](#).
- 7 Replace the [wireless card](#).
- 8 Follow the procedure from step 4 to step 7 in "[Replacing the hard drive](#)".
- 9 Replace the [base cover](#).

Removing the battery

 **WARNING:** Before working inside your computer, read the safety information that shipped with your computer and follow the steps in [Before working inside your computer](#). After working inside your computer, follow the instructions in [After working inside your computer](#). For more safety best practices, see the Regulatory Compliance home page at www.dell.com/regulatory_compliance.

Prerequisites

- 1 Remove the [base cover](#).
- 2 Follow the procedure from step 1 to step 4 in "[Removing the hard drive](#)".
- 3 Remove the [wireless card](#).
- 4 Remove the [solid-state drive](#).
- 5 Remove the [rear-I/O cover](#).
- 6 Remove the [computer base](#).

Procedure

- 1 Remove the four screws (M2.5x5) that secure the battery to the palm-rest assembly.

Replacing the battery

⚠ WARNING: Before working inside your computer, read the safety information that shipped with your computer and follow the steps in [Before working inside your computer](#). After working inside your computer, follow the instructions in [After working inside your computer](#). For more safety best practices, see the Regulatory Compliance home page at www.dell.com/regulatory_compliance.

Procedure

- 1 Place the battery on the palm-rest assembly, and align the screw holes on the battery with the screw holes on the palm-rest assembly.
- 2 Replace the four screws (M2.5x5) that secure the battery to the palm-rest assembly.

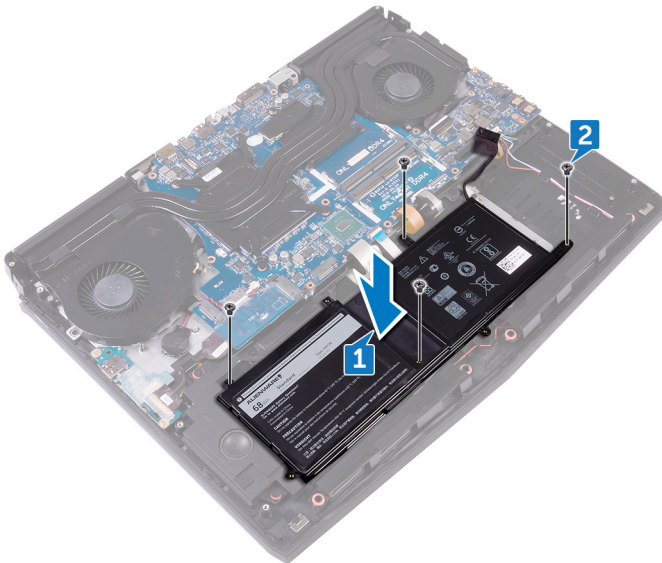

Post-requisites

- 1 Replace the [computer base](#).
- 2 Replace the [rear-I/O cover](#).
- 3 Replace the [solid-state drive](#).
- 4 Replace the [wireless card](#).
- 5 Follow the procedure from step 4 to step 7 in "[Replacing the hard drive](#)".
- 6 Replace the [base cover](#).

Removing the touchpad

 **WARNING:** Before working inside your computer, read the safety information that shipped with your computer and follow the steps in [Before working inside your computer](#). After working inside your computer, follow the instructions in [After working inside your computer](#). For more safety best practices, see the Regulatory Compliance home page at www.dell.com/regulatory_compliance.

Prerequisites

- 1 Remove the [base cover](#).
- 2 Follow the procedure from step 1 to step 4 in "[Removing the hard drive](#)".
- 3 Remove the [wireless card](#).
- 4 Remove the [solid-state drive](#).
- 5 Remove the [rear-I/O cover](#).
- 6 Remove the [computer base](#).
- 7 Remove the [battery](#).

Procedure

- 1 Open the latch, and disconnect the touchpad cable from the system board.
- 2 Open the latches, and disconnect the touchpad cable and the touchpad buttons cable from the touchpad.
- 3 Remove the five screws (M2x3) that secure the touchpad bracket to the palm-rest assembly.

- 4 Lift the touchpad bracket off the palm-rest assembly.

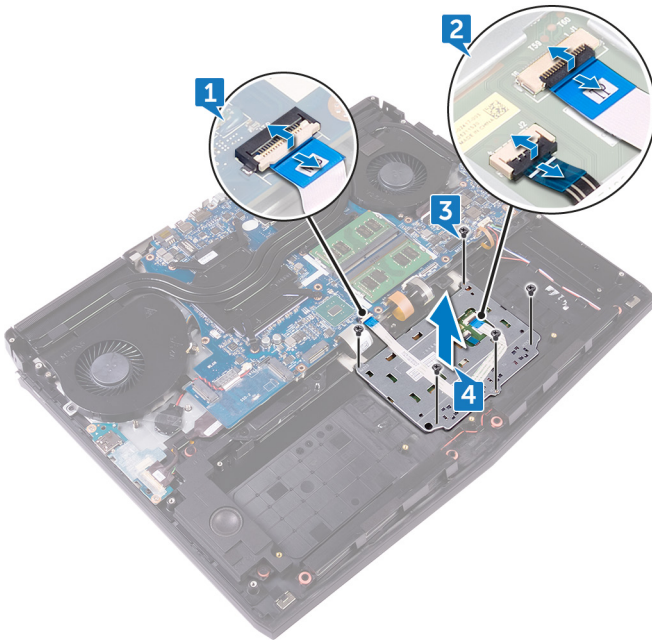

- 5 Open the computer 90 degrees, and using a plastic scribe to release the touchpad from the adhesive on the palm-rest assembly.

- 6 Peel the touchpad off the palm-rest assembly.

⚠ CAUTION: To avoid potential damage to the alignment posts on palm-rest assembly, carefully peel the touchpad off the palm-rest assembly.

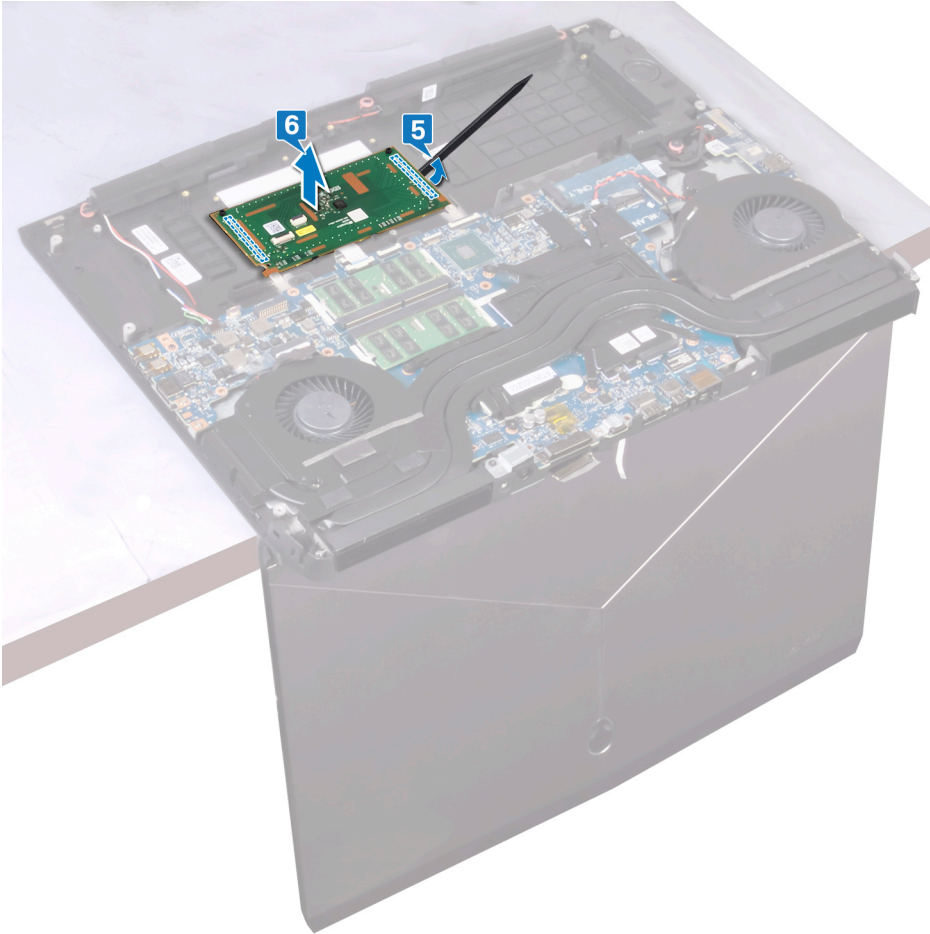

Replacing the touchpad

-  **WARNING:** Before working inside your computer, read the safety information that shipped with your computer and follow the steps in [Before working inside your computer](#). After working inside your computer, follow the instructions in [After working inside your computer](#). For more safety best practices, see the Regulatory Compliance home page at www.dell.com/regulatory_compliance.

Procedure

- 1 Using the alignment posts on the palm-rest assembly, adhere the touchpad to the palm-rest assembly.

-  **NOTE:** Clean the adhesive thoroughly on the palm-rest assembly to avoid having a gap between the touchpad and the palm-rest assembly.

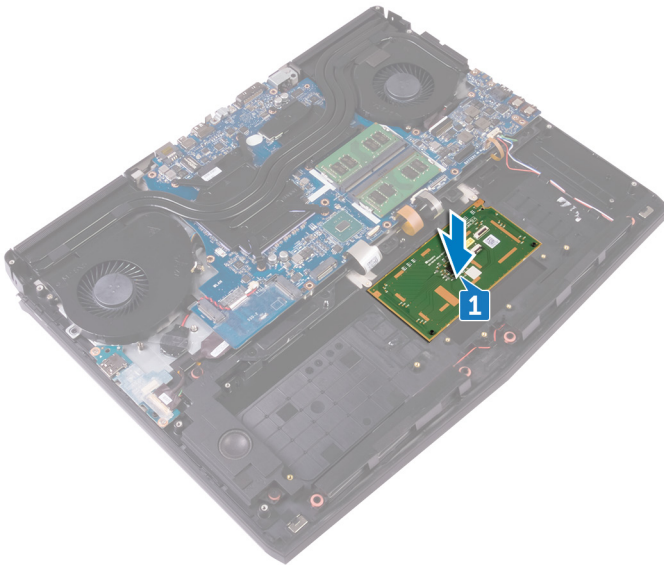

- 2 Align the screw holes on the touchpad bracket with the screw holes on the palm-rest assembly.
- 3 Replace the five screws (M2x3) that secure the touchpad bracket to the palm-rest assembly.
- 4 Slide the touchpad cable and touchpad buttons cable into their respective connectors on the touchpad and close the latches to secure the cables.
- 5 Slide the touchpad cable into the connector on the system board and close the latch to secure the cable.

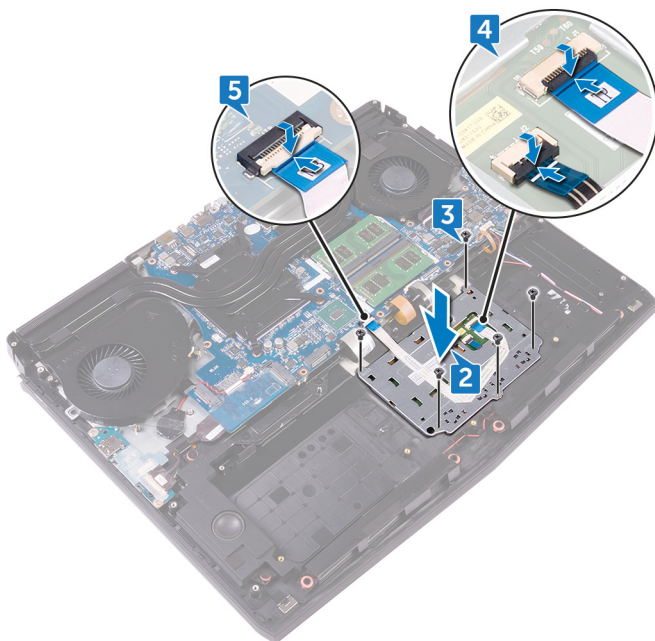

Post-requisites

- 1 Replace the [battery](#).
- 2 Replace the [computer base](#).
- 3 Replace the [rear-I/O cover](#).
- 4 Replace the [solid-state drive](#).
- 5 Replace the [wireless card](#).
- 6 Follow the procedure from step 4 to step 7 in "[Replacing the hard drive](#)".

7 Replace the [base cover](#).

Removing the keyboard

 **WARNING:** Before working inside your computer, read the safety information that shipped with your computer and follow the steps in [Before working inside your computer](#). After working inside your computer, follow the instructions in [After working inside your computer](#). For more safety best practices, see the Regulatory Compliance home page at www.dell.com/regulatory_compliance.

Prerequisites

- 1 Remove the [base cover](#).
- 2 Follow the procedure from step 1 to step 4 in "[Removing the hard drive](#)".
- 3 Remove the [wireless card](#).
- 4 Remove the [solid-state drive](#).
- 5 Remove the [memory modules](#).
- 6 Remove the [rear-I/O cover](#).
- 7 Remove the [computer base](#).
- 8 Remove the [coin-cell battery](#).
- 9 Remove the [I/O board](#).
- 10 Remove the [subwoofer](#).
- 11 Follow the procedure from step 1 to step 22 in "[Removing the system board](#)".
- 12 Remove the [power-adapter port](#).
- 13 Remove the [battery](#).

Procedure

- 1 Remove the 17 screws (M2x3) that secure the keyboard bracket to the palm-rest assembly.

-
- 2** Lift the keyboard bracket off the palm-rest assembly.

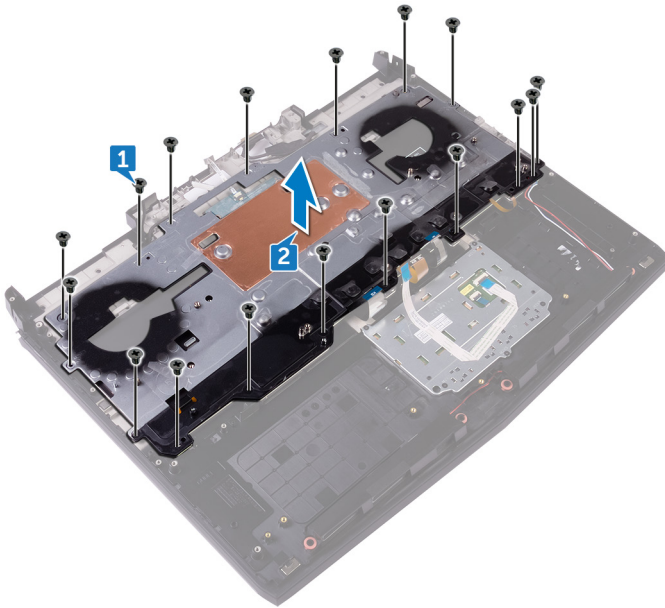

-
-
- 3** Open the latches and disconnect the macro-keys cable and macro-keys backlight cable from the keyboard.

- 4 Peel off the macro-keys cable and macro-keys backlight cable from the keyboard.

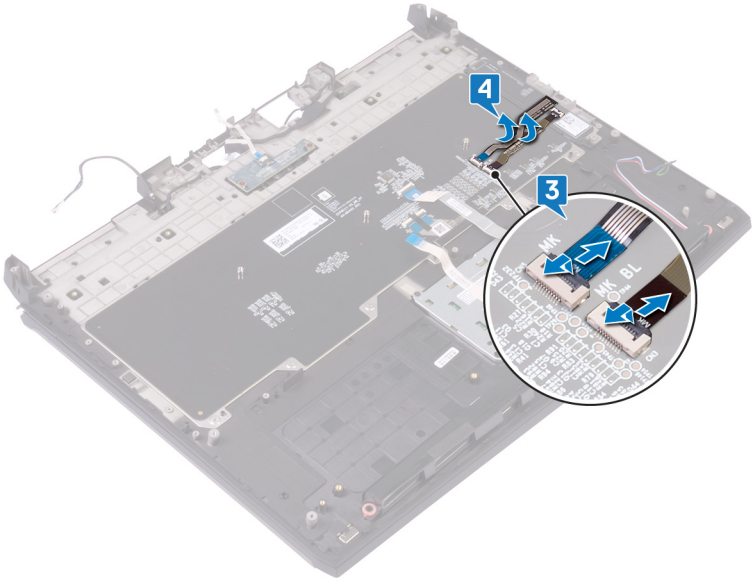

- 5 Lift the keyboard at an angle, and remove it from the tabs on the palm-rest assembly.

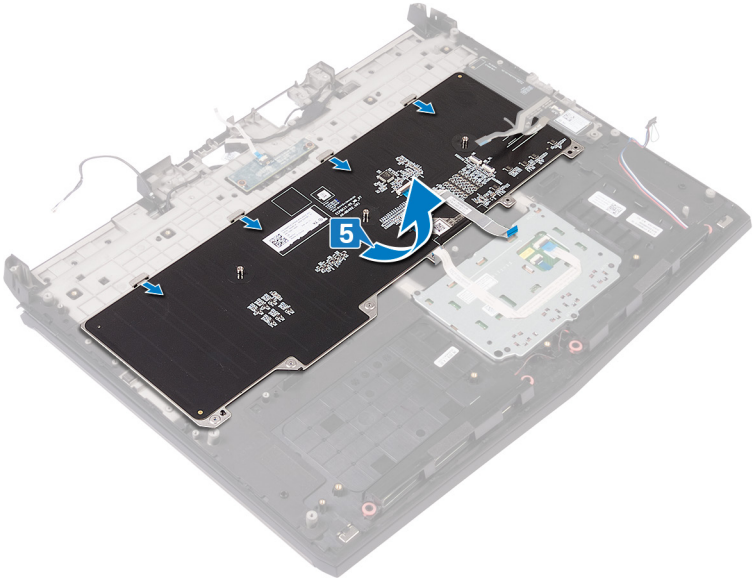

Replacing the keyboard

⚠ WARNING: Before working inside your computer, read the safety information that shipped with your computer and follow the steps in [Before working inside your computer](#). After working inside your computer, follow the instructions in [After working inside your computer](#). For more safety best practices, see the Regulatory Compliance home page at www.dell.com/regulatory_compliance.

Procedure

⚠ CAUTION: Ensure that there are no cables under the keyboard.

- 1 Slide the keyboard under the tabs on the palm-rest assembly.

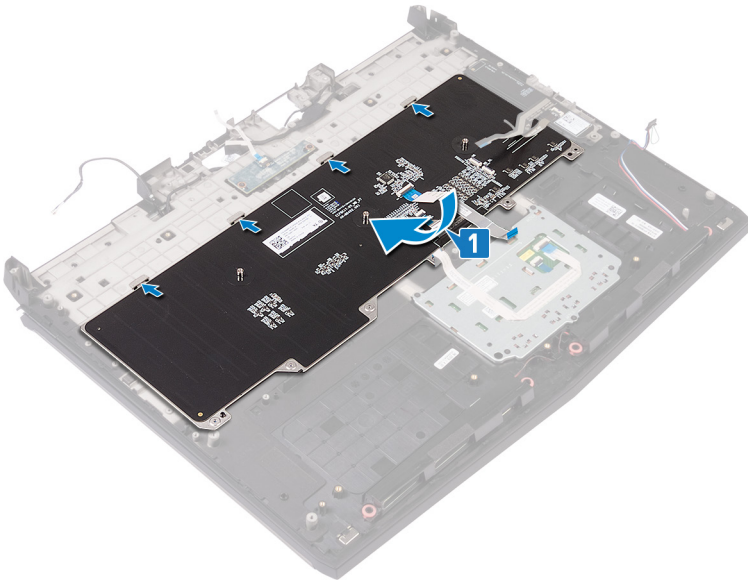

- 2 Slide the macro-keys cable and the macro-keys backlight cable to their respective connectors on the keyboard, and close the latches to secure the cables.

- 3 Adhere the macro-keys cable and the macro-keys backlight cable to the keyboard.

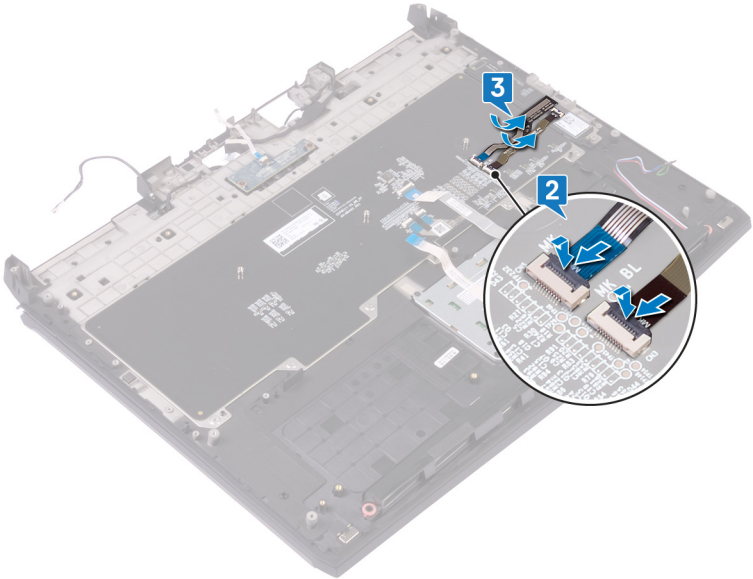

- 4 Align the screw holes on the keyboard bracket with the screw holes on the palm-rest assembly.

- 5 Replace the 17 screws (M2x3) that secure the keyboard bracket to the palm-rest assembly.

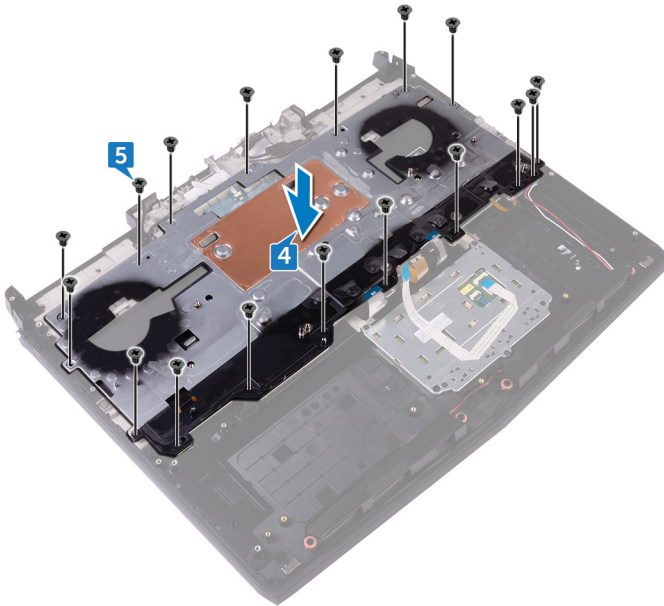

Post-requisites

- 1 Replace the [battery](#).
- 2 Replace the [power-adaptor port](#).
- 3 Follow the procedure from step 2 to step 18 in "[Replacing the system board](#)".
- 4 Replace the [subwoofer](#).
- 5 Replace the [I/O board](#).
- 6 Replace the [coin-cell battery](#).
- 7 Replace the [computer base](#).
- 8 Replace the [rear-I/O cover](#).
- 9 Replace the [memory modules](#).
- 10 Replace the [solid-state drive](#).
- 11 Replace the [wireless card](#).
- 12 Follow the procedure from step 4 to step 7 in "[Replacing the hard drive](#)".

13 Replace the [base cover](#).

Removing the macro keys

 **WARNING:** Before working inside your computer, read the safety information that shipped with your computer and follow the steps in [Before working inside your computer](#). After working inside your computer, follow the instructions in [After working inside your computer](#). For more safety best practices, see the Regulatory Compliance home page at www.dell.com/regulatory_compliance.

Prerequisites

- 1 Remove the [base cover](#).
- 2 Follow the procedure from step 1 to step 4 in "[Removing the hard drive](#)".
- 3 Remove the [wireless card](#).
- 4 Remove the [solid-state drive](#).
- 5 Remove the [memory modules](#).
- 6 Remove the [rear-I/O cover](#).
- 7 Remove the [computer base](#).
- 8 Remove the [coin-cell battery](#).
- 9 Remove the [I/O board](#).
- 10 Remove the [subwoofer](#).
- 11 Follow the procedure from step 1 to step 22 in "[Removing the system board](#)".
- 12 Remove the [power-adaptor port](#).
- 13 Remove the [battery](#).
- 14 Remove the [keyboard](#).

Procedure

Lift the macro keys at an angle, and release it from the tabs on the palm-rest assembly.

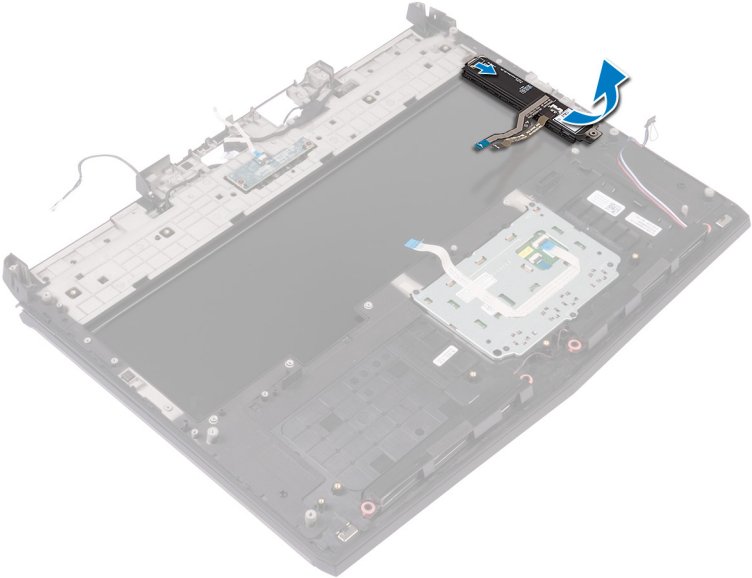

Replacing the macro keys

⚠ WARNING: Before working inside your computer, read the safety information that shipped with your computer and follow the steps in [Before working inside your computer](#). After working inside your computer, follow the instructions in [After working inside your computer](#). For more safety best practices, see the Regulatory Compliance home page at www.dell.com/regulatory_compliance.

Procedure

⚠ CAUTION: Ensure that there are no cables under the macro keys.

Slide the macro keys under the tabs on the palm-rest assembly.

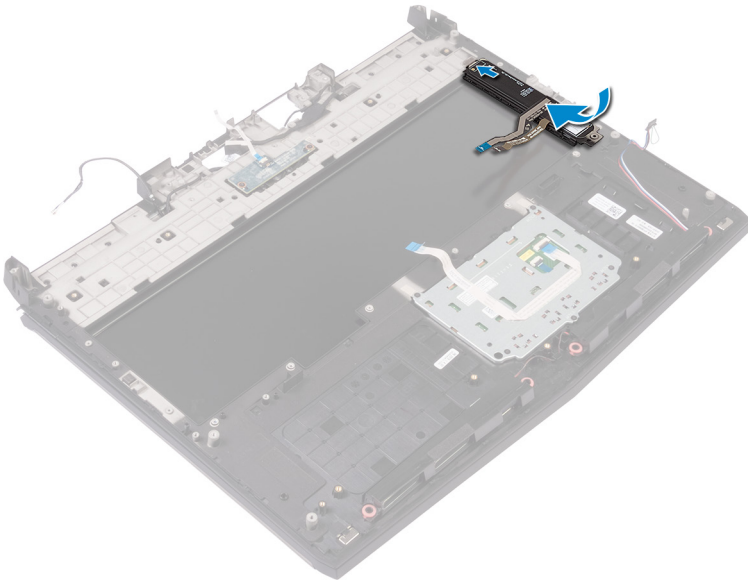

Post-requisites

- 1 Replace the [keyboard](#).
- 2 Replace the [battery](#).
- 3 Replace the [power-adapter port](#).
- 4 Follow the procedure from step 2 to step 18 in "[Replacing the system board](#)".
- 5 Replace the [subwoofer](#).
- 6 Replace the [I/O board](#).
- 7 Replace the [coin-cell battery](#).
- 8 Replace the [computer base](#).
- 9 Replace the [rear-I/O cover](#).
- 10 Replace the [memory modules](#).
- 11 Replace the [solid-state drive](#).
- 12 Replace the [wireless card](#).
- 13 Follow the procedure from step 4 to step 7 in "[Replacing the hard drive](#)".
- 14 Replace the [base cover](#).

Removing the palm rest

 **WARNING:** Before working inside your computer, read the safety information that shipped with your computer and follow the steps in [Before working inside your computer](#). After working inside your computer, follow the instructions in [After working inside your computer](#). For more safety best practices, see the Regulatory Compliance home page at www.dell.com/regulatory_compliance.

Prerequisites

- 1 Remove the [base cover](#).
- 2 Follow the procedure from step 1 to step 4 in "[Removing the hard drive](#)".
- 3 Remove the [wireless card](#).
- 4 Remove the [solid-state drive](#).
- 5 Remove the [rear-I/O cover](#).
- 6 Remove the [computer base](#).
- 7 Remove the [coin-cell battery](#).
- 8 Remove the [speakers](#).
- 9 Remove the [I/O board](#).
- 10 Remove the [subwoofer](#).
- 11 Remove the [memory modules](#).
- 12 Follow the procedure from step 1 to step 22 in "[Removing the system board](#)".
- 13 Remove the [power-button board](#).
- 14 Remove the [power-adaptor port](#).
- 15 Remove the [battery](#).
- 16 Remove the [touchpad](#).
- 17 Remove the [keyboard](#).
- 18 Remove the [macro keys](#).
- 19 Remove the [display assembly](#).

Procedure

After performing all the prerequisites, we are left with the palm rest.

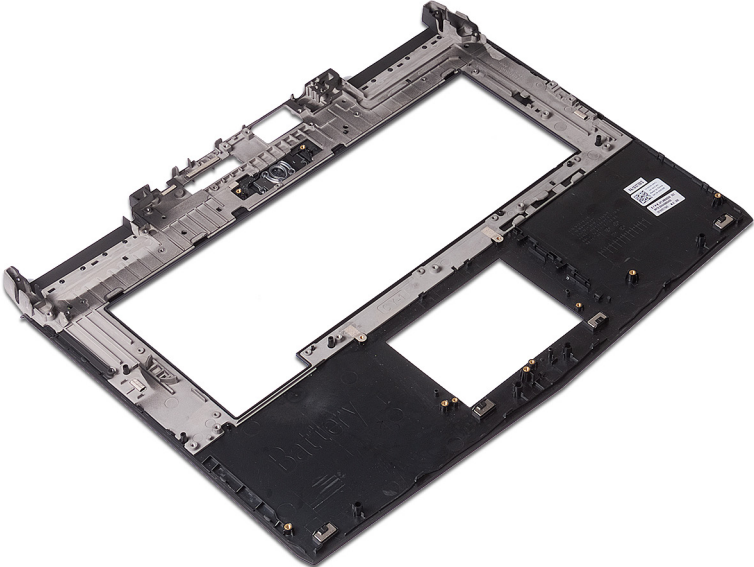

Replacing the palm rest

 **WARNING:** Before working inside your computer, read the safety information that shipped with your computer and follow the steps in [Before working inside your computer](#). After working inside your computer, follow the instructions in [After working inside your computer](#). For more safety best practices, see the Regulatory Compliance home page at www.dell.com/regulatory_compliance.

Procedure

Place the palm rest on a flat surface.

Post-requisites

- 1 Replace the [display assembly](#).
- 2 Replace the [macro keys](#).
- 3 Replace the [keyboard](#).
- 4 Replace the [touchpad](#).
- 5 Replace the [battery](#).
- 6 Replace the [power-adapter port](#).
- 7 Replace the [power-button board](#).
- 8 Follow the procedure from step 2 to step 18 in "[Replacing the system board](#)".
- 9 Replace the [memory modules](#).
- 10 Replace the [subwoofer](#).
- 11 Replace the [I/O board](#).
- 12 Replace the [speakers](#).
- 13 Replace the [coin-cell battery](#).
- 14 Replace the [computer base](#).
- 15 Replace the [rear-I/O cover](#).
- 16 Replace the [solid-state drive](#).
- 17 Replace the [wireless card](#).
- 18 Follow the procedure from step 4 to step 7 in "[Replacing the hard drive](#)".

19 Replace the [base cover](#).

Downloading drivers

Downloading the audio driver

- 1 Turn on your computer.
- 2 Go to www.dell.com/support.
- 3 Enter the Service Tag of your computer, and then click **Submit**.

 **NOTE: If you do not have the Service Tag, use the autodetect feature or manually browse for your computer model.**

- 4 Click **Drivers & downloads**.
- 5 Click the **Detect Drivers** button.
- 6 Review and agree to the Terms and Conditions for using Dell System Detect, then click **Continue**.

If necessary, your computer starts to download and install **Dell System Detect**.

 **NOTE: Review on-screen instructions for browser-specific instructions.**

- 7 Click **View Drivers for My System**.
- 8 Click **Download and Install** to install all driver updates detected for your computer.
- 9 Select a location to save the files.
- 10 If prompted, approve requests from User Account Control to make changes on the system.

The application installs all drivers and updates identified.

 **NOTE: Not all files can be installed automatically. Review the installation summary to identify if manual installation is necessary.**

- 11 Click **Category** for manual download and installation.
- 12 Click **Audio** in the drop-down list.
- 13 Click **Download** to download the audio driver for your computer.
- 14 After the download is complete, navigate to the folder where you saved the audio driver file.

- 15 Double-click the audio driver file icon and follow the instructions on the screen to install the driver.

Table 3. Audio controllers in Device Manager

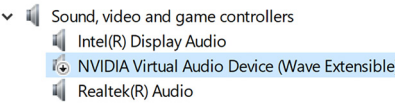
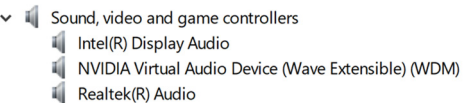
Before installation	After installation
 A screenshot of Windows Device Manager showing the 'Sound, video and game controllers' category expanded. It lists three devices: Intel(R) Display Audio, NVIDIA Virtual Audio Device (Wave Extensible) (highlighted in blue), and Realtek(R) Audio.	 A screenshot of Windows Device Manager showing the 'Sound, video and game controllers' category expanded. It lists three devices: Intel(R) Display Audio, NVIDIA Virtual Audio Device (Wave Extensible) (WDM), and Realtek(R) Audio.

Downloading the chipset driver

- 1 Turn on your computer.
- 2 Go to www.dell.com/support.
- 3 Enter the Service Tag of your computer, and then click **Submit**.

 **NOTE: If you do not have the Service Tag, use the autodetect feature or manually browse for your computer model.**

- 4 Click **Drivers & downloads**.
- 5 Click the **Detect Drivers** button.
- 6 Review and agree to the Terms and Conditions for using Dell System Detect, then click **Continue**.

If necessary, your computer starts to download and install **Dell System Detect**.

 **NOTE: Review on-screen instructions for browser-specific instructions.**

- 7 Click **View Drivers for My System**.
- 8 Click **Download and Install** to install all driver updates detected for your computer.
- 9 Select a location to save the files.
- 10 If prompted, approve requests from User Account Control to make changes on the system.

The application installs all drivers and updates identified.

 **NOTE: Not all files can be installed automatically. Review the installation summary to identify if manual installation is necessary.**

- 11 Click **Category** for manual download and installation.

- 12 Click **Chipset** in the drop-down list.
- 13 Click **Download** to download the chipset driver for your computer.
- 14 After the download is complete, navigate to the folder where you saved the chipset driver file.
- 15 Double-click the chipset driver file icon and follow the instructions on the screen to install the driver.

Downloading the graphics driver

- 1 Turn on your computer.
- 2 Go to www.dell.com/support.
- 3 Enter the Service Tag of your computer, and then click **Submit**.

 **NOTE: If you do not have the Service Tag, use the autodetect feature or manually browse for your computer model.**

- 4 Click **Drivers & downloads**.
- 5 Click the **Detect Drivers** button.
- 6 Review and agree to the Terms and Conditions for using Dell System Detect, then click **Continue**.

If necessary, your computer starts to download and install **Dell System Detect**.

 **NOTE: Review on-screen instructions for browser-specific instructions.**

- 7 Click **View Drivers for My System**.
- 8 Click **Download and Install** to install all driver updates detected for your computer.
- 9 Select a location to save the files.
- 10 If prompted, approve requests from User Account Control to make changes on the system.



The application installs all drivers and updates identified.

 **NOTE: Not all files can be installed automatically. Review the installation summary to identify if manual installation is necessary.**

- 11 Click **Category** for manual download and installation.
- 12 Click **Video** in the drop-down list.
- 13 Click **Download** to download the graphics driver for your computer.

- 14 After the download is complete, navigate to the folder where you saved the graphics driver file.
- 15 Double-click the graphics driver file icon and follow the instructions on the screen to install the driver.

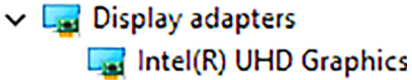
Table 4. Video controllers in Device Manager

Before installation	After installation
	

Downloading the network driver

- 1 Turn on your computer.
- 2 Go to www.dell.com/support.
- 3 Enter the Service Tag of your computer, and then click **Submit**.
 -  **NOTE: If you do not have the Service Tag, use the autodetect feature or manually browse for your computer model.**
- 4 Click **Drivers & downloads**.
- 5 Click the **Detect Drivers** button.
- 6 Review and agree to the Terms and Conditions for using Dell System Detect, then click **Continue**.

If necessary, your computer starts to download and install **Dell System Detect**.

-  **NOTE: Review on-screen instructions for browser-specific instructions.**
- 7 Click **View Drivers for My System**.
- 8 Click **Download and Install** to install all driver updates detected for your computer.
- 9 Select a location to save the files.
- 10 If prompted, approve requests from User Account Control to make changes on the system.

The application installs all drivers and updates identified.

-  **NOTE: Not all files can be installed automatically. Review the installation summary to identify if manual installation is necessary.**

- 11 Click **Category** for manual download and installation.
- 12 Click **Network** in the drop-down list.
- 13 Click **Download** to download the network driver for your computer.
- 14 After the download is complete, navigate to the folder where you saved the network driver file.
- 15 Double-click the network driver file icon and follow the instructions on the screen to install the driver.

Downloading the tobii driver

- 1 Turn on your computer.
- 2 Go to www.dell.com/support.
- 3 Enter the Service Tag of your computer, and then click **Submit**.
 **NOTE: If you do not have the Service Tag, use the autodetect feature or manually browse for your computer model.**
- 4 Click **Drivers & downloads**.
- 5 Click the **Detect Drivers** button.
- 6 Review and agree to the Terms and Conditions for using Dell System Detect, then click **Continue**.

If necessary, your computer starts to download and install **Dell System Detect**.



-  **NOTE: Review on-screen instructions for browser-specific instructions.**
- 7 Click **View Drivers for My System**.
- 8 Click **Download and Install** to install all driver updates detected for your computer.
- 9 Select a location to save the files.
- 10 If prompted, approve requests from User Account Control to make changes on the system.

The application installs all drivers and updates identified.

-  **NOTE: Not all files can be installed automatically. Review the installation summary to identify if manual installation is necessary.**
- 11 Click **Category** for manual download and installation.
- 12 Click **Chipset** in the drop-down list.
- 13 Click **Download** to download the tobii driver for your computer.

- 14 After the download is complete, navigate to the folder where you saved the tobii driver file.
- 15 Double-click the tobii driver file icon and follow the instructions on the screen to install the driver.

Downloading the USB driver

- 1 Turn on your computer.
- 2 Go to www.dell.com/support.
- 3 Enter the Service Tag of your computer, and then click **Submit**.
 **NOTE: If you do not have the Service Tag, use the autodetect feature or manually browse for your computer model.**
- 4 Click **Drivers & downloads**.
- 5 Click the **Detect Drivers** button.
- 6 Review and agree to the Terms and Conditions for using Dell System Detect, then click **Continue**.
If necessary, your computer starts to download and install **Dell System Detect**.
 **NOTE: Review on-screen instructions for browser-specific instructions.**
- 7 Click **View Drivers for My System**.
- 8 Click **Download and Install** to install all driver updates detected for your computer.
- 9 Select a location to save the files.
- 10 If prompted, approve requests from User Account Control to make changes on the system.
The application installs all drivers and updates identified.
 **NOTE: Not all files can be installed automatically. Review the installation summary to identify if manual installation is necessary.**
- 11 Click **Category** for manual download and installation.
- 12 Click **Chipset** in the drop-down list.
- 13 Click **Download** to download the USB driver for your computer.
- 14 After the download is complete, navigate to the folder where you saved the USB driver file.

- 15 Double-click the USB driver file icon and follow the instructions on the screen to install the driver.

Table 5. USB controllers in Device Manager

Before installation	After installation
<ul style="list-style-type: none">Universal Serial Bus controllers<ul style="list-style-type: none">Intel(R) USB 3.1 eXtensible Host Controller - 1.10 (I)UCSI USB Connector ManagerUSB Root Hub (USB 3.0)	<ul style="list-style-type: none">Universal Serial Bus controllers<ul style="list-style-type: none">Intel(R) USB 3.1 eXtensible Host Controller - 1.10 (Microsoft)UCSI USB Connector ManagerUSB Composite DeviceUSB Root Hub (USB 3.0)

Downloading the wireless driver

- 1 Turn on your computer.
- 2 Go to www.dell.com/support.
- 3 Enter the Service Tag of your computer, and then click **Submit**.

 **NOTE: If you do not have the Service Tag, use the autodetect feature or manually browse for your computer model.**

- 4 Click **Drivers & downloads**.
- 5 Click the **Detect Drivers** button.
- 6 Review and agree to the Terms and Conditions for using Dell System Detect, then click **Continue**.

If necessary, your computer starts to download and install **Dell System Detect**.

 **NOTE: Review on-screen instructions for browser-specific instructions.**

























- 7 Click **View Drivers for My System**.
- 8 Click **Download and Install** to install all driver updates detected for your computer.
- 9 Select a location to save the files.
- 10 If prompted, approve requests from User Account Control to make changes on the system.

The application installs all drivers and updates identified.

 **NOTE: Not all files can be installed automatically. Review the installation summary to identify if manual installation is necessary.**

- 11 Click **Category** for manual download and installation.
- 12 Click **Network** in the drop-down list.
- 13 Click **Download** to download the wireless driver for your computer.
- 14 After the download is complete, navigate to the folder where you saved the wireless driver file.
- 15 Double-click the wireless driver file icon and follow the instructions on the screen to install the driver.

Table 6. Network adapters in Device Manager

Before installation	After installation
<ul style="list-style-type: none">  Network adapters <ul style="list-style-type: none">  Bluetooth Device (Personal Area Ne  Killer E2500 Gigabit Ethernet Contr  WAN Miniport (IKEv2)  WAN Miniport (IP)  WAN Miniport (IPv6)  WAN Miniport (L2TP)  WAN Miniport (Network Monitor)  WAN Miniport (PPPOE)  WAN Miniport (PPTP)  WAN Miniport (SSTP) 	<ul style="list-style-type: none">  Network adapters <ul style="list-style-type: none">  Bluetooth Device (Personal Area Network)  Bluetooth Device (RFCOMM Protocol TDI)  Killer E2500 Gigabit Ethernet Controller #2  Killer(R) Wireless-AC 1550 Wireless Network Adapter (9260NGW)  WAN Miniport (IKEv2)  WAN Miniport (IP)  WAN Miniport (IPv6)  WAN Miniport (L2TP)  WAN Miniport (Network Monitor)  WAN Miniport (PPPOE)  WAN Miniport (PPTP)  WAN Miniport (SSTP)

System setup

 **NOTE:** Depending on the computer and its installed devices, the items listed in this section may or may not be displayed.

Boot Sequence

Boot Sequence allows you to bypass the System Setup–defined boot device order and boot directly to a specific device (for example: optical drive or hard drive). During the Power-on Self Test (POST), when the Dell logo appears, you can:

- Access System Setup by pressing F2 key
- Bring up the one-time boot menu by pressing F12 key

The one-time boot menu displays the devices that you can boot from including the diagnostic option. The boot menu options are:

- Removable Drive (if available)
- STXXXX Drive

 **NOTE:** XXX denotes the SATA drive number.

- Optical Drive (if available)
- SATA Hard Drive (if available)
- Diagnostics

 **NOTE:** Choosing Diagnostics, will display the ePSA diagnostics screen.

The boot sequence screen also displays the option to access the System Setup screen.

Navigation keys

 **NOTE:** For most of the System Setup options, changes that you make are recorded but do not take effect until you restart the system.

Keys	Navigation
Up arrow	Moves to the previous field.
Down arrow	Moves to the next field.
Enter	Selects a value in the selected field (if applicable) or follow the link in the field.
Spacebar	Expands or collapses a drop-down list, if applicable.
Tab	Moves to the next focus area.
	 NOTE: For the standard graphics browser only.
Esc	Moves to the previous page until you view the main screen. Pressing Esc in the main screen displays a message that prompts you to save any unsaved changes and restarts the system.

BIOS overview

 **CAUTION: Unless you are an expert computer user, do not change the settings in the BIOS Setup program. Certain changes can make your computer work incorrectly.**

 **NOTE: Before you change BIOS Setup program, it is recommended that you write down the BIOS Setup program screen information for future reference.**

Use the BIOS Setup program for the following purposes:

- Get information about the hardware installed in your computer, such as the amount of RAM and the size of the hard drive.
- Change the system configuration information.
- Set or change a user-selectable option, such as the user password, type of hard drive installed, and enabling or disabling base devices.

Entering BIOS setup program

- 1 Turn on (or restart) your computer.

- 2 During POST, when the DELL logo is displayed, watch for the F2 prompt to appear, and then press F2 immediately.



NOTE: The F2 prompt indicates that the keyboard is initialized. This prompt can appear very quickly, so you must watch for it, and then press F2. If you press F2 before the F2 prompt, this keystroke is lost. If you wait too long and the operating system logo appears, continue to wait until you see the desktop. Then, turn off your computer and try again.

Enabling or disabling the USB in BIOS setup program

- 1 Turn on or restart your computer.
- 2 Press F2 when the Dell logo is displayed on the screen to enter the BIOS setup program.
The BIOS setup program is displayed.
- 3 On the left pane, select **Settings** → **System Configuration** → **USB Configuration**.
The USB configuration is displayed on the right pane.
- 4 Select or clear the **Enable External USB Port** check box to enable or disable it, respectively.
- 5 Save the settings and exit.

Identifying the hard drive in BIOS setup program

- 1 Turn on or restart your computer.
- 2 Press F2 when the Dell logo is displayed on the screen to enter the BIOS setup program.
A list of hard drives are displayed under the **System Information** in the **General** group.

Checking the system memory in BIOS setup program

- 1 Turn on or restart your computer.
- 2 Press F2 when the Dell logo is displayed to enter the BIOS setup program.
- 3 On the left pane, select **Settings** → **General** → **System Information**.
The memory information is displayed on the right pane.

System setup options

 **NOTE:** Depending on your computer and its installed devices, the items listed in this section may or may not appear.

Table 7. System setup options—Main menu

Main	
System Time	Displays the current time in hh:mm:ss format.
System Date	Displays the current date in mm/dd/yyyy format.
BIOS Version	Displays the BIOS version.
Product Name	Displays the model number of your computer.
Service Tag	Displays the service tag of your computer.
Asset Tag	Displays the asset tag of your computer.
CPU Type	Displays the processor type.
CPU Speed	Displays the processor speed.
CPU ID	Displays the processor identification code.
CPU L1 Cache	Displays the processor L1 cache size.
CPU L2 Cache	Displays the processor L2 cache size.
CPU L3 Cache	Displays the processor L3 cache size.
Integrated Graphics	Displays the integrated graphics.
Discrete Graphics 1	Displays the first discrete graphics installed on your computer.
Discrete Graphics 1	Displays the second discrete graphics installed on your computer.
First HDD	Displays the type of hard drive installed.

Main



Second HDD	Displays the type of secondary hard-drive installed.
Third HDD	Displays the type of third hard-drive installed.
M.2 PCIe SSD-1	Displays the type of primary SSD installed.
M.2 PCIe SSD-2	Displays the type of secondary SSD installed.
M.2 PCIe SSD-3	Displays the type of third SSD installed.
AC Adapter Type	Displays the AC adapter type.

Table 8. System setup options—Advanced menu

Advanced

Intel(R) SpeedStep(TM)	Enables you to enable or disable Intel Speedstep Technology. Default: Enabled  NOTE: If enabled, the processor clock speed and core voltage are adjusted dynamically based on the processor load.
Virtualization	Enables you to enable or disable Intel Virtualization Technology feature for the processor. Default: Enabled
VT for Direct I/O	Specify whether a Virtual Machine Monitor (VMM) can utilize the additional hardware capabilities provided by Intel Virtualization Technology for Direct I/O.
Trusted Execution	Specify whether a Virtual Machine Monitor (VMM) can utilize the additional hardware capabilities

Advanced

	<p>provided by Intel Trusted Execution Technology. Default: Disabled</p>
Integrated NIC	<p>Enables you to enable or disable the on-board LAN controller. Default: Enabled</p>
USB Emulation	<p>Enables you to enable or disable the USB emulation feature. This feature defines how the BIOS, in the absence of a USB-aware operating system, handles USB devices. USB emulation is always enabled during POST. Default: Enabled</p> <p> NOTE: You cannot boot any type of USB device (floppy, hard drive, or memory key) when this option is off.</p>
USB Powershare	<p>Enables you to charge USB devices when the computer is turned off or in standby mode. Default: Enabled</p>
USB Wake Support	<p>Enables you to enable the USB devices to wake the computer from Standby. Default: Disabled</p> <p> NOTE: If USB PowerShare is enabled, a device connected to the USB PowerShare connector may not wake the computer.</p>
Intel Speed Shift Technology	<p>Enable/disable Intel Speed Shift Technology support. Setting this option to enable to allows the operating system to select the appropriate processor performance automatically. Default: Enabled</p>

Advanced

SATA Operation	Enables you to configure the operating mode of the integrated SATA hard drive controller. Default: AHCI
Adapter Warnings	Enables you to choose if the computer should display warning messages when you use AC adapters that are not supported by your computer. Default: Enabled
Function Key Behavior	Enables you to set function key or multimedia key as the default function key behavior. Default: Function key
Express Charge	Enables you to charge your computer battery using Standard Charge or Express Charge mode. Default: Express Charge
Touchpad Backlight	Enables you to configure the touchpad backlight option. Default: Auto
Battery Health	Displays the battery health.
Intel(R) Software Guard Extensions	Enable or disable Intel Software Guard Extensions. Default: Software Controlled
Intel(R) Software Guard Extensions allocated memory size	Displays the allocated memory size for Intel Software Guard Extensions.
BIOS Recovery from Hard Drive	Enable the user to recover from certain corrupted BIOS conditions from a recovery file on the user primary hard drive Default: Enabled
BIOS Auto-Recovery	Enable or disable BIOS Auto-Recovery. Default: Disabled

Advanced

Always Perform Integrity Check Enable or disable Always Perform Integrity Check.
Default: Disabled

Performance Options

CPU Performance Mode Enables you to select the CPU performance mode.
Default: Enabled

Fan Performance Mode Enables you to select the fan performance mode.
Default: Balanced Mode

Core Over Clocking Level Enable or disable the over-clocking setting and adjust the processor flex ratio and voltage in the Customization mode.
Default: Disabled

SupportAssist System Resolution

Auto OS Recovery Threshold Control the automatic boot flow for SupportAssist System Resolution Console and for Dell OS Recovery tool.
Default: 2

SupportAssist OS Recovery Enable or disable SupportAssist OS recovery.
Default: Enabled

Intel(R) Rapid Storage Technology

Non-RAID Physical Disks Displays the disk using the Intel(R) Rapid Storage Technology.

Table 9. System setup options—Security menu

Security	
Unlock Setup Status	Displays if the setup status is unlocked.
Admin Password Status	Displays if the administrator password is clear or set. Default: Not set
System Password Status	Displays if the system password is clear or set. Default: Not set
HDD Password Status	Displays if the HDD password is clear or set. Default: Not set
Admin Password	Enables you to set the administrator password. The administrator password controls access to the system setup utility.
System Password	Enables you to set the system password. The system password controls access to the computer at boot.
HDD password	Enables you to set, change or delete the hard-disk drive password.
Password Change	Enables you to permit or deny system password or HDD password changes. Default: Permitted
Computrace	Enable or disable the BIOS module interface of the optional Computrace Service from Absolute Software. Default: Activate
Firmware TPM	Enables you to enable or disable the firmware TPM function. Default: Enabled
PPI Bypass for Clear Command	Enables you to control the TPM Physical Presence Interface (PPI).

Security

	When enabled, this setting will allow the OS to skip BIOS PPI user prompts when issuing the Clear command. Changes to this setting take effect immediately. Default: Enabled
UEFI Capsule Firmware Updates	Enable or disable BIOS updates through UEFI capsule update packages. Default: Enabled

Table 10. System setup options—Boot menu

Boot

Boot List Option	Displays the available boot options. Default: UEFI
File Browser Add Boot Option	Enables you to add the boot options.
File Browser Del Boot Option	Enables you to delete the boot options
Secure Boot	Enable or disable the secure boot feature. Default: Disabled
Legacy Option ROMs	Enable or disable the Legacy Option ROMs. Default: Disabled
Attempt Legacy Boot	Enable or disable Attempt Legacy Boot. Default: Disabled
Boot Option Priorities	Displays the boot sequence.
Boot Option #1	Displays the available first boot option.
Boot Option #2	Displays the available second boot option.

Boot

Boot Option #3	Displays the available third boot option.
----------------	---

Table 11. System setup options—Exit menu

Exit

Save Changes and Reset	Allows you to exit system setup and save your changes.
Discard Changes and Reset	Allows you to exit system setup and load previous values for all system setup options.
Restore Defaults	Allows you to restore default values for all system setup options.
Discard Changes	Allows you to load previous values for all system setup options.
Save Changes	Allows you to save the changes for all system setup options.

Troubleshooting

Flashing the BIOS

You may need to flash (update) the BIOS when an update is available or when you replace the system board.

Follow these steps to flash the BIOS:

- 1 Turn on your computer.
- 2 Go to www.dell.com/support.
- 3 Click **Product support**, enter the Service Tag of your computer, and then click **Submit**.



NOTE: If you do not have the Service Tag, use the auto-detect feature or manually browse for your computer model.

- 4 Click **Drivers & downloads** → **Find it myself**.
- 5 Select the operating system installed on your computer.
- 6 Scroll down the page and expand **BIOS**.
- 7 Click **Download** to download the latest version of the BIOS for your computer.
- 8 After the download is complete, navigate to the folder where you saved the BIOS update file.
- 9 Double-click the BIOS update file icon and follow the instructions on the screen.

Flashing BIOS (USB key)

- 1 Follow the procedure from step 1 to step 7 in "[Flashing the BIOS](#)" to download the latest BIOS setup program file.
- 2 Create a bootable USB drive. For more information see the knowledge base article [SLN143196](#) at www.dell.com/support.
- 3 Copy the BIOS setup program file to the bootable USB drive.
- 4 Connect the bootable USB drive to the computer that needs the BIOS update.
- 5 Restart the computer and press **F12** when the Dell logo is displayed on the screen.

- 6 Boot to the USB drive from the **One Time Boot Menu**.
- 7 Type the BIOS setup program filename and press **Enter**.
- 8 The **BIOS Update Utility** appears. Follow the instructions on the screen to complete the BIOS update.

Reinstall Windows using a USB recovery drive

 **CAUTION:** This process formats the hard drive and removes all data on your computer. Ensure that you back up data on your computer before beginning this task.

 **NOTE:** Before reinstalling Windows, ensure your computer has more than 2 GB of memory and more than 32 GB of storage space.

 **NOTE:** This process may take up to an hour to complete and your computer will restart during the recovery process.

- 1 Connect the USB recovery drive to your computer.
- 2 Restart your computer.
- 3 Press F12 after the Dell logo is displayed on the screen to access the boot menu.
A **Preparing one-time boot menu** message appears.
- 4 After the boot menu loads, select the USB recovery device under **UEFI BOOT**.
The system reboots and a screen to **Choose the keyboard layout** is displayed.
- 5 Choose your keyboard layout.
- 6 In the **Choose an option** screen, click **Troubleshoot**.
- 7 Click **Recover from a drive**.
- 8 Choose one of the following options:
 - **Just remove my files** to do a quick format.
 - **Fully clean the drive** to do a complete format.
- 9 Click **Recover** to start the recovery process.

Enhanced Pre-Boot System Assessment (ePSA) diagnostics



CAUTION: Use the ePSA diagnostics to test only your computer. Using this program with other computers may cause invalid results or error messages.

The ePSA diagnostics (also known as system diagnostics) performs a complete check of your hardware. The ePSA is embedded with the BIOS and is launched by the BIOS internally. The embedded system diagnostics provides a set of options for particular devices or device groups allowing you to:

- Run tests automatically or in an interactive mode
- Repeat tests
- Display or save test results
- Run thorough tests to introduce additional test options to provide extra information about the failed device(s)
- View status messages that inform you if tests are completed successfully
- View error messages that inform you of problems encountered during testing



NOTE: Some tests for specific devices require user interaction. Always ensure that you are present at the computer terminal when the diagnostic tests are performed.

For more information, see [Dell EPSA Diagnostic 3.0](#).

Running the ePSA diagnostics

- 1 Power-on the computer.
- 2 As the computer boots, press the F12 key as the Dell logo appears.
- 3 On the boot menu screen, select the **Diagnostics** option.
- 4 Click the arrow key at the bottom left corner.
Diagnostics front page is displayed.
- 5 Press the arrow in the lower-right corner to go to the page listing.
The items detected are listed.
- 6 To run a diagnostic test on a specific device, press Esc and click **Yes** to stop the diagnostic test.
- 7 Select the device from the left pane and click **Run Tests**.

- 8 If there are any issues, error codes are displayed.
Note the error code and validation number and contact Dell.

Diagnositics

Power and battery-status light: Indicates the power and battery-charge status.

Solid amber – Computer is running on battery and the battery has less than 10 percent charge.

User-defined color (AC mode) – Power adapter is connected and the battery is fully charged.

User-defined color (Battery mode) – Computer is running on battery and the battery has more than 10 percent charge.

User-defined color (Breath) – Computer is in sleep state.

Off – Computer is in hibernation, or turned off.

The power and battery-status light blinks red and blue along with beep codes indicating failures.

For example, the power and battery-status light blinks red two times followed by a pause, and then blinks blue three times followed by a pause. This 2,3 pattern continues until the computer is turned off indicating no memory or RAM is detected.

The following table shows different light patterns and what they indicate.

Table 12. Diagnostics

Light Pattern	Problem description
2,1	CPU failure
2,2	System board: BIOS and ROM failure
2,3	No memory or RAM detected
2,4	Memory or RAM failure
2,5	Invalid memory installed
2,6	System board or chipset error
2,7	LCD failure
3,1	CMOS battery failure
3,2	PCI/video card failure

Light Pattern	Problem description
3,3	Recovery image not found
3,4	Recovery image found but invalid

Camera status light: Indicates whether the camera is in use.

- Solid white – Camera is in use.
- Off – Camera is not in use.

Caps Lock status light: Indicates whether Caps Lock is enabled or disabled.

- Solid white – Caps Lock enabled.
- Off – Caps Lock disabled.

Network port light: Indicates network connectivity.

- Off – No network connection.
- Solid green – 10 Mbps connection.
- Solid orange – 100 Mbps connection.
- Solid yellow – 1000 Mbps connection.
- Flicker yellow – Network activity.

Wi-Fi power cycle

If your computer is unable to access the internet due to Wi-Fi connectivity issues a Wi-Fi power cycle procedure may be performed. The following procedure provides the instructions on how to conduct a Wi-Fi power cycle:



NOTE: Some ISPs (Internet Service Providers) provide a modem/router combo device.

- 1 Turn off your computer.
- 2 Turn off the modem.
- 3 Turn off the wireless router.
- 4 Wait for 30 seconds.
- 5 Turn on the wireless router.
- 6 Turn on the modem.
- 7 Turn on your computer.

Flea power release

Flea power is the residual static electricity that remains on the computer even after it has been powered off and the battery has been removed. The following procedure provides the instructions on how to conduct flea power release:



- 1 Turn off your computer.
- 2 Remove the [base cover](#).
- 3 Press and hold the power button for 15 seconds to drain the flea power.
- 4 Replace the [base cover](#).
- 5 Turn on your computer.

Getting help and contacting Alienware

Self-help resources

You can get information and help on Alienware products and services using these online self-help resources:

Table 13. Alienware products and online self-help resources

Information about Alienware products and services	www.alienware.com
Dell Help & Support app	
Tips	
Contact Support	In Windows search, type Contact Support , and press Enter .
Online help for operating system	www.dell.com/support/windows www.dell.com/support/linux
Troubleshooting information, user manuals, setup instructions, product specifications, technical help blogs, drivers, software updates, and so on	www.alienware.com/gamingservices
VR Support	www.dell.com/VRsupport
Tobii Eye Tracker and Tobii Eye Tracking	www.tobii.com
Videos providing step-by-step instructions to service your computer	www.youtube.com/alienwareservices

Contacting Alienware

To contact Alienware for sales, technical support, or customer service issues, see www.alienware.com.



NOTE: Availability varies by country and product, and some services may not be available in your country.



NOTE: If you do not have an active internet connection, you can find contact information on your purchase invoice, packing slip, bill, or Dell product catalog.