

# HP Z6 G4 Workstation Architecture



The HP Z6 G4 is the successor to the HP Z640 personal workstation. Its architecture introduces several new functionalities and technologies. These include all new Intel® memory architecture, Intel®-integrated 10 GbE, I/O slot improvements and better performance.

## Table of contents

Chassis and system highlights.....	2
System Architecture.....	4
I/O slot optimizations.....	7
Storage configuration and RAID .....	10
Memory configurations and optimization.....	22

# Chassis and system highlights

More power and configurability! HP is proud to introduce the all new HP Z6 G4 Workstation. This surprisingly small workstation has been completely redesigned to provide maximum expandability and performance in minimal space. The HP Z6 G4 continues the HP tradition of tool-free design and amazingly quiet acoustics.

## Mobility and flexibility

Workstation customers continue to express the need for easy system mobility. The HP Z6 G4 has integrated front and rear carrying handles and slick feet to easily slide the unit around.

The flexible HP Z6 G4 design allows for the system to be used in the tower orientation or rack-mounted on a convenient slide-out tray. To offer additional flexibility in deployment, the HP Z6 G4 is modular by design allowing it to be configured as a single or dual processor system. The optional 2nd processor module provides the second CPU and 6 additional memory slots – providing a total of 12 DIMM slots for this very compact dual processor workstation! Adding or upgrading memory on the 2nd processor module is extremely easy – no tools required and it takes only seconds to remove and install, featuring intuitive touchpoints and handles, user-friendly positive latching, self-aligning guides, and blind-mate interconnect (no manual cable connections).

With two internal storage bays, two M.2 storage slots, two 5.25" external device bays, a dedicated 9.5 mm slim ODD bay, and expanded PCIe Gen 3 capability, the HP Z6 G4 delivers more flexibility for storage and accessory options. The internal storage bays feature tool-free drive carriers which are compatible with industry standard 3.5" storage devices or 2.5" devices with optional adapter. The HP Z6 G4 also provides tool-free accessibility to the external device bays – expanding storage capabilities, allowing additional I/O options, or customer specific devices.

New with this generation of premium workstations, the Front IO-User Interface is now modular and configurable with two options to choose from. Both modules feature the power button/LED, HDD activity LED, audio jack, USB charging port, and optional SD card reader. The Entry module features 4 USB 3.1 Gen 1 Type-A ports, while the Premium module provides 2 USB 3.1 Gen 2 Type-C ports and 2 USB 3.1 Gen 1 Type-A ports.

## Interior design

The streamlined interior is well organized and all user serviceable components are identified with consistent blue touchpoints. The service label located on the access panel provides users with system board and memory loading information and quick access to diagnostic information. Cables are efficiently routed to provide better component access and airflow management.



## Tool-free design

HP has always been a leader in tool-free product design and the HP Z6 G4 continues this tradition. The following components can be easily accessed or upgraded without tools: side access panel, hard drives, external bay devices, memory, expansion cards, and the 2nd CPU/memory module.



## Security

Due to the tool-free ease of use, HP understands system and component security may be a concern; therefore, several security features have been incorporated. The padlock loop and Kensington security slot are included standard. The side access panel keylock, HP Business PC Security Lock kit, system intrusion sensor, and the remotely activated solenoid lock are available as options.

## Quiet and reliable

Acoustic noise is very important to HP and our customers because a noisy environment can increase user fatigue and reduces productivity. HP continues its leadership in this area with the design of the HP Z6 G4. Even with an increase in power each generation, HP strives to maintain the same or better acoustic levels. This is achieved with some innovative engineering using very efficient heatsink design, strategically placed fans, and active fan control. As with all our premium workstations, the hard drives are mechanically isolated to reduce vibration and noise. The system is arranged so that sensitive components receive fresh cool air. With internal fans distributed throughout the system, airflow is targeted at the high power-density components. HP's advanced algorithms control fan speeds in real time based on system configuration, environment, and key component temperatures to provide users with an exceptionally quiet system and uncompromising reliability and performance.

While low acoustics and thermal reliability are priorities, it is also important that the system can withstand difficult physical environments. The HP Z6 G4 is built to withstand high shock and vibration environments. Rigorous climatic and dynamic testing helps to ensure HP Workstations are highly reliable in demanding conditions.

## Designed with the environment in mind

HP is committed to environmental sustainability and energy efficiency. To reduce energy consumption, HP Workstations offer ENERGY STAR<sup>®5,6</sup> qualified configurations and the HP Z6 G4 features a 90% efficient power supply. The HP Workstation design team has taken a proactive approach (beyond industry regulations) to recyclability and selecting materials that reduce the impact on the environment. HP Z6 G4 configurations, are available with low-halogen material<sup>1</sup>.

# System Architecture

## New technologies

### **New Intel® Processor micro-architecture**

The HP Z6 G4 Workstation uses the Intel® C622 chipset to support the latest Intel® Xeon® processor Scalable family<sup>8</sup> including processors of up to twenty-eight-cores and up to 205W. Intel® Xeon® Scalable processors feature a new micro-architecture with new Intel® AVX-512 (Intel® Advanced Vector Extensions for 512-bit) instructions, all new memory architecture, Intel® Ultra Path Interconnect (Intel® UPI), 48 PCIe Gen3 lanes and optional integrated 10 Gigabit Ethernet. The Intel® Xeon® Scalable family processors feature two integrated memory controllers each supporting three DDR4 channels that increase the memory capacity and bandwidth by 50%. The dual Intel® Ultra Path Interconnect (Intel® UPI) between the two processors supports data transfers up to 10.4 GT/s increasing peak data transfers and bandwidth over the HP Z640. Each processor supports 48 lanes of PCIe Gen3, a 20% increase over the previous generation.

### **Intel® Advanced Vector Extensions 512 (Intel® AVX-512)**

The new Intel® AVX-512 instructions extend the Intel® Advanced Vector Extensions (Intel® AVX) instructions with 512-bit integer instructions. The 512-bit integer vectors benefit enterprise-class and High Performance computing workloads.

### **Next generation Intel® Active Management Technology**

New features for Intel® AMT 11.0 and later include:

USB-Redirect with ME 11.x and later, USB-Redirect (USB-R; AKA Media Redirection) has replaced IDE-Redirection as the interface for directing a media image from a local system to a remote system. With USB-R, a USB drive image is created on the remote system to mount as a drive accessible to the local OS or BIOS. This feature can be used for file sharing, installing software, or reimaging a remote system.

### **Memory technology**

The HP Z6 G4 Workstation introduces support for DDR4 2666MHz Registered DIMMs<sup>3</sup>. The speed that the memory runs is determined by the processors and is limited to 2666MHz for the Skylake processor generation. The HP Z6 Workstation supports up to 356 GB of DDR4 memory. NUMA and Non-NUMA modes are supported and dynamic power saving is enabled.

### **USB 3.1 Gen2 Type-C**

The HP Z6 G4 configured with the Premium Front I/O module provides two USB 3.1 Gen2 Type-C ports in addition to two USB 3.1 Gen1 Type-A ports. The Type-C ports each deliver up to 15W of power (3A @ 5V) when the system is running. More information on USB Technology and Performance measurements can be found in the “Resources, contacts, or additional links” section below.

## I/O and storage

### **Internal I/O**

The HP Z6 G4 provides a total of six high-performance Graphics and I/O slots. An additional bulkhead allows for a seventh mechanical-only IO card (e.g. SDI card).

The HP Z6 G4 provides two PCIe3 x16 and three PCIe3 x4 dedicated electrical slots. An additional two PCIe3 x4 buses feed the two on-board M.2 slots. The sixth high-performance I/O slot serves as a PCIe3 x4 or x8 slot depending on whether the second M.2 slot is occupied. A PCIe mux switches in an additional four PCIe lanes when the second M.2 slot is not used.

The HP Z6 G4 provides an internal 1-port USB 3.0 header, an internal 2-port USB 2.0 header and an internal 1-port USB 2.0 header.

### **Storage**

The HP Z6 G4 supports six 6 Gb/s SATA ports on the Intel® C622 chipset’s sSATA controller.

The sSATA controller operates in AHCI mode or RAID mode and supports RAID modes 0, 1, 5 and 10. The sSATA ports can be routed to the rear panel with an eSATA bulkhead option.

### External I/O

On the front I/O area, the HP Z6 G4 can be configured two ways.

- The Entry Front I/O option provides 4 USB 3.1 Gen1 Type-A ports (the left-most supports battery charging), combo headset/microphone jack, and the option for an SD card reader.
- The Premium Front I/O option provides 2 USB 3.1 Gen2 Type-C ports, 2 USB 3.1 Gen1 Type-A ports (the left-most supports battery charging), combo headset/microphone jack, and the option for an SD card reader.

In the rear I/O area, the HP Z6 G4 provides 6 USB 3.0 ports, 2 gigabit Ethernet LAN ports, audio Line-In, audio Line-Out and PS/2 ports. Additional rear I/O ports can be added via PCIe add-in cards.

## Graphics

### Graphics

The HP Z6 G4 depending on system configurations can support up to three 75W cards, or up to two 180W cards or one 250W card.

## Other features

- 1000W power supply, 90% efficient
- Rear panel power on/off switch and LED for easier rack maintenance
- ENERGY STAR® qualified configurations, China's Energy Conservation Program (CECP) configurations, European Union's ErP LOT6 2013 power limit of 0.5W in Max Power Savings off mode.
- Intel® vPro™ manageability with support both for DASH and Intel® AMT (Advanced Manageability Technology) on all the Xeon® processors. IT managers have increased flexibility in optimizing their Enterprise manageability strategy across HP's Commercial Laptops, Desktops and Workstations.

## HP Z6 G4 vs HP Z640 feature comparison

**Table 1.** HP Z6 G4 vs HP Z640 feature comparison

	HP Z6 G4	HP Z640
Operating System	Windows 10 Professional 64-bit	Windows 8.1 Professional 64-bit
	Windows 7 Professional 64-bit	Windows 7 Professional 64-bit
Processors	Intel® Xeon Scalable Processor	Intel® Xeon E5-2600v3
New instruction set	AVX-512	AVX2
	AES-NI	AES-NI
Memory technology	DDR4: Registered DIMMs	DDR4: Registered and LR-DIMMs
	Up to 2666MHz <sup>3</sup>	Up to 2400MHz
USB enhancement	Two USB 3.1 Gen2 Type-C ports (Premium Front I/O option)	USB charging port on top-most front port
USB 3.1 Gen1 ports	6 Rear, 4 Front (Entry Front I/O) or 2 Front (Premium Front I/O), 1 Internal	4 Rear, 4 Front, 1 Internal
Manageability	Intel® ME11.20/AMT11, Intel® vPro	Intel® ME9.1/AMT9.1, Intel® vPro

## HP Z6 G4 supported CPU line-up at introduction

Name	Clock Speed (GHz)	Cores	Cache (MB)	Memory Speed (MHz)	UPI Speed (GT/s)	Hyper Threading	Featuring Intel® vPro™ Technology	Intel® Turbo Boost Technology <sup>2</sup>	TDP (W)
Intel® Xeon® 8180 processor	2.5	28	38.5	2666	10.4	YES	YES	13/7	205
Intel® Xeon® 8160 processor	2.1	24	33	2666	10.4	YES	YES	16/7	150
Intel® Xeon® 6152 processor	2.1	22	30.25	2666	10.4	YES	YES	16/7	140
Intel® Xeon® 6154 processor	3	18	24.75	2666	10.4	YES	YES	7/7	200
Intel® Xeon® 6148 processor	2.4	20	27.5	2666	10.4	YES	YES	13/7	150
Intel® Xeon® 6142 processor	2.6	16	22	2666	10.4	YES	YES	11/7	150
Intel® Xeon® 6146 processor	3.2	12	24.75	2666	10.4	YES	YES		165
Intel® Xeon® 6136 processor	3	12	24.75	2666	10.4	YES	YES	7/6	150
Intel® Xeon® 6140 processor	2.3	18	24.75	2666	10.4	YES	YES	14/7	140
Intel® Xeon® 6144 processor	3.5	8	24.75	2666	10.4	YES	YES		165
Intel® Xeon® 6134 processor	3.2	8	24.75	2666	10.4	YES	YES	5/5	130
Intel® Xeon® 6132 processor	2.6	14	19.25	2666	10.4	YES	YES	11/7	140
Intel® Xeon® 6130 processor	2.1	16	22	2666	10.4	YES	YES	16/7	125
Intel® Xeon® 6128 processor	3.4	6	19.25	2666	10.4	YES	YES	3/3	115
Intel® Xeon® 5120 processor	2.2	14	19.25	2400	10.4	YES	YES	10/4	105
Intel® Xeon® 5118 processor	2.3	12	16.5	2400	10.4	YES	YES	9/4	105
Intel® Xeon® 5122 processor	3.6	4	16.5	2666	10.4	YES	YES	1/1	105
Intel® Xeon® 4116 processor	2.1	12	16.5	2400	9.6	YES	YES	9/3	85
Intel® Xeon® 4114 processor	2.2	10	13.75	2400	9.6	YES	YES	8/3	85
Intel® Xeon® 4112 processor	2.6	4	8.25	2400	9.6	YES	YES	4/3	85
Intel® Xeon® 4108 processor	1.8	8	11	2400	9.6	YES	YES	12/3	85
Intel® Xeon® 3106 processor	1.7	8	11	2133	9.6	NO	YES	N/A	85
Intel® Xeon® 3104 processor	1.7	6	8.25	2133	9.6	NO	YES	N/A	85

<sup>1</sup>The specifications shown in this column represent the following: (one core maximum turbo steps, all core maximum turbo steps) assuming non-AVX operation. Turbo boost stepping occurs in 100MHz increments. Processors that do not have turbo functionality are denoted as N/A.

# I/O slot optimizations

The HP Z6 G4 Workstation utilizes PCI-Express 3.0 technology with high performance over a variety of conditions. This paper provides guidance on optimizing the performance of your system when using PCI-Express cards.

Figure 1. HP Z6 G4 Workstation Block Diagram

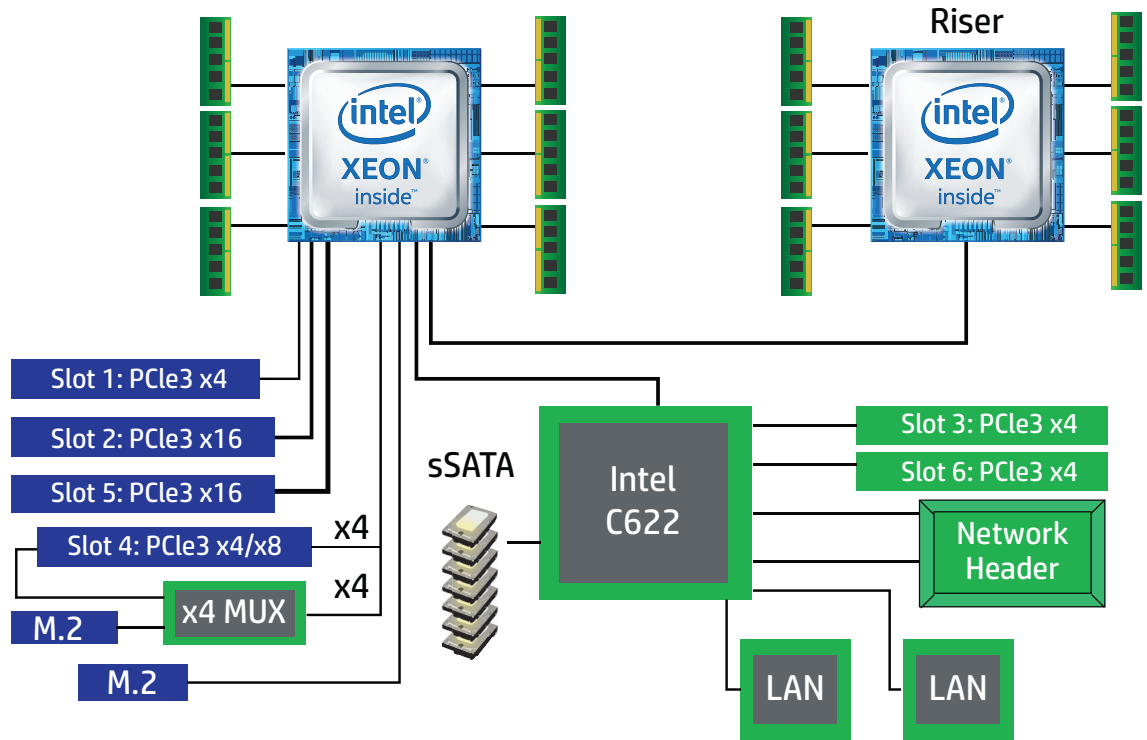

Slot 4 is x4 if 2<sup>nd</sup> M.2 is installed.

## Integrated PCI-Express 3.0

The HP Z6 G4 uses the Intel® Xeon® processor Scalable family, with integrated PCI-Express 3.0 controllers delivering a peak bandwidth of 16 GB/s per direction for each x16 slot (1 GB/s per lane). PCI-Express 3.0 is backward compatible with 1.0 and 2.0, and slots will train to the highest common speed.

PCI-Express 3.0 slots will initialize at 1.0 and then transition to 3.0 through a training sequence that involves four adaptive training phases. It is recommended to carefully evaluate and validate PCI-Express 3.0 devices that are not available or supported from HP.

## PCI-Express performance

The HP Z6 G4 integrates several features within the processor: Three PCIe 3.0 controllers, DMA caching, two 3-channel memory controllers per processor (1 DIMM per channel), and a dual UPI processor interconnect at up to 10.4 GT/s. This produces excellent performance in I/O bandwidth, remote bandwidth, and latency.

Figure 2. x16 Peak Bandwidth per Direction-GB/s

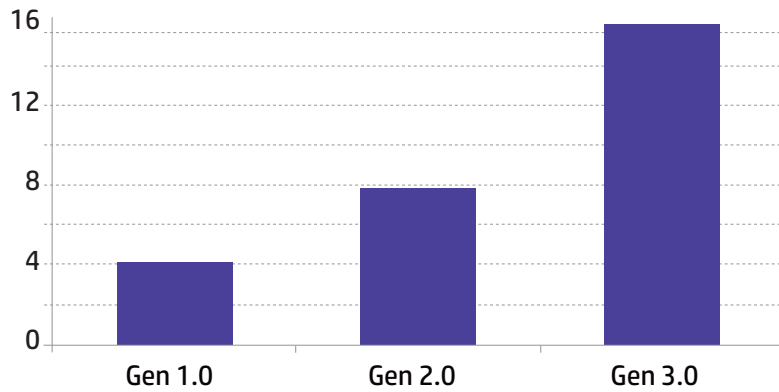

## PCI-Express I/O slot options

The HP Z6 G4 provides a total of six high-performance Graphics and I/O slots and supports up to three PCIe 3.0 graphics cards. Two M.2 slots are also available at PCIe 3.0 speeds. A mux provides the user with the option to either add a second M.2 device or expand slot 4 to 8 lanes. An additional bulkhead allows for a seventh mechanical-only I/O card when the CPU Riser is not installed. The HP Z6 G4, depending on system configurations, can support up to three 75W cards, or up to two 180W cards or one 250W card.

Figure 3.

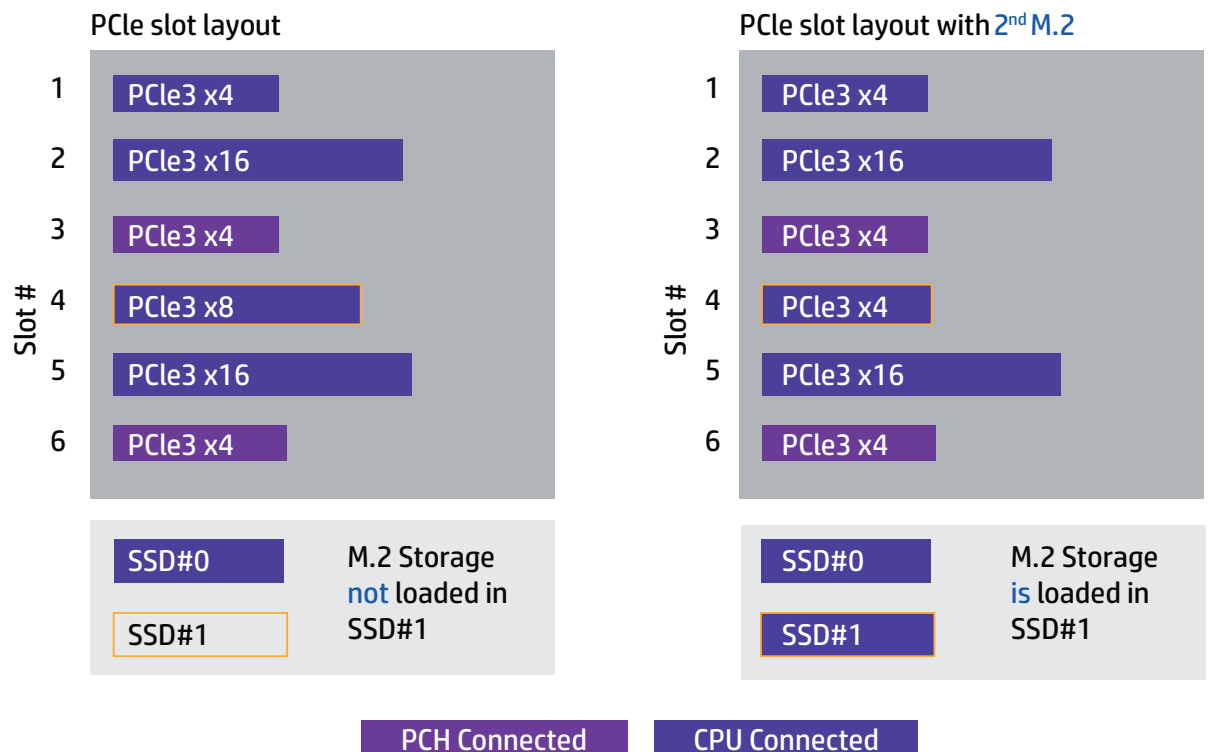

## Recipe for optimizing PCI-Express I/O performance

For high I/O bandwidth applications, the choice of slot loading, processor, and memory configuration can be optimized to ensure maximum bandwidth available. Applications and cards sensitive to I/O latency may benefit as well from some of the tips below.

### Recommended configuration steps

1. Place GPU and graphics cards first, following the slot order listed in Table 2.
2. Place I/O cards next, from highest bandwidth to lowest, following the slot order listed in Table 2. This is the optimal load order for most applications.
3. Additional I/O bandwidth refinements may be possible. If necessary, refer to the tips below.

**Table 2.** HP Z6 G4 I/O Slot Recommended Load Order

Load priority	Card description	Slot 0 Riser / Mech	Slot 1 x 4	Slot 2 x 16	Slot 3 x 4	Slot 4* x4/x8	Slot 5 x16	Slot 6 x4
1	Riser	Only						
2	1st Graphics	NA		Only				
3	Z Turbo Drive Quad Pro <sup>7</sup> (4x M.2 Card)	NA					Only	
4	2nd Graphics	NA				2	1	
5	3rd Graphics	NA	2			1		
6	SAS	NA				2	1	
7	Network Interface Controller- 10G	NA				2	1	
8	Network Interface Controller < 10G	NA	1		3	4		2
9	eSATA (2x port cable)	5 (no riser)			4	3	2	1
10	Wireless Network	NA	1		2	3		
11	Serial port (1x port cable)	Maybe			4	3	2	1

\* Slot 4 is x4 with an M.2 device in SSD#1, x8 otherwise

### Additional tips

- Use SSD#0 if installing only one M.2 device.
- For applications doing direct bus Peer-to-Peer transfers between cards, load the corresponding cards in slots located behind the same processor. For instance, load cards in slots 2, 4, 5, 7, and 8, or in slots 1, 3, 6, and 9.
- For very high bandwidth applications in dual processor systems, select processor models with the highest QPI frequency (10.4 GT/s).
- If possible, make sure all I/O cards are loaded in slots that have a PCI-Express Lane Width at least as wide as the card (see Table 2).
- For predictable latencies, try disabling NUMA (Non-Uniform Memory Access) mode (BIOS setup menu -> Advanced -> Performance Options -> Non-Uniform Memory Access (NUMA) = Disable).
- For cards that are latency sensitive, load these cards in processor slots.
- Ensure Idle Power Savings BIOS setting is set to Normal (BIOS setup menu -> Advanced -> Power Options -> Idle Power Savings = Normal).
- Use the latest system BIOS version available on [hp.com](http://hp.com).
- Check for updates in the latest performance optimization white papers (link below).

# Storage configuration and RAID

The HP Z6 G4 Workstation includes a 6 port, 6 GB/s Intel® sSATA RAID controller.

## SATA storage features

### Controller interfaces and supported drive types

The controllers support the following drive types and max link speeds:

Controller	Number of ports	Max link speed	Interface type	Drives supported*
sSATA	6	6 GB/s	SATA	SSD, SED, HDD, ODD, and eSATA

\*Key management software used with SED drives requires that SATA emulation mode be set to AHCI.

### RAID Levels

The RAID levels supported are shown in the table below:

Controller	Number of ports	RAID levels	Max RAIDs
sSATA	6	0, 1, 5, 10	2

### Option ROM Launch Policy

In the Pre-OS environment, HP Workstations can use either Option ROM (OROM) or a Unified Extensible Firmware.

Interface (UEFI) driver for configuration and management of the RAID controllers. The default shipping configuration is set to All UEFI. This can be changed in BIOS Setup under *Advanced > Option ROM Launch Policy*. Select the desired Option ROM Launch Policy from the pull down menu.

The OROM or UEFI driver is not available when the sSATA controller is set to AHCI.

When the Option ROM Launch Policy is set to All Legacy, the sSATA OROM will only display at power on if there are two or more RAID capable devices attached to the controller, or a single device is attached that contains RAID metadata. In the latter case, the OROM will show that the RAID is failed or degraded.

When the Option ROM Launch Policy is set to UEFI, the legacy OROM will not display and management of RAID can be performed in **3<sup>rd</sup> Party Option ROM Management** from the **BIOS Startup Menu**, or by pressing **F3** during **POST**.

### Controller Enable/Disable

The sSATA controller can be Disabled or Enabled from the BIOS menu under *Advanced > Device Configurations*. Select Enable or Disable from the pull down menu for the controller that you would like to Enable or Disable. By default the sSATA controller is enabled.

### Per port Enable/Disable of sSATA ports

Individual sSATA ports can be Disabled or Enabled individually from the BIOS menu under *Advanced > Device Configurations*. Select Enable or Disable from the pull down menu for the Port that you would like to Enable or Disable. By default all of the sSATA ports are enabled.

### External SATA (eSATA)

External SATA (eSATA) is supported on the sSATA controller with an optional eSATA bulkhead adapter.

Ports can be configured individually as eSATA in the BIOS under `Advanced > Device Configurations > eSATA Port n` under the sSATA controller. When a port is designated as eSATA, the port link speed may be limited to 3 GB/s.

An option to eject the drive will be available from the `Windows Taskbar Safely Remove Hardware and Eject Media` applet. Disks included in a RAID array will not be visible in the Eject applet. The current OS disk may be visible in the Eject applet but cannot be ejected. External drives can be hot plugged if the drive is compatible with hot plugging.

Hot plug or Hot unplug and surprise removal/insertion of internal drives is not recommended.

### SATA emulation modes

The sSATA controller is capable of being set to two different SATA emulation modes. Controls are provided for SATA Emulation Mode in the BIOS under `Advanced > Device Configurations > SATA Emulation Mode`

- RAID (Default; ACHI + RAID capability with greatest flexibility for most users).
- AHCI (Required when using SEDs).

## AHCI and RAID technology

The default SATA emulation mode on HP Workstations is RAID (RAID + AHCI) unless SEDs are installed. If SEDs are installed, the SATA emulation mode will be set to AHCI. The SATA emulation mode can be changed in BIOS setup under `Advanced > Device Configurations`, but changing the mode is not recommended and can result in boot failure<sup>7</sup> or data loss if the SATA emulation mode is changed after the OS is installed or if a volume already contains data. Always back up your data before making any storage system changes.

### RAID

RAID provides all of the benefits of AHCI with the added flexibility of RAID for configurations needing performance or data redundancy. Even if you don't use RAID today, setting the SATA mode to RAID makes your system RAID ready for the future. RAID is the preferred mode and default storage configuration SATA mode set in HP Workstation BIOS.

### AHCI (Advanced Host Controller Interface)

AHCI is a technical standard developed by Intel® for the hardware mechanism that allows software to communicate with SATA (Serial ATA) devices. It is enumerated as a PCI device and transfers data between system memory and SATA devices.

AHCI provides many benefits over the legacy IDE (Integrated Drive Electronics) hard drive interface. Some of the benefits include:

- Elimination of master/slave handling.
- Native Command Queuing (NCQ) that allows a SATA device to internally optimize the order of command execution for increased performance.
- TRIM command support for SSDs which keeps track of files that have been deleted but not erased on the drive. This improves performance of the drive and helps extend the life of the SSD by preventing unnecessary writes.

### Supported RAID levels

RAID provides a method of combining multiple disks into a single logical volume to increase performance or create data redundancy.

**RAID 0** – Creates a single volume that has data striped across two or more drives on the same controller. The size of the volume is based on the size of the smallest capacity drive times the number of drives in the RAID 0 configuration. RAID 0 is typically used to improve performance or create a larger volume from smaller drives. There is no data redundancy or parity in a RAID 0 configuration.

**RAID 1** – Creates a single volume that is a mirror image of identical data on two physical drives on the same controller. The size of the mirror is limited by the smallest drive used in the RAID 1 configuration. This configuration provides data redundancy protection against a single drive failure, does not use parity, and does not improve performance. If a drive fails, the drive can be replaced by a drive of the same capacity or larger capacity to rebuild the RAID array.

**RAID 5** – Creates a single volume from three or more physical drives on the same controller.

RAID 5 uses striping with parity data in distributed blocks across all member disks. A RAID 5 volume is tolerant of a single disk failure. RAID 5 has performance attributes similar to a RAID 0 and reliability of RAID 1, however parity calculations can reduce the performance relative to a RAID 0.

**RAID 10** – Creates a mirror of pair of drives, and then stripes the data on the mirrored pairs. A RAID 10 must contain two or more drive pairs, with a four drive minimum. A RAID 10 is fault tolerant to one drive per mirrored pair.

## Creating RAID arrays on the sSATA controller

RAID arrays on sSATA controller can be created through Option ROM (OROM) at power on, UEFI driver within **3<sup>rd</sup> Party Option ROM Management** from the BIOS **Startup Menu**, DOS utilities, EFI shell utilities, Windows command line utilities, or from a graphical user interface (GUI) within the Windows OS.

### 1. Pre-OS RAID creation through the Option ROM (OROM)

In order to use the OROM for configuration of RAID arrays, the Option ROM Launch Policy in BIOS must be set to **All Legacy**. This is the default as shipped configuration and can be changed in BIOS Setup under **Advanced > Option ROM Launch Policy**.

To access the OROM, press Ctrl-I as soon as you see Intel® Rapid Storage Technology enterprise Option ROM.

The OROM will only display at power on if there are two or more RAID capable devices attached to the controller, or a single device is attached that contains RAID metadata. In the latter case, the OROM will show that the RAID is failed or degraded.

Once in the OROM, you can Create RAID Volumes, Delete RAID Volumes, Reset Disks to Non-RAID, or Exit. The keys available for use are listed at the bottom of the screen.

Example: RAID volume creation on the SATA controller through OROM.

- a. Use the **Up/Down** arrows to navigate to “1. Create RAID Volume” if not already selected.
- b. Enter the desired volume name and press **Tab** or **Enter**.
- c. Use the **Up/Down** arrows to scroll through available RAID levels. A description of the level will appear in the “HELP” box. Select the desired RAID level and press **Tab** or **Enter**.
- d. Press **Enter** to open the “SELECT DISKS” window.
- e. Use the **Up/Down** arrows to highlight a desired disk and press **Space** to select the disk. Press **Enter** after you have selected all of the disks that you want to be included in the RAID.
- f. If you are creating a RAID array that is striped, you can use the **Up/Down** arrows to change strip size if desired. Press **Enter** when done.
- g. Capacity will be automatically calculated for you based on the RAID type. The capacity shown may be around 95% of the actual available capacity. In a mirrored array, the reserved space helps to ensure that a failed drive can be replaced with another drive of the same listed capacity even if the actual capacity is slightly less than the listed capacity. Press **Enter** to accept the default capacity.
- h. Press **Enter** to create the volume.

Similarly a user can Delete RAID volumes or reset disks to Non-RAID status by following the on screen prompts and using the keys listed at the bottom of each screen.

### 2. RAID creation using the UEFI driver within 3<sup>rd</sup> Party Option ROM Management in BIOS setup

In order to create RAID arrays using the UEFI driver within 3<sup>rd</sup> Party Option ROM Management in the BIOS, the **Option ROM Launch Policy** in BIOS must be set to **All UEFI** or **All UEFI Except Video**. This can be changed in BIOS Setup under **Advanced > Option ROM Launch Policy**.

The UEFI driver interface can be reached in BIOS in the following ways:

- Press **Esc** when powering up the system to enter the BIOS **Startup Menu** and select **3<sup>rd</sup> Party Option ROM Management**. This will take you directly to the **Drivers** screen where you can select the controller that you want to configure RAID on. If a controller does not have devices attached, it will not show up in the menu.
- Press **F3** when powering up the system to enter the **Drivers** screen directly.
- Press **F10** when powering up the system to enter BIOS Setup, navigate to UEFI Drivers and select **3<sup>rd</sup> Party Option ROM Management**. This will cause the system to reboot and directly enter the Drivers screen.

Use the **Up/Down** arrows to select the Intel® RSTe sSATA Controller. From here you can create a new RAID volume or view existing configurations.

Example: RAID volume creation on sSATA controller using the UEFI Driver interface.

- a. Use the **Up/Down** arrows to select **Create RAID Volume** and press **Enter**.
- b. Use the **Up/Down** arrows to select **Name** and press **Enter** to pop up a box for editing the volume name. Change the name if desired and press **Enter** to close the edit box.

- c. Use the **Up/Down** arrows to select **RAID Level** and press **Enter** to show available RAID levels. Use the **Up/Down** arrows to select the desired RAID level and press **Enter** to accept.
- d. Use the **Up/Down** arrows to navigate to "< >" behind the drives you want to include in the array. Press **Enter** to open a selection box and use **Up/Down** arrows to change from blank to "X". Press **Enter** to accept. Continue selecting drives until you have selected all of the drives that you want to include in the RAID array.
- e. Arrays that use striping, will have an option to select strip size. You can accept the default by navigating past it or press **Enter** and make a selection.
- f. Leave the capacity as default
- g. Use the **Up/Down** arrows to select Create Volume and press **Enter** to create the array. This will take you back to the main screen for the current controller where you can create an additional RAID array (up to 2 arrays) or view already created arrays.

### 3. RAID creation from a DOS or EFI shell.

RAID arrays can be created in a DOS or EFI shell by using the shell specific Intel® RAID Utility for the controller. This is useful in a deployment environment where an organization wants to configure multiple systems identically. The utilities can also be run from a DOS or EFI bootable USB key.

The utilities are specific to a particular driver version and are available with the driver package downloadable from [hp.com](http://hp.com).

The utilities are:

#### DOS Shell

- RCfgSata.exe (For the SATA controller)

#### EFI Shell

- RCfgSata.efi (For the SATA controller)

For the latest commands use "/"? option when executing the command.

Example:

```
> RCfgSata.exe /? Press Enter
```

Results in:

Intel® RAID Utility for Serial ATA–vn.n.n.nnnn

```
RCfgSata.exe [/?] [/Y] [/Q] [/C:vol _ name] [/SS:strip _ size] [/L:raid _ level]
[/S:vol _ size] [/DS:disk _ id] [/D:vol _ name] [/X] [/I] [/P] [/U] [/ST] [/V]
```

/? Displays Help Screen. Other options ignored.

/Y Suppress any user input. Used with options /C, /D, & /X.

/Q Quiet mode/No output. Should not be used with status commands.

#### COMMANDS—Only one at a time.

/C Create a volume with the specified name.

/S, /DS, /SS, & /L can be specified along with /C.

/SS Specify strip size in KB. Only valid with /C.

/L Specify RAID Level (0, 1, 10, or 5). Only valid with /C.

/S Specify volume size in GB or percentage if a '%' is appended.

Percentage must be between 1-100. Only valid with /C.

/DS Selects the disks to be used in the creation of volume.

#### List should be delimited by spaces.

/D Delete Volume with specified name.

/X Remove all metadata from all disks. Use with /DS to delete metadata from selected disks.

/I Display All Drive/Volume/Array Information. /P can be specified.

/P Pause display between sections. Only valid with /I or /ST.

- /U Do not delete the partition table. Only valid with /C on RAID 1 volumes.
- /ST Display Volume/RAID/Disk Status.
- /V Display version information.

#### 4. RAID creation from a Windows Administrator Command Prompt.

RAID arrays can be created by using the Intel® Rapid Storage Technology enterprise (RSTe) Command Line Interface (RSTCLI) for 32-bit and 64-bit Windows operating systems. RSTCLI is included in the Intel® RSTe driver package for your system, downloadable from [hp.com](http://hp.com). The RSTCLI must be executed from an administrator command prompt. If you attempt to execute the RSTCLI utility from a non-administrator command prompt, you will receive the following message: “Could not obtain system information to display middleware version.”

See the **RSTe CLI Specification** included with the RSTCLI for specific usage instructions.

#### 5. RAID creation from within the OS using the Intel® Rapid Storage Technology enterprise GUI.

The RSTe GUI provides an easy method for creating RAID arrays. The RSTe GUI is pre-installed on systems shipped from the factory, and can also be installed from the latest driver package available on [hp.com](http://hp.com).

Launch Intel® Rapid Storage Technology enterprise GUI by navigating to it from the start menu, or press the **Windows** key and then start typing “Intel®” in the Box that appears. A short list should appear that contains “Intel® Rapid Storage Technology enterprise”. Click this item with the mouse to launch the GUI.

Click the “Create Volume...” button to start the guided RAID array creation process. Additional help is available on each page of RAID creation process by clicking on “More help on this page” at the lower right corner of each page. A balloon with a question mark inside will be displayed if help or suggestions are available for a specific topic. Click on the balloon to display the help on the item in a new page.

## Z Turbo Drive storage features

The HP Z6 G4 workstation can support up to 6 Z Turbo Drives<sup>11</sup>. All Z Turbo Drives qualified on HP Z6 G4 are NVMe storage devices. There are two M.2 slots on the system board, and up to four additional M.2 modules may be added via a Z Turbo Drive Quad Pro carrier.

The two M.2 slots on the system board can accommodate M.2 modules up to the 22110 form factor. The Z Turbo Drive Quad Pro can accommodate four modules up the 22110 form factor.

#### TRIM support for HP Z Turbo Drives

TRIM keeps track of files that have been deleted but not erased on the drive to improve performance and help extend the life of the SSD. TRIM is not an acronym, but is a command specific to SSDs and is typically represented by TRIM in all upper case. TRIM is supported on NVMe devices using the DATASET MANAGEMENT command.

#### Configuring RAID with HP Z Turbo Drives using Microsoft Windows

Once the HP Z Turbo Drives are installed in the system and the system has been rebooted, launch **Disk Management**.

- For Windows 7 systems, click **Start**, right-click on **Computer**, select **Manage**, select **Disk Management**.
- For Windows 8 and later systems, hit the **Windows+X** keys on the keyboard, select **Disk Management**.

If the HP Z Turbo Drives are new, you will be asked to initialize the drives.

- Choose either **Master Boot Record (MBR)** or **GUID Partition Table (GPT)**.
  - You can use MBR or GPT for arrays smaller than 2.2 TB (e.g. the array size for two 512 GB drives in a RAID 0 is equal to 1 TB; the array size for two 512 GB drives in a RAID 1 is equal to 512 GB).
  - GPT must be used for arrays larger than 2.2 TB (e.g. the array size for four 1 TB drives in a RAID 0 is equal to 4 TB).
- Click **OK**.

Figure 4. Initialize disk

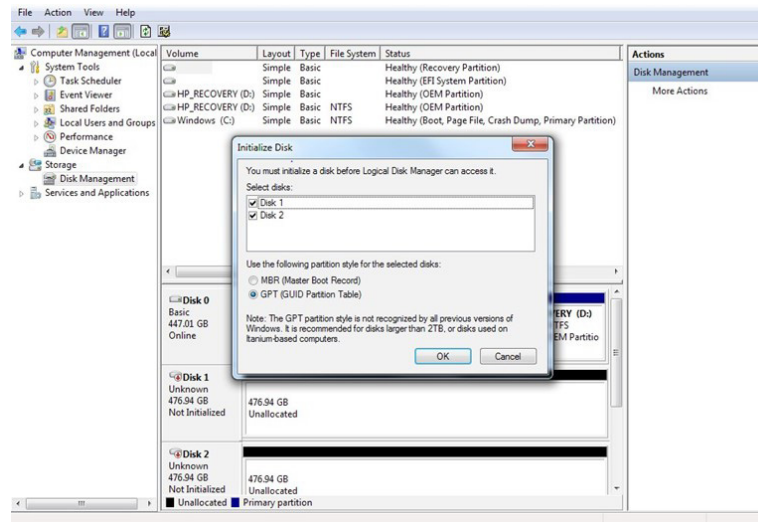

The drives are now initialized but unallocated.

Figure 5. Initialized but unallocated drives

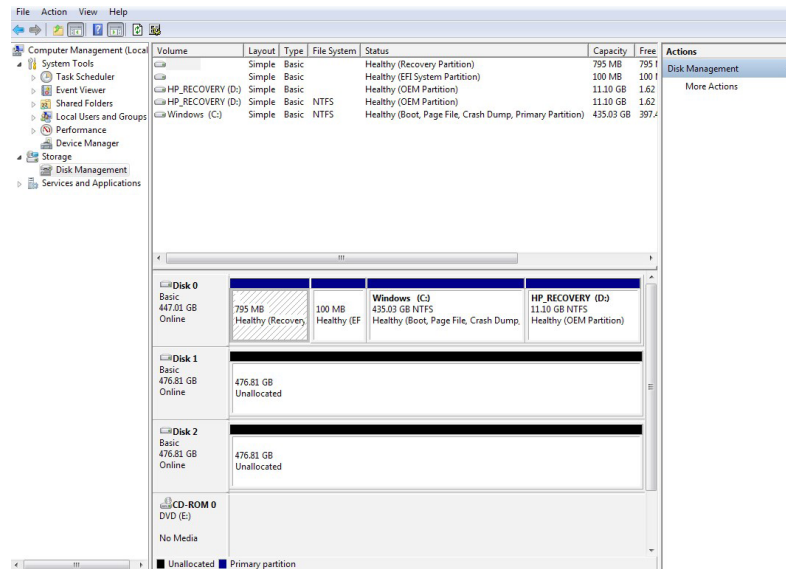

Mouse over one of the unallocated HP Z Turbo Drives and right-click. A menu will appear to configure a software RAID. The software RAID modes are defined as follows:

- **Simple volume:** No RAID, single drive.
- **Spanned volume:** A single partition system that includes multiple drives. Files are not deliberately broken up among the drives. A spanned volume does not include any performance or redundancy advantages.
- **Striped volume (RAID 0):** Data and files are deliberately broken up across multiple disks in an attempt to improve read and write performance. The resulting RAID volume size is the sum of the individual drives included in the configuration.
- **Mirrored volume (RAID 1):** Data is replicated between drives, providing data redundancy but no performance advantage. The RAID volume size equals the size of the smallest drive in the array.
- **RAID 5 volume:** A RAID 5 does not replicate data between multiple drives and is more efficient at storing the redundancy information necessary to restore the RAID when a drive fails. Instead of replicating all data to a second drive, it creates a smaller parity partition to allow data recovery. RAID 5 is not available on Windows 7 or Windows 10.

Figure 6. Disk Management screen and menu choices

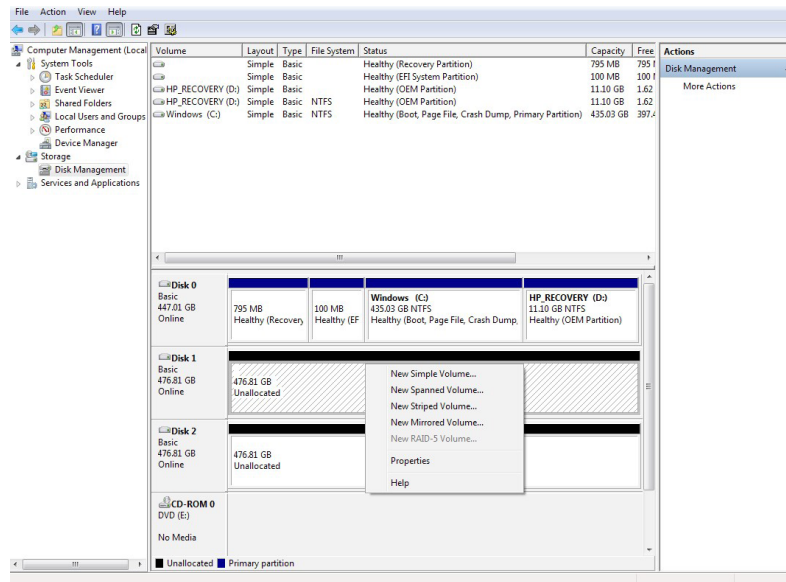

For this document, RAID 0 is selected using HP Z Turbo Drive G2s. Microsoft Windows provides a wizard to help complete the process.

Figure 7. Microsoft Windows RAID Configuration Wizard

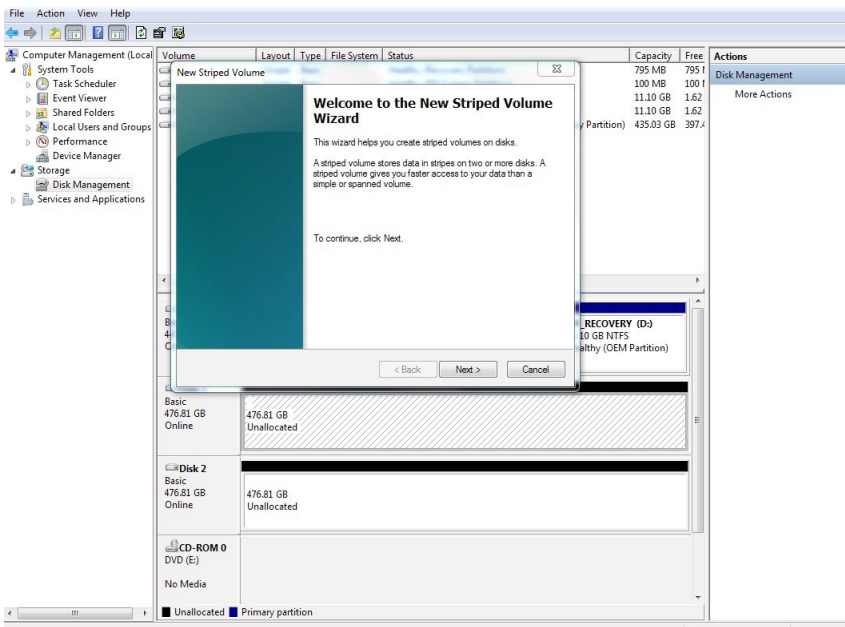

Click **Next**.

Choose the other drives to be included in the RAID array. For each drive to be added to the array:

- Select the drive.
- Click **Add**.

Figure 8. Drive selection

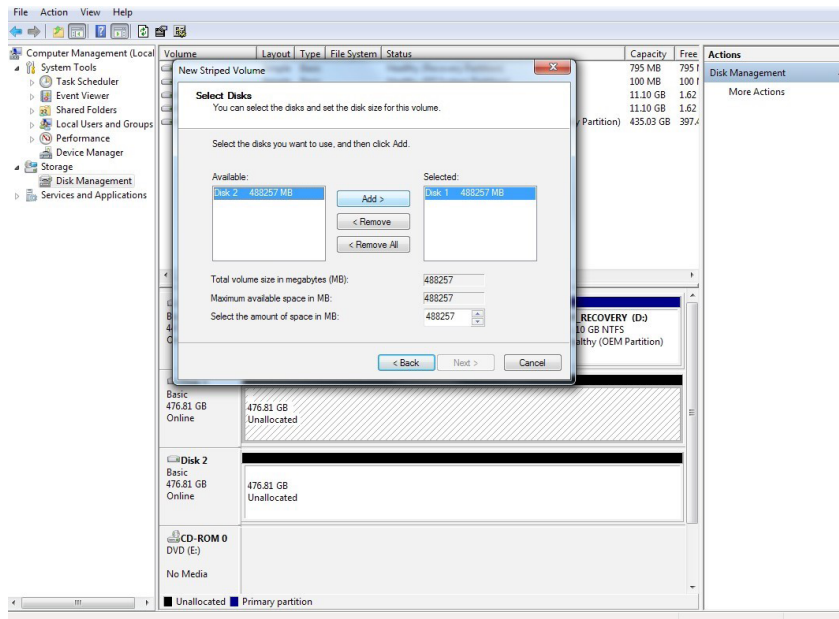

Once all drives have been added, click **Next**.

Figure 9. Drive selection

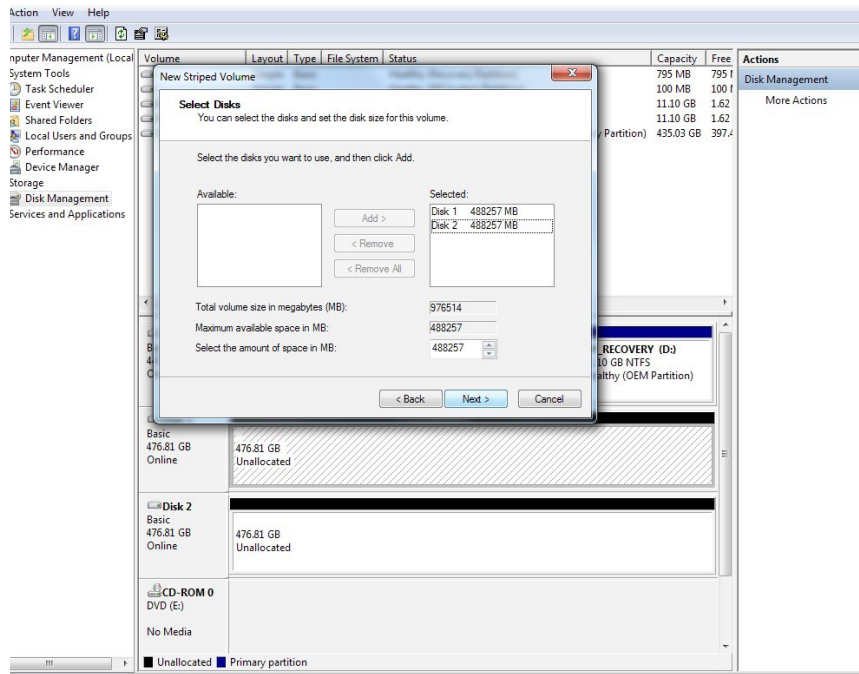

Assign a drive letter for the resulting RAID volume. Notice that the RAID can be assigned to an empty NTFS folder. Choose the appropriate option, then click **Next**.

Figure 10. Assigning a drive letter

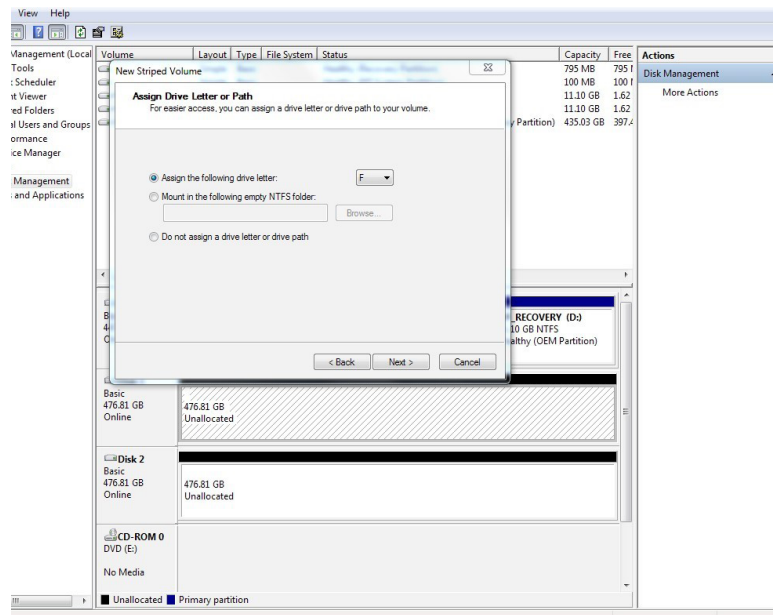

The OS will now format the RAID volume. Select either the default stripe size, or choose an alternative size. Click **Next** to continue.

Figure 11. Stripe size

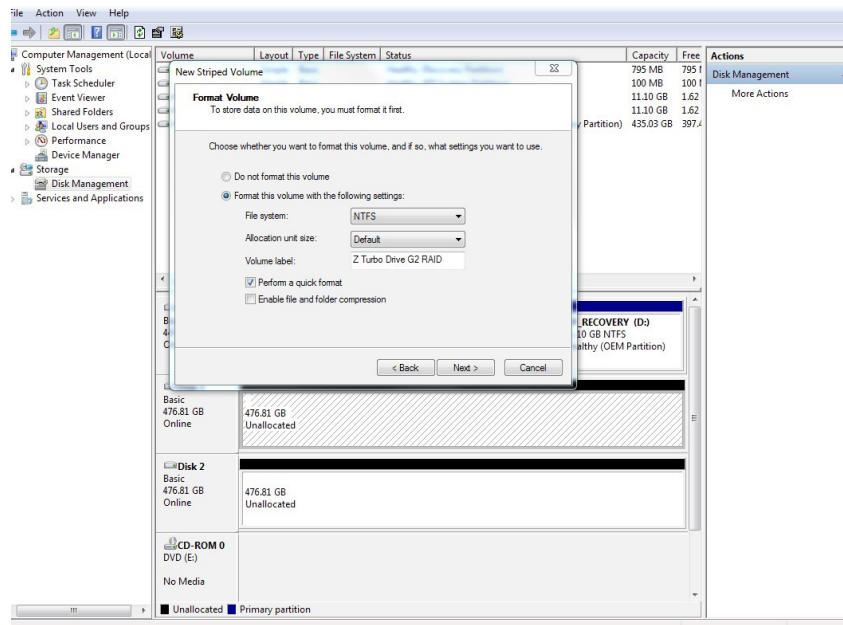

When the RAID configuration has completed, click **Finish**.

Figure 12. RAID configuration completion message

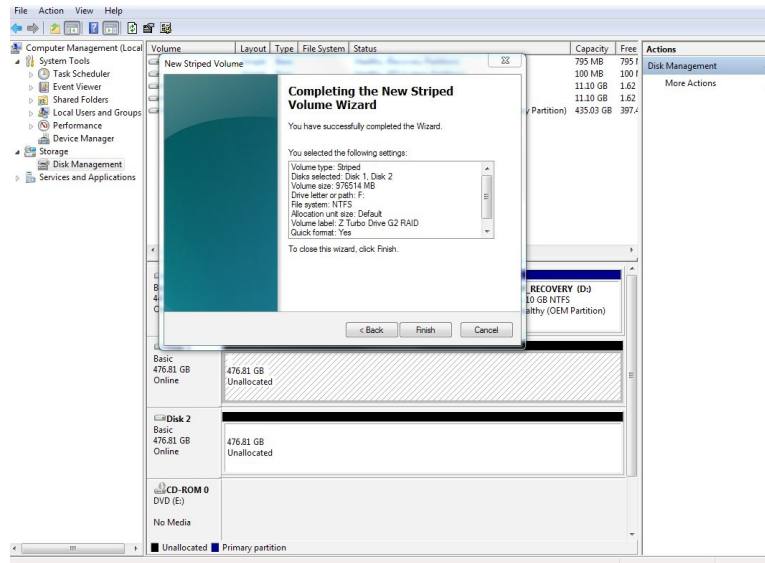

Click **Yes** to continue with the RAID configuration, or **No** to abort.

Figure 13. RAID configuration confirmation

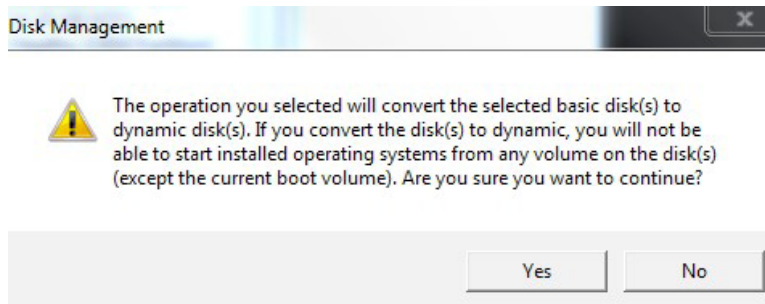

When completed, Disk Management will show all the disks configured using RAID, based on the name of the volume and the assigned drive letter. Note that in Disk Management, the volumes shown in the top pane relates to the overall size of the RAID while the disks listed at the bottom display the size of the individual drives.

Figure 14. Disk Management with HP Z Turbo Drives in a RAID 0 configuration

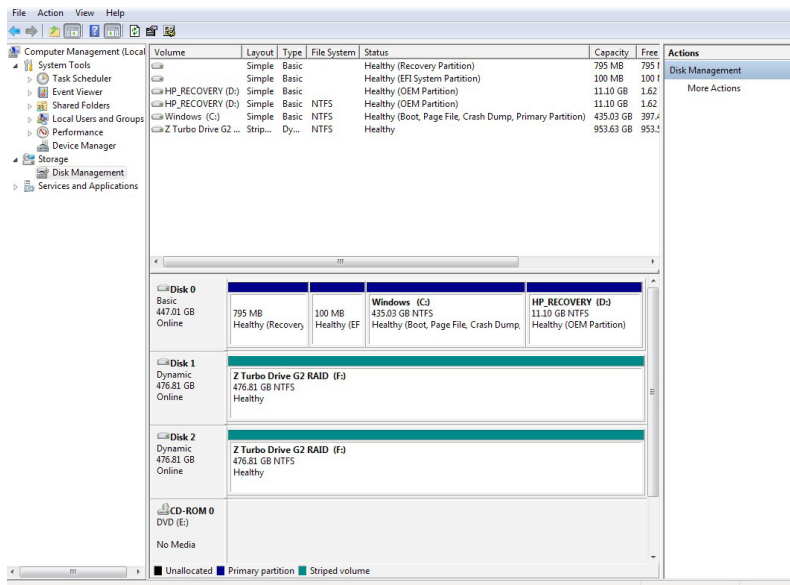

**Note:** On completion the OS will see a new drive and may generate an AutoPlay dialog. Either select **Open folder to view files** or close the dialog box.

Figure 15. AutoPlay dialog box

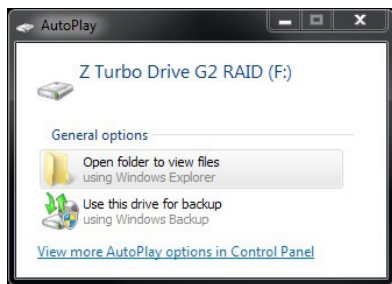

## Performance considerations

### Power settings

The default “Balanced” and “Power Saver” plans in Windows Power Options may result in power management settings that may adversely affect performance of your applications. If the workstation is being used for a high demand application, consider choosing the “High performance” power plan or choose custom settings that better fit your use model.

### SSDs used in RAID configurations and TRIM support

TRIM keeps track of files that have been deleted but not erased on the drive to improve performance and help extend the life of the SSD. As the SSD is used, the controller within the SSD distributes data across the available FLASH on the SSD until all FLASH is used. After the FLASH has been used up, a block erase is required before subsequent writes can occur. The TRIM command normally frees up memory prior to being needed for the next write. If the TRIM commands are not sent to the drive and no unerased FLASH is available for writing, the SSD controller must erase a block of memory prior to writing. This can slow performance in applications that perform a lot of file write and file delete operations. One example is in compiling code where the compiler generates many intermediate files that then get deleted.

The table below shows which RAID arrays support TRIM:

Controller	TRIM supported	TRIM not supported
sSATA	0, 1, 10	5
NVMe	0, 1, 10	

### Storage caching options

HP Workstations ship with default storage cache settings that balance performance with data protection. The balance of performance and protection can be adjusted by changing one or more of these settings.

*Create a backup of your data before attempting to change any storage related settings.*

#### Windows Write-caching policy (Disk Properties in Disk Manager)

Write caching on the device:

DEFAULT: Enabled

Improves performance by enabling write caching on the disk; however, a loss of power may result in loss of data that has not been committed to the storage media.

Windows write-cache buffer flushing:

DEFAULT: Enabled

When enabled, Windows will periodically instruct the storage device to commit data in the devices cache to the non-volatile storage media. These periodic commands result in decreased overall system performance.

---

**Note:** If Windows write-cache buffer flushing is enabled, Intel® RSTe write-back cache is disabled. To enable write-back cache on volumes, you must disable Windows write-cache buffer flushing.

---

A user can choose to disable Windows write-cache buffer flushing to restore system performance, allowing the Intel® RSTe driver to handle all write-cache buffer flushing.

#### Intel® RSTe write-back cache [for RAID volumes] (Intel® RSTe GUI, Volume Properties)

DEFAULT: Disabled

When enabled the read and write performance of a RAID or recovery volume is improved. In write-back cache mode, the RAID controller acknowledges write I/O requests immediately after the data loads into the controller cache. The application can continue working without waiting for the data to be physically written to the hard drives.

Enabling Intel® RSTe write-back cache will enable Write caching on the device if not already enabled and will disable Windows write-cache buffer flushing.

# Memory configurations and optimization

The purpose of this section is to provide an overview of the memory configurations for the HP Z6 G4 Workstation and to provide recommendations to optimize performance.

## Supported memory modules

**Types of memory supported on an HP Z6 G4 Workstation are:**

- 8 GB, 16 GB, and 32 GB PC4-2666-R 2666 MHz DDR4 Registered DIMMs<sup>4</sup>
- Single and dual rank 4 Gb and 8 Gb based DIMMs are supported

**Types of memory NOT supported on an HP Z6 G4 Workstation are:**

- Unbuffered DIMMs
- LR DIMMs
- Non-ECC DIMMs
- DDR, DDR2, or DDR3 DIMMs

See [Memory Technology White Paper](#) for more memory module technical information.

## Platform capabilities

**Maximum capacity**

- Single processor: 192 GB
- Dual processors: 384 GB

**Total of 12 memory sockets**

- 6 memory sockets available per CPU
- 6 channels per processor and 1 sockets per channel

**Speed**

- 2666 MHz, 2400 MHz, and 2133 MHz memory speeds are supported in this platform
- Memory will operate at the speed of the slowest rated installed processor or DIMM

**Dynamic power saving is enabled.**

**NUMA, Sub-NUMA and Non-NUMA modes are supported and user configurable.**

## Memory features

### ECC is supported on all of our supported DIMMs

- Single-bit errors are automatically corrected.
- Multi-bit errors are detected and will cause the system to immediately reboot and halt with an F1 prompt error message.
- By way of comparison, non-ECC memory (not supported on this platform) does not detect or correct single-bit or multi-bit errors which can cause instability, or corruption of data, in the platform. See Memory Technology White Paper for more information.

### Command and Address parity is supported

- Command and Address errors are detected and will cause the system to immediately reboot and halt with an F1 prompt error message.

## Optimize performance

System performance is largely based on the applications being used. Generally, to obtain the best performance, it is advised that you follow the following guidelines:

- For best performance, it is recommended to load memory into all channels. Since these platforms have 6 channels per CPU, install memory in sets of 6 for single CPU configurations or 12 for dual CPU configurations.
- Proper individual DIMM capacity selection is essential to maximizing performance. Evenly distributing total desired memory across all operational channels and CPUs will deliver the best performance.
- It is not recommended to only use three DIMMs, but to get better performance out of a three DIMM configuration, it is recommended that you install all three DIMMs on one side of the CPU.

## Loading rules

- Load the memory modules in order of size, starting with the largest module and finishing with the smallest module.
- Load the first and second DIMMs in the sockets furthest from the CPU. The third and fourth DIMMs should be loaded in the slots closest to the CPU. The fifth and sixth DIMMs should be installed in the middle slots.
  - For 3 DIMM per CPU configurations: load DIMMs in CPUx-DIMM1, CPUx-DIMM2 and CPUx-DIMM3.
- For a dual processor configuration, follow the loading order above, but alternate between the 2 processors.
- See figures below for loading order.

Figure 16. Loading order for single and dual CPU configurations

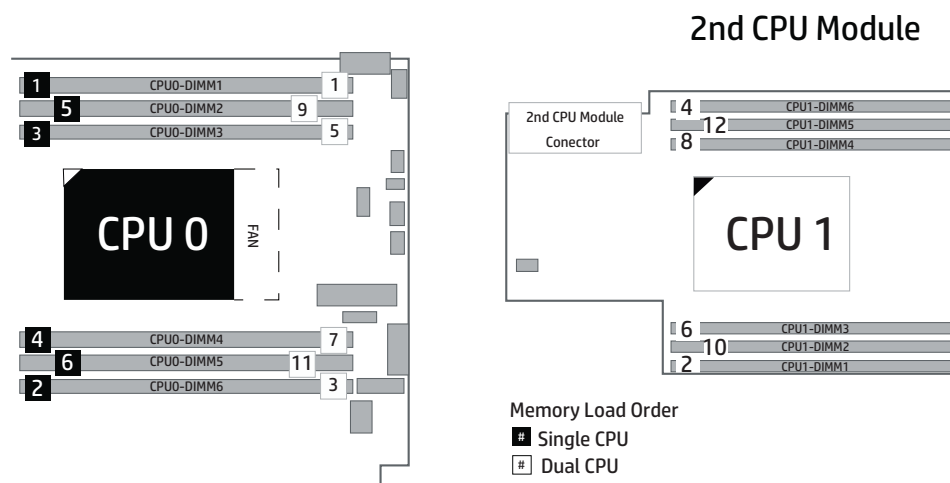

## Memory Cooling

- For single CPU configurations, an optional memory cooling duct is required for any memory configuration above 32 GB total capacity in order to cool appropriately.
  - Examples of this are:
    - 64 GB total installed having four 16 GB 2666 MHz DDR4 Registered DIMMs.
    - 128 GB total installed having four 32 GB 2666 MHz DDR4 Registered DIMMs.
- All dual CPU configurations require this memory cooling duct.
- All single CPU configurations with 32 GB or less installed total memory capacity will be cooled appropriately without the optional memory cooling duct installed.
  - Examples of this are:
    - 16 GB total having two 8GB DDR4 2666 MHz DDR4 Registered DIMMs.
    - 32 GB total installed having two 16 GB 2666 MHz DDR4 Registered DIMMs.

## Resources, contacts, or additional links

[hp.com/go/whitepapers](http://hp.com/go/whitepapers)

This site includes white papers on USB 3.0 Technology, Battery Charging technology, Thunderbolt™ 2 Technology, etc.

[hp.com/support/Z6\\_G4\\_manuals](http://hp.com/support/Z6_G4_manuals)

Learn more at

[hp.com/go/workstations](http://hp.com/go/workstations)

\* Not all features are available in all editions or versions of Windows. Systems may require upgraded and/or separately purchased hardware, drivers, software or BIOS update to take full advantage of Windows functionality. Windows 10 is automatically updated, which is always enabled. ISP fees may apply and additional requirements may apply over time for updates. See <http://www.windows.com>

<sup>1</sup> In accordance with Microsoft's support policy, HP does not support the Windows 8 or Windows 7 operating system on products configured with Intel® and AMD 7th generation and forward processors or provide any Windows 8 or Windows 7 drivers on <http://www.support.hp.com>

<sup>2</sup> Intel® Turbo Boost technology requires a PC with a processor with Intel® Turbo Boost capability. Intel® Turbo Boost performance varies depending on hardware, software, and overall system configuration. See [intel.com/technology/turboboost](http://intel.com/technology/turboboost) for more information.

<sup>3</sup> Each processor supports up to 4 channels of DDR4 memory. To realize full performance at least 1 DIMM must be inserted into each channel. To get full 8 channel support, 2 processors MUST be installed. Actual memory speeds dependent on processor capability.

<sup>4</sup> For hard drives, GB = 1 billion bytes. TB = 1 trillion bytes. Actual formatted capacity is less. Up to 30 GB for Windows 10 of system disk is reserved for system recovery software.

<sup>5</sup> EPEAT® registered where applicable. EPEAT® registration varies by country. See [www.epeat.net](http://www.epeat.net) for registration status by country. Search keyword generator on HP's 3rd party option store for solar generator accessories at [www.hp.com/go/options](http://www.hp.com/go/options)

<sup>6</sup> External power supplies, power cords, cables and peripherals are not low halogen. Service parts obtained after purchase may not be low halogen.

<sup>7</sup> Optional or add-on feature.

<sup>8</sup> Multi-Core is designed to improve performance of certain software products. Not all customers or software applications will necessarily benefit from use of this technology. Performance and clock frequency will vary depending on application workload and your hardware and software configurations. Intel's numbering, branding, and/or naming is not a measurement of higher performance.

Sign up for updates  
[hp.com/go/getupdated](http://hp.com/go/getupdated)



Share with colleagues

© Copyright 2017 HP Development Company, L.P. The information contained herein is subject to change without notice. The only warranties for HP products and services are set forth in the express warranty statements accompanying such products and services. Nothing herein should be construed as constituting an additional warranty. HP shall not be liable for technical or editorial errors or omissions contained herein.

Microsoft and Windows are U.S. registered trademarks of the Microsoft group of companies. Intel, Core, Xeon, vPro, and Thunderbolt are trademarks of Intel Corporation in the U.S. and other countries. NVIDIA, Quadro, and Optimus are registered trademarks of NVIDIA Corporation. AMD, FirePro, and Enduro are trademarks of Advanced Micro Devices, Inc. Linux® is the registered trademark of Linus Torvalds in the U.S. and other countries. Bluetooth is a trademark of its proprietor and used by HP Company under license. DisplayPort™ and the DisplayPort™ logo are trademarks owned by the Video Electronics Standards Association (VESA®) in the U.S. and other countries.

