



HP Spectre x360 Convertible PC

Model numbers: 15-bl000 – 15-bl099, 15t-bl000

Maintenance and Service Guide

IMPORTANT! This document is intended for
HP authorized service providers only.

© Copyright 2016 HP Development Company, L.P.

Bluetooth is a trademark owned by its proprietor and used by HP Inc. under license. Intel and Core are trademarks of Intel Corporation in the U.S. and other countries. Windows is either a registered trademark or trademark of Microsoft Corporation in the United States and/or other countries. SD Logo is a trademark of its proprietor.

The information contained herein is subject to change without notice. The only warranties for HP products and services are set forth in the express warranty statements accompanying such products and services. Nothing herein should be construed as constituting an additional warranty. HP shall not be liable for technical or editorial errors or omissions contained herein.

First Edition: December 2016

Document Part Number: 912979-001

Product notice

This user guide describes features that are common to most models. Some features may not be available on your computer.

In accordance with Microsoft's support policy, HP does not support the Windows® 8 or Windows 7 operating system on products configured with Intel and AMD 7th generation and forward processors or provide any Windows 8 or Windows 7 drivers on <http://www.support.hp.com>.

Not all features are available in all editions of Windows. This computer may require upgraded and/or separately purchased hardware, drivers and/or software to take full advantage of Windows functionality. Go to <http://www.microsoft.com> for details.

Software terms

By installing, copying, downloading, or otherwise using any software product preinstalled on this computer, you agree to be bound by the terms of the HP End User License Agreement (EULA). If you do not accept these license terms, your sole remedy is to return the entire unused product (hardware and software) within 14 days for a full refund subject to the refund policy of your seller.

For any further information or to request a full refund of the price of the computer, please contact your seller.

Safety warning notice

 **WARNING!** To reduce the possibility of heat-related injuries or of overheating the device, do not place the device directly on your lap or obstruct the device air vents. Use the device only on a hard, flat surface. Do not allow another hard surface, such as an adjoining optional printer, or a soft surface, such as pillows or rugs or clothing, to block airflow. Also, do not allow the AC adapter to contact the skin or a soft surface, such as pillows or rugs or clothing, during operation. The device and the AC adapter comply with the user-accessible surface temperature limits defined by the International Standard for Safety of Information Technology Equipment (IEC 60950-1).

Table of contents

1 Product description	1
2 External component identification	4
Display	4
Top	5
TouchPad	5
Lights	6
Speakers	7
Keys	8
Using the action keys	9
Left side	10
Right side	12
Bottom	13
Labels	14
3 Illustrated parts catalog	15
Computer major components	15
Miscellaneous parts	17
4 Removal and replacement preliminary requirements	18
Tools required	18
Service considerations	18
Plastic parts	18
Cables and connectors	18
Grounding guidelines	19
Electrostatic discharge damage	19
5 Removal and replacement procedures	22
Bottom cover	23
Battery	24
Memory modules	26
WLAN module	28
Fans, left and right	30
Heat sink	32
Speakers	34
USB/audio/power connector board	37

Solid-state drive	40
RTC battery	41
TouchPad	42
Volume board	44
Card reader board	46
Display assembly	48
System board	50
Top cover/keyboard	53
6 Using Setup Utility (BIOS)	54
Starting Setup Utility (BIOS)	54
Updating Setup Utility (BIOS)	54
Determining the BIOS version	54
Downloading a BIOS update	55
7 Using HP PC Hardware Diagnostics (UEFI)	56
Downloading HP PC Hardware Diagnostics (UEFI) to a USB device	56
8 Backing up, restoring, and recovering	58
Creating recovery media and backups	58
Creating HP Recovery media (select products only)	58
Using Windows tools	59
Restore and recovery	60
Recovering using HP Recovery Manager	60
9 Specifications	64
10 Power cord set requirements	65
Requirements for all countries	65
Requirements for specific countries and regions	65
11 Recycling	67
Index	68

1 Product description

Category	Description
Product Name	HP Spectre x360 Convertible PC Model numbers: 15-bl000 – 15-bl099, 15t-bl000
Processor	7th generation Intel™ Core® processor <ul style="list-style-type: none">Intel Core i7-7500U 2.7-GHz, max turbo 3.5-GHz, 4 GB Intel Smart Cache, 15 W
Chipset	Intel SOC (System on Chip)
Graphics	Internal Graphics Intel HD Graphics 620 NVIDIA N16S-GTR-S (GeForce 940MX) with 2048 MB of dedicated video memory
Panel	Touch screen; multi touch enabled; 16:9 ultra-wide aspect ratio; typical brightness: 340 nits <ul style="list-style-type: none">39.6 cm (15.6-in), UWVA (3840×2160), BrightView, ultra high-definition (UHD), white-light emitting (WLED), eDP, 2.6-mm Supports active stylus Windows Ink certification
Memory	Two SODIMM slots - not customer accessible/upgradeable Support for DDR4-2133 dual channel (DDR4-2400 bridge to DDR4-2133) Supports up to 16 GB maximum system memory in the following configurations <ul style="list-style-type: none">16 GB (8 GB × 2)12 GB (8 GB + 4 GB)8 GB (4 GB × 2)
Primary storage	PCIe, NVMe, TLC, M.2 SSD configuration as storage Support for single M.2 solid-state drive configuration as storage in the following configurations: <ul style="list-style-type: none">1 TB512 GB360 GB256 GB
Audio and video	BANG & OLUFSEN Dual speakers Supports HP Audio Boost Cortana Certification
Webcam and microphone	HP TrueVision Full HD IR camera with activity light, (2) IR lights, USB 2.0, FHD, BSI sensor 1080p by 30 frames per second Supports Windows Help

Category	Description
	<p>Supports Voice Recognition</p> <p>Dual array digital microphones with appropriate beam-forming, echo-cancellation, noise-suppression software</p> <p>HP Noise Cancellation enabled</p>
Sensors	<p>Accelerometer</p> <p>Gyroscope</p> <p>Digital Compass</p>
Wireless	<p>Integrated Wireless options with dual antennas (M.2):</p> <p>Two built-in WLAN antennas (in display assembly)</p> <p>Support for Miracast-certified devices (Windows 10 only)</p> <p>Support for Intel WiDi (Intel 8265NV)</p> <p>WiFi SAR enabled in BIOS (Intel WLAN only)</p> <p>Support for the following WLAN module:</p> <ul style="list-style-type: none"> • Intel Dual Band Wireless-AC 8265 802.11 ac 2x2 WiFi + Bluetooth 4.2 Combo Adapter
External media cards	<p>HP Multi-Format Digital Media Card Reader</p> <p>Supports SD/SDHC/SDXC</p> <p>Push-push insertion/removal</p>
Internal card expansion	<p>One M.2 Slot for WLAN</p> <p>One M.2 Slot for SSD</p>
Ports	<p>USB 3.0 Type-A port</p> <p>USB 3.1 Gen 1 port</p> <p>USB 3.0 Type-C ports</p> <p>USB 3.1 Gen 2 port with Thunderbolt™ Gen 3 technology</p> <p>USB 3.1 Gen 1 port</p> <p>All ports support data transfer, power delivery, and:</p> <p>DisplayPort 1.2 supporting up to 3840x2160 @ 60 Hz</p> <p>HDMI v2.0 output support up to 3840x2160 at 60 Hz with HDCP 2.2</p> <p>Headphone output and microphone input combo jack (stereo)</p> <p>AC adapter through Type-C port</p> <p>All ports support HP USB Boost</p>
Keyboard/pointing devices	<p>Full-size, backlight, island-style keyboard</p> <p>Dark ash silver</p> <p>Touchpad requirements</p> <ul style="list-style-type: none"> • Multi-touch gestures enabled • Taps enabled as default • Support for Windows modern TouchPad gestures • ClickPad with image sensor

Category	Description
Power requirements	<p>AC adapter</p> <p>USB Type-C, 90-W with power cords</p> <p>Power cord</p> <p>1 meter power cord with tag label</p> <p>Battery</p> <p>6-cell, 79.2-WHr, 3.43-AH, Li-ion battery</p>
Security	Trusted Platform Module (TPM) 2.0 support
Operating system	<p>Preinstalled</p> <p>Windows 10</p> <p>Windows 10 Pro</p> <p>For Developed Markets (ML):</p> <p>Windows 10 Home High End ML</p> <p>For Emerging Markets (EM):</p> <p>Windows 10 Home High End EM/SL</p> <p>SEAP Windows 10 Home High End</p>
Serviceability	<p>End user replaceable part</p> <p>AC adapter</p>

2 External component identification

Display

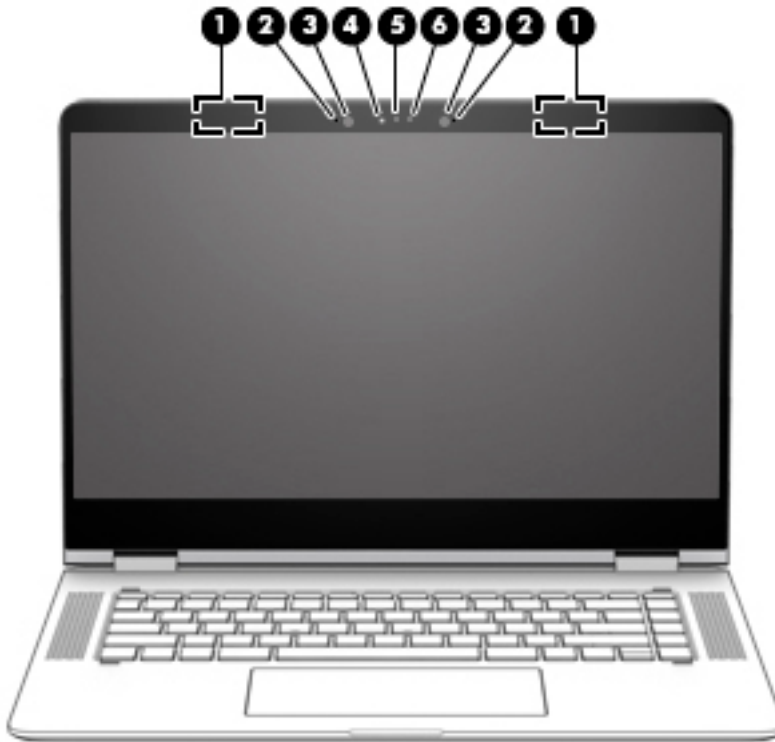

Component	Description
(1) WLAN antennas* (2)	Send and receive wireless signals to communicate with wireless local area networks (WLANs).
(2) Internal microphones (2)	Record sound.
(3) Infrared camera lights (2)	On: The infrared camera is in use.
(4) Camera light	On: The camera is in use.
(5) Camera	Allows you to video chat, record video, and record still images.
(6) Infrared camera	Allows a facial recognition logon to Windows, instead of a password logon.

*The antennas are not visible from the outside of the computer, and antenna location varies. For optimal transmission, keep the areas immediately around the antennas free from obstructions.

For wireless regulatory notices, see the section of the *Regulatory, Safety, and Environmental Notices* that applies to your country or region.

To access this guide:

- ▲ Select the **Start** button, select **All apps** (required on some products), select **HP Help and Support**, and then select **HP Documentation**.

Top

TouchPad

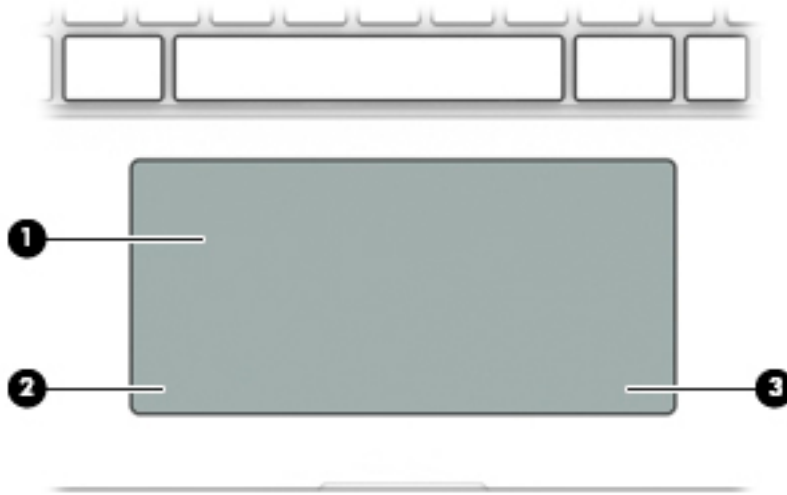

Component		Description
(1)	TouchPad zone	Reads your finger gestures to move the pointer or activate items on the screen.
(2)	Left TouchPad button	Functions like the left button on an external mouse.
(3)	Right TouchPad button	Functions like the right button on an external mouse.

Lights

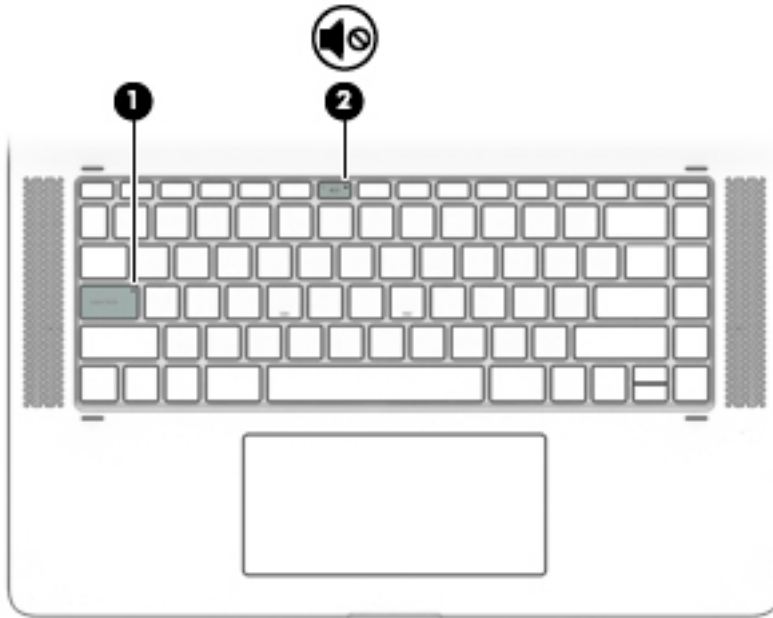

Component		Description
(1)	Caps lock light	On: Caps lock is on, which switches the key input to all capital letters.
(2)	 Mute light	<ul style="list-style-type: none">• Amber: Computer sound is off.• Off: Computer sound is on.

Speakers

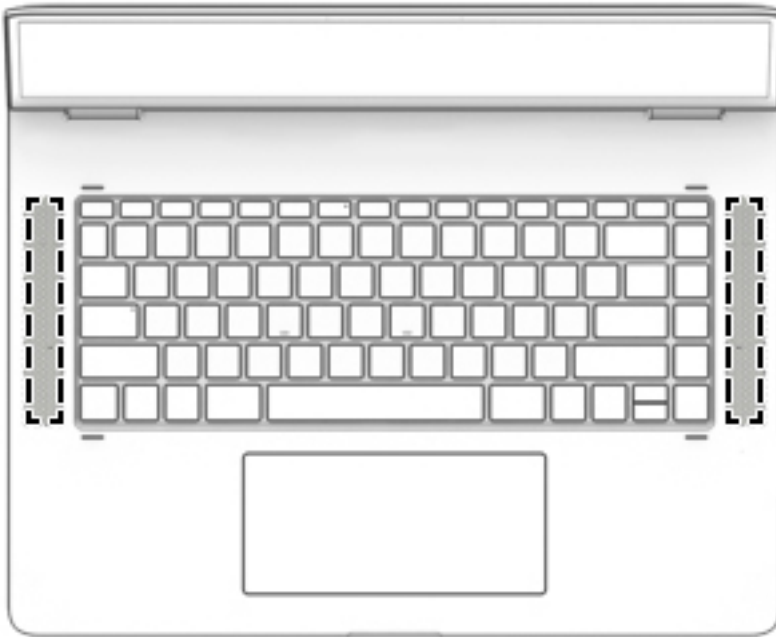

Component	Description
Speakers (2)	Produce sound.



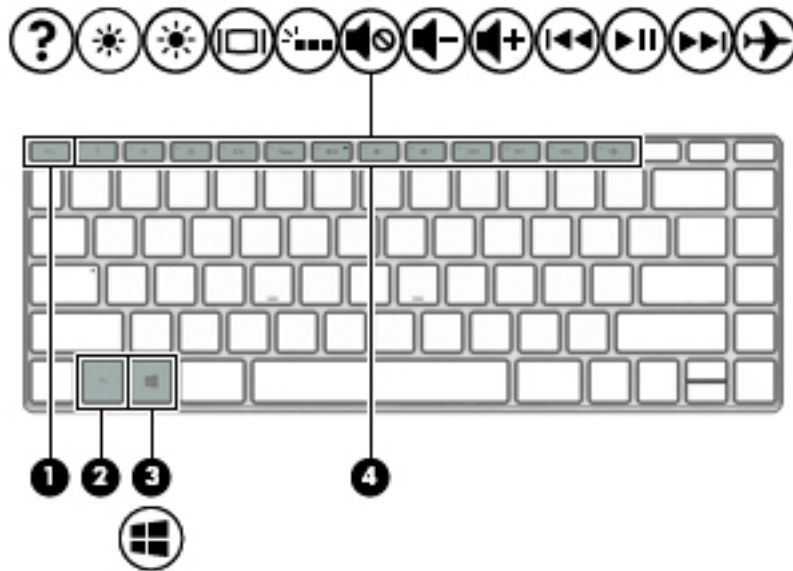









Keys



Component	Description
(1) esc key	Displays system information when pressed in combination with the fn key.
(2) fn key	Executes specific functions when pressed in combination with the esc key or the spacebar .
(3)  Windows key	Opens the Start menu. NOTE: Pressing the Windows key again will close the Start menu.
(4) Action keys	Execute frequently used system functions. NOTE: On select products, the f5 action key turns the keyboard backlight feature off or on.



Using the action keys

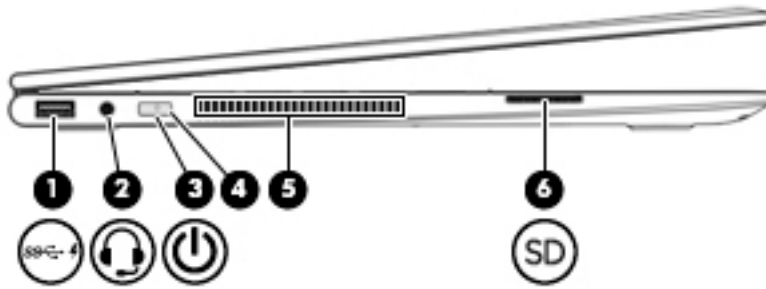

- An action key performs an assigned function.
- The icon on each action key illustrates the function for that key.

Icon	Description
	Opens the Get started app.
	Decreases the screen brightness incrementally as long as you hold down the key.
	Increases the screen brightness incrementally as long as you hold down the key.
	Switches the screen image between display devices connected to the system. For example, if a monitor is connected to the computer, repeatedly pressing this key alternates the screen image from the computer display to the monitor display to a simultaneous display on both the computer and the monitor.
	Turns the keyboard backlight off or on. NOTE: To conserve battery power, turn off this feature.
	Mutes or restores speaker sound.
	Decreases speaker volume incrementally while you hold down the key.
	Increases speaker volume incrementally while you hold down the key.
	Plays the previous track of an audio CD or the previous section of a DVD or a Blu-ray Disc (BD).
	Starts, pauses, or resumes playback of an audio CD, a DVD, or a BD.
	Plays the next track of an audio CD or the next section of a DVD or a BD.
	Turns the airplane mode and wireless feature on or off. NOTE: The airplane mode key is also referred to as the wireless button. NOTE: A wireless network must be set up before a wireless connection is possible.

Left side





Component	Description
(1)  USB 3.x port with HP Sleep and Charge	Connects a USB device, provides high-speed data transfer, and even when the computer is off, charges products such as a cell phone, camera, activity tracker, or smartwatch.
(2)  Audio-out (headphone)/Audio-in (microphone) combo jack	Connects optional powered stereo speakers, headphones, earbuds, a headset, or a television audio cable. Also connects an optional headset microphone. This jack does not support optional standalone microphones. <p>WARNING! To reduce the risk of personal injury, adjust the volume before putting on headphones, earbuds, or a headset. For additional safety information, refer to the <i>Regulatory, Safety, and Environmental Notices</i>.</p> <p>To access this guide:</p> <ul style="list-style-type: none"> ▲ Select the Start button, select All apps (required on some products), select HP Help and Support, and then select HP Documentation. <p>NOTE: When a device is connected to the jack, the computer speakers are disabled.</p>
(3)  Power button	<ul style="list-style-type: none"> • When the computer is off, press the button to turn on the computer. • When the computer is on, press the button briefly to initiate Sleep. • When the computer is in the Sleep state, press the button briefly to exit Sleep. • When the computer is in Hibernation, press the button briefly to exit Hibernation. <p>CAUTION: Pressing and holding down the power button results in the loss of unsaved information.</p> <p>If the computer has stopped responding and shutdown procedures are ineffective, press and hold the power button down for at least 5 seconds to turn off the computer.</p> <p>To learn more about your power settings, see your power options.</p> <ul style="list-style-type: none"> ▲ Type <code>power</code> in the taskbar search box, and then select Power & sleep settings. – or – Right-click the Start button, and then select Power Options.

Component		Description
(4)	 Power light	<ul style="list-style-type: none"> • On: The computer is on. • Blinking: The computer is in the Sleep state, a power-saving state. The computer shuts off power to the display and other unneeded components. • Off: The computer is off or in Hibernation. Hibernation is a power-saving state that uses the least amount of power.
(5)	Vent	<p>Enables airflow to cool internal components.</p> <p>NOTE: The computer fan starts up automatically to cool internal components and prevent overheating. It is normal for the internal fan to cycle on and off during routine operation.</p>
(6)	 Memory card reader	<p>Reads optional memory cards that enable you to store, manage, share, or access information.</p> <p>To insert a card:</p> <ol style="list-style-type: none"> 1. Hold the card label-side up, with connectors facing the computer. 2. Insert the card into the memory card reader, and then press in on the card until it is firmly seated. <p>To remove a card:</p> <ul style="list-style-type: none"> ▲ Press in on the card, and then remove it from the memory card reader.

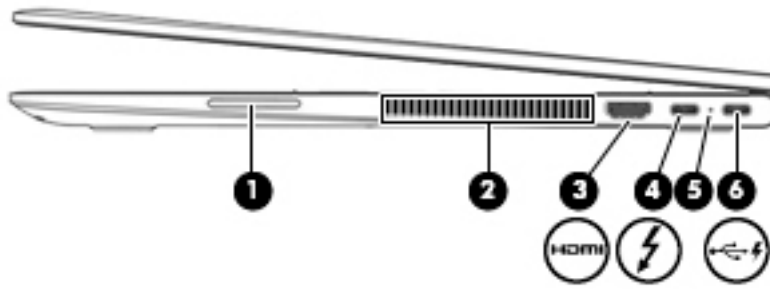
Right side



Component	Description
(1) Volume button	Controls speaker volume on the computer.
(2) Vent	Enables airflow to cool internal components. NOTE: The computer fan starts up automatically to cool internal components and prevent overheating. It is normal for the internal fan to cycle on and off during routine operation.
(3)  HDMI port	Connects an optional video or audio device, such as a high-definition television, any compatible digital or audio component, or a high-speed High-Definition Multimedia Interface (HDMI) device.
(4)  USB Type-C power connector port with HP Sleep and Charge and Thunderbolt port	Connects an AC adapter that has a USB Type-C connector, supplying power to the computer and, if needed, charging the computer battery. – or – Connects a USB device that has a Type-C connector, and even when the computer is off, charges products such as a cell phone, camera, activity tracker, or smartwatch, and provides high-speed data transfer. – or – Connects a display device that has a USB Type-C connector, providing display output. NOTE: Your computer may also support a Thunderbolt docking station.
(5) AC adapter and battery light	<ul style="list-style-type: none"> White: The AC adapter is connected and the battery is fully charged. Blinking white: The AC adapter is disconnected and the battery has reached a low battery level. Amber: The AC adapter is connected and the battery is charging. Off: The battery is not charging.
(6)  USB Type-C power connector port with HP Sleep and Charge	Connects an AC adapter that has a USB Type-C connector, supplying power to the computer and, if needed, charging the computer battery. – or – Connects a USB device that has a Type-C connector, and even when the computer is off, charges products such as a cell phone, camera, activity tracker, or smartwatch, and provides high-speed data transfer.

Bottom

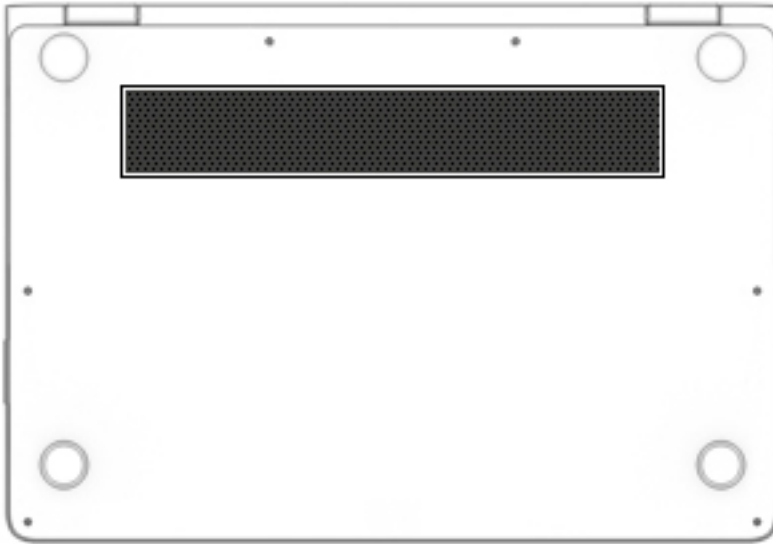

Component	Description
Vent	Enables airflow to cool internal components. NOTE: The computer fan starts up automatically to cool internal components and prevent overheating. It is normal for the internal fan to cycle on and off during routine operation.

Labels

The labels affixed to the computer provide information you may need when you troubleshoot system problems or travel internationally with the computer.

IMPORTANT: Check the following locations for the labels described in this section: the bottom of the computer, inside the battery bay, under the service door, or on the back of the display.

- Service label—Provides important information to identify your computer. When contacting support, you will probably be asked for the serial number, and possibly for the product number or the model number. Locate these numbers before you contact support.

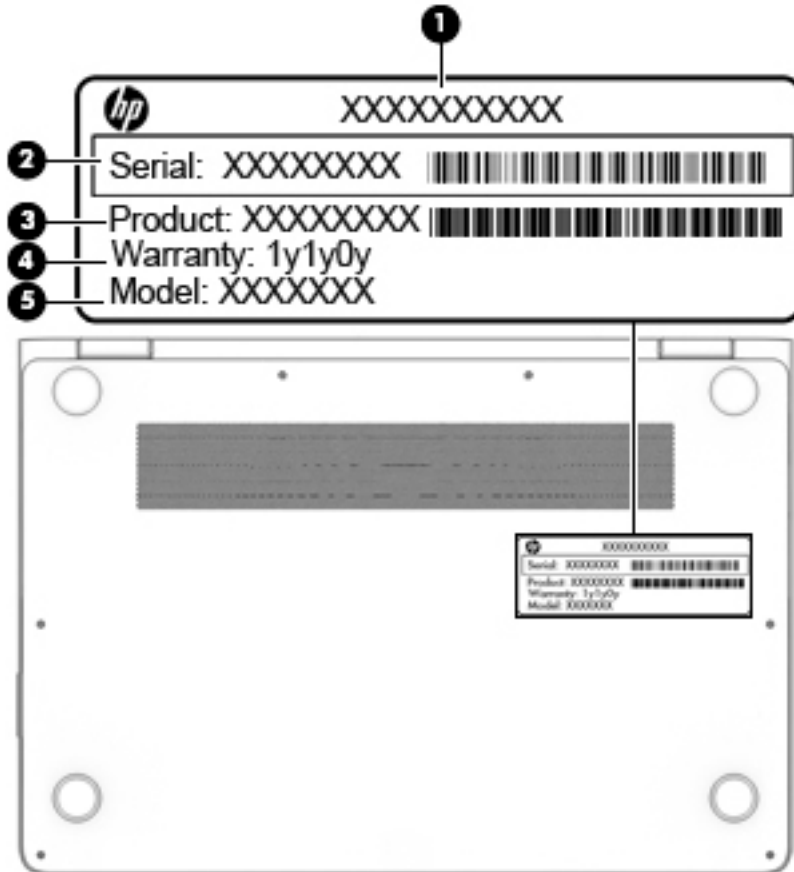

Component

- | | |
|-----|-----------------|
| (1) | HP product name |
| (2) | Serial number |
| (3) | Product number |
| (4) | Warranty period |
| (5) | Model name |

- Regulatory label(s)—Provide(s) regulatory information about the computer.
- Wireless certification label(s)—Provide(s) information about optional wireless devices and the approval markings for the countries or regions in which the devices have been approved for use.

3 Illustrated parts catalog

 **NOTE:** HP continually improves and changes product parts. For complete and current information on supported parts for the computer, go to <http://partsurfer.hp.com>, select the country or region, and then follow the on-screen instructions.

Computer major components

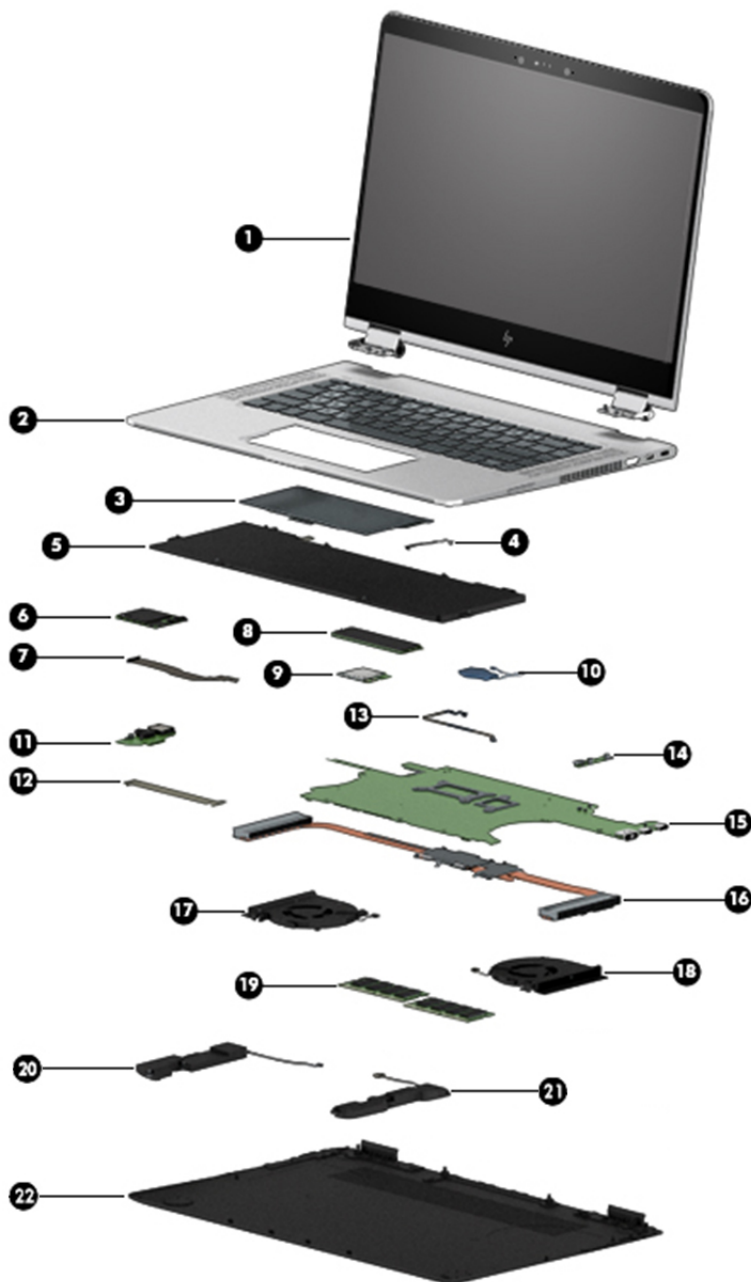

Item	Component	Spare part number
(1)	Display assembly (full hinge-up)	911082-001
(2)	Top cover and keyboard (includes TouchPad, keyboard cable, keyboard backlight cable; top cover/keyboard spare part kits include replacement rubber feet)	
	For use in Canada	912995-DB1
	For use in Denmark, Finland, and Norway	912995-DH1
	For use in France	912995-051
	For use in Germany	912995-041
	For use in the Netherlands	912995-B31
	For use in Russia	912995-251
	For use in Saudi Arabia	912995-171
	For use in Switzerland	912995-BG1
	For use in the United Kingdom and Singapore	912995-031
	For use in the United States	912995-001
(3)	TouchPad (TouchPad spare part kits include replacement rubber feet)	913004-001
(4)	TouchPad cable (TouchPad cable spare part kits include replacement rubber feet)	912992-001
(5)	Battery , 6-cell, 79-WHr, 3.43-AHr, Li-ion (battery spare part kits include rubber feet)	902499-856
(6)	Card reader board (card reader board spare part kits include replacement rubber feet)	913005-001
(7)	Card reader board cable (card reader board cable spare part kits include replacement rubber feet)	912991-001
(8)	Solid-state drive (solid-state drive spare part kits include replacement rubber feet)	
	1-TB, PCIe solid-state drive	913015-001
	512-GB, PCIe solid-state drive	913014-001
	360-GB, PCIe solid-state drive	920299-001
	256-GB, PCIe solid-state drive	913013-001
(9)	Intel Dual Band Wireless-AC 8265 802.11 ac 2x2 WiFi + Bluetooth 4.2 Combo Adapter (WLAN module spare part kits include replacement rubber feet)	910264-856
(10)	RTC battery (RTC battery spare part kits include replacement rubber feet)	913007-001
(11)	USB/audio/power connector board (spare part kits include replacement rubber feet)	913006-001
(12)	USB/audio/power connector board cable (spare part kits include replacement rubber feet)	912993-001
(13)	Volume board cable (volume board cable spare part kits include replacement rubber feet)	913634-001
(14)	Volume board (volume board spare part kits include replacement rubber feet)	913633-001
(15)	System board (includes processor and replacement thermal material; system board spare part kits include replacement rubber feet)	
	Intel Core i7-7500U processor, 2-GB of discrete graphics memory, and the Windows 10 operating system	911083-601
	Intel Core i7-7500U processor, 2-GB of discrete graphics memory, and a non-Windows operating system	911083-001

Item	Component	Spare part number
(16)	Heat sink (includes replacement thermal material; heat sink spare part kits include replacement rubber feet)	911081-001
(17)	Fan, left (fan spare part kits include replacement rubber feet)	912994-001
(18)	Fan, right (fan spare part kits include replacement rubber feet)	919437-001
(19)	Memory modules (DDR4-2400; memory spare part kits include replacement rubber feet)	
	8 GB	862398-857
	4 GB	862397-857
(20)	Left Speaker Kit (speaker spare part kits include replacement rubber feet)	913009-001
(21)	Right Speaker Kit (speaker spare part kits include replacement rubber feet)	913008-001
(22)	Bottom cover (includes rubber feet)	912990-001

Miscellaneous parts

Component	Spare part number
AC adapter , 90-W, 3-pin, PFC, USB-C	904144-850
USB-C to RJ-45 adapter	855560-001
USB-C to VGA adapter	831751-001
USB-C to USB-A adapter	833960-001
Power cord (C5, 3-pin, 1.0-m)	
For use in Denmark	213353-011
For use in Europe (Austria, Belgium, Finland, France, Germany, the Netherlands, Norway and Sweden)	213349-012
For use in North America	213349-013
For use in Switzerland	213354-011
For use in the United Kingdom and Singapore	213351-011
Screw Kit	910949-001
Rubber feet	910948-001
Active pen	920241-001
Notebook sleeve case	910942-001

4 Removal and replacement preliminary requirements

Tools required

You will need the following tools to complete the removal and replacement procedures:

- Flat-bladed screw driver
- Magnetic screw driver
- Phillips P0 screw driver

Service considerations

The following sections include some of the considerations that you must keep in mind during disassembly and assembly procedures.

 **NOTE:** As you remove each subassembly from the tablet, place the subassembly (and all accompanying screws) away from the work area to prevent damage.

Plastic parts

 **CAUTION:** Using excessive force during disassembly and reassembly can damage plastic parts. Use care when handling the plastic parts. Apply pressure only at the points designated in the maintenance instructions.

Cables and connectors

 **CAUTION:** When servicing the tablet, be sure that cables are placed in their proper locations during the reassembly process. Improper cable placement can damage the tablet.

Cables must be handled with extreme care to avoid damage. Apply only the tension required to unseat or seat the cables during removal and insertion. Handle cables by the connector whenever possible. In all cases, avoid bending, twisting, or tearing cables. Be sure that cables are routed in such a way that they cannot be caught or snagged by parts being removed or replaced. Handle flex cables with extreme care; these cables tear easily.

Grounding guidelines

Electrostatic discharge damage

Electronic components are sensitive to electrostatic discharge (ESD). Circuitry design and structure determine the degree of sensitivity. Networks built into many integrated circuits provide some protection, but in many cases, ESD contains enough power to alter device parameters or melt silicon junctions.

A discharge of static electricity from a finger or other conductor can destroy static-sensitive devices or microcircuitry. Even if the spark is neither felt nor heard, damage may have occurred.

An electronic device exposed to ESD may not be affected at all and can work perfectly throughout a normal cycle. Or the device may function normally for a while, then degrade in the internal layers, reducing its life expectancy.

CAUTION: To prevent damage to the tablet when you are removing or installing internal components, observe these precautions:

Keep components in their electrostatic-safe containers until you are ready to install them.

Before touching an electronic component, discharge static electricity by using the guidelines described in this section.

Avoid touching pins, leads, and circuitry. Handle electronic components as little as possible.

If you remove a component, place it in an electrostatic-safe container.

The following table shows how humidity affects the electrostatic voltage levels generated by different activities.

CAUTION: A product can be degraded by as little as 700 V.

Typical electrostatic voltage levels			
Event	Relative humidity		
	10%	40%	55%
Walking across carpet	35,000 V	15,000 V	7,500 V
Walking across vinyl floor	12,000 V	5,000 V	3,000 V
Motions of bench worker	6,000 V	800 V	400 V
Removing DIPS from plastic tube	2,000 V	700 V	400 V
Removing DIPS from vinyl tray	11,500 V	4,000 V	2,000 V
Removing DIPS from Styrofoam	14,500 V	5,000 V	3,500 V
Removing bubble pack from PCB	26,500 V	20,000 V	7,000 V
Packing PCBs in foam-lined box	21,000 V	11,000 V	5,000 V

Packaging and transporting guidelines

Follow these grounding guidelines when packaging and transporting equipment:

- To avoid hand contact, transport products in static-safe tubes, bags, or boxes.
- Protect ESD-sensitive parts and assemblies with conductive or approved containers or packaging.
- Keep ESD-sensitive parts in their containers until the parts arrive at static-free workstations.
- Place items on a grounded surface before removing items from their containers.
- Always be properly grounded when touching a component or assembly.
- Store reusable ESD-sensitive parts from assemblies in protective packaging or nonconductive foam.
- Use transporters and conveyors made of antistatic belts and roller bushings. Be sure that mechanized equipment used for moving materials is wired to ground and that proper materials are selected to avoid static charging. When grounding is not possible, use an ionizer to dissipate electric charges.

Workstation guidelines

Follow these grounding workstation guidelines:

- Cover the workstation with approved static-shielding material.
- Use a wrist strap connected to a properly grounded work surface and use properly grounded tools and equipment.
- Use conductive field service tools, such as cutters, screw drivers, and vacuums.
- When fixtures must directly contact dissipative surfaces, use fixtures made only of static-safe materials.
- Keep the work area free of nonconductive materials, such as ordinary plastic assembly aids and Styrofoam.
- Handle ESD-sensitive components, parts, and assemblies by the case or PCM laminate. Handle these items only at static-free workstations.
- Avoid contact with pins, leads, or circuitry.
- Turn off power and input signals before inserting or removing connectors or test equipment.

Equipment guidelines

Grounding equipment must include either a wrist strap or a foot strap at a grounded workstation.

- When seated, wear a wrist strap connected to a grounded system. Wrist straps are flexible straps with a minimum of one megohm $\pm 10\%$ resistance in the ground cords. To provide proper ground, wear a strap snugly against the skin at all times. On grounded mats with banana-plug connectors, use alligator clips to connect a wrist strap.
- When standing, use foot straps and a grounded floor mat. Foot straps (heel, toe, or boot straps) can be used at standing workstations and are compatible with most types of shoes or boots. On conductive floors or dissipative floor mats, use foot straps on both feet with a minimum of one megohm resistance between the operator and ground. To be effective, the conductive must be worn in contact with the skin.

The following grounding equipment is recommended to prevent electrostatic damage:

- Antistatic tape
- Antistatic smocks, aprons, and sleeve protectors
- Conductive bins and other assembly or soldering aids
- Nonconductive foam
- Conductive tabletop workstations with ground cords of one megohm resistance
- Static-dissipative tables or floor mats with hard ties to the ground
- Field service kits
- Static awareness labels
- Material-handling packages
- Nonconductive plastic bags, tubes, or boxes
- Metal tote boxes
- Electrostatic voltage levels and protective materials

The following table lists the shielding protection provided by antistatic bags and floor mats.

Material	Use	Voltage protection level
Antistatic plastics	Bags	1,500 V
Carbon-loaded plastic	Floor mats	7,500 V
Metallized laminate	Floor mats	5,000 V

5 Removal and replacement procedures

 **NOTE:** This chapter provides removal and replacement procedures for Authorized Service Provider only components. Components described in this chapter should only be accessed by an authorized service provider. Accessing these components can damage the computer or void the warranty.

There are as many as 48 screws that must be removed, replaced, and/or loosened when servicing the computer. Make special note of each screw size and location during removal and replacement.

 **NOTE:** HP continually improves and changes product parts. For complete and current information on supported parts for your computer, go to <http://partsurfer.hp.com>, select your country or region, and then follow the on-screen instructions.

Bottom cover

 **NOTE:** The bottom cover spare part kit includes rubber feet.

Description	Spare part number
Bottom cover	912990-001

Before disassembling the computer, follow these steps:

1. Turn off the computer. If you are unsure whether the computer is off or in Hibernation, turn the computer on, and then shut it down through the operating system.
2. Disconnect the power from the computer by first unplugging the power cord from the AC outlet and then unplugging the AC adapter from the computer.
3. Disconnect all external devices from the computer.

Remove the bottom cover:

1. Close the computer and position it upside down.
2. Pry the two rear feet of the bottom of the computer **(1)**.
3. Remove the two Phillips M2.0×9.0 screws **(2)** from under the rear feet.
4. Remove the two Torx T8M2.0×3.5 screws **(3)** and the four Torx T8M2.0×9.0 screws **(4)** that secure the bottom cover to the computer.
5. Starting near the hinges, pry the bottom cover **(5)** off the computer.

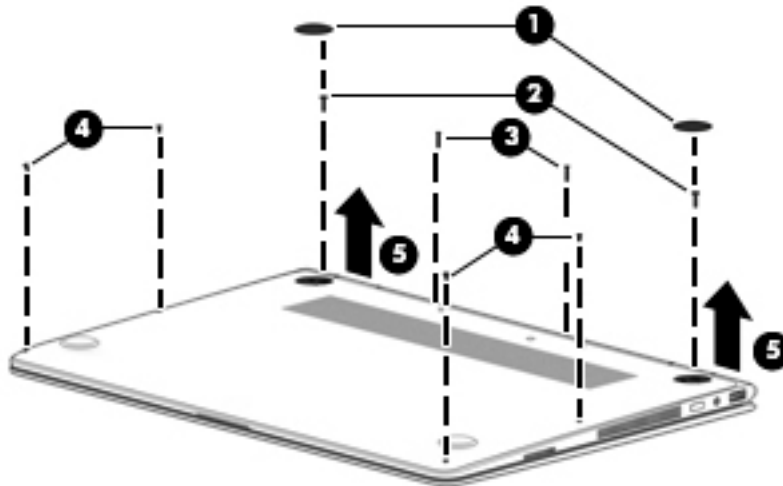

Reverse this procedure to install the bottom cover.

Battery

Battery spare part kits include replacement rubber feet.

Description	Spare part number
Battery, 6-cell, 79-WHr, 3.43-AHr, Li-ion	902499-856

Before removing the battery, follow these steps:

1. Shut down the computer. If you are unsure whether the computer is off or in Hibernation, turn the computer on, and then shut it down through the operating system.
2. Disconnect all external devices connected to the computer.
3. Disconnect the power from the computer by first unplugging the power cord from the AC outlet and then unplugging the AC adapter from the computer.
4. Remove the bottom cover (see [Bottom cover on page 23](#)).

 **WARNING!** To reduce potential safety issues, use only the battery provided with the computer, a replacement battery provided by HP, or a compatible battery purchased from HP.

 **CAUTION:** Removing a battery that is the sole power source for the computer can cause loss of information. To prevent loss of information, save your work or shut down the computer through Windows before removing the battery.

Remove the battery:

1. Disconnect the battery cable from the system board **(1)**.
2. Remove the six Phillips M2.0×3.5 screws **(2)** that secure the battery to the computer.

3. Remove the battery (3) from the computer.

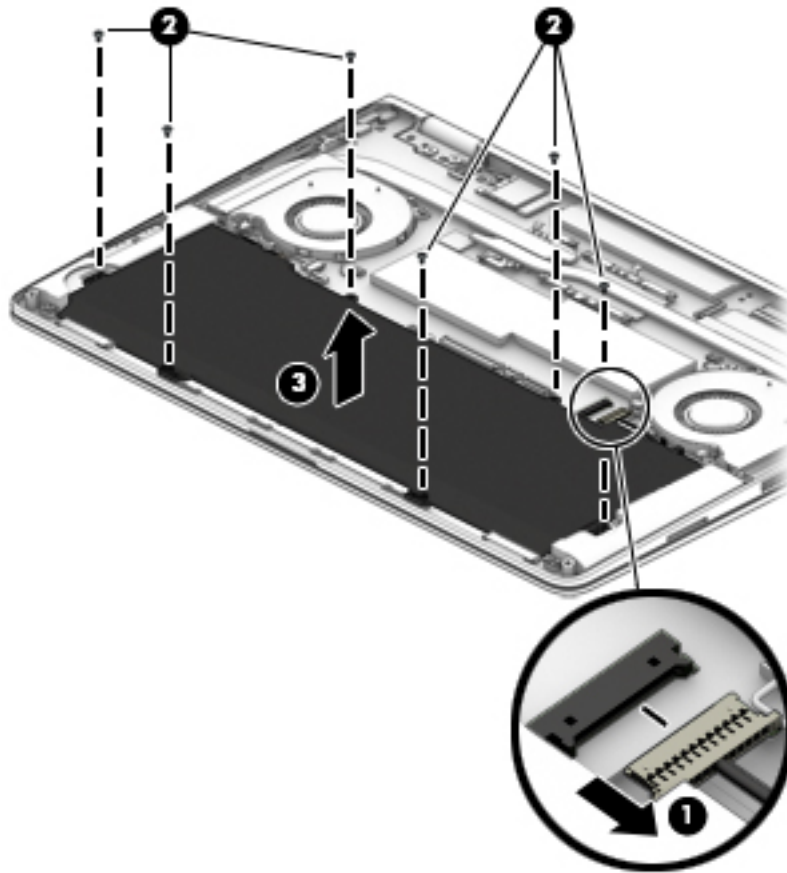

Reverse this procedure to install the battery.

Memory modules

Memory module spare part kits include replacement rubber feet.

Description	Spare part number
8-GB (PC4-2400)	862398-857
4-GB (PC4-2400)	862397-857

The memory modules are installed upside down under the memory cover. Remove the cover to access the memory modules.

Update BIOS before adding memory modules

Before adding new memory, make sure you update the computer to the latest BIOS.

 **CAUTION:** Failure to update the computer to the latest BIOS prior to installing new memory may result in various system problems.

To update BIOS:

1. Navigate to www.hp.com.
2. Click **Support & Drivers** > click **Drivers & Software**.
3. In the **Enter a product name/number** box, type the computer model information, and then click **Search**.
4. Click the link for the computer model.
5. Select the operating system, and then click **Next**.
6. Under **Step 2: Select a Download**, click the **BIOS** link.
7. Click the link for the most recent BIOS.
8. Click the **Download** button, and then follow the on-screen instructions.

Before removing the memory module, follow these steps:

1. Shut down the computer. If you are unsure whether the computer is off or in Hibernation, turn the computer on, and then shut it down through the operating system.
2. Disconnect all external devices connected to the computer.
3. Disconnect the power from the computer by first unplugging the power cord from the AC outlet and then unplugging the AC adapter from the computer.
4. Remove the bottom cover (see [Bottom cover on page 23](#)).
5. Disconnect the battery cable from the system board (see [Battery on page 24](#)).

 **CAUTION:** To prevent damage to internal components, be sure to disconnect the battery cable from the system board before removing the memory modules. You do not need to remove the battery to remove the memory modules.

Remove the memory module:

1. **To remove the memory cover:**
Lift the Mylar off the right side of the memory cover **(1)** off the computer.

2. Pry around the edges of the memory cover, and then lift it off the system board (2).

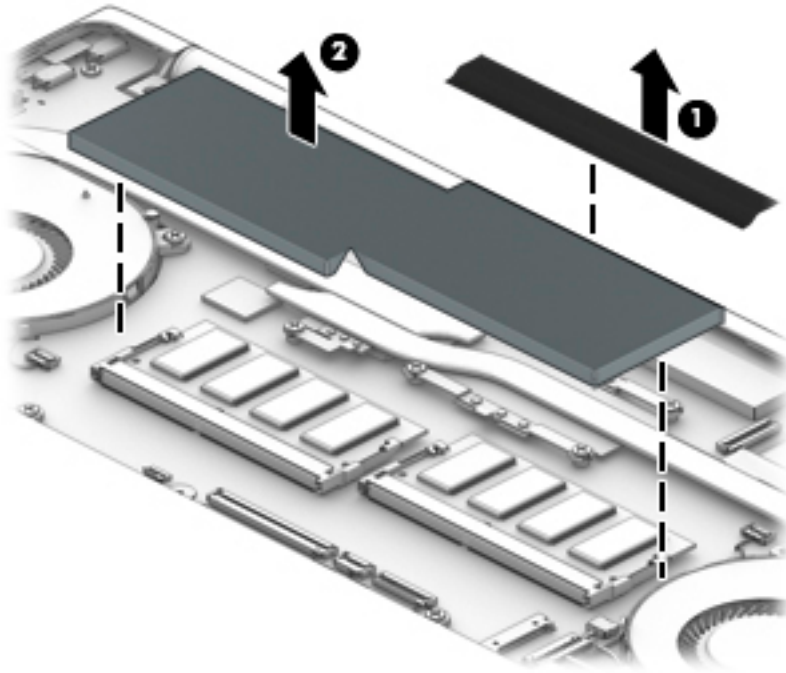

3. Spread the retaining tabs (1) on each side of the memory module slot to release the memory module. (The edge of the module opposite the slot rises away from the computer.)
4. Remove the memory module (2) by pulling the module away from the slot at an angle.



NOTE: The memory modules are installed upside down.

Memory modules are designed with a notch to prevent incorrect insertion into the memory module slot.

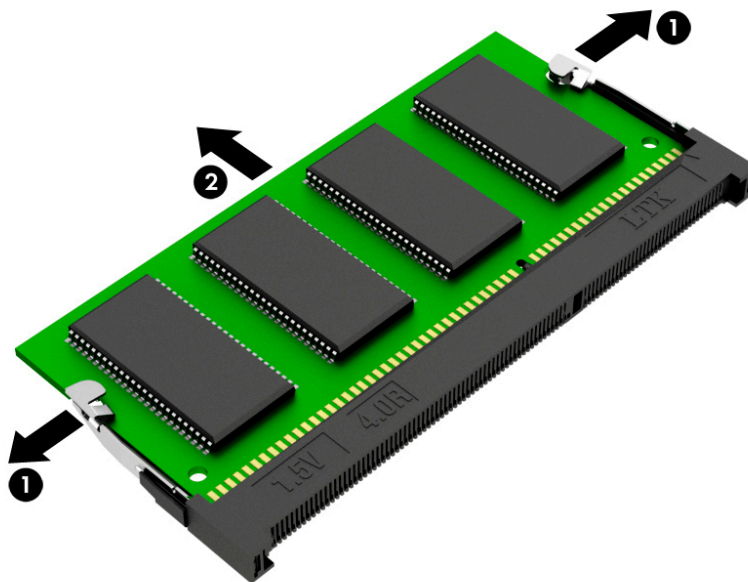

Reverse this procedure to install a memory module.

WLAN module

WLAN module spare part kits include replacement rubber feet.

Description	Spare part number
Intel Dual Band Wireless-AC 8265 802.11 ac 2×2 WiFi + Bluetooth 4.2 Combo Adapter	910264-856

 **CAUTION:** To prevent an unresponsive system, replace the wireless module only with a wireless module authorized for use in the computer by the governmental agency that regulates wireless devices in your country or region. If you replace the module and then receive a warning message, remove the module to restore device functionality, and then contact technical support.

Before removing the WLAN module, follow these steps:

1. Shut down the computer. If you are unsure whether the computer is off or in Hibernation, turn the computer on, and then shut it down through the operating system.
2. Disconnect all external devices connected to the computer.
3. Disconnect the power from the computer by first unplugging the power cord from the AC outlet and then unplugging the AC adapter from the computer.
4. Remove the bottom cover (see [Bottom cover on page 23](#)).
5. Disconnect the battery cable from the system board (see [Battery on page 24](#)).

 **CAUTION:** To prevent damage to internal components, be sure to disconnect the battery cable from the system board before removing the WLAN module. You do not need to remove the battery to remove the WLAN module.

Remove the WLAN module:

1. If installed, remove the tape from atop the antenna connectors on the WLAN module.
2. Disconnect the WLAN antenna cables **(1)** from the terminals on the WLAN module.

 **NOTE:** The WLAN antenna cable labeled “1” connects to the WLAN module “Main” terminal labeled “1”. The WLAN antenna cable labeled “2” connects to the WLAN module “Aux” terminal labeled “2”.

3. Remove the Phillips PM2.0×2.7 screw **(2)** that secures the WLAN module to the top cover. (The WLAN module tilts up.)

4. Remove the WLAN module (3) by pulling the module away from the slot at an angle.

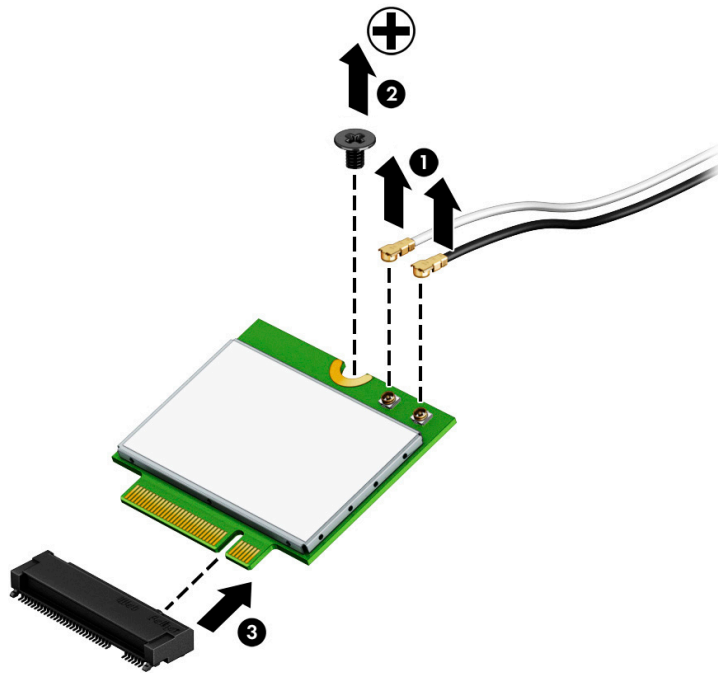

 **NOTE:** If the WLAN antenna cables are not connected to the terminals on the WLAN module, protective sleeves should be installed on the antenna connectors, as shown in the following illustration.

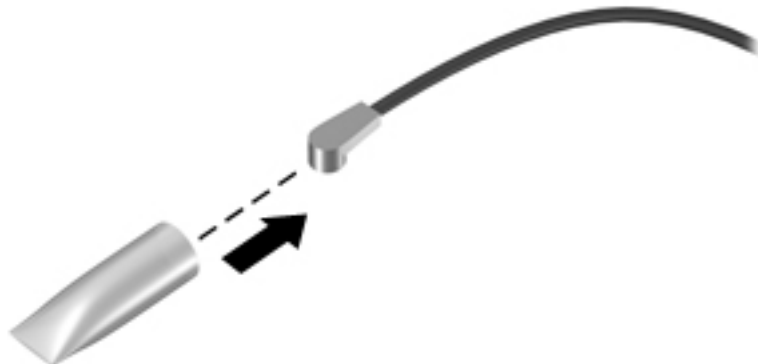

Reverse this procedure to install the WLAN module.

When replacing a WLAN module, after securing the antenna cables to the connectors on the module, be sure to replace the tape atop the antenna connectors.

Fans, left and right

Fan spare part kits include replacement rubber feet.

Description	Spare part number
Fan, left	912994-001
Fan, right	919437-001

Before removing the fans, follow fan these steps:

1. Shut down the computer. If you are unsure whether the computer is off or in Hibernation, turn the computer on, and then shut it down through the operating system.
2. Disconnect all external devices connected to the computer.
3. Disconnect the power from the computer by first unplugging the power cord from the AC outlet and then unplugging the AC adapter from the computer.
4. Remove the bottom cover (see [Bottom cover on page 23](#)).
5. Disconnect the battery cable from the system board (see [Battery on page 24](#)).

 **CAUTION:** To prevent damage to internal components, be sure to disconnect the battery cable from the system board before removing the fans. You do not need to remove the battery to remove the fans.

6. Remove the system board (see [System board on page 50](#)).

Remove the fans:

1. To remove the left fan:

Remove the RTC battery and right speaker cable from the clips in the fan housing **(1)**.

2. Remove the two Phillips M2.0×3.5 screws **(2)** that secure the fan to the computer.
3. Disconnect the fan cable from the system board **(3)**.

4. Remove the fan (4) from the computer.

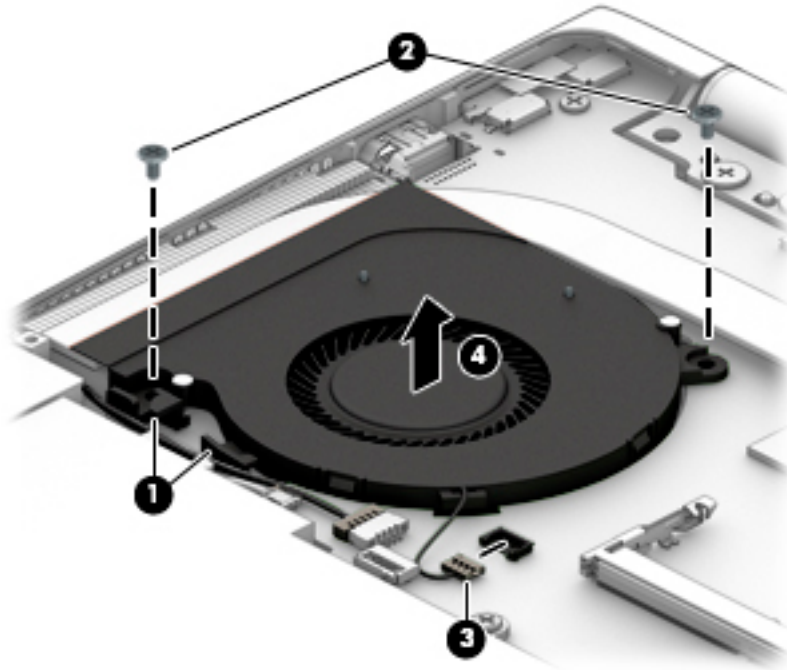

5. **To remove the left fan:**

- Remove the left speaker cable from the clips in the fan housing (1).
6. Disconnect the fan cable from the system board (2).
7. Remove the two Phillips PM2.0×3.5 screws (3) that secure the fan to the computer.
8. Remove the fan (4) from the computer.

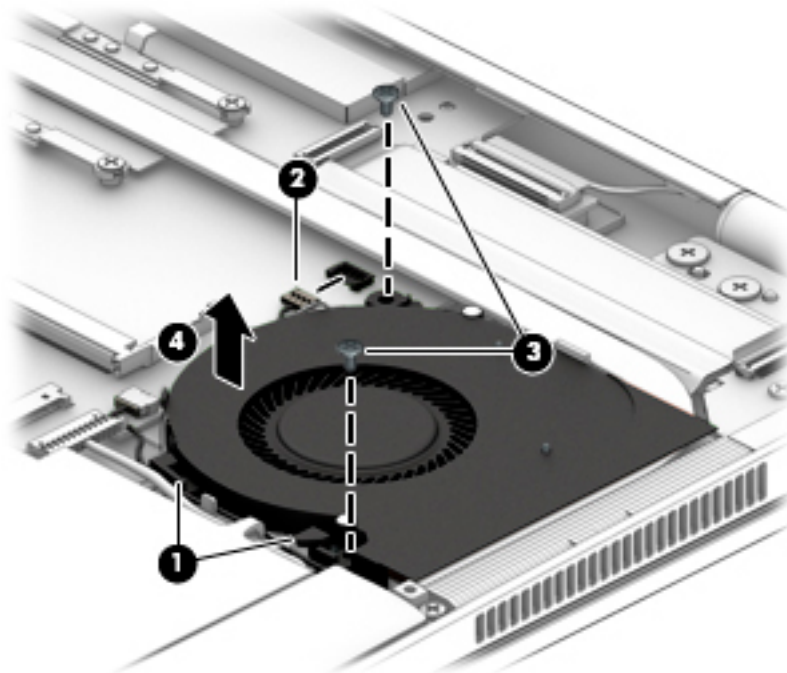

Reverse this procedure to install the fans.

Heat sink

 **NOTE:** The heat sink spare part kit includes replacement thermal material.

Heat sink spare part kits include replacement rubber feet.

Description	Spare part number
Heat sink	911081-001

Before removing the heat sink, follow these steps:

1. Shut down the computer. If you are unsure whether the computer is off or in Hibernation, turn the computer on, and then shut it down through the operating system.
2. Disconnect all external devices connected to the computer.
3. Disconnect the power from the computer by first unplugging the power cord from the AC outlet and then unplugging the AC adapter from the computer.
4. Remove the bottom cover (see [Bottom cover on page 23](#)).
5. Disconnect the battery cable from the system board (see [Battery on page 24](#)).

 **CAUTION:** To prevent damage to internal components, be sure to disconnect the battery cable from the system board before removing the heat sink. You do not need to remove the battery to remove the heat sink.

6. Remove the fans (see [Fans, left and right on page 30](#)).

Remove the heat sink:

1. Remove the six Phillips M2.0×2.5 screws **(1)** that secure the heat sink to the system board.

 **NOTE:** Due to the adhesive quality of the thermal material located between the heat sink and system board components, it may be necessary to move the heat sink from side to side to detach it.

2. Remove the heat sink (2) from the system board.

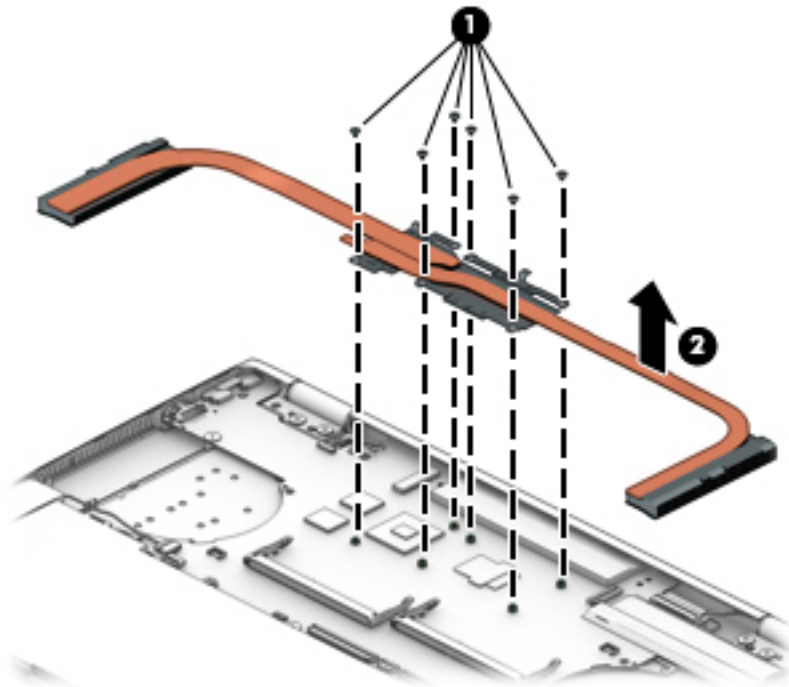

 **NOTE:** The thermal material must be thoroughly cleaned from the surfaces of the heat sink and the system board each time the heat sink is removed. Thermal paste is used on the system board components (1)(3) and the heat sink (2)(4).

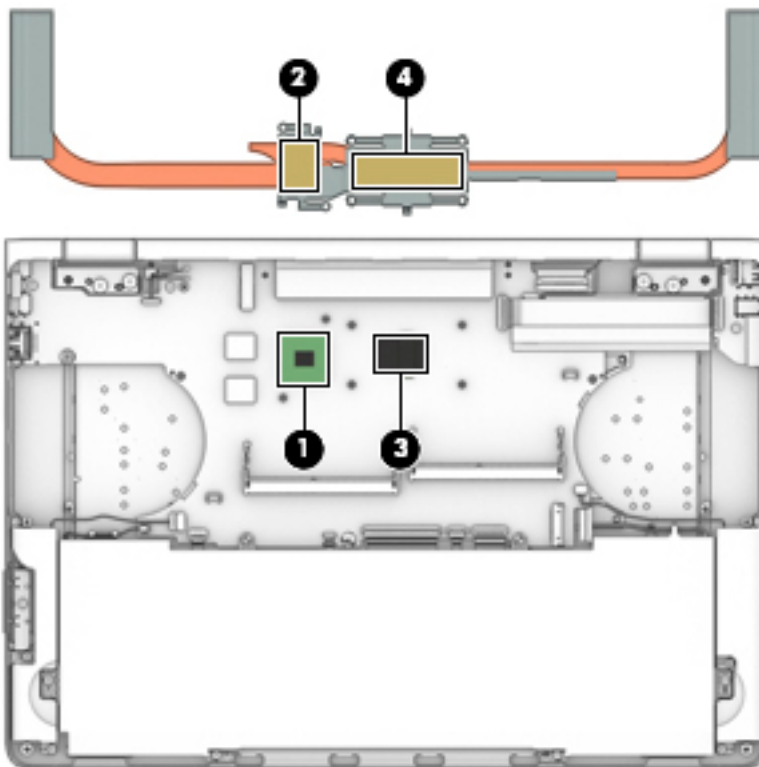

Reverse this procedure to install the heat sink.

Speakers

Speaker spare part kits include replacement rubber feet.

Description	Spare part number
Right Speaker Kit	913008-001
Left Speaker Kit	913009-001

Before removing the speakers, follow these steps:

1. Shut down the computer. If you are unsure whether the computer is off or in Hibernation, turn the computer on, and then shut it down through the operating system.
2. Disconnect all external devices connected to the computer.
3. Disconnect the power from the computer by first unplugging the power cord from the AC outlet and then unplugging the AC adapter from the computer.
4. Remove the bottom cover (see [Bottom cover on page 23](#)).
5. Disconnect the battery cable from the system board (see [Battery on page 24](#)).

 **CAUTION:** To prevent damage to internal components, be sure to disconnect the battery cable from the system board before removing the speakers. You do not need to remove the battery to remove the speakers.

Remove the speakers:

1. **To remove the right speaker:**
Disconnect the speaker cable **(1)** from the system board.
2. Remove the speaker cable from the clips on the fan housing **(2)**.
3. Remove the three Phillips M2.0×3.5 screws **(3)** that secure the speakers to the computer.

4. Remove the right speaker from the computer (4).

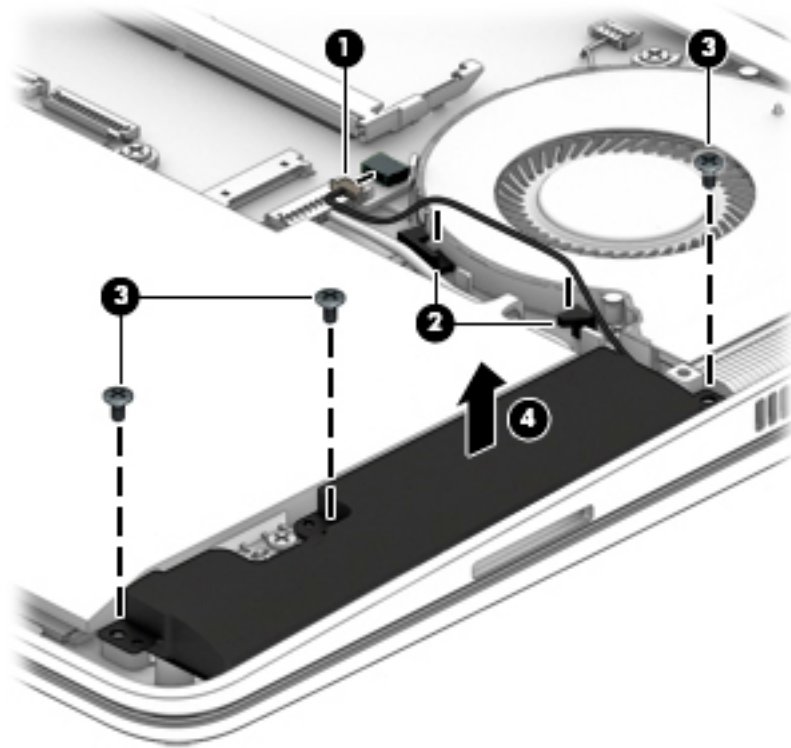

5. **To remove the left speaker:**

Disconnect the speaker cable (1) from the system board.

6. Remove the speaker cable from the clips on the fan housing (2).
7. Remove the three Phillips M2.0×3.5 screws (3) that secure the speakers to the computer.

8. Remove the left speaker from the computer (4).

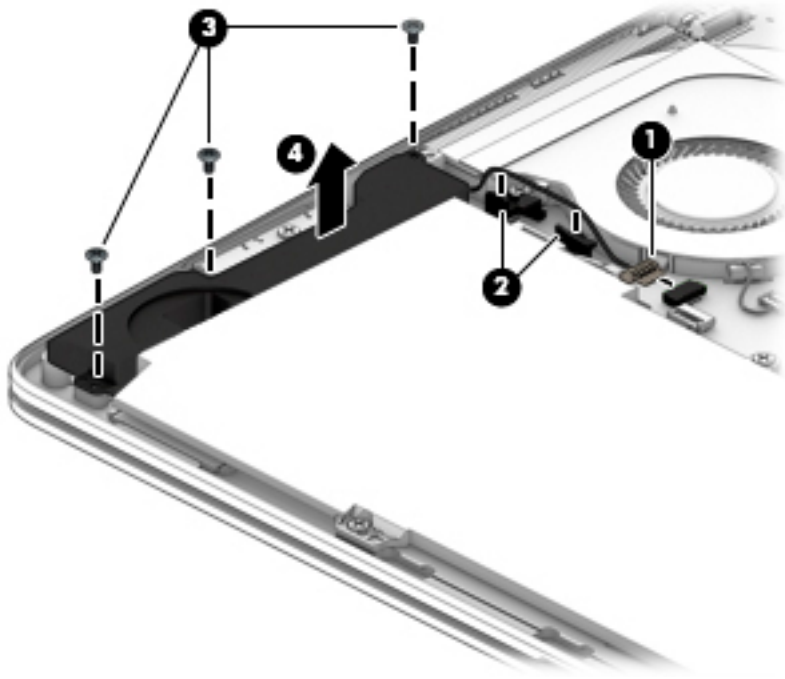

Reverse this procedure to install the speakers.

USB/audio/power connector board

USB/audio/power connector board and cable spare part kits include replacement rubber feet.

Description	Spare part number
USB/audio/power connector board	913006-001
USB/audio/power connector board cable	912993-001

Before removing the USB/audio/power connector board, follow these steps:

1. Turn off the computer. If you are unsure whether the computer is off or in Hibernation, turn the computer on, and then shut it down through the operating system.
2. Disconnect the power from the computer by first unplugging the power cord from the AC outlet and then unplugging the AC adapter from the computer.
3. Disconnect all external devices from the computer.
4. Remove the bottom cover (see [Bottom cover on page 23](#)).
5. Disconnect the battery cable from the system board (see [Battery on page 24](#)).

 **CAUTION:** To prevent damage to internal components, be sure to disconnect the battery cable from the system board before removing the USB/audio/power board. You do not need to remove the battery to remove the board.

Remove the USB/audio/power connector board:

1. Lift the Mylar tape up from the board **(1)**.
2. Disconnect the cable from the connector on the bottom of the board **(2)**.
3. Remove the Phillips PM2.0×3.0 screw **(3)** that secures the board to the computer.

4. Remove the board **(4)** from the computer.

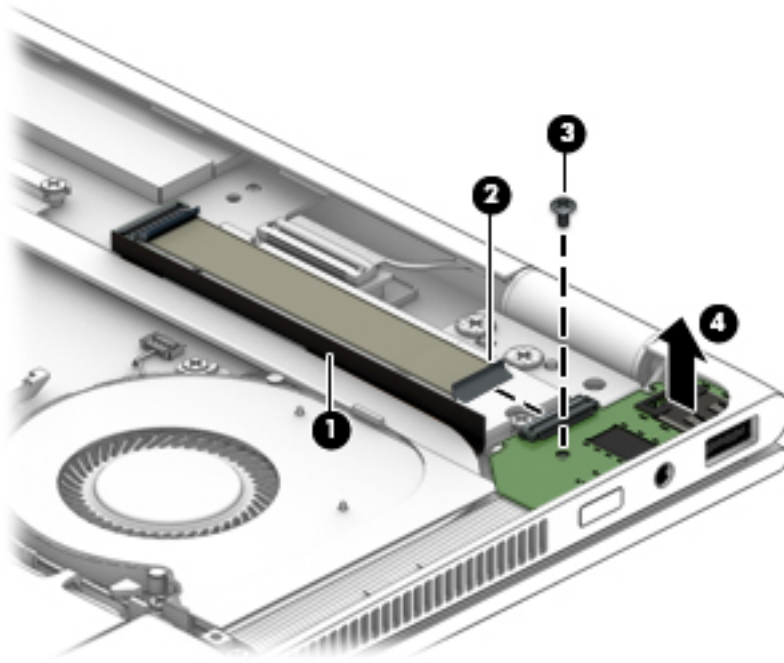

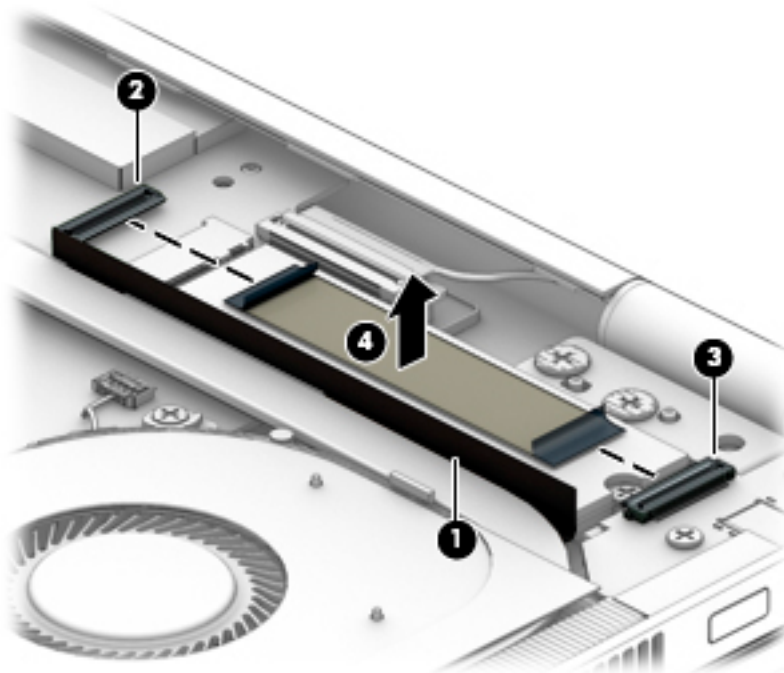

5. **To remove the USB/audio/power connector board:**
Lift the Mylar tape up from the board **(1)**.
6. Disconnect the ZIF connector from system board **(2)**.
7. Disconnect the ZIF connector from board **(3)**.
8. Remove the cable **(4)** from the computer.

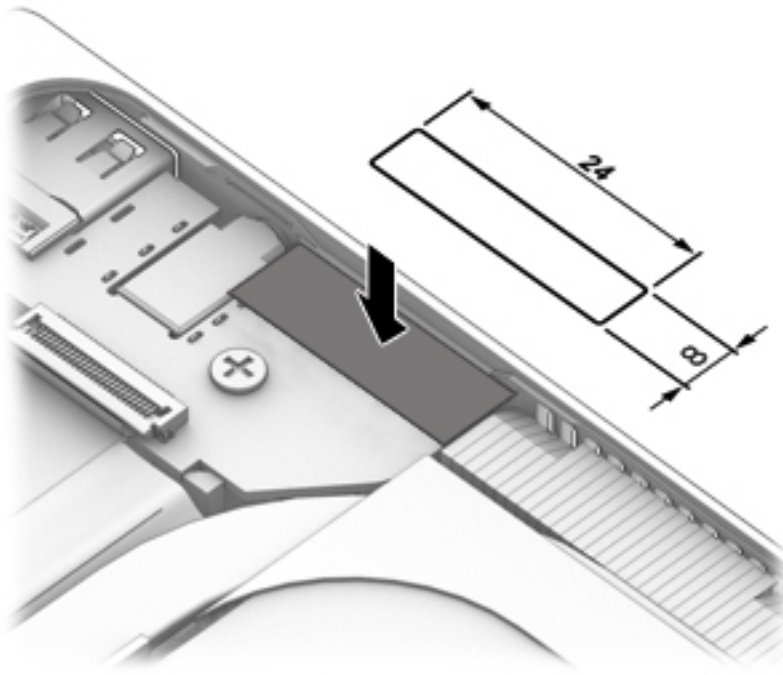

Reverse this procedure to install the USB/audio board.

When replacing the USB/audio board, replace the acetate tape over the light, as shown in the following image. Tape size for this location is 8 mm × 24 mm.



 **IMPORTANT:** The acetate tape is not spared and must be obtained locally.

Solid-state drive

Solid-state drive spare part kits include replacement rubber feet.

Description	Spare part number
1-TB, PCIe solid-state drive	913015-001
512-GB, PCIe solid-state drive	913014-001
360-GB, PCIe solid-state drive	920299-001
256-GB, PCIe solid-state drive	913013-001

 **IMPORTANT:** To remove the solid-state drive, you have to remove the power connector and USB/audio board cable.

Before removing the solid-state drive, follow these steps:

1. Shut down the computer. If you are unsure whether the computer is off or in Hibernation, turn the computer on, and then shut it down through the operating system.
2. Disconnect all external devices connected to the computer.
3. Disconnect the power from the computer by first unplugging the power cord from the AC outlet and then unplugging the AC adapter from the computer.
4. Remove the bottom cover (see [Bottom cover on page 23](#)).
5. Disconnect the battery cable from the system board (see [Battery on page 24](#)).

 **CAUTION:** To prevent damage to internal components, be sure to disconnect the battery cable from the system board before removing the solid-state drive. You do not need to remove the battery to remove the solid-state drive.

6. Remove the power connector and USB/audio board cable (see [USB/audio/power connector board on page 37](#)).

Remove the solid-state drive:

1. Remove the PM2.0×2.9 screw **(1)** that secures the solid-state drive to the bottom cover. (The solid-state drive tilts up.)
2. Remove the solid-state drive **(2)** by pulling the drive away from the slot at an angle.

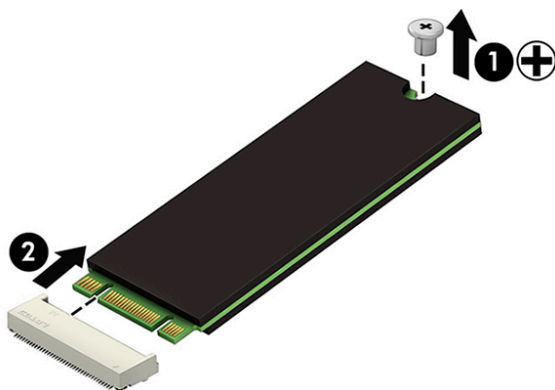

Reverse this procedure to install the solid-state drive.

RTC battery

RTC battery spare part kits include replacement rubber feet.

Description	Spare part number
RTC battery	913007-001

 **IMPORTANT:** The RTC battery is located under the main system battery.

Before removing the RTC battery, follow these steps:

1. Turn off the computer. If you are unsure whether the computer is off or in Hibernation, turn the computer on, and then shut it down through the operating system.
2. Disconnect the power from the computer by first unplugging the power cord from the AC outlet and then unplugging the AC adapter from the computer.
3. Disconnect all external devices from the computer.
4. Remove the bottom cover (see [Bottom cover on page 23](#)).
5. Remove the battery (see [Battery on page 24](#)).

Remove the RTC battery:

1. Position the system board upside-down.
2. Use a tool to pry the battery out of the socket **(1)**.
3. Remove the battery from the system board **(2)**.

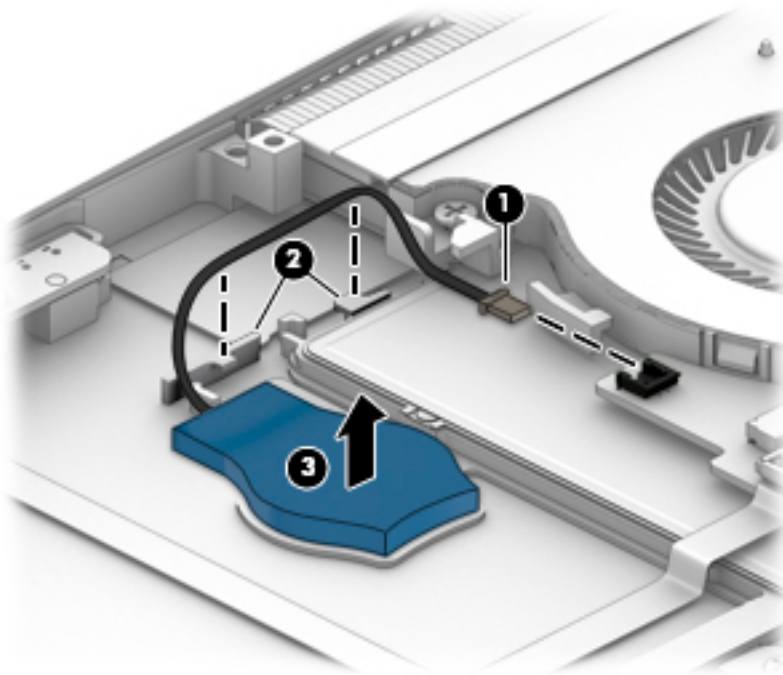

Reverse this procedure to install the RTC battery.

TouchPad

TouchPad board and cable spare part kits include replacement rubber feet.

Description	Spare part number
TouchPad	913004-001
TouchPad cable	912992-001



IMPORTANT: The TouchPad is located under the main system battery.

Before removing the TouchPad, follow these steps:

1. Turn off the computer. If you are unsure whether the computer is off or in Hibernation, turn the computer on, and then shut it down through the operating system.
2. Disconnect the power from the computer by first unplugging the power cord from the AC outlet and then unplugging the AC adapter from the computer.
3. Disconnect all external devices from the computer.
4. Remove the bottom cover (see [Bottom cover on page 23](#)).
5. Remove the battery (see [Battery on page 24](#)).

Remove the TouchPad:

1. Disconnect the TouchPad cable from the TouchPad board **(1)**.
2. Remove the five Phillips M2.0×2.0 screws **(2)** that secure the TouchPad to the computer.

3. Remove the TouchPad from the computer (3).

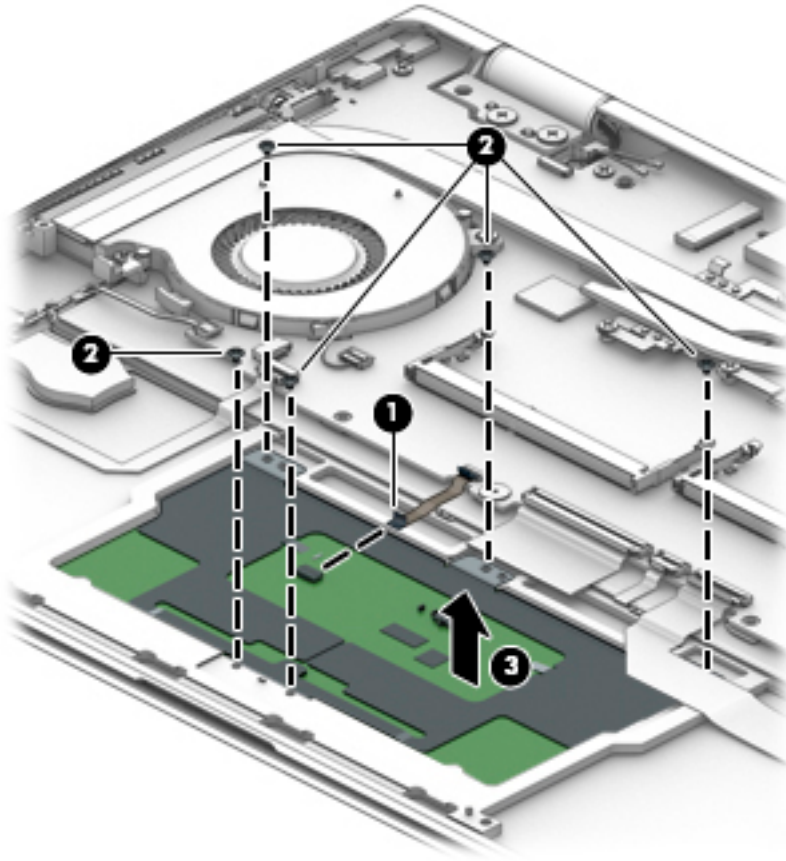

Reverse this procedure to install the TouchPad.

Volume board

Volume board and cable spare part kits include replacement rubber feet.

Description	Spare part number
Volume board	913634-001
Volume board cable	913633-001



IMPORTANT: You must remove the battery and right speaker to remove the volume board. The volume board cable routes under the right speaker.

Before removing the volume board, follow these steps:

1. Turn off the computer. If you are unsure whether the computer is off or in Hibernation, turn the computer on, and then shut it down through the operating system.
2. Disconnect the power from the computer by first unplugging the power cord from the AC outlet and then unplugging the AC adapter from the computer.
3. Disconnect all external devices from the computer.
4. Remove the bottom cover (see [Bottom cover on page 23](#)).
5. Remove the battery (see [Battery on page 24](#)).
6. Remove the right speaker (see [Speakers on page 34](#)).

Remove the volume board:

1. Remove the Phillips PM2.0×3.5 screw **(1)** that secures the volume board to the computer.
2. Lift and rotate the board so you can access the connector underneath **(2)**.
3. Disconnect the cable from the ZIF connector on the bottom of the board **(3)**.

4. Remove the board (4) from the computer.

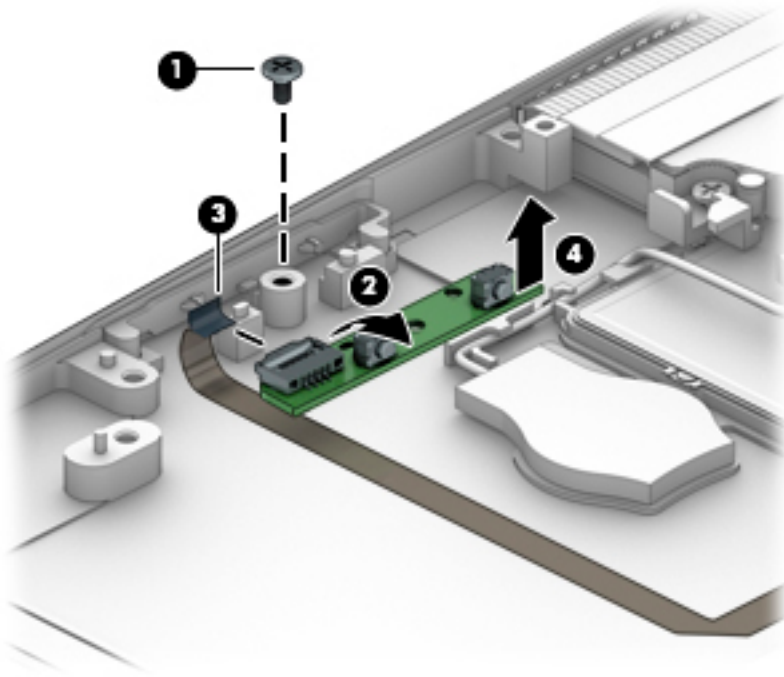

5. Remove the volume board.

Reverse this procedure to install the volume board.

Card reader board

Card reader board and cable spare part kits include replacement rubber feet.

Description	Spare part number
Card reader board	913005-001
Card reader board cable	912991-001



IMPORTANT: You must remove the battery and left speaker to remove the card reader board.

Before removing the card reader board, follow these steps:

1. Turn off the computer. If you are unsure whether the computer is off or in Hibernation, turn the computer on, and then shut it down through the operating system.
2. Disconnect the power from the computer by first unplugging the power cord from the AC outlet and then unplugging the AC adapter from the computer.
3. Disconnect all external devices from the computer.
4. Remove the bottom cover (see [Bottom cover on page 23](#)).
5. Remove the battery (see [Battery on page 24](#)).
6. Remove the left speaker (see [Speakers on page 34](#)).

Remove the card reader board:

1. Remove the Phillips M2.0×2.5 screw **(1)** that secures the card reader board to the computer.
2. Lift and position the card reader board so you can access the connector underneath **(2)**.
3. Disconnect the cable from the ZIF connector on the bottom of the card reader board **(3)**.

4. Remove the card reader board **(4)** from the computer.

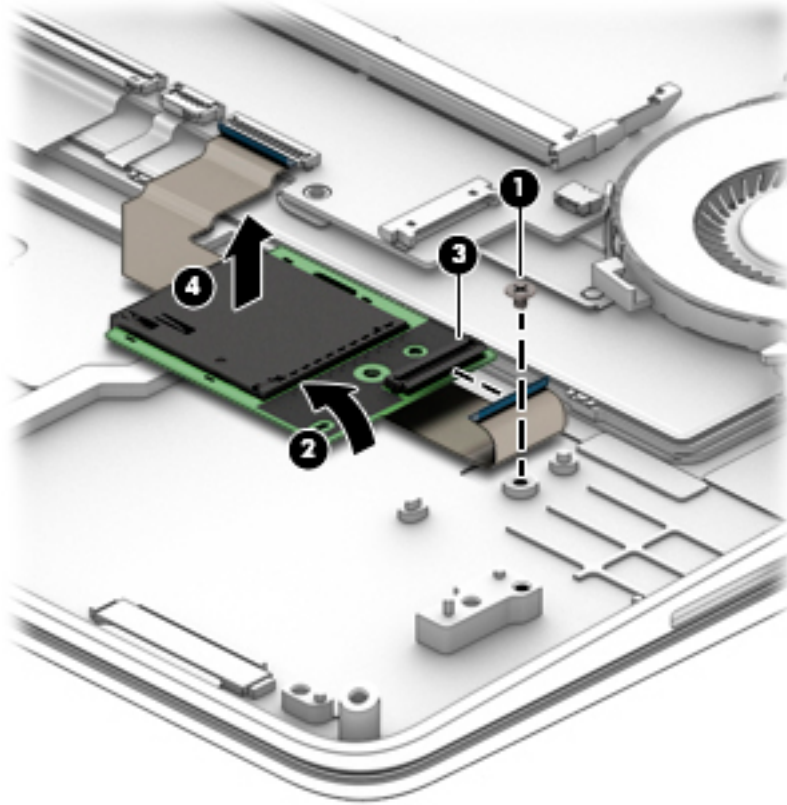

Reverse this procedure to install the card reader board.

Display assembly

Description	Spare part number
Display assembly (full hinge-up)	911082-001

Before removing the display assembly, follow these steps:

1. Turn off the computer. If you are unsure whether the computer is off or in Hibernation, turn the computer on, and then shut it down through the operating system.
2. Disconnect the power from the computer by first unplugging the power cord from the AC outlet and then unplugging the AC adapter from the computer.
3. Disconnect all external devices from the computer.
4. Remove the bottom cover (see [Bottom cover on page 23](#)).
5. Disconnect the battery cable from the system board (see [Battery on page 24](#)).

 **CAUTION:** To prevent damage to internal components, be sure to disconnect the battery cable from the system board before removing the display. You do not need to remove the battery to remove the display.

Remove the display assembly:

1. Open the computer all the way until it is flat (180 degrees).
2. Disconnect the webcam cable from the system board **(2)**.
3. Disconnect the antenna cables from the WLAN module **(3)**.
4. Disconnect the display panel cable from the ZIF connector on the system board **(4)**.
5. Remove the four Phillips M2.5×4.0 screws **(5)** that secure the display assembly to the computer.

6. Pull the display assembly away from the computer (6).

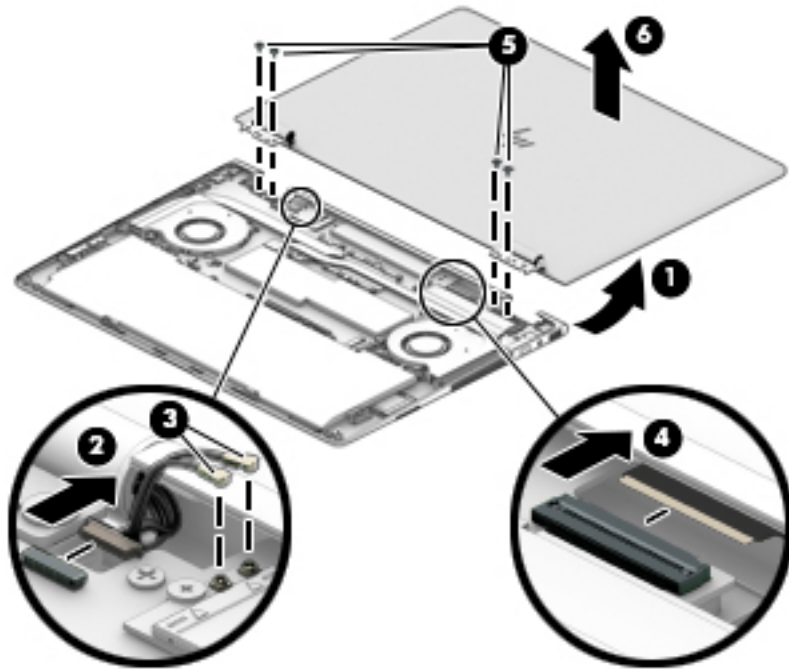

Reverse this procedure to install the display assembly.

System board



NOTE: The system board spare part kit includes processor, a graphics subsystem with 2 GB of discrete graphics memory and replacement thermal material.

System board spare part kits include replacement rubber feet.

Description	Spare part number
Equipped with an Intel Core i7-7500U processor, 2-GB of discrete graphics memory, and the Windows 10 operating system	911083-601
Equipped with an Intel Core i7-7500U processor, 2-GB of discrete graphics memory, and a non-Windows operating system	911083-001

Before removing the system board, follow these steps:

1. Shut down the computer. If you are unsure whether the computer is off or in Hibernation, turn the computer on, and then shut it down through the operating system.
2. Disconnect all external devices connected to the computer.
3. Disconnect the power from the computer by first unplugging the power cord from the AC outlet and then unplugging the AC adapter from the computer.
4. Remove the bottom cover (see [Bottom cover on page 23](#)).
5. Remove the battery (see [Battery on page 24](#)).
6. Remove the fans (see [Fans, left and right on page 30](#)).
7. Remove the heat sink (see [Heat sink on page 32](#)).

When replacing the system board, be sure that the following components are removed from the defective system board and installed on the replacement system board:

- Memory modules (see [Memory modules on page 26](#))
- WLAN module (see [WLAN module on page 28](#))
- Solid-state drive (see [Solid-state drive on page 40](#))

Remove the system board:

1. Disconnect the following cables from the system board:
 - (1) Webcam cable
 - (2) Display cable
 - (3) RTC battery cable
 - (4) Left speaker cable
 - (5) Volume cable
 - (6) TouchPad cable
 - (7) Keyboard cable
 - (8) Keyboard backlight cable
 - (9) Card reader board cable

(10) Right speaker cable

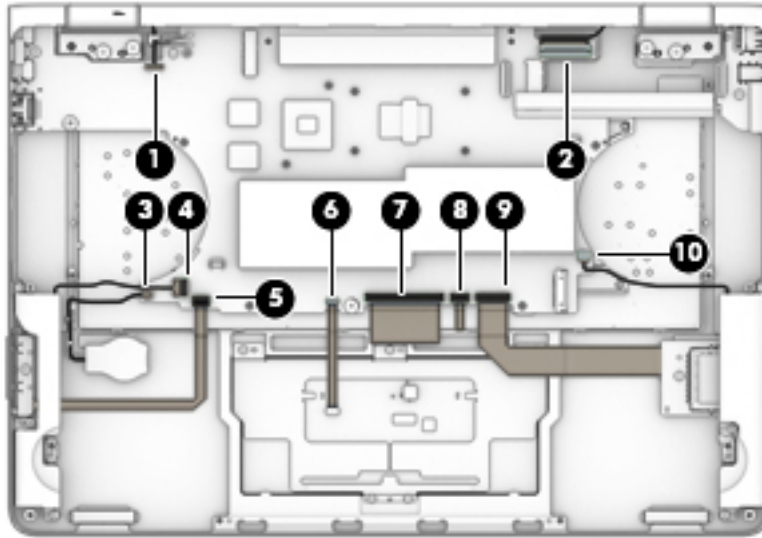

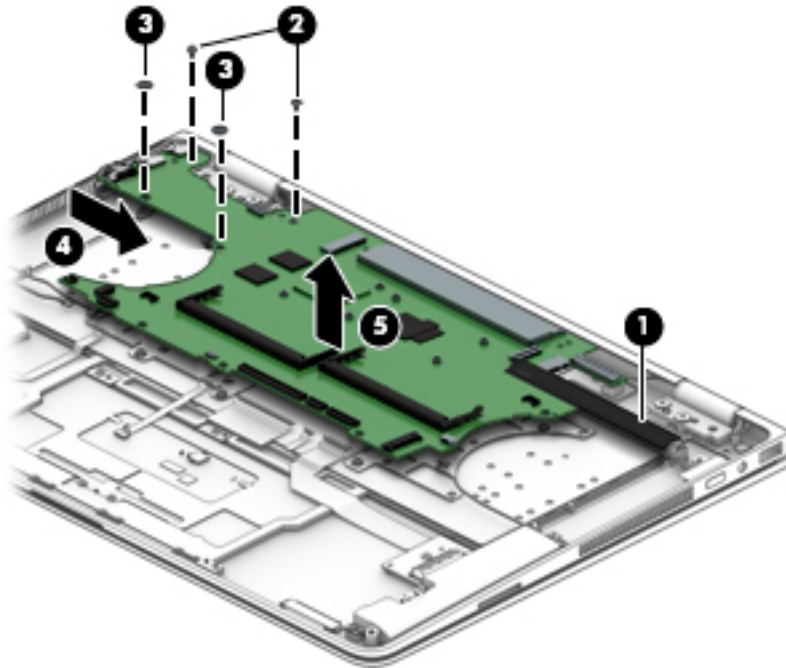

2. Lift the long Mylar strip from atop the system board **(1)**.
3. Remove the two Phillips M2.0×3.5 screws **(2)** and the two Phillips broadhead M2.0×2.0 screws **(3)** that secure the system board to the computer.
4. Slide the system board toward the right **(4)**, and then remove the system board from the computer **(5)**.

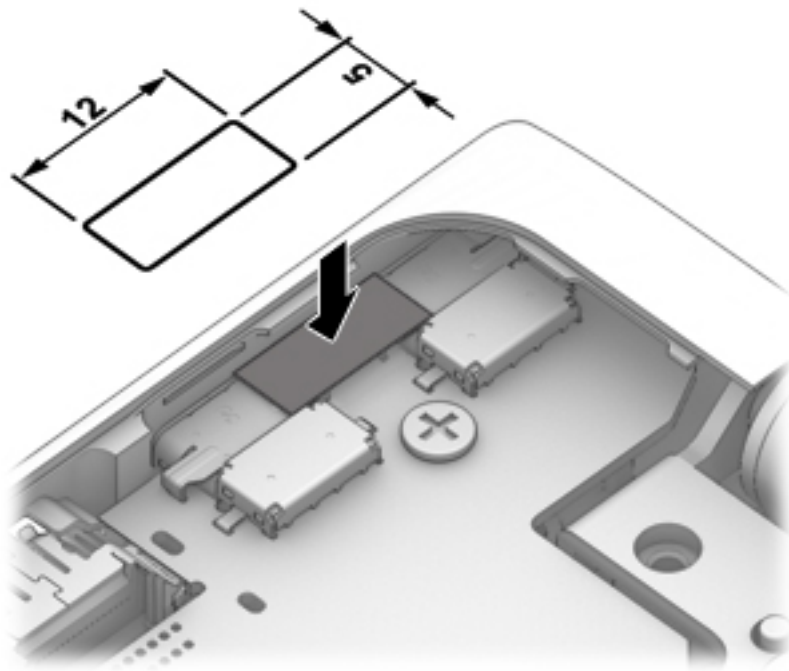

Reverse this procedure to install the system board.

When replacing the system board, replace the acetate tape over the light, as shown in the following image. Tape size for this location is 5 mm × 12 mm.



 **IMPORTANT:** The acetate tape is not spared and must be obtained locally.

Top cover/keyboard

The top cover/keyboard spare part kit includes TouchPad, keyboard, keyboard cable, and keyboard backlight cable.

Top cover/keyboard spare part kits include replacement rubber feet.

For use in country or region	Spare part number	For use in country or region	Spare part number
For use in Canada	912995-DB1	For use in the Russia	912995-251
For use in Denmark, Finland, and Norway	912995-DH1	For use in Saudi Arabia	912995-171
For use in France	912995-051	For use in Switzerland	912995-BG1
For use in Germany	912995-041	For use in the United Kingdom and Singapore	912995-031
For use in the Netherlands	912995-B31	For use in the United States	912995-001

The top cover/keyboard spare part remains after all other spare parts have been removed.

6 Using Setup Utility (BIOS)

Setup Utility, or Basic Input/Output System (BIOS), controls communication between all the input and output devices on the system (such as disk drives, display, keyboard, mouse, and printer). Setup Utility (BIOS) includes settings for the types of devices installed, the startup sequence of the computer, and the amount of system and extended memory.

 **NOTE:** To start Setup Utility on convertible computers, your computer must be in notebook mode and you must use the keyboard attached to your notebook.

Starting Setup Utility (BIOS)

 **CAUTION:** Use extreme care when making changes in Setup Utility (BIOS). Errors can prevent the computer from operating properly.

- ▲ Turn on or restart the computer, quickly press `esc`, and then press `f10`.

Updating Setup Utility (BIOS)

Updated versions of Setup Utility (BIOS) may be available on the HP website.

Most BIOS updates on the HP website are packaged in compressed files called *SoftPaqs*.

Some download packages contain a file named `Readme.txt`, which contains information regarding installing and troubleshooting the file.

Determining the BIOS version

To decide whether you need to update Setup Utility (BIOS), first determine the BIOS version on your computer.

To reveal the BIOS version information (also known as *ROM date* and *System BIOS*), use one of these options.

- HP Support Assistant
 1. Type `support` in the taskbar search box, and then select the **HP Support Assistant** app.
– or –
Click the question mark icon in the taskbar.
 2. Select **My PC**, and then select **Specifications**.
- Setup Utility (BIOS)
 1. Start Setup Utility (BIOS) (see [Starting Setup Utility \(BIOS\) on page 54](#)).
 2. Select **Main**, select **System Information**, and then make note of the BIOS version.
 3. Select **Exit**, select **No**, and then follow the on-screen instructions.

To check for later BIOS versions, see [Downloading a BIOS update on page 55](#).

Downloading a BIOS update

 **CAUTION:** To reduce the risk of damage to the computer or an unsuccessful installation, download and install a BIOS update only when the computer is connected to reliable external power using the AC adapter. Do not download or install a BIOS update while the computer is running on battery power, docked in an optional docking device, or connected to an optional power source. During the download and installation, follow these instructions:

- Do not disconnect power from the computer by unplugging the power cord from the AC outlet.
- Do not shut down the computer or initiate Sleep.
- Do not insert, remove, connect, or disconnect any device, cable, or cord.

 **NOTE:** If your computer is connected to a network, consult the network administrator before installing any software updates, especially system BIOS updates.

1. Type `support` in the taskbar search box, and then select the **HP Support Assistant** app.
– or –
Click the question mark icon in the taskbar.
2. Click **Updates**, and then click **Check for updates and messages**.
3. Follow the on-screen instructions.
4. At the download area, follow these steps:
 - a. Identify the most recent BIOS update and compare it to the BIOS version currently installed on your computer. If the update is more recent than your BIOS version, make a note of the date, name, or other identifier. You may need this information to locate the update later, after it has been downloaded to your hard drive.
 - b. Follow the on-screen instructions to download your selection to the hard drive.

Make a note of the path to the location on your hard drive where the BIOS update is downloaded. You will need to access this path when you are ready to install the update.

BIOS installation procedures vary. Follow any instructions that appear on the screen after the download is complete. If no instructions appear, follow these steps:

1. Type `file` in the taskbar search box, and then select **File Explorer**.
2. Click your hard drive designation. The hard drive designation is typically Local Disk (C:).
3. Using the hard drive path you recorded earlier, open the folder that contains the update.
4. Double-click the file that has an `.exe` extension (for example, `filename.exe`).

The BIOS installation begins.
5. Complete the installation by following the on-screen instructions.

 **NOTE:** After a message on the screen reports a successful installation, you can delete the downloaded file from your hard drive.

7 Using HP PC Hardware Diagnostics (UEFI)

HP PC Hardware Diagnostics is a Unified Extensible Firmware Interface (UEFI) that allows you to run diagnostic tests to determine whether the computer hardware is functioning properly. The tool runs outside the operating system so that it can isolate hardware failures from issues that are caused by the operating system or other software components.

When HP PC Hardware Diagnostics (UEFI) detects a failure that requires hardware replacement, a 24-digit Failure ID code is generated. This ID code can then be provided to support to help determine how to correct the problem.

 **NOTE:** To start diagnostics on a convertible computer, your computer must be in notebook mode and you must use the keyboard attached.

To start HP PC Hardware Diagnostics (UEFI), follow these steps:

1. Turn on or restart the computer, and quickly press *esc*.
2. Press *f2*.

The BIOS searches three places for the diagnostic tools, in the following order:

- a. Connected USB drive

 **NOTE:** To download the HP PC Hardware Diagnostics (UEFI) tool to a USB drive, see [Downloading HP PC Hardware Diagnostics \(UEFI\) to a USB device on page 56](#).

- b. Hard drive

- c. BIOS

3. When the diagnostic tool opens, select the type of diagnostic test you want to run, and then follow the on-screen instructions.

 **NOTE:** If you need to stop a diagnostic test, press *esc*.

Downloading HP PC Hardware Diagnostics (UEFI) to a USB device

 **NOTE:** The HP PC Hardware Diagnostics (UEFI) download instructions are provided in English only, and you must use a Windows computer to download and create the HP UEFI support environment because only .exe files are offered.

There are two options to download HP PC Hardware Diagnostics to a USB device.

Download the latest UEFI version

1. Go to <http://www.hp.com/go/techcenter/pcdiags>. The HP PC Diagnostics home page is displayed.
2. In the HP PC Hardware Diagnostics section, select the **Download** link, and then select **Run**.

Download any version of UEFI for a specific product

1. Go to <http://www.hp.com/support>.
2. Select **Get software and drivers**.

3. Enter the product name or number.

– or –

Select **Identify now** to let HP automatically detect your product.

4. Select your computer, and then select your operating system.
5. In the **Diagnostic** section, follow the on-screen instructions to select and download the UEFI version you want.

8 Backing up, restoring, and recovering

This chapter provides information about the following processes. The information in the chapter is standard procedure for most products.

- Creating recovery media and backups
- Restoring and recovering your system

For additional information, refer to the HP support assistant app.

- ▲ Type `support` in the taskbar search box, and then select the **HP Support Assistant** app.

– or –

Click the question mark icon in the taskbar.

 **IMPORTANT:** If you will be performing recovery procedures on a tablet, the tablet battery must be at least 70% charged before you start the recovery process.

IMPORTANT: For a tablet with a detachable keyboard, connect the keyboard to the keyboard dock before beginning any recovery process.

Creating recovery media and backups

The following methods of creating recovery media and backups are available on select products only. Choose the available method according to your computer model.

- Use HP Recovery Manager to create HP Recovery media after you successfully set up the computer. This step creates a backup of the HP Recovery partition on the computer. The backup can be used to reinstall the original operating system in cases where the hard drive is corrupted or has been replaced. For information on creating recovery media, see [Creating HP Recovery media \(select products only\) on page 58](#). For information on the recovery options that are available using the recovery media, see [Using Windows tools on page 59](#).
- Use Windows tools to create system restore points and create backups of personal information.

For more information, see [Recovering using HP Recovery Manager on page 60](#).

 **NOTE:** If storage is 32 GB or less, Microsoft System Restore is disabled by default.

Creating HP Recovery media (select products only)

If possible, check for the presence of the Recovery partition and the Windows partition. From the **Start** menu, select **File Explorer**, and then select **This PC**.

- If your computer does not list the Windows partition and the Recovery partition, you can obtain recovery media for your system from support. See the *Worldwide Telephone Numbers* booklet included with the computer. You can also find contact information on the HP website. Go to <http://www.hp.com/support>, select your country or region, and follow the on-screen instructions.

You can use Windows tools to create system restore points and create backups of personal information, see [Using Windows tools on page 59](#).

- If your computer does list the Recovery partition and the Windows partition, you can use HP Recovery Manager to create recovery media after you successfully set up the computer. HP Recovery media can be used to perform system recovery if the hard drive becomes corrupted. System recovery reinstalls the original operating system and software programs that were installed at the factory and then configures the settings for the programs. HP Recovery media can also be used to customize the system or restore the factory image if you replace the hard drive.
 - Only one set of recovery media can be created. Handle these recovery tools carefully, and keep them in a safe place.
 - HP Recovery Manager examines the computer and determines the required storage capacity for the media that will be required.
 - To create recovery discs, your computer must have an optical drive with DVD writer capability, and you must use only high-quality blank DVD-R, DVD+R, DVD-R DL, or DVD+R DL discs. Do not use rewritable discs such as CD±RW, DVD±RW, double-layer DVD±RW, or BD-RE (rewritable Blu-ray) discs; they are not compatible with HP Recovery Manager software. Or, instead, you can use a high-quality blank USB flash drive.
 - If your computer does not include an integrated optical drive with DVD writer capability, but you would like to create DVD recovery media, you can use an external optical drive (purchased separately) to create recovery discs. If you use an external optical drive, it must be connected directly to a USB port on the computer; the drive cannot be connected to a USB port on an external device, such as a USB hub. If you cannot create DVD media yourself, you can obtain recovery discs for your computer from HP. See the *Worldwide Telephone Numbers* booklet included with the computer. You can also find contact information on the HP website. Go to <http://www.hp.com/support>, select your country or region, and follow the on-screen instructions.
 - Be sure that the computer is connected to AC power before you begin creating the recovery media.
 - The creation process can take an hour or more. Do not interrupt the creation process.
 - If necessary, you can exit the program before you have finished creating all of the recovery DVDs. HP Recovery Manager will finish burning the current DVD. The next time you start HP Recovery Manager, you will be prompted to continue.

To create HP Recovery media:

 **IMPORTANT:** For a tablet with a detachable keyboard, connect the keyboard to the keyboard dock before beginning these steps.

1. Type `recovery` in the taskbar search box, and then select **HP Recovery Manager**.
2. Select **Create recovery media**, and then follow the on-screen instructions.

If you ever need to recover the system, see [Recovering using HP Recovery Manager on page 60](#).

Using Windows tools

You can create recovery media, system restore points, and backups of personal information using Windows tools.

 **NOTE:** If storage is 32 GB or less, Microsoft System Restore is disabled by default.

For more information and steps, see the Get started app.

- ▲ Select the **Start** button, and then select the **Get started** app.

Restore and recovery

There are several options for recovering your system. Choose the method that best matches your situation and level of expertise:



IMPORTANT: Not all methods are available on all products.

- Windows offers several options for restoring from backup, refreshing the computer, and resetting the computer to its original state. For more information see the Get started app.
 - ▲ Select the **Start** button, and then select the **Get started** app.
- If you need to correct a problem with a preinstalled application or driver, use the Reinstall drivers and/or applications option (select products only) of HP Recovery Manager to reinstall the individual application or driver.
 - ▲ Type `recovery` in the taskbar search box, select **HP Recovery Manager**, select **Reinstall drivers and/or applications**, and then follow the on-screen instructions.
- If you want to recover the Windows partition to original factory content, you can choose the System Recovery option from the HP Recovery partition (select products only) or use the HP Recovery media. For more information, see [Recovering using HP Recovery Manager on page 60](#). If you have not already created recovery media, see [Creating HP Recovery media \(select products only\) on page 58](#).
- On select products, if you want to recover the computer's original factory partition and content, or if you have replaced the hard drive, you can use the Factory Reset option of HP Recovery media. For more information, see [Recovering using HP Recovery Manager on page 60](#).
- On select products, if you want to remove the recovery partition to reclaim hard drive space, HP Recovery Manager offers the Remove Recovery Partition option.

For more information, see [Removing the HP Recovery partition \(select products only\) on page 63](#).

Recovering using HP Recovery Manager

HP Recovery Manager software allows you to recover the computer to its original factory state by using the HP Recovery media that you either created or that you obtained from HP, or by using the HP Recovery partition (select products only). If you have not already created recovery media, see [Creating HP Recovery media \(select products only\) on page 58](#).

What you need to know before you get started

- HP Recovery Manager recovers only software that was installed at the factory. For software not provided with this computer, you must either download the software from the manufacturer's website or reinstall the software from the media provided by the manufacturer.



IMPORTANT: Recovery through HP Recovery Manager should be used as a final attempt to correct computer issues.

- HP Recovery media must be used if the computer hard drive fails. If you have not already created recovery media, see [Creating HP Recovery media \(select products only\) on page 58](#).
- To use the Factory Reset option (select products only), you must use HP Recovery media. If you have not already created recovery media, see [Creating HP Recovery media \(select products only\) on page 58](#).
- If your computer does not allow the creation of HP Recovery media or if the HP Recovery media does not work, you can obtain recovery media for your system from support. See the *Worldwide Telephone Numbers* booklet included with the computer. You can also find contact information from the HP

website. Go to <http://www.hp.com/support>, select your country or region, and follow the on-screen instructions.

 **IMPORTANT:** HP Recovery Manager does not automatically provide backups of your personal data. Before beginning recovery, back up any personal data you want to retain.

Using HP Recovery media, you can choose from one of the following recovery options:

 **NOTE:** Only the options available for your computer display when you start the recovery process.

- System Recovery—Reinstalls the original operating system, and then configures the settings for the programs that were installed at the factory.
- Factory Reset—Restores the computer to its original factory state by deleting all information from the hard drive and re-creating the partitions. Then it reinstalls the operating system and the software that was installed at the factory.

The HP Recovery partition (select products only) allows System Recovery only.

Using the HP Recovery partition (select products only)

The HP Recovery partition allows you to perform a system recovery without the need for recovery discs or a recovery USB flash drive. This type of recovery can be used only if the hard drive is still working.

To start HP Recovery Manager from the HP Recovery partition:

 **IMPORTANT:** For a tablet with a detachable keyboard, connect the keyboard to the keyboard dock before beginning these steps (select products only).

1. Type `recovery` in the taskbar search box, select **Recovery Manager**, and then select **HP Recovery Environment**.

- or -

For computers or tablets with keyboards attached, press **f11** while the computer boots, or press and hold **f11** as you press the power button.

For tablets without keyboards:

Turn on or restart the tablet, and then quickly hold down the volume up button; then select **f11**.

- or -

Turn on or restart the tablet, and then quickly hold down the volume down button; then select **f11**.

- or -

Turn on or restart the tablet, and then quickly hold down the Windows button; then select **f11**.

2. Select **Troubleshoot** from the boot options menu.
3. Select **Recovery Manager**, and then follow the on-screen instructions.

Using HP Recovery media to recover

You can use HP Recovery media to recover the original system. This method can be used if your system does not have an HP Recovery partition or if the hard drive is not working properly.

1. If possible, back up all personal files.
2. Insert the HP Recovery media, and then restart the computer.



NOTE: If the computer does not automatically restart in HP Recovery Manager, change the computer boot order. See [Changing the computer boot order on page 62](#).

3. Follow the on-screen instructions.

Changing the computer boot order

If your computer does not restart in HP Recovery Manager, you can change the computer boot order, which is the order of devices listed in BIOS where the computer looks for startup information. You can change the selection to an optical drive or a USB flash drive.

To change the boot order:



IMPORTANT: For a tablet with a detachable keyboard, connect the keyboard to the keyboard dock before beginning these steps.

1. Insert the HP Recovery media.
2. Access the system **Startup** menu.

For computers or tablets with keyboards attached:

- ▲ Turn on or restart the computer or tablet, quickly press **esc**, and then press **f9** for boot options.

For tablets without keyboards:

- ▲ Turn on or restart the tablet, and then quickly hold down the volume up button; then select **f9**.

- or -

Turn on or restart the tablet, and then quickly hold down the volume down button; then select **f9**.

- or -

Turn on or restart the tablet, and then quickly hold down the Windows button; then select **f9**.

3. Select the optical drive or USB flash drive from which you want to boot.
4. Follow the on-screen instructions.

Removing the HP Recovery partition (select products only)

HP Recovery Manager software allows you to remove the HP Recovery partition to free up hard drive space.



IMPORTANT: After you remove the HP Recovery partition, you will not be able to perform System Recovery or create HP recovery media from the HP Recovery partition. So before you remove the Recovery partition, create HP Recovery media; see [Creating HP Recovery media \(select products only\) on page 58](#).



NOTE: The Remove Recovery Partition option is only available on products that support this function.

Follow these steps to remove the HP Recovery partition:

1. Type `recovery` in the taskbar search box, and then select **HP Recovery Manager**.
2. Select **Remove Recovery Partition**, and then follow the on-screen instructions.

9 Specifications

	Metric	U.S.
Dimensions		
Width	359.7 mm	14.16 in
Depth	250.9 mm	9.88 in
Height	17.9 mm	0.71
Weight (equipped with solid-state drive)	2136 g	4.7 lbs
Input power		
Operating voltage and current	19.5 V dc @ 2.31 A – 45 W	
	19.5 V dc @ 3.33 A – 65 W	
NOTE: This product is designed for IT power systems in Norway with phase-to-phase voltage not exceeding 240 V rms.		
NOTE: The computer operating voltage and current can be found on the system regulatory label.		
Temperature		
Operating	5°C to 35°C	41°F to 95°F
Nonoperating	-20°C to 60°C	-4°F to 140°F
Relative humidity (noncondensing)		
Operating	10% to 90%	
Nonoperating	5% to 95%	
Maximum altitude (unpressurized)		
Operating	-15 m to 3,048 m	-50 ft to 10,000 ft
Nonoperating	-15 m to 12,192 m	-50 ft to 40,000 ft
NOTE: Applicable product safety standards specify thermal limits for plastic surfaces. The device operates well within this range of temperatures.		

10 Power cord set requirements

The wide-range input feature of the computer permits it to operate from any line voltage from 100 to 120 volts AC, or from 220 to 240 volts AC.

The 3-conductor power cord set included with the computer meets the requirements for use in the country or region where the equipment is purchased.

Power cord sets for use in other countries and regions must meet the requirements of the country or region where the computer is used.

Requirements for all countries

The following requirements are applicable to all countries and regions:

- The length of the power cord set must be at least 1.0 m (3.3 ft) and no more than 2.0 m (6.5 ft).
- All power cord sets must be approved by an acceptable accredited agency responsible for evaluation in the country or region where the power cord set will be used.
- The power cord sets must have a minimum current capacity of 10 amps and a nominal voltage rating of 125 or 250 V AC, as required by the power system of each country or region.
- The appliance coupler must meet the mechanical configuration of an EN 60 320/IEC 320 Standard Sheet C13 connector for mating with the appliance inlet on the back of the computer. Requirements for all countries 113

Requirements for specific countries and regions

Country/region	Accredited agency	Applicable note number
Australia	EANSW	1
Austria	OVE	1
Belgium	CEBC	1
Canada	CSA	2
Denmark	DEMKO	1
Finland	FIMKO	1
France	UTE	1
Germany	VDE	1
Italy	IMQ	1
Japan	METI	3
The Netherlands	KEMA	1
Norway	NEMKO	1
The People's Republic of China	COC	5

Country/region	Accredited agency	Applicable note number
South Korea	EK	4
Sweden	CEMKO	1
Switzerland	SEV	1
Taiwan	BSMI	4
The United Kingdom	BSI	1
The United States	UL	2

1. The flexible cord must be Type H05VV-F, 3-conductor, 1.0-mm² conductor size. Power cord set fittings (appliance coupler and wall plug) must bear the certification mark of the agency responsible for evaluation in the country or region where it will be used.
2. The flexible cord must be Type SPT-3 or equivalent, No. 18 AWG, 3-conductor. The wall plug must be a two-pole grounding type with a NEMA 5-15P (15 A, 125 V) or NEMA 6-15P (15 A, 250 V) configuration.
3. The appliance coupler, flexible cord, and wall plug must bear a “T” mark and registration number in accordance with the Japanese Dentori Law. The flexible cord must be Type VCT or VCTF, 3-conductor, 1.00-mm² conductor size. The wall plug must be a two-pole grounding type with a Japanese Industrial Standard C8303 (7 A, 125 V) configuration.
4. The flexible cord must be Type RVV, 3-conductor, 0.75-mm² conductor size. Power cord set fittings (appliance coupler and wall plug) must bear the certification mark of the agency responsible for evaluation in the country or region where it will be used.
5. The flexible cord must be Type VCTF, 3-conductor, 0.75-mm² conductor size. Power cord set fittings (appliance coupler and wall plug) must bear the certification mark of the agency responsible for evaluation in the country or region where it will be used.

11 Recycling

When a non-rechargeable or rechargeable battery has reached the end of its useful life, do not dispose of the battery in general household waste. Follow the local laws and regulations in your area for battery disposal.

HP encourages customers to recycle used electronic hardware, HP original print cartridges, and rechargeable batteries. For more information about recycling programs, see the HP Web site at <http://www.hp.com/recycle>.

Index

- A**
 - AC adapter and battery 12
 - AC adapter, spare part numbers 17
 - action keys 9
 - identifying 8
 - active pen, spare part number 17
 - airplane mode key 9
 - audio, product description 1
 - audio-out (headphone)/audio-in (microphone) jack, identifying 10
- B**
 - backups 58
 - battery
 - removal 24
 - spare part number 16, 24
 - BIOS
 - determining version 54
 - downloading an update 55
 - starting the Setup Utility 54
 - updating 54
 - Bluetooth label 14
 - boot order
 - changing 62
 - bottom 14
 - bottom cover
 - removal 23
 - spare part numbers 17, 23
 - buttons
 - left TouchPad 5
 - power 10
 - right TouchPad 5
- C**
 - cables, service considerations 18
 - camera
 - identifying 4
 - camera light, identifying 4
 - caps lock light, identifying 6
 - card reader board
 - removal 46
 - spare part numbers 16, 46
 - card reader board cable
 - spare part numbers 16
 - chipset, product description 1
 - components
 - bottom 13
 - display 4
 - left side 10
 - right side 12
 - top 5
 - computer
 - major components 15
 - specifications 64
 - connector, power 12
 - connectors
 - service considerations 18
- D**
 - display assembly
 - removal 48
 - spare part numbers 48
 - display panel, product description 1
- E**
 - electrostatic discharge 19
 - equipment guidelines 21
 - esc key, identifying 8
 - external media cards, product description 2
- F**
 - fan
 - removal 30
 - spare part numbers 17, 30
 - fn key, identifying 8
- G**
 - graphics, product description 1
 - grounding guidelines 19
 - guidelines
 - equipment 21
 - grounding 19
 - packaging 20
 - transporting 20
 - workstation 20
- H**
 - HDMI port
 - identifying 12
 - heat sink
 - removal 32
 - spare part numbers 17, 32
- HP PC Hardware Diagnostics (UEFI) using 56
- HP Recovery Manager
 - correcting boot problems 62
 - starting 61
- HP Recovery media
 - creating 58
 - recovery 61
- HP Recovery partition
 - recovery 61
 - removing 63
- I**
 - infrared camera
 - identifying 4
 - infrared camera lights, identifying 4
 - internal microphones, identifying 4
- J**
 - jacks
 - audio-out (headphone)/audio-in (microphone) 10
- K**
 - keyboard
 - removal 53
 - spare part numbers 16, 53
 - keys
 - action 8
 - airplane mode 9
 - esc 8
 - fn 8
 - Windows 8
- L**
 - labels
 - Bluetooth 14
 - regulatory 14
 - serial number 14
 - service 14
 - wireless certification 14
 - WLAN 14

- left speaker kit
 - spare part number 17
- lights
 - AC adapter and battery light 12
 - caps lock 6
 - mute 6
 - power 11
- M**
- memory card reader, identifying 11
- memory card, identifying 11
- memory module
 - removal 26
 - spare part numbers 26
- memory modules
 - spare part numbers 17
- memory, product description 1
- microphone
 - product description 1
- minimized image recovery 61
- minimized image, creating 60
- model name 1
- mute light, identifying 6
- O**
- operating system, product description 3
- original system recovery 60
- P**
- packaging guidelines 20
- plastic parts, service considerations 18
- ports
 - HDMI 12
 - product description 2
 - USB 3.x port with HP Sleep and Charge 10
 - USB Type-C power connector and Thunderbolt port 12
 - USB Type-C power connector port with HP Sleep and Charge 12
 - USB Type-C power connector with HP Sleep and Charge 12
- power button, identifying 10
- power connector, identifying 12
- power cord
 - set requirements 65
 - spare part numbers 17
- power lights, identifying 11
- power requirements, product description 2, 3
- primary storage, product description 1
- processor, product description 1
- product description
 - audio 1
 - chipset 1
 - display panel 1
 - external media cards 2
 - graphics 1
 - memory 1
 - microphone 1
 - operating system 3
 - ports 2
 - power requirements 2, 3
 - primary storage 1
 - processors 1
 - product name 1
 - security 3
 - sensors 2
 - serviceability 3
 - solid-state drive 1
 - video 1
 - wireless 2
- product name 1
- product name and number, computer 14
- R**
- recover
 - options 60
- recovery
 - discs 59, 61
 - HP Recovery Manager 60
 - media 61
 - starting 61
 - supported discs 59
 - system 60
 - USB flash drive 61
 - using HP Recovery media 59
- recovery media
 - creating 58
 - creating using HP Recovery Manager 59
- recovery partition
 - removing 63
- regulatory information
 - regulatory label 14
 - wireless certification labels 14
- removal/replacement procedures 22
- right speaker kit
 - spare part number 17
- RTC battery
 - removal 41
 - spare part number 41
 - spare part numbers 16
- rubber feet, spare part number 17
- S**
- Screw Kit, spare part number 17
- security, product description 3
- sensors, product description 2
- serial number 14
- serial number, computer 14
- service considerations
 - cables 18
 - connectors 18
 - plastic parts 18
- service labels, locating 14
- serviceability, product description 3
- slots
 - memory card reader 11
- solid-state drive
 - product description 1
 - removal 40
 - spare part numbers 16, 40
- speaker kit, left
 - spare part number 17
- speaker kit, right
 - spare part number 17
- speakers
 - identifying 7
 - removal 34
 - spare part number 34
- supported discs, recovery 59
- system board
 - removal 50
 - spare part numbers 16, 50
- system recovery 60
- system restore point
 - creating 59
- system restore point, creating 58
- T**
- Thunderbolt
 - identifying USB Type-C 12
- tools required 18

- TouchPad
 - buttons 5
 - removal 42
 - spare part numbers 16, 42
- TouchPad cable
 - spare part numbers 16
- TouchPad zone, identifying 5
- transporting guidelines 20
- traveling with the computer 14
- Type-C power connector port with HP Sleep and Charge, identifying 12
- WLAN module
 - removal 28
 - spare part numbers 16, 28
 - workstation guidelines 20

U

- USB 3.x port with HP Sleep and Charge, identifying 10
- USB Type-C power connector and Thunderbolt port, identifying 12
- USB Type-C power connector port with HP Sleep and Charge, identifying 12
- USB-C to RJ-45 adapter 17
- USB-C to USB-A adapter 17
- USB-C to VGA adapter 17
- USB/audio/power connector board
 - removal 37
 - spare part number 16
 - spare part numbers 37
- USB/audio/power connector board cable
 - spare part number 16

V

- vents, identifying 11, 12, 13
- video, product description 1
- volume board
 - removal 44
 - spare part number 16, 44
- volume board cable
 - spare part number 16

W

- Windows
 - system restore point 58, 59
- Windows key, identifying 8
- Windows tools
 - using 59
- wireless certification label 14
- wireless, product description 2
- WLAN antennas, identifying 4
- WLAN device 14
- WLAN label 14