

# Alienware 13 R3 Service Manual

**Computer Model:** Alienware 13 R3  
**Regulatory Model:** P81G  
**Regulatory Type:** P81G001

A L I E N W A R E™ 

# Notes, cautions, and warnings

---

 **NOTE:** A NOTE indicates important information that helps you make better use of your product.

 **CAUTION:** A CAUTION indicates either potential damage to hardware or loss of data and tells you how to avoid the problem.

 **WARNING:** A WARNING indicates a potential for property damage, personal injury, or death.

---

**Copyright © 2016 Dell Inc. or its subsidiaries. All rights reserved.** Dell, EMC, and other trademarks are trademarks of Dell Inc. or its subsidiaries. Other trademarks may be trademarks of their respective owners.

2016 - 12

Rev. A01

# Contents

<b>Before working inside your computer.....</b>	<b>10</b>
Before you begin .....	10
Safety instructions.....	10
Recommended tools.....	11
Screw list.....	12
<b>After working inside your computer.....</b>	<b>14</b>
<b>Removing the base cover.....</b>	<b>15</b>
Procedure.....	15
<b>Replacing the base cover.....</b>	<b>17</b>
Procedure.....	17
<b>Removing the wireless card.....</b>	<b>18</b>
Prerequisites.....	18
Procedure.....	18
<b>Replacing the wireless card.....</b>	<b>20</b>
Procedure.....	20
Post-requisites.....	21
<b>Removing the solid-state drive.....</b>	<b>22</b>
Prerequisites.....	22
Procedure.....	22

<b>Replacing the solid-state drive.....</b>	<b>24</b>
Procedure.....	24
Post-requisites.....	25
<b>Removing the memory modules.....</b>	<b>26</b>
Prerequisites.....	26
Procedure.....	26
<b>Replacing the memory modules.....</b>	<b>28</b>
Procedure.....	28
Post-requisites.....	29
<b>Removing the rear-I/O cover.....</b>	<b>30</b>
Prerequisites.....	30
Procedure.....	30
<b>Replacing the rear-I/O cover.....</b>	<b>32</b>
Procedure.....	32
Post-requisites.....	32
<b>Removing the computer base.....</b>	<b>33</b>
Prerequisites.....	33
Procedure.....	33
<b>Replacing the computer base.....</b>	<b>36</b>
Procedure.....	36
Post-requisites.....	36
<b>Removing the coin-cell battery.....</b>	<b>37</b>
Prerequisites.....	37
Procedure.....	37

- Replacing the coin-cell battery..... 39**
  - Procedure..... 39
  - Post-requisites.....39
  
- Removing the heat-sink assembly..... 40**
  - Prerequisites..... 40
  - Procedure.....40
  
- Replacing the heat-sink assembly..... 42**
  - Procedure.....42
  - Post-requisites.....42
  
- Removing the battery..... 43**
  - Prerequisites..... 43
  - Procedure..... 43
  
- Replacing the battery.....45**
  - Procedure.....45
  - Post-requisites..... 45
  
- Removing the touch pad..... 46**
  - Prerequisites..... 46
  - Procedure.....46
  
- Replacing the touch pad..... 50**
  - Procedure.....50
  - Post-requisites..... 50
  
- Removing the system board..... 51**
  - Prerequisites..... 51
  - Procedure.....52

<b>Replacing the system board.....</b>	<b>55</b>
Procedure.....	55
Post-requisites.....	56
<b>Removing the speakers.....</b>	<b>57</b>
Prerequisites.....	57
Procedure.....	57
<b>Replacing the speakers.....</b>	<b>59</b>
Procedure.....	59
Post-requisites.....	59
<b>Removing the power-adapter port.....</b>	<b>60</b>
Prerequisites.....	60
Procedure.....	60
<b>Replacing the power-adapter port.....</b>	<b>62</b>
Procedure.....	62
Post-requisites.....	62
<b>Removing the power-button board.....</b>	<b>63</b>
Prerequisites.....	63
Procedure.....	63
<b>Replacing the power-button board.....</b>	<b>65</b>
Procedure.....	65
Post-requisites.....	65
<b>Removing the keyboard.....</b>	<b>66</b>
Prerequisites.....	66
Procedure.....	66

- Replacing the keyboard..... 69**
  - Procedure..... 69
  - Post-requisites..... 69
  
- Removing the display assembly..... 71**
  - Prerequisites..... 71
  - Procedure..... 71
  
- Replacing the display assembly..... 74**
  - Procedure..... 74
  - Post-requisites..... 74
  
- Removing the palm rest..... 76**
  - Prerequisites..... 76
  - Procedure..... 76
  
- Replacing the palm rest..... 78**
  - Procedure..... 78
  - Post-requisites..... 78
  
- Removing the display bezel..... 79**
  - Prerequisites..... 79
  - Procedure..... 79
  
- Replacing the display bezel..... 82**
  - Procedure..... 82
  - Post-requisites..... 82
  
- Removing the camera cable..... 83**
  - Prerequisites..... 83
  - Procedure..... 83

- Replacing the camera cable..... 85**
  - Procedure..... 85
  - Post-requisites.....85
  
- Removing the camera..... 86**
  - Prerequisites..... 86
  - Procedure..... 86
  
- Replacing the camera..... 88**
  - Procedure..... 88
  - Post-requisites.....88
  
- Removing the display panel..... 89**
  - Prerequisites..... 89
  - Procedure..... 89
  
- Replacing the display panel..... 92**
  - Procedure..... 92
  - Post-requisites..... 92
  
- Removing the display hinges..... 94**
  - Prerequisites..... 94
  - Procedure..... 94
  
- Replacing the display hinges..... 98**
  - Procedure..... 98
  - Post-requisites.....98
  
- Removing the display back-cover and antenna assembly..... 100**
  - Prerequisites..... 100
  - Procedure..... 101



<b>Replacing the display back-cover and antenna assembly.....</b>	<b>102</b>
Procedure.....	102
Post-requisites.....	102
<b>BIOS overview.....</b>	<b>103</b>
Entering the BIOS setup program.....	103
Timing key sequences.....	103
System setup options.....	103
Clearing forgotten passwords.....	109
Clearing CMOS settings.....	109
Flashing the BIOS.....	110
Boot menu.....	110
Boot menu enhancements.....	111
<b>Diagnostics.....</b>	<b>112</b>
<b>Flashing the BIOS.....</b>	<b>114</b>
<b>Getting help and contacting Alienware.....</b>	<b>115</b>
Self-help resources.....	115
Contacting Alienware.....	115

# Before working inside your computer

---

 **NOTE:** The images in this document may differ from your computer depending on the configuration you ordered.

## Before you begin

1 Save and close all open files and exit all open applications.

2 Shut down your computer.

The shut-down instruction varies depending on the operating system installed on your computer.

– Windows 10: Click **Start** →  **Power** → **Shut down**.

– Windows 8.1: On the **Start** screen, Click the power icon  → **Shut down**.

– Windows 7: Click **Start** → **Shut down**.

 **NOTE:** If you are using a different operating system, see the documentation of your operating system for shut-down instructions.

3 Disconnect your computer and all attached devices from their electrical outlets.

4 Disconnect all attached network devices and peripherals, such as keyboard, mouse, and monitor, from your computer.

5 Remove any media card and optical disc from your computer, if applicable.

6 Close the display and turn the computer over.

## Safety instructions

Use the following safety guidelines to protect your computer from potential damage and ensure your personal safety.

 **WARNING:** Before working inside your computer, read the safety information that shipped with your computer. For more safety best practices, see the Regulatory Compliance home page at [www.dell.com/regulatory\\_compliance](http://www.dell.com/regulatory_compliance).

 **WARNING:** Disconnect all power sources before opening the computer cover or panels. After you finish working inside the computer, replace all covers, panels, and screws before connecting to the electrical outlet.

 **CAUTION:** To avoid damaging the computer, ensure that the work surface is flat and clean.

 **CAUTION:** To avoid damaging the components and cards, handle them by their edges, and avoid touching pins and contacts.

 **CAUTION:** You should only perform troubleshooting and repairs as authorized or directed by the Dell technical assistance team. Damage due to servicing that is not authorized by Dell is not covered by your warranty. See the safety instructions that shipped with the product or at [www.dell.com/regulatory\\_compliance](http://www.dell.com/regulatory_compliance).

 **CAUTION:** Before touching anything inside your computer, ground yourself by touching an unpainted metal surface, such as the metal at the back of the computer. While you work, periodically touch an unpainted metal surface to dissipate static electricity, which could harm internal components.

 **CAUTION:** When you disconnect a cable, pull on its connector or on its pull tab, not on the cable itself. Some cables have connectors with locking tabs or thumb-screws that you must disengage before disconnecting the cable. When disconnecting cables, keep them evenly aligned to avoid bending any connector pins. When connecting cables, ensure that the ports and connectors are correctly oriented and aligned.

 **CAUTION:** Press and eject any installed card from the media-card reader.













## Recommended tools





The procedures in this document may require the following tools:

- Phillips screwdriver
- Plastic scribe

# Screw list

**Table 1. Screw list**

Component	Secured to	Screw type	Quantity	Screw image
Wireless card	Computer base	M2x3	1	
Solid-state drive	Computer base	M2x3	1	
Rear-I/O cover	Palm-rest assembly	M2.5x6L	2	
Computer base	Palm-rest assembly	M2x3	1	
Computer base	Palm-rest assembly	M2.5x6L	11	
Computer base	Palm-rest assembly	M2.5x6L	2	
Heat-sink assembly	System board	M2x3	7	
Touch-pad bracket	Palm-rest assembly	M2x3	5	
System board	Palm-rest assembly	M2.5x6L	2	
Speaker	Palm-rest assembly	M2x3	1	
Power-button board	Palm-rest assembly	M2x3	2	
Keyboard bracket	Palm-rest assembly	M2x3	8	

<b>Component</b>	<b>Secured to</b>	<b>Screw type</b>	<b>Quantity</b>	<b>Screw image</b>
Display assembly	Palm-rest assembly	M2.5x6L	4	
Display panel	Display back-cover and antenna assembly	M1.6x2	4	
Display hinges	Display back-cover and antenna assembly	M2.5x2.0L	8	
USB Type-C port bracket	System board	M2.5x6L	2	

# After working inside your computer

---



**CAUTION: Leaving stray or loose screws inside your computer may severely damage your computer.**

- 1 Replace all screws and ensure that no stray screws remain inside your computer.
- 2 Connect any external devices, peripherals, or cables you removed before working on your computer.
- 3 Replace any media cards, discs, or any other parts that you removed before working on your computer.
- 4 Connect your computer and all attached devices to their electrical outlets.
- 5 Turn on your computer.

# Removing the base cover

**⚠ WARNING:** Before working inside your computer, read the safety information that shipped with your computer and follow the steps in [Before working inside your computer](#). After working inside your computer, follow the instructions in [After working inside your computer](#). For more safety best practices, see the Regulatory Compliance home page at [www.dell.com/regulatory\\_compliance](http://www.dell.com/regulatory_compliance).

## Procedure

- 1 Loosen the five captive screws that secure the base cover to the computer base.
- 2 Using a plastic scribe, gently pry the base cover to release the tabs on the base cover from the slots on the computer base.
- 3 Lift the base cover off the computer base.

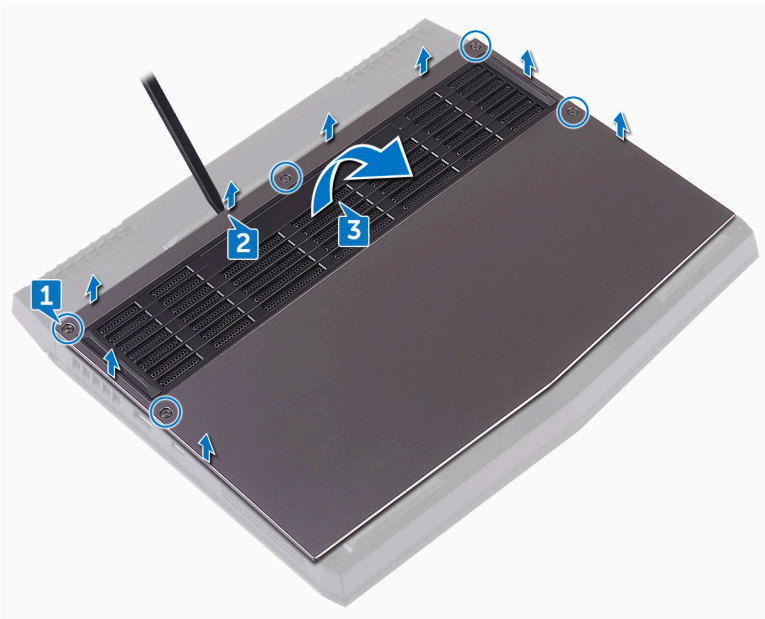

- 4 Using a plastic scribe, disconnect the battery cable from the system board.



- 5 Press and hold the power button for five seconds to ground the system board.



# Replacing the base cover

---



**WARNING:** Before working inside your computer, read the safety information that shipped with your computer and follow the steps in [Before working inside your computer](#). After working inside your computer, follow the instructions in [After working inside your computer](#). For more safety best practices, see the Regulatory Compliance home page at [www.dell.com/regulatory\\_compliance](http://www.dell.com/regulatory_compliance).

## Procedure

- 1 Connect the battery cable to the system board.
- 2 Slide the tabs on the base cover into the slots on the computer base and snap the base cover into place.
- 3 Tighten the five captive screws that secure the base cover to the computer base.

# Removing the wireless card

---

 **WARNING:** Before working inside your computer, read the safety information that shipped with your computer and follow the steps in [Before working inside your computer](#). After working inside your computer, follow the instructions in [After working inside your computer](#). For more safety best practices, see the Regulatory Compliance home page at [www.dell.com/regulatory\\_compliance](http://www.dell.com/regulatory_compliance).

## Prerequisites

Remove the [base cover](#).

## Procedure

- 1 Remove the screw (M2x3) that secures the wireless card and bracket to the computer base.
- 2 Lift the wireless-card bracket off the wireless card.
- 3 Disconnect the antenna cables from the wireless card.

4 Lift and slide the wireless card out of the wireless-card slot.

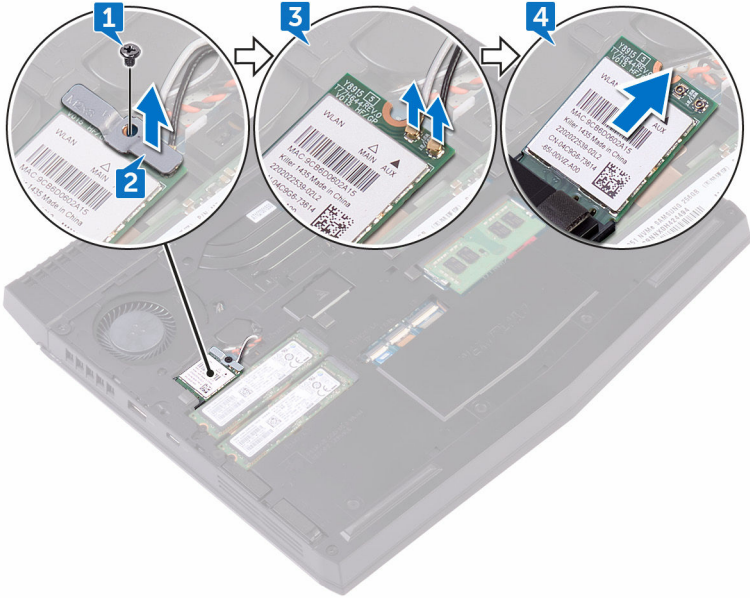

# Replacing the wireless card

---

 **WARNING:** Before working inside your computer, read the safety information that shipped with your computer and follow the steps in [Before working inside your computer](#). After working inside your computer, follow the instructions in [After working inside your computer](#). For more safety best practices, see the Regulatory Compliance home page at [www.dell.com/regulatory\\_compliance](http://www.dell.com/regulatory_compliance).

## Procedure

 **CAUTION:** To avoid damaging the wireless card, do not place any cables under it.

- 1 Align the notch on the wireless card with the tab on the wireless-card slot.
- 2 Slide the wireless card at an angle into the wireless-card slot.
- 3 Connect the antenna cables to the wireless card.

The following table provides the antenna-cable color scheme for the wireless card supported by your computer.

**Table 2. Antenna-cable color scheme**

<b>Connectors on the wireless card</b>	<b>Antenna cable color</b>
Auxiliary (black triangle)	Black
Main (white triangle)	White

- 4 Align the screw hole on the wireless-card bracket with the screw hole on the wireless card and the computer base.

- 5 Replace the screw (M2x3) that secures the wireless-card bracket to the wireless card and the computer base.

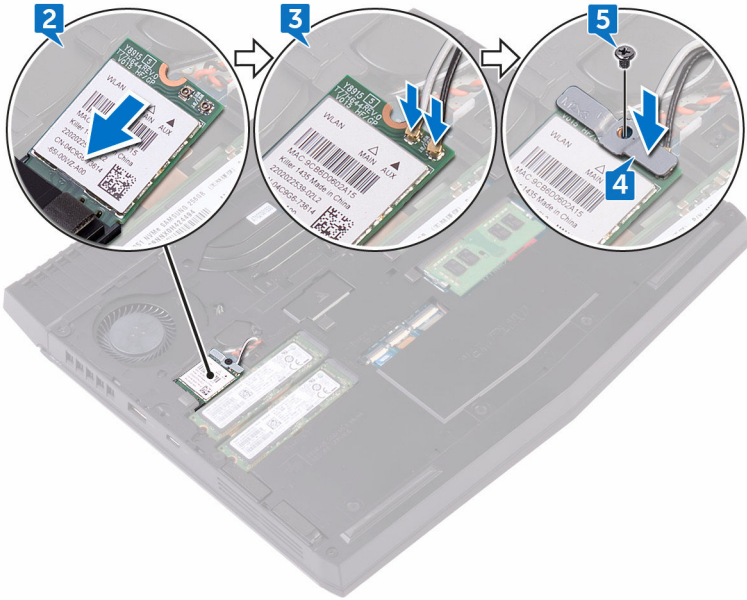



## Post-requisites

Replace the [base cover](#).

# Removing the solid-state drive

---

-  **WARNING:** Before working inside your computer, read the safety information that shipped with your computer and follow the steps in [Before working inside your computer](#). After working inside your computer, follow the instructions in [After working inside your computer](#). For more safety best practices, see the Regulatory Compliance home page at [www.dell.com/regulatory\\_compliance](http://www.dell.com/regulatory_compliance).
-  **CAUTION:** Solid-state drives are fragile. Exercise care when handling the solid-state drive.
-  **CAUTION:** To avoid data loss, do not remove the solid-state drive while the computer is in sleep or on state.

## Prerequisites

Remove the [base cover](#).

## Procedure

- 1 Remove the screw (M2x3) that secures the solid-state drive to the computer base.

2 Lift and slide the solid-state drive from the solid-state drive slot.

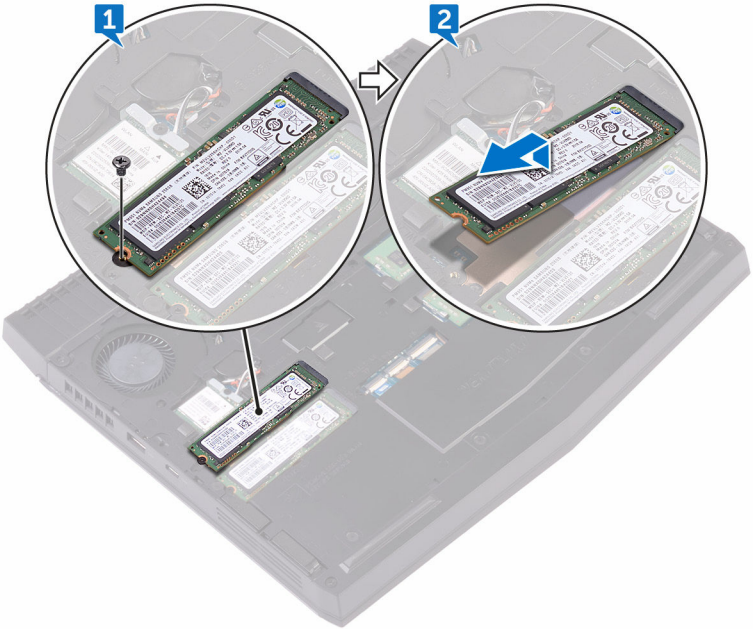

# Replacing the solid-state drive

---

 **WARNING:** Before working inside your computer, read the safety information that shipped with your computer and follow the steps in [Before working inside your computer](#). After working inside your computer, follow the instructions in [After working inside your computer](#). For more safety best practices, see the Regulatory Compliance home page at [www.dell.com/regulatory\\_compliance](http://www.dell.com/regulatory_compliance).

 **CAUTION:** Solid-state drives are fragile. Exercise care when handling the solid-state drive.

## Procedure

 **NOTE:** Adhere the thermal pad on the copper foil area, if the thermal pads are shipped with the solid-state drive.

- 1 Align the notch on the solid-state drive with the tab on the solid-state drive slot and slide the solid-state drive into the solid-state drive slot.
- 2 Press the other end of the solid-state drive to align the screw hole on the solid-state drive with the screw hole on the computer base.



- 3 Replace the screw (M2x3) that secures the solid-state drive to the computer base.

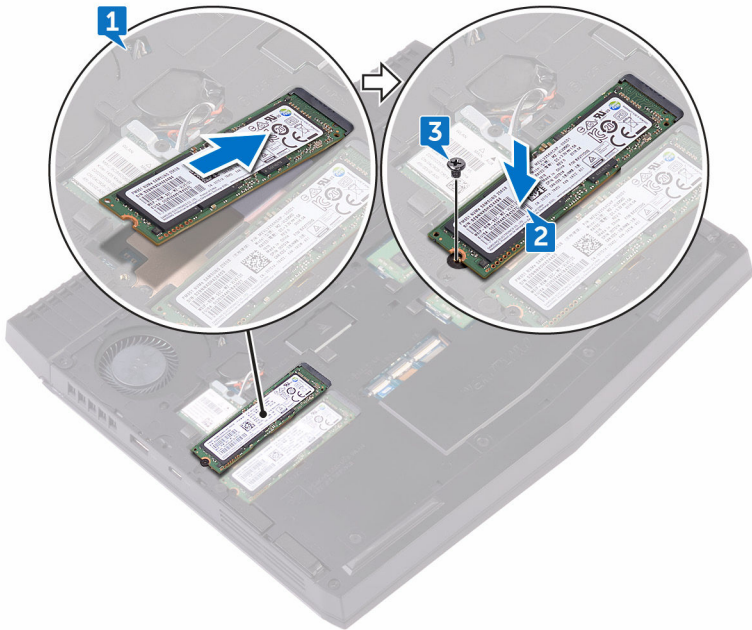

## Post-requisites

Replace the [base cover](#).

# Removing the memory modules

---

 **WARNING:** Before working inside your computer, read the safety information that shipped with your computer and follow the steps in [Before working inside your computer](#). After working inside your computer, follow the instructions in [After working inside your computer](#). For more safety best practices, see the Regulatory Compliance home page at [www.dell.com/regulatory\\_compliance](http://www.dell.com/regulatory_compliance).

## Prerequisites

Remove the [base cover](#).

## Procedure

- 1 Using your fingertips, carefully spread apart the securing clips on each end of the memory-module slot until the memory module pops up.

2 Slide and remove the memory module from the memory-module slot.

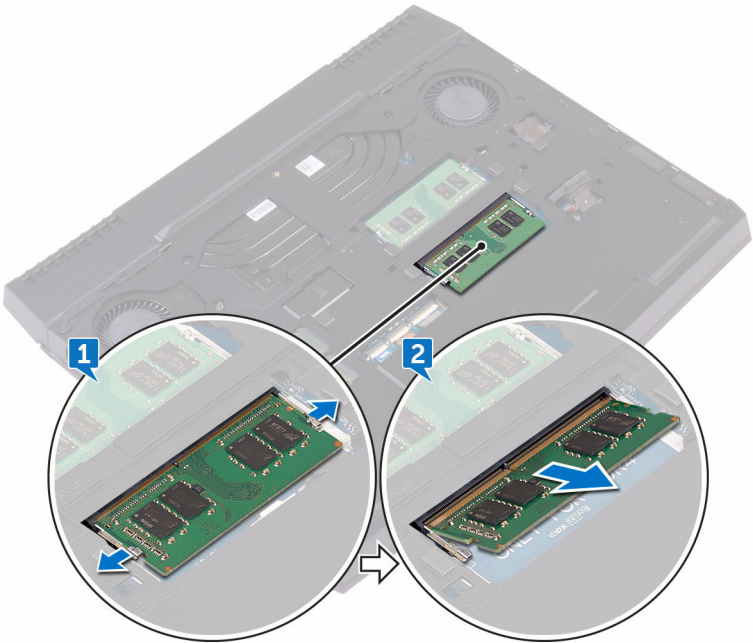

# Replacing the memory modules

---

 **WARNING:** Before working inside your computer, read the safety information that shipped with your computer and follow the steps in [Before working inside your computer](#). After working inside your computer, follow the instructions in [After working inside your computer](#). For more safety best practices, see the Regulatory Compliance home page at [www.dell.com/regulatory\\_compliance](http://www.dell.com/regulatory_compliance).

## Procedure

- 1 Align the notch on the memory module with the tab on the memory-module slot and slide the memory module firmly into the slot at an angle.

- 2 Press the memory module down until it clicks into place.

 **NOTE:** If you do not hear the click, remove the memory module and reinstall it.

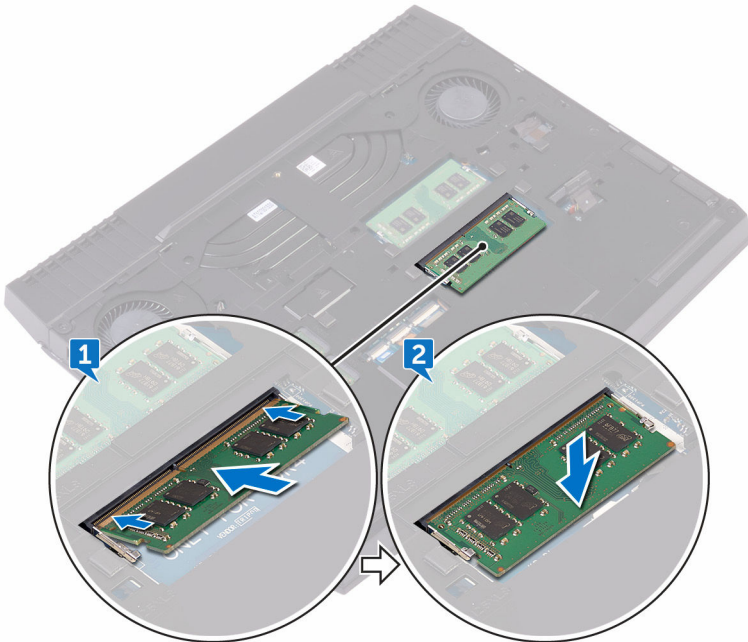

## Post-requisites

Replace the [base cover](#).

# Removing the rear-I/O cover

---

 **WARNING:** Before working inside your computer, read the safety information that shipped with your computer and follow the steps in [Before working inside your computer](#). After working inside your computer, follow the instructions in [After working inside your computer](#). For more safety best practices, see the Regulatory Compliance home page at [www.dell.com/regulatory\\_compliance](http://www.dell.com/regulatory_compliance).

## Prerequisites

Remove the [base cover](#).

## Procedure

- 1 Remove the two screws (M2.5x6L) that secure the rear-I/O cover to the palm-rest assembly.
- 2 Using a plastic scribe, gently release the tabs that secure rear-I/O cover to the computer base.

3 Slide and remove the rear-I/O cover from the computer base.

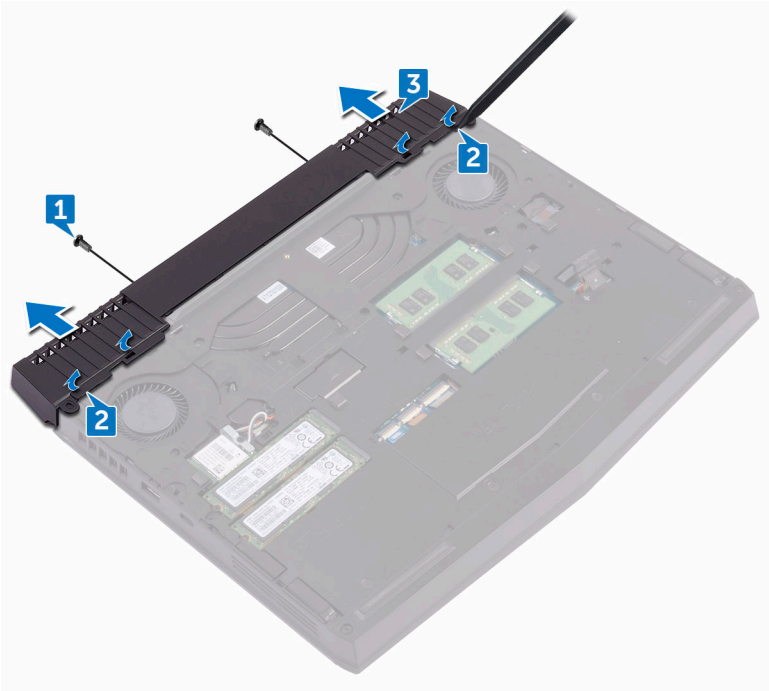

# Replacing the rear-I/O cover

---

 **WARNING:** Before working inside your computer, read the safety information that shipped with your computer and follow the steps in [Before working inside your computer](#). After working inside your computer, follow the instructions in [After working inside your computer](#). For more safety best practices, see the Regulatory Compliance home page at [www.dell.com/regulatory\\_compliance](http://www.dell.com/regulatory_compliance).

## Procedure

- 1 Slide the rear-I/O cover into the slots on the computer base and snap the rear-I/O cover into place.
- 2 Replace the two screws (M2.5x6L) that secure the rear-I/O cover to the palm-rest assembly.

## Post-requisites

Replace the [base cover](#).



# Removing the computer base

---

 **WARNING:** Before working inside your computer, read the safety information that shipped with your computer and follow the steps in [Before working inside your computer](#). After working inside your computer, follow the instructions in [After working inside your computer](#). For more safety best practices, see the Regulatory Compliance home page at [www.dell.com/regulatory\\_compliance](http://www.dell.com/regulatory_compliance).

## Prerequisites

- 1 Remove the [base cover](#).
- 2 Remove the [solid-state drive](#).
- 3 Remove the [wireless card](#).
- 4 Remove the [rear-I/O cover](#).

## Procedure

- 1 Remove the eleven (M2.5x6L) screws that secure the computer base to the palm-rest assembly.
- 2 Remove the (M2x3) screw that secures the computer base to the palm-rest assembly.

- 3** Remove the two (M2.5x6L) screws that secure the computer base to the palm-rest assembly.

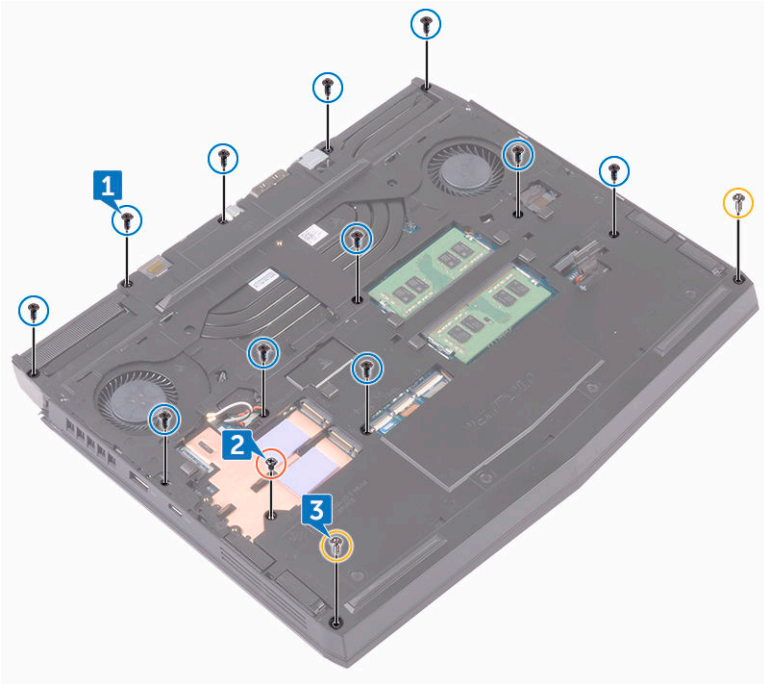

4 Lift the computer base from the palm-rest assembly.

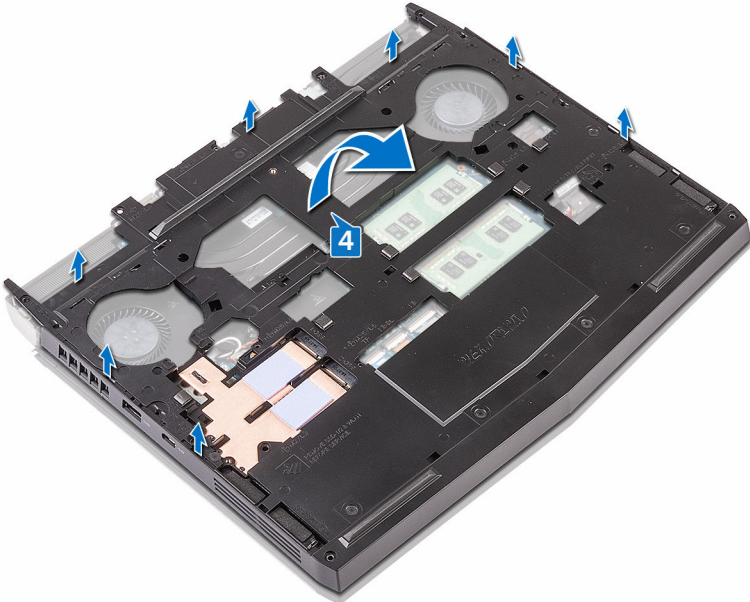

# Replacing the computer base

---

 **WARNING:** Before working inside your computer, read the safety information that shipped with your computer and follow the steps in [Before working inside your computer](#). After working inside your computer, follow the instructions in [After working inside your computer](#). For more safety best practices, see the Regulatory Compliance home page at [www.dell.com/regulatory\\_compliance](http://www.dell.com/regulatory_compliance).

## Procedure

- 1 Align the screw holes on the computer base with the screw holes on the palm-rest assembly.
- 2 Replace the two (M2.5x6L) screws that secure the computer base to the palm-rest assembly.
- 3 Replace the (M2x3) screw that secures the computer base to the palm-rest assembly.
- 4 Replace the eleven (M2.5x6L) screws that secure the computer base to the palm-rest assembly.

## Post-requisites

- 1 Replace the [rear-I/O cover](#).
- 2 Replace the [wireless card](#).
- 3 Replace the [solid-state drive](#).
- 4 Replace the [base cover](#).

# Removing the coin-cell battery

---

 **WARNING:** Before working inside your computer, read the safety information that shipped with your computer and follow the steps in [Before working inside your computer](#). After working inside your computer, follow the instructions in [After working inside your computer](#). For more safety best practices, see the Regulatory Compliance home page at [www.dell.com/regulatory\\_compliance](http://www.dell.com/regulatory_compliance).

 **CAUTION:** Removing the coin-cell battery resets the BIOS setup program's settings to default. It is recommended that you note the BIOS setup program's settings before removing the coin-cell battery.

## Prerequisites

- 1 Remove the [base cover](#).
- 2 Remove the [wireless card](#).
- 3 Remove the [solid-state drive](#).
- 4 Remove the [rear-I/O cover](#).
- 5 Remove the [computer base](#).

## Procedure

- 1 Disconnect the coin-cell battery cable from the system board.

- 
- 2 Gently peel off the coin-cell battery along with its cable off the palm-rest assembly.

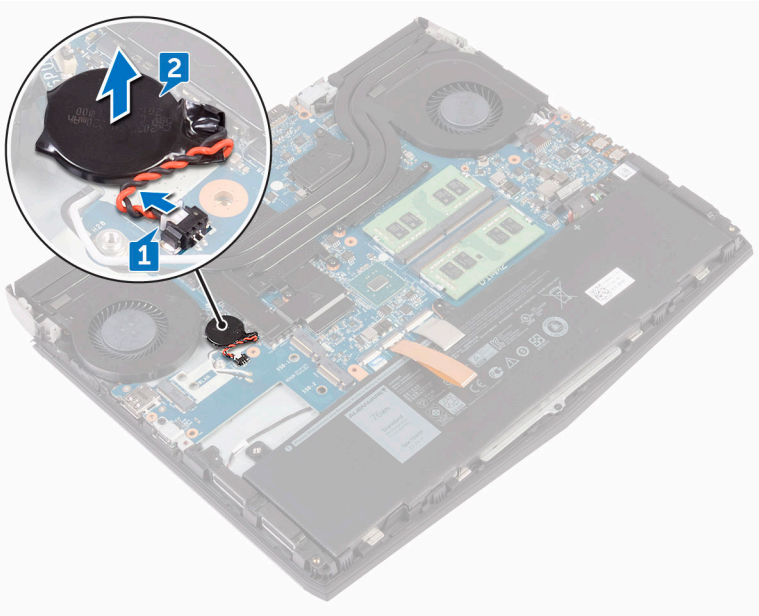

# Replacing the coin-cell battery

---

 **WARNING:** Before working inside your computer, read the safety information that shipped with your computer and follow the steps in [Before working inside your computer](#). After working inside your computer, follow the instructions in [After working inside your computer](#). For more safety best practices, see the Regulatory Compliance home page at [www.dell.com/regulatory\\_compliance](http://www.dell.com/regulatory_compliance).

## Procedure



- 1 Adhere the coin-cell battery to the palm-rest assembly.
- 2 Connect the coin-cell battery cable to the system board.

## Post-requisites

- 1 Replace the [computer base](#).
- 2 Replace the [rear-I/O cover](#).
- 3 Replace the [solid-state drive](#).
- 4 Replace the [wireless card](#).
- 5 Replace the [base cover](#).

# Removing the heat-sink assembly

---

-  **WARNING:** Before working inside your computer, read the safety information that shipped with your computer and follow the steps in [Before working inside your computer](#). After working inside your computer, follow the instructions in [After working inside your computer](#). For more safety best practices, see the Regulatory Compliance home page at [www.dell.com/regulatory\\_compliance](http://www.dell.com/regulatory_compliance).
-  **WARNING:** The heat sink may become hot during normal operation. Allow sufficient time for the heat sink to cool before you touch it.
-  **CAUTION:** For maximum cooling of the processor, do not touch the heat transfer areas on the heat sink. The oils in your skin can reduce the heat transfer capability of the thermal grease.

## Prerequisites

- 1 Remove the [base cover](#).
- 2 Remove the [wireless card](#).
- 3 Remove the [solid-state drive](#).
- 4 Remove the [rear-I/O cover](#).
- 5 Remove the [computer base](#).

## Procedure

- 1 Disconnect the left-fan cable from the system board.
- 2 Disconnect the right-fan cable from the system board.
- 3 In sequential order (as indicated on the heat-sink assembly), remove the seven screws (M2x3) that secure the heat-sink assembly to the system board.



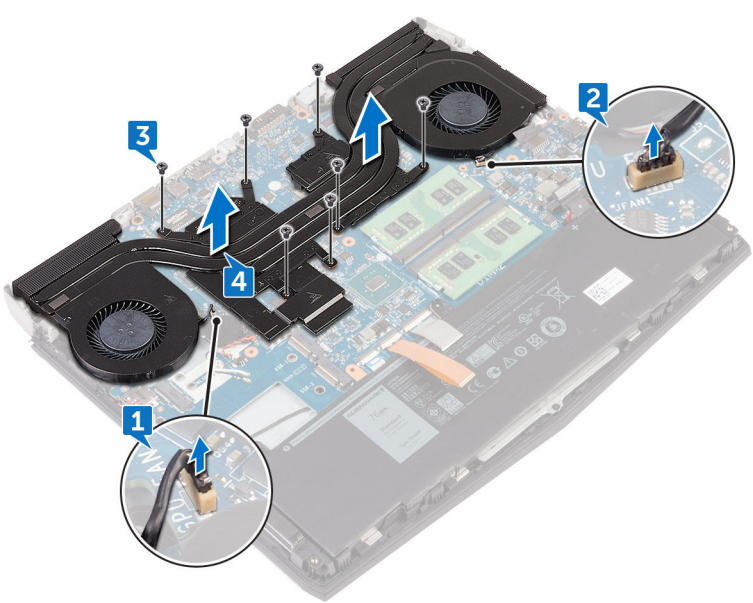

4 Lift the heat-sink assembly off the system board.



# Replacing the heat-sink assembly

---

-  **WARNING:** Before working inside your computer, read the safety information that shipped with your computer and follow the steps in [Before working inside your computer](#). After working inside your computer, follow the instructions in [After working inside your computer](#). For more safety best practices, see the Regulatory Compliance home page at [www.dell.com/regulatory\\_compliance](http://www.dell.com/regulatory_compliance).
-  **CAUTION:** Incorrect alignment of the heat sink can damage the system board and processor.
-  **NOTE:** The original thermal grease can be reused if the original system board and fan are reinstalled together. If either the system board or the fan is replaced, use the thermal pad provided in the kit to ensure that thermal conductivity is achieved.

## Procedure

- 1 Align the screw holes on the heat-sink assembly with the screw holes on the system board.
- 2 In sequential order (indicated on the heat-sink assembly), replace the seven screws (M2x3) that secure the heat-sink assembly to the system board.
- 3 Connect the right-fan cable to the respective connector on the system board.
- 4 Connect the left-fan cable to the respective connector on the system board.

## Post-requisites

- 1 Replace the [computer base](#).
- 2 Replace the [rear-I/O cover](#).
- 3 Replace the [solid-state drive](#).
- 4 Replace the [wireless card](#).
- 5 Replace the [base cover](#).

# Removing the battery

---



**WARNING:** Before working inside your computer, read the safety information that shipped with your computer and follow the steps in [Before working inside your computer](#). After working inside your computer, follow the instructions in [After working inside your computer](#). For more safety best practices, see the Regulatory Compliance home page at [www.dell.com/regulatory\\_compliance](http://www.dell.com/regulatory_compliance).

## Prerequisites

- 1 Remove the [base cover](#).
- 2 Remove the [wireless card](#).
- 3 Remove the [solid-state drive](#).
- 4 Remove the [rear-I/O cover](#).
- 5 Remove the [computer base](#).

## Procedure

- 1 Peel off the keyboard connector from the battery.

2 Lift the battery off the palm-rest assembly.

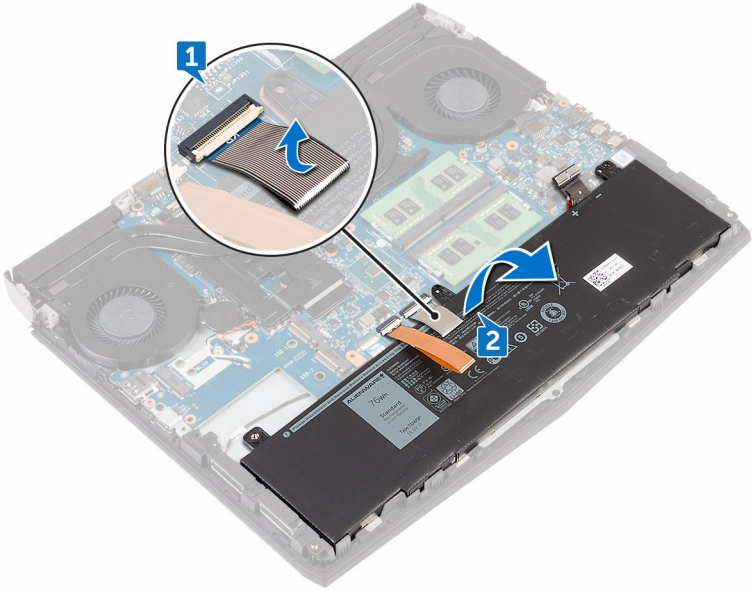

# Replacing the battery

---

 **WARNING:** Before working inside your computer, read the safety information that shipped with your computer and follow the steps in [Before working inside your computer](#). After working inside your computer, follow the instructions in [After working inside your computer](#). For more safety best practices, see the Regulatory Compliance home page at [www.dell.com/regulatory\\_compliance](http://www.dell.com/regulatory_compliance).

## Procedure

 **CAUTION:** Ensure the keyboard and keyboard-backlit cables are not under the battery.

- 1 Using the alignment post, place the battery on the palm-rest assembly.
- 2 Adhere the keyboard connector that secures the battery to the palm-rest assembly.

## Post-requisites

- 1 Replace the [computer base](#).
- 2 Replace the [rear-I/O cover](#).
- 3 Replace the [solid-state drive](#).
- 4 Replace the [wireless card](#).
- 5 Replace the [base cover](#).

# Removing the touch pad

---

 **WARNING:** Before working inside your computer, read the safety information that shipped with your computer and follow the steps in [Before working inside your computer](#). After working inside your computer, follow the instructions in [After working inside your computer](#). For more safety best practices, see the Regulatory Compliance home page at [www.dell.com/regulatory\\_compliance](http://www.dell.com/regulatory_compliance).

## Prerequisites

- 1 Remove the [base cover](#).
- 2 Remove the [wireless card](#).
- 3 Remove the [solid-state drive](#).
- 4 Remove the [rear-I/O cover](#).
- 5 Remove the [computer base](#).
- 6 Remove the [battery](#).

## Procedure

- 1 Open the latches and disconnect the touch-pad cable from the system board and touch pad.

- 2 Peel off the touch-pad cable from the touch-pad bracket.

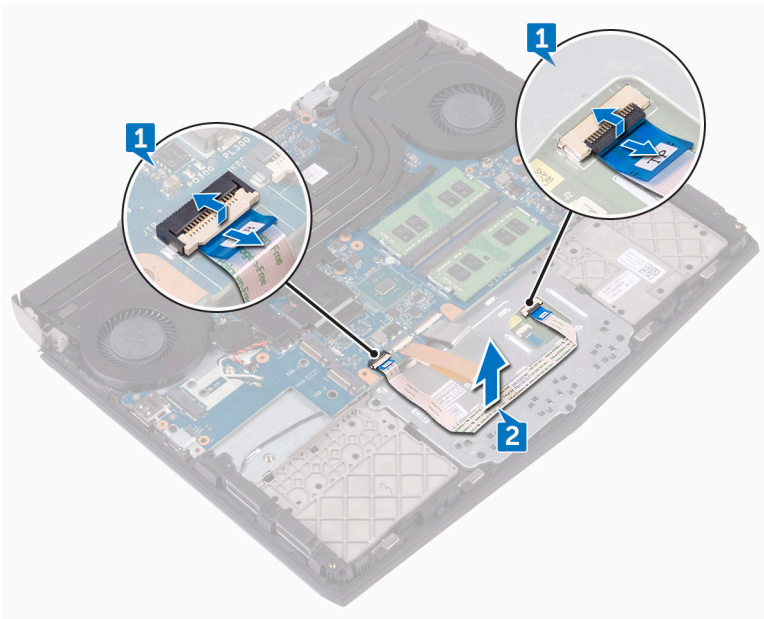

- 3 Open the latch and disconnect the touch-pad buttons cable from the touch pad.
- 4 Remove the five screws (M2x3) that secure the touch-pad bracket to the palm-rest assembly.

5 Using a plastic scribe, lift the touch-pad bracket off the palm-rest assembly.

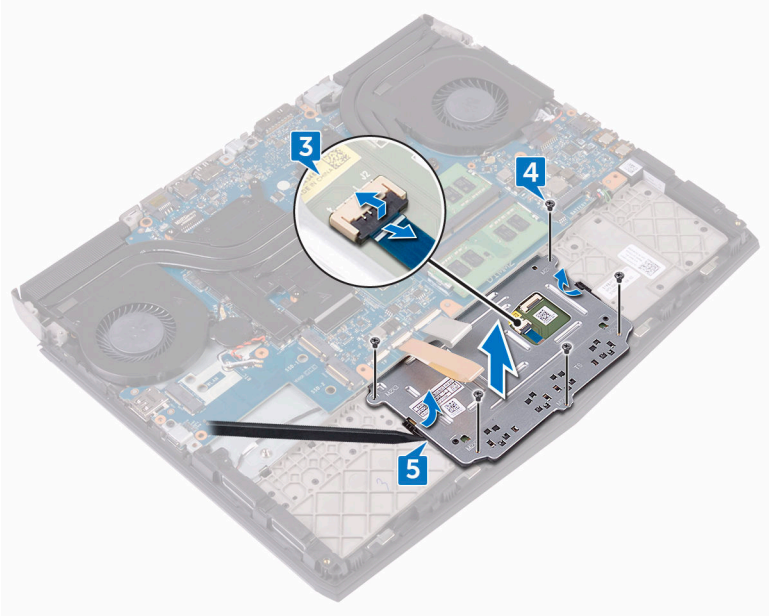



6 Lift the touch pad off the palm-rest assembly.

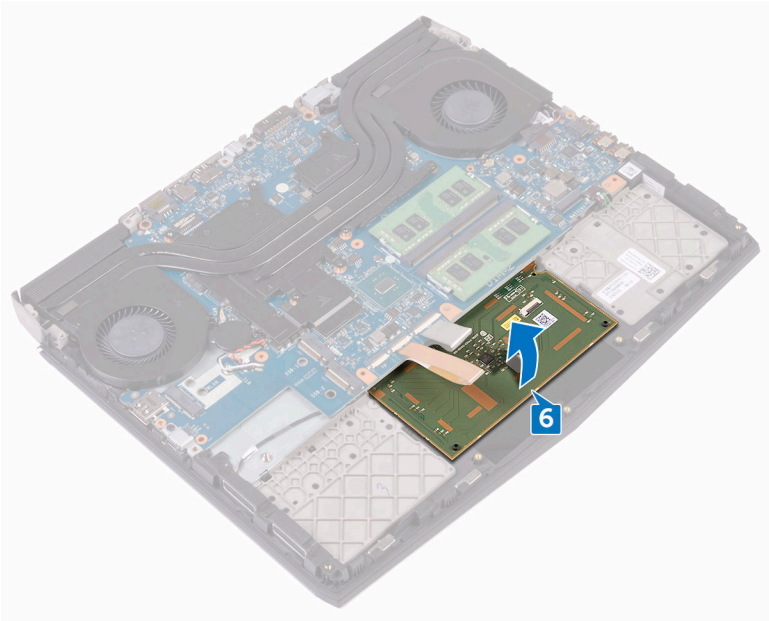

# Replacing the touch pad

---

 **WARNING:** Before working inside your computer, read the safety information that shipped with your computer and follow the steps in [Before working inside your computer](#). After working inside your computer, follow the instructions in [After working inside your computer](#). For more safety best practices, see the Regulatory Compliance home page at [www.dell.com/regulatory\\_compliance](http://www.dell.com/regulatory_compliance).

## Procedure

 **CAUTION:** Ensure the keyboard and keyboard-backlit cables are not under the touch pad.





- 1 Using the alignment posts on the palm-rest assembly, place the touch pad on the palm-rest assembly.
- 2 Align the screw holes on the touch-pad bracket with the screw holes on the palm-rest assembly.
- 3 Replace the five screws (M2x3) that secure the touch-pad bracket to the palm-rest assembly.
- 4 Slide the touch-pad buttons cable into the respective connector on the touch pad and close the latch to secure the cable.
- 5 Slide the touch-pad cables into their respective connectors on the system board and touch pad, and close the latches to secure the cable.

## Post-requisites

- 1 Replace the [battery](#).
- 2 Replace the [computer base](#).
- 3 Replace the [rear-I/O cover](#).
- 4 Replace the [solid-state drive](#).
- 5 Replace the [wireless card](#).
- 6 Replace the [base cover](#).

# Removing the system board

---

-  **WARNING:** Before working inside your computer, read the safety information that shipped with your computer and follow the steps in [Before working inside your computer](#). After working inside your computer, follow the instructions in [After working inside your computer](#). For more safety best practices, see the Regulatory Compliance home page at [www.dell.com/regulatory\\_compliance](http://www.dell.com/regulatory_compliance).
-  **NOTE:** Your computer's Service Tag is stored in the system board. You must enter the Service Tag in the BIOS setup program after you replace the system board.
-  **NOTE:** Replacing the system board removes any changes you have made to the BIOS using the BIOS setup program. You must make the appropriate changes again after you replace the system board.
-  **NOTE:** Before disconnecting the cables from the system board, note the location of the connectors so that you can reconnect the cables correctly after you replace the system board.

## Prerequisites

- 1 Remove the [base cover](#).
- 2 Remove the [wireless card](#).
- 3 Remove the [solid-state drive](#).
- 4 Remove the [memory modules](#).
- 5 Remove the [rear-I/O cover](#).
- 6 Remove the [computer base](#).
- 7 Remove the [coin-cell battery](#).
- 8 Remove the [battery](#).
- 9 Remove the [heat-sink assembly](#).

# Procedure

**△ CAUTION: Place the computer on a clean, flat surface.**

- 1 Turn the computer over.
- 2 Disconnect the logo-board cable from the system board.
- 3 Using the pull-tab, disconnect the power-button board cable from the system board.
- 4 Open the latch and disconnect the display cable from the system board.

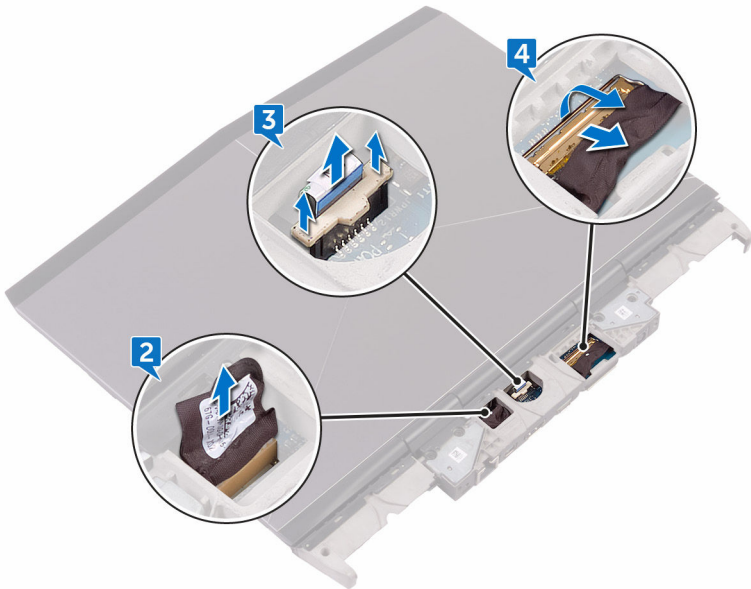

- 5 Turn the computer over.
- 6 Remove the screw (M2.5x6L) that secures the USB Type-C port bracket to the system board and lift the USB Type-C port bracket off the system board.
- 7 Disconnect the power-adapter port cable from the system board.
- 8 Disconnect the speaker cable from the system board.
- 9 Open the latch and disconnect the keyboard cable from the system board.
- 10 Open the latch and disconnect the keyboard-backlight cable from the system board.

- 11 Open the latch and disconnect the touch-pad cable from the system board.
- 12 Remove the screw (M2.5x6L) that secures the USB Type-C port bracket to the system board and lift the USB Type-C port bracket off the system board.

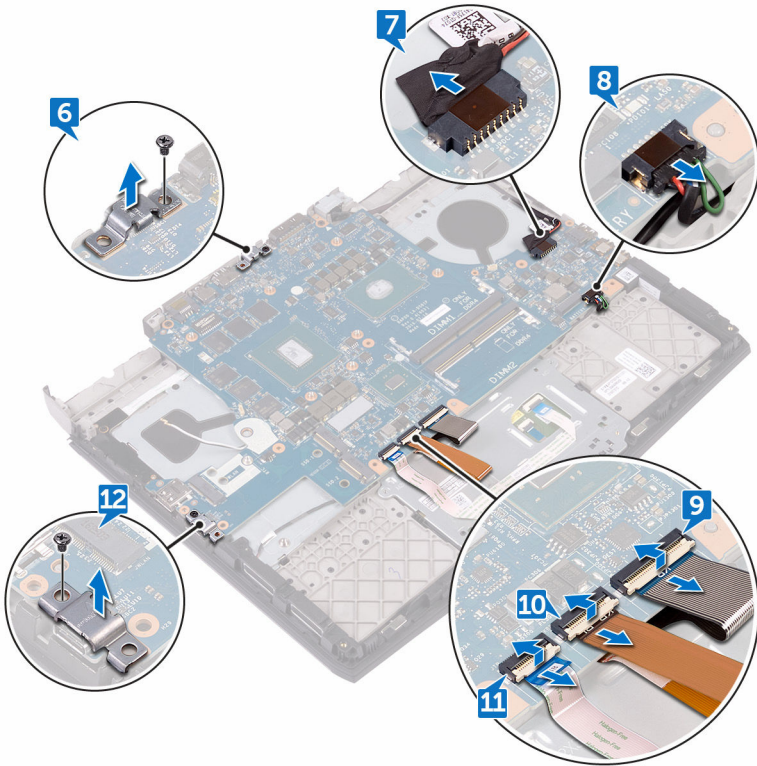

- 13 Remove the two screws (M2.5x6L) that secure the system board to the palm-rest assembly.

14 Lift the system board off the palm-rest assembly.

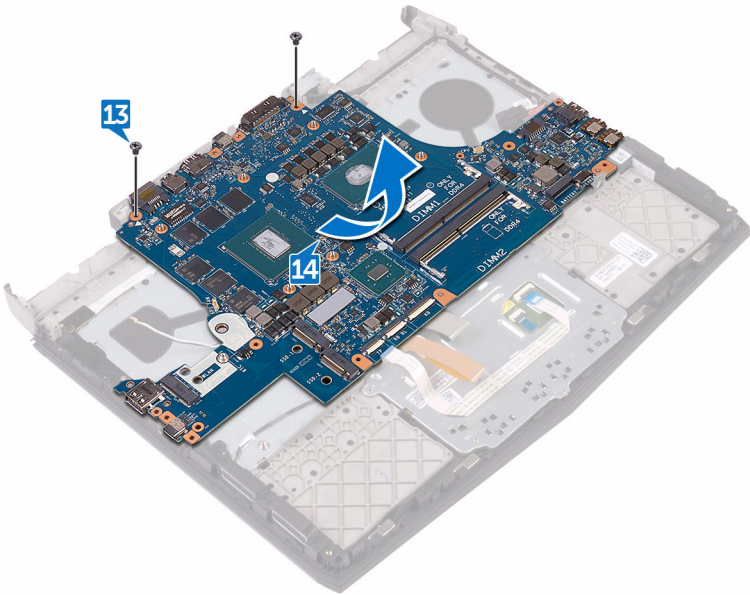

# Replacing the system board

---

 **WARNING:** Before working inside your computer, read the safety information that shipped with your computer and follow the steps in [Before working inside your computer](#). After working inside your computer, follow the instructions in [After working inside your computer](#). For more safety best practices, see the Regulatory Compliance home page at [www.dell.com/regulatory\\_compliance](http://www.dell.com/regulatory_compliance).

 **NOTE:** Your computer's Service Tag is stored in the system board. You must enter the Service Tag in the BIOS setup program after you replace the system board.

 **NOTE:** Replacing the system board removes any changes you have made to the BIOS using the BIOS setup program. You must make the appropriate changes again after you replace the system board.

## Procedure

 **CAUTION:** Ensure that no cables are under the system board.

- 1 Align the screw holes on the system board with the screw holes on the palm-rest assembly.
- 2 Replace the two screws (M2.5x6L) that secure the system-board to the palm-rest assembly.
- 3 Align the screw hole on the USB Type-C port bracket with the screw hole on the system board on the back and right side of your computer.
- 4 Replace the screw (M2.5x6L) that secures the USB Type-C port bracket to the system board on the back and right side of your computer.
- 5 Slide the touch-pad cable into the connector on the system board and close the latch to secure the cable.
- 6 Slide the keyboard-backlight cable into the connector on the system board and close the latch to secure the cable.
- 7 Slide the keyboard cable into the connector on the system board and close the latch to secure the cable.
- 8 Connect the speaker cable to the system board.
- 9 Connect the power-adaptor port cable to the system board.

- 10 Turn the computer over.
- 11 Slide the display cable into the connector on the system board and close the latch to secure the cable.
- 12 Connect the power-button board cable to the system board.
- 13 Connect the logo-board cable to the system board.

## Post-requisites

- 1 Replace the [heat-sink assembly](#).
- 2 Replace the [battery](#).
- 3 Replace the [coin-cell battery](#).
- 4 Replace the [computer base](#).
- 5 Replace the [rear-I/O cover](#).
- 6 Replace the [memory modules](#).
- 7 Replace the [solid-state drive](#).
- 8 Replace the [wireless card](#).
- 9 Replace the [base cover](#).



# Removing the speakers

---

 **WARNING:** Before working inside your computer, read the safety information that shipped with your computer and follow the steps in [Before working inside your computer](#). After working inside your computer, follow the instructions in [After working inside your computer](#). For more safety best practices, see the Regulatory Compliance home page at [www.dell.com/regulatory\\_compliance](http://www.dell.com/regulatory_compliance).

## Prerequisites

- 1 Remove the [base cover](#).
- 2 Remove the [wireless card](#).
- 3 Remove the [solid-state drive](#).
- 4 Remove the [memory modules](#).
- 5 Remove the [rear-I/O cover](#).
- 6 Remove the [computer base](#).
- 7 Remove the [coin-cell battery](#).
- 8 Remove the [battery](#).
- 9 Remove the [heat-sink assembly](#).
- 10 Remove the [system board](#).

## Procedure

- 1 Remove the screw (M2x3) that secures the speaker to the palm-rest assembly.
- 2 Lift the left speaker off the palm-rest assembly.
- 3 Peel off the tape that secures the speaker cable to the palm-rest assembly.
- 4 Remove the speaker cable from the routing guides on the palm-rest assembly.

5 Lift the right speaker off the palm-rest assembly.

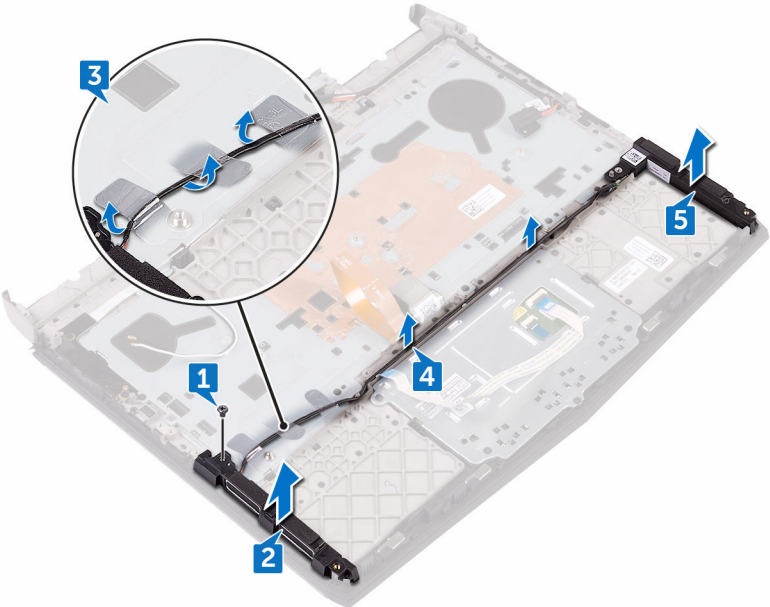

# Replacing the speakers

---

 **WARNING:** Before working inside your computer, read the safety information that shipped with your computer and follow the steps in [Before working inside your computer](#). After working inside your computer, follow the instructions in [After working inside your computer](#). For more safety best practices, see the Regulatory Compliance home page at [www.dell.com/regulatory\\_compliance](http://www.dell.com/regulatory_compliance).

## Procedure

- 1 Using the alignment posts, place the right speaker on the palm-rest assembly.
- 2 Route the speaker cable through the routing guides on palm-rest assembly.



**NOTE:** Move the keyboard and keyboard-backlit cables out of the way.

- 3 Using the alignment posts, place the left speaker on the palm-rest assembly.
- 4 Adhere the tape that secures the speaker cable to the palm-rest assembly.
- 5 Replace the screw (M2x3) that secures the speaker to the palm-rest assembly.

## Post-requisites

- 1 Replace the [system board](#).
- 2 Replace the [heat-sink assembly](#).
- 3 Replace the [battery](#).
- 4 Replace the [coin-cell battery](#).
- 5 Replace the [computer base](#).
- 6 Replace the [rear-I/O cover](#).
- 7 Replace the [memory modules](#).
- 8 Replace the [solid-state drive](#).
- 9 Replace the [wireless card](#).
- 10 Replace the [base cover](#).

# Removing the power-adapter port

---



**WARNING:** Before working inside your computer, read the safety information that shipped with your computer and follow the steps in [Before working inside your computer](#). After working inside your computer, follow the instructions in [After working inside your computer](#). For more safety best practices, see the Regulatory Compliance home page at [www.dell.com/regulatory\\_compliance](http://www.dell.com/regulatory_compliance).

## Prerequisites

- 1 Remove the [base cover](#).
- 2 Remove the [wireless card](#).
- 3 Remove the [memory modules](#).
- 4 Remove the [solid-state drive](#).
- 5 Remove the [rear-I/O cover](#).
- 6 Remove the [computer base](#).
- 7 Remove the [coin-cell battery](#).
- 8 Remove the [heat-sink assembly](#).
- 9 Remove the [battery](#).
- 10 Remove the [system board](#).

## Procedure

- 1 Lift the power-adapter port bracket off the power-adapter port.
- 2 Lift the power-adapter port off the palm-rest assembly.

3 Remove the cable from the routing guides on the palm-rest assembly.

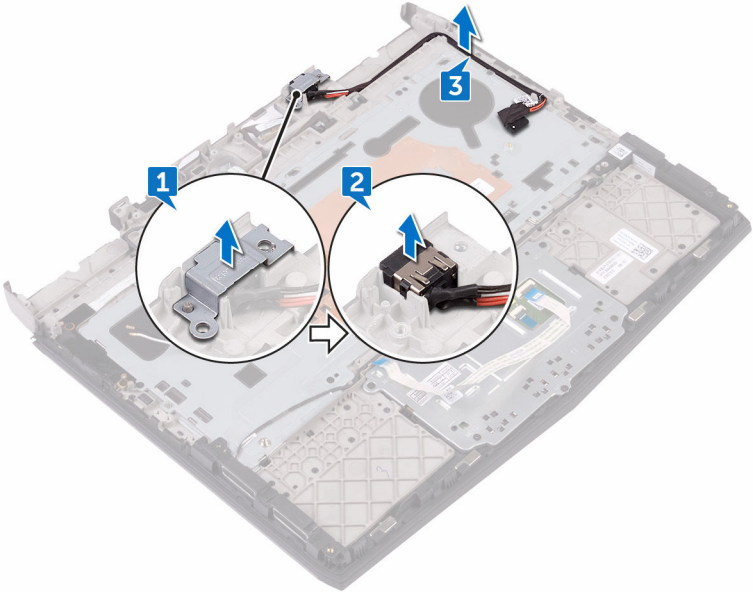

# Replacing the power-adapter port

---

 **WARNING:** Before working inside your computer, read the safety information that shipped with your computer and follow the steps in [Before working inside your computer](#). After working inside your computer, follow the instructions in [After working inside your computer](#). For more safety best practices, see the Regulatory Compliance home page at [www.dell.com/regulatory\\_compliance](http://www.dell.com/regulatory_compliance).

## Procedure

- 1 Slide the power-adapter port into the slot on the palm-rest assembly.
- 2 Place the power-adapter port bracket on the power-adapter port.
- 3 Route the power-adapter port cable through the routing guides on the palm-rest assembly.

## Post-requisites

- 1 Replace the [system board](#).
- 2 Replace the [battery](#).
- 3 Replace the [heat-sink assembly](#).
- 4 Replace the [coin-cell battery](#).
- 5 Replace the [computer base](#).
- 6 Replace the [rear-I/O cover](#).
- 7 Replace the [solid-state drive](#).
- 8 Replace the [memory modules](#).
- 9 Replace the [wireless card](#).
- 10 Replace the [base cover](#).

# Removing the power-button board

---

 **WARNING:** Before working inside your computer, read the safety information that shipped with your computer and follow the steps in [Before working inside your computer](#). After working inside your computer, follow the instructions in [After working inside your computer](#). For more safety best practices, see the Regulatory Compliance home page at [www.dell.com/regulatory\\_compliance](http://www.dell.com/regulatory_compliance).

## Prerequisites

- 1 Remove the [base cover](#).
- 2 Remove the [wireless card](#).
- 3 Remove the [memory modules](#).
- 4 Remove the [solid-state drive](#).
- 5 Remove the [rear-I/O cover](#).
- 6 Remove the [computer base](#).
- 7 Remove the [coin-cell battery](#).
- 8 Remove the [heat-sink assembly](#).
- 9 Remove the [battery](#).
- 10 Remove the [system board](#).

## Procedure

- 1 Remove the two screws (M2x3) that secure the power-button board to the palm-rest assembly.
- 2 Lift the power-button board, along with its cable, off the palm-rest assembly.

3 Peel the power-button board cable from the palm-rest assembly.

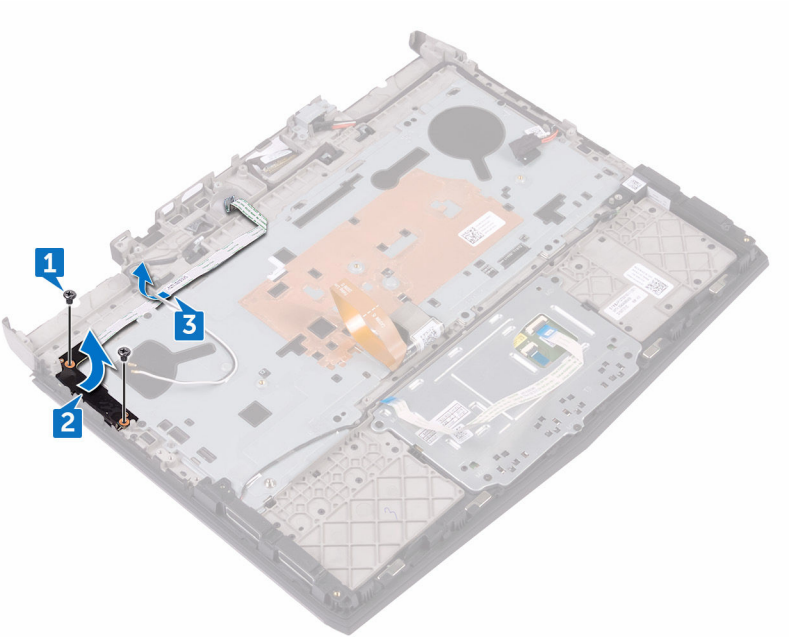



# Replacing the power-button board

---

 **WARNING:** Before working inside your computer, read the safety information that shipped with your computer and follow the steps in [Before working inside your computer](#). After working inside your computer, follow the instructions in [After working inside your computer](#). For more safety best practices, see the Regulatory Compliance home page at [www.dell.com/regulatory\\_compliance](http://www.dell.com/regulatory_compliance).

## Procedure

- 1 Using the alignment posts, place the power-button board on the palm-rest assembly.
- 2 Adhere the power-button board cable to the palm-rest assembly.
- 3 Align the screw holes on the power-button board with the screw holes on the palm-rest assembly.
- 4 Replace the two screws (M2x3) that secure the power-button board to the palm-rest assembly.

## Post-requisites

- 1 Replace the [system board](#).
- 2 Replace the [battery](#).
- 3 Replace the [heat-sink assembly](#).
- 4 Replace the [coin-cell battery](#).
- 5 Replace the [computer base](#).
- 6 Replace the [rear-I/O cover](#).
- 7 Replace the [solid-state drive](#).
- 8 Replace the [memory modules](#).
- 9 Replace the [wireless card](#).
- 10 Replace the [base cover](#).

# Removing the keyboard

---



**WARNING:** Before working inside your computer, read the safety information that shipped with your computer and follow the steps in [Before working inside your computer](#). After working inside your computer, follow the instructions in [After working inside your computer](#). For more safety best practices, see the Regulatory Compliance home page at [www.dell.com/regulatory\\_compliance](http://www.dell.com/regulatory_compliance).

## Prerequisites

- 1 Remove the [base cover](#).
- 2 Remove the [wireless card](#).
- 3 Remove the [solid-state drive](#).
- 4 Remove the [memory modules](#).
- 5 Remove the [rear-I/O cover](#).
- 6 Remove the [computer base](#).
- 7 Remove the [coin-cell battery](#).
- 8 Remove the [heat-sink assembly](#).
- 9 Remove the [battery](#).
- 10 Remove the [system board](#).
- 11 Remove the [speakers](#).
- 12 Remove the [power-button board](#).

## Procedure

- 1 Remove the eight screws (M2x3) that secure the keyboard bracket to the palm-rest assembly.
- 2 Using a plastic scribe, pry the keyboard bracket off the palm-rest assembly.

3 Lift the keyboard bracket off the palm-rest assembly.

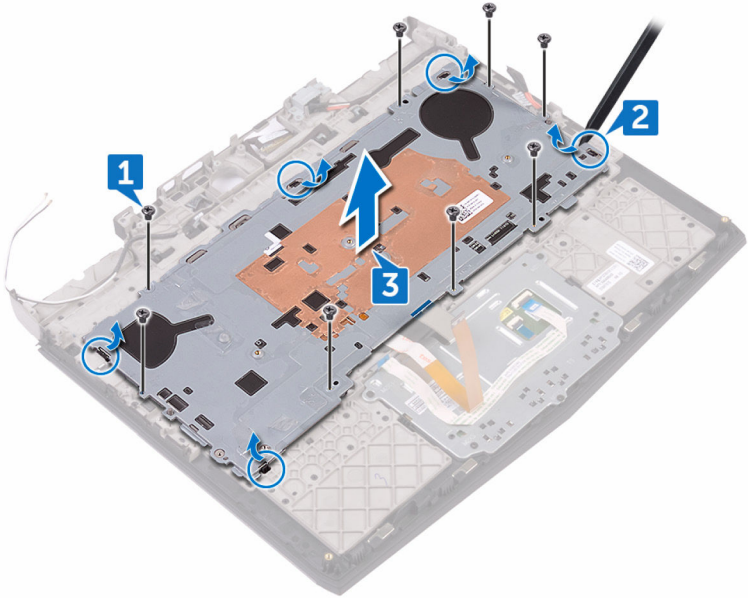

- 4 Lift the keyboard at an angle and remove it from the tabs on the palm-rest assembly.

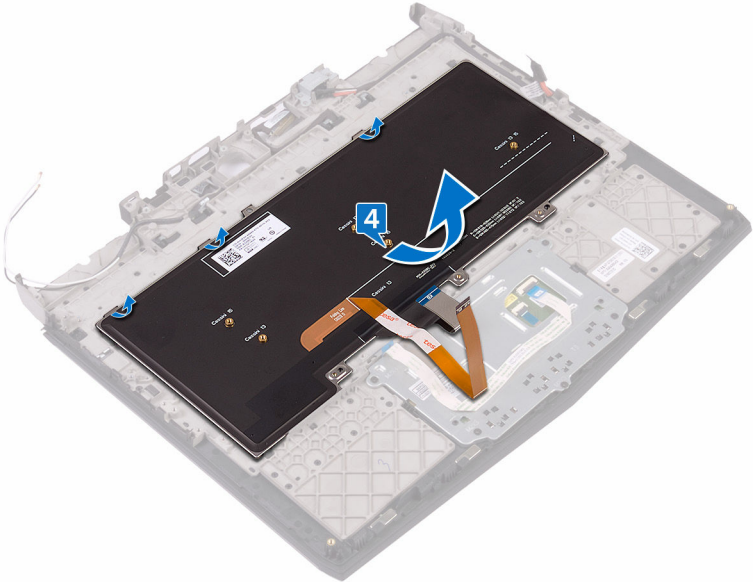

# Replacing the keyboard

---

 **WARNING:** Before working inside your computer, read the safety information that shipped with your computer and follow the steps in [Before working inside your computer](#). After working inside your computer, follow the instructions in [After working inside your computer](#). For more safety best practices, see the Regulatory Compliance home page at [www.dell.com/regulatory\\_compliance](http://www.dell.com/regulatory_compliance).

## Procedure

 **CAUTION:** To avoid damaging the keyboard, do not place any cables under it.

- 1 Insert the tabs on the keyboard into the slots on the palm-rest assembly.
- 2 Align the tabs on the palm-rest assembly to the slots on the keyboard bracket and snap into place.
- 3 Align the screw holes on the keyboard bracket with the screw holes on the palm-rest assembly.
- 4 Replace the eight screws (M2x3) that secure the keyboard bracket to the palm-rest assembly.

## Post-requisites

- 1 Replace the [power-button board](#).
- 2 Replace the [speakers](#).
- 3 Replace the [system board](#).
- 4 Replace the [battery](#).
- 5 Replace the [heat-sink assembly](#).
- 6 Replace the [coin-cell battery](#).
- 7 Replace the [computer base](#).
- 8 Replace the [rear-I/O cover](#).
- 9 Replace the [memory modules](#).
- 10 Replace the [solid-state drive](#).

- 11 Replace the [wireless card](#).
- 12 Replace the [base cover](#).

# Removing the display assembly

---

 **WARNING:** Before working inside your computer, read the safety information that shipped with your computer and follow the steps in [Before working inside your computer](#). After working inside your computer, follow the instructions in [After working inside your computer](#). For more safety best practices, see the Regulatory Compliance home page at [www.dell.com/regulatory\\_compliance](http://www.dell.com/regulatory_compliance).

## Prerequisites

- 1 Remove the [base cover](#).
- 2 Remove the [wireless card](#).
- 3 Remove the [solid-state drive](#).
- 4 Remove the [memory modules](#).
- 5 Remove the [rear-I/O cover](#).
- 6 Remove the [computer base](#).
- 7 Remove the [coin-cell battery](#).
- 8 Remove the [heat-sink assembly](#).
- 9 Remove the [battery](#).
- 10 Remove the [system board](#).

## Procedure

- 1 Remove the antenna cables from the routing guides on the palm-rest assembly.
- 2 Remove the logo-board cable from the routing guides on the palm-rest assembly.

- 3 Remove the display cable from the routing guides on the palm-rest assembly.

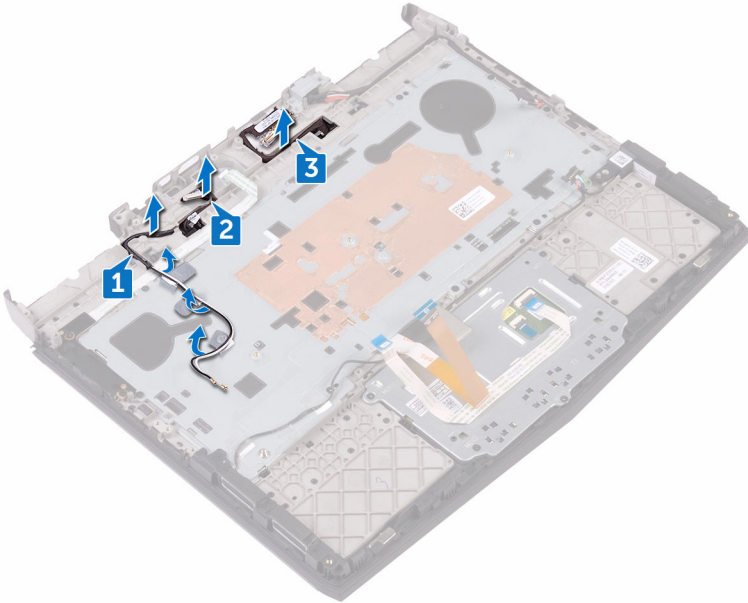

**⚠ CAUTION: Place the computer on a clean, flat surface.**

- 4 Turn the computer over.
- 5 Remove the four screws (M2.5x6L) that secure the display assembly to the palm-rest assembly.
- 6 Lift the display assembly off the palm-rest assembly.



- 7** Remove the cables from the routing holes on the palm-rest assembly.

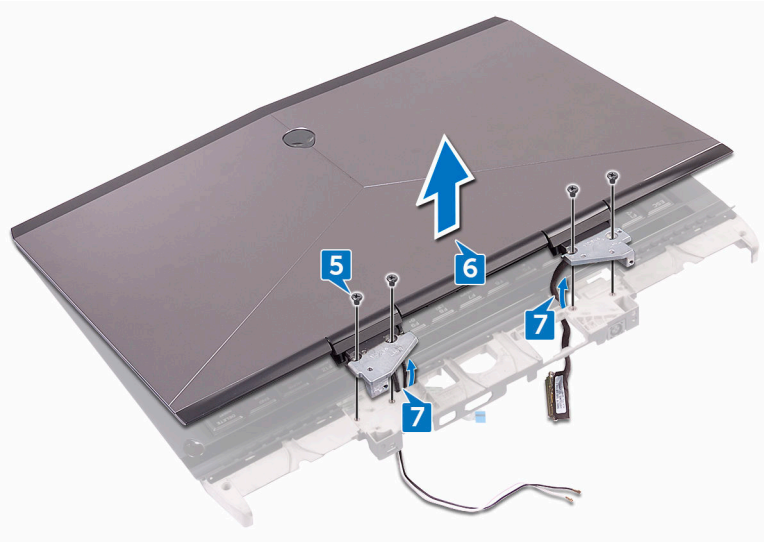

- 8** Place the display assembly on a clean, flat surface.



# Replacing the display assembly

---

 **WARNING:** Before working inside your computer, read the safety information that shipped with your computer and follow the steps in [Before working inside your computer](#). After working inside your computer, follow the instructions in [After working inside your computer](#). For more safety best practices, see the Regulatory Compliance home page at [www.dell.com/regulatory\\_compliance](http://www.dell.com/regulatory_compliance).

## Procedure

- 1 Route the cables through the routing holes on the palm-rest assembly.
- 2 Align the screw holes on the display hinges with the screw holes on the palm-rest assembly.
- 3 Replace the four screws (M2.5x6L) that secure the display assembly to the palm-rest assembly.
- 4 Turn the computer over.
- 5 Route the display cable through the routing guides on the palm-rest assembly.
- 6 Route the logo-board cable through the routing guides on the palm-rest assembly.
- 7 Route the antenna cables through the routing guides on the palm-rest assembly.

## Post-requisites

- 1 Replace the [system board](#).
- 2 Replace the [battery](#).
- 3 Replace the [heat-sink assembly](#).
- 4 Replace the [coin-cell battery](#).
- 5 Replace the [computer base](#).
- 6 Replace the [rear-I/O cover](#).
- 7 Replace the [memory modules](#).
- 8 Replace the [solid-state drive](#).

- 9 Replace the [wireless card](#).
- 10 Replace the [base cover](#).

# Removing the palm rest

---

 **WARNING:** Before working inside your computer, read the safety information that shipped with your computer and follow the steps in [Before working inside your computer](#). After working inside your computer, follow the instructions in [After working inside your computer](#). For more safety best practices, see the Regulatory Compliance home page at [www.dell.com/regulatory\\_compliance](http://www.dell.com/regulatory_compliance).

## Prerequisites

- 1 Remove the [base cover](#).
- 2 Remove the [wireless card](#).
- 3 Remove the [solid-state drive](#).
- 4 Remove the [memory modules](#).
- 5 Remove the [rear-I/O cover](#).
- 6 Remove the [computer base](#).
- 7 Remove the [coin-cell battery](#).
- 8 Remove the [heat-sink assembly](#).
- 9 Remove the [battery](#).
- 10 Remove the [system board](#).
- 11 Remove the [speakers](#).
- 12 Remove the [touch pad](#).
- 13 Remove the [display assembly](#).
- 14 Remove the [keyboard](#).
- 15 Remove the [power-adapter port](#).
- 16 Remove the [power-button board](#).

## Procedure

After performing all the prerequisites, we are left with the palm rest.

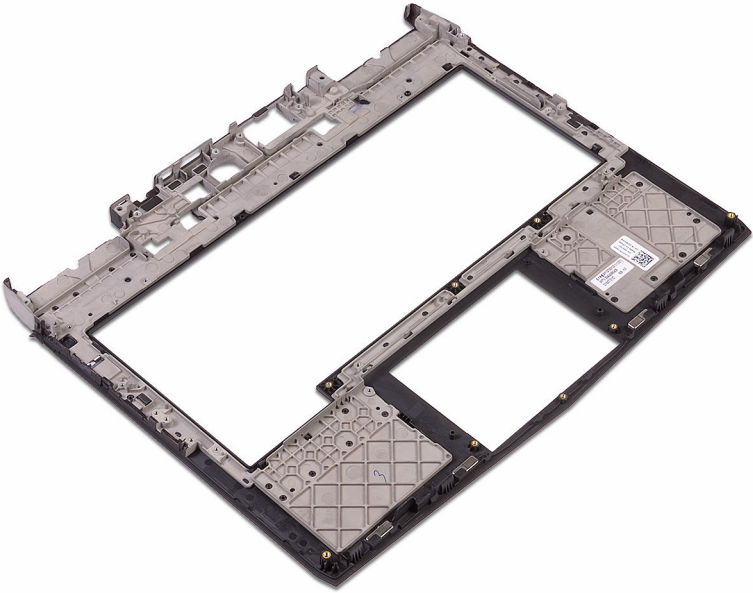

# Replacing the palm rest

---

 **WARNING:** Before working inside your computer, read the safety information that shipped with your computer and follow the steps in [Before working inside your computer](#). After working inside your computer, follow the instructions in [After working inside your computer](#). For more safety best practices, see the Regulatory Compliance home page at [www.dell.com/regulatory\\_compliance](http://www.dell.com/regulatory_compliance).

## Procedure

Place the palm rest on a flat surface.

## Post-requisites

- 1 Replace the [power-button board](#).
- 2 Replace the [power-adapter port](#).
- 3 Replace the [keyboard](#).
- 4 Replace the [display assembly](#).
- 5 Replace the [touch pad](#).
- 6 Replace the [speakers](#).
- 7 Replace the [system board](#).
- 8 Replace the [battery](#).
- 9 Replace the [heat-sink assembly](#).
- 10 Replace the [coin-cell battery](#).
- 11 Replace the [computer base](#).
- 12 Replace the [rear-I/O cover](#).
- 13 Replace the [memory modules](#).
- 14 Replace the [solid-state drive](#).
- 15 Replace the [wireless card](#).
- 16 Replace the [base cover](#).

# Removing the display bezel

---

 **WARNING:** Before working inside your computer, read the safety information that shipped with your computer and follow the steps in [Before working inside your computer](#). After working inside your computer, follow the instructions in [After working inside your computer](#). For more safety best practices, see the Regulatory Compliance home page at [www.dell.com/regulatory\\_compliance](http://www.dell.com/regulatory_compliance).

## Prerequisites

 **NOTE:** These instructions are applicable only for laptops with a non-touch screen display.

- 1 Remove the [base cover](#).
- 2 Remove the [wireless card](#).
- 3 Remove the [solid-state drive](#).
- 4 Remove the [memory modules](#).
- 5 Remove the [rear-I/O cover](#).
- 6 Remove the [computer base](#).
- 7 Remove the [coin-cell battery](#).
- 8 Remove the [battery](#).
- 9 Remove the [heat-sink assembly](#).
- 10 Remove the [system board](#).
- 11 Remove the [display assembly](#).

## Procedure

- 1 Using your fingertips, carefully pry up the inside edges of the display bezel.

- 2 Carefully lift the display bezel and turn it over.

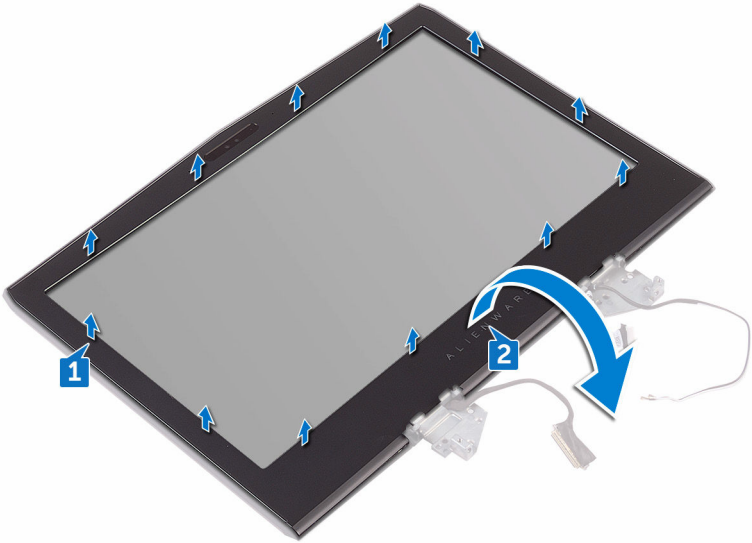

- 3 Open the latch and disconnect the alien head logo-board cable from the logo board.
- 4 Peel off the tape that secures the logo-board cable to the logo board and disconnect the logo-board cable from the logo board.



5 Lift the display bezel off the display assembly.

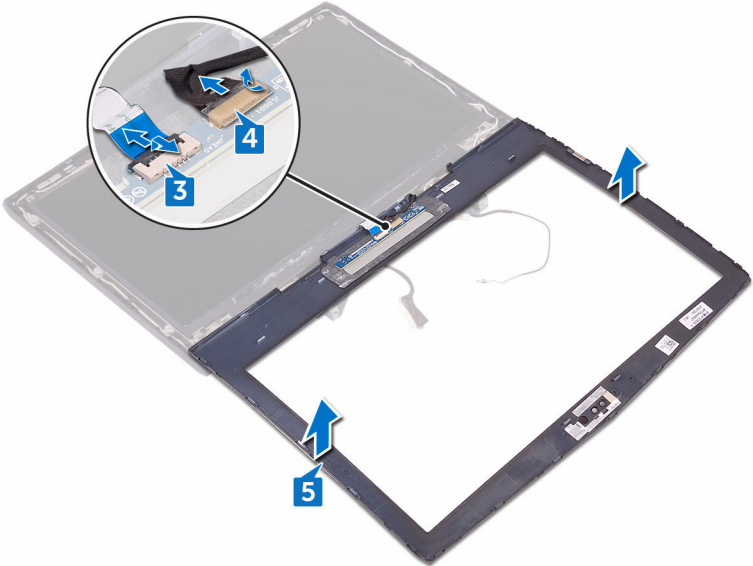

# Replacing the display bezel

---

 **WARNING:** Before working inside your computer, read the safety information that shipped with your computer and follow the steps in [Before working inside your computer](#). After working inside your computer, follow the instructions in [After working inside your computer](#). For more safety best practices, see the Regulatory Compliance home page at [www.dell.com/regulatory\\_compliance](http://www.dell.com/regulatory_compliance).

## Procedure

- 1 Place the display assembly on a clean and flat surface.
- 2 Connect the logo-board cable to the logo board.
- 3 Adhere the tape that secures the logo-board cable to the logo board.
- 4 Slide the alien head logo-board cable into the logo board and close the latch to secure the cable.
- 5 Carefully turn the display bezel over.
- 6 Align the display bezel with the display back-cover and antenna assembly and gently snap the display bezel into place.

## Post-requisites

- 1 Replace the [display assembly](#).
- 2 Replace the [system board](#).
- 3 Replace the [heat-sink assembly](#).
- 4 Replace the [battery](#).
- 5 Replace the [coin-cell battery](#).
- 6 Replace the [computer base](#).
- 7 Replace the [rear-I/O cover](#).
- 8 Replace the [memory modules](#).
- 9 Replace the [solid-state drive](#).
- 10 Replace the [wireless card](#).
- 11 Replace the [base cover](#).

# Removing the camera cable

---

 **WARNING:** Before working inside your computer, read the safety information that shipped with your computer and follow the steps in [Before working inside your computer](#). After working inside your computer, follow the instructions in [After working inside your computer](#). For more safety best practices, see the Regulatory Compliance home page at [www.dell.com/regulatory\\_compliance](http://www.dell.com/regulatory_compliance).

## Prerequisites

 **NOTE:** These instructions are applicable only for laptops with a non-touch screen display.

- 1 Remove the [base cover](#).
- 2 Remove the [wireless card](#).
- 3 Remove the [solid-state drive](#).
- 4 Remove the [memory modules](#).
- 5 Remove the [rear-I/O cover](#).
- 6 Remove the [computer base](#).
- 7 Remove the [coin-cell battery](#).
- 8 Remove the [heat-sink assembly](#).
- 9 Remove the [battery](#).
- 10 Remove the [system board](#).
- 11 Remove the [display assembly](#).
- 12 Remove the [display bezel](#).
- 13 Remove the [display panel](#).
- 14 Remove the [display hinges](#).

## Procedure

- 1 Peel the tape that secures the camera cable to the camera module and disconnect the camera cable from the camera module.

- 2 Note the camera cable routing and remove the cable from the routing guides on the display back-cover and antenna assembly.

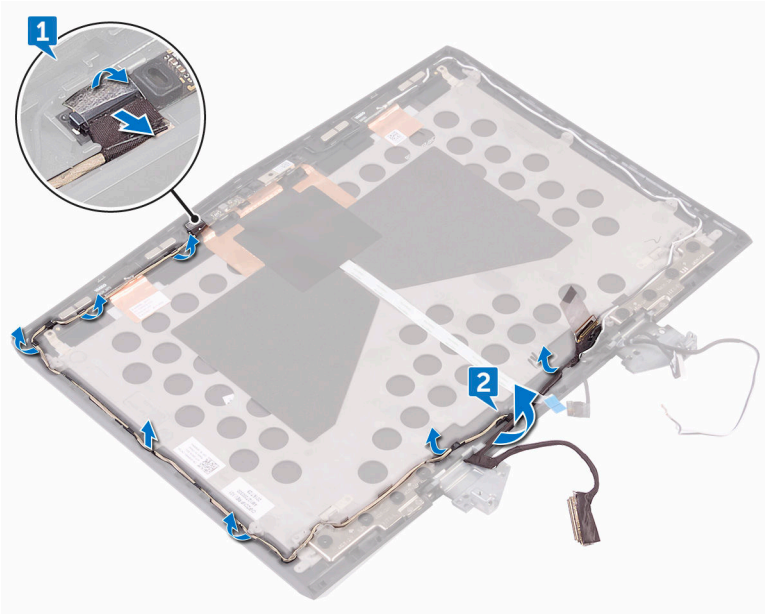

# Replacing the camera cable

---

 **WARNING:** Before working inside your computer, read the safety information that shipped with your computer and follow the steps in [Before working inside your computer](#). After working inside your computer, follow the instructions in [After working inside your computer](#). For more safety best practices, see the Regulatory Compliance home page at [www.dell.com/regulatory\\_compliance](http://www.dell.com/regulatory_compliance).

## Procedure

- 1 Route the camera cable through the routing guides on the display back-cover and antenna assembly.
- 2 Connect the camera cable to the camera module.

## Post-requisites

- 1 Replace the [display hinges](#).
- 2 Replace the [display panel](#).
- 3 Replace the [display bezel](#).
- 4 Replace the [display assembly](#).
- 5 Replace the [system board](#).
- 6 Replace the [battery](#).
- 7 Replace the [heat-sink assembly](#).
- 8 Replace the [coin-cell battery](#).
- 9 Replace the [computer base](#).
- 10 Replace the [rear-I/O cover](#).
- 11 Replace the [memory modules](#).
- 12 Replace the [solid-state drive](#).
- 13 Replace the [wireless card](#).
- 14 Replace the [base cover](#).

# Removing the camera

---

 **WARNING:** Before working inside your computer, read the safety information that shipped with your computer and follow the steps in [Before working inside your computer](#). After working inside your computer, follow the instructions in [After working inside your computer](#). For more safety best practices, see the Regulatory Compliance home page at [www.dell.com/regulatory\\_compliance](http://www.dell.com/regulatory_compliance).

## Prerequisites

 **NOTE:** These instructions are applicable only for laptops with a non-touch screen display.

- 1 Remove the [base cover](#).
- 2 Remove the [wireless card](#).
- 3 Remove the [memory modules](#).
- 4 Remove the [solid-state drive](#).
- 5 Remove the [rear-I/O cover](#).
- 6 Remove the [computer base](#).
- 7 Remove the [coin-cell battery](#).
- 8 Remove the [battery](#).
- 9 Remove the [system board](#).
- 10 Remove the [display assembly](#).
- 11 Remove the [display bezel](#).

## Procedure

- 1 Using a plastic scribe, pry the camera module from the display back-cover and antenna assembly.
- 2 Peel the tape that secures the camera cable to the camera module and disconnect the camera cable from the camera module.

- 3 Lift the camera module from the display back-cover and antenna assembly.

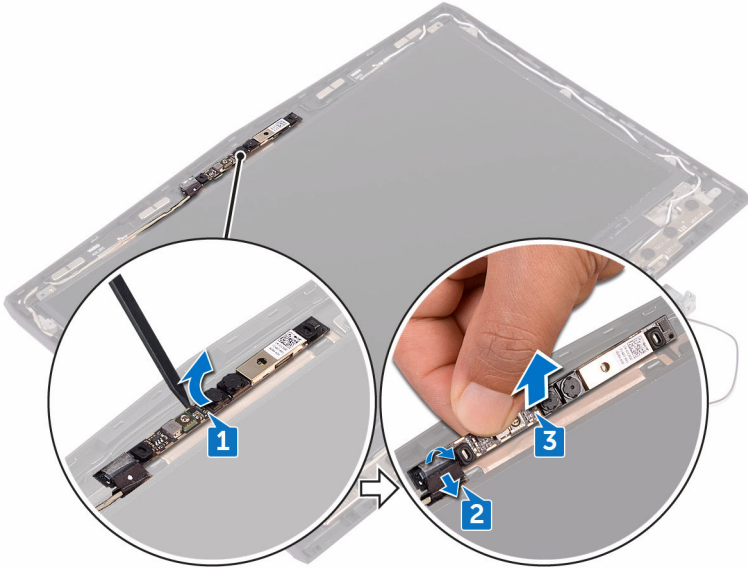

- 4 Follow the procedure in step 2 in [Removing the display back-cover and antenna assembly](#) to remove the camera cable.

# Replacing the camera

---

 **WARNING:** Before working inside your computer, read the safety information that shipped with your computer and follow the steps in [Before working inside your computer](#). After working inside your computer, follow the instructions in [After working inside your computer](#). For more safety best practices, see the Regulatory Compliance home page at [www.dell.com/regulatory\\_compliance](http://www.dell.com/regulatory_compliance).

## Procedure

- 1 Using the alignment posts, adhere the camera module to the display back-cover and antenna assembly.
- 2 Connect the camera cable to the camera module.
- 3 Adhere the tape that secures the camera cable to the camera module.

## Post-requisites

- 1 Replace the [display bezel](#).
- 2 Replace the [display assembly](#).
- 3 Replace the [system board](#).
- 4 Replace the [battery](#).
- 5 Replace the [coin-cell battery](#).
- 6 Replace the [computer base](#).
- 7 Replace the [rear-I/O cover](#).
- 8 Replace the [solid-state drive](#).
- 9 Replace the [memory modules](#).
- 10 Replace the [wireless card](#).
- 11 Replace the [base cover](#).



# Removing the display panel

---

 **WARNING:** Before working inside your computer, read the safety information that shipped with your computer and follow the steps in [Before working inside your computer](#). After working inside your computer, follow the instructions in [After working inside your computer](#). For more safety best practices, see the Regulatory Compliance home page at [www.dell.com/regulatory\\_compliance](http://www.dell.com/regulatory_compliance).

## Prerequisites

 **NOTE:** These instructions are applicable only for laptops with a non-touch screen display.

- 1 Remove the [base cover](#).
- 2 Remove the [wireless card](#).
- 3 Remove the [solid-state drive](#).
- 4 Remove the [memory modules](#).
- 5 Remove the [rear-I/O cover](#).
- 6 Remove the [computer base](#).
- 7 Remove the [coin-cell battery](#).
- 8 Remove the [heat-sink assembly](#).
- 9 Remove the [battery](#).
- 10 Remove the [system board](#).
- 11 Remove the [display assembly](#).
- 12 Remove the [display bezel](#).
- 13 Remove the [camera](#).

## Procedure

- 1 Remove the four screws (M1.6x2) that secure the display panel to the display back-cover and antenna assembly.

- 
- 2 Gently lift the display panel and turn it over.

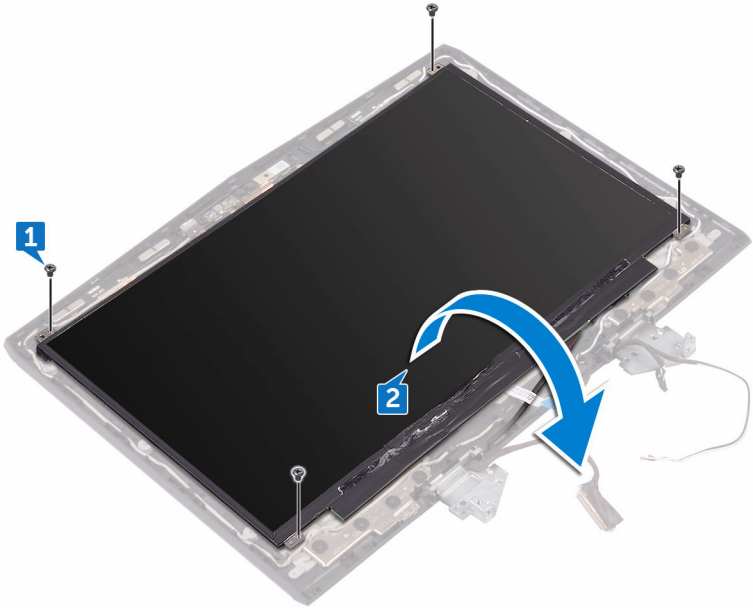

- 
- 
- 3 Peel the tape that secures the display cable to the display panel.
- 4 Open the latch and disconnect the display cable from the display panel.

5 Lift the display panel off the display back-cover.

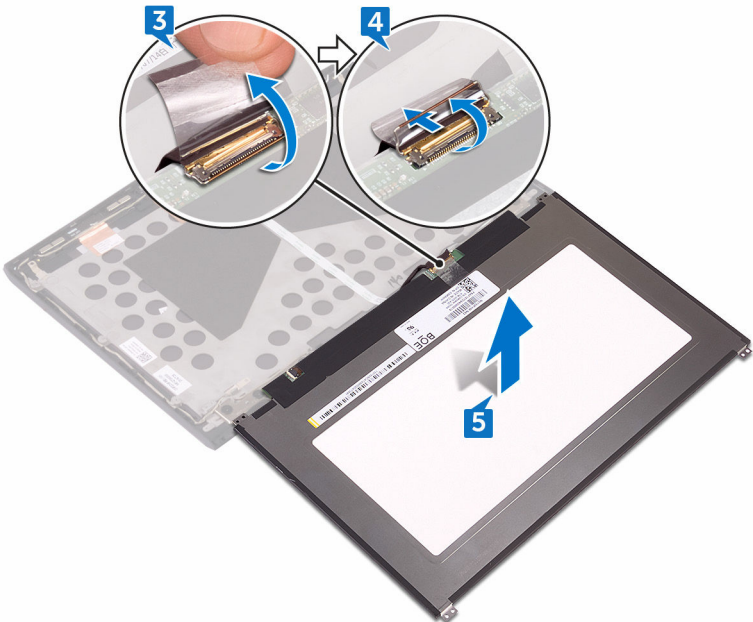

# Replacing the display panel

---

 **WARNING:** Before working inside your computer, read the safety information that shipped with your computer and follow the steps in [Before working inside your computer](#). After working inside your computer, follow the instructions in [After working inside your computer](#). For more safety best practices, see the Regulatory Compliance home page at [www.dell.com/regulatory\\_compliance](http://www.dell.com/regulatory_compliance).

## Procedure

- 1 Slide the display cable into the connector on the display panel and close the latch to secure the cable.
- 2 Adhere the tape that secures the display cable to the display panel.
- 3 Turn the display panel over and gently place it on the display back-cover.

 **CAUTION:** Ensure that no cables are under the display panel.

- 4 Align the screw holes on the display panel with the screw holes on the display back-cover and antenna assembly.
- 5 Replace the four screws (M1.6x2) that secure the display panel to the display back-cover and antenna assembly.

## Post-requisites

- 1 Replace the [camera](#).
- 2 Replace the [display bezel](#).
- 3 Replace the [display assembly](#).
- 4 Replace the [system board](#).
- 5 Replace the [battery](#).
- 6 Replace the [heat-sink assembly](#).
- 7 Replace the [coin-cell battery](#).
- 8 Replace the [computer base](#).
- 9 Replace the [rear-I/O cover](#).
- 10 Replace the [memory modules](#).

- 11** Replace the [solid-state drive](#).
- 12** Replace the [wireless card](#).
- 13** Replace the [base cover](#).

# Removing the display hinges

---

 **WARNING:** Before working inside your computer, read the safety information that shipped with your computer and follow the steps in [Before working inside your computer](#). After working inside your computer, follow the instructions in [After working inside your computer](#). For more safety best practices, see the Regulatory Compliance home page at [www.dell.com/regulatory\\_compliance](http://www.dell.com/regulatory_compliance).

## Prerequisites

 **NOTE:** These instructions are applicable only for laptops with a non-touch screen display.

- 1 Remove the [base cover](#).
- 2 Remove the [wireless card](#).
- 3 Remove the [solid-state drive](#).
- 4 Remove the [memory modules](#).
- 5 Remove the [rear-I/O cover](#).
- 6 Remove the [computer base](#).
- 7 Remove the [coin-cell battery](#).
- 8 Remove the [heat-sink assembly](#).
- 9 Remove the [battery](#).
- 10 Remove the [system board](#).
- 11 Remove the [display assembly](#).
- 12 Remove the [display bezel](#).
- 13 Remove the [display panel](#).

## Procedure

- 1 Press the hinge caps on both the edges to release the hinge caps from the hinge.

- 2 Remove the hinge caps off the hinges.

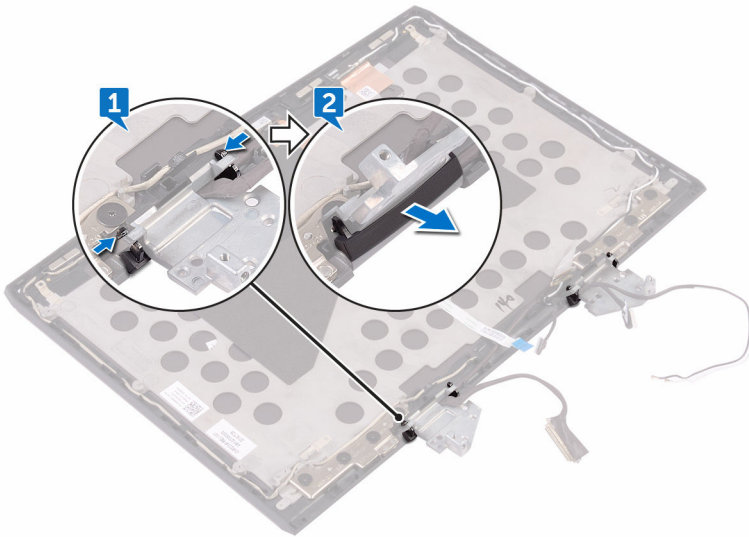

- 3 Remove the display cable from the routing guide on the display back-cover and antenna assembly.
- 4 Remove the logo-board cable from the routing guide on the display back-cover and antenna assembly.

- 5 Remove the antenna cables from the routing guide on the display back-cover and antenna assembly.

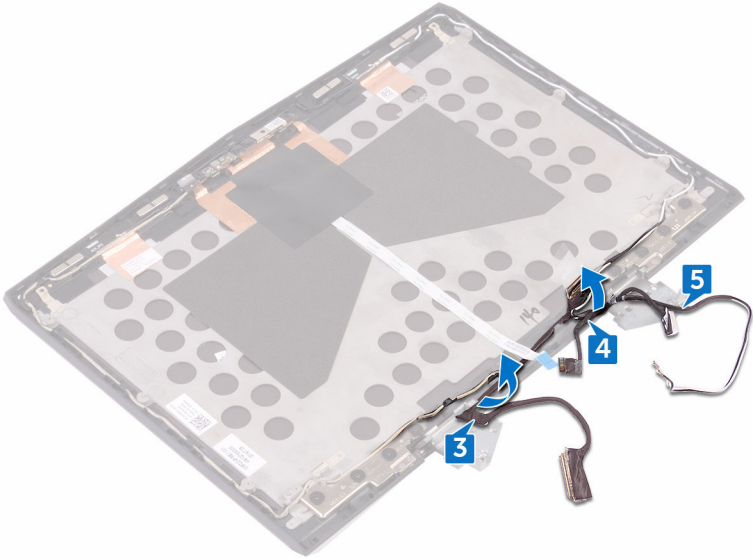

- 6 Remove the eight screws (M2.5x2.0L) that secure the hinges to the display back-cover and antenna assembly.



7 Lift the hinges from the display back-cover and antenna assembly.

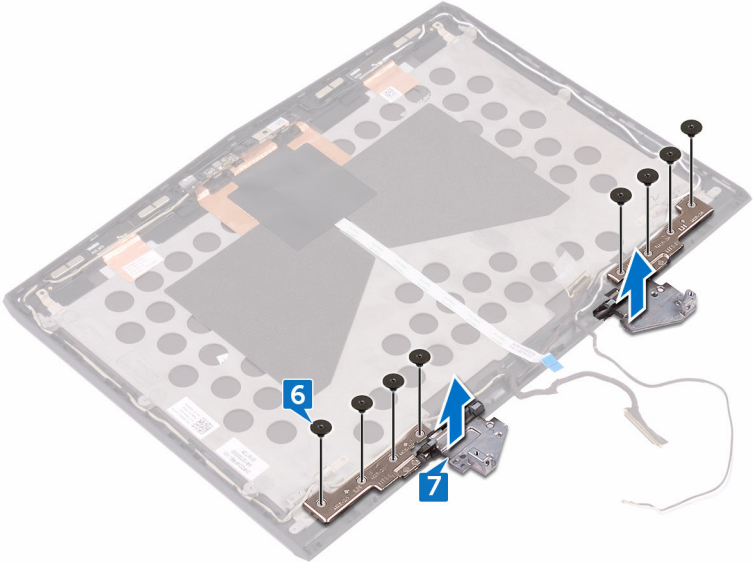

# Replacing the display hinges

---

 **WARNING:** Before working inside your computer, read the safety information that shipped with your computer and follow the steps in [Before working inside your computer](#). After working inside your computer, follow the instructions in [After working inside your computer](#). For more safety best practices, see the Regulatory Compliance home page at [www.dell.com/regulatory\\_compliance](http://www.dell.com/regulatory_compliance).

## Procedure

- 1 Align the screw holes on the display hinges with the screw holes on the display back-cover and antenna assembly.
- 2 Replace the eight screws (M2.5x2.0L) that secure the display hinges to the display back-cover and antenna assembly.
- 3 Route the antenna cables through the routing guides on the display back-cover and antenna assembly.
- 4 Route the logo-board cable through the routing guides on the display back-cover and antenna assembly.
- 5 Route the display cable through the routing guides on the display back-cover and antenna assembly.
- 6 Place the hinge caps on the display hinges and press down to snap them into place.

## Post-requisites

- 1 Replace the [display panel](#).
- 2 Replace the [display bezel](#).
- 3 Replace the [display assembly](#).
- 4 Replace the [system board](#).
- 5 Replace the [battery](#).
- 6 Replace the [heat-sink assembly](#).
- 7 Replace the [coin-cell battery](#).
- 8 Replace the [computer base](#).

- 9** Replace the [rear-I/O cover](#).
- 10** Replace the [memory modules](#).
- 11** Replace the [solid-state drive](#).
- 12** Replace the [wireless card](#).
- 13** Replace the [base cover](#).

# Removing the display back-cover and antenna assembly

---



**WARNING:** Before working inside your computer, read the safety information that shipped with your computer and follow the steps in [Before working inside your computer](#). After working inside your computer, follow the instructions in [After working inside your computer](#). For more safety best practices, see the Regulatory Compliance home page at [www.dell.com/regulatory\\_compliance](http://www.dell.com/regulatory_compliance).

## Prerequisites



**NOTE:** These instructions are applicable only for laptops with a non-touch screen display.

- 1 Remove the [base cover](#).
- 2 Remove the [wireless card](#).
- 3 Remove the [solid-state drive](#).
- 4 Remove the [memory modules](#).
- 5 Remove the [rear-I/O cover](#).
- 6 Remove the [computer base](#).
- 7 Remove the [coin-cell battery](#).
- 8 Remove the [heat-sink assembly](#).
- 9 Remove the [battery](#).
- 10 Remove the [system board](#).
- 11 Remove the [display assembly](#).
- 12 Remove the [display bezel](#).
- 13 Remove the [display panel](#).
- 14 Remove the [display hinges](#).
- 15 Remove the [camera cable](#).
- 16 Remove the [camera](#).

# Procedure

After performing the steps in prerequisites we are left with the display back-cover and antenna assembly .

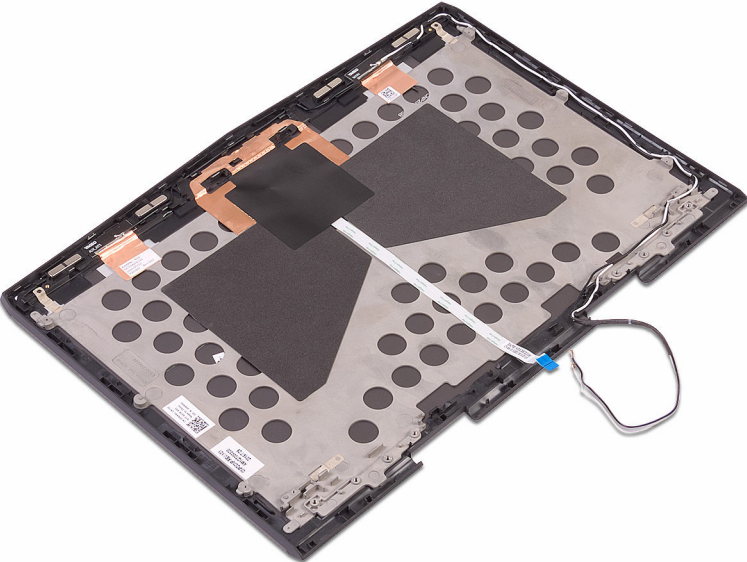

# Replacing the display back-cover and antenna assembly

---



**WARNING:** Before working inside your computer, read the safety information that shipped with your computer and follow the steps in [Before working inside your computer](#). After working inside your computer, follow the instructions in [After working inside your computer](#). For more safety best practices, see the Regulatory Compliance home page at [www.dell.com/regulatory\\_compliance](http://www.dell.com/regulatory_compliance).

## Procedure

Place the display back-cover and antenna assembly on a clean and flat surface.

## Post-requisites

- 1 Replace the [camera](#).
- 2 Replace the [camera cable](#).
- 3 Replace the [display hinges](#).
- 4 Replace the [display panel](#).
- 5 Replace the [display bezel](#).
- 6 Replace the [display assembly](#).
- 7 Replace the [system board](#).
- 8 Replace the [battery](#).
- 9 Replace the [heat-sink assembly](#).
- 10 Replace the [coin-cell battery](#).
- 11 Replace the [computer base](#).
- 12 Replace the [rear-I/O cover](#).
- 13 Replace the [memory modules](#).
- 14 Replace the [solid-state drive](#).
- 15 Replace the [wireless card](#).
- 16 Replace the [base cover](#).

# BIOS overview

---

The BIOS manages data flow between the computer's operating system and attached devices such as the hard disk, video adapter, keyboard, mouse, and printer.

## Entering the BIOS setup program

- 1 Turn on or restart your computer.
- 2 Press F2 when the Dell logo is displayed on the screen to enter the BIOS setup program.

You can change the user-definable settings in BIOS setup program.

## Timing key sequences

The keyboard is not the first device initialized by the BIOS setup program. As a result, if you press a keystroke too early, the keyboard is locked out. In such cases, a keyboard error message is displayed on the screen, and you cannot restart your computer with the Ctrl+Alt+Del key combination.

To prevent the keyboard from locking, wait until the keyboard is initialized completely. The keyboard is initialized if one of the following occurs:

- The keyboard lights flash.
- The F2=Setup prompt appears at the top-right corner of the screen during boot.

## System setup options

 **NOTE:** Depending on this computer and its installed devices, the items listed in this section may or may not appear.

**Table 3. Main tab**

<b>Main</b>	
System Time	Displays the current time in hh:mm:ss format.
System Date	Displays the current date in mm/dd/yyyy format.
BIOS Version	Displays the BIOS version.
Product Name	Displays the model number of your computer.
Service Tag	Displays the service tag of your computer.
Asset Tag	Displays the asset tag of your computer.
CPU Type	Displays the processor type.
CPU Speed	Displays the processor speed.
CPU ID	Displays the processor identification code.
CPU L1 Cache	Displays the processor L1 cache size.
CPU L2 Cache	Displays the processor L2 cache size.
CPU L3 Cache	Displays the processor L3 cache size.
Integrated Graphics	Displays the integrated graphics.
Discrete Graphics 1	Displays the first discrete graphics installed on your computer.
First HDD	Displays the type of hard drive installed.
Second HDD	Displays the type of secondary hard-drive installed.
Third HDD	Displays the type of third hard-drive installed.
Fourth HDD	Displays the type of fourth hard-drive installed.



---

**Main**

---

M.2 PCIe SSD-1	Displays the type of primary SSD installed.
M.2 PCIe SSD-2	Displays the type of secondary SSD installed.
M.2 PCIe SSD-3	Displays the type of third SSD installed.

**Table 4. Advanced tab**

---

**Advanced**

---

Intel(R) SpeedStep Technology	Allows you to enable or disable Intel (R) Speedstep Technology.  <b>NOTE: If enabled, the processor clock speed and core voltage are adjusted dynamically based on the processor load.</b>
	Default: Enabled
Virtualization	Allows you to enable or disable the Intel Virtualization technology. Default: Enabled
VT for Direct I/O	Specify whether a Virtual Machine Monitor (VMM) can utilize the additional hardware capabilities provided by Intel Virtualization Technology for Direct I/O.
Integrated NIC	Allows you to enable or disable the on-board LAN controller. Default: Enabled
USB Emulation	Allows you to enable or disable the USB emulation feature. This feature defines how the BIOS, in the absence of a USB-aware operating system, handles USB devices. USB emulation is always enabled during POST.

---

## Advanced

---



**NOTE: You cannot boot any type of USB device (floppy, hard drive, or memory key) when this option is off.**

Default: Enabled

USB PowerShare

Allows you to charge USB devices when the computer is turned off or in standby mode.

Default: Enabled

USB Wake Support

Allows you to enable USB devices to wake the computer from standby or to disable the USB wake support feature.



**NOTE: If USB PowerShare is enabled, a device connected to the USB PowerShare connector may not wake the computer.**

Default: Disabled

SATA Operation

Allows you to configure the operating mode of the integrated SATA hard drive controller.

Default: AHCI

Adapter Warnings

Allows you to choose if the computer should display warning messages when you use AC adapters that are not supported by your computer.

Default: Enabled

Function Key Behavior

Allows you to set function key or multimedia key as the default function key behavior.

Default: Function key

Express Charge

Allows you to charge your computer battery using Standard Charge or Express Charge mode.

Default: Express Charge

---

**Advanced**

---

Touchpad Backlight	Allows you to configure the touchpad backlight option.
Battery Health	Displays the battery health.
Intel Software Guard Extensions	Allows you to enable or disable the Intel Software Guard Extensions Default: Disabled
BIOS Recovery	Enable the user to recover from certain corrupted BIOS conditions from a recovery file on the user primary hard drive Default: Enabled
Performance Options	
<b>SupportAssist System Resolution</b>	
Auto OS Recovery Threshold	Control the automatic boot flow for SupportAssist System Resolution Console and for Dell OS Recovery tool.

**Table 5. Security tab**

---

**Security**

---

Unlock Setup Status	Displays if the setup status is unlocked.
Admin Password Status	Displays if the administrator password is clear or set. Default: Not set
System password Status	Displays if the system password is clear or set. Default: Not set
HDD password Status	Displays if the HDD password is clear or set. Default: Not set
Admin Password	Allows you to set the administrator password. The administrator password

---

**Security**

---

	controls access to the system setup utility.
System Password	Allows you to set the system password. The system password controls access to the computer at boot.
HDD password	Allows you to set, change or delete the hard-disk drive password.
Password Change	Allows you to permit or deny system password or HDD password changes. Default: Permitted
Computrace	Enable or disable the BIOS module interface of the optional Computrace Service from Absolute Software.
Firmware TPM	
UEFI Capsule Firmware Updates	Enable or disable BIOS updates through UEFI capsule update packages.

**Table 6. Boot tab**

---

**Boot**

---

Boot List Option	Displays the available boot options.
File Browser Add Boot Option	Allows to add the boot options.
File Browser Del Boot Option	Allows to delete the boot options
Secure Boot	Enable or disable the secure boot feature.
Legacy Option ROMs	Enable or disable the Legacy Option ROMs.
Boot Option Priorities	Displays the boot sequence.
Boot Option #1	Displays the available first boot option.

<b>Boot</b>	
Boot Option #2	Displays the available second boot option.
Boot Option #3	Displays the available third boot option.

**Table 7. Exit tab**

<b>Exit</b>	
Save Changes and Reset	Allows you to exit system setup and save your changes.
Discard Changes and Reset	Allows you to exit system setup and load previous values for all system setup options.
Restore Defaults	Allows you to restore default values for all system setup options.
Discard Changes	Allows you to load previous values for all system setup options.
Save Changes	Allows you to save the changes for all system setup options.

## Clearing forgotten passwords

Contact Dell technical support to clear the forgotten passwords, see [www.dell.com/contactdell](http://www.dell.com/contactdell).

## Clearing CMOS settings

- 1 Remove the [base cover](#).
- 2 Remove the [wireless card](#).
- 3 Remove the [solid-state drive](#).
- 4 Remove the [rear I/O cover](#).
- 5 Remove the [computer base](#).
- 6 Remove the [battery](#).
- 7 Remove the [coin-cell battery](#).
- 8 Wait for one minute.

- 9 Replace the [coin-cell battery](#).
- 10 Replace the [battery](#).
- 11 Replace the [computer base](#).
- 12 Replace the [rear I/O cover](#).
- 13 Replace the [solid-state drive](#).
- 14 Replace the [wireless card](#).
- 15 Replace the [base cover](#).

## Flashing the BIOS

You may need to flash (update) the BIOS when an update is available or when you replace the system board. To flash the BIOS:

- 1 Turn on your computer.
- 2 Go to [www.dell.com/support](http://www.dell.com/support).
- 3 Click **Product support**, enter the Service Tag of your computer, and then click **Submit**.



**NOTE: If you do not have the Service Tag, use the auto-detect feature or manually browse for your computer model.**

- 4 Click **Drivers & downloads** → **Find it myself**.
- 5 Select the operating system installed on your computer.
- 6 Scroll down the page and expand **BIOS**.
- 7 Click **Download** to download the latest version of the BIOS for your computer.
- 8 After the download is complete, navigate to the folder where you saved the BIOS update file.
- 9 Double-click the BIOS update file icon and follow the instructions on the screen.

## Boot menu

This computer includes a one-time boot menu. By using this feature, you can change the sequence of devices that your computer attempts to boot from, for example, CD-ROM, hard drive, or network.

# Boot menu enhancements

The boot menu enhancements are as follows:

- **Easier access** — Press F12 to access the boot selection menu.
- **User prompting** — The user is prompted to use the keystroke on the BIOS screen.
- **Diagnostics options** — The boot menu includes the ePSA diagnostic options.

# Diagnostics

---

**Power and battery-status light:** Indicates the power and battery-charge status.

**Solid amber** – Computer is running on battery and the battery has less than 10 percent charge.

**User-defined color (AC mode)** – Power adapter is connected and the battery is fully charged.

**User-defined color (Battery mode)** – Computer is running on battery and the battery has more than 10 percent charge.

**User-defined color (Breath)** – Computer is in sleep state.

**Off** – Computer is in hibernation, or turned off.

The power and battery-status light blinks red and blue along with beep codes indicating failures.

For example, the power and battery-status light blinks red two times followed by a pause, and then blinks blue three times followed by a pause. This 2,3 pattern continues until the computer is turned off indicating no memory or RAM is detected.

The following table shows different light patterns and what they indicate.

**Table 8. Diagnostics**

Light Pattern	Problem description
2,1	CPU failure
2,2	System board: BIOS and ROM failure
2,3	No memory or RAM detected
2,4	Memory or RAM failure
2,5	Invalid memory installed
2,6	System board or chipset error
2,7	LCD failure
3,1	CMOS battery failure
3,2	PCI/video card failure
3,3	Recovery image not found



---

Light Pattern	Problem description
3,4	Recovery image found but invalid

---

**Camera status light:** Indicates whether the camera is in use.

- Solid white – Camera is in use.
- Off – Camera is not in use.

**Caps Lock status light:** Indicates whether Caps Lock is enabled or disabled.

- Solid white – Caps Lock enabled.
- Off – Caps Lock disabled.

**Network port light:** Indicates network connectivity.

- Off – No network connection.
- Solid green – 10 Mbps connection.
- Solid orange – 100 Mbps connection.
- Solid yellow – 1000 Mbps connection.
- Flicker yellow – Network activity.

# Flashing the BIOS

---

You may need to flash (update) the BIOS when an update is available or when you replace the system board. To flash the BIOS:

- 1 Turn on your computer.
- 2 Go to [www.dell.com/support](http://www.dell.com/support).
- 3 Click **Product support**, enter the Service Tag of your computer, and then click **Submit**.



**NOTE: If you do not have the Service Tag, use the auto-detect feature or manually browse for your computer model.**

- 4 Click **Drivers & downloads** → **Find it myself**.
- 5 Select the operating system installed on your computer.
- 6 Scroll down the page and expand **BIOS**.
- 7 Click **Download** to download the latest version of the BIOS for your computer.
- 8 After the download is complete, navigate to the folder where you saved the BIOS update file.
- 9 Double-click the BIOS update file icon and follow the instructions on the screen.

# Getting help and contacting Alienware

---

## Self-help resources

You can get information and help on Alienware products and services using these online self-help resources:

**Table 9. Alienware products and online self-help resources**

Information about Alienware products and services [www.alienware.com](http://www.alienware.com)

Dell Help & Support app



Get started app



Get started app

Accessing help

In Windows search, type **Help and Support**, and press **Enter**.

Online help for operating system

[www.dell.com/support/windows](http://www.dell.com/support/windows)  
[www.dell.com/support/linux](http://www.dell.com/support/linux)

Troubleshooting information, user manuals, setup instructions, product specifications, technical help blogs, drivers, software updates, and so on

[www.alienware.com/gamingservices](http://www.alienware.com/gamingservices)

VR Support

[www.dell.com/VRsupport](http://www.dell.com/VRsupport)

Videos providing step-by-step instructions to service your computer

[www.youtube.com/alienwareservices](http://www.youtube.com/alienwareservices)

## Contacting Alienware

To contact Alienware for sales, technical support, or customer service issues, see [www.alienware.com](http://www.alienware.com).

 **NOTE: Availability varies by country and product, and some services may not be available in your country.**

 **NOTE: If you do not have an active internet connection, you can find contact information on your purchase invoice, packing slip, bill, or Dell product catalog.**