

Inspiron 13

5000 Series 2-in-1

Service Manual

Computer Model: Inspiron 13-5368
Regulatory Model: P69G
Regulatory Type: P69G001



Notes, cautions, and warnings



NOTE: A NOTE indicates important information that helps you make better use of your computer.



CAUTION: A CAUTION indicates either potential damage to hardware or loss of data and tells you how to avoid the problem.



WARNING: A WARNING indicates a potential for property damage, personal injury, or death.

© 2016 Dell Inc. All rights reserved. This product is protected by U.S. and international copyright and intellectual property laws. Dell and the Dell logo are trademarks of Dell Inc. in the United States and/or other jurisdictions. All other marks and names mentioned herein may be trademarks of their respective companies.

2016-05

Rev. A01

Contents

Before working inside your computer.....	12
Before you begin	12
Safety instructions.....	12
Recommended tools.....	13
After working inside your computer.....	15
Removing the base cover.....	16
Procedure.....	16
Replacing the base cover.....	19
Procedure.....	19
Removing the battery.....	20
Prerequisites.....	20
Procedure.....	20
Replacing the battery.....	22
Procedure.....	22
Post-requisites.....	22
Removing the memory modules.....	23
Prerequisites.....	23
Procedure.....	24
Replacing the memory modules.....	26
Procedure.....	26
Post-requisites.....	27

Removing the hard drive.....	29
Prerequisites.....	29
Procedure.....	29
Replacing the hard drive.....	32
Procedure.....	32
Post-requisites.....	32
Removing the coin-cell battery.....	33
Prerequisites.....	33
Procedure.....	33
Replacing the coin-cell battery.....	35
Procedure.....	35
Post-requisites.....	35
Removing the wireless card.....	36
Prerequisites.....	36
Procedure.....	36
Replacing the wireless card.....	38
Procedure.....	38
Post-requisites.....	39
Removing the keyboard daughter-board.....	40
Prerequisites.....	40
Procedure.....	40
Replacing the keyboard daughter-board.....	42
Procedure.....	42
Post-requisites.....	42

Removing the speakers.....	43
Prerequisites.....	43
Procedure.....	43
Replacing the speakers.....	45
Procedure.....	45
Post-requisites.....	45
Removing the fan.....	46
Prerequisites.....	46
Procedure.....	46
Replacing the fan.....	48
Procedure.....	48
Post-requisites.....	48
Removing the heat sink.....	49
Prerequisites.....	49
Procedure.....	49
Replacing the heat sink.....	51
Procedure.....	51
Post-requisites.....	51
Removing the power and volume-buttons board.....	52
Prerequisites.....	52
Procedure.....	52
Replacing the power and volume-buttons board.....	54
Procedure.....	54
Post-requisites.....	54

Removing the status-light board.....	55
Prerequisites.....	55
Procedure.....	55
Replacing the status-light board.....	58
Procedure.....	58
Post-requisites.....	58
Removing the touch pad.....	59
Prerequisites.....	59
Procedure.....	59
Replacing the touch pad.....	63
Procedure.....	63
Post-requisites.....	63
Removing the I/O board.....	64
Prerequisites.....	64
Procedure.....	64
Replacing the I/O board.....	66
Procedure.....	66
Post-requisites.....	66
Removing the display assembly.....	67
Prerequisites.....	67
Procedure.....	67
Replacing the display assembly.....	71
Procedure.....	71
Post-requisites.....	71

Removing the power-adapter port.....	72
Prerequisites.....	72
Procedure.....	72
Replacing the power-adapter port.....	74
Procedure.....	74
Post-requisites.....	74
Removing the system board.....	75
Prerequisites.....	75
Procedure.....	75
Replacing the system board.....	79
Procedure.....	79
Post-requisites.....	79
Entering the Service Tag in the BIOS setup program.....	80
Removing the palm rest and keyboard assembly.....	81
Prerequisites.....	81
Procedure.....	81
Replacing the palm rest and keyboard assembly.....	83
Procedure.....	83
Post-requisites.....	83
Removing the display panel.....	84
Prerequisites.....	84
Procedure.....	84
Replacing the display panel.....	87
Procedure.....	87
Post-requisites.....	87

Removing the display back-cover and antenna assembly.....	88
Prerequisites.....	88
Procedure.....	88
Replacing the display back-cover and antenna assembly.....	90
Procedure.....	90
Post-requisites.....	90
Removing the camera.....	91
Prerequisites.....	91
Procedure.....	91
Replacing the camera.....	93
Procedure.....	93
Post-requisites.....	93
Removing the display cable.....	94
Prerequisites.....	94
Procedure.....	94
Replacing the display cable.....	96
Procedure.....	96
Post-requisites.....	96
Removing the sensor board.....	97
Prerequisites.....	97
Procedure.....	97
Replacing the sensor board.....	99
Procedure.....	99
Post-requisites.....	99

Flashing the BIOS.....	100
Technology and components.....	101
Audio.....	101
Downloading the audio driver.....	101
Identifying the audio controller.....	101
Changing the audio settings.....	102
Camera.....	102
Identifying the webcam in device manager.....	102
Starting the camera application.....	102
Getting the Dell Webcam Central.....	103
Display.....	104
Adjusting the brightness.....	104
Changing the screen resolution.....	104
Rotating the display.....	105
Cleaning the display.....	106
HDMI.....	106
Connecting to external display devices.....	106
Graphics.....	108
Downloading the graphics driver.....	108
Identifying the display adapter.....	108
Changing the display settings in Intel HD Graphics Control Panel.....	109
Intel WiDi.....	109
Downloading the WiDi application.....	110
Setting up the wireless display.....	110
USB.....	111
Downloading the USB 3.0 driver.....	111
Enabling or disabling the USB in BIOS setup program.....	111
Fixing a no-boot issue caused by USB emulation.....	112
Wi-Fi.....	112
Turning on or off Wi-Fi.....	112
Downloading the Wi-Fi driver.....	112

Configuring Wi-Fi.....	113
Bluetooth.....	113
Turning on or off Bluetooth.....	114
Pairing the Bluetooth-enabled devices.....	114
Removing the Bluetooth device.....	115
Transferring files between devices using Bluetooth.....	115
Hard Drive.....	116
Identifying the hard drive.....	116
Identifying the hard drive in BIOS setup program.....	117
Media-card reader.....	117
Browsing a media card.....	117
Downloading the media-card reader driver.....	117
Keyboard.....	118
Changing the keyboard language.....	118
Keyboard shortcuts.....	118
Touch pad.....	119
Identifying the touch pad.....	120
Touch pad gestures.....	120
Power adapter.....	120
Battery.....	121
Chipset.....	121
Downloading the chipset driver.....	121
Identifying the chipset.....	122
Memory.....	123
Checking the system memory in Windows.....	123
Verifying the system memory in BIOS setup program.....	123
Testing memory using ePSA.....	123
Processors.....	123
Identifying the processors in Windows.....	124
Checking the processor usage in the task manager.....	124
Operating System.....	125
Service Tag location.....	125
Device drivers.....	125
Intel Dynamic Platform and Thermal Framework.....	125

Intel Chipset Software Installation Utility.....	125
Intel HD Graphics 520 driver.....	126
Intel Serial IO Driver.....	126
Intel Trusted Execution Engine Interface.....	128
Intel Virtual Button driver.....	129
Intel Wireless 3165 WiFi and Bluetooth drivers.....	130
BIOS overview.....	131
Entering the BIOS setup program.....	131
Boot menu.....	131
Boot menu enhancements.....	131
Timing key sequences.....	131

System diagnostic lights..... 132

Getting help and contacting Dell..... 134



Self-help resources.....	134
Contacting Dell.....	135

Before working inside your computer

 **NOTE:** The images in this document may differ from your computer depending on the configuration you ordered.

Before you begin

- 1 Save and close all open files and exit all open applications.
- 2 Shut down your computer.
The shut-down instruction varies depending on the operating system installed on your computer.









- Windows 10: Click or tap **Start** →  **Power** → **Shut down**.
- Windows 8.1: On the **Start** screen, click or tap the power icon  → **Shut down**.
- Windows 7: Click or tap **Start** → **Shut down**.

 **NOTE:** If you are using a different operating system, see the documentation of your operating system for shut-down instructions.

- 3 Disconnect your computer and all attached devices from their electrical outlets.
- 4 Disconnect all cables such as telephone cables, network cables, and so on, from your computer.
- 5 Disconnect all attached devices and peripherals, such as keyboard, mouse, monitor, and so on, from your computer.
- 6 Remove any media card and optical disc from your computer, if applicable.

Safety instructions

Use the following safety guidelines to protect your computer from potential damage and ensure your personal safety.

-  **WARNING:** Before working inside your computer, read the safety information that shipped with your computer. For more safety best practices, see the Regulatory Compliance home page at www.dell.com/regulatory_compliance.
-  **WARNING:** Disconnect all power sources before opening the computer cover or panels. After you finish working inside the computer, replace all covers, panels, and screws before connecting to the electrical outlet.
-  **CAUTION:** To avoid damaging the computer, ensure that the work surface is flat and clean.
-  **CAUTION:** To avoid damaging the components and cards, handle them by their edges, and avoid touching pins and contacts.
-  **CAUTION:** You should only perform troubleshooting and repairs as authorized or directed by the Dell technical assistance team. Damage due to servicing that is not authorized by Dell is not covered by your warranty. See the safety instructions that shipped with the product or at www.dell.com/regulatory_compliance.
-  **CAUTION:** Before touching anything inside your computer, ground yourself by touching an unpainted metal surface, such as the metal at the back of the computer. While you work, periodically touch an unpainted metal surface to dissipate static electricity, which could harm internal components.
-  **CAUTION:** When you disconnect a cable, pull on its connector or on its pull tab, not on the cable itself. Some cables have connectors with locking tabs or thumb-screws that you must disengage before disconnecting the cable. When disconnecting cables, keep them evenly aligned to avoid bending any connector pins. When connecting cables, ensure that the ports and connectors are correctly oriented and aligned.
-  **CAUTION:** Press and eject any installed card from the media-card reader.

Recommended tools

The procedures in this document may require the following tools:

- Phillips screwdriver

- Plastic scribe

After working inside your computer



CAUTION: Leaving stray or loose screws inside your computer may severely damage your computer.

- 1 Replace all screws and ensure that no stray screws remain inside your computer.
- 2 Connect any external devices, peripherals, or cables you removed before working on your computer.
- 3 Replace any media cards, discs, or any other parts that you removed before working on your computer.
- 4 Connect your computer and all attached devices to their electrical outlets.
- 5 Turn on your computer.

Removing the base cover



WARNING: Before working inside your computer, read the safety information that shipped with your computer and follow the steps in [Before working inside your computer](#). After working inside your computer, follow the instructions in [After working inside your computer](#). For more safety best practices, see the Regulatory Compliance home page at www.dell.com/regulatory_compliance.

Procedure

- 1 Close the display and turn the computer over.

2 Remove the screws that secure the base cover to the palm-rest assembly.

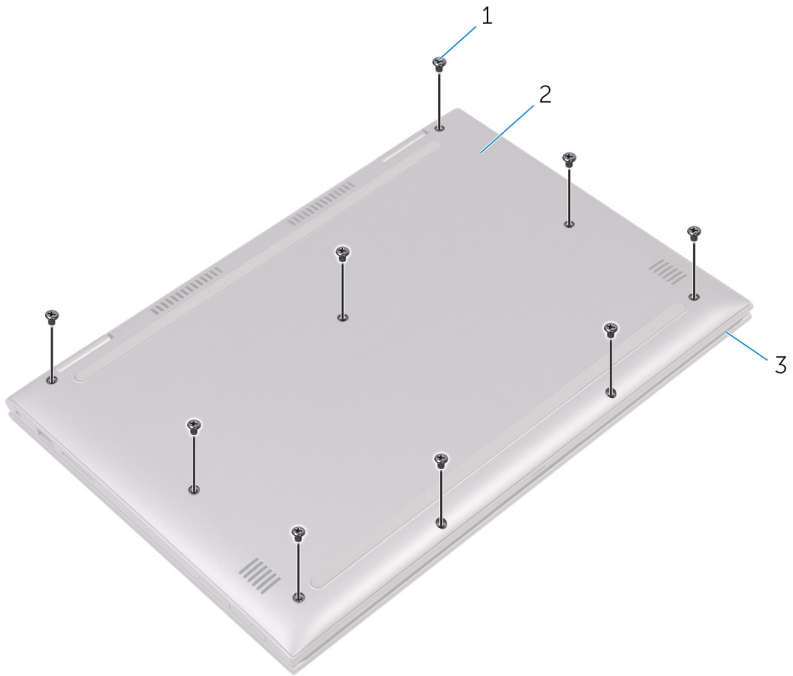

1 screws (9)

2 base cover

3 palm-rest assembly

- 3** Using a plastic scribe, release the tabs that secure the base cover to the palm-rest assembly and remove the base cover off the palm-rest assembly.

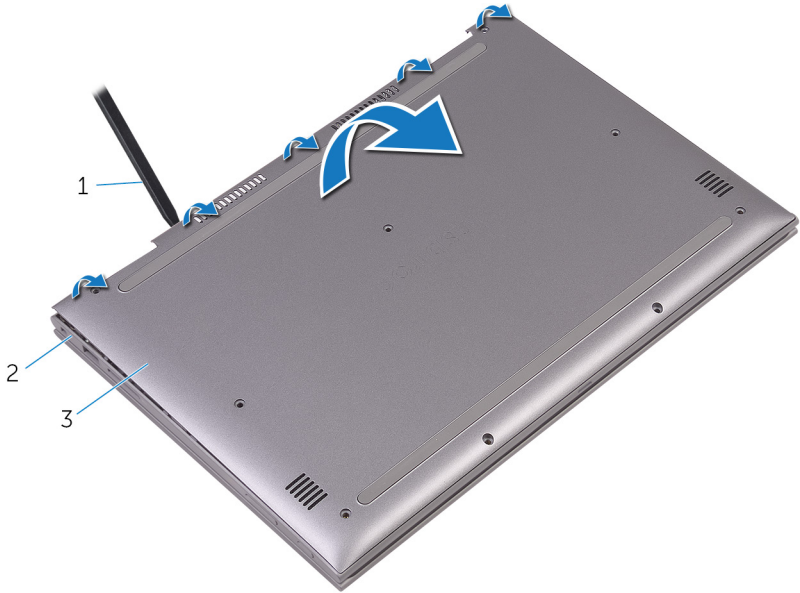

- 1 plastic scribe
3 base cover

- 2 palm-rest assembly

Replacing the base cover



WARNING: Before working inside your computer, read the safety information that shipped with your computer and follow the steps in [Before working inside your computer](#). After working inside your computer, follow the instructions in [After working inside your computer](#). For more safety best practices, see the Regulatory Compliance home page at www.dell.com/regulatory_compliance.

Procedure

- 1 Align the base cover with the palm-rest assembly and snap it into place.
- 2 Replace the screws that secure the base cover to the palm-rest assembly.

Removing the battery



WARNING: Before working inside your computer, read the safety information that shipped with your computer and follow the steps in [Before working inside your computer](#). After working inside your computer, follow the instructions in [After working inside your computer](#). For more safety best practices, see the Regulatory Compliance home page at www.dell.com/regulatory_compliance.

Prerequisites

Remove the [base cover](#).

Procedure

- 1 Disconnect the battery cable from the system board.
- 2 Remove the screws that secure the battery to the palm-rest assembly.

3 Lift the battery off the palm-rest assembly.

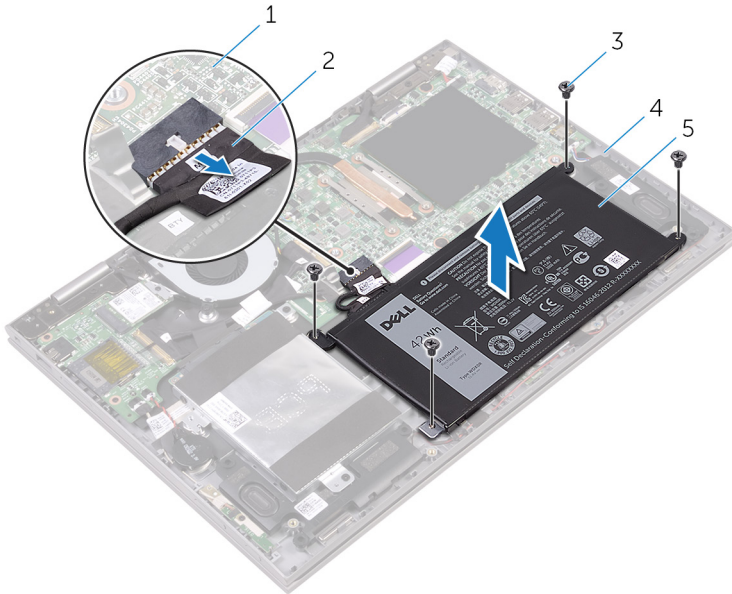

1 system board

2 battery cable

3 screws (4)

4 palm-rest assembly

5 battery

4 Press and hold the power button for five seconds to ground the system board.

Replacing the battery



WARNING: Before working inside your computer, read the safety information that shipped with your computer and follow the steps in [Before working inside your computer](#). After working inside your computer, follow the instructions in [After working inside your computer](#). For more safety best practices, see the Regulatory Compliance home page at www.dell.com/regulatory_compliance.

Procedure

- 1 Align the screw holes on the battery with the screw holes on the palm-rest assembly.
- 2 Replace the screws that secure the battery to the palm-rest assembly.
- 3 Connect the battery cable to the system board.

Post-requisites

Replace the [base cover](#).

Removing the memory modules

 **WARNING:** Before working inside your computer, read the safety information that shipped with your computer and follow the steps in [Before working inside your computer](#). After working inside your computer, follow the instructions in [After working inside your computer](#). For more safety best practices, see the Regulatory Compliance home page at www.dell.com/regulatory_compliance.

Prerequisites

- 1 Remove the [base cover](#).
- 2 Remove the [battery](#).

Procedure

- 1 Lift the Mylar to access the memory module.



1 memory module

2 Mylar

- 2 Use your fingertips to carefully spread apart the securing-clips on each end of the memory-module slot until the memory module pops up.

3 Remove the memory module from the memory-module slot.

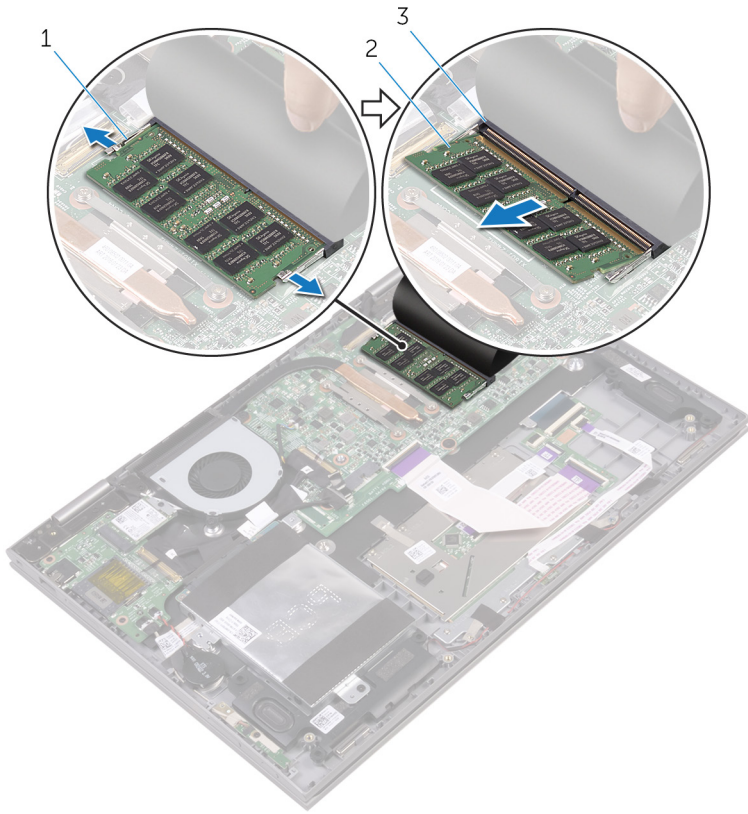

1 securing clips (2)

2 memory module

3 memory-module slot

Replacing the memory modules

 **WARNING:** Before working inside your computer, read the safety information that shipped with your computer and follow the steps in [Before working inside your computer](#). After working inside your computer, follow the instructions in [After working inside your computer](#). For more safety best practices, see the Regulatory Compliance home page at www.dell.com/regulatory_compliance.

Procedure

- 1 Lift the Mylar to access the memory-module slot.
- 2 Align the notch on the memory module with the tab on the memory-module slot.

- 3 Slide the memory module firmly into the slot at an angle and press the memory module down until it clicks into place.

 **NOTE:** If you do not hear the click, remove the memory module and reinstall it.

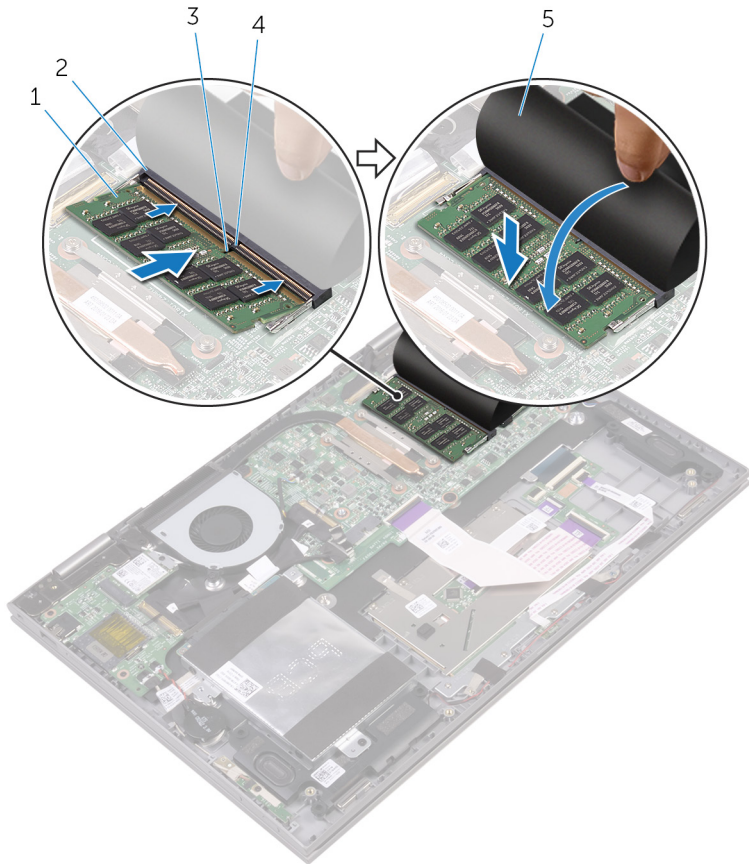

- 1 memory module
- 3 notch
- 5 Mylar



- 2 memory-module slot
- 4 tab

Post-requisites

- 1 Replace the [battery](#).

2 Replace the [base cover](#).

Removing the hard drive

-  **WARNING:** Before working inside your computer, read the safety information that shipped with your computer and follow the steps in [Before working inside your computer](#). After working inside your computer, follow the instructions in [After working inside your computer](#). For more safety best practices, see the Regulatory Compliance home page at www.dell.com/regulatory_compliance.
-  **CAUTION:** Hard drives are fragile. Exercise care when handling the hard drive.
-  **CAUTION:** To avoid data loss, do not remove the hard drive while the computer is in sleep or on state.

Prerequisites

- 1 Remove the [base cover](#).
- 2 Remove the [battery](#).

Procedure

- 1 Peel off the tape that secures the hard-drive cable to the palm-rest assembly.
- 2 Using the pull tab, disconnect the hard-drive cable from the system board.
- 3 Remove the screws that secure the hard-drive assembly to the palm-rest assembly.

- 4 Lift the hard-drive assembly, along with its cable, off the palm-rest assembly.

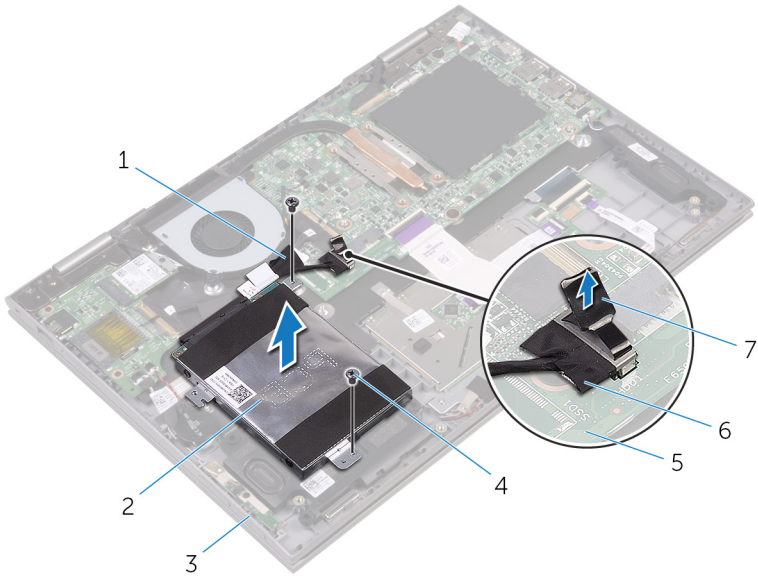

- | | | | |
|---|--------------------|---|---------------------|
| 1 | tape | 2 | hard-drive assembly |
| 3 | palm-rest assembly | 4 | screws (2) |
| 5 | system board | 6 | hard-drive cable |
| 7 | pull tab | | |

- 5 Disconnect the interposer from the hard-drive assembly.

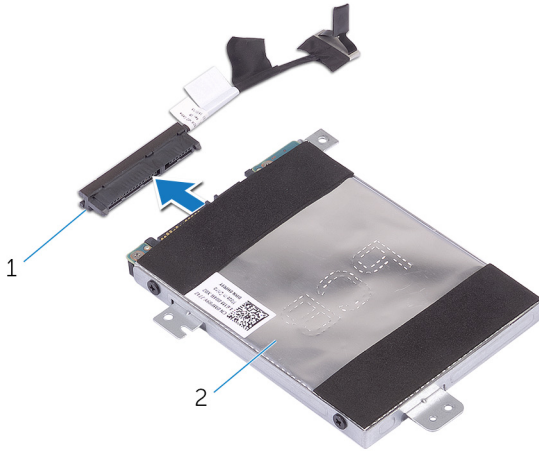

1 interposer

2 hard-drive assembly

- 6 Remove the screws that secure the hard-drive bracket to the hard drive.
7 Lift the hard-drive bracket off the hard drive.

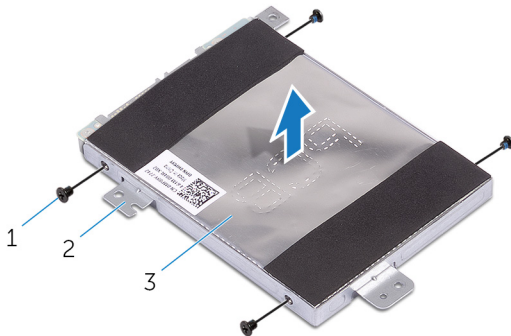



1 screws (4)

2 hard-drive bracket

3 hard drive

Replacing the hard drive

-  **WARNING:** Before working inside your computer, read the safety information that shipped with your computer and follow the steps in [Before working inside your computer](#). After working inside your computer, follow the instructions in [After working inside your computer](#). For more safety best practices, see the Regulatory Compliance home page at www.dell.com/regulatory_compliance.
-  **CAUTION:** Hard drives are fragile. Exercise care when handling the hard drive.



Procedure

- 1 Align the screw holes on the hard-drive bracket with the screw holes on the hard drive.
- 2 Replace the screws that secure the hard-drive bracket to the hard drive.
- 3 Connect the interposer to the hard-drive assembly.
- 4 Align the screw holes on the hard-drive assembly with the screw holes on the palm-rest assembly.
- 5 Replace the screws that secure the hard-drive assembly to the palm-rest assembly.
- 6 Connect the hard-drive cable to the system board.
- 7 Adhere the tape that secures the hard-drive cable to the palm-rest assembly.

Post-requisites

- 1 Replace the [battery](#).
- 2 Replace the [base cover](#).

Removing the coin-cell battery

-  **WARNING:** Before working inside your computer, read the safety information that shipped with your computer and follow the steps in [Before working inside your computer](#). After working inside your computer, follow the instructions in [After working inside your computer](#). For more safety best practices, see the Regulatory Compliance home page at www.dell.com/regulatory_compliance.
-  **CAUTION:** Removing the coin-cell battery resets the BIOS setup program's settings to default. It is recommended that you note the BIOS setup program's settings before removing the coin-cell battery.

Prerequisites

- 1 Remove the [base cover](#).
- 2 Remove the [battery](#).

Procedure

- 1 Disconnect the coin-cell battery cable from the I/O board.

2 Peel the coin-cell battery off the palm-rest assembly.

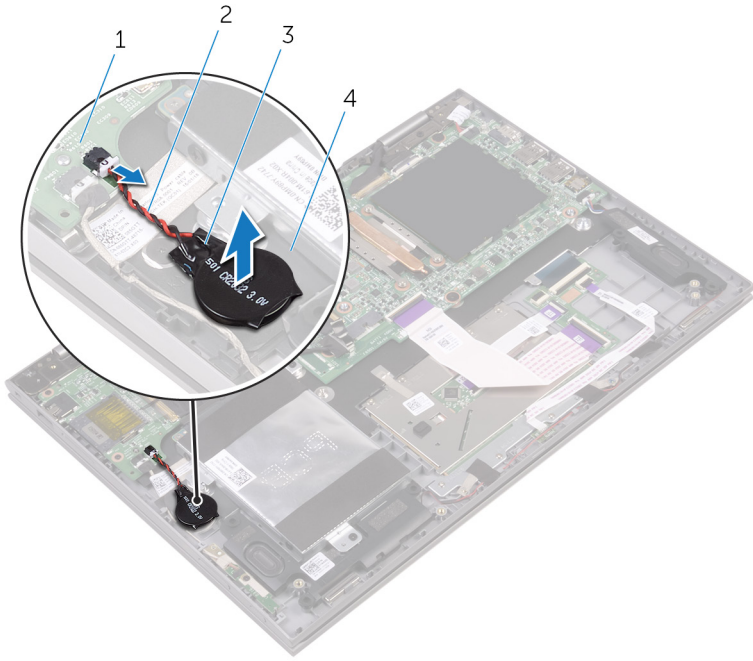

1 I/O board

2 coin-cell battery cable

3 coin-cell battery

4 palm-rest assembly

Replacing the coin-cell battery



WARNING: Before working inside your computer, read the safety information that shipped with your computer and follow the steps in [Before working inside your computer](#). After working inside your computer, follow the instructions in [After working inside your computer](#). For more safety best practices, see the Regulatory Compliance home page at www.dell.com/regulatory_compliance.

Procedure

- 1 Adhere the coin-cell battery to the palm-rest assembly.
- 2 Connect the coin-cell battery cable to the I/O board.

Post-requisites

- 1 Replace the [battery](#).
- 2 Replace the [base cover](#).

Removing the wireless card



WARNING: Before working inside your computer, read the safety information that shipped with your computer and follow the steps in [Before working inside your computer](#). After working inside your computer, follow the instructions in [After working inside your computer](#). For more safety best practices, see the Regulatory Compliance home page at www.dell.com/regulatory_compliance.

Prerequisites

- 1 Remove the [base cover](#).
- 2 Remove the [battery](#).

Procedure

- 1 Remove the screw that secures the wireless-card bracket to the wireless card.
- 2 Disconnect the antenna cables from the wireless card.

3 Slide and remove the wireless card from the wireless-card slot.

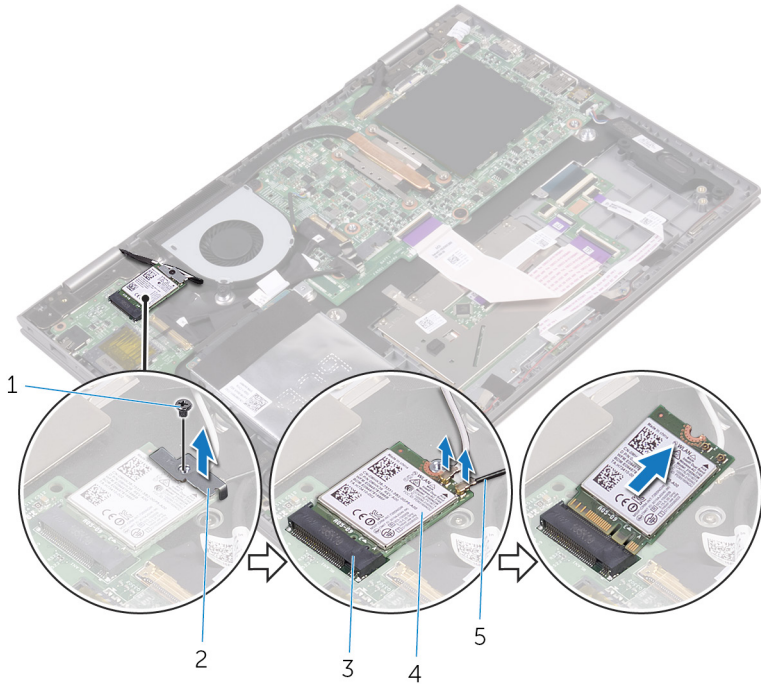

- | | | | |
|---|--------------------|---|-----------------------|
| 1 | screw | 2 | wireless-card bracket |
| 3 | wireless-card slot | 4 | wireless card |
| 5 | antenna cables (2) | | |

Replacing the wireless card

 **WARNING:** Before working inside your computer, read the safety information that shipped with your computer and follow the steps in [Before working inside your computer](#). After working inside your computer, follow the instructions in [After working inside your computer](#). For more safety best practices, see the Regulatory Compliance home page at www.dell.com/regulatory_compliance.

Procedure

 **CAUTION:** To avoid damage to the wireless card, do not place any cables under it.

- 1 Align the notch on the wireless card with the tab on the wireless-card slot.
- 2 Insert the wireless card at an angle into the wireless-card slot.
- 3 Connect the antenna cables to the wireless card.

The following table provides the antenna-cable color scheme for the wireless card supported by your computer.

Connectors on the wireless card	Antenna-cable color
Main (white triangle)	White
Auxiliary (black triangle)	Black

- 4 Align the screw hole on the wireless card bracket with the screw hole on the wireless card.

- 5 Replace the screw that secures the wireless card bracket to the wireless card.

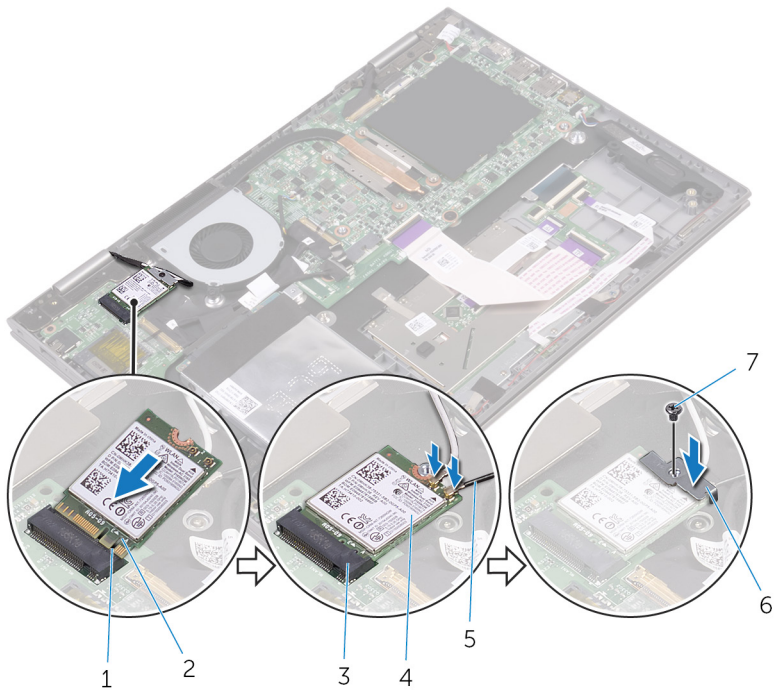

- | | | | |
|---|--------------------|---|-----------------------|
| 1 | tab | 2 | notch |
| 3 | wireless-card slot | 4 | wireless card |
| 5 | antenna cables (2) | 6 | wireless card bracket |
| 7 | screw | | |

Post-requisites

- 1 Replace the [battery](#).
- 2 Replace the [base cover](#).

Removing the keyboard daughter-board



WARNING: Before working inside your computer, read the safety information that shipped with your computer and follow the steps in [Before working inside your computer](#). After working inside your computer, follow the instructions in [After working inside your computer](#). For more safety best practices, see the Regulatory Compliance home page at www.dell.com/regulatory_compliance.

Prerequisites

- 1 Remove the [base cover](#).
- 2 Remove the [battery](#).

Procedure

- 1 Open the latches and disconnect the keyboard cable, keyboard daughter-board cable, touch-pad cable, and status-light board-cable from the keyboard daughter-board.

- 2 Using a plastic scribe, pry the keyboard daughter-board off the palm-rest assembly.

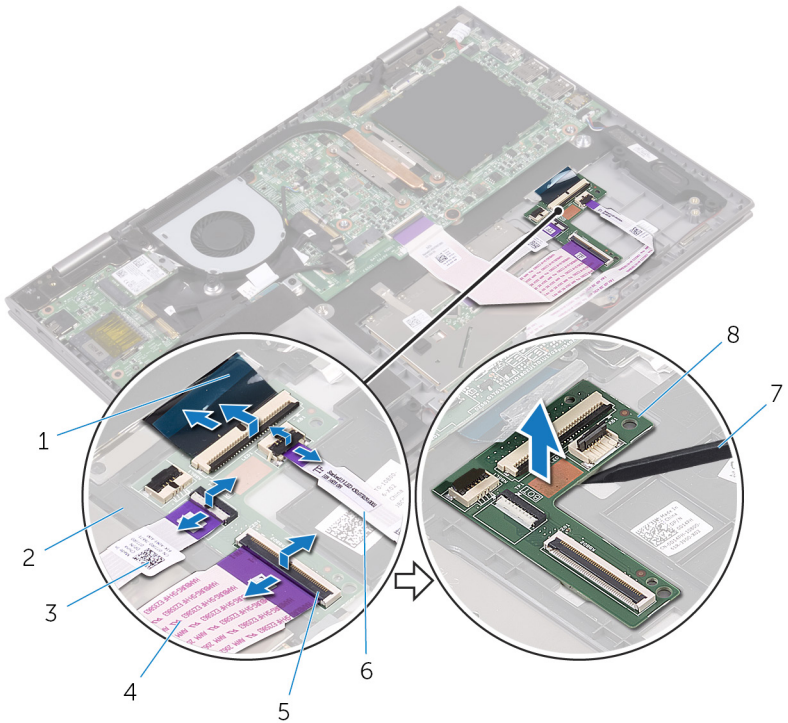

1 keyboard cable

3 touch-pad cable

5 latch

7 plastic scribe

2 palm-rest assembly

4 keyboard daughter-board cable

6 status-light board-cable

8 keyboard daughter-board

Replacing the keyboard daughter-board



WARNING: Before working inside your computer, read the safety information that shipped with your computer and follow the steps in [Before working inside your computer](#). After working inside your computer, follow the instructions in [After working inside your computer](#). For more safety best practices, see the Regulatory Compliance home page at www.dell.com/regulatory_compliance.

Procedure

- 1 Adhere the keyboard daughter board on the palm-rest assembly.
- 2 Connect the keyboard cable, keyboard daughter-board cable, touch-pad cable, and status-light board-cable and close the latches to secure the cables.

Post-requisites

- 1 Replace the [battery](#).
- 2 Replace the [base cover](#).

Removing the speakers



WARNING: Before working inside your computer, read the safety information that shipped with your computer and follow the steps in [Before working inside your computer](#). After working inside your computer, follow the instructions in [After working inside your computer](#). For more safety best practices, see the Regulatory Compliance home page at www.dell.com/regulatory_compliance.

Prerequisites

- 1 Remove the [base cover](#).
- 2 Remove the [battery](#).

Procedure

- 1 Disconnect the speaker cable from the system board.
- 2 Peel off the pieces of tape that secure the speaker cable to the palm-rest assembly.
- 3 Remove the speaker cable from the routing guides on the palm-rest assembly.
- 4 Note the position of the rubber grommets before lifting the speaker.

- 5 Remove the speakers from the alignment posts and lift the speakers off the palm-rest assembly.

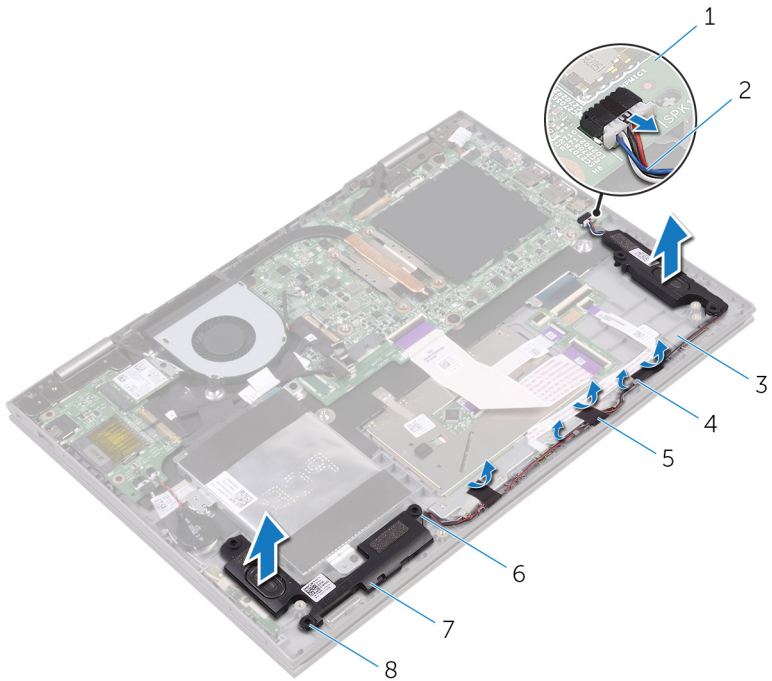

- | | | | |
|---|--------------------|---|---------------------|
| 1 | system board | 2 | speaker cable |
| 3 | palm-rest assembly | 4 | routing guides |
| 5 | tape (3) | 6 | alignment posts |
| 7 | speakers (2) | 8 | rubber grommets (5) |

Replacing the speakers



WARNING: Before working inside your computer, read the safety information that shipped with your computer and follow the steps in [Before working inside your computer](#). After working inside your computer, follow the instructions in [After working inside your computer](#). For more safety best practices, see the Regulatory Compliance home page at www.dell.com/regulatory_compliance.

Procedure



NOTE: The rubber grommets may get pushed out while replacing the speaker. Ensure that the rubber grommets are in their position after placing the speaker on the palm-rest assembly.

- 1 Using the alignment posts, align and place the speakers on the palm-rest assembly.
- 2 Replace the rubber grommets if they are pushed up while replacing the speaker.
- 3 Route the speaker cable through the routing guides on the palm-rest assembly.
- 4 Adhere the pieces of tape that secure the speaker cable to the palm-rest assembly.
- 5 Connect the speaker cable to the system board.

Post-requisites

- 1 Replace the [battery](#).
- 2 Replace the [base cover](#).

Removing the fan



WARNING: Before working inside your computer, read the safety information that shipped with your computer and follow the steps in [Before working inside your computer](#). After working inside your computer, follow the instructions in [After working inside your computer](#). For more safety best practices, see the Regulatory Compliance home page at www.dell.com/regulatory_compliance.

Prerequisites

- 1 Remove the [base cover](#).
- 2 Remove the [battery](#).

Procedure

- 1 Remove the screws that secure the fan to the palm-rest assembly.
- 2 Disconnect the fan cable from the system board.

3 Lift the fan off the palm-rest assembly.

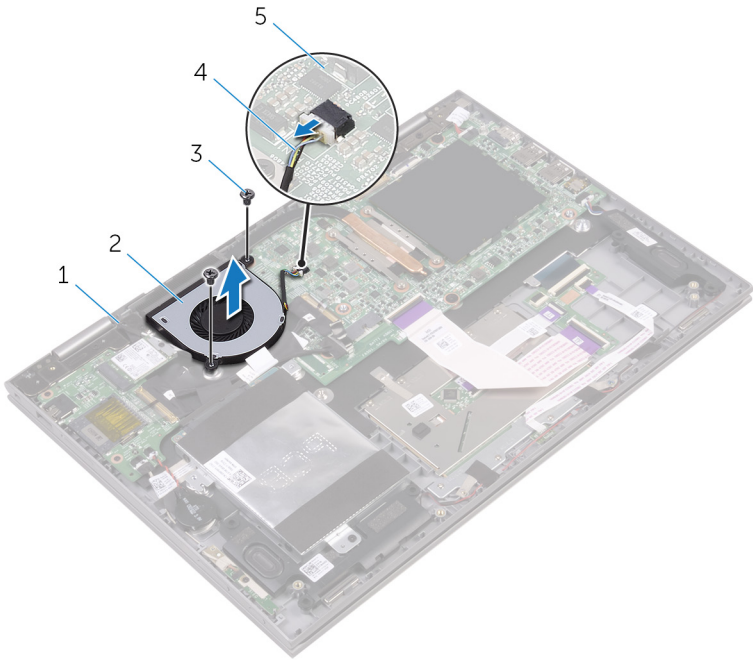

- 1 palm-rest assembly
- 3 screws (2)
- 5 system board

- 2 fan
- 4 fan cable

Replacing the fan



WARNING: Before working inside your computer, read the safety information that shipped with your computer and follow the steps in [Before working inside your computer](#). After working inside your computer, follow the instructions in [After working inside your computer](#). For more safety best practices, see the Regulatory Compliance home page at www.dell.com/regulatory_compliance.

Procedure

- 1 Align the screw holes on the fan with the screw holes on the palm-rest assembly.
- 2 Replace the screws that secure the fan to the palm-rest assembly.
- 3 Connect the fan cable to the system board.

Post-requisites

- 1 Replace the [battery](#).
- 2 Replace the [base cover](#).

Removing the heat sink

 **WARNING:** Before working inside your computer, read the safety information that shipped with your computer and follow the steps in [Before working inside your computer](#). After working inside your computer, follow the instructions in [After working inside your computer](#). For more safety best practices, see the Regulatory Compliance home page at www.dell.com/regulatory_compliance.

 **WARNING:** The heat sink may become hot during normal operation. Allow sufficient time for the heat sink to cool before you touch it.

 **CAUTION:** For maximum cooling of the processor, do not touch the heat transfer areas on the heat sink. The oils in your skin can reduce the heat transfer capability of the thermal grease.

Prerequisites

- 1 Remove the [base cover](#).
- 2 Remove the [battery](#).

Procedure

- 1 In sequential order (as indicated on the heat sink), loosen the captive screws that secure the heat sink to the system board.

2 Lift the heat sink off the system board.

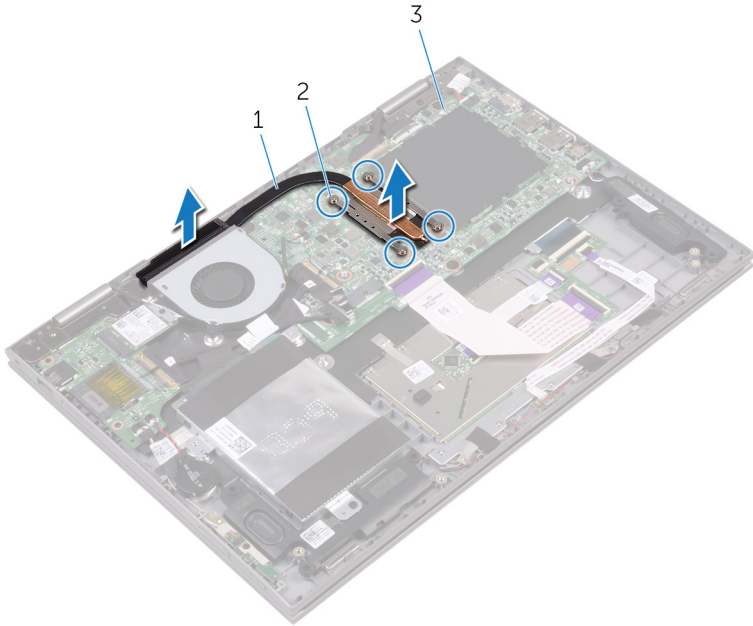



1 heat sink

2 captive screws (4)

3 system board

Replacing the heat sink

 **WARNING:** Before working inside your computer, read the safety information that shipped with your computer and follow the steps in [Before working inside your computer](#). After working inside your computer, follow the instructions in [After working inside your computer](#). For more safety best practices, see the Regulatory Compliance home page at www.dell.com/regulatory_compliance.

 **CAUTION:** Incorrect alignment of the heat sink can damage the system board and processor.

 **NOTE:** The original thermal grease can be reused if the original system board and heat sink are reinstalled together. If either the system board or the heat sink is replaced, use the thermal pad provided in the kit to ensure that thermal conductivity is achieved.

Procedure

- 1 Place the heat sink on the system board.
- 2 Align the screw holes on the heat sink with the screw holes on the system board.
- 3 In sequential order (indicated on the heat sink), tighten the captive screws that secure the heat sink to the system board.

Post-requisites

- 1 Replace the [battery](#).
- 2 Replace the [base cover](#).

Removing the power and volume-buttons board



WARNING: Before working inside your computer, read the safety information that shipped with your computer and follow the steps in [Before working inside your computer](#). After working inside your computer, follow the instructions in [After working inside your computer](#). For more safety best practices, see the Regulatory Compliance home page at www.dell.com/regulatory_compliance.

Prerequisites

- 1 Remove the [base cover](#).
- 2 Remove the [battery](#).
- 3 Remove the [hard drive](#).

Procedure

- 1 Peel off the tape that secures the power and volume-buttons board-cable to the palm-rest assembly.
- 2 Disconnect the power and volume-buttons board-cable from the I/O board.
- 3 Remove the power and volume-buttons board-cable from the routing guides on the palm-rest assembly.
- 4 Remove the screw that secures the power and volume-buttons board to the palm-rest assembly.

5 Lift the power and volume-buttons board off the palm-rest assembly.

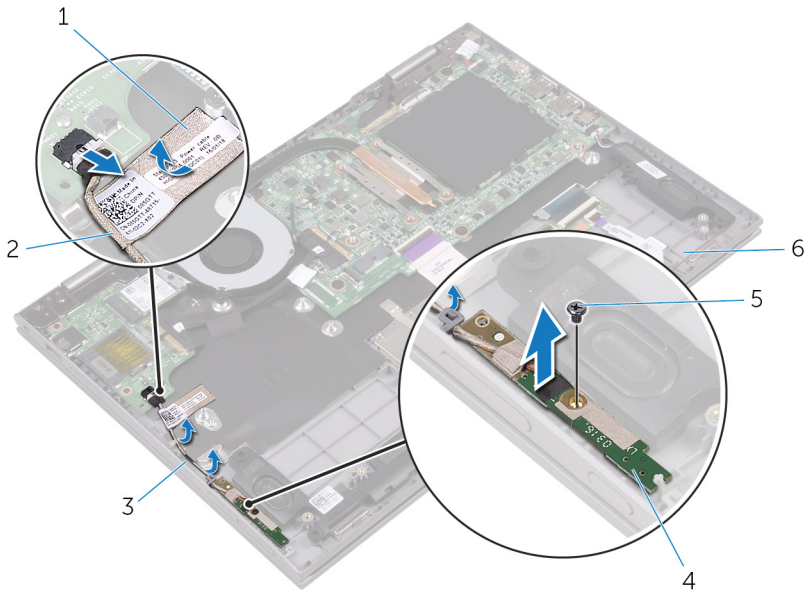

1 tape

3 routing guides (2)

5 screw

2 power and volume-
buttons board-cable

4 power and volume-
buttons board

6 palm-rest assembly

Replacing the power and volume-buttons board



WARNING: Before working inside your computer, read the safety information that shipped with your computer and follow the steps in [Before working inside your computer](#). After working inside your computer, follow the instructions in [After working inside your computer](#). For more safety best practices, see the Regulatory Compliance home page at www.dell.com/regulatory_compliance.

Procedure

- 1 Align the screw hole on the power and volume-buttons board with the screw hole on the palm-rest assembly.
- 2 Replace the screw that secures the power and volume-buttons board to the palm-rest assembly.
- 3 Route the power and volume-buttons board-cable through the routing guides on the palm-rest assembly.
- 4 Connect the power and volume-buttons board-cable to the I/O board.
- 5 Adhere the tape that secure the power and volume-buttons board-cable to the palm-rest assembly.

Post-requisites

- 1 Replace the [hard drive](#).
- 2 Replace the [battery](#).
- 3 Replace the [base cover](#).

Removing the status-light board

 **WARNING:** Before working inside your computer, read the safety information that shipped with your computer and follow the steps in [Before working inside your computer](#). After working inside your computer, follow the instructions in [After working inside your computer](#). For more safety best practices, see the Regulatory Compliance home page at www.dell.com/regulatory_compliance.

Prerequisites

- 1 Remove the [base cover](#).
- 2 Remove the [battery](#).

Procedure

- 1 Peel off the pieces of tape securing the speaker cable to the palm-rest assembly.
- 2 Remove the speaker cable from the routing guides on the palm-rest assembly.

- 3 Lift the speaker cable off the status-light board.

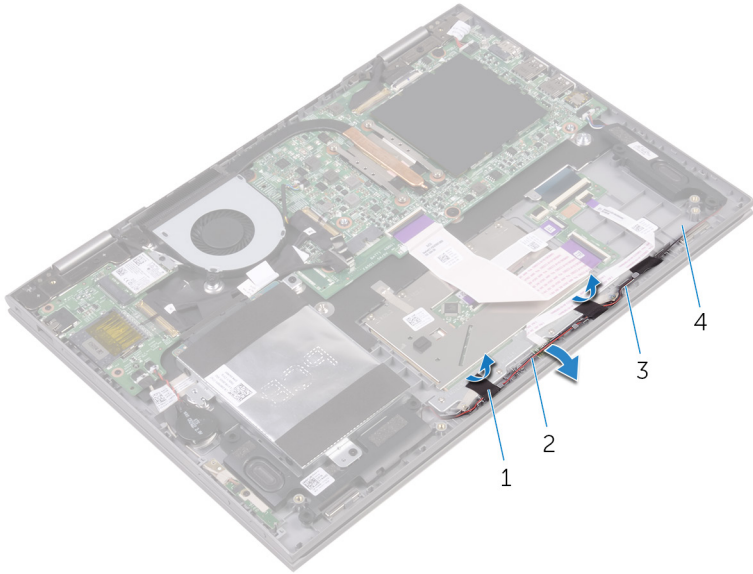

1 tape (2)

3 routing guides

2 speaker cable

4 palm-rest assembly

- 4 Open the latch and disconnect the status-light board-cable from the keyboard daughter-board.

5 Lift the status-light board off the palm-rest assembly.

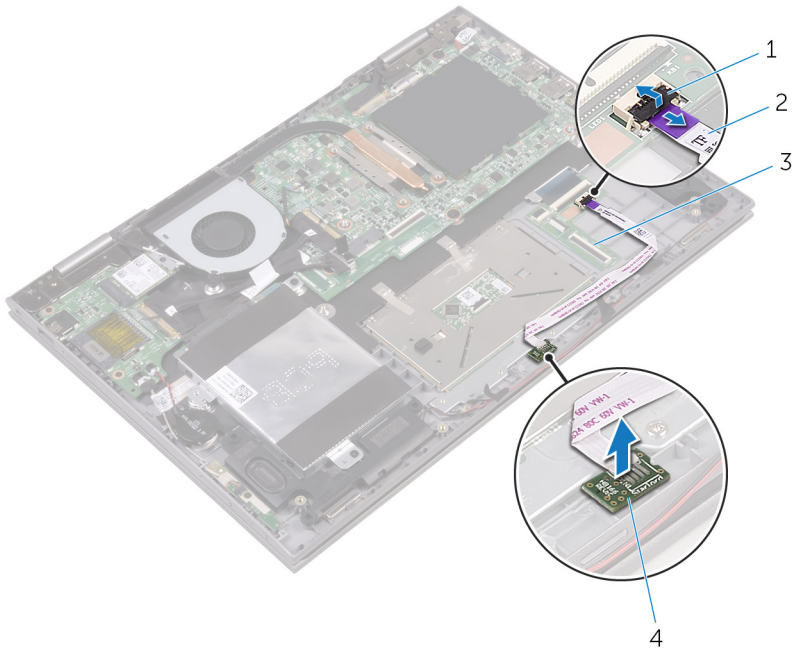

1 latch

2 status-light board-cable

3 keyboard daughter-board

4 status-light board

Replacing the status-light board

 **WARNING:** Before working inside your computer, read the safety information that shipped with your computer and follow the steps in [Before working inside your computer](#). After working inside your computer, follow the instructions in [After working inside your computer](#). For more safety best practices, see the Regulatory Compliance home page at www.dell.com/regulatory_compliance.

Procedure

- 1 Align and place the status-light board in the slot on the palm-rest assembly.
- 2 Slide the status-light board-cable into the connector on the keyboard daughter-board and close the latch to secure the cable.
- 3 Adhere the pieces of tape securing the speaker cable to the palm-rest assembly.

Post-requisites

- 1 Replace the [battery](#).
- 2 Replace the [base cover](#).

Removing the touch pad



WARNING: Before working inside your computer, read the safety information that shipped with your computer and follow the steps in [Before working inside your computer](#). After working inside your computer, follow the instructions in [After working inside your computer](#). For more safety best practices, see the Regulatory Compliance home page at www.dell.com/regulatory_compliance.

Prerequisites

- 1 Remove the [base cover](#).
- 2 Remove the [battery](#).
- 3 Remove the [status-light board](#).

Procedure

- 1 Open the latches and disconnect the keyboard daughter-board cable from the keyboard daughter-board and the system board.

- 2** Open the latches and disconnect the touch-pad cable from the touch pad and the keyboard daughter-board.

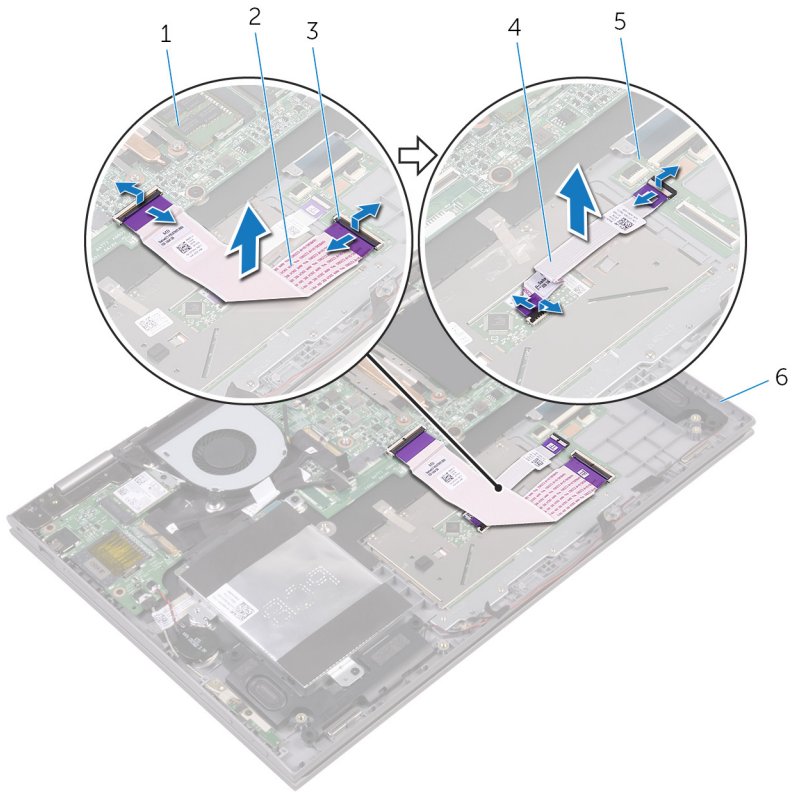

- | | | | |
|---|-------------------------|---|-------------------------------|
| 1 | system board | 2 | keyboard daughter-board cable |
| 3 | latch | 4 | touch-pad cable |
| 5 | keyboard daughter-board | 6 | palm-rest assembly |

- 3** Peel off the pieces of tape that secure the touch-pad to the palm-rest assembly.
- 4** Remove the screws that secure the touch-pad bracket to the palm-rest assembly.

- 5** Lift the touch-pad bracket off the palm-rest assembly.

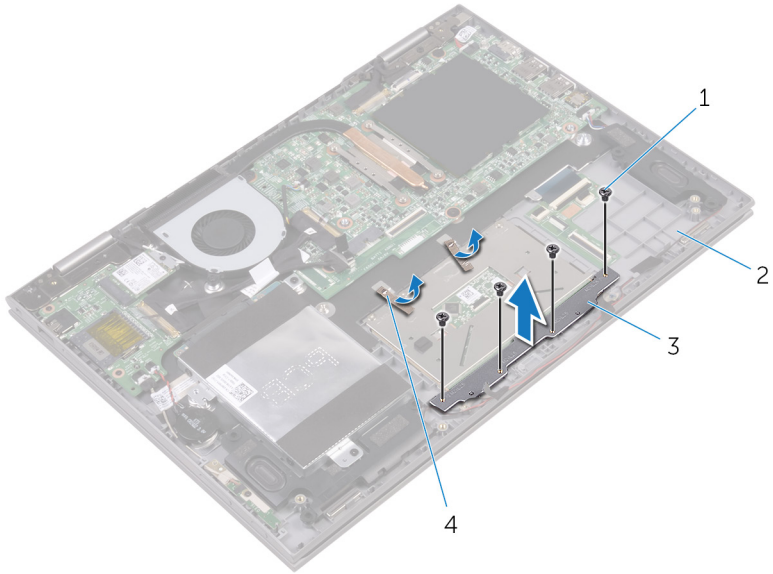

- | | | | |
|---|-------------------|---|--------------------|
| 1 | screws (4) | 2 | palm-rest assembly |
| 3 | touch-pad bracket | 4 | tape (2) |

- 6** Remove the screws that secure the touch pad to the palm-rest assembly.

7 Lift the touch pad off the palm-rest assembly.

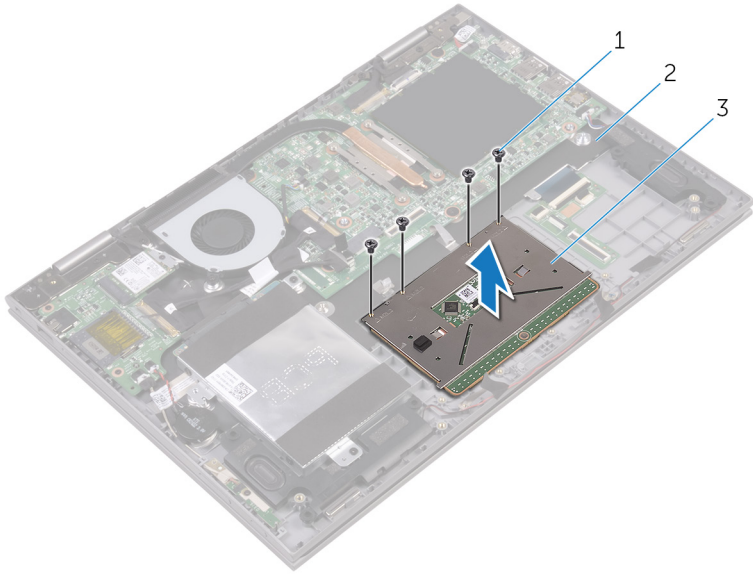

- 1 screws (4)
- 3 touch pad

- 2 palm-rest assembly

Replacing the touch pad



WARNING: Before working inside your computer, read the safety information that shipped with your computer and follow the steps in [Before working inside your computer](#). After working inside your computer, follow the instructions in [After working inside your computer](#). For more safety best practices, see the Regulatory Compliance home page at www.dell.com/regulatory_compliance.

Procedure

- 1 Place the touch pad on the palm-rest assembly.
- 2 Align the screw holes on the touch pad with the screw holes on the palm-rest assembly.
- 3 Replace the screws that secure the touch pad to the palm-rest assembly.
- 4 Align the screw holes on the touch-pad bracket with the screw holes on the palm-rest assembly.
- 5 Replace the screws that secure the touch-pad bracket to the palm-rest assembly.
- 6 Adhere the pieces of tape that secure the touch pad to the palm-rest assembly.
- 7 Slide both ends of the touch-pad cable into their respective connectors on the touch pad and keyboard daughter-board and close the latches to secure the cable.
- 8 Slide the keyboard daughter-board cable into their respective connectors on the system board and keyboard daughter-board and close the latches to secure the cable.

Post-requisites

- 1 Replace the [status-light board](#).
- 2 Replace the [battery](#).
- 3 Replace the [base cover](#).

Removing the I/O board



WARNING: Before working inside your computer, read the safety information that shipped with your computer and follow the steps in [Before working inside your computer](#). After working inside your computer, follow the instructions in [After working inside your computer](#). For more safety best practices, see the Regulatory Compliance home page at www.dell.com/regulatory_compliance.

Prerequisites

- 1 Remove the [base cover](#).
- 2 Remove the [battery](#).
- 3 Remove the [wireless card](#).

Procedure

- 1 Peel off the tape that secures the I/O-board cable to the I/O board.
- 2 Disconnect the I/O-board cable from the I/O board.
- 3 Peel off the tape that secures the power and volume-buttons board-cable to the palm-rest assembly.
- 4 Disconnect the power and volume-buttons board-cable from the I/O board.
- 5 Disconnect the coin-cell battery-cable from the I/O board.
- 6 Remove the screws that secure the I/O board to the palm-rest assembly.

7 Lift the I/O board off the palm-rest assembly.

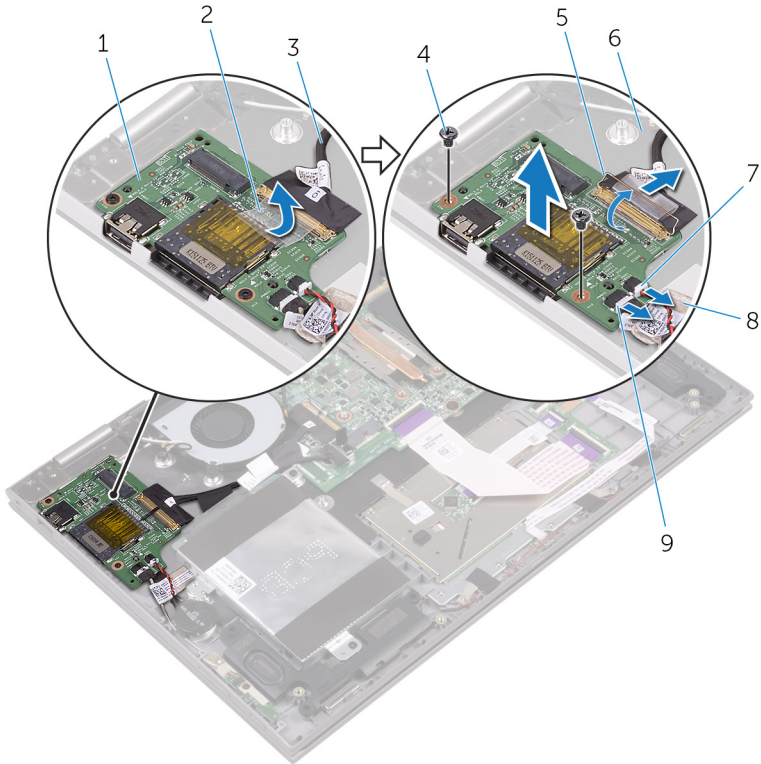

- | | | | |
|---|--------------------------------------|---|--------------------|
| 1 | I/O board | 2 | tape |
| 3 | I/O-board cable | 4 | screws (2) |
| 5 | latch | 6 | palm-rest assembly |
| 7 | coin-cell battery-cable | 8 | tape |
| 9 | power and volume-buttons board-cable | | |

Replacing the I/O board



WARNING: Before working inside your computer, read the safety information that shipped with your computer and follow the steps in [Before working inside your computer](#). After working inside your computer, follow the instructions in [After working inside your computer](#). For more safety best practices, see the Regulatory Compliance home page at www.dell.com/regulatory_compliance.

Procedure

- 1 Place the I/O board on the palm-rest assembly.
- 2 Align the screw hole on the I/O board with the screw hole on the palm-rest assembly.
- 3 Replace the screw that secures the I/O board to the palm-rest assembly.
- 4 Connect the power and volume-buttons board-cable and coin-cell battery-cable to the I/O board.
- 5 Connect the I/O-board cable to the I/O board.
- 6 Adhere the tape that secures the power and volume-buttons board-cable to the palm-rest assembly.
- 7 Adhere the tape that secures the I/O-board cable to the I/O board.

Post-requisites

- 1 Replace the [wireless card](#).
- 2 Replace the [battery](#).
- 3 Replace the [base cover](#).

Removing the display assembly



WARNING: Before working inside your computer, read the safety information that shipped with your computer and follow the steps in [Before working inside your computer](#). After working inside your computer, follow the instructions in [After working inside your computer](#). For more safety best practices, see the Regulatory Compliance home page at www.dell.com/regulatory_compliance.

Prerequisites

- 1 Remove the [base cover](#).
- 2 Remove the [battery](#).
- 3 Remove the [wireless card](#).

Procedure

- 1 Peel off the pieces of tape that secure the display cable and touch-screen board-cable to the system board.

- 2 Open the latches to disconnect the display cable and the touch-screen board-cable from the system board.

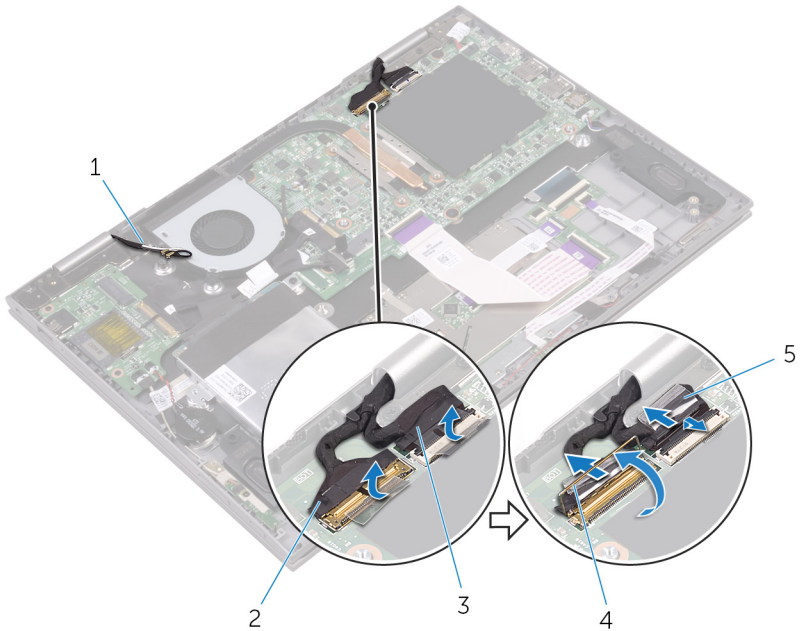

- | | | | |
|---|--------------------------|---|---------------|
| 1 | antenna cables (2) | 2 | display cable |
| 3 | touch-screen board-cable | 4 | latch |
| 5 | tape (2) | | |

- 3 Turn the computer over and open the display as far as possible.

⚠ CAUTION: Place the computer on a soft and clean surface to avoid scratching the display.

- 4 Place the computer face down on a flat surface.

5 Remove the screws that secure the display assembly to the palm-rest assembly.

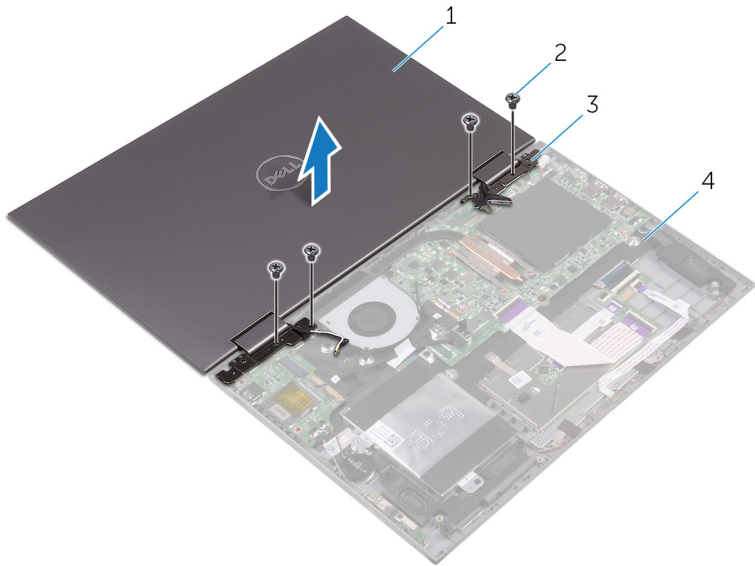

- 1 display assembly
- 3 display hinges (2)

- 2 screws (4)
- 4 palm-rest assembly

- 6 Lift the display assembly off the palm-rest assembly.



- 1 display assembly

Replacing the display assembly

 **WARNING:** Before working inside your computer, read the safety information that shipped with your computer and follow the steps in [Before working inside your computer](#). After working inside your computer, follow the instructions in [After working inside your computer](#). For more safety best practices, see the Regulatory Compliance home page at www.dell.com/regulatory_compliance.

Procedure

 **CAUTION:** Place the computer on a soft and clean surface to avoid scratching the display.

- 1 Place the display assembly face down on the palm-rest assembly.
- 2 Align the screw holes on the display hinges with the screw holes on the palm-rest assembly.
- 3 Replace the screws that secure the display assembly to the palm-rest assembly.
- 4 Close the display and turn the computer over.
- 5 Slide the display cable and the touch-screen board-cable into their respective connectors on the system board and close the latches to secure the cables.
- 6 Adhere the pieces of tape that secure the display cable and the touch-screen board-cable to their respective connectors on the system board.

Post-requisites

- 1 Replace the [wireless card](#).
- 2 Replace the [battery](#).
- 3 Replace the [base cover](#).

Removing the power-adapter port

 **WARNING:** Before working inside your computer, read the safety information that shipped with your computer and follow the steps in [Before working inside your computer](#). After working inside your computer, follow the instructions in [After working inside your computer](#). For more safety best practices, see the Regulatory Compliance home page at www.dell.com/regulatory_compliance.

Prerequisites

- 1 Remove the [base cover](#).
- 2 Remove the [battery](#).
- 3 Remove the [wireless card](#).
- 4 Remove the [display assembly](#).

Procedure

- 1 Disconnect the power-adapter port-cable from the system board.
- 2 Remove the screw that secures the power-adapter port to the palm-rest assembly.

3 Lift the power-adaptor port off the palm-rest assembly.

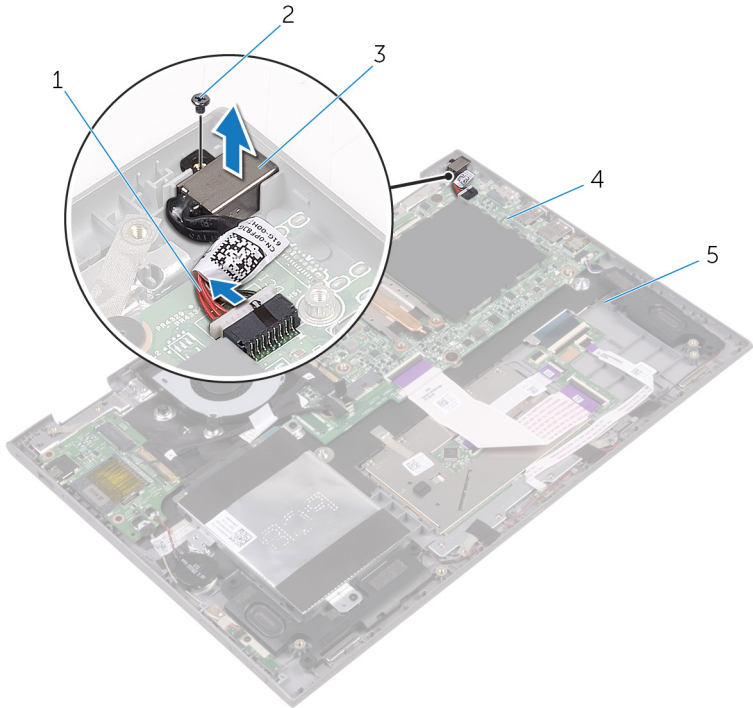

- 1 power-adaptor port-cable
- 3 power adapter port
- 5 palm-rest assembly

- 2 screw
- 4 system board

Replacing the power-adapter port



WARNING: Before working inside your computer, read the safety information that shipped with your computer and follow the steps in [Before working inside your computer](#). After working inside your computer, follow the instructions in [After working inside your computer](#). For more safety best practices, see the Regulatory Compliance home page at www.dell.com/regulatory_compliance.

Procedure

- 1 Place the power-adapter port into the slot on the palm-rest assembly.
- 2 Align the screw hole on the power-adapter port with the screw hole on the palm-rest assembly.
- 3 Replace the screw that secures the power-adapter port to the palm-rest assembly.
- 4 Connect the power-adapter port-cable to the system board.

Post-requisites

- 1 Replace the [display assembly](#).
- 2 Replace the [wireless card](#).
- 3 Replace the [battery](#).
- 4 Replace the [base cover](#).

Removing the system board



WARNING: Before working inside your computer, read the safety information that shipped with your computer and follow the steps in [Before working inside your computer](#). After working inside your computer, follow the instructions in [After working inside your computer](#). For more safety best practices, see the Regulatory Compliance home page at www.dell.com/regulatory_compliance.



NOTE: Your computer's Service Tag is stored in the system board. You must enter the Service Tag in the BIOS setup program after you replace the system board.



NOTE: Replacing the system board removes any changes you have made to the BIOS using the BIOS setup program. You must make the appropriate changes again after you replace the system board.



NOTE: Before disconnecting the cables from the system board, note the location of the connectors so that you can reconnect the cables correctly after you replace the system board.

Prerequisites

- 1 Remove the [base cover](#).
- 2 Remove the [battery](#).
- 3 Remove the [memory modules](#).
- 4 Remove the [fan](#).
- 5 Remove the [heat sink](#).

Procedure

- 1 Peel off the pieces of tape that secure the display cable and touch-screen board-cable to the system board.

- 2 Peel off the tape that secures the I/O-board cable to the system board.

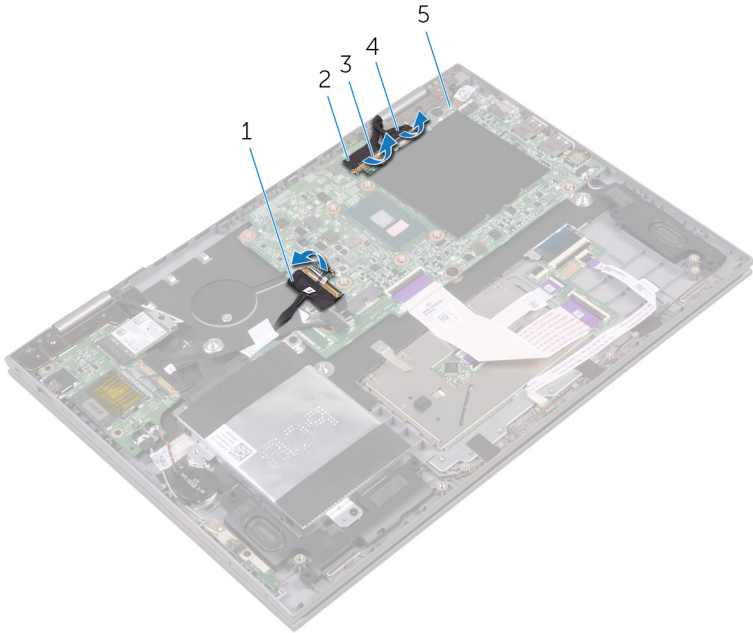

- | | | | |
|---|-----------------|---|--------------------|
| 1 | I/O-board cable | 2 | display cable |
| 3 | tape (3) | 4 | touch-screen cable |
| 5 | system board | | |

- 3 Open the latches to disconnect the display cable and the touch-screen board-cable from the system board.
- 4 Open the latch to disconnect the I/O-board cable from the system board.
- 5 Disconnect the power-adapter cable and the speaker cable from the system board.
- 6 Open the latch and disconnect the keyboard daughter-board cable from the system board.

7 Disconnect the hard-drive cable from the system board.

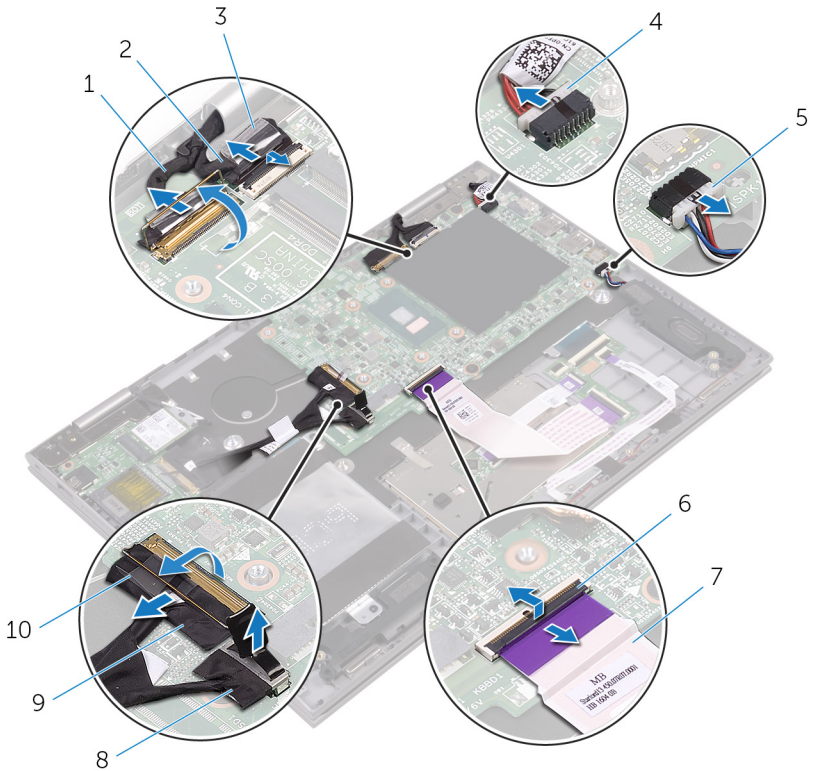

1 display cable

3 tape

5 speaker cable

7 keyboard daughter-board cable

9 I/O-board cable

2 touch-screen cable

4 power adapter port-cable

6 latch

8 hard-drive cable

10 tape

8 Remove the screws that secure the system board to the palm-rest assembly.

9 Lift the system board off the palm-rest assembly.

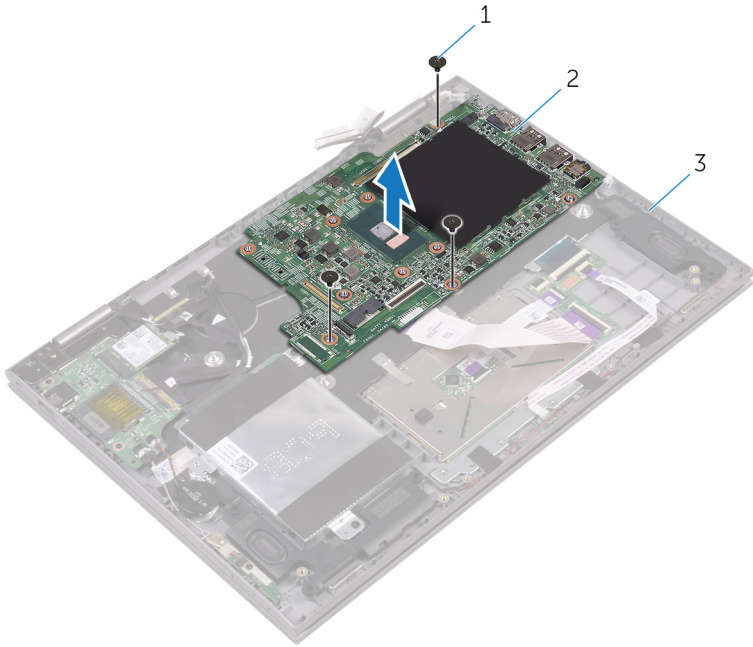

1 screw

2 system board

3 palm-rest assembly

Replacing the system board



WARNING: Before working inside your computer, read the safety information that shipped with your computer and follow the steps in [Before working inside your computer](#). After working inside your computer, follow the instructions in [After working inside your computer](#). For more safety best practices, see the Regulatory Compliance home page at www.dell.com/regulatory_compliance.



NOTE: Your computer's Service Tag is stored in the system board. You must enter the Service Tag in the BIOS setup program after you replace the system board.



NOTE: Replacing the system board removes any changes you have made to the BIOS using the BIOS setup program. You must make the appropriate changes again after you replace the system board.

Procedure

- 1 Align the screw holes on the system board with the screw holes on the palm-rest assembly.
- 2 Replace the screw that secures the system board to the palm-rest assembly.
- 3 Slide the I/O-board cable into the system-board connector close the latch to secure the cable.
- 4 Adhere the tape that secures the I/O-board cable to the system board.
- 5 Connect the power-adaptor port-cable and the speaker cable to the system board.
- 6 Slide the keyboard daughter-board cable into the connector on the system board and close the latch to secure the cable.
- 7 Connect the hard-drive cable to the system board.
- 8 Slide the display cable and the touch-screen board-cable into their respective connectors and close the latches to secure the cables.
- 9 Adhere the pieces of tape that secure the display cable and touch-screen board-cable to the system board.

Post-requisites

- 1 Replace the [heat sink](#).

- 2 Replace the [fan](#).
- 3 Replace the [memory modules](#).
- 4 Replace the [battery](#).
- 5 Replace the [base cover](#).

Entering the Service Tag in the BIOS setup program

- 1 Turn on or restart your computer.
- 2 Press F2 when the Dell logo is displayed to enter the BIOS setup program.
- 3 Navigate to the **Main** tab and enter the Service Tag in the **Service Tag Input** field.

Removing the palm rest and keyboard assembly

 **WARNING:** Before working inside your computer, read the safety information that shipped with your computer and follow the steps in [Before working inside your computer](#). After working inside your computer, follow the instructions in [After working inside your computer](#). For more safety best practices, see the Regulatory Compliance home page at www.dell.com/regulatory_compliance.

Prerequisites

- 1 Remove the [base cover](#).
- 2 Remove the [battery](#).
- 3 Remove the [memory modules](#).
- 4 Remove the [coin-cell battery](#).
- 5 Remove the [hard drive](#).
- 6 Remove the [wireless card](#).
- 7 Remove the [keyboard daughter-board](#).
- 8 Remove the [touch pad](#).
- 9 Remove the [fan](#).
- 10 Remove the [heat sink](#).
- 11 Remove the [I/O board](#).
- 12 Remove the [power and volume-buttons board](#).
- 13 Remove the [status-light board](#).
- 14 Remove the [speakers](#).
- 15 Remove the [display assembly](#).
- 16 Remove the [power-adapter port](#).
- 17 Remove the [system board](#).

Procedure

After performing the steps in prerequisites we are left with the palm-rest and keyboard assembly.

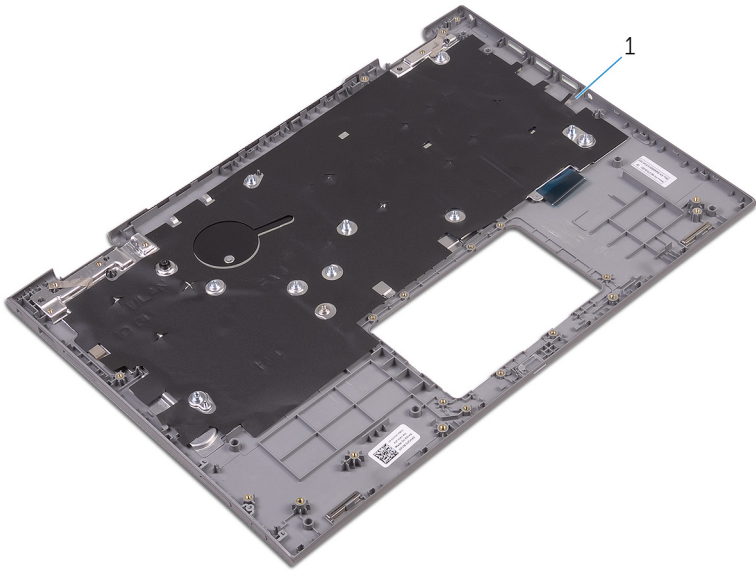

1 palm rest

Replacing the palm rest and keyboard assembly

 **WARNING:** Before working inside your computer, read the safety information that shipped with your computer and follow the steps in [Before working inside your computer](#). After working inside your computer, follow the instructions in [After working inside your computer](#). For more safety best practices, see the Regulatory Compliance home page at www.dell.com/regulatory_compliance.

Procedure

Place the palm-rest and keyboard assembly on a flat surface with the keyboard facing down.

Post-requisites

- 1 Replace the [system board](#).
- 2 Replace the [power-adapter port](#).
- 3 Replace the [display assembly](#).
- 4 Replace the [speakers](#).
- 5 Replace the [status-light board](#).
- 6 Replace the [power and volume-buttons board](#).
- 7 Replace the [I/O board](#).
- 8 Replace the [heat sink](#).
- 9 Replace the [fan](#).
- 10 Replace the [touch pad](#).
- 11 Replace the [keyboard daughter-board](#).
- 12 Replace the [wireless card](#).
- 13 Replace the [hard drive](#).
- 14 Replace the [coin-cell battery](#).
- 15 Replace the [memory modules](#).
- 16 Replace the [battery](#).
- 17 Replace the [base cover](#).

Removing the display panel



WARNING: Before working inside your computer, read the safety information that shipped with your computer and follow the steps in [Before working inside your computer](#). After working inside your computer, follow the instructions in [After working inside your computer](#). For more safety best practices, see the Regulatory Compliance home page at www.dell.com/regulatory_compliance.

Prerequisites

- 1 Remove the [base cover](#).
- 2 Remove the [battery](#).
- 3 Remove the [display assembly](#).

Procedure

- 1 Remove the display cable from the routing guides inside the hinge covers.

- 2** Using a plastic scribe, pry the display-panel assembly off the display back-cover and antenna assembly.

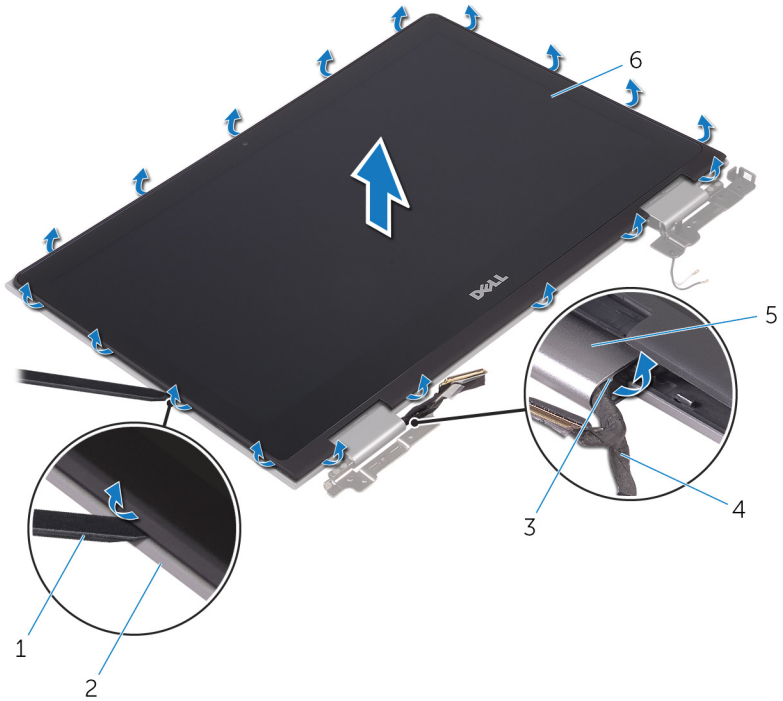

- | | | | |
|---|----------------|---|--------------------|
| 1 | plastic scribe | 2 | display back-cover |
| 3 | routing guides | 4 | display cable |
| 5 | hinge covers | 6 | display panel |

- 3** Turn over the display-panel assembly.
4 Remove the [camera](#).

- 5 Remove the [sensor board](#).

After performing the above steps, we are left with the display panel.



- 1 display panel

Replacing the display panel



WARNING: Before working inside your computer, read the safety information that shipped with your computer and follow the steps in [Before working inside your computer](#). After working inside your computer, follow the instructions in [After working inside your computer](#). For more safety best practices, see the Regulatory Compliance home page at www.dell.com/regulatory_compliance.

Procedure

- 1 Place the display panel on a flat surface.
- 2 Replace the [sensor board](#).
- 3 Replace the [camera](#).
- 4 Turn over the display-panel assembly.
- 5 Route the display cable through the routing guides inside the hinge covers.
- 6 Align the display-panel assembly with the display back-cover and antenna assembly and gently snap the display-panel assembly into place.

Post-requisites

- 1 Replace the [display assembly](#).
- 2 Replace the [battery](#).
- 3 Replace the [base cover](#).

Removing the display back-cover and antenna assembly

 **WARNING:** Before working inside your computer, read the safety information that shipped with your computer and follow the steps in [Before working inside your computer](#). After working inside your computer, follow the instructions in [After working inside your computer](#). For more safety best practices, see the Regulatory Compliance home page at www.dell.com/regulatory_compliance.

Prerequisites

- 1 Remove the [base cover](#).
- 2 Remove the [battery](#).
- 3 Remove the [display assembly](#).
- 4 Follow the procedure from step 1 to 2 in "[Removing the display panel](#)".

Procedure

After performing the steps in prerequisites we are left with the display back-cover and antenna assembly.

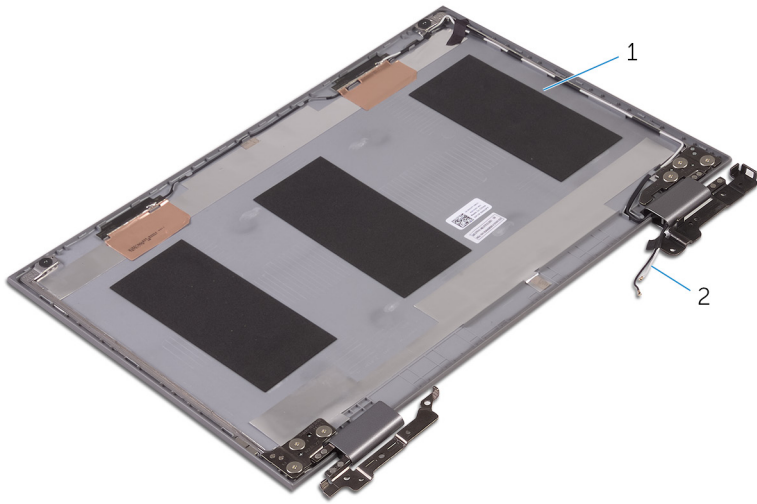

- 1 display back-cover and antenna 2 antenna cables assembly

Replacing the display back-cover and antenna assembly



WARNING: Before working inside your computer, read the safety information that shipped with your computer and follow the steps in [Before working inside your computer](#). After working inside your computer, follow the instructions in [After working inside your computer](#). For more safety best practices, see the Regulatory Compliance home page at www.dell.com/regulatory_compliance.

Procedure

Place the display back-cover and antenna assembly on a flat surface.

Post-requisites

- 1 Replace the [display panel](#).
- 2 Replace the [display assembly](#).
- 3 Replace the [battery](#).
- 4 Replace the [base cover](#).

Removing the camera

 **WARNING:** Before working inside your computer, read the safety information that shipped with your computer and follow the steps in [Before working inside your computer](#). After working inside your computer, follow the instructions in [After working inside your computer](#). For more safety best practices, see the Regulatory Compliance home page at www.dell.com/regulatory_compliance.

Prerequisites

- 1 Remove the [base cover](#).
- 2 Remove the [battery](#).
- 3 Remove the [display assembly](#).
- 4 Follow the procedure from step 1 to step 3 in "[Removing the display panel](#)".

Procedure

 **CAUTION:** Place the display-panel assembly on a soft and clean surface to avoid scratching the display.

- 1 Using a plastic scribe, pry the camera module off the display panel.

- 2 Turn the camera over and peel off the tape to disconnect the camera cable from the camera module.

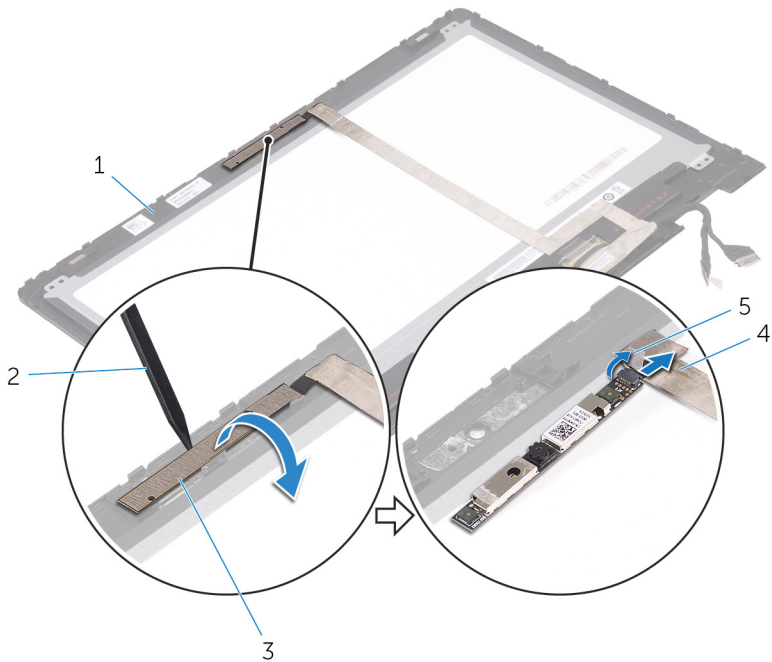

- | | | | |
|---|---------------|---|----------------|
| 1 | display panel | 2 | plastic scribe |
| 3 | camera module | 4 | camera cable |
| 5 | tape | | |

Replacing the camera



WARNING: Before working inside your computer, read the safety information that shipped with your computer and follow the steps in [Before working inside your computer](#). After working inside your computer, follow the instructions in [After working inside your computer](#). For more safety best practices, see the Regulatory Compliance home page at www.dell.com/regulatory_compliance.

Procedure

- 1 Connect the camera cable to the camera module.
- 2 Adhere the tape that secures the camera cable to the camera module.
- 3 Using the alignment post place the camera module on the display panel and snap it into place.

Post-requisites

- 1 Follow the procedure from step 4 to step 6 in "[Replacing the display panel](#)".
- 2 Replace the [display assembly](#).
- 3 Replace the [battery](#).
- 4 Replace the [base cover](#).

Removing the display cable



WARNING: Before working inside your computer, read the safety information that shipped with your computer and follow the steps in [Before working inside your computer](#). After working inside your computer, follow the instructions in [After working inside your computer](#). For more safety best practices, see the Regulatory Compliance home page at www.dell.com/regulatory_compliance.

Prerequisites

- 1 Remove the [base cover](#).
- 2 Remove the [battery](#).
- 3 Remove the [display assembly](#).
- 4 Follow the procedure from step 1 to step 3 in “[Removing the display panel](#)”.
- 5 Remove the [camera](#).

Procedure

- 1 Peel off the tape and open the latch to disconnect the display cable from the display panel.
- 2 Peel off the sensor-board cable tape and disconnect the sensor-board cable.
- 3 Open the connector latch and disconnect the display cable.
- 4 Note the display cable routing and remove the display cable from the routing guides on the display panel.

5 Lift the display cable off the display panel.

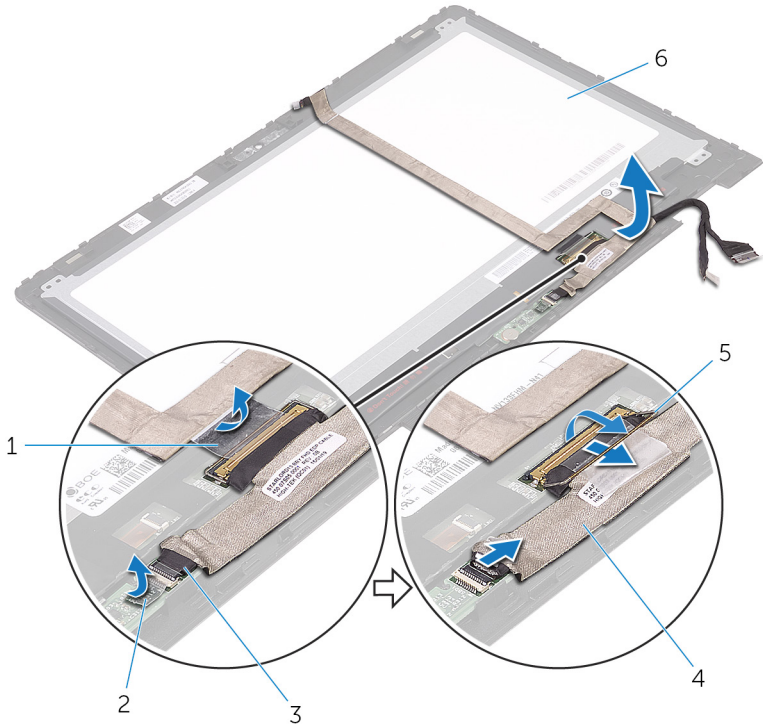

1 tape

3 sensor-board cable

5 latch

2 sensor-board cable tape

4 display cable

6 display panel

Replacing the display cable



WARNING: Before working inside your computer, read the safety information that shipped with your computer and follow the steps in [Before working inside your computer](#). After working inside your computer, follow the instructions in [After working inside your computer](#). For more safety best practices, see the Regulatory Compliance home page at www.dell.com/regulatory_compliance.

Procedure

- 1 Route the display cable through the routing guides on the display panel.
- 2 Slide the display cable into the connector and press down the latch to secure the cable.
- 3 Slide the sensor-board cable into the connector on the sensor board and press down the latch to secure the cable.
- 4 Adhere the sensor-board cable tape.
- 5 Adhere the tape that secures the display cable to the display panel.

Post-requisites

- 1 Follow the procedure from step 4 to step 6 in "[Replacing the display panel](#)".
- 2 Replace the [display assembly](#).
- 3 Replace the [camera](#).
- 4 Replace the [battery](#).
- 5 Replace the [base cover](#).

Removing the sensor board



WARNING: Before working inside your computer, read the safety information that shipped with your computer and follow the steps in [Before working inside your computer](#). After working inside your computer, follow the instructions in [After working inside your computer](#). For more safety best practices, see the Regulatory Compliance home page at www.dell.com/regulatory_compliance.

Prerequisites

- 1 Remove the [base cover](#).
- 2 Remove the [battery](#).
- 3 Remove the [display assembly](#).
- 4 Follow the procedure from step 1 to step 3 in "[Removing the display panel](#)".

Procedure



CAUTION: Place the display-panel assembly on a soft and clean surface to avoid scratching the display.

- 1 Remove the screw that secures the sensor board to the display panel.
- 2 Peel off the tape and open the latch to disconnect the sensor-board cable from the sensor board.

3 Lift the sensor board off the display panel.

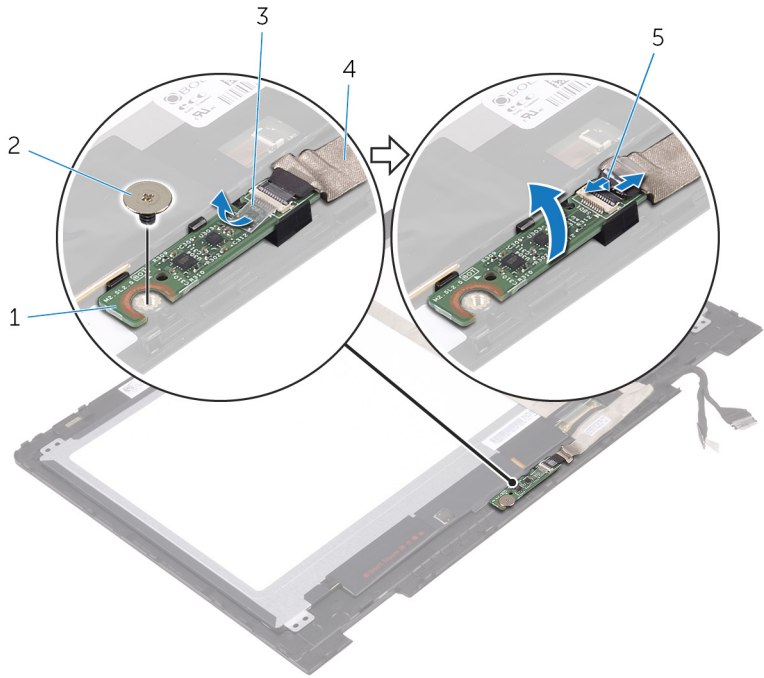

1 sensor board

2 screw

3 tape

4 sensor-board cable

5 latch

Replacing the sensor board



WARNING: Before working inside your computer, read the safety information that shipped with your computer and follow the steps in [Before working inside your computer](#). After working inside your computer, follow the instructions in [After working inside your computer](#). For more safety best practices, see the Regulatory Compliance home page at www.dell.com/regulatory_compliance.

Procedure

- 1 Align the screw hole on the sensor board to the display panel and snap the sensor board in place.
- 2 Slide the sensor-board cable into the slot on sensor board and press down the latch to secure the cable.
- 3 Adhere the tape on the sensor-board connector to secure the cable.
- 4 Replace the screw that secures the sensor board to the display panel.

Post-requisites

- 1 Follow the procedure from step 4 to step 6 in "[Replacing the display panel](#)".
- 2 Replace the [display assembly](#).
- 3 Replace the [battery](#).
- 4 Replace the [base cover](#).

Flashing the BIOS

You may need to flash (update) the BIOS when an update is available or when you replace the system board. To flash the BIOS:

- 1 Turn on your computer.
- 2 Go to www.dell.com/support.
- 3 Click or tap **Product support**, enter the Service Tag of your computer, and then click or tap **Submit**.



NOTE: If you do not have the Service Tag, use the auto-detect feature or manually browse for your computer model.

- 4 Click or tap **Drivers & downloads** → **Find it myself**.
- 5 Select the operating system installed on your computer.
- 6 Scroll down the page and expand **BIOS**.
- 7 Click or tap **Download** to download the latest version of the BIOS for your computer.
- 8 After the download is complete, navigate to the folder where you saved the BIOS update file.
- 9 Double-click or double-tap the BIOS update file icon and follow the instructions on the screen.

Technology and components

Audio

The Inspiron-5368 is shipped with Realtek ALC3253 with Waves MaxxAudio Pro, which is the utility to adjust various audio settings.



NOTE: The audio drivers are already installed when you receive your computer.

Downloading the audio driver

- 1 Turn on your computer.
- 2 Go to www.dell.com/support.
- 3 Click or tap **Product support**, enter the Service Tag of your computer and then click or tap **Submit**.



NOTE: If you do not have the Service Tag, use the auto-detect feature or manually browse for your computer model.

- 4 Click or tap **Drivers & downloads** → **Find it myself**.
- 5 Scroll down the page and expand **Audio**.
- 6 Click or tap **Download** to download the audio driver for your computer.
- 7 After the download is complete, navigate to the folder where you saved the audio driver file.
- 8 Double-click or double-tap the audio driver file icon and follow the instructions on the screen to install the driver.

Identifying the audio controller

- 1 On the taskbar, click or tap the search box, and then type *Device Manager*.
- 2 Click or tap **Device Manager**.
The **Device Manager** window is displayed.

- 3 Expand **Sound, video and game controllers** to view the audio controller.

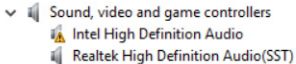
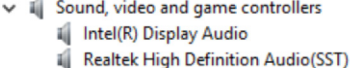
Before installation	After installation
	

Changing the audio settings

- 1 On the taskbar, click or tap the search box, and then type **Dell Audio**.
- 2 Click or tap **Dell Audio** and change the audio settings as required.

Camera

The Inspiron 13-5368 is shipped with an integrated 0.92 megapixel high-speed camera with a maximum of 1280 X 720 HD resolution at 30 FPS. The camera has built-in digital-array microphones.

 **NOTE:** You must replace the camera module if you encounter any issues with the built-in microphones.

Infrared camera – optional - Allows you to video chat, capture photos, and record videos. Depth-sensing feature of the camera enhances security when paired with Windows Hello.

Identifying the webcam in device manager

- 1 On the taskbar, click or tap the search box, and then type **Device Manager**.
- 2 Click or tap **Device Manager**.
The **Device Manager** window is displayed.
- 3 Expand **Imaging Devices**.

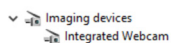

Starting the camera application

- 1 On the taskbar, click or tap the search box, and then type **Camera**.

2 Click or tap **Camera**.

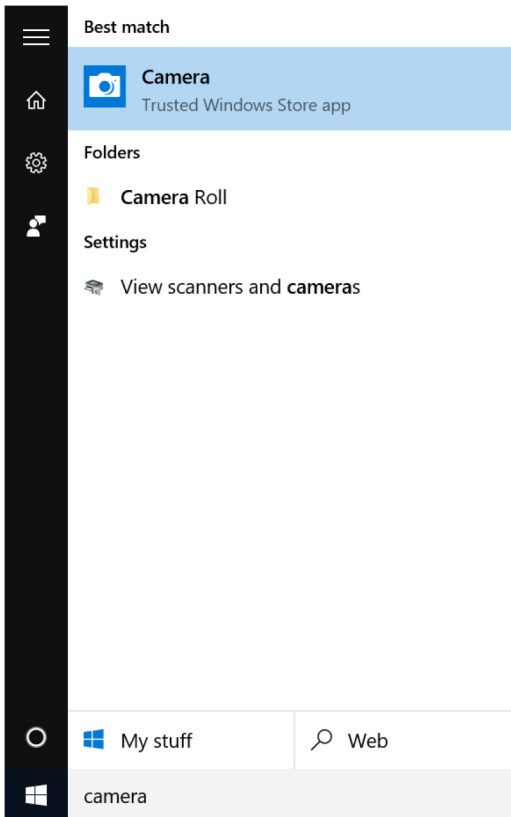

Getting the Dell Webcam Central

A CD is shipped along with your computer, which contains the Dell Webcam Central software. If you do not have the software, you can download it by registering through My Account on the Dell website.

 **NOTE:** The Dell Webcam Central is not available for download from the support site or the resource CD.

Display

The Inspiron 13-5368 is shipped with the following display options:

- 13.3-inch HD WLED touch with 1366 X 768 resolution
- 13.3-inch FHD WLED touch screen with 1920 X 1080 resolution

Adjusting the brightness

- 1 Right-click or touch and hold on your desktop and select **Display settings**.
- 2 Drag or swipe the **Adjust brightness level** slider to adjust the brightness.

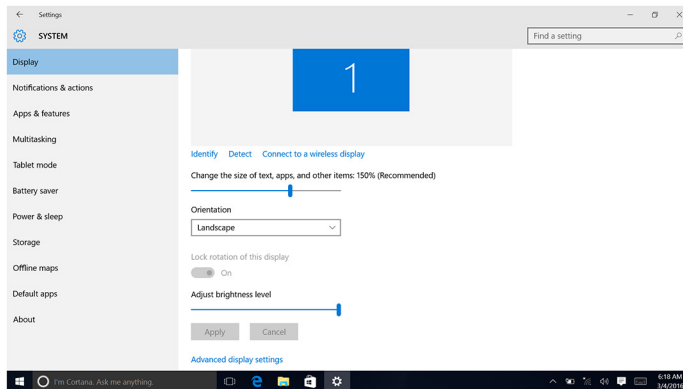

You can press F11 to decrease brightness and F12 to increase brightness.

Changing the screen resolution

- 1 Right-click or touch and hold on your desktop and select **Display settings**.
- 2 Click or tap **Advanced display settings**.
- 3 Select the appropriate resolution from the drop-down list.

4 Click or tap **Apply**.

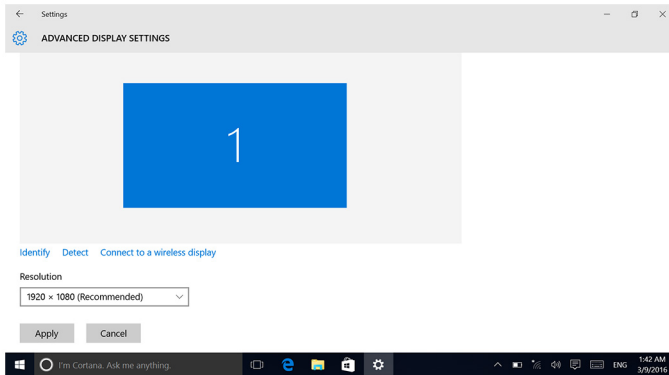

Rotating the display

- 1 Right-click or touch and hold on your desktop.
- 2 Select **Graphics Options** → **Rotation** and select from the following options:
 - Rotate to 0 Degrees
 - Rotate to 90 Degrees
 - Rotate to 180 Degrees
 - Rotate to 270 Degrees

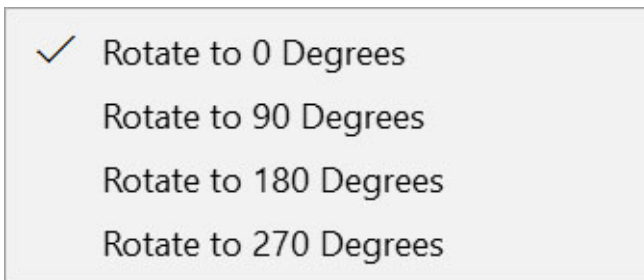



The display can also be rotated using the following key combinations:

- Ctrl + Alt + Up arrow key (Rotate to 0 Degrees)
- Ctrl + Alt + Right arrow key (Rotate to 90 Degrees)
- Ctrl + Alt + Down arrow key (Rotate to 180 Degrees)
- Ctrl + Alt + Left arrow key (Rotate to 270 Degrees)

Cleaning the display

 **CAUTION:** Do not use substances such as alcohol, chemicals, or household cleaners for cleaning the display.

 **CAUTION:** To avoid damaging the display, do not apply force when cleaning and wipe off any remaining liquid after cleaning.

 **NOTE:** A commercial display cleaning kit should be used for cleaning. If unavailable, use a soft, damp microfiber cloth lightly sprayed with distilled water.

- 1 Turn off your computer and display before cleaning.
- 2 Gently wipe the display in circular motions to remove any dust or dirt particles.
- 3 Let the display dry thoroughly before turning it on.

HDMI

The Inspiron 13-5368 supports HDMI to connect a TV or another HDMI-in enabled device. It provides video and audio output. The HDMI port is located on the left side of your computer.

 **NOTE:** Appropriate converters (sold separately) are required to connect standard DVI and DisplayPort devices.

Connecting to external display devices

- 1 Connect the HDMI cable to your computer and the external display.
- 2 Press F8 to display the different modes.

3 Select one of the following display modes:

- PC screen only
- Duplicate
- Extend
- Second screen only



NOTE: For more information, see the document that shipped with your display device.

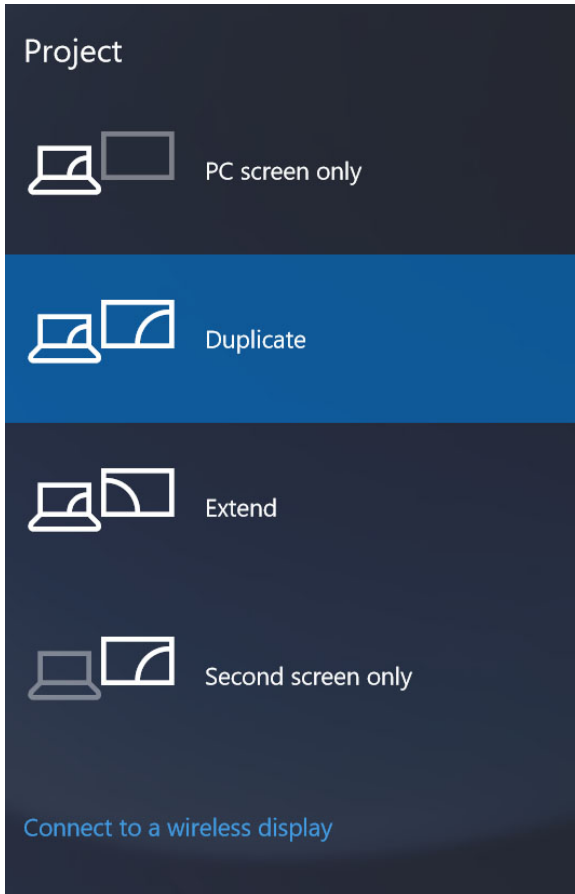

Graphics

The Inspiron 13-5368 is shipped with the following video controllers:

- Intel HD Graphics 510 - Intel Celeron and Pentium (Shared system memory)
- Intel HD Graphics 520 - Intel Core i3/i5/i7 (Shared system memory)
- Intel Iris Graphics 540 - Intel Core i7 (Shared system memory)

Downloading the graphics driver

- 1 Turn on your computer.
- 2 Go to www.dell.com/support.
- 3 Click or tap **Product Support**, enter the Service Tag of your computer and click or tap **Submit**.



NOTE: If you do not have the Service Tag, use the auto-detect feature or manually browse for your computer model.

- 4 Click or tap **Drivers & downloads** → **Find it myself**.
- 5 Scroll down the page and expand **Video**.
- 6 Click or tap **Download** to download the graphics driver for your computer.
- 7 After the download is complete, navigate to the folder where you saved the graphics driver file.
- 8 Double-click or double-tap the graphics driver file icon and follow the instructions on the screen to install the driver.

Identifying the display adapter

- 1 On the taskbar, click or tap the search box, and then type `Device Manager`.
- 2 Click or tap **Device Manager**.
The **Device Manager** window is displayed.
- 3 Expand **Display adapters**.

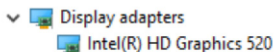

Changing the display settings in Intel HD Graphics Control Panel

- 1 Right-click or touch and hold on the desktop and select **Graphics Properties** to launch the **Intel HD Graphics Control Panel**.

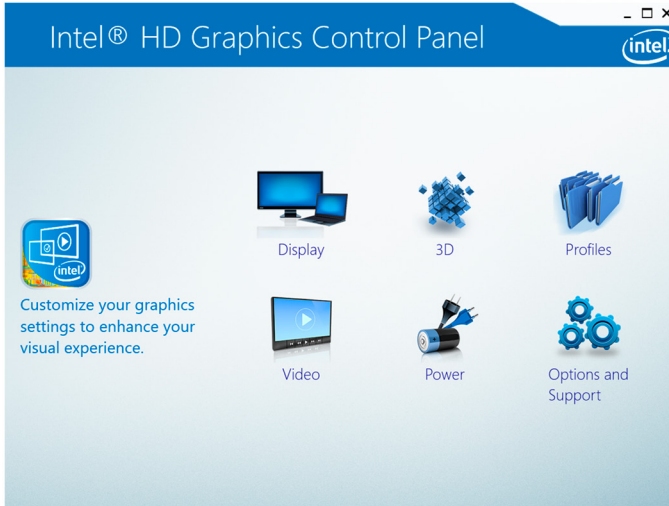

- 2 Click or tap **Display**.
- 3 Change the display settings as required.

Intel WiDi

The wireless display feature allows you to share your computer display with a compatible TV without using cables. You must connect a wireless display adapter to your TV before setting up the wireless display. To check if your TV supports this feature, see the documentation that is shipped with the TV.

The following table provides the basic system requirements for a wireless display.

Processor	2nd generation Intel Core i3, i5, i7
Video Controller	Intel HD Graphics
WLAN card	Intel 2230 or Intel 6150

Operating System	Windows 7 or later
Driver	Download and install the latest driver for “Intel Wireless Display Connection Manager” available at www.dell.com/support

Downloading the WiDi application

- 1 Turn on your computer.
- 2 Go to www.dell.com/support.
- 3 Click or tap **Product Support**, enter the Service Tag of your computer and click or tap **Submit**.
 **NOTE:** If you do not have the Service Tag, use the auto-detect feature or manually browse for your computer model.
- 4 Click or tap **Drivers & downloads** → **Find it myself**.
- 5 Scroll down the page and expand **Video**.
- 6 Click or tap **Download** to download the Intel WiDi application for your computer.
- 7 After the download is complete, navigate to the folder where you saved the WiDi application file.
- 8 Double-click or double-tap the application icon and follow the instructions on the screen to install the application.

Setting up the wireless display

- 1 Turn on your computer.
 **NOTE:** Ensure that Wi-Fi is enabled.
- 2 Connect the wireless display adapter to the TV.
- 3 Turn on the TV and the wireless display adapter.
- 4 Select the appropriate video source for your TV, such as HDMI1, HDMI2, or S-Video.
- 5 Double-click or double-tap the Intel Wireless Display icon on the desktop.
The **Intel Wireless Display** window is displayed.
- 6 Click or tap **Scan for available displays**.
- 7 Select your wireless display adapter from the **Detected Wireless Displays** list.
- 8 Enter the security code that appears on your TV.

USB

The following table shows the USB ports available in Inspiron 13-5368.

Ports	Location
USB 3.0 port	Left side
USB 3.0 port with PowerShare	Left side
USB 2.0 port	Right side

 **NOTE:** USB 3.0 needs the driver to be installed before it can detect any USB devices.

Downloading the USB 3.0 driver

- 1 Turn on your computer.
- 2 Go to www.dell.com/support.
- 3 Click or tap **Product Support**, enter the Service Tag of your computer and click or tap **Submit**.

 **NOTE:** If you do not have the Service Tag, use the auto-detect feature or manually browse for your computer model.

- 4 Click or tap **Drivers & Downloads** → **Find it myself**.
- 5 Scroll down the page and expand **Chipset**.
- 6 Click or tap **Download** to download the USB 3.0 driver for your computer.
- 7 After the download is complete, navigate to the folder where you saved USB 3.0 driver file.
- 8 Double-click or double-tap the USB 3.0 driver file icon and follow the instructions on screen to install the driver.

Enabling or disabling the USB in BIOS setup program

- 1 Turn on or restart your computer.
- 2 Press F2 when the Dell logo is displayed on the screen to enter the BIOS setup program.
The BIOS setup program is displayed.
- 3 On the left pane, select **Settings** → **System Configuration** → **USB Configuration**.
The USB configuration is displayed on the right pane.

- 4 Select the **Enable External USB Port** check box to either enable or disable it respectively.
- 5 Save the system setup settings and exit.

Fixing a no-boot issue caused by USB emulation

Sometimes the computer does not boot to the operating system when USB devices are connected to the computer during startup. This behavior occurs because the computer is looking for bootable files in the USB devices. Follow these steps to fix the no-boot issue:

- 1 Turn on or restart your computer.
- 2 Press F2 when the Dell logo is displayed on the screen to enter the BIOS setup program.
The BIOS setup program is displayed.
- 3 On the left pane, select **Settings** → **System Configuration** → **USB Configuration**.
The USB configuration is displayed on the right pane.
- 4 Clear the **Enable Boot Support** check box to disable it.
- 5 Save the settings and exit.

Wi-Fi

The Inspiron 13-5368 is shipped with Wi-Fi 802.11ac.

Turning on or off Wi-Fi

 **NOTE:** There is no physical switch to enable or disable Wi-Fi. It has to be done through computer settings.

- 1 Swipe-in from the right edge of the display, or click or tap the **Action Center** icon on the task bar to access the Action Center.
- 2 Click or tap **Wi-Fi** to turn Wi-Fi on or off.

Downloading the Wi-Fi driver

- 1 Turn on your computer.
- 2 Go to www.dell.com/support.

- 3 Click or tap **Product Support**, enter the Service Tag of your computer, and then click or tap **Submit**.
 -  **NOTE:** If you do not have the Service Tag, use the auto-detect feature or manually browse for your computer model.
- 4 Click or tap **Drivers & downloads** → **Find it myself**.
- 5 Scroll down the page and expand **Network**.
- 6 Click or tap **Download** to download the Wi-Fi driver for your computer.
- 7 After the download is complete, navigate to the folder where you saved the Wi-Fi driver file.
- 8 Double-click or double-tap the driver file icon and follow the on-screen instructions to install the driver.

Configuring Wi-Fi

- 1 Turn on Wi-Fi. For more information, see [Turning on or off Wi-Fi](#).
- 2 Swipe-in from the right edge of the display, or click or tap the **Action Center** icon on the task bar to access the Action Center.
- 3 Right-click or touch and hold **Wi-Fi**, and then click or tap **Go to settings**. A list of available networks is displayed.
- 4 Select your network and click or tap **Connect**.

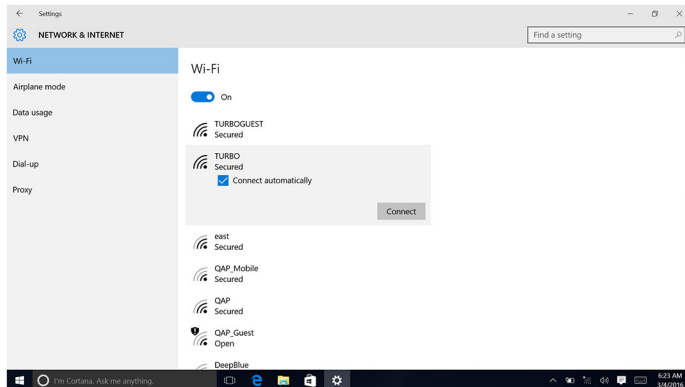

 **NOTE:** Type the network security key, if prompted.

Bluetooth

The Inspiron 13-5368 is shipped with Bluetooth 4.0 and Bluetooth 4.1 (optional).

Turning on or off Bluetooth



NOTE: There is no physical switch to enable or disable Bluetooth. It has to be done through the computer settings.

- 1 Swipe-in from the right edge of the display, or click or tap the **Action Center** icon on the task bar to access the Action Center.
- 2 Click or tap **Bluetooth** to turn Bluetooth on or off.

Pairing the Bluetooth-enabled devices

- 1 Turn on Bluetooth. For more information, see [Turning on or off Bluetooth](#).
- 2 Swipe-in from the right edge of the display, or click or tap the **Action Center** icon on the task bar to access the Action Center.
- 3 Right-click or touch and hold **Bluetooth**, and then click or tap **Go to settings**.
- 4 Select the required Bluetooth device for pairing.
- 5 Click or tap **Pair** to pair the bluetooth devices.

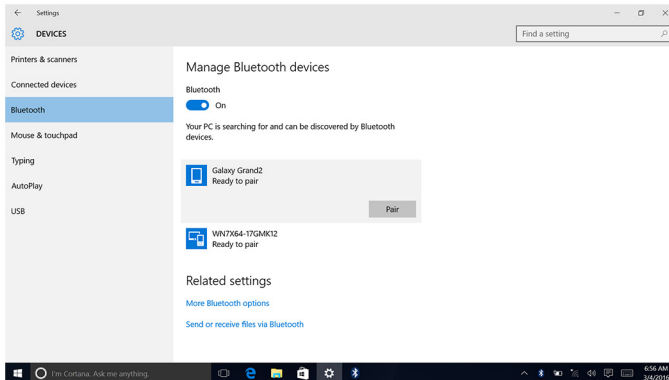

- 6 Click or tap **Yes** to confirm the passcodes on both the devices.

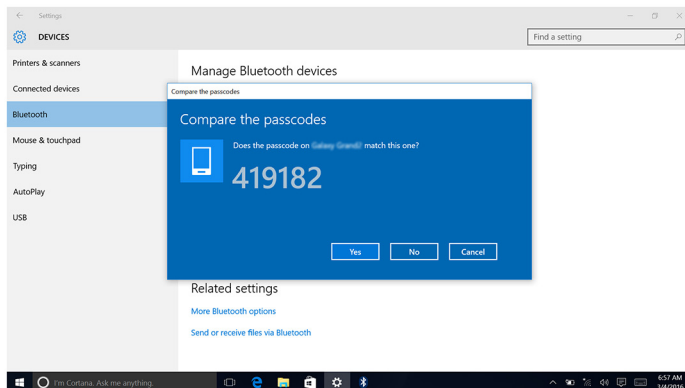

Removing the Bluetooth device

- 1 Swipe-in from the right edge of the display, or click or tap the **Action Center** icon on the task bar to access the Action Center.
- 2 Right-click or touch and hold **Bluetooth**, and then click or tap **Go to settings**.
- 3 Click or tap the device you want to remove, and click or tap **Remove device**.

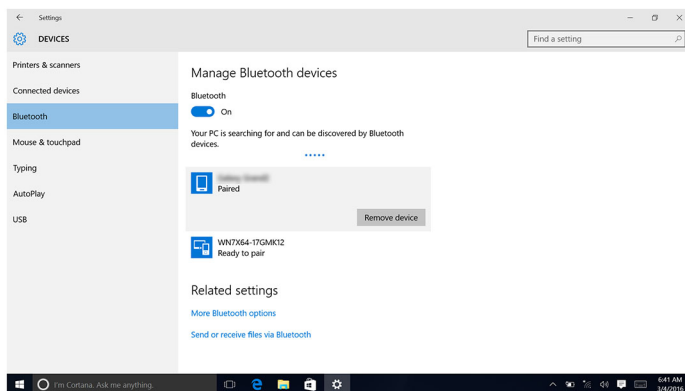

Transferring files between devices using Bluetooth

- 1 Swipe-in from the right edge of the display, or click or tap the **Action Center** icon on the task bar to access the Action Center.

- 2 Right-click or touch and hold **Bluetooth**, and then click or tap **Go to settings**.
- 3 Select your Bluetooth device.
- 4 Click or tap **Send or receive files via Bluetooth**.
- 5 In the **Bluetooth File Transfer** window, click or tap **Send files**, and then select the file you want to transfer.

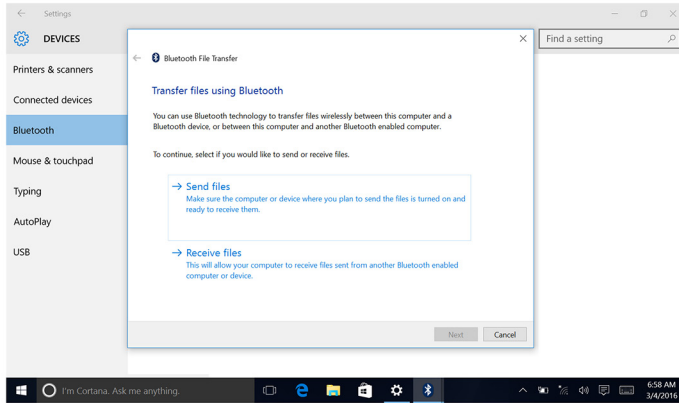

Hard Drive

The following table shows the hard-drive options available in Inspiron 13-5368.

Capacity	Dimensions
SSD	M.2 Drive

Identifying the hard drive

- 1 On the taskbar, click or tap the search box, and then type **Device Manager**.
- 2 Click or tap **Device Manager**.
The **Device Manager** window is displayed.
- 3 Expand **Disk drives**.

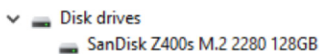

Identifying the hard drive in BIOS setup program

- 1 Turn on or restart your computer.
- 2 Press F2 when the Dell logo is displayed on the screen to enter the BIOS setup program.
A list of hard drives are displayed under the **System Information** in the **General** group.

Media-card reader

The Inspiron 13-5368 has one SD-card slot located on the right side of your computer.

Browsing a media card

- 1 Insert the media card with the metal contacts facing down.
The card will auto-play and a notification appears on the screen.
- 2 Follow the instructions on the screen.

Downloading the media-card reader driver

- 1 Turn on your computer.
- 2 Go to www.dell.com/support.
- 3 Click or tap **Product Support**, enter the Service Tag of your computer, and then click or tap **Submit**.





NOTE: If you do not have the Service Tag, use the auto-detect feature or manually browse for your computer model.

- 4 Click or tap **Drivers & Downloads** → **Find it myself**.
- 5 Scroll down the page and expand **Chipset**.
- 6 Click or tap **Download** to download the media-card reader driver for your computer.
- 7 After the download is complete, navigate to the folder where you saved the media-card reader driver file.
- 8 Double-click or double-tap the card-reader driver file icon and follow the instructions on the screen to install the driver.









Keyboard















The Inspiron 13-5368 is shipped with a backlit keyboard.

Changing the keyboard language

- 1 Click or tap **Start** .
- 2 Click or tap **Settings** .
- 3 Click or tap **Time & language** → **Region & language**.
- 4 Click or tap **Add a language**.
- 5 Choose the language you want to add and select a country for the language.
- 6 Under **Languages** click or tap the language that you want to set as the default language.
- 7 Click or tap **Set as default**.

Keyboard shortcuts

Keys	Description
	Mute audio
	Decrease volume
	Increase volume
	Play previous track/chapter
	Play/Pause
	Play next track/chapter
	Switch to external display
	Search
	Toggle keyboard backlight

Keys	Description
	Decrease brightness
	Increase brightness
	Turn off/on wireless
	Pause/Break
	Sleep
	Toggle scroll lock
	Toggle between power and battery-status light/hard-drive activity light
	System request
	Open application menu
	Toggle Fn-key lock
	End
	Home
	Page down
	Page up

Touch pad

The Inspiron 13-5368 is shipped with a Precision touch pad.

A precision touch pad is a new class of input device that provides high precision pointer input and gesture functionality. Precision touch pads interact with the operating system directly without a driver.

The operating system handles the overall functionality of the touch pad and there are no separate drivers available for download.

Identifying the touch pad

- 1 On the taskbar, click or tap the search box, and then type *Device Manager*.
- 2 Click or tap **Device Manager**.
The **Device Manager** window is displayed.
- 3 Expand **Mice and Other Pointing Devices**.

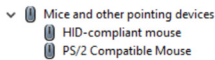



Touch pad gestures

Gesture	Procedure	Result
Tap to click	Tap on the touch pad.	Selects an item
Tap, tap-slide to highlight or drag	Tap, tap-slide on the touch pad	Highlights text, and drags and drops an item
Slide to scroll	Place two fingers on the touch pad, and then slide.	Scrolls the page. Pages can scroll left and right, up and down, or both.
Pinch or stretch to zoom	Place two fingers on the touch pad and move them toward each other or away from each other	Zooms in (stretch) or zooms out (pinch) on the touch pad.
Swipe for Action Center	Swipe in from the right edge	Opens the Action Center. Swipe again to hide the Action Center.
Swipe for adding new desktop	Swipe in from the left edge	Click or tap New New desktop to add a new desktop

Power adapter

The Inspiron 13-5368 is shipped with a 45 W power adapter.

 **WARNING:** When you disconnect the power adapter cable from the computer, pull on its connector, not the cable itself. When disconnecting cable, keep it evenly aligned to avoid bending any connector pins. When connecting the cable, ensure that the port and the connector are correctly oriented and aligned.

 **WARNING:** The power adapter works with electrical outlets worldwide. However, power connectors and power strips vary among countries. Using an incompatible cable or improperly connecting the cable to the power strip or electrical outlet may cause fire or equipment damage.

 **NOTE:** Depending on the region, two or three pin adapters are available. Please verify part numbers from SPMD before replacing the power adapter.

Battery

The Inspiron 13-5368 is shipped with 4-cell “smart” lithium-ion (56 WHr) battery.

 **NOTE:** Batteries are covered for a period of one year from the invoice date unless stated otherwise in the invoice.

Chipset

The chipset is virtually divided into two sections — Northbridge and Southbridge. All computer components communicate with the CPU through the chipset.

The Inspiron 13-5368 is shipped with the chipset that is integrated in the 6th generation Intel Core i3/i5/i7 processors.

Downloading the chipset driver

- 1 Turn on your computer.
- 2 Go to www.dell.com/support.
- 3 Click or tap **Product Support**, enter the Service Tag of your computer, and then click or tap **Submit**.

 **NOTE:** If you do not have the Service Tag, use the auto-detect feature or manually browse for your computer model.

- 4 Click or tap **Drivers & downloads** → **Find it myself**.
- 5 Scroll down the page and expand **Chipset**.

- 6 Click or tap **Download** to download the appropriate chipset driver for your computer.
- 7 After the download is complete, navigate to the folder where you saved the chipset driver file.
- 8 Double-click or double-tap the chipset driver file icon and follow the instructions on the screen to install the driver.

Identifying the chipset

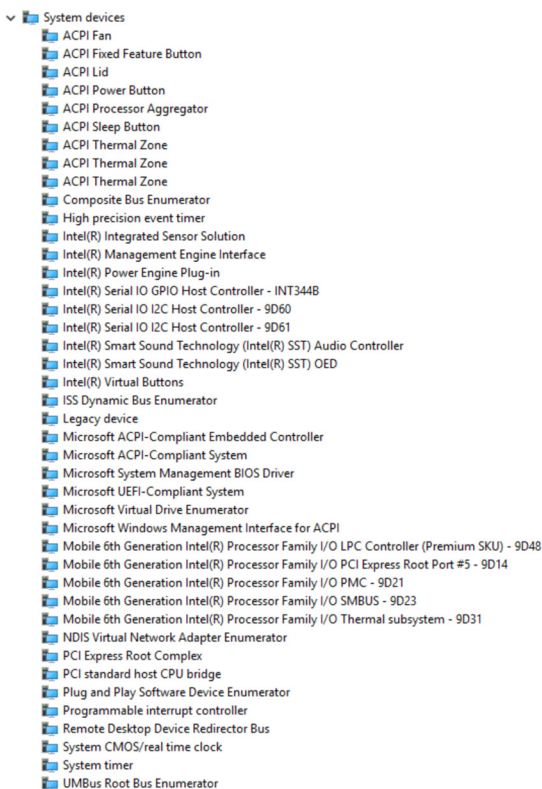

- 1 On the taskbar, click or tap the search box, and then type *Device Manager*.
- 2 Click or tap **Device Manager**.
The **Device Manager** window is displayed.
- 3 Expand **System devices**.



Memory

The Inspiron 13-5368 has two SODIMM (RAM)slots, which are accessible by removing the base cover. Your computer supports 4 GB, 8 GB, 12 GB, and 16 GB dual-channel DDR4 memory of up to 2133 MHz.

Checking the system memory in Windows

- 1 Click or tap **Start** .
- 2 Select **Settings** .
- 3 Click or tap **System** → **About**.

Verifying the system memory in BIOS setup program

- 1 Turn on or restart your computer.
- 2 Press F2 when the Dell logo is displayed on the screen to enter the BIOS setup program.
- 3 On the left pane, select **Settings** → **General** → **System Information**.
The memory information is displayed on the right pane.

Testing memory using ePSA

- 1 Turn on or restart your computer.
- 2 Press F12 after the Dell logo is displayed on the screen to access the boot menu.
- 3 Use the arrow keys to highlight the **Diagnostics** menu option and press **Enter**.
- 4 Follow the instructions on the screen to complete the ePSA Pre-boot System Assessment (PSA).

 **NOTE:** If the operating system logo appears, wait until you see the desktop. Turn off your computer and try again.

Processors

The Inspiron 13-5368 is available with the following processor options:

- 6th generation Intel Core i3/i5/i7
- Intel Celeron Dual Core

- Intel Pentium Dual Core

Identifying the processors in Windows

- 1 On the taskbar, click or tap the search box, and then type **Device Manager**.
- 2 Click or tap **Device Manager**.
The **Device Manager** window is displayed.
- 3 Expand **Processors**.



Checking the processor usage in the task manager

- 1 Right-click or double-tap on the taskbar.
- 2 Click or tap **Task Manager**.
The **Task Manager** window is displayed.
- 3 Click or tap **Performance** tab to display processor performance details.

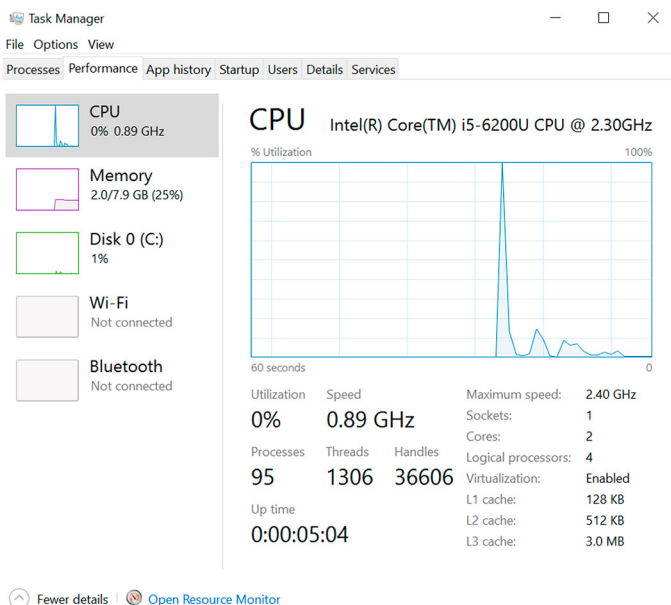

Operating System

The Inspiron 13-5368 is shipped with the Windows 10 factory installation.

Service Tag location

The service tag is a unique alphanumeric identifier that allows Dell service technicians to identify the hardware components in your computer and access warranty information.

Device drivers

Intel Dynamic Platform and Thermal Framework

In the Device Manager, check if the Intel Dynamic Platform and Thermal Framework is installed.

Install the driver updates from www.dell.com/support.

- ▼ Intel(R) Dynamic Platform and Thermal Framework
 - Intel(R) Dynamic Platform and Thermal Framework Generic Participant
 - Intel(R) Dynamic Platform and Thermal Framework Generic Participant
 - Intel(R) Dynamic Platform and Thermal Framework Manager
 - Intel(R) Dynamic Platform and Thermal Framework Memory Participant
 - Intel(R) Dynamic Platform and Thermal Framework Processor Participant

Intel Chipset Software Installation Utility

In the Device Manager, check if the chipset driver is installed.

Install the Intel chipset updates from www.dell.com/support.

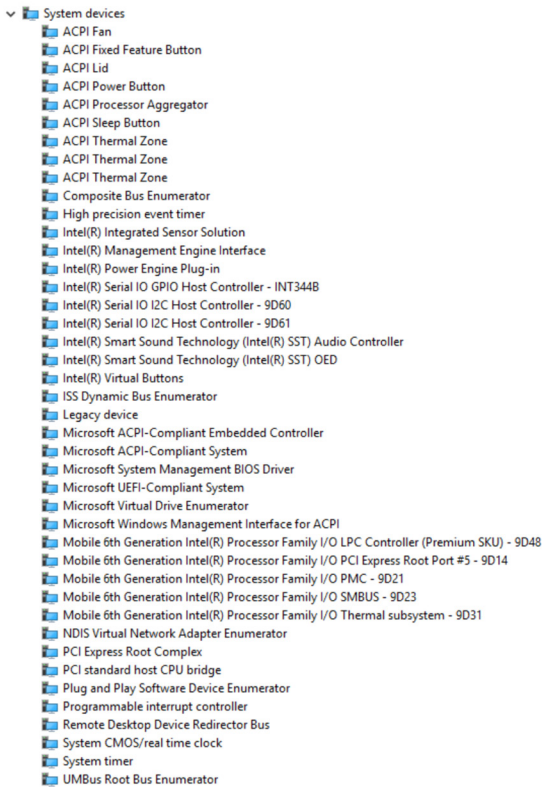





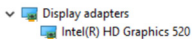



















Intel HD Graphics 520 driver



In the Device Manager, check if the video driver is installed.
Install the video driver updates from www.dell.com/support.



Intel Serial IO Driver

In the Device Manager, check if the Intel Serial IO Driver is installed.
Install the driver updates from www.dell.com/support.

- ▼  Human Interface Devices
 -  Converted Portable Device Control device
 -  GPIO Dock Mode Indicator Driver
 -  GPIO Laptop or Slate Indicator Driver
 -  HID PCI Minidriver for ISS
 -  HID PCI Minidriver for ISS
 -  HID PCI Minidriver for ISS
 -  HID PCI Minidriver for ISS
 -  HID PCI Minidriver for ISS
 -  HID-compliant consumer control device
 -  HID-compliant consumer control device
 -  HID-compliant consumer control device
 -  HID-compliant consumer control device
 -  HID-compliant consumer control device
 -  HID-compliant consumer control device
 -  HID-compliant consumer control device
 -  HID-compliant consumer control device
 -  HID-compliant consumer control device
 -  HID-compliant system controller
 -  HID-compliant system controller
 -  HID-compliant system controller
 -  HID-compliant system controller
 -  HID-compliant touch pad
 -  HID-compliant touch screen
 -  HID-compliant vendor-defined device
 -  HID-compliant vendor-defined device
 -  HID-compliant vendor-defined device
 -  HID-compliant vendor-defined device
 -  HID-compliant vendor-defined device
 -  HID-compliant vendor-defined device
 -  HID-compliant wireless radio controls
 -  I2C HID Device
 -  Microsoft Input Configuration Device
 -  Microsoft Input Configuration Device
 -  Portable Device Control device
 -  USB Input Device
 -  USB Input Device
 -  USB Input Device

- ▼  Mice and other pointing devices
 -  HID-compliant mouse
 -  PS/2 Compatible Mouse

- System devices
 - ACPI Fan
 - ACPI Fixed Feature Button
 - ACPI Lid
 - ACPI Power Button
 - ACPI Processor Aggregator
 - ACPI Sleep Button
 - ACPI Thermal Zone
 - ACPI Thermal Zone
 - ACPI Thermal Zone
 - Composite Bus Enumerator
 - High precision event timer
 - Intel(R) Integrated Sensor Solution
 - Intel(R) Management Engine Interface
 - Intel(R) Power Engine Plug-in
 - Intel(R) Serial IO GPIO Host Controller - INT344B
 - Intel(R) Serial IO I2C Host Controller - 9D60
 - Intel(R) Serial IO I2C Host Controller - 9D61
 - Intel(R) Smart Sound Technology (Intel(R) SST) Audio Controller
 - Intel(R) Smart Sound Technology (Intel(R) SST) OED
 - Intel(R) Virtual Buttons
 - ISS Dynamic Bus Enumerator
 - Legacy device
 - Microsoft ACPI-Compliant Embedded Controller
 - Microsoft ACPI-Compliant System
 - Microsoft System Management BIOS Driver
 - Microsoft UEFI-Compliant System
 - Microsoft Virtual Drive Enumerator
 - Microsoft Windows Management Interface for ACPI
 - Mobile 6th Generation Intel(R) Processor Family I/O LPC Controller (Premium SKU) - 9D48
 - Mobile 6th Generation Intel(R) Processor Family I/O PCI Express Root Port #5 - 9D14
 - Mobile 6th Generation Intel(R) Processor Family I/O PMC - 9D21
 - Mobile 6th Generation Intel(R) Processor Family I/O SMBUS - 9D23
 - Mobile 6th Generation Intel(R) Processor Family I/O Thermal subsystem - 9D31
 - NDIS Virtual Network Adapter Enumerator
 - PCI Express Root Complex
 - PCI standard host CPU bridge
 - Plug and Play Software Device Enumerator
 - Programmable interrupt controller
 - Remote Desktop Device Redirector Bus
 - System CMOS/real time clock
 - System timer
 - UMBus Root Bus Enumerator

Intel Trusted Execution Engine Interface

In the device manager, check if the Intel Trusted Execution Engine Interface driver is installed.

Install the driver updates from www.dell.com/support.

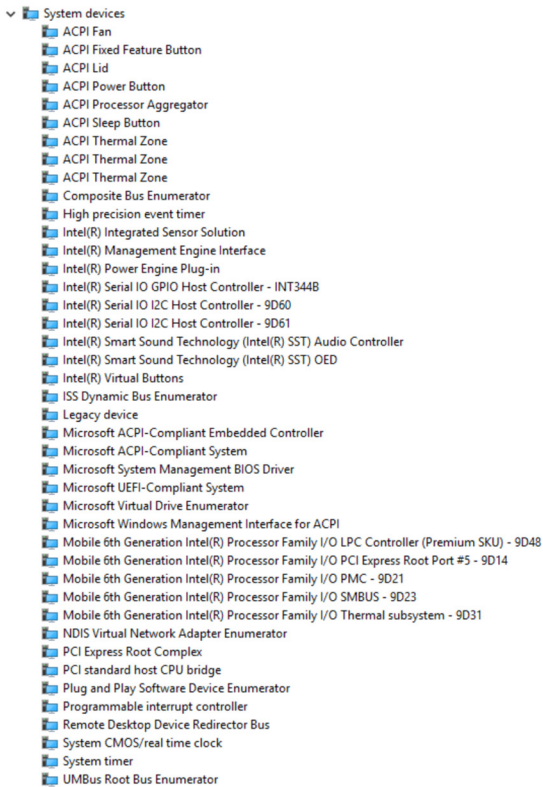

Intel Virtual Button driver

Check if the Intel Virtual Button driver is installed by looking at Device Manager under System devices (shown below).

Install the driver update from www.dell.com/support.

- System devices
 - ACPI Fan
 - ACPI Fixed Feature Button
 - ACPI Lid
 - ACPI Power Button
 - ACPI Processor Aggregator
 - ACPI Sleep Button
 - ACPI Thermal Zone
 - ACPI Thermal Zone
 - ACPI Thermal Zone
 - Composite Bus Enumerator
 - High precision event timer
 - Intel(R) Integrated Sensor Solution
 - Intel(R) Management Engine Interface
 - Intel(R) Power Engine Plug-in
 - Intel(R) Serial IO GPIO Host Controller - INT344B
 - Intel(R) Serial IO I2C Host Controller - 9D60
 - Intel(R) Serial IO I2C Host Controller - 9D61
 - Intel(R) Smart Sound Technology (Intel(R) SST) Audio Controller
 - Intel(R) Smart Sound Technology (Intel(R) SST) OED
 - Intel(R) Virtual Buttons
 - ISS Dynamic Bus Enumerator
 - Legacy device
 - Microsoft ACPI-Compliant Embedded Controller
 - Microsoft ACPI-Compliant System
 - Microsoft System Management BIOS Driver
 - Microsoft UEFI-Compliant System
 - Microsoft Virtual Drive Enumerator
 - Microsoft Windows Management Interface for ACPI
 - Mobile 6th Generation Intel(R) Processor Family I/O LPC Controller (Premium SKU) - 9D48
 - Mobile 6th Generation Intel(R) Processor Family I/O PCI Express Root Port #5 - 9D14
 - Mobile 6th Generation Intel(R) Processor Family I/O PMC - 9D21
 - Mobile 6th Generation Intel(R) Processor Family I/O SMBUS - 9D23
 - Mobile 6th Generation Intel(R) Processor Family I/O Thermal subsystem - 9D31
 - NDIS Virtual Network Adapter Enumerator
 - PCI Express Root Complex
 - PCI standard host CPU bridge
 - Plug and Play Software Device Enumerator
 - Programmable interrupt controller
 - Remote Desktop Device Redirector Bus
 - System CMOS/real time clock
 - System timer
 - UMBus Root Bus Enumerator

Intel Wireless 3165 WiFi and Bluetooth drivers

In the Device Manager, check if the network card driver is installed.

Install the driver updates from www.dell.com/support.

- Network adapters
 - Bluetooth Device (Personal Area Network)
 - Bluetooth Device (RFCOMM Protocol TDI)
 - Intel(R) Dual Band Wireless-AC 3165

In the Device Manager, check if the Bluetooth driver is installed.

Install the driver updates from www.dell.com/support.

- Bluetooth
 - Intel(R) Wireless Bluetooth(R)
 - Microsoft Bluetooth Enumerator
 - Microsoft Bluetooth LE Enumerator

BIOS overview

The BIOS manages data flow between the computer's operating system and attached devices such as hard disk, video adapter, keyboard, mouse, and printer.

Entering the BIOS setup program

- 1 Turn on or restart your computer.
- 2 Press F2 when the Dell logo is displayed on the screen to enter the BIOS setup program.

You can change the user-defined settings in BIOS setup program.

Boot menu

The Inspiron 13-5368 includes a one-time boot menu. By using this feature, you can change the sequence of devices that your computer attempts to boot from, for example, floppy, CD-ROM, or hard drive.

Boot menu enhancements

The boot menu enhancements are as follows:

- **Easier Access** – Press F12 to access the boot selection menu.
- **User Prompting** – The user is prompted to use the keystroke on the BIOS screen.
- **Diagnostics Options** – The boot menu includes the ePSA diagnostic options.

Timing key sequences

The keyboard is not the first device initialized by Setup. As a result, if you press a keystroke too early, the keyboard is locked out. In such case, a keyboard error message is displayed on the screen, and you cannot restart your computer with the Ctrl+Alt+Del key combination.

To prevent the keyboard from locking, wait until the keyboard is initialized completely. The keyboard is initialized if one of the following occurs:

- The keyboard lights flash.
- The F2=Setup prompt appears at the top right corner of the screen during boot.

System diagnostic lights

Power and battery-status light/hard-drive activity light: Indicates the battery-charge status or the hard-drive activity.

 **NOTE:** Press Fn+H to toggle this light between power and battery-status light and hard-drive activity light.

Hard-drive activity light

Turns on when the computer reads from or writes to the hard drive.

Power and battery-status light

Indicates the power and battery-charge status.

Solid white – Power adapter is connected and the battery has more than 5 percent charge.

Amber – Computer is running on battery and the battery has less than 5 percent charge.

Off

- Power adapter is connected and the battery is fully charged.
- Computer is running on battery and the battery has more than 5 percent charge.
- Computer is in sleep state, hibernation, or turned off.

The power and battery-status light blinks amber along with beep codes indicating failures.

For example, the power and battery-status light blinks amber two times followed by a pause, and then blinks white three times followed by a pause. This 2,3 pattern continues until the computer is turned off indicating no memory or RAM is detected.

The following table shows different light patterns, what they indicate, and the suggested solutions.

Light pattern	Problem description	Suggested solution
2,1	CPU failure	Replace the system board.
2,2	System board: BIOS and ROM failure	Flash latest BIOS version. If problem persists, replace the system board.
2,3	No memory or RAM detected	Confirm that the memory module is installed properly. If

Light pattern	Problem description	Suggested solution
		problem persists, replace the memory module.
2,4	Memory or RAM failure	Replace the memory module.
2,5	Invalid memory installed	Replace the memory module.
2,6	System board or chipset error	Replace the system board.
2,7	LCD failure	Replace the LCD.
3,1	CMOS battery failure	Replace the CMOS battery.
3,2	PCI or video card or chip failure	Replace the CMOS battery.
3,3	Recovery image not found	Reimage the system.
3,4	Recovery image found but invalid	Reimage the system.

The computer may emit a series of beeps during start-up if the errors or problems cannot be displayed. The repetitive beep codes help the user troubleshoot problems with the computer.

Camera status light: Indicates whether the camera is in use.

- Solid white – Camera is in use.
- Off – Camera is not in use.

Caps Lock status light: Indicates whether Caps Lock is enabled or disabled.

- Solid white – Caps Lock enabled.
- Off – Caps Lock disabled.

Getting help and contacting Dell

Self-help resources

You can get information and help on Dell products and services using these self-help resources:

Information about Dell products and services www.dell.com

Windows 8.1 and Windows 10

Dell Help & Support app



Windows 10

Get started app



Windows 8.1

Help + Tips app



Accessing help in Windows 8, Windows 8.1, and Windows 10

In Windows search, type **Help and Support**, and press Enter.

Accessing help in Windows 7

Click **Start** → **Help and Support**.

Online help for operating system

www.dell.com/support/windows

www.dell.com/support/linux

Troubleshooting information, user manuals, setup instructions, product specifications, technical help blogs, drivers, software updates, and so on.

www.dell.com/support

Learn about your operating system, setting up and using your computer, data backup, diagnostics, and so on.

See *Me and My Dell* at

www.dell.com/support/manuals.

Contacting Dell

To contact Dell for sales, technical support, or customer service issues, see www.dell.com/contactdell.



NOTE: Availability varies by country and product, and some services may not be available in your country.



NOTE: If you do not have an active internet connection, you can find contact information on your purchase invoice, packing slip, bill, or Dell product catalog.