



Dell DSS 7000/DSS 7500 Owner's Manual

Regulatory Model: B14S
Regulatory Type: B14S001



Notes, Cautions and Warnings

 NOTE: A NOTE indicates important information that helps you make better use of your computer.

 CAUTION: A CAUTION indicates either potential damage to hardware or loss of data and tells you how to avoid the problem.

 WARNING: A WARNING indicates a potential for property damage, personal injury, or death.

Copyright © 2016 Dell Inc. All rights reserved. This product is protected by U.S. and international copyright and intellectual property laws. Dell™ and the Dell logo are trademarks of Dell Inc. in the United States and/or other jurisdictions. All other marks and names mentioned herein may be trademarks of their respective companies.

2016 - 9

Rev. A02

Contents

1	About your system	8
	Front-panel features and indicators	8
	Back-panel features and indicators	10
	HDD indicator codes	12
	NIC indicator codes	13
	Indicator codes for the redundant PSU	14
	Documentation matrix	15
2	Performing initial system configuration	16
	Setting up your system	16
	Installing the rack and the server	16
	Installing the rails	16
	Installing the cable management arm (CMA)	18
	Setting up and configuring the iDRAC IP address	20
	Configuring the iDRAC settings for the dedicated management port card	21
	Logging in to iDRAC	21
	Installing the OS	22
	Managing your system remotely	22
	Downloading and installing drivers and firmware	22
	Installing the driver for the LSI 9311 card on a Ubuntu1404 system	23
3	Pre-operating system management applications	24
	Navigation keys	24
	About System Setup	24
	Entering System Setup	25
	System Setup Main Menu	25
	System BIOS page	25
	System Information page	26
	Memory Settings page	26
	Processor Settings page	27
	SATA Settings page	29
	Boot Settings page	30
	Integrated Devices page details	31
	Serial Communication page	32
	System Profile Settings page	33
	System Security Settings page	34
	Secure Boot Custom Policy Settings page	35
	Miscellaneous Settings page	36
	About Boot Manager	36

Entering Boot Manager.....	36
Boot Manager main menu.....	37
About Dell Lifecycle Controller.....	37
Changing the boot order.....	37
Choosing the system boot mode.....	37
Assigning a system and setup password.....	38
Using your system password to secure your system.....	39
Deleting or changing an existing system and/or setup password.....	39
Operating with a setup password enabled.....	40
Embedded system management.....	40
iDRAC Settings utility.....	40
Entering the iDRAC Settings utility.....	40
Changing the Thermal Settings.....	40
4 Installing and removing system components.....	42
Safety instructions.....	42
Before working inside your system.....	42
After working inside your system.....	42
Recommended tools.....	43
System cover.....	43
Removing the system cover.....	43
Installing the system cover.....	44
Server sleds.....	44
Removing the server sled.....	44
Installing the server sled.....	45
Expansion cards and expansion-card riser module.....	46
Expansion card installation guidelines.....	46
Removing the expansion-card riser module.....	47
Installing the expansion-card riser module.....	48
Removing an expansion card.....	48
Installing an expansion card.....	49
Installing an optional card.....	50
Installing the supercapacitor.....	52
Removing a riser card.....	54
Installing a riser card.....	55
Cooling shroud.....	56
Removing the cooling shroud.....	56
Installing the cooling shroud.....	57
System memory.....	57
General memory module installation guidelines.....	58
Mode-specific guidelines.....	59

Sample memory configurations	60
Removing a memory module	61
Installing a memory module	62
Heat sinks and processors	64
Removing a processor	64
Installing a processor	67
Hard disk drives	70
Removing a 3.5-inch HDD blank.....	70
Installing a 3.5-inch HDD blank.....	71
Removing a 3.5-inch hot-swap HDD.....	71
Installing a 3.5-inch hot-swap HDD.....	72
Removing a 3.5-inch HDD from an HDD carrier.....	73
Installing a 3.5-inch HDD into an HDD carrier.....	74
Removing a 2.5-inch hot-swap HDD.....	74
Installing a 2.5-inch hot-swap HDD.....	75
Installing a 2.5-inch SSD into a 3.5-inch HDD adapter.....	76
Removing a 2.5-inch SSD from a 3.5-inch HDD adapter.....	76
Installing an HDD adapter into an HDD carrier.....	77
Removing an HDD adapter from an HDD carrier.....	78
Removing a 2.5-inch SSD from an HDD carrier.....	78
Installing an HDD into an HDD carrier.....	78
System fans	79
Removing a system fan	79
Installing a system fan.....	80
Removing the fan cage.....	80
Installing the fan cage.....	81
PSUs.....	82
Removing a redundant PSU.....	82
Installing a redundant PSU.....	83
System battery.....	84
Replacing the system battery.....	84
Interposer board	85
Removing the interposer board.....	85
Installing the interposer board.....	86
Expander board.....	87
Removing the expander board.....	87
Installing the expander board.....	89
Paddle board.....	89
Removing the paddle board.....	89
Installing the paddle board.....	90
HDD cage and backplane.....	90

Removing the HDD cage and backplane	90
Installing the HDD cage and backplane.....	93
System board.....	95
Removing the system board.....	95
Installing the system board.....	97
Trusted Platform Module.....	99
5 Troubleshooting your system.....	101
Safety first—for you and your system.....	101
Troubleshooting system startup failure.....	101
Troubleshooting external connections.....	101
Troubleshooting the video subsystem	101
Troubleshooting a USB device.....	101
Troubleshooting a serial I/O device.....	102
Troubleshooting a NIC.....	102
Troubleshooting a wet system.....	103
Troubleshooting a damaged system	104
Troubleshooting the system battery.....	105
Troubleshooting PSUs	105
Power source issues.....	105
PSU issues.....	106
Troubleshooting cooling issues.....	106
Troubleshooting system fans	107
Troubleshooting system memory	107
Troubleshooting HDDs.....	108
Troubleshooting expansion cards.....	109
Troubleshooting processors.....	110
Troubleshooting server sleds	110
System messages.....	110
Warning messages.....	110
Diagnostic messages	111
6 Using system diagnostics	112
Dell Embedded System Diagnostics.....	112
When to use the Embedded System Diagnostics.....	112
Running the Embedded System Diagnostics from Boot Manager	112
Running the Embedded System Diagnostics from the Dell Lifecycle Controller....	112
System diagnostic controls	113
7 Jumpers and connectors.....	114
System board jumper settings	114
System board connectors.....	115

Disabling a forgotten password.....	117
8 Technical specifications.....	118
9 Getting help	124
Contacting Dell	124
Locating your system Service Tag.....	124

About your system

The Dell 4U rack server contains the DSS 7000 chassis and up to two DSS 7500 server sleds. Each server sled supports up to two processors based on the Intel Xeon EP E5-2600 v3 family and EP E5-2600 v4 family, up to 12 DIMMs, and up to two boot solid state drives (SSDs). The chassis supports up to 90 hard disk drives (HDDs)/SSDs.

The server systems are available in the following configurations:

System	Configuration
Single-node systems with one server sled	Up to 90 3.5-inch hot-swappable Serial Attached SCSI (SAS) HDDs, SATA HDDs, or SATA SSDs Up to 16 hot-swappable SAS SSDs Up to two 2.5-inch hot-swappable boot SATA SSDs
Dual-node systems with two server sleds	Up to 90 3.5-inch hot-swappable Serial Attached SCSI (SAS) HDDs, SATA HDDs, or SATA SSDs, or Up to 12 hot-swappable SAS SSDs Up to four 2.5-inch hot-swappable boot SATA SSDs

Front-panel features and indicators

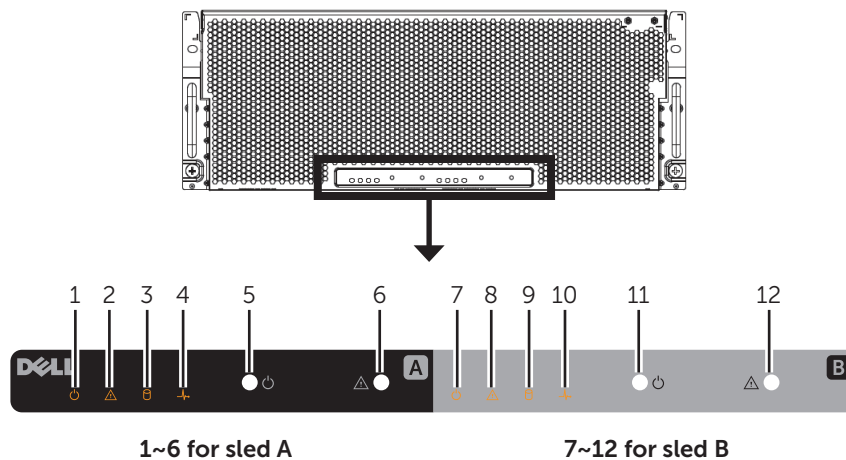

















Figure 1. Front-panel features and indicators

Item	Indicator, Button, or Connector	Icon	Description
1	Power indicator		The power indicator glows when the system is turned on.
2	ID indicator		When a system identification button is pressed, the ID indicator blinks blue to help locate a particular system within a rack.
3	Sled A HDD fault status indicator		The indicator blinks amber if an HDD experiences an issue.
4	System board status indicator		If the system is on, and in good health, the indicator glows solid blue. The indicator blinks amber if the system is in standby, and if any issue exists (for example, a failed fan or HDD).
5	Power button		The power button controls the PSU output to the system.  NOTE: On ACPI-compliant operating systems (OSs), turning off the system using the power button causes the system to perform a graceful shutdown before power to the system is turned off.
6	System identification button		The identification button can be used to locate a particular system within a rack. Press to toggle the system ID on and off. If the system stops responding during POST, press and hold the system ID button for more than five seconds to enter BIOS progress mode. To reset iDRAC (if not disabled in F2 iDRAC setup) press and hold the button for more than 15 seconds.
7	Power indicator		The power indicator glows when the system is turned on.
8	ID indicator		When a system identification button is pressed, the ID indicator blinks blue to help locate a particular system within a rack.
9	Sled B HDD fault status indicator		The indicator blinks amber if an HDD experiences an issue.
10	System board status indicator		If the system is on, and in good health, the indicator glows solid blue. The indicator blinks amber if the system is in standby, and if any issue exists (for example, a failed fan or HDD).

Item	Indicator, Button, or Connector	Icon	Description
11	Power button		The power button controls the PSU output to the system.  NOTE: On ACPI-compliant operating systems, turning off the system using the power button causes the system to perform a graceful shutdown before power to the system is turned off.
12	System identification button		The identification button can be used to locate a particular system within a rack. Press to toggle the system ID on and off. If the system stops responding during POST, press and hold the system ID button for more than five seconds to enter BIOS progress mode. To reset iDRAC (if not disabled in F2 iDRAC setup) press and hold the button for more than 15 seconds.

 NOTE: Features of sled B are for dual-node systems only.

Back-panel features and indicators

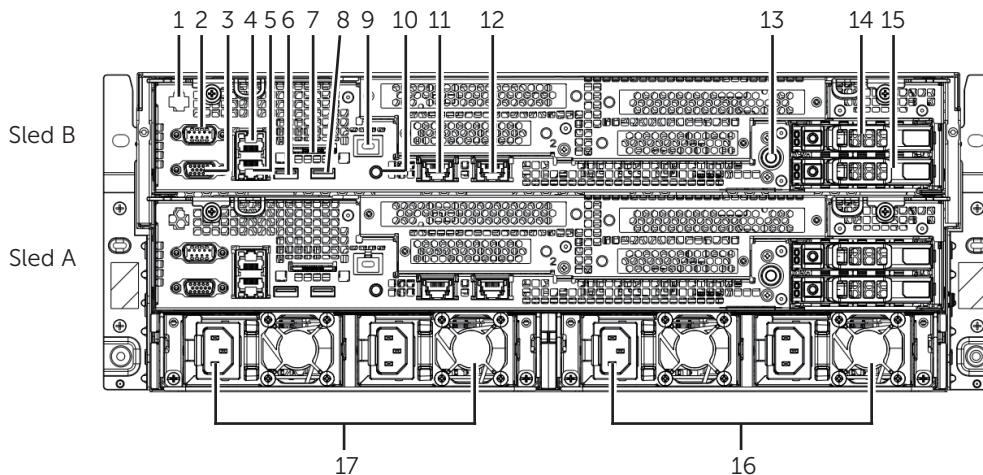













Figure 2. Back-panel features and indicators

Item	Indicator, Button, or Connector	Icon	Description
1	Blade EN connector (optional)		This function is reserved.

Item	Indicator, Button, or Connector	Icon	Description
2	Serial connector		Enables you to connect a serial device to the system.
3	Video connector		Enables you to connect a VGA display to the system.
4	Ethernet connector 1		Integrated 10/100/1000 Mbps NIC connector.
5	Ethernet connector 2		Integrated 10/100/1000 Mbps NIC connector.
6	USB connector		Enables you to connect USB devices to the system. The port is USB 2.0-compliant.
7	SD vFlash card slot		Provides persistent on-demand local storage and a custom deployment environment that allows automation of server configuration, scripts and imaging. See the Integrated Dell Remote Access User's Guide at dell.com/idracmanuals .
8	USB connector		Enables you to connect USB devices to the system. The port is USB 3.0-compliant.
9	Dedicated Ethernet port		Dedicated management port on the iDRAC ports card.
10	System identification button		<p>The identification button can be used to locate a particular system within a rack.</p> <p>Press to toggle the system ID on and off.</p> <p>If the system stops responding during POST, press and hold the system ID button for more than five seconds to enter BIOS progress mode.</p> <p>To reset the iDRAC (if not disabled in F2 iDRAC setup) press and hold the button for more than 15 seconds.</p>
11	Ethernet connector 3		Integrated 10/100/1000 Mbps NIC connector.
12	Ethernet connector 4		Integrated 10/100/1000 Mbps NIC connector.
13	Power button		<p>The power button controls the PSU output to the system.</p> <p> NOTE: On ACPI-compliant operating systems (OSs), turning off the system using the power button causes the system to perform a graceful shutdown before power to the system is turned off.</p>
14	Boot HDD A		2.5-inch boot HDD.
15	Boot HDD B		2.5-inch boot HDD.

Item	Indicator, Button, or Connector	Icon	Description
16	Power supply units		Two redundant power supply units (PSUs) for sled A.
17	Power supply units		Two redundant power supply units (PSUs) for sled B.

 NOTE: Features of sled B are for dual-node systems only.

 NOTE: A dummy sled will be installed over sled B compartment and two dummy PSUs over the PSU slots for sled B for the single-node system.

HDD indicator codes

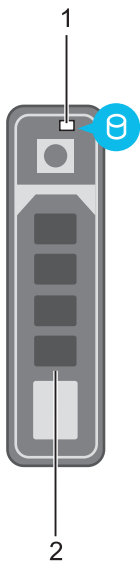



Figure 3. 2.5-inch HDD indicator

1 HDD activity indicator 2 HDD

 NOTE: If the HDD is in Advanced Host Controller Interface (AHCI) mode, the status indicator (on the right side) does not function and remains off.

 NOTE: The function of the status indicator may vary depending on the HDD type.

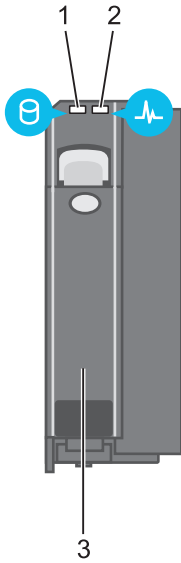

Figure 4. 3.5-inch HDD indicators

- | | | | |
|---|------------------------|---|----------------------|
| 1 | HDD activity indicator | 2 | HDD status indicator |
| 3 | HDD | | |

Drive-status indicator pattern (RAID only)	Condition
Blinks green two times per second	Identifying drive or preparing for removal.
Off	Normal operation
Solid orange	Drive failed
Steady green	Drive online

NIC indicator codes

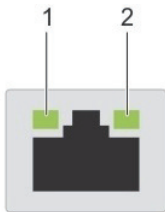

Figure 5. NIC indicators

- | | | | |
|---|----------------|---|--------------------|
| 1 | link indicator | 2 | activity indicator |
|---|----------------|---|--------------------|

Indicator pattern	Description
Link and activity indicators are OFF	The NIC is not connected to the network.
Link indicator is green	The NIC is connected to a valid network at its maximum port speed (1 Gbps).
Link indicator is yellow	The NIC is connected to a valid network at less than its maximum port speed.
Activity indicator is blinking green	Network data is being sent or received.

Indicator codes for the redundant PSU

Each AC PSU has an illuminated translucent handle that indicates whether power is present or whether a power fault has occurred.

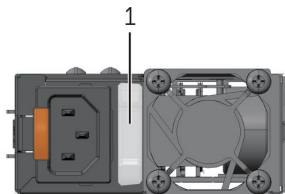





Figure 6. AC PSU status indicator

1 AC PSU status indicator/handle

Indicator pattern	Description
Green	A valid power source is connected to the PSU and the PSU is operational.
Flashing green	When updating the firmware of the PSU is being updated, the PSU handle flashes green. ⚠ CAUTION: Do not disconnect the power cord or unplug the PSU when updating firmware. If firmware update is interrupted, the PSUs will not function. You must roll back the power supply firmware by using Life cycle controller. For more information, see Dell Lifecycle Controller User's Guide at dell.com/idracmanuals.
Flashing green and turns off	When hot-adding a PSU, the PSU handle flashes green five times at 4 Hz rate and turns off. This indicates that there is a PSU mismatch with respect to efficiency, feature set, health status, and supported voltage. Replace the PSU with a PSU that matches the capacity of the other PSU. 📌 NOTE: For AC PSUs, use only PSUs with the Extended Power Performance (EPP) label on the back. Mixing PSUs from earlier generations of Dell servers can result in a PSU mismatch condition or failure to turn on.

Indicator pattern	Description
Flashing amber	<p>Indicates an issue with the PSU.</p> <p> CAUTION: When correcting a PSU mismatch, replace only the PSU with the flashing indicator. Swapping the other PSU to make a matched pair can result in an error condition and unexpected system shutdown. To change from a High Output configuration to a Low Output configuration or vice versa, you must turn off the system.</p> <p> CAUTION: If two PSUs are used, they must be of the same type and have the same maximum output power.</p> <p> CAUTION: Combining AC and DC PSUs is not supported and triggers a mismatch.</p>
Not lit	Power is not connected.

Documentation matrix

The documentation matrix provides information about documents that you can refer to for setting up and managing your system.

To...	Refer to...
Install your system into a rack	Installing the rack and the server
Configure and log in to iDRAC, set up managed and management system, know the iDRAC features and troubleshoot using iDRAC	Integrated Dell Remote Access Controller User's Guide at dell.com/idracmanuals
Know about the RACADM subcommands and supported RACADM interfaces	RACADM Command Line Reference Guide for iDRAC and CMC at dell.com/idracmanuals
Start, enable and disable Lifecycle Controller, know the features, use and troubleshoot Lifecycle Controller	Dell Lifecycle Controller User's Guide at dell.com/idracmanuals
Use Lifecycle Controller Remote Services	Dell Lifecycle Controller Remote Services Quick Start Guide at dell.com/idracmanuals
Check the event and error messages generated by the system firmware and agents that monitor system components	Dell Event and Error Messages Reference Guide at dell.com/idracmanuals

Performing initial system configuration

After you receive your system, you must set up your system, install the OS if it is not pre-installed, and set up and configure the system iDRAC IP address.

Setting up your system

1. Unpack the server.
2. Install the rack.
3. Install the server into the rack.
4. Install the hard disk drives into the chassis.
5. Connect the peripherals to the system.
6. Connect the system to its electrical outlet.
7. Turn the system on by pressing the power button or using iDRAC.
8. Turn on the attached peripherals.

Installing the rack and the server

Installing the rails

1. Remove the inner member and slide the intermediate member back.
 - a. Press and remove the inner member.
 - b. Press down according to the arrow's direction, and slide the intermediate member back.

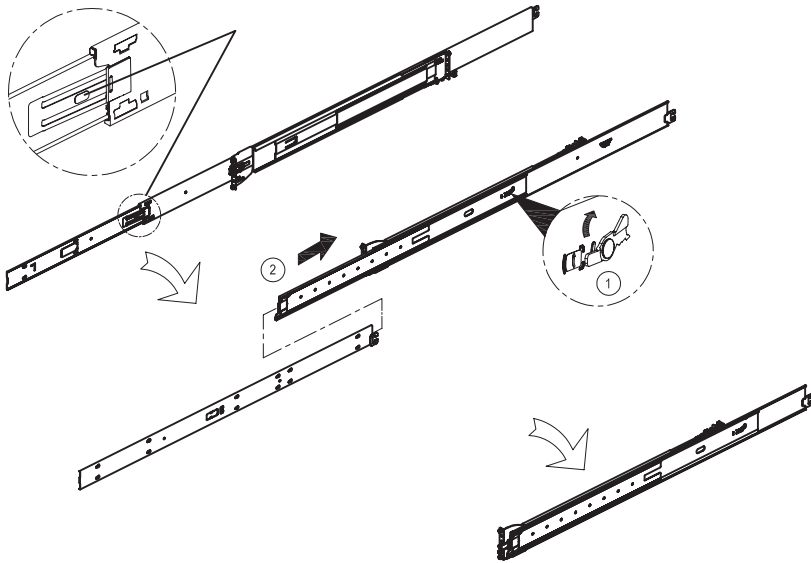



Figure 7. Removing the inner member and sliding the intermediate member back

2. Install the inner member onto the chassis and secure it with the screw.

 NOTE: Pay attention to the installation direction.

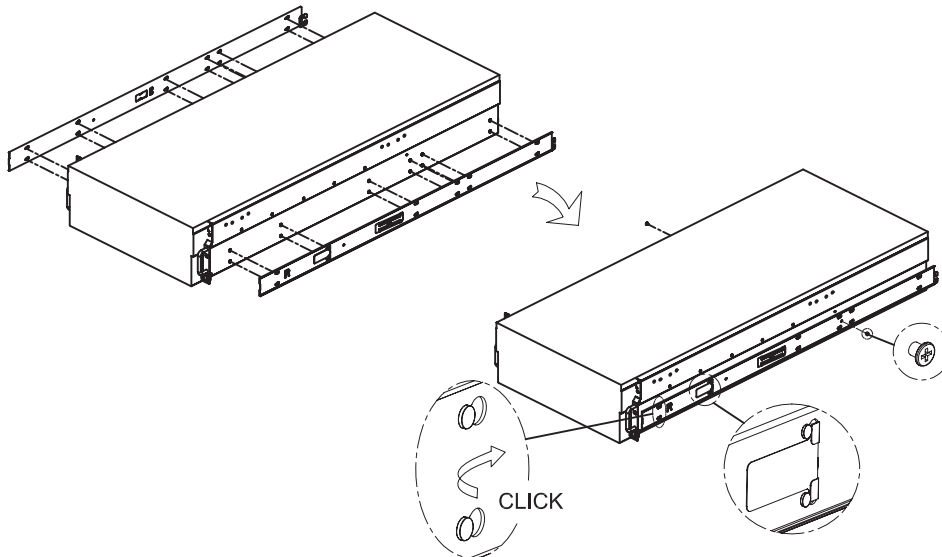

Figure 8. Installing the inner member onto the chassis

3. Secure the outer member and bracket into the rack with the screws for both the left and right sides.

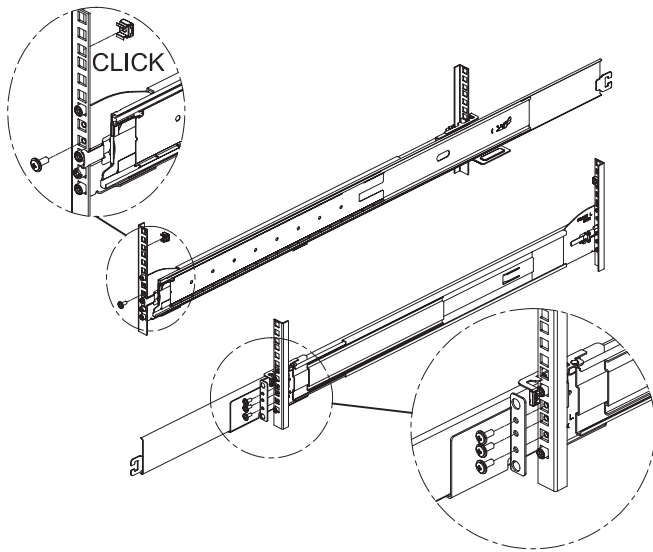

Figure 9. Securing the outer member and bracket into the rack

4. Install the chassis into the rack.
 - a. Make sure that the ball-bearing retainer is at the front of the intermediate member.
 - b. Aim and push the inner member on the chassis into the intermediate member. The tab must be pressed when pushing the chassis in.
 - c. Secure the inner member with the screw.

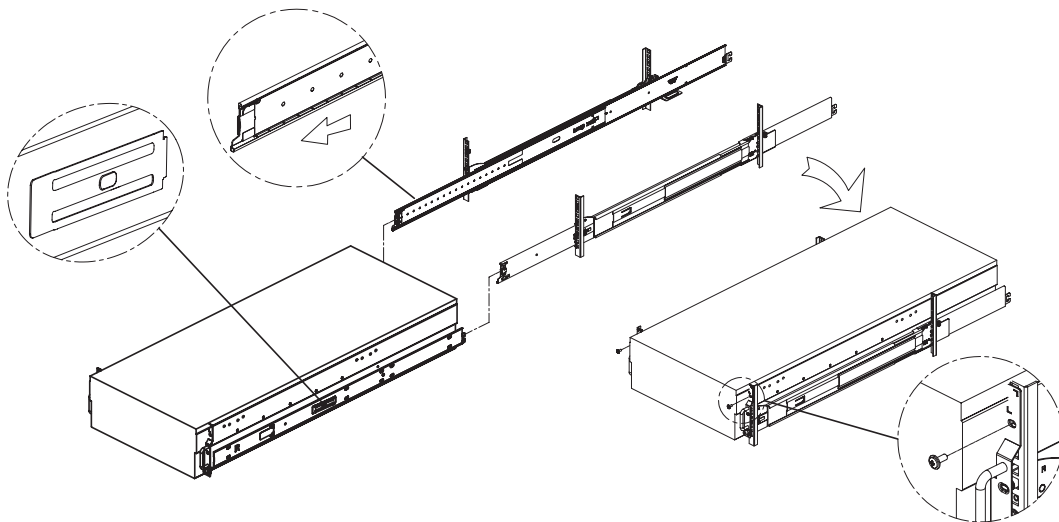

Figure 10. Installing the chassis into the rack

Installing the cable management arm (CMA)

1. Switch the left and right sides of the CMA by pressing the **PUSH** button and spin 180 degrees to change the direction.

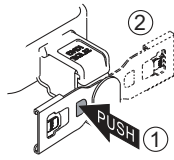

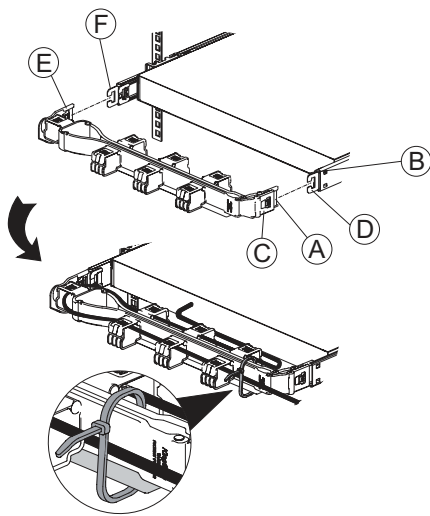

Figure 11. Switching the left and right sides of the CMA

2. The loop strap must be tied to the CMA crossbar.

 NOTE: The loop strap can be removed after the system arrives the final destination.

3. Install the CMA.



a. Install the CMA connector (A) into the CMA connector base on the inner member (B).

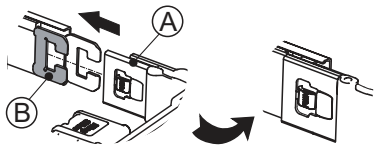

b. Install the CMA connector (C) into the CMA connector base on the outer member (D).

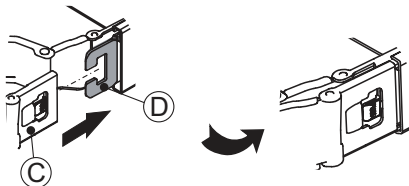

- c. Install the CMA connector (F) beside the center CMA body (E) to the CMA connector base on the outer member (F).

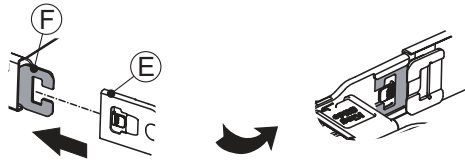

4. Release the CMA.

- a. To release the outer member, press the **PUSH** button on the CMA plug-in part to draw it out.

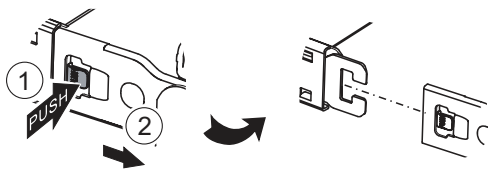

Then turn the CMA 90 degrees to the right, and press the **PUSH** button on the CMA plug-in part to draw it out.

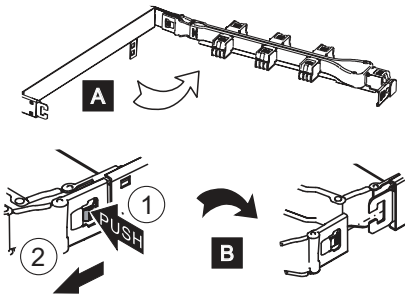

- b. To release the inner member, press the **PUSH** button on the CMA plug-in part to draw it out.

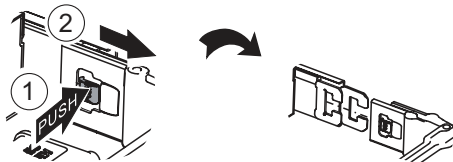

Setting up and configuring the iDRAC IP address

You can set up the Integrated Dell Remote Access Controller (iDRAC) IP address by using one of the following interfaces:

- iDRAC Settings utility
- Lifecycle Controller
- Dell OpenManage Deployment Toolkit

You can configure iDRAC IP address by using the following interfaces:

- iDRAC Web interface. For more information about the iDRAC Web interface, see the Integrated Dell Remote Access Controller User's Guide.
- Remote Access Controller ADMin (RACADM). For more information about the RACADM, see the RACADM Command Line Interface Reference Guide and the Integrated Dell Remote Access Controller User's Guide.
- Remote Services that includes Web Services Management (WS-Man). For more information about the Remote Services, see the Lifecycle Controller Remote Services Quick Start Guide.

For more information about setting up and configuring iDRAC, see the Integrated Dell Remote Access Controller User's Guide at dell.com/idracmanuals.

Configuring the iDRAC settings for the dedicated management port card

1. Turn on or restart your system.
2. Press **F2** immediately after you see the following message:

```
F2 = System Setup
```

If your operating system begins to load before you press **F2**, enable the system to finish booting, and then restart your system and try again.

3. In the **System Setup Main Menu** page, click **iDRAC Settings** → **Network**.

4. If the dedicated management port card is installed:

By default, the **NIC Selection** option in **Network Settings** is set to **Dedicated**; the **Register DRAC on DNS** option in **Common Settings** is disabled.

You can also set the **NIC Selection** option to **LOM1**, **LOM2**, **LOM3** or **LOM4**.

5. If the dedicated management port card is not installed:

By default, the **NIC Selection** option in **Network Settings** is set to **LOM1**; the **Register DRAC on DNS** option in **Common Settings** is disabled.

You can also set the **NIC Selection** option to **LOM2**, **LOM3** or **LOM4**.

Logging in to iDRAC

You can log in to iDRAC as an iDRAC local user, a Microsoft Active Directory user, or a Lightweight Directory Access Protocol (LDAP) user. You can also log in by using Single Sign-On or a Smart Card. The default user name is **root** and password is **calvin**. For more information about logging in to iDRAC and iDRAC licenses, see the Integrated Dell Remote Access Controller User's Guide at dell.com/idracmanuals.

You can also access iDRAC using RACADM. For more information about using RACADM, see the RACADM Command Line Interface Reference Guide and the Integrated Dell Remote Access Controller User's Guide available at dell.com/idracmanuals.

Installing the OS

If the server is shipped without an OS, install the supported OS on the server by using one of the following methods:

- For information about Dell Systems Management Tools and Documentation media, see the OS documentation at dell.com/operatingsystemmanuals.
- For information about Dell Lifecycle Controller, see the Lifecycle Controller documentation at dell.com/idracmanuals.
- For information about Dell OpenManage Deployment Toolkit, see the OpenManage documentation at dell.com/openmanagemanuals.
- Installation by using Preboot Execution Environment (PXE), Windows Deployment Services (WDS), or a DVD.

For information about the list of OSs supported on your system, see the OS support matrix at dell.com/ossupport.

Managing your system remotely

To perform out-of-band systems management using iDRAC, you must configure iDRAC for remote accessibility, set up the management station and managed system, and configure the supported Web browsers. For more information about configuring iDRAC for remote accessibility, see the Integrated Dell Remote Access Controller User's Guide at dell.com/idracmanuals.

You can also remotely monitor and manage the server by using the Dell OpenManage Server Administrator (OMSA) software and OpenManage Essentials (OME) systems management console. For more information about the Dell OMSA software and OME systems management console, see dell.com/openmanagemanuals.

Downloading and installing drivers and firmware

It is recommended that you download and install the latest BIOS, drivers, and systems management firmware on your system.

Prerequisites

Ensure that you clear the web browser cache.

Steps

1. Go to dell.com/support/drivers.
2. In the **Product support** section, enter the Service Tag of your system in the **Enter a Service Tag or Express Service Code** field.



NOTE: If you do not have the Service Tag, select **Auto-detect your product** to enable the system to automatically detect your Service Tag, or select your product by clicking **View products** from the **Browse for a product** section.

3. Click **Drivers and downloads**.

The drivers that are applicable to your selection are displayed.

4. Download the drivers you require to a diskette drive, USB drive, CD, or DVD.

Installing the driver for the LSI 9311 card on a Ubuntu1404 system

1. Download the required driver (mpt3sas.ko) to a USB drive from dell.com/support/drivers.
2. When prompted by the Ubuntu installer CD, select Ubuntu Server for installation.
3. On the **[!]Configure the C lock** screen, press **Ctrl + Alt + F1** to access a console.
4. Mount the USB drive with the driver by using the following command if the USB drive is mapped to the device name sda1 OR sdb1:

```
# mount -t vfat /dev/sda1 /mnt/usb
```

5. Change the directory to the folder with the driver.
6. Use the following commands:

```
# cp -f /LSI/mpt3sas.ko /lib/modules/3.13.0-24-generic/kernel/drivers/scsi
# insmod /lib/modules/3.13.0-24-generic/kernel/fs/configfs/configfs.ko
# insmod /lib/modules/3.13.0-24-generic/kernel/drivers/scsi/scsi_transport_
sas.ko
# insmod /lib/modules/3.13.0-24-generic/kernel/drivers/scsi/raid_class.ko
# insmod /lib/modules/3.13.0-24-generic/kernel/drivers/scsi/mpt3sas.ko
```

7. The driver gets loaded and detects the controller and the disks.
8. Press **Ctrl + Alt + F1** to return to the installer screen.
9. Proceed with the OS installation.

Pre-operating system management applications

The pre-operating system management applications for your system help you manage different settings and features of your system without booting to the operating system.

Your system has the following pre-operating system management applications:

- System Setup
- Boot Manager
- Dell Lifecycle Controller

Navigation keys

The navigation keys can help you access the pre-operating system management applications.

Key	Description
Page Up	Moves to the previous page.
Page Down	Moves to the next page.
Up arrow	Moves to the previous field.
Down arrow	Moves to the next field.
Enter	Enables you to type a value in the selected field (if applicable) or follow the link in the field.
Spacebar	Expands or collapses a drop-down list, if applicable.
Tab	Moves to the next focus area.  NOTE: This feature is applicable for the standard graphical browser only.
Esc	Moves to the previous page until you view the main page. Pressing Esc in the main page exits System BIOS/iDRAC Settings/Device Settings/Service Tag Settings and proceeds with system boot.
F1	Displays the System Setup help.

About System Setup

Using System Setup, you can configure the BIOS settings, iDRAC settings, and device settings of your system.

You can access System Setup in two ways:

- Standard Graphical Browser — This is enabled by default.
- Text Browser — This is enabled using Console Redirection.

 **NOTE:** By default, help text for the selected field is displayed in the graphical browser. To view the help text in the text browser, press **F1**.

Entering System Setup

1. Turn on or restart your system.
2. Press **F2** immediately after you see the following message:

F2 = System Setup

If your operating system begins to load before you press **F2**, enable the system to finish booting, and then restart your system and try again.

System Setup Main Menu

Option	Description
System BIOS	Enables you to configure BIOS settings.
iDRAC Settings	Enables you to configure iDRAC settings. The iDRAC Settings utility is an interface to set up and configure the iDRAC parameters by using UEFI. You can enable or disable various iDRAC parameters by using the iDRAC Settings utility. For more information about this utility, see the Integrated Dell Remote Access Controller User's Guide at dell.com/idracmanuals .
Device Settings	Enables you to configure device settings.

System BIOS page

By using the **System BIOS** page, you can view the BIOS settings and edit specific functions such as Boot order, system password, setup password, setting the RAID mode, and enabling or disabling USB ports.

In the **System Setup Main Menu**, click **System BIOS**.

Menu Item	Description
System Information	Displays information about the system such as the system model name, BIOS version and Service Tag.
Memory Settings	Displays information and options related to the installed memory.
Processor Settings	Displays information and options related to the processor such as speed and cache size.
SATA Settings	Displays options to enable or disable the integrated Serial ATA (SATA) controller and ports.
Boot Settings	Displays options to specify the boot mode (BIOS or UEFI). Enables you to modify UEFI and BIOS boot settings.

Menu Item	Description
Integrated Devices	Displays options to enable or disable integrated device controllers and ports, and to specify related features and options.
Serial Communication	Displays options to enable or disable the serial ports and specify related features and options.
System Profile Settings	Displays options to change the processor power management settings, memory frequency, and so on.
System Security	Displays options to configure the system security settings like, system password, setup password and TPM security. It also enables or disables support for the power and NMI buttons on the system.
Miscellaneous Settings	Displays options to change the system date and time.

System Information page

You can use the **System Information** page to view system properties such as Service Tag, system model, and the BIOS version.

To view the **System Information**, click **System Setup Main Menu** → **System BIOS** → **System Information**.

Menu Item	Description
System Model Name	Displays the system model name.
System BIOS Version	Displays the BIOS version installed on the system.
System Management Engine Version	Displays the latest revision of the Management Engine firmware.
System Service Tag	Displays the system Service Tag.
System Manufacturer	Displays the name of the system manufacturer.
System Manufacturer Contact Information	Displays the contact information of the system manufacturer.
System CPLD Version	Displays the latest revision of the system CPLD firmware.
UEFI Compliance Version	Displays the system firmware UEFI compliance level.

Memory Settings page

You can use the **Memory Settings** page to view all the memory settings and enable or disable specific memory functions such as system memory testing and node interleaving.

To view the **Memory Setting** page, click **System Setup Main Menu** → **System BIOS** → **Memory Settings**.

Menu Item	Description
System Memory Size	Displays the amount of memory installed in the system.
System Memory Type	Displays the type of memory installed in the system.



Menu Item	Description
System Memory Speed	Displays the system memory speed.
System Memory Voltage	Displays the system memory voltage.
Video Memory	Displays the amount of video memory utilized.
System Memory Testing	Specifies whether system memory tests are run during system boot. Options are Enabled and Disabled . By default, the System Memory Testing option is set to Disabled .
Memory Operating Mode	Specifies the memory operating mode. The options available are Optimizer Mode and Spare Mode . By default, the Memory Operating Mode option is set to Optimizer Mode .  NOTE: The Memory Operating Mode can have different defaults and available options based on the memory configuration of your system.
Node Interleaving	Specifies if Non-Uniform Memory architecture (NUMA) is supported. If this field is Enabled , memory interleaving is supported if a symmetric memory configuration is installed. If Disabled , the system supports NUMA (asymmetric) memory configurations. By default, the Node Interleaving option is set to Disabled .
Snoop Mode	Specifies the Snoop Mode options. Snoop Mode options available are Early Snoop and Home Snoop . By default, the Snoop Mode option is set to Early Snoop . The field is only available when the Node Interleaving option is set to Disabled .

Processor Settings page

You can use the **Processor Settings** page to view the processor settings and perform specific functions such as enabling virtualization technology, hardware prefetcher, and logical processor idling.

To view the **Processor Settings** page, click **System Setup Main Menu** → **System BIOS** → **Processor Settings**.

Menu Item	Description
QPI Speed	Specifies the QPI (QuickPath Interconnect). The options available are Maximum data rate and 6.4 GT/s . By default, the QPI Speed option is set to Maximum data rate .
Alternate RTID (Requestor Transaction ID) Setting	Enables you to allocate more RTIDs to the remote socket, thereby increasing cache performance between the sockets or easing work in normal mode for NUMA. By default, the Alternate RTID (Requestor Transaction ID) Setting is set to Disabled .
Virtualization Technology	Enables or disables the additional hardware capabilities provided for virtualization. By default, the Virtualization Technology option is set to Enabled .

Menu Item	Description
Address Translation Service (ATS)	Defines the Address Translation Cache (ATC) for devices to cache the DMA transactions. This field provides an interface to a chipset's Address Translation and Protection Table to translate DMA addresses to host addresses. By default, the option is set to Enabled .
Adjacent Cache Line Prefetch	Optimizes the system for applications that require high utilization of sequential memory access. By default, the Adjacent Cache Line Prefetch option is set to Enabled . You can disable this option for applications that require high utilization of random memory access.
Hardware Prefetcher	Enables or disables the hardware prefetcher. By default, the Hardware Prefetcher option is set to Enabled .
DCU Streamer Prefetcher	Allows you to enable or disable the Data Cache Unit (DCU) streamer prefetcher. By default, the DCU Streamer Prefetcher option is set to Enabled .
DCU IP Prefetcher	Enables or disables the Data Cache Unit (DCU) IP prefetcher. By default, the DCU IP Prefetcher option is set to Enabled .
Logical Processor Idling	Enables or disables the operating system capability to put logical processors in the idling state in order to reduce power consumption. By default, the option is set to Disabled .
Configurable TDP	Allows reconfiguration of Thermal Design Power (TDP) to lower levels. TDP refers to the maximum amount of power the cooling system is required to dissipate.
X2Apic Mode	Enables or disables the X2Apic mode.
Number of Cores per Processor	Controls the number of enabled cores in each processor. By default, the Number of Cores per Processor option is set to All .
Processor 64-bit Support	Specifies if the processors support 64-bit extensions.
Processor Core Speed	Displays the maximum core frequency of the processor.
Processor Bus Speed	Displays the bus speed of the processor.  NOTE: The processor bus speed option displays only when both processors are installed.
Processor 1	 NOTE: Depending on the number of installed CPUs, there may be up to two processor listings. The following settings are displayed for each processor installed in the system.
Family-Model-Stepping	Displays the family, model and stepping of the processor as defined by Intel.
Brand	Displays the brand name reported by the processor.
Level 2 Cache	Displays the total L2 cache.
Level 3 Cache	Displays the total L3 cache.

Menu Item	Description
Number of Cores	Displays the number of cores per processor.
Processor 2	 NOTE: Depending on the number of installed CPUs, there may be up to two processor listings. The following settings are displayed for each processor installed in the system.
Family-Model-Stepping	Displays the family, model and stepping of the processor as defined by Intel.
Brand	Displays the brand name reported by the processor.
Level 2 Cache	Displays the total L2 cache.
Level 3 Cache	Displays the total L3 cache.
Number of Cores	Displays the number of cores per processor.

SATA Settings page

You can use the **SATA Settings** page to view the SATA settings of SATA devices and enable RAID on your system.

To view the **SATA Settings** page, click **System Setup Main Menu** → **System BIOS** → **SATA Settings**.



Menu Item	Description
Embedded SATA	Enables the embedded SATA to be set to Off , ATA , AHCI , or RAID modes. By default, the Embedded SATA option is set to AHCI .
Security Freeze Lock	Sends Security Freeze Lock command to the Embedded SATA drives during POST. This option is applicable only to ATA and AHCI mode.
Write Cache	Enables or disables the command for Embedded SATA drives during POST.
Port A – H (reserved)	Sets the drive type of the selected device. For Embedded SATA settings in ATA mode, set this field to Auto to enable BIOS support. Set it to OFF to turn off BIOS support. For AHCI mode or RAID mode, BIOS always enables support.
Model	Displays the drive model of the selected device.
Drive Type	Displays the type of drive attached to the SATA port.
Capacity	Displays the total storage capacity of the HDD. The field is undefined for removable media devices such as optical drives.
Port I (boot drive A)	Sets the drive type of the selected device. For Embedded SATA settings in ATA mode, set this field to Auto to enable BIOS support. Set it to OFF to turn off BIOS support. For AHCI mode or RAID mode, BIOS always enables support.
Model	Displays the drive model of the selected device.

Menu Item	Description
Drive Type	Displays the type of drive attached to the SATA port.
Capacity	Displays the total capacity of the HDD. The field is undefined for removable media devices such as optical drives.
Port J (boot drive B)	Sets the drive type of the selected device. For Embedded SATA settings in ATA mode, set this field to Auto to enable BIOS support. Set it to OFF to turn off BIOS support. For AHCI mode or RAID mode, BIOS always enables support.
Model	Displays the drive model of the selected device.
Drive Type	Displays the type of drive attached to the SATA port.
Capacity	Displays the total capacity of the HDD. The field is undefined for removable media devices such as optical drives.

Boot Settings page

You can use the **Boot Settings** page to set the Boot mode to either **BIOS** or **UEFI**. It also enables you to specify the boot order.



To view the **Boot Settings** page, click **System Setup Main Menu** → **System BIOS** → **Boot Settings**.

Menu Item	Description
Boot Mode	<p>Enables you to set the boot mode of the system.</p> <p> CAUTION: Switching the boot mode may prevent the system from booting if the operating system is not installed in the same boot mode.</p> <p> NOTE: Setting this field to UEFI disables the BIOS Boot Settings menu. Setting this field to BIOS disables the UEFI Boot Settings menu.</p> <p>If the operating system supports UEFI, you can set this option to UEFI. Setting this field to BIOS enables compatibility with non-UEFI operating systems. By default, the Boot Mode option is set to BIOS.</p>
Boot Sequence Retry	Enables or disables the Boot Sequence Retry feature. If this field is enabled and the system fails to boot, the system reattempts the boot sequence after 30 seconds. By default, the Boot Sequence Retry option is set to Enabled .
Hard-Disk Failover	Specifies which devices in the Hard-Disk Drive Sequence are attempted in the boot sequence. When the option is Disabled , only the first HDD in the list is attempted to boot. When set to Enabled , all hard disk devices are attempted in order, as listed in the Hard-Disk Drive Sequence . This option is not enabled for UEFI Boot Mode.
Boot Option Settings	Configures the boot sequence and the boot devices.

Integrated Devices page details

The **Integrated Devices** page enables you to view and configure the settings of all integrated devices including the video controller, integrated RAID controller, and the USB ports.

In the **System Setup Main Menu** page, click **System BIOS** → **Integrated Devices**.



Menu Item	Description
USB 3.0 Setting	Allows you to enable or disable the USB 3.0 support. Enable this option only if your operating system supports USB 3.0. Disabling this allows devices to operate at USB 2.0 speed. USB 3.0 is disabled by default.
User Accessible USB Ports	<p>Allows you to enable or disable the USB ports. To disable front USB ports, select Only Back Ports On; to disable all USB ports, select All Ports Off. The USB keyboard and mouse device operates during boot process in certain operating systems. After the boot process is complete, the USB keyboard and mouse device do not work if the ports are disabled.</p> <p> NOTE: Selecting Only Back Ports On and All Ports Off will disable the USB management port and also restrict access to iDRAC features.</p> <p> NOTE: Front USB ports may not be available on your model.</p>
Internal USB Port	Allows you to enable or disable the internal USB port. By default, the Internal USB Port option is set to On .
Embedded NIC1 and NIC2	Allows you to enable or disable the Embedded NIC1 and NIC2. If set to Disabled (OS) , the NIC may still be available for shared network access by the embedded management controller. Configure this function using the NIC management utilities of the system.
Embedded NIC3 and NIC4	Allows you to enable or disable the Embedded NIC3 and NIC4. If set to Disabled (OS) , the NIC may still be available for shared network access by the embedded management controller. Configure this function using the NIC management utilities of the system.
I/OAT DMA Engine	Allows you to enable or disable the I/OAT option. Enable only if the hardware and software supports the feature.
Embedded Video Controller	Allows you to enable or disable the Embedded Video Controller . By default, the embedded video controller is Enabled . If the Embedded Video Controller is the only display capability in the system (that is, no add-in graphics card is installed), then the Embedded Video Controller is automatically used as the primary display even if the Embedded Video Controller setting is Disabled .
Current State of Embedded Video Controller	Displays the current state of the Embedded Video Controller. Current State of Embedded Video Controller is a read only field, indicating the current state for the Embedded Video Controller.
SR-IOV Global Enable	Allows you to enable or disable the BIOS configuration of Single Root I/O Virtualization (SR-IOV) devices. By default, the SR-IOV Global Enable option is set to Disabled .

Menu Item	Description
OS Watchdog Timer	If your system stops responding, this watchdog timer aids in the recovery of your operating system. When this field is set to Enabled , the operating system is allowed to initialize the timer. When the field is set to Disabled (the default), the timer will have no effect on the system.
Memory Mapped I/O above 4 GB	Allows you to enable support for PCIe devices that require large amounts of memory. By default, the option is set to Enabled .
Slot Disablement	Allows you to enable or disable the available PCIe slots on your system. The Slot Disablement feature controls the configuration of PCIe cards installed in the specified slot. Slot disablement must be used only when the installed peripheral card is preventing booting into the operating system or causing delays in system startup. If the slot is disabled, both the Option ROM and UEFI driver are disabled.

Serial Communication page

You can use the **Serial Communication** page to view the properties of the serial communication port.

To view the **Serial Communication** page, click **System Setup Main Menu** → **System BIOS** → **Serial Communication**.

Menu Item	Description
Serial Communication	Selects serial communication devices (Serial Device 1 and Serial Device 2) in the BIOS. BIOS console redirection can also be enabled and the port address can be specified. By default, Serial Communication option is set to Auto .
Serial Port Address	<p>Enables you to set the port address for serial devices. By default, the Serial Port Address option is set to Serial Device 1=COM2, Serial Device 2=COM1.</p> <p> NOTE: You can use only Serial Device 2 for the Serial Over LAN (SOL) feature. To use console redirection by SOL, configure the same port address for console redirection and the serial device.</p> <p> NOTE: Every time the system boots, the BIOS syncs the serial MUX setting saved in iDRAC. The serial MUX setting can independently be changed in iDRAC. Therefore, loading the BIOS default settings from within the BIOS setup utility may not always revert this setting to the default setting of Serial Device 1.</p>
External Serial Connector	<p>You can associate the External Serial Connector to Serial Device 1, Serial Device 2, or the Remote Access Device using this field.</p> <p> NOTE: Only Serial Device 2 can be used for (Serial Over LAN) SOL. To use console redirection by SOL, configure the same port address for console redirection and the serial device.</p>



Menu Item	Description
	 NOTE: Every time the system boots, the BIOS syncs the serial MUX setting saved in iDRAC. The serial MUX setting can independently be changed in iDRAC. Therefore, loading the BIOS default settings from within the BIOS setup utility may not always revert this setting to the default setting of Serial Device 1.
Failsafe Baud Rate	Displays the failsafe baud rate for console redirection. The BIOS attempts to determine the baud rate automatically. This failsafe baud rate is used only if the attempt fails, and the value must not be changed. By default, the Failsafe Baud Rate option is set to 115200 .
Remote Terminal Type	Sets the remote console terminal type. By default, the Remote Terminal Type option is set to VT100/VT220 .
Redirection After Boot	Enables or disables the BIOS console redirection when the operating system is loaded. By default, the Redirection After Boot option is set to Enabled .

System Profile Settings page

You can use the **System Profile Settings** page to enable specific system performance settings such as power management.

To view the **System Profile Settings** page, click **System Setup Main Menu** → **System BIOS** → **System Profile Settings**.

Menu Item	Description
System Profile	Sets the system profile. If you set the System Profile option to a mode other than Custom , the BIOS automatically sets the rest of the options. You can only change the rest of the options if the mode is set to Custom . By default, the System Profile option is set to Performance Per Watt (DAPC) . DAPC is Dell Active Power Controller.  NOTE: The following parameters are available only when the System Profile is set to Custom .
CPU Power Management	Sets the CPU power management. By default, the CPU Power Management option is set to System DBPM (DAPC) . DBPM is Demand-Based Power Management.
Memory Frequency	Sets the speed of the system memory. You can select Maximum Performance , Maximum Reliability , or a specific speed.
C1E	Enables or disables the processor to switch to a minimum performance state when it is idle. By default, the C1E option is set to Enabled .
C States	Enables or disables the processor to operate in all available power states. By default, the C States option is set to Enabled .
Collaborative CPU Performance Control	Enables or disables the CPU power management. When set to Enabled , the CPU power management is controlled by the OS DBPM and the System DBPM (DAPC). By default, the option is set to Disabled .

Menu Item	Description
Memory Patrol Scrub	Sets the memory patrol scrub frequency. By default, the Memory Patrol Scrub option is set to Standard .
Memory Refresh Rate	Sets the memory refresh rate to either 1x or 2x. By default, the Memory Refresh Rate option is set to 1x .
Uncore Frequency	Dynamic mode allows the processor to optimize power resources across the cores and uncore during runtime. The optimization of the uncore frequency to either save power or optimize performance is influenced by the setting of the Energy Efficiency Policy .
Energy Efficient Policy	Enables you to select the Energy Efficient Policy . The CPU uses the setting to manipulate the internal behavior of the processor and determines whether to target higher performance or better power savings.
Monitor/Mwait	Enables the Monitor/Mwait instructions in the processor. By default, the Monitor/Mwait option is set to Enabled for all system profiles, except Custom .  NOTE: This option can be disabled only if the C States option in Custom mode is disabled.  NOTE: When C States is enabled in Custom mode, changing the Monitor/Mwait setting does not impact system power or performance.

System Security Settings page

You can use the **System Security** page to perform specific functions such as setting the system password, setup password and disabling the power button.

To view the **System Security** page, click **System Setup Main Menu** → **System BIOS** → **System Security Settings**.

Menu Item	Description
Intel AES-NI	Improves the speed of applications by performing encryption and decryption using the Advanced Encryption Standard Instruction Set and is set to Enabled by default.
System Password	Sets the system password. This option is set to Enabled by default and is read-only if the password jumper is not installed in the system.
Setup Password	Sets the setup password. This option is read-only if the password jumper is not installed in the system.
Password Status	Locks the system password. By default, the Password Status option is set to Unlocked .
TPM Information	Changes the operational state of the TPM. By default, the TPM Activation option is set to No Change .

Menu Item	Description
Intel TXT	Enables or disables the Intel Trusted Execution Technology (TXT). To enable Intel TXT , Virtualization Technology must be enabled and TPM Security must be Enabled with Pre-boot measurements. By default, the Intel TXT option is set to Off .
Power Button	Enables or disables the power button on the front of the system. By default, the Power Button option is set to Enabled .
NMI Button	Enables or disables the NMI button on the front of the system. By default, the NMI Button option is set to Disabled .
AC Power Recovery	Sets how the system reacts after AC power is restored to the system. By default, the AC Power Recovery option is set to Last .
AC Power Recovery Delay	Sets how the system supports staggering of power up after AC power is restored to the system. By default, the AC Power Recovery Delay option is set to Immediate .
User Defined Delay (60s to 240s)	Sets the User Defined Delay when the User Defined option for AC Power Recovery Delay is selected.
UEFI Variable Access	Provides varying degrees of securing UEFI variables. When set to Standard (the default) UEFI variables are accessible in the Operating System per the UEFI specification. When set to Controlled , selected UEFI variables are protected in the environment and new UEFI boot entries are forced to be at the end of the current boot order.
Secure Boot	Enables Secure Boot, where the BIOS authenticates each pre-boot image using the certificates in the Secure Boot Policy. Secure Boot is disabled by default.
Secure Boot Policy	When Secure Boot policy is Standard , the BIOS uses the system manufacturer's key and certificates to authenticate pre-boot images. When Secure Boot policy is Custom , the BIOS uses the user-defined key and certificates. Secure Boot policy is Standard by default.
Secure Boot Policy Summary	Displays the list of certificates and hashes that secure boot uses to authenticate images.

Secure Boot Custom Policy Settings page

Secure Boot Custom Policy Settings is displayed only when **Secure Boot Policy** is set to **Custom**.

In the **System Setup Main Menu** page, click **System BIOS** → **System Security** → **Secure Boot Custom Policy Settings**.

Menu Item	Description
Platform Key	Imports, exports, deletes, or restores the platform key (PK).
Key Exchange Key Database	Allows you to import, export, delete, or restore entries in the Key Exchange Key (KEK) Database.

Menu Item	Description
Authorized Signature Database	Imports, exports, deletes, or restores entries in the Authorized Signature Database (db).
Forbidden Signature Database	Imports, exports, deletes, or restores entries in the Forbidden Signature Database (dbx).

Miscellaneous Settings page

You can use the **Miscellaneous Settings** page to perform specific functions such as updating the asset tag and changing the system date and time.

To view the **Miscellaneous Settings** page, click **System Setup Main Menu** → **System BIOS** → **Miscellaneous Settings**.

Menu Item	Description
System Time	Enables you to set the time on the system.
System Date	Enables you to set the date on the system.
Asset Tag	Displays the asset tag and enables you to modify it for security and tracking purposes.
Keyboard NumLock	Enables you to set whether the system boots with the NumLock enabled or disabled. By default the Keyboard NumLock is set to On .  NOTE: A NOTE indicates important information that helps you make better use of your computer.
F1/F2 Prompt on Error	Enables or disables the F1/F2 prompt on error. By default, F1/F2 Prompt on Error is set to Enabled . The F1/F2 prompt also includes keyboard errors.
Load Legacy Video Option ROM	Enables you to determine whether the system BIOS loads the legacy video (INT 10H) option ROM from the video controller. Selecting Enabled in the operating system does not support UEFI video output standards. This field is only for UEFI boot mode. You cannot set this to Enabled if UEFI Secure Boot mode is enabled.

About Boot Manager

Boot Manager enables you to add, delete, and arrange boot options. You can also access System Setup and boot options without restarting the system.

Entering Boot Manager

The Boot Manager page allows you to select boot options and diagnostic utilities.

1. Turn on or restart your system.
2. Press **F11** when you see the message `F11 = Boot Manager`.

If your operating system begins to load before you press **F11**, allow the system to finish booting, and then restart your system and try again.

Boot Manager main menu

Menu Item	Description
Continue Normal Boot	The system attempts to boot to devices starting with the first item in the boot order. If the boot attempt fails, the system continues with the next item in the boot order until the boot is successful or no more boot options are found.
One Shot Boot Menu	Takes you to the boot menu where you can select a one time boot device to boot from.
Launch System Setup	Enables you to access the System Setup.
Launch Lifecycle Controller	Exits the Boot Manager and invokes the Lifecycle Controller program.
System Utilities	Starts system utilities menu such as system diagnostics and UEFI shell.

About Dell Lifecycle Controller

Dell Lifecycle Controller allows you to perform useful tasks such as configuring BIOS and hardware settings, deploying an operating system, updating drivers, changing RAID settings, and saving hardware profiles. For more information about Dell Lifecycle Controller, see the documentation at dell.com/idracmanuals.

Changing the boot order

You may have to change the boot order if you want to boot from a USB key or an optical drive. The instructions given here may vary if you have selected **BIOS** for **Boot Mode**.

1. In the **System Setup Main Menu**, click **System BIOS** → **Boot Settings**.
2. Click **Boot Option Settings** → **Boot Sequence**.
3. Use the arrow keys to select a boot device, and use the **+** and **-** keys to move the device down or up in the order.
4. Click **Exit**, click **Yes** to save the settings on exit.

Choosing the system boot mode

System Setup enables you to specify the boot mode for installing your operating system:

- BIOS boot mode (the default) is the standard BIOS-level boot interface.
- UEFI boot mode is an enhanced 64-bit boot interface based on Unified Extensible Firmware Interface (UEFI) specifications that overlays the system BIOS.

To select the system **Boot Mode**:

1. In the **System Setup Main Menu**, click **System BIOS** → **Boot Settings** → **Boot Mode**.
2. Select the **Boot Mode** you want the system to boot into.

 **NOTE:** After the system boots in the specified boot mode, proceed to install your operating system from that mode.

 **CAUTION:** Trying to boot the operating system from the other boot mode will cause the system to halt at startup.

 **NOTE:** Operating systems must be UEFI-compatible to be installed from the UEFI boot mode. DOS and 32-bit operating systems do not support UEFI and can only be installed from the BIOS boot mode.

 **NOTE:** For more information about supported operating systems, go to dell.com/ossupport.

Assigning a system and setup password

Prerequisites

You can assign a new **System Password** and **Setup Password** or change an existing **System Password** and **Setup Password** only when the password jumper setting is **enabled** and **Password Status** is **Unlocked**.

If the password jumper setting is disabled, the existing **System Password** and **Setup Password** are deleted and you need not provide the system password to boot the system.

 **NOTE:** The password jumper enables or disables the System Password and Setup Password features. For more information about the password jumper settings, see [System board jumper settings](#).

Steps

1. To start System Setup, press **F2** immediately after a turn-on or reboot.
2. From the **System Setup Main Menu**, select **System BIOS** and press **Enter**.
The **System BIOS** page is displayed.
3. On the **System BIOS** page, select **System Security** and press **Enter**.
The **System Security** page is displayed.
4. On the **System Security** page, verify that **Password Status** is **Unlocked**.
5. Select **System Password**, enter your system password, and press **Enter** or **Tab**.
Use the following guidelines to assign the system password:
 - A password can have up to 32 characters.
 - The password can contain the numbers 0 – 9.
 - Only the following special characters are allowed: space, ("), (+), (,), (-), (.), (/), (:), (!), (\), (|), (`).A message prompts you to reenter the system password.
6. Reenter the system password, and click **OK**.
7. Select **Setup Password**, enter your setup password and press **Enter** or **Tab**.
A message prompts you to reenter the setup password.
8. Reenter the setup password, and click **OK**.
9. Press **Esc** to return to the System BIOS page. Press **Esc** again.
A message prompts you to save the changes.

 **NOTE:** Password protection does not take effect until the system reboots.

Using your system password to secure your system

Prerequisites

 NOTE: If you have assigned a setup password, the system accepts your setup password as an alternate system password.

Steps

1. Turn on or reboot your system.
2. Type your password and press **Enter**.

Next steps

When **Password Status** is **Locked**, type the password and press **Enter** when prompted at reboot.

If an incorrect system password is entered, the system displays a message and prompts you to reenter your password. You have three attempts to enter the correct password. After the third unsuccessful attempt, a message is displayed indicating that the system has halted and must be turned off.

Even after you shut down and restart the system, if your password is incorrect, a message is displayed indicating that your password is incorrect.

 NOTE: You can use the **Password Status** option in conjunction with the **System Password** and **Setup Password** options to protect your system from unauthorized changes.

Deleting or changing an existing system and/or setup password

Prerequisites

Ensure that the Password jumper is set to enabled and the **Password Status** is set to **Unlocked** before attempting to delete or change the existing System and/or Setup password. You cannot delete or change an existing System or Setup password if the **Password Status** is **Locked**.

Steps

1. To enter System Setup, press **F2** immediately after a turn-on or restart.
2. In the **System Setup Main Menu**, select **System BIOS** and press **Enter**.
The **System BIOS** page is displayed.
3. In the **System BIOS** page, select **System Security** and press **Enter**.
The **System Security** page is displayed.
4. In the **System Security** page, verify that **Password Status** is set to **Unlocked**.
5. Select **System Password**, change or delete the existing system password and press **Enter** or **Tab**.
6. Select **Setup Password**, change or delete the existing setup password and press **Enter** or **Tab**.

 NOTE: If you change the System and/or Setup password, a message prompts you to reenter the new password. If you delete the System and/or Setup password, a message prompts you to confirm the deletion.

7. Press **Esc** to return to the System BIOS page. Press **Esc** again, and a message prompts you to save the changes.

Operating with a setup password enabled

If **Setup Password** is **Enabled**, enter the correct setup password before modifying most of the System Setup options.

If you do not enter the correct password in three attempts, the system displays the following message:

```
Invalid Password! Number of unsuccessful password attempts: <x> System Halted!  
Must power down.
```

Even after you shut down and restart the system, if your password is incorrect, a message is displayed indicating that your password is incorrect. The following options are exceptions:

- If **System Password** is not **Enabled** and is not locked through the **Password Status** option, you can assign a system password.
- You cannot disable or change an existing system password.

 **NOTE:** You can use the Password Status option in conjunction with the **Setup Password** option to protect the system password from unauthorized changes.

Embedded system management

The Dell Lifecycle Controller provides advanced embedded systems management throughout the server's lifecycle. The Lifecycle Controller can be started during the boot sequence and can function independently of the operating system.

 **NOTE:** Certain platform configurations may not support the full set of features provided by the Lifecycle Controller.

For more information about setting up the Lifecycle Controller, configuring hardware and firmware, and deploying the operating system, see the Lifecycle Controller documentation at dell.com/support.

iDRAC Settings utility

The iDRAC Settings utility is an interface to set up and configure the iDRAC parameters using UEFI. You can enable or disable various iDRAC parameters using the iDRAC Settings Utility.

 **NOTE:** Accessing some of the features on the iDRAC Settings utility requires the iDRAC Enterprise License upgrade.

For more information about using iDRAC, see the iDRAC User's Guide at dell.com/idracmanuals.

Entering the iDRAC Settings utility

1. Turn on or restart the managed system.
2. Press **F2** during Power-on Self-test (POST).
3. In the **System Setup Main Menu**, click **iDRAC Settings**.

The iDRAC Settings page is displayed.

Changing the Thermal Settings

The iDRAC Settings utility enables you to select and customize the thermal control settings for your system.

1. Start the iDRAC Settings utility.

2. Under **iDRAC Settings** → **Thermal** → **User Cooling Options**, select between the following options:

- Default
- Custom









NOTE: When the **User Option** is set to the **Default** setting, the user option cannot be modified.

3. Click **Back** → **Finish** → **Yes**.

Installing and removing system components

Safety instructions

-  **WARNING:** Whenever you need to lift the system, get others to assist you. To avoid injury, do not attempt to lift the system by yourself.
-  **WARNING:** Opening or removing the system cover while the system is powered on may expose you to a risk of electric shock.
-  **CAUTION:** Do not operate the system without the cover for a duration exceeding five minutes.
-  **CAUTION:** Many repairs may only be done by a certified service technician. You should only perform troubleshooting and simple repairs as authorized in your product documentation, or as directed by the online or telephone service and support team. Damage due to servicing that is not authorized by Dell is not covered by your warranty. Read and follow the safety instructions that came with the product.
-  **NOTE:** It is recommended that you always use a static mat and static strap while working on components inside the system.
-  **NOTE:** To ensure proper operation and cooling, all bays in the system must be populated at all times with either a module or with a blank.

Before working inside your system

1. Turn off the system, including any attached peripherals.
2. Disconnect the system from the electrical outlet and disconnect the peripherals.
3. Remove the system cover.

Related Links

[Removing the system cover](#)

After working inside your system

1. Install the system cover.
2. Reconnect the system to its electrical outlet.
3. Turn the system on, including any attached peripherals.

Related Links

[Installing the system cover](#)

Recommended tools

You may require the following items to perform the procedures in this section:

- #2 Phillips screwdriver
- Hex nut driver
- Wrist grounding strap connected to ground

System cover

 **WARNING:** Whenever you need to lift the system, get others to assist you. To avoid injury, do not attempt to lift the system by yourself.

 **WARNING:** Installing or removing the system cover when the system is on may expose you to a risk of electric shock.

 **CAUTION:** Many repairs may only be done by a certified service technician. You should only perform troubleshooting and simple repairs as authorized in your product documentation, or as directed by the online or telephone service and support team. Damage due to servicing that is not authorized by Dell is not covered by your warranty. Read and follow the safety instructions that came with the product.

 **CAUTION:** Do not operate the system without the cover for a duration exceeding five minutes.

Removing the system cover

Prerequisites

1. Ensure that you read the [Safety instructions](#).
2. Turn off the system, including any attached peripherals.
3. Disconnect the system from the electrical outlet and peripherals.

Steps

1. Loosen the screw from the system cover.
2. Slide the four release latches as indicated by the directional arrows on the latches.
3. Hold the cover on both sides, and lift the cover away from the system.

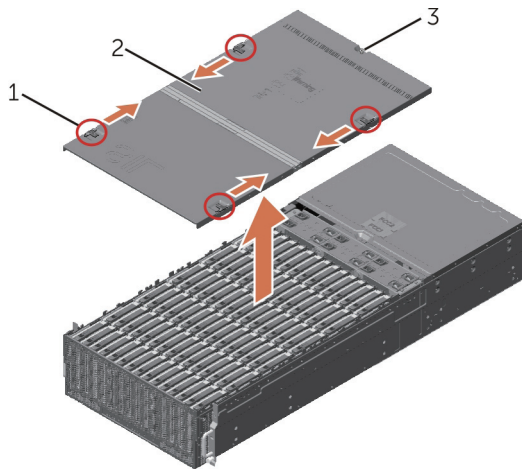

Figure 12. Removing and installing the system cover

- | | | | |
|---|-------------------|---|--------------|
| 1 | release latch (4) | 2 | system cover |
| 3 | screw | | |

Installing the system cover

Prerequisites

Ensure that you read the [Safety instructions](#).

Steps

1. Align the slots of the system cover with the tabs on the chassis.
2. Slide back the four release latches until they lock into place.
3. Tighten the screw to secure the system cover.

Next steps

Complete the procedure listed in [After working inside your system](#).

Server sleds

 **NOTE:** A dummy sled will be installed over sled B compartment for the single-node system.

Removing the server sled

Prerequisites

 **CAUTION:** Many repairs may only be done by a certified service technician. You should only perform troubleshooting and simple repairs as authorized in your product documentation, or as directed by the online or telephone service and support team. Damage due to servicing that is not authorized by Dell is not covered by your warranty. Read and follow the safety instructions that came with the product.

1. Ensure that you read the [Safety instructions](#).
2. Complete the procedure listed in [Before working inside your system](#).

△ CAUTION: Never operate your system with the cooling shroud removed. The system may get overheated quickly, resulting in shutdown of the system and loss of data.

△ CAUTION: The replacement service time for server sleds when the system is operating is two minutes.

Steps

1. Loosen the two screws locking the server sled.
2. Pull the lever outward to release the server sled.
3. Pull the server sled sway from the system.

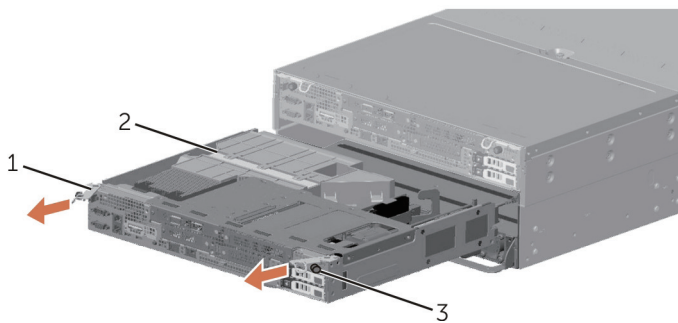

Figure 13. Removing and installing the server sled

- | | | | |
|---|-----------|---|-------------|
| 1 | lever (2) | 2 | server sled |
| 3 | screw (2) | | |

Installing the server sled

Prerequisites

△ CAUTION: Many repairs may only be done by a certified service technician. You should only perform troubleshooting and simple repairs as authorized in your product documentation, or as directed by the online or telephone service and support team. Damage due to servicing that is not authorized by Dell is not covered by your warranty. Read and follow the safety instructions that came with the product.

1. Ensure that you read the [Safety instructions](#).
2. Complete the procedure listed in [Before working inside your system](#).

Steps

1. Install the server sled into the system.
Pay attention not to damage the airmax connectors during installation.
2. Push the lever inward to put the server sled into place.
3. Tighten the two screws to secure the server sled.

Next steps

Complete the procedure listed in [After working inside your system](#).

Expansion cards and expansion-card riser module

 NOTE: A missing or an unsupported expansion-card riser module logs an SEL event. It does not prevent your system from powering on and no BIOS POST message or F1/F2 pause is displayed.

Expansion card installation guidelines

 NOTE: Only supported cards from Dell can be installed in the system.

Your system supports Generation 3 cards. The following table provides riser configurations for DSS 7500 systems:

Table 1. Expansion card slots available on the expansion-card riser module

Expansion-card riser module	PCIe slot on the expansion-card riser module	Processor connection	Height	Length	Link width	Slot width
PCIE_G3_X8	1	Processor 2	Half Height	Half Length	x8	x8
PCIE_G3_X16	2	Processor 1	Full Height	Half Length	x16	x16
PCIE_G3_X8	3	Processor 1	Full Height	Half Length	x8	x8
PCIE_G3_X8	4	Processor 1	Half Height	Half Length	x8	x8

 NOTE: The PCIE_G3_X8 and PCIE_G3_X16 are the two different types of risers supported on DSS 7500 systems. You can install an expansion card on the system board only using expansion-card riser module.

 NOTE: The expansion cards are not hot-swappable.

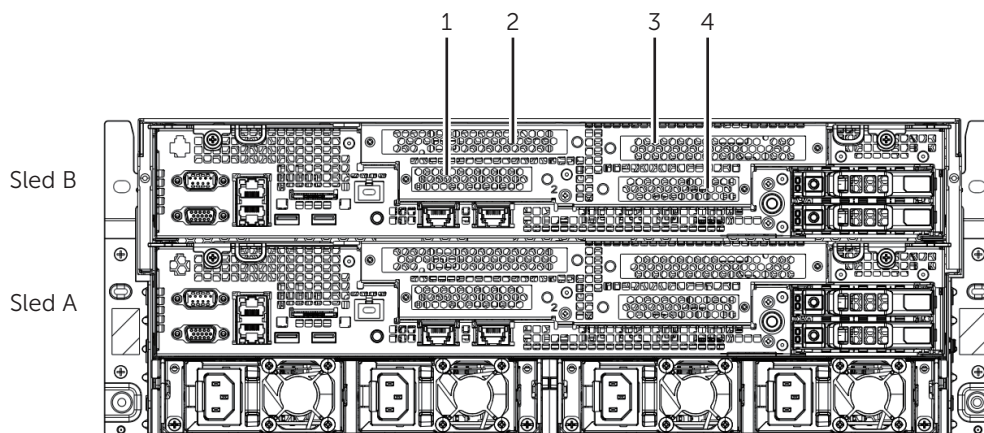



Figure 14. Expansion card slot allocation

- | | | | |
|---|--------|---|--------|
| 1 | slot 1 | 2 | slot 2 |
| 3 | slot 3 | 4 | slot 4 |

 NOTE: A dummy sled will be installed over sled B compartment for the single-node system.

The following table provides a guide for installing expansion cards to ensure proper cooling and mechanical fit. The expansion cards with the highest priority must be installed first using the slot priority indicated. All other expansion cards must be installed in card priority and slot priority order.

Table 2. Expansion card installation order

Card priority	Card type	Slot priority	Maximum allowed
1	RAID	4	1
2	40 Gb NICs	1, 2	2
3	10 Gb NICs	2, 1	2

Removing the expansion-card riser module

Prerequisites

 **CAUTION:** Many repairs may only be done by a certified service technician. You should only perform troubleshooting and simple repairs as authorized in your product documentation, or as directed by the online or telephone service and support team. Damage due to servicing that is not authorized by Dell is not covered by your warranty. Read and follow the safety instructions that came with the product.

1. Ensure that you read the [Safety instructions](#).
2. Complete the procedure listed in [Before working inside your system](#).
3. Remove the server sled.

Steps

Remove the five screws and lift the expansion-card riser module from the riser connector on the system board.

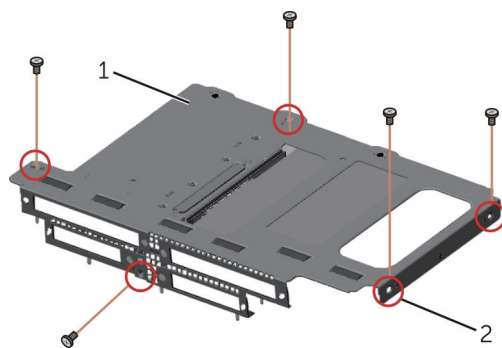

Figure 15. Removing and installing the expansion-card riser module

1 expansion-card riser module

2 screw (5)

Next steps

1. Install the expansion card, if applicable.
2. Install the expansion-card riser module.
3. Complete the procedure listed in [After working inside your system](#).

Related Links

[Removing the server sled](#)

[Removing an expansion card](#)

[Installing a riser card](#)

[Installing the expansion-card riser module](#)

Installing the expansion-card riser module

Prerequisites



CAUTION: Many repairs may only be done by a certified service technician. You should only perform troubleshooting and simple repairs as authorized in your product documentation, or as directed by the online or telephone service and support team. Damage due to servicing that is not authorized by Dell is not covered by your warranty. Read and follow the safety instructions that came with the product.

Ensure that you read the [Safety instructions](#).

Steps

1. If applicable, reinstall the expansion card into the expansion-card riser module.
2. Align the guides on the expansion-card riser module with the holes on the server sled.
3. Lower the expansion-card riser module until it is fully seated.
4. Secure the expansion-card riser module with the five screws.

Next steps

Complete the procedure listed in [After working inside your system](#).

Related Links

[Removing an expansion card](#)

[Installing a riser card](#)

[Removing the server sled](#)

[Installing the server sled](#)

Removing an expansion card

Prerequisites



CAUTION: Many repairs may only be done by a certified service technician. You should only perform troubleshooting and simple repairs as authorized in your product documentation, or as directed by the online or telephone service and support team. Damage due to servicing that is not authorized by Dell is not covered by your warranty. Read and follow the safety instructions that came with the product.

1. Ensure that you read the [Safety instructions](#).
2. Complete the procedure listed in [Before working inside your system](#).
3. Remove the expansion-card riser module.

Steps

1. Remove the screw securing the expansion card and remove the expansion card from the riser card.
2. If you are removing the expansion card permanently, install a metal filler bracket over the empty expansion slot.

 **NOTE:** You must install a filler bracket over an empty expansion slot to maintain Federal Communications Commission (FCC) certification of the system. The brackets also keep dust and dirt out of the system and aid in proper cooling and airflow inside the system.

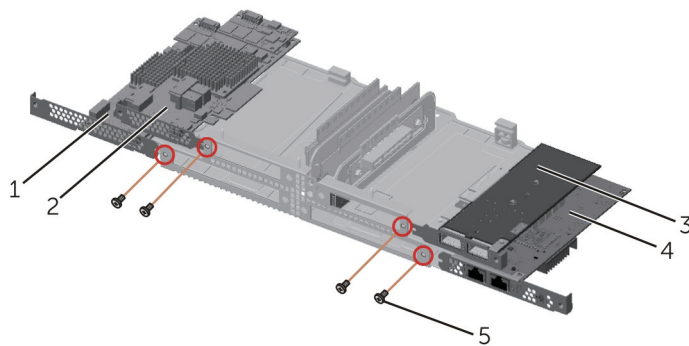

Figure 16. Removing and installing the expansion card

- | | | | |
|---|-----------|---|-----------|
| 1 | RAID card | 2 | RAID card |
| 3 | NIC card | 4 | NIC card |
| 5 | screw (4) | | |

 **NOTE:** For information about the expansion card priority and slot priority order, see [Table 2](#).

Next steps

Complete the procedure listed in [After working inside your system](#).

Related Links

- [Removing the expansion-card riser module](#)
- [Installing the expansion-card riser module](#)

Installing an expansion card

 **NOTE:** Only supported cards from Dell can be installed in the system.

Prerequisites

 **CAUTION:** Many repairs may only be done by a certified service technician. You should only perform troubleshooting and simple repairs as authorized in your product documentation, or as directed by the online or telephone service and support team. Damage due to servicing that is not authorized by Dell is not covered by your warranty. Read and follow the safety instructions that came with the product.

1. Ensure that you read the [Safety instructions](#).
2. Complete the procedure listed in [Before working inside your system](#).
3. Remove the expansion-card riser module.

Steps

1. Insert the expansion card into the riser card until the card is fully seated.
2. Secure the expansion card with the screw.

Next steps

1. Install the expansion-card riser module on the system board.
2. Complete the procedure listed in [After working inside your system](#).

Related Links

[Removing the expansion-card riser module](#)

[Installing the expansion-card riser module](#)

[Removing the server sled](#)

[Installing the server sled](#)

Installing an optional card

Your system supports adding a second card. Install the second card in the assigned slot location.

Table 3. Optional card slot allocation

Card type	Slot
X520	slot 1
X540	slot 1
CX3pro	slot 2

 **NOTE:** Only supported cards from Dell can be installed in the system.

Prerequisites

 **CAUTION:** Many repairs may only be done by a certified service technician. You should only perform troubleshooting and simple repairs as authorized in your product documentation, or as directed by the online or telephone service and support team. Damage due to servicing that is not authorized by Dell is not covered by your warranty. Read and follow the safety instructions that came with the product.

1. Ensure that you read the [Safety instructions](#).
2. Complete the procedure listed in [Before working inside your system](#).

3. Remove the expansion-card riser module.

Steps

1. Attach and secure the system's expansion-card bracket to the card with two screws.

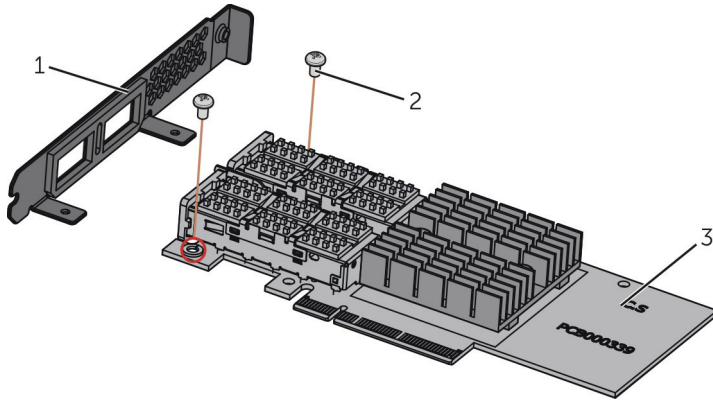

Figure 17. Attaching the bracket to the CX3pro card

- 1 bracket
- 2 screw (2)
- 3 CX3pro card

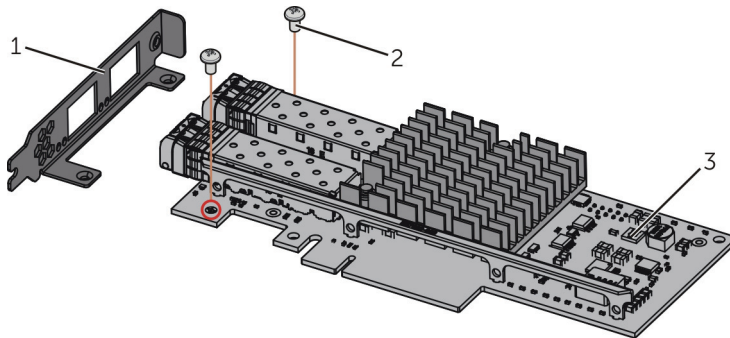

Figure 18. Attaching the bracket to the X520 card

- 1 bracket
- 2 screw (2)
- 3 X520 card

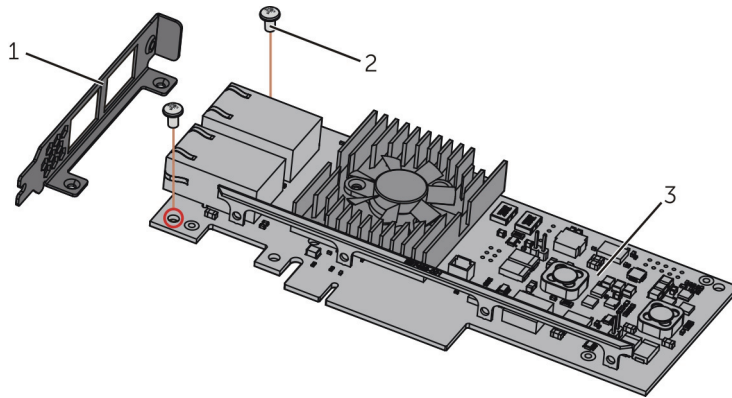

Figure 19. Attaching the bracket to the X540 card

- | | | | |
|---|-----------|---|-----------|
| 1 | bracket | 2 | screw (2) |
| 3 | X540 card | | |

2. Insert the card into the riser card until the card is fully seated.
3. Secure the card with the screw.
4. For the dedicated management port card, insert the card into the board-to-board connector on the system board, and secure the card to the server sled with two screws.

Next steps

1. Install the expansion-card riser module on the system board.
2. Complete the procedure listed in [After working inside your system](#).

Related Links

- [Removing the expansion-card riser module](#)
- [Installing the expansion-card riser module](#)
- [Removing the server sled](#)
- [Installing the server sled](#)

Installing the supercapacitor

Prerequisites

⚠ CAUTION: Many repairs may only be done by a certified service technician. You should only perform troubleshooting and simple repairs as authorized in your product documentation, or as directed by the online or telephone service and support team. Damage due to servicing that is not authorized by Dell is not covered by your warranty. Read and follow the safety instructions that came with the product.

1. Ensure that you read the [Safety instructions](#).
2. Complete the procedure listed in [Before working inside your system](#).
3. Remove the expansion-card riser module.
4. Remove the expansion card.

Steps

Depending on the type of the supercapacitor, follow the illustrations below to install the supercapacitor.

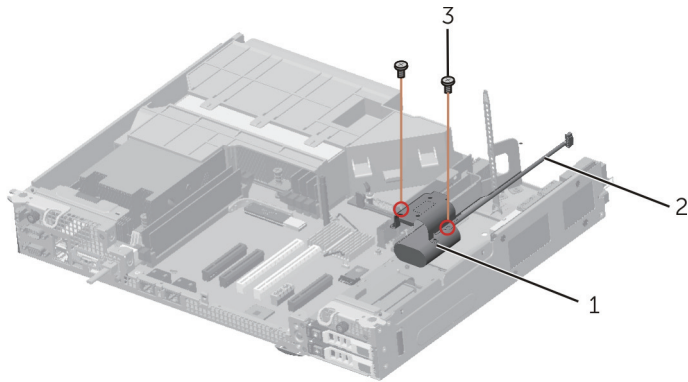

- | | | | |
|---|-------------------------------|---|----------------|
| 1 | Adaptec AFM700 supercapacitor | 2 | extender cable |
| 3 | screw (2) | | |

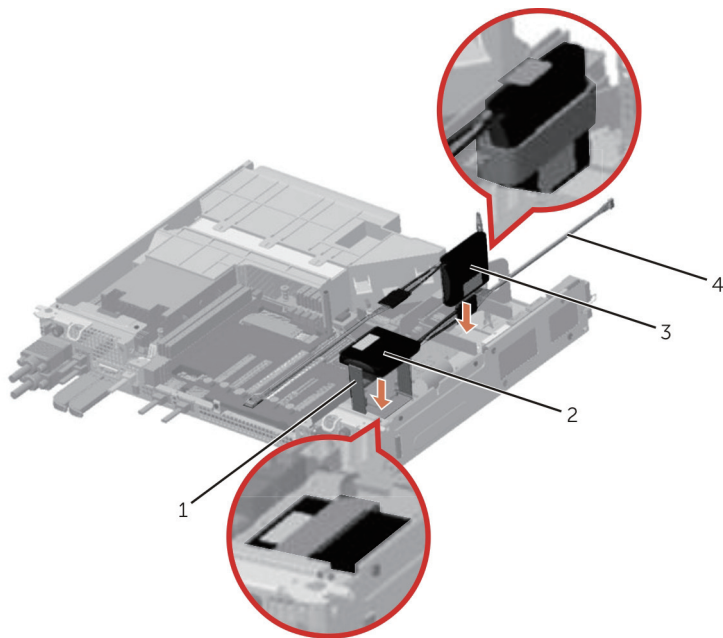

- | | | | |
|---|-------------------------------|---|-------------------------------|
| 1 | fastener (2) | 2 | LSI 49571-15 supercapacitor 1 |
| 3 | LSI 49571-15 supercapacitor 2 | 4 | extender cable (2) |

Next steps

1. Install the expansion card to the expansion-card riser module.
2. Install the expansion-card riser module on the system board.
3. Complete the procedure listed in [After working inside your system](#).

Related Links

- [Removing the expansion-card riser module](#)
- [Installing the expansion-card riser module](#)
- [Removing an expansion card](#)
- [Installing an expansion card](#)
- [Removing the server sled](#)
- [Installing the server sled](#)

Removing a riser card

Prerequisites

⚠ CAUTION: Many repairs may only be done by a certified service technician. You should only perform troubleshooting and simple repairs as authorized in your product documentation, or as directed by the online or telephone service and support team. Damage due to servicing that is not authorized by Dell is not covered by your warranty. Read and follow the safety instructions that came with the product.

1. Ensure that you read the [Safety instructions](#).
2. Complete the procedure listed in [Before working inside your system](#).
3. Remove the expansion-card riser module.
4. Remove the expansion cards.

Steps

Remove the screws securing the riser card and lift the card away from the riser module.

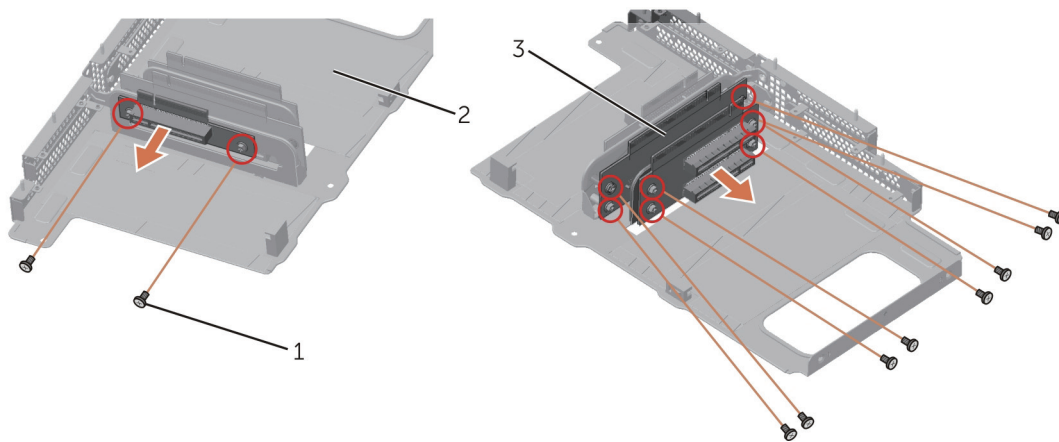

Figure 20. Removing and installing the riser card from expansion-card riser module

- 1 screw (10)
- 2 expansion-card riser module
- 3 riser card

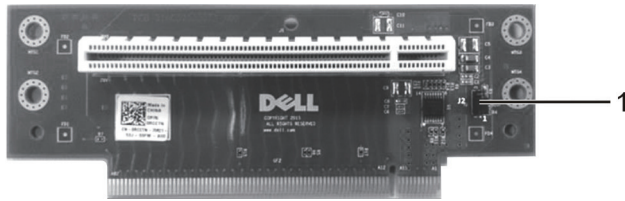

Figure 21. Jumper on the riser card

- 1 Jumper J2 (reserved)

Next steps

Complete the procedure listed in [After working inside your system](#).

Related Links

- [Removing the expansion-card riser module](#)
- [Installing the expansion-card riser module](#)
- [Removing an expansion card](#)

Installing a riser card

 NOTE: Only supported cards from Dell can be installed in the system.

Prerequisites

 CAUTION: Many repairs may only be done by a certified service technician. You should only perform troubleshooting and simple repairs as authorized in your product documentation, or as directed by the online or telephone service and support team. Damage due to servicing that is not authorized by Dell is not covered by your warranty. Read and follow the safety instructions that came with the product.

1. Ensure that you read the [Safety instructions](#).
2. Complete the procedure listed in [Before working inside your system](#).
3. Remove the expansion-card riser module.

Steps

1. Insert the riser card into the expansion-card riser module until the card is fully seated.
2. Secure the card with the screws.

Next steps

1. Install the expansion cards.
2. Install the expansion-card riser module on the system board.
3. Complete the procedure listed in [After working inside your system](#).

Related Links

- [Removing the expansion-card riser module](#)
- [Installing the expansion-card riser module](#)
- [Removing an expansion card](#)
- [Installing an expansion card](#)
- [Removing the server sled](#)
- [Installing the server sled](#)

Cooling shroud

Removing the cooling shroud

Prerequisites

⚠ CAUTION: Many repairs may only be done by a certified service technician. You should only perform troubleshooting and simple repairs as authorized in your product documentation, or as directed by the online or telephone service and support team. Damage due to servicing that is not authorized by Dell is not covered by your warranty. Read and follow the safety instructions that came with the product.

1. Ensure that you read the [Safety instructions](#).
2. Complete the procedure listed in [Before working inside your system](#).
3. Remove the expansion-card riser module.
4. Remove the CPU2 power cable.

⚠ CAUTION: Never operate your system with the cooling shroud removed. The system may get overheated quickly, resulting in shutdown of the system and loss of data.

Steps

Remove the three screws and lift the shroud away from the system board.

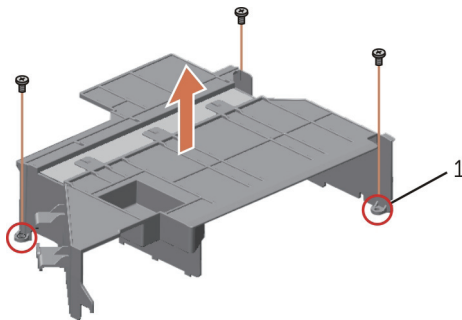

Figure 22. Removing and installing the cooling shroud

- 1 screw (3)

Related Links

- [Removing the expansion-card riser module](#)
- [Removing the server sled](#)

Installing the cooling shroud

Prerequisites

 **CAUTION:** Many repairs may only be done by a certified service technician. You should only perform troubleshooting and simple repairs as authorized in your product documentation, or as directed by the online or telephone service and support team. Damage due to servicing that is not authorized by Dell is not covered by your warranty. Read and follow the safety instructions that came with the product.

1. Ensure that you read the [Safety instructions](#).
2. Complete the procedure listed in [Before working inside your system](#).

Steps

Place the shroud in place on the system board and secure the three screws.

Next steps

1. Connect the CPU2 power cable.
2. Install the expansion-card riser module.
3. Complete the procedure listed in [After working inside your system](#).

Related Links

[Removing the expansion-card riser module](#)

[Installing the expansion-card riser module](#)

[Removing the server sled](#)

[Installing the server sled](#)

System memory

Your system supports DDR4 registered DIMMs (RDIMMs).

 **NOTE:** MT/s indicates DIMM speed in MegaTransfers per second.

Memory bus operating frequency can be 2400 MT/s, 2133 MT/s, 1866 MT/s, 1600 MT/s, or 1333 MT/s depending on the following factors:

- System profile selected (for example, Performance Optimized, Custom, or Dense Configuration Optimized)
- Maximum supported DIMM frequency of the processors

The system contains 12 memory sockets split into four sets — two sets of 4 sockets and two sets of 2 sockets each. Each 4-socket set is organized into two channels and each 2-socket set is organized into one channel. In each channel of the 4-socket set, the release levers of the first socket are marked white and the second socket black. In the 2-socket set, each release lever is marked white.

 **NOTE:** DIMMs in sockets A1 – A8 are assigned to processor 1 and DIMMs in sockets B1 – B4 are assigned to processor 2.

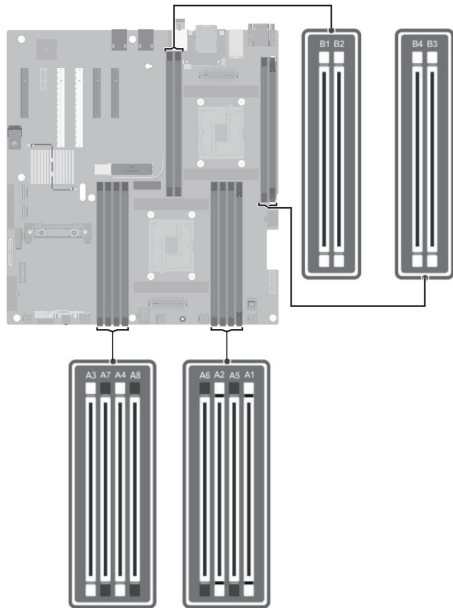

Memory channels are organized as follows:

- Processor 1
 - channel 0: memory sockets A1 and A5
 - channel 1: memory sockets A2 and A6
 - channel 2: memory sockets A3 and A7
 - channel 3: memory sockets A4 and A8

- Processor 2
 - channel 0: memory sockets B1
 - channel 1: memory sockets B2
 - channel 2: memory sockets B3
 - channel 3: memory sockets B4

The following table shows the memory populations and operating frequencies for the supported configurations.

DIMM Type	DIMMs Populated/ Channel	Operating Frequency (in MT/s)	Maximum DIMM Rank/Channel
1.2 V			
RDIMM	1	2400, 2133, 1866, 1600, 1333	Dual rank or single rank
	2	2400, 2133, 1866, 1600, 1333	Dual rank or single rank

General memory module installation guidelines

Your system supports Flexible Memory Configuration, enabling the system to be configured and run in any valid chipset architectural configuration. The following are the recommended guidelines for installing memory modules:

- x4 and x8 DRAM based DIMMs can be mixed. For more information, see [Mode-specific guidelines](#).
- Up to two dual- or single-rank RDIMMs can be populated per channel.
- Populate DIMM sockets only if a processor is installed. For single-processor systems, sockets A1 – A8 are available. For dual-processor systems, sockets A1 – A8 and sockets B1 – B4 are available.
- Populate all sockets with white release levers first, and then all the sockets with black release levers.
- When mixing memory modules with different capacities, populate the sockets with memory modules with highest capacity first. For example, if you want to mix 16 GB and 32 GB DIMMs, populate 32 GB DIMMs in the sockets with white release levers and 16 GB DIMMs in the sockets with black release levers.
- In a dual-processor configuration, the memory configuration for each processor should be identical through the first eight slots. For example, if you populate socket A1 for processor 1, then populate socket B1 for processor 2, and so on.
- Memory modules of different capacities can be mixed provided other memory population rules are followed (for example, 16 GB and 32 GB memory modules can be mixed).
- Mixing of more than two DIMM capacities in a system is not supported.
- Populate two DIMMs per processor (one DIMM per channel) at a time to maximize performance.

Mode-specific guidelines

Four memory channels are allocated to each processor. The allowable configurations depend on the memory mode selected.

 NOTE: You can mix x4 and x8 DRAM based DIMMs to support RAS features. However, all guidelines for specific RAS features must be followed. x4 DRAM based DIMMs retain Single Device Data Correction (SDDC) in memory optimized (independent channel) mode. x8 DRAM based DIMMs require Advanced ECC mode to gain SDDC.

The following sections provide additional slot population guidelines for each mode:

Advanced ECC (lockstep)

Advanced ECC mode extends SDDC from x4 DRAM based DIMMs to both x4 and x8 DRAMs. This protects against single DRAM chip failures during normal operation.

Memory installation guidelines:

- Memory modules must be identical in size, speed, and technology.
- DIMMs installed in memory sockets with white release levers must be identical and similar rule applies for sockets with black release levers. This ensures that identical DIMMs are installed in matched pairs - for example, A1 with A2, A3 with A4, A5 with A6.

 NOTE: Advanced ECC with Mirroring is not supported.

Memory optimized (independent channel) mode

This mode supports SDDC only for memory modules that use x4 device width, and the mode does not impose any specific slot population requirements.

Memory sparing

 NOTE: To use memory sparing, this feature must be enabled in the System Setup.

In this mode, one rank per channel is reserved as a spare. If persistent correctable errors are detected on a rank, the data from this rank is copied to the spare rank and the failed rank is disabled.

With memory sparing enabled, the system memory available to the operating system is reduced by one rank per channel. For example, in a dual-processor configuration with sixteen 4 GB dual-rank DIMMs, the available system memory is: 3/4 (ranks/channel) × 16 (DIMMs) × 4 GB = 48 GB, and not 16 (DIMMs) × 4 GB = 64 GB.

 NOTE: Memory sparing does not offer protection against a multi-bit uncorrectable error.

 NOTE: Both Advanced ECC/Lockstep and Optimizer modes support Memory Sparing.

Sample memory configurations

The following tables list sample memory configurations for one and two processor configurations that follow the appropriate memory guidelines.

 NOTE: 1R and 2R in the following tables indicate single- and dual-rank DIMMs respectively.

Table 4. Memory configurations—single processor

System Capacity (in GB)	DIMM Size (in GB)	Number of DIMMs	DIMM Rank, Organization, and Frequency	DIMM Slot Population
64	16	4	2R, x8, 2400 MT/s, 2R, x8, 2133 MT/s, 2R, x8, 1866 MT/s	A1, A2, A3, A4
128	32	4	2R, x8, 2400 MT/s, 2R, x8, 2133 MT/s, 2R, x8, 1866 MT/s	A1, A2, A3, A4
128	16	8	2R, x8, 2400 MT/s, 2R, x8, 2133 MT/s, 2R, x8, 1866 MT/s	A1, A2, A3, A4, A5, A6, A7, A8
256	32	8	2R, x8, 2400 MT/s, 2R, x8, 2133 MT/s, 2R, x8, 1866 MT/s	A1, A2, A3, A4, A5, A6, A7, A8

Table 5. Memory configurations—two processors

System Capacity (in GB)	DIMM Size (in GB)	Number of DIMMs	DIMM Rank, Organization, and Frequency	DIMM Slot Population
64	16	4	2R, x8, 2400 MT/s, 2R, x8, 2133 MT/s, 2R, x8, 1866 MT/s	A1, A2, B1, B2

System Capacity (in GB)	DIMM Size (in GB)	Number of DIMMs	DIMM Rank, Organization, and Frequency	DIMM Slot Population
128	32	4	2R, x8, 2400 MT/s, 2R, x8, 2133 MT/s, 2R, x8, 1866 MT/s	A1, A2, B1, B2
128	16	8	2R, x8, 2400 MT/s, 2R, x8, 2133 MT/s, 2R, x8, 1866 MT/s	A1, A2, A3, A4, B1, B2, B3, B4
192	16	12	2R, x8, 2400 MT/s, 2R, x8, 2133 MT/s, 2R, x8, 1866 MT/s	A1, A2, A3, A4, A5, A6, A7, A8, B1, B2, B3, B4
256	32	8	2R, x8, 2400 MT/s, 2R, x8, 2133 MT/s, 2R, x8, 1866 MT/s	A1, A2, A3, A4, B1, B2, B3, B4
384	32	12	2R, x8, 2400 MT/s, 2R, x8, 2133 MT/s, 2R, x8, 1866 MT/s	A1, A2, A3, A4, A5, A6, A7, A8, B1, B2, B3, B4

Removing a memory module

Prerequisites

 **CAUTION:** Many repairs may only be done by a certified service technician. You should only perform troubleshooting and simple repairs as authorized in your product documentation, or as directed by the online or telephone service and support team. Damage due to servicing that is not authorized by Dell is not covered by your warranty. Read and follow the safety instructions that came with the product.

1. Ensure that you read the [Safety instructions](#).
2. Complete the procedure listed in [Before working inside your system](#).
3. Remove the server sled.
4. Remove the cooling shroud.

 **WARNING:** The memory modules are hot to the touch for some time after the system has been powered down. Allow time for the memory modules to cool before handling them. Handle the memory modules by the card edges and avoid touching the components or metallic contacts on the memory module.

 **CAUTION:** To ensure proper system cooling, memory module blanks must be installed in any memory socket that is not occupied. Remove memory module blanks only if you intend to install memory modules in those sockets.

Steps

1. Locate the appropriate memory module socket.

CAUTION: Handle each memory module only by the card edges, making sure not to touch the middle of the memory module or metallic contacts.

2. To release the memory module from the socket, simultaneously press the ejectors on both ends of the memory module socket.

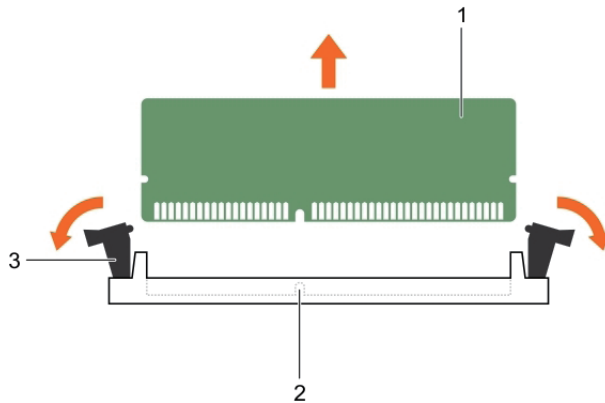

Figure 23. Removing a memory module

- | | | | |
|---|---------------------------|---|----------------------|
| 1 | memory module | 2 | memory module socket |
| 3 | memory module ejector (2) | | |

Related Links

[Removing the server sled](#)

[Removing the cooling shroud](#)

Installing a memory module

Prerequisites

CAUTION: Many repairs may only be done by a certified service technician. You should only perform troubleshooting and simple repairs as authorized in your product documentation, or as directed by the online or telephone service and support team. Damage due to servicing that is not authorized by Dell is not covered by your warranty. Read and follow the safety instructions that came with the product.

1. Ensure that you read the [Safety instructions](#).
2. Complete the procedure listed in [Before working inside your system](#).
3. Remove the server sled.
4. Remove the cooling shroud.

WARNING: The memory modules are hot to the touch for some time after the system has been powered down. Allow time for the memory modules to cool before handling them. Handle the memory modules by the card edges and avoid touching the components or metallic contacts on the memory module.

Steps

1. Locate the appropriate memory module socket.

△ CAUTION: Handle each memory module only by the card edges, making sure not to touch the middle of the memory module or metallic contacts.

2. If a memory module or a memory module blank is installed in the socket, remove it.

✎ NOTE: Retain the removed memory module blanks for future use.

△ CAUTION: To prevent damage to the memory module or the memory module socket during installation, do not bend or flex the memory module; insert both ends of the memory module simultaneously.

3. Align the edge connector of the memory module with the alignment key of the memory module socket, and insert the memory module in the socket.

✎ NOTE: The memory module socket has an alignment key that allows you to install the memory module in the socket in only one orientation.

△ CAUTION: Do not apply pressure at the center of the memory module; apply pressure at both ends of the memory module evenly.

4. Press the memory module with your thumbs until the socket levers firmly click into place.

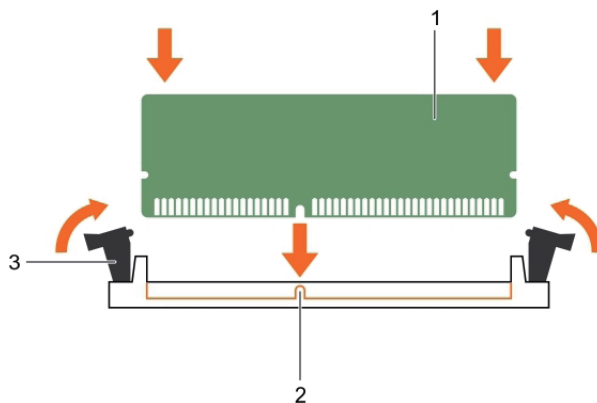

Figure 24. Installing the memory module

- | | | | |
|---|----------------------------------|---|---------------|
| 1 | memory module | 2 | alignment key |
| 3 | memory module socket ejector (2) | | |

When the memory module is properly seated in the socket, the levers on the memory module socket align with the levers on the other sockets that have memory modules installed.

5. Repeat steps 3 and 4 of this procedure to install the remaining memory modules.

Next steps

1. Install the cooling shroud.
2. Install the server sled.

3. Complete the procedure listed in [After working inside your system](#).
4. Press **F2** to start System Setup, and check the **System Memory** setting.
The **System Memory** value should reflect the newly installed memory.
5. If the value is incorrect, one or more of the memory modules may not be installed properly. Repeat step 3 and step 4 of this procedure, checking to ensure that the memory modules are firmly seated in their sockets.
6. Run the system memory test in the system diagnostics.

Related Links

[Removing the cooling shroud](#)

[Installing the cooling shroud](#)

[Removing the server sled](#)

[Installing the server sled](#)

Heat sinks and processors

Use the following procedure when:

- Installing an additional processor
- Replacing a processor

Removing a processor

Prerequisites



WARNING: The heat sink and processor are hot to the touch for some time after the system has been powered down. Allow the heat sink and processor to cool before handling them.



CAUTION: Many repairs may only be done by a certified service technician. You should only perform troubleshooting and simple repairs as authorized in your product documentation, or as directed by the online or telephone service and support team. Damage due to servicing that is not authorized by Dell is not covered by your warranty. Read and follow the safety instructions that came with the product.



CAUTION: Never remove the heat sink from a processor unless you intend to remove the processor. The heat sink is necessary to maintain proper thermal conditions.

1. Ensure that you read the [Safety instructions](#).
2. Keep the #2 Phillips screwdriver handy.
3. Before upgrading your system, download the latest system BIOS version from [dell.com/support](#) and follow the instructions included in the compressed download file to install the update on your system.



NOTE: You can update the system BIOS using the Lifecycle Controller. For more information about Dell Lifecycle controller, see [dell.com/idracmanuals](#).

4. Complete the procedure listed in [Before working inside your system](#).
5. Remove the server sled.
6. Remove the cooling shroud.

Steps

1. Loosen one of the screws that secures the heat sink to the system board.

Wait 30 seconds for the heat sink to loosen from the processor.

2. Remove the screw diagonally opposite the screw you first removed.
3. Repeat the procedure for the remaining two screws.
4. Remove the heat sink.

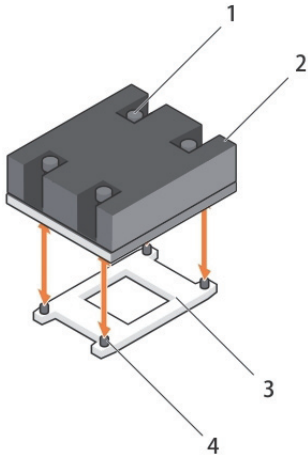

Figure 25. Removing and installing a processor heat sink

- | | | | |
|---|-------------------|---|-----------|
| 1 | captive screw (4) | 2 | heat sink |
| 3 | processor socket | 4 | slot (4) |

⚠ CAUTION: The processor is held in its socket under strong pressure. Be aware that the release lever can spring up suddenly if not firmly grasped.

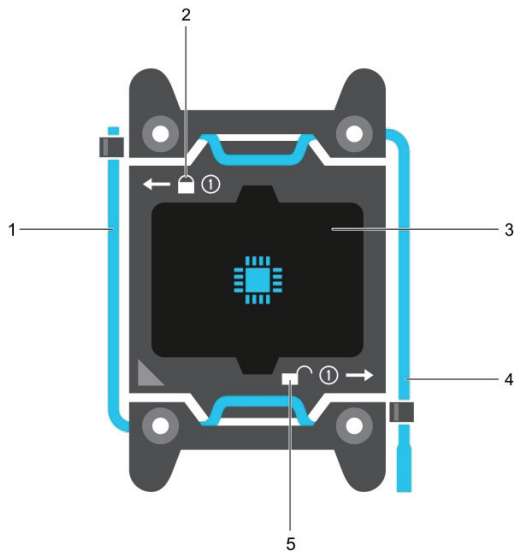



Figure 26. Processor shield opening and closing lever sequence

- | | | | |
|---|----------------------------------|---|---------------------------------|
| 1 | close first socket release lever | 2 | lock icon |
| 3 | processor | 4 | open first socket release lever |
| 5 | unlock icon | | |
- Position your thumb firmly over the processor open first socket-release lever near the unlock icon  and release the lever from the locked position by pushing down and out from under the tab.
 - Similarly, position your thumb firmly over the processor close first socket-release lever near the lock icon  and release the lever from the locked position by pushing down and out from under the tab. Rotate the lever 90 degrees upward.
 - Lower the open first socket-release lever to lift the processor shield.

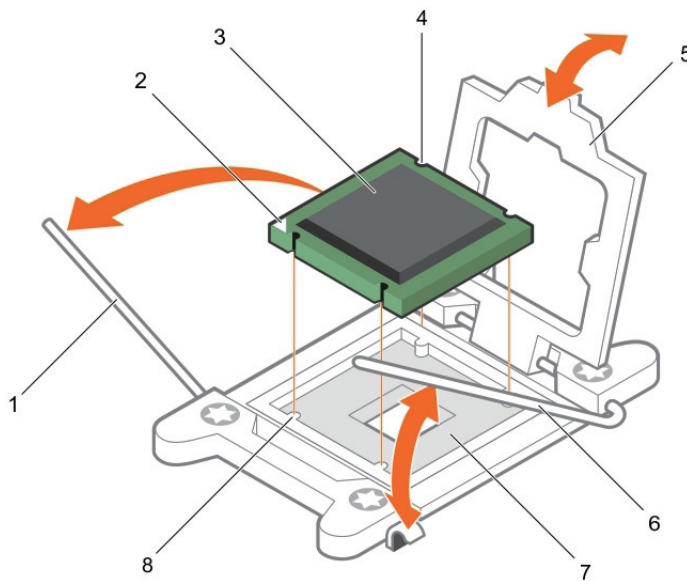





Figure 27. Removing and installing a processor

- | | | | |
|---|----------------------------------|---|---------------------------------|
| 1 | close first socket-release lever | 2 | pin-1 indicator of processor |
| 3 | processor | 4 | slot (4) |
| 5 | processor shield | 6 | open first socket-release lever |
| 7 | socket | 8 | socket keys (4) |
- Hold the tab on the processor shield and rotate the processor shield upward until the open first socket-release lever lifts up.
 - Lift the processor out of the socket and leave the open first socket-release lever up so that the socket is ready for the new processor.

 **CAUTION: The socket pins are fragile and can be permanently damaged. Be careful not to bend the pins in the socket when removing the processor out of the socket.**

 NOTE: If you are permanently removing the processor, you must install a socket protective cap in the vacant socket to protect the socket pins and keep the socket free of dust.

 NOTE: After removing the processor, place it in an antistatic container for reuse, return, or temporary storage. Do not touch the bottom of the processor. Touch only the side edges of the processor.

Related Links

[Removing the cooling shroud](#)

[Installing the cooling shroud](#)

[Removing the server sled](#)

Installing a processor

Prerequisites

1. Ensure that you read the [Safety instructions](#).
2. Keep the #2 Phillips screwdriver handy.
3. Before upgrading your system, download the latest system BIOS version from dell.com/support and follow the instructions included in the compressed download file to install the update on your system.

 NOTE: You can update the system BIOS using the Lifecycle Controller.

4. Complete the procedure listed in [Before working inside your system](#).
5. Remove the server sled.
6. Remove the cooling shroud.

 **WARNING: The heat sink and processor are hot to the touch for some time after the system has been powered down. Allow the heat sink and processor to cool before handling them.**

 **CAUTION: Never remove the heat sink from a processor unless you intend to remove the processor. The heat sink is necessary to maintain proper thermal conditions.**

 **CAUTION: Many repairs may only be done by a certified service technician. You should only perform troubleshooting and simple repairs as authorized in your product documentation, or as directed by the online or telephone service and support team. Damage due to servicing that is not authorized by Dell is not covered by your warranty. Read and follow the safety instructions that came with the product.**



 NOTE: If you are installing a single processor, it must be installed in socket CPU1.

Steps

1. Remove the heat sink.
2. Unpack the new processor

If the processor has previously been used in a system, remove any remaining thermal grease from the processor using a lint-free cloth.

3. Locate the processor socket.
4. If applicable, remove the socket protective cap.

5. Position your thumb firmly over the open first socket-release lever near the unlock icon  and release the lever from the locked position by pushing down and in from under the tab.
6. Similarly, release the close first socket-release lever near the lock icon  from the locked position. Rotate the lever 90 degrees upward.
7. Hold the tab near the lock symbol on the processor shield and rotate it upward and out of the way.
8. To install the processor in the socket:

 **CAUTION: Positioning the processor incorrectly can permanently damage the system board or the processor. Be careful not to bend the pins in the socket.**

 **CAUTION: While removing or reinstalling the processor, wipe your hands of any contaminants. Contaminants on the processor pins such as thermal grease or oil can damage the processor.**

- a. Align the processor with the socket keys on the socket.

 **CAUTION: Do not use force to seat the processor. When the processor is positioned correctly, it engages easily into the socket.**

- b. Align the pin-1 indicator of the processor with the triangle on the socket.
- c. Place the processor on the socket such that the slots on the processor aligns with the socket keys on the socket.

 **CAUTION: Do not use force to seat the processor. When the processor is positioned correctly, it engages easily into the socket.**

- d. Close the processor shield.

- e. Rotate the close first socket-release lever near the lock icon  until it is locked in position.

- f. Similarly, rotate the open first socket-release lever near the unlock icon  to the unlocked position.

9. To install the heat sink:

- a. If applicable, remove the existing thermal grease from the heat sink using a clean lint-free cloth.
- b. Apply thermal grease on the top of the processor. Use the thermal grease syringe included with your processor kit to apply the grease in a thin spiral on the top of the processor as shown in the figure.

 **CAUTION: Applying too much thermal grease can result in excess grease coming in contact with and contaminating the processor socket.**

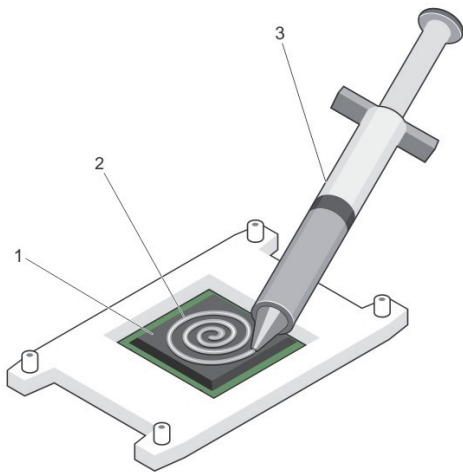



Figure 28. Applying thermal grease on the top of the processor

- | | | | |
|---|------------------------|---|----------------|
| 1 | processor | 2 | thermal grease |
| 3 | thermal grease syringe | | |

 NOTE: The thermal grease is intended for one-time use only. Dispose of the syringe after you use it.

- c. Place the heat sink onto the processor.
- d. Tighten the four screws to secure the heat sink to the system board.

 NOTE: Tighten the screws diagonally opposite to each other. Do not over-tighten the heat sink retention screws when installing the heat sink. To prevent over-tightening, tighten the retention screw until resistance is felt, and stop once the screw is seated. The screw tension should be no more than 6 in-lb (6.9 kg-cm).

Next steps

1. Install the cooling shroud.
2. Install the server sled.
3. Complete the procedure listed in [After working inside your system](#).
4. While booting, press **F2** to start the System Setup and check that the processor information matches the new system configuration.
5. Run the system diagnostics to verify that the new processor operates correctly.

Related Links

- [Removing the cooling shroud](#)
- [Installing the cooling shroud](#)
- [Removing the server sled](#)
- [Installing the server sled](#)

Hard disk drives

Your system supports the following:

System	Configuration
Single-node systems with one server sled	Up to 90 3.5-inch hot-swappable Serial Attached SCSI (SAS) HDDs, SATA HDDs, or SATA SSDs, or Up to 16 hot-swappable SAS SSDs Up to two 2.5-inch hot-swappable boot SATA SSDs
Dual-node systems with two server sleds	Up to 90 3.5-inch hot-swappable Serial Attached SCSI (SAS) HDDs, SATA HDDs, or SATA SSDs, or Up to 12 hot-swappable SAS SSDs Up to four 2.5-inch hot-swappable boot SATA SSDs

 NOTE: SSD/SAS/SATA HDDs can be mixed in a system.

The hot-swappable HDDs connect to the system board through the HDD backplane. Hot-swappable HDDs are supplied in hot-swappable HDD carriers that fit in the HDD slots.

 **CAUTION: Before attempting to remove or install a hot-swappable HDD while the system is running, see the documentation for the storage controller card to ensure that the host adapter is configured correctly to support hot-swap HDD removal and insertion.**

 **CAUTION: Do not turn off or reboot your system while the HDD is being formatted. Doing so can cause an HDD failure.**

 NOTE: Use only HDDs that have been tested and approved for use with the HDD backplane.

When you format an HDD, allow enough time for the formatting to be completed. Be aware that high-capacity HDDs can take a number of hours to format.

Removing a 3.5-inch HDD blank

Prerequisites

Remove the system cover.

 **CAUTION: Many repairs may only be done by a certified service technician. You should only perform troubleshooting and simple repairs as authorized in your product documentation, or as directed by the online or telephone service and support team. Damage due to servicing that is not authorized by Dell is not covered by your warranty. Read and follow the safety instructions that came with the product.**

 **CAUTION: To maintain proper system cooling, all empty HDD slots must have drive blanks installed.**

Ensure that you read the [Safety instructions](#).

Steps

Press the release button and slide the blank out of the HDD slot.

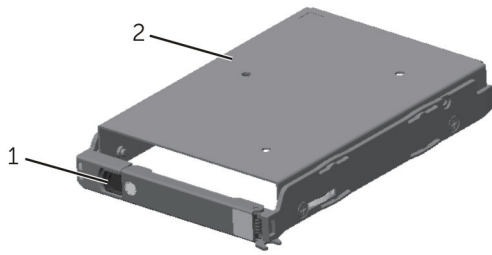

Figure 29. Removing and installing a 3.5-inch HDD blank

1 release button

2 HDD blank

Related Links

[Removing the system cover](#)

Installing a 3.5-inch HDD blank

Prerequisites

△ CAUTION: Many repairs may only be done by a certified service technician. You should only perform troubleshooting and simple repairs as authorized in your product documentation, or as directed by the online or telephone service and support team. Damage due to servicing that is not authorized by Dell is not covered by your warranty. Read and follow the safety instructions that came with the product.

Ensure that you read the [Safety instructions](#).

Steps

Insert the HDD blank into the HDD slot until the release button clicks into place.

Next steps

Install the system cover.

Related Links

[Removing the system cover](#)

[Installing the system cover](#)

Removing a 3.5-inch hot-swap HDD

Prerequisites

△ CAUTION: Many repairs may only be done by a certified service technician. You should only perform troubleshooting and simple repairs as authorized in your product documentation, or as directed by the online or telephone service and support team. Damage due to servicing that is not authorized by Dell is not covered by your warranty. Read and follow the safety instructions that came with the product.

1. Ensure that you read the [Safety instructions](#).
2. Using the management software, prepare the HDD for removal. For more information about the management software, see the documentation for the storage controller.

If the HDD is online, the green activity/fault indicator flashes as the drive is turned off. You can remove the HDD when the HDD indicators turn off. Remove the system cover.

3. Remove the system cover.

CAUTION: To prevent data loss, ensure that your operating system supports hot-swap drive installation. See the documentation supplied with your operating system.

Steps

1. Press the release button to open the HDD carrier release handle.
2. Slide the HDD carrier out of the HDD slot.

CAUTION: To maintain proper system cooling, all empty HDD slots must have HDD blanks installed.

3. If you are not replacing the HDD immediately, insert an HDD blank in the empty HDD slot.

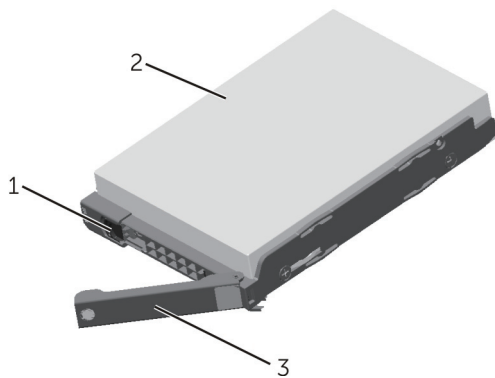

Figure 30. Removing and installing a 3.5-inch hot-swap HDD

- | | | | |
|---|--------------------|---|--------------|
| 1 | release button | 2 | 3.5-inch HDD |
| 3 | HDD carrier handle | | |

Related Links

[Removing the system cover](#)

Installing a 3.5-inch hot-swap HDD

Prerequisites

CAUTION: Many repairs may only be done by a certified service technician. You should only perform troubleshooting and simple repairs as authorized in your product documentation, or as directed by the online or telephone service and support team. Damage due to servicing that is not authorized by Dell is not covered by your warranty. Read and follow the safety instructions that came with the product.

CAUTION: Use only HDDs that have been tested and approved for use with the HDD backplane.

CAUTION: Combining SAS and SATA HDDs in the same RAID volume is not supported.

△ CAUTION: When installing an HDD, ensure that the adjacent drives are fully installed. Inserting an HDD carrier and attempting to lock its handle next to a partially installed carrier can damage the partially installed carrier's shield spring and make it unusable.

△ CAUTION: To prevent data loss, ensure that your operating system supports hot-swap drive installation. See the documentation supplied with your operating system.

△ CAUTION: When a replacement hot-swappable HDD is installed and the system is powered on, the HDD automatically begins to rebuild. Make absolutely sure that the replacement HDD is blank or contains data that you wish to have over-written. Any data on the replacement HDD is immediately lost after the HDD is installed.

Steps

1. If an HDD blank is installed in the HDD slot, remove it.
2. Install an HDD in the HDD carrier.
3. Press the release button on the front of the HDD carrier and open the HDD carrier handle.
4. Insert the HDD carrier into the HDD slot until the carrier comes in contact with the backplane.
5. Close the HDD carrier handle to lock the HDD in place.

Related Links

[Removing the system cover](#)

[Installing the system cover](#)

Removing a 3.5-inch HDD from an HDD carrier

Prerequisites

1. Keep the #2 Phillips screwdriver ready.
2. Remove the HDD carrier from the system.

Steps

1. Remove the screws from the slide rails on the HDD carrier.
2. Lift the HDD out of the HDD carrier.

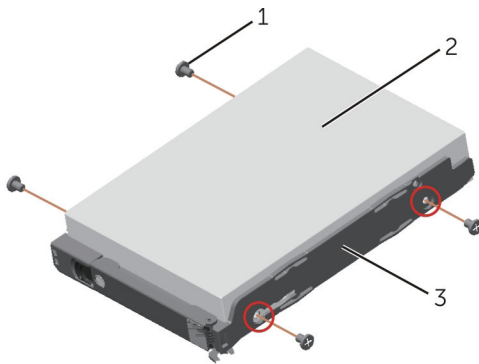



Figure 31. Removing and installing a 3.5-inch HDD into an HDD carrier

- 1 screw (4)
- 2 3.5-inch HDD
- 3 HDD carrier

Installing a 3.5-inch HDD into an HDD carrier

Prerequisites

 **CAUTION:** Many repairs may only be done by a certified service technician. You should only perform troubleshooting and simple repairs as authorized in your product documentation, or as directed by the online or telephone service and support team. Damage due to servicing that is not authorized by Dell is not covered by your warranty. Read and follow the safety instructions that came with the product.

Steps

1. Insert the HDD into the HDD carrier with the connector end of the HDD toward the back.
2. Align the screw holes on the HDD with the set of screw holes on the HDD carrier.
When aligned correctly, the back of the HDD is flush with the back of the HDD carrier.
3. Attach the screws to secure the HDD to the HDD carrier.

Removing a 2.5-inch hot-swap HDD

Prerequisites

 **CAUTION:** Many repairs may only be done by a certified service technician. You should only perform troubleshooting and simple repairs as authorized in your product documentation, or as directed by the online or telephone service and support team. Damage due to servicing that is not authorized by Dell is not covered by your warranty. Read and follow the safety instructions that came with the product.

1. Ensure that you read the [Safety instructions](#).
2. Using the management software, prepare the HDD for removal. For more information, see the documentation for the storage controller.
If the HDD is online, the green activity/fault indicator flashes as the drive is turned off. You can remove the HDD when the HDD indicators turn off. Remove the system cover.
3. Remove the system cover.

 **CAUTION:** To prevent data loss, ensure that your operating system supports hot-swap drive installation. See the documentation supplied with your operating system.

Steps

1. Press the release button to open the HDD carrier release handle.
2. Slide the HDD carrier out of the HDD slot.
 **CAUTION:** To maintain proper system cooling, all empty HDD slots must have HDD blanks installed.
3. If you are not replacing the HDD immediately, insert an HDD blank in the empty HDD slot.

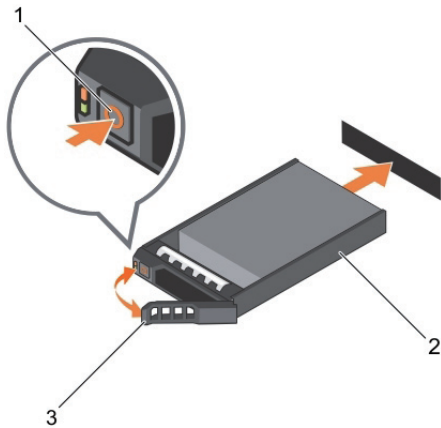

Figure 32. Removing and installing a 2.5-inch hot-swap HDD

- | | | | |
|---|--------------------|---|-------------|
| 1 | release button | 2 | HDD carrier |
| 3 | HDD carrier handle | | |

Related Links

[Removing the system cover](#)

Installing a 2.5-inch hot-swap HDD

Prerequisites

- △ **CAUTION:** Many repairs may only be done by a certified service technician. You should only perform troubleshooting and simple repairs as authorized in your product documentation, or as directed by the online or telephone service and support team. Damage due to servicing that is not authorized by Dell is not covered by your warranty. Read and follow the safety instructions that came with the product.
- △ **CAUTION:** Use only HDDs that have been tested and approved for use with the HDD backplane.
- △ **CAUTION:** Combining SAS and SATA HDDs in the same RAID volume is not supported.
- △ **CAUTION:** When installing an HDD, ensure that the adjacent drives are fully installed. Inserting an HDD carrier and attempting to lock its handle next to a partially installed carrier can damage the partially installed carrier's shield spring and make it unusable.
- △ **CAUTION:** To prevent data loss, ensure that your operating system supports hot-swap drive installation. See the documentation supplied with your operating system.
- △ **CAUTION:** When a replacement hot-swappable HDD is installed and the system is powered on, the HDD automatically begins to rebuild. Make absolutely sure that the replacement HDD is blank or contains data that you wish to have over-written. Any data on the replacement HDD is immediately lost after the HDD is installed.

Steps

1. If an HDD blank is installed in the HDD slot, remove it.
2. Install an HDD in the HDD carrier.

3. Press the release button on the front of the HDD carrier and open the HDD carrier handle.
4. Insert the HDD carrier into the HDD slot until the carrier comes in contact with the backplane.
5. Close the HDD carrier handle to lock the HDD in place.

Related Links

[Removing the system cover](#)

[Installing the system cover](#)

Installing a 2.5-inch SSD into a 3.5-inch HDD adapter

Prerequisites

⚠ CAUTION: Many repairs may only be done by a certified service technician. You should only perform troubleshooting and simple repairs as authorized in your product documentation, or as directed by the online or telephone service and support team. Damage due to servicing that is not authorized by Dell is not covered by your warranty. Read and follow the safety instructions that came with the product.

1. Keep the #2 Phillips screwdriver ready.
2. Ensure that you read the [Safety instructions](#).

Steps

1. Align the screw holes on the 2.5-inch SSD with the screw holes on the 3.5-inch HDD adapter.
2. Install the screws to secure the HDD to the HDD adapter.

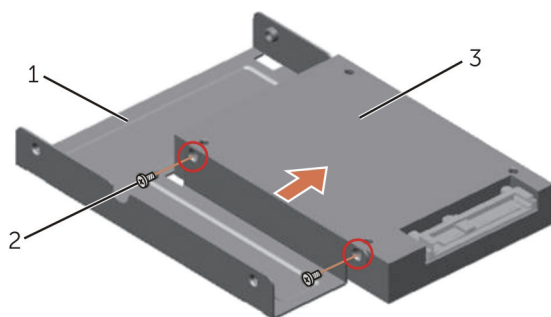

Figure 33. Removing and Installing a 2.5-inch SSD into a 3.5-inch HDD adapter

- | | | | |
|---|----------------------|---|-----------|
| 1 | 3.5-inch HDD adapter | 2 | screw (2) |
| 3 | 2.5-inch SSD | | |

Removing a 2.5-inch SSD from a 3.5-inch HDD adapter

Prerequisites

⚠ CAUTION: Many repairs may only be done by a certified service technician. You should only perform troubleshooting and simple repairs as authorized in your product documentation, or as directed by the online or telephone service and support team. Damage due to servicing that is not authorized by Dell is not covered by your warranty. Read and follow the safety instructions that came with the product.

1. Ensure that you read the [Safety instructions](#).

2. Keep the #2 Phillips screwdriver ready.

 NOTE: A 2.5-inch SSD is installed in a 3.5-inch HDD adapter, which is then installed in the 3.5-inch HDD carrier.

Steps

1. Remove the screws from the side of the 3.5-inch HDD adapter.
2. Remove the HDD from the HDD adapter.

Installing an HDD adapter into an HDD carrier

Prerequisites

 **CAUTION:** Many repairs may only be done by a certified service technician. You should only perform troubleshooting and simple repairs as authorized in your product documentation, or as directed by the online or telephone service and support team. Damage due to servicing that is not authorized by Dell is not covered by your warranty. Read and follow the safety instructions that came with the product.

1. Ensure that you read the [Safety instructions](#).
2. Keep the #2 Phillips screwdriver ready.

Steps

1. Insert the HDD adapter into the HDD carrier with the connector end of the HDD toward the back of the HDD carrier.
2. Align the screw holes on the HDD with the holes on the HDD carrier.
3. Install the screws to secure the HDD to the HDD carrier.

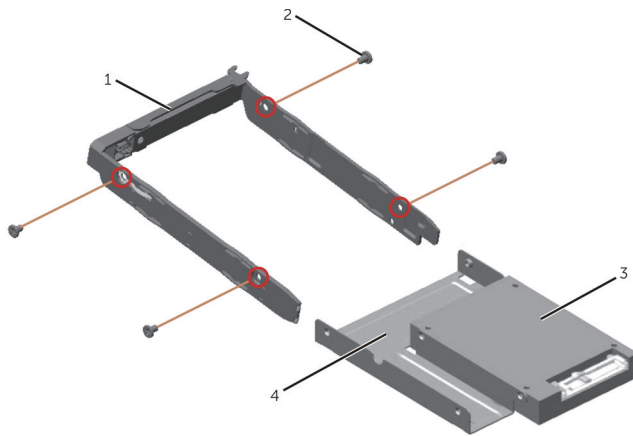

Figure 34. Removing and installing an HDD adapter into a 3.5-inch HDD carrier

- | | | | |
|---|----------------------|---|-------------|
| 1 | 3.5-inch HDD carrier | 2 | screw (4) |
| 3 | 2.5-inch SSD | 4 | HDD adapter |

Removing an HDD adapter from an HDD carrier

Prerequisites

1. Ensure that you read the [Safety instructions](#).
2. Keep the #2 Phillips screwdriver ready.

Steps

1. Remove the screws from the slide rails on the HDD carrier.
2. Lift the HDD adapter out of the HDD carrier.

Removing a 2.5-inch SSD from an HDD carrier

Prerequisites

1. Keep the #2 Phillips screwdriver ready.
2. Remove the HDD carrier from the system.

Steps

1. Remove the screws from the slide rails on the HDD carrier.
2. Lift the HDD out of the HDD carrier.

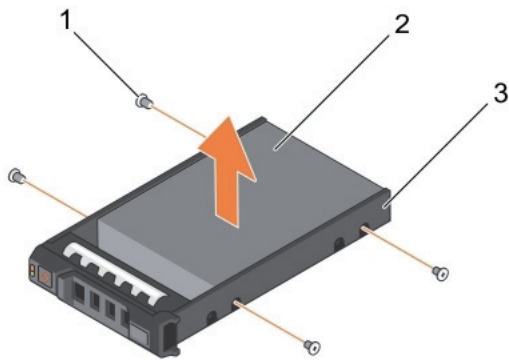

Figure 35. Removing and installing a 2.5-inch SSD into an HDD carrier

- | | | | |
|---|-------------|---|-----|
| 1 | screw (4) | 2 | SSD |
| 3 | HDD carrier | | |

Installing an HDD into an HDD carrier

Prerequisites

CAUTION: Many repairs may only be done by a certified service technician. You should only perform troubleshooting and simple repairs as authorized in your product documentation, or as directed by the online or telephone service and support team. Damage due to servicing that is not authorized by Dell is not covered by your warranty. Read and follow the safety instructions that came with the product.

Steps

1. Insert the HDD into the HDD carrier with the connector end of the HDD toward the back.
2. Align the screw holes on the HDD with the set of screw holes on the HDD carrier.
When aligned correctly, the back of the HDD is flush with the back of the HDD carrier.
3. Attach the screws to secure the HDD to the HDD carrier.

System fans

Your system supports up to six system fans in a redundant PSU configuration.

Removing a system fan

Prerequisites

⚠ CAUTION: Many repairs may only be done by a certified service technician. You should only perform troubleshooting and simple repairs as authorized in your product documentation, or as directed by the online or telephone service and support team. Damage due to servicing that is not authorized by Dell is not covered by your warranty. Read and follow the safety instructions that came with the product.

✍ NOTE: The procedure for removing each fan is identical.

⚠ CAUTION: The replacement service time for the system fans when the system is operating is two minutes.

1. Ensure that you read the [Safety instructions](#).
2. Complete the procedure listed in [Before working inside your system](#).
3. Remove the system cover.

Steps

1. Pull the two handles inward and lift the fan out of the system fan cage.
2. Lift the fan out of the system fan cage.

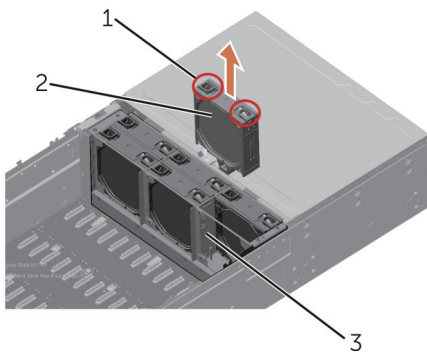

Figure 36. Removing and installing a system fan

- 1 handle (2)
- 2 system fan
- 3 fan cage

Related Links

[Removing the system cover](#)

Installing a system fan

Prerequisites

 **CAUTION:** Many repairs may only be done by a certified service technician. You should only perform troubleshooting and simple repairs as authorized in your product documentation, or as directed by the online or telephone service and support team. Damage due to servicing that is not authorized by Dell is not covered by your warranty. Read and follow the safety instructions that came with the product.

1. Ensure that you read the [Safety instructions](#).
2. Remove the system cover.

Steps

Lower the fan into the system fan bracket.

Next steps

1. Install the system cover.
2. Complete the procedure listed in [After working inside your system](#).

Related Links

[Removing the system cover](#)

[Installing the system cover](#)

Removing the fan cage

Prerequisites

 **CAUTION:** Many repairs may only be done by a certified service technician. You should only perform troubleshooting and simple repairs as authorized in your product documentation, or as directed by the online or telephone service and support team. Damage due to servicing that is not authorized by Dell is not covered by your warranty. Read and follow the safety instructions that came with the product.

1. Ensure that you read the [Safety instructions](#).
2. Complete the procedure listed in [Before working inside your system](#).
3. Turn off the system.
4. Remove the system cover.
5. Remove all system fans.

Steps

1. Remove the four screws from the fan cage.
2. Lift the fan cage out of the chassis.

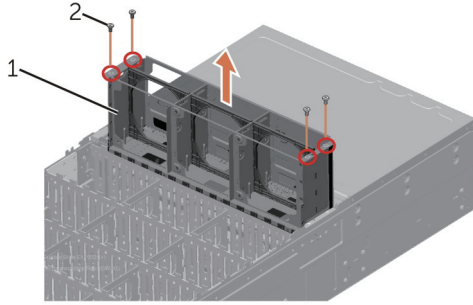

Figure 37. Removing and installing the fan cage

- | | | | |
|---|----------|---|-----------|
| 1 | fan cage | 2 | screw (4) |
|---|----------|---|-----------|

Related Links

[Removing the system cover](#)

[Removing a system fan](#)

Installing the fan cage

Prerequisites

⚠ CAUTION: Many repairs may only be done by a certified service technician. You should only perform troubleshooting and simple repairs as authorized in your product documentation, or as directed by the online or telephone service and support team. Damage due to servicing that is not authorized by Dell is not covered by your warranty. Read and follow the safety instructions that came with the product.

1. Ensure that you read the [Safety instructions](#).
2. Turn off the system.
3. Remove the system cover.

Steps

1. Lower the fan cage into the chassis.
2. Secure the fan cage with the four screws.

Next steps

1. Install the system fans.
2. Install the system cover.
3. Complete the procedure listed in [After working inside your system](#).

Related Links

[Removing the system cover](#)

[Installing the system cover](#)

[Removing a system fan](#)

[Installing a system fan](#)

PSUs

Your system supports 1100 W (for dual-node systems) or 1600 W (for single-node systems) AC redundant PSUs:

When two identical PSUs are installed, the PSU configuration is redundant (1 + 1) for each server sled. In redundant mode, power is supplied to the system equally from both PSUs to maximize efficiency.

 NOTE: If two PSUs are used, they must be of the same type and have the same maximum output power.

 NOTE: For AC PSUs, use only PSUs with the Extended Power Performance (EPP) label on the back. Mixing PSUs from previous generations of Dell servers can result in a PSU mismatch condition or failure to turn on.

Removing a redundant PSU

Prerequisites

 **CAUTION:** Many repairs may only be done by a certified service technician. You should only perform troubleshooting and simple repairs as authorized in your product documentation, or as directed by the online or telephone service and support team. Damage due to servicing that is not authorized by Dell is not covered by your warranty. Read and follow the safety instructions that came with the product.

 **CAUTION:** The system requires one PSU for normal operation. On power-redundant systems, remove and replace only one PSU at a time in a system that is powered on.

 **CAUTION:** The replacement service time for redundant PSUs when the system is operating is two minutes.

1. Ensure that you read the [Safety instructions](#).
2. Disconnect the power cable from the power source.
3. Disconnect the power cable from the PSU and remove the straps that bundle and secure the system cables.

 NOTE: You may have to unlatch and lift the optional cable management arm if it interferes with PSU removal. For information about the cable management arm, see [Installing the cable management arm \(CMA\)](#).

Steps

Press the release latch and pull the PSU straight out to release it from the chassis.

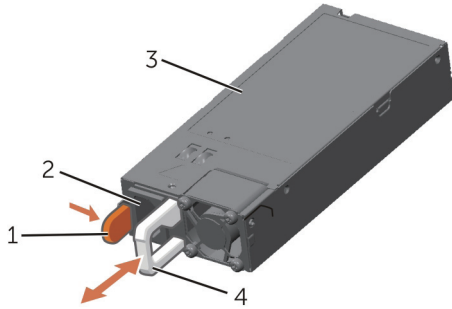

Figure 38. Removing and installing a redundant PSU

- | | | | |
|---|---------------|---|---------------|
| 1 | release latch | 2 | PSU connector |
| 3 | redundant PSU | 4 | PSU handle |

Installing a redundant PSU

Prerequisites

⚠ CAUTION: Many repairs may only be done by a certified service technician. You should only perform troubleshooting and simple repairs as authorized in your product documentation, or as directed by the online or telephone service and support team. Damage due to servicing that is not authorized by Dell is not covered by your warranty. Read and follow the safety instructions that came with the product.

Ensure that you read the [Safety instructions](#).

Steps

1. Verify that both PSUs are the same type and have the same maximum output power.
 - ✎ NOTE:** The maximum output power (shown in Watts) is listed on the PSU label.
2. Slide the new PSU into the chassis until the PSU is fully seated and the release latch snaps into place.
 - ✎ NOTE:** If you unlatched the cable management arm in step 3 of the previous procedure, relatch it. For information about the cable management arm, see [Installing the cable management arm \(CMA\)](#).
3. Connect the power cable to the PSU and plug the cable into a power outlet.
 - ⚠ CAUTION:** When connecting the power cable, secure the cable with the strap.
 - ✎ NOTE:** When installing, hot-swapping, or hot-adding a new PSU in a system with two PSUs, allow several seconds for the system to recognize the PSU and determine its status. The PSU status indicator turns green to signify that the PSU is functioning properly.

System battery

Replacing the system battery

Prerequisites

⚠ WARNING: There is a danger of a new battery exploding if it is incorrectly installed. Replace the battery only with the same or equivalent type recommended by the manufacturer. See your safety information for additional information.

⚠ CAUTION: Many repairs may only be done by a certified service technician. You should only perform troubleshooting and simple repairs as authorized in your product documentation, or as directed by the online or telephone service and support team. Damage due to servicing that is not authorized by Dell is not covered by your warranty. Read and follow the safety instructions that came with the product.

1. Ensure that you read the [Safety instructions](#).
2. Complete the procedure listed in [Before working inside your system](#).
3. Remove the server sled.
4. Remove the expansion-card riser module.

Steps

1. Locate the battery socket, see [System board connectors](#).

⚠ CAUTION: To avoid damage to the battery connector, you must firmly support the connector while installing or removing a battery.

2. To eject the battery, press firmly on the edge of the positive side of the battery in the direction of the arrow as shown in the illustration here.

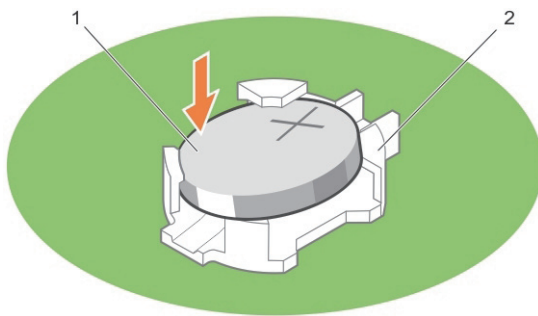

1 positive side of battery

2 socket

3. To install a new system battery, hold the battery with the positive facing up and slide it under the securing tabs.
4. Press the battery into the connector until it snaps into place.

Next steps

1. Install the expansion-card riser module.
2. Install the server sled.

3. Complete the procedure listed in [After working inside your system](#).
4. While booting, press **F2** to start the System Setup and ensure the battery is operating properly.
5. Enter the correct time and date in the System Setup Time and Date fields.
6. Exit the System Setup.

Related Links

- [Removing the expansion-card riser module](#)
- [Removing an expansion card](#)
- [Installing a riser card](#)
- [Installing the expansion-card riser module](#)
- [Removing the server sled](#)
- [Installing the server sled](#)

Interposer board

Removing the interposer board

Prerequisites



CAUTION: Many repairs may only be done by a certified service technician. You should only perform troubleshooting and simple repairs as authorized in your product documentation, or as directed by the online or telephone service and support team. Damage due to servicing that is not authorized by Dell is not covered by your warranty. Read and follow the safety instructions that came with the product.

1. Ensure that you read the [Safety instructions](#).
2. Complete the procedure listed in [Before working inside your system](#).
3. Remove the PSUs from the system.
4. Remove the server sleds.
5. Remove the system cover.
6. Remove the system fans and fan cage.

Steps

1. Disconnect all cables from the interposer board.
2. Pull the latch upward and lift the interposer board out of the chassis.

Next steps

1. Install the system fans and fan cage.
2. Install the system cover.
3. Install the server sleds.
4. Complete the procedure listed in [After working inside your system](#).

Related Links

- [Removing the server sled](#)
- [Installing the server sled](#)
- [Removing the system cover](#)
- [Installing the system cover](#)
- [Removing a system fan](#)
- [Installing a system fan](#)
- [Removing the fan cage](#)
- [Installing the fan cage](#)

Expander board

Removing the expander board

Prerequisites

 **CAUTION:** Many repairs may only be done by a certified service technician. You should only perform troubleshooting and simple repairs as authorized in your product documentation, or as directed by the online or telephone service and support team. Damage due to servicing that is not authorized by Dell is not covered by your warranty. Read and follow the safety instructions that came with the product.

1. Ensure that you read the [Safety instructions](#).
2. Complete the procedure listed in [Before working inside your system](#).
3. Remove the PSUs from the system.
4. Remove the system cover.

Steps

1. Remove the PSUs.
2. Loosen the two screws, and then open and pull the handle to remove the expander board bracket from the chassis.

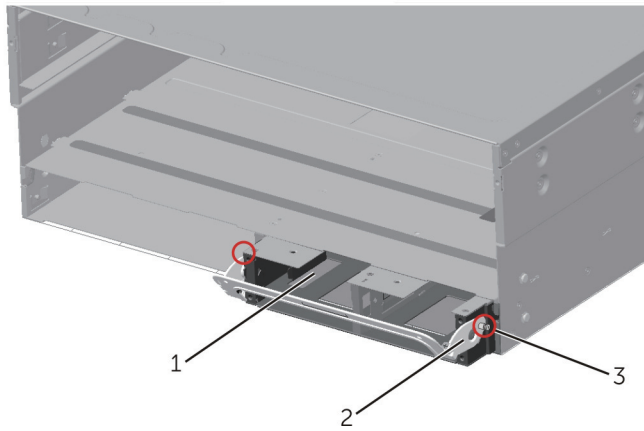

Figure 40. Removing and installing the expander board bracket

- 1 expander board bracket
- 2 handle (2)
- 3 screw (2)

- 3. Remove the six screws securing the expander board.
- 4. Remove the expander board from the expander board bracket.

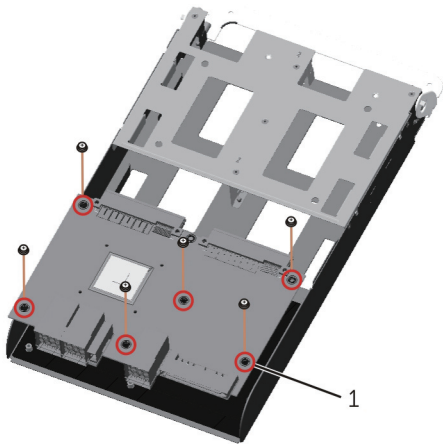

Figure 41. Removing and installing the expander board from the expander board bracket

- 1 screw (6)

Related Links

- [Removing the system cover](#)
- [Installing the system cover](#)

Installing the expander board

Prerequisites

 **CAUTION:** Many repairs may only be done by a certified service technician. You should only perform troubleshooting and simple repairs as authorized in your product documentation, or as directed by the online or telephone service and support team. Damage due to servicing that is not authorized by Dell is not covered by your warranty. Read and follow the safety instructions that came with the product.

Ensure that you read the [Safety instructions](#).

Steps

1. Install the expander board into the chassis.
2. Secure the expander board with the six screws.
3. Push the handle to install the expander board bracket into the chassis and secure the bracket with the two screws.
4. Install the PSUs.

Next steps

1. Install the system cover.
2. Complete the procedure listed in [After working inside your system](#).

Related Links

[Removing the system cover](#)

[Installing the system cover](#)

Paddle board

Removing the paddle board

Prerequisites

 **CAUTION:** Many repairs may only be done by a certified service technician. You should only perform troubleshooting and simple repairs as authorized in your product documentation, or as directed by the online or telephone service and support team. Damage due to servicing that is not authorized by Dell is not covered by your warranty. Read and follow the safety instructions that came with the product.

1. Ensure that you read the [Safety instructions](#).
2. Complete the procedure listed in [Before working inside your system](#).
3. Remove the server sled.

Steps

1. Disconnect all cables from the paddle board.
2. Remove the two screws on the paddle board and lift it away from the server sled.

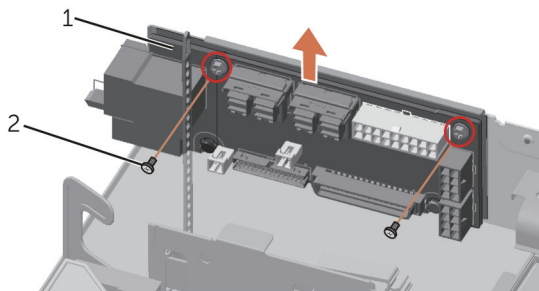

Figure 42. Removing and installing the paddle board

- | | | | |
|---|--------------|---|-----------|
| 1 | paddle board | 2 | screw (2) |
|---|--------------|---|-----------|

Related Links

[Removing the server sled](#)

Installing the paddle board

Prerequisites

- △ **CAUTION:** Many repairs may only be done by a certified service technician. You should only perform troubleshooting and simple repairs as authorized in your product documentation, or as directed by the online or telephone service and support team. Damage due to servicing that is not authorized by Dell is not covered by your warranty. Read and follow the safety instructions that came with the product.

Ensure that you read the [Safety instructions](#).

Steps

1. Install the paddle board into the server sled.
2. Tighten the two screws that secure the paddle board to the server sled.

Next steps

1. Reconnect all cables to the paddle board.
2. Complete the procedure listed in [After working inside your system](#).

Related Links

[Installing the server sled](#)

HDD cage and backplane

The DSS 7000 chassis supports 3.5-inch (x90) SAS/SATA backplane.

Removing the HDD cage and backplane

Prerequisites

- △ **CAUTION:** Many repairs may only be done by a certified service technician. You should only perform troubleshooting and simple repairs as authorized in your product documentation, or as directed by the online or telephone service and support team. Damage due to servicing that is not authorized by Dell is not covered by your warranty. Read and follow the safety instructions that came with the product.

⚠ **CAUTION:** To prevent damage to the drives and backplane, you must remove the HDDs from the system before removing the backplane.

⚠ **CAUTION:** You must note the number of each HDD and temporarily label them before removal so that you can replace them in the same locations.

1. Ensure that you read the [Safety instructions](#).
2. Complete the procedure listed in [Before working inside your system](#).
3. Turn off the system.
4. Remove the system cover.
5. Remove all HDDs.
6. Remove all system fans and the fan cage.
7. Remove all PSUs.
8. Remove all server sleds.
9. Remove all expander boards.
10. Disconnect all cables from the backplane.

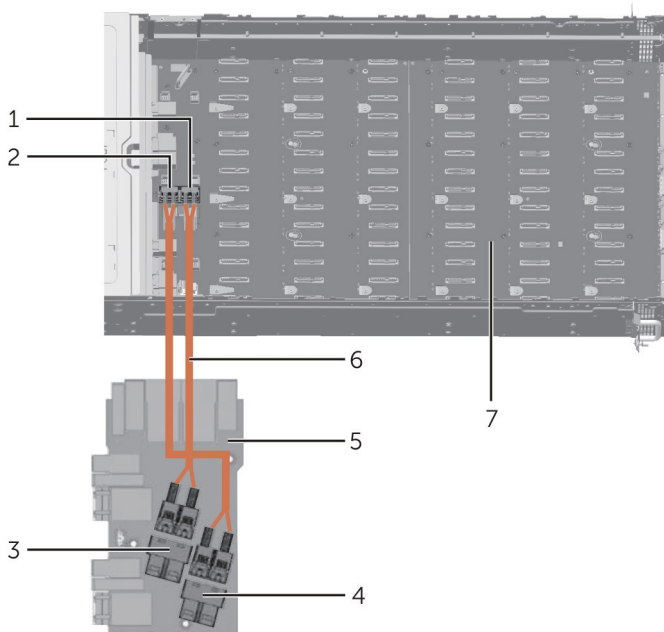

Figure 43. Cabling diagram for the backplane

- | | | | |
|---|--|---|--|
| 1 | SAS_A and SAS_B connectors on the backplane | 2 | SAS_C and SAS_D connectors on the backplane |
| 3 | SAS_A and SAS_B connectors on the interposer board | 4 | SAS_C and SAS_D connectors on the interposer board |

- 5 interposer board
- 7 HDD backplane

- 6 mini-SAS HD cable (2)

 NOTE: For single-node systems, the interposer board looks differently and its number of SAS connectors varies.

11. Remove the interposer board.

Steps

- 1. Remove the 24 screws securing the HDD cage to the chassis.
- 2. Loosen the 18 screws and lift the HDD cage out of the chassis.

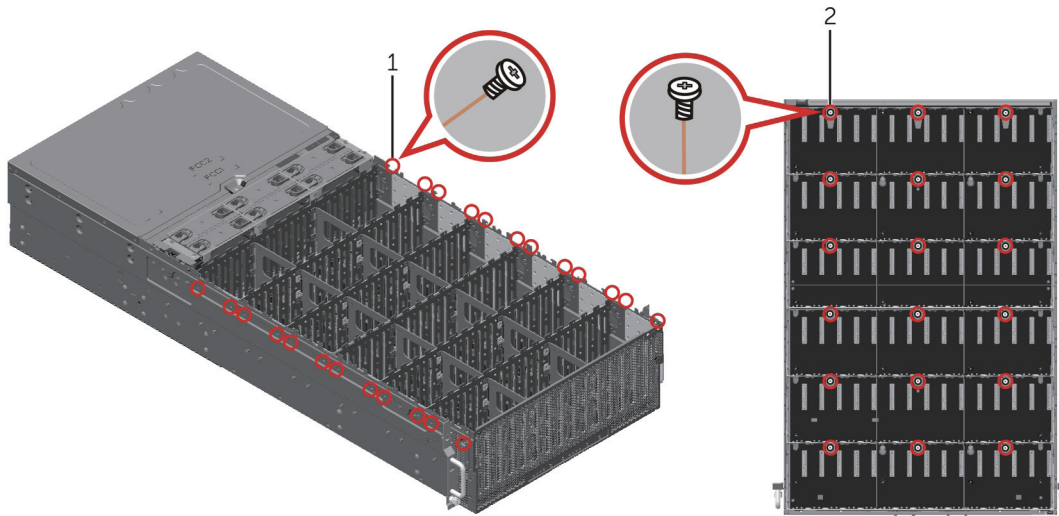

Figure 44. Removing and Installing the HDD cage

- 1 screw (24)

- 2 screw (18)

- 3. Remove the 26 screws from the backplane.
- 4. Remove the two standoffs from the backplane and chassis.
- 5. Slide the backplane to unlock the guide pins.
- 6. Lift the backplane out of the chassis.

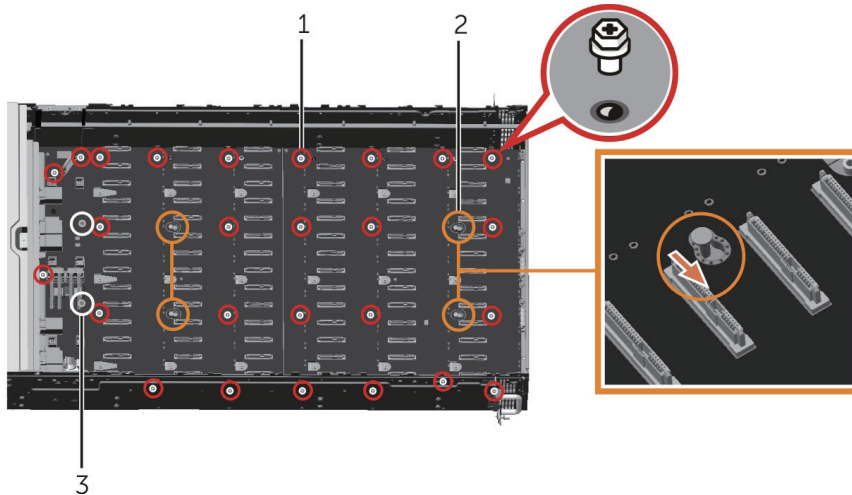

Figure 45. Removing and Installing the backplane

- | | | | |
|---|--------------|---|---------------|
| 1 | screw (26) | 2 | guide pin (4) |
| 3 | standoff (2) | | |

Related Links

- [Removing the system cover](#)
- [Removing a 3.5-inch hot-swap HDD](#)
- [Removing a system fan](#)
- [Removing the fan cage](#)
- [Removing the server sled](#)
- [Removing a redundant PSU](#)
- [Removing the interposer board](#)
- [Removing the expander board](#)

Installing the HDD cage and backplane

Prerequisites

CAUTION: Many repairs may only be done by a certified service technician. You should only perform troubleshooting and simple repairs as authorized in your product documentation, or as directed by the online or telephone service and support team. Damage due to servicing that is not authorized by Dell is not covered by your warranty. Read and follow the safety instructions that came with the product.

1. Ensure that you read the [Safety instructions](#).
2. Complete the procedure listed in [Before working inside your system](#).
3. Turn off the system.
4. Remove the system cover.
5. Remove all HDDs.
Take note of the HDD allocation so that you can re-install the HDDs in their original locations.
6. Remove all system fans and the fan cage.

7. Remove all PSUs.
8. Remove all server sleds.
9. Remove all expander boards.
10. Remove the interposer board.

Steps

1. Use the hooks on the chassis as guides to align the HDD backplane.
2. Slide the backplane to lock the guide pins.
3. Install the two standoffs through the backplane and secure them to the chassis.
4. Secure the backplane with the 26 screws.
5. Place the HDD cage inside the chassis and secure it with the 18 screws.
6. Secure the HDD cage to the chassis with the 24 screws.

Next steps

1. Install the interposer board.
2. Connect all cables to the backplane.
3. Install all expander boards.
4. Install the fan cage and all system fans.
5. Install all server sleds.
6. Install the HDDs in their original locations.
Begin with slot number 44 in the descending order.
7. Install all PSUs.
8. Install the system cover.
9. Complete the procedure listed in [After working inside your system](#).

Related Links

- [Removing the system cover](#)
- [Installing the system cover](#)
- [Removing a 3.5-inch hot-swap HDD](#)
- [Installing a 3.5-inch hot-swap HDD](#)
- [Removing a system fan](#)
- [Installing a system fan](#)
- [Removing the fan cage](#)
- [Installing the fan cage](#)
- [Removing the server sled](#)
- [Installing the server sled](#)
- [Removing a redundant PSU](#)
- [Installing a redundant PSU](#)
- [Removing the interposer board](#)
- [Installing the interposer board](#)
- [Removing the expander board](#)
- [Installing the expander board](#)

System board

Removing the system board

Prerequisites

- △ CAUTION: Many repairs may only be done by a certified service technician. You should only perform troubleshooting and simple repairs as authorized in your product documentation, or as directed by the online or telephone service and support team. Damage due to servicing that is not authorized by Dell is not covered by your warranty. Read and follow the safety instructions that came with the product.
- △ CAUTION: If you are using the Trusted Program Module (TPM) with an encryption key, you may be prompted to create a recovery key during program or System Setup. Be sure to create and safely store this recovery key. If you replace this system board, you must supply the recovery key when you restart your system or program before you can access the encrypted data on your HDDs.
- △ CAUTION: Do not attempt to remove the TPM plug-in module from the system board. Once the TPM plug-in module is installed, it is cryptographically bound to that specific system board. Any attempt to remove an installed TPM plug-in module breaks the cryptographic binding, and it cannot be re-installed or installed on another system board.

1. Ensure that you read the [Safety instructions](#).
2. Complete the procedure listed in [Before working inside your system](#).
3. Remove the server sled.
4. Remove the following:
 - a. cooling shroud
 - b. memory modules
 - c. sled cables
 - d. expansion cards
 - e. riser cards
 - f. expansion-card riser module
 - g. heat sink and processor

Steps

1. Disconnect all other cables from the system board.

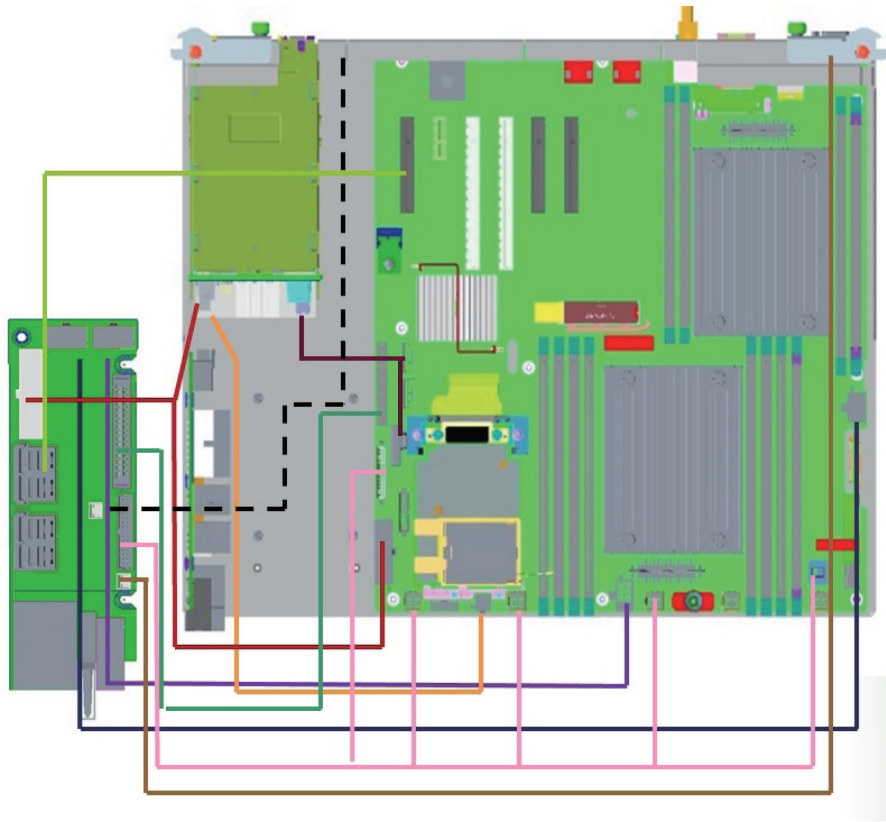













Figure 46. Cabling diagram

- | | | | |
|---|--|---|---------------------------------|
|  | 18-pin power cable and 4-pin power cable |  | 8-pin power cable |
|  | 8-pin power cable |  | 60-pin FBBI cable |
|  | 30-pin signal cable |  | 2-pin Blade EN cable (reserved) |
|  | SATA 7P cable |  | 4-pin power cable |
|  | Mini SAS HDD cable |  | Power button cable |

2. Remove the six screws on the system board.
3. Use a hex nut driver to remove the hex nut on the riser support standoff and the riser support standoff.
4. Lift the system board away from the server sled.

 **NOTE:** To prevent damage to the system board, ensure that you hold the system board by its edges only.

 **CAUTION:** Do not lift the system board assembly by holding a memory module, processor, or other components.

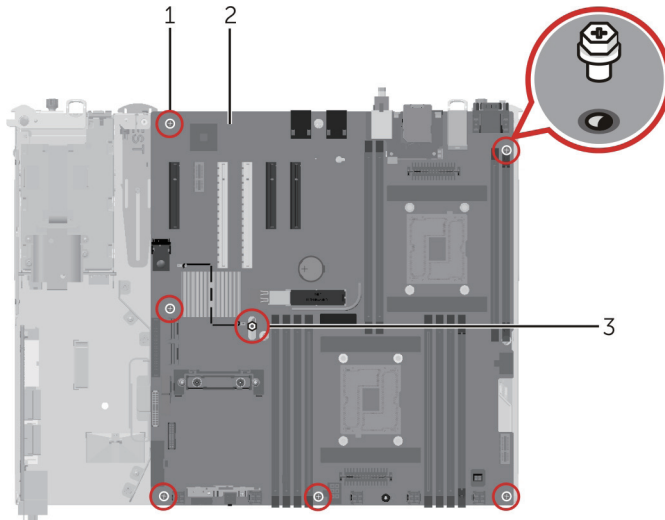

Figure 47. Removing and installing the system board

- | | | | |
|---|------------------------|---|--------------|
| 1 | screw (6) | 2 | system board |
| 3 | riser support standoff | | |

Related Links

- [Removing the cooling shroud](#)
- [Removing a memory module](#)
- [Removing an expansion card](#)
- [Removing the expansion-card riser module](#)
- [Removing a processor](#)
- [Removing the server sled](#)

Installing the system board

Prerequisites

CAUTION: Many repairs may only be done by a certified service technician. You should only perform troubleshooting and simple repairs as authorized in your product documentation, or as directed by the online or telephone service and support team. Damage due to servicing that is not authorized by Dell is not covered by your warranty. Read and follow the safety instructions that came with the product.

CAUTION: Do not lift the system board assembly by holding a memory module, processor, or other components.

1. Ensure that you read the [Safety instructions](#).
2. Unpack the new system board assembly.

Steps

1. Hold the system board by its edges and lower the system board into the chassis.
2. Replace and secure the riser support standoff with the hex nut.
3. Tighten the six screws that secure the system board to the server sled.

Next steps

1. Install the Trusted Platform Module (TPM). See [Installing the Trusted Platform Module](#).
2. Replace the following:
 - a. heat sink/heat-sink blank and processor
 - b. expansion-card riser module
 - c. riser cards
 - d. expansion cards
 - e. sled cables
 - f. memory modules
 - g. cooling shroud
3. Reconnect all cables to the system board.
 NOTE: Ensure that the cables inside the system are routed through the cable routing latch.
4. Complete the procedure listed in [After working inside your system](#).
5. Ensure that you:
 - a. Use the Easy Restore feature to restore the service tag. See [Restoring the Service Tag using Easy Restore](#).
 - b. If the Service Tag is not backed up in the backup flash device, enter the system service tag manually. See [Entering the system Service Tag using System Setup](#).
 - c. Update the BIOS and iDRAC versions.
 - d. Reenable the Trusted Platform Module (TPM). See [Re-enabling the TPM for BitLocker users](#) or [Re-enabling the TPM for TXT users](#).

Related Links

- [Installing the cooling shroud](#)
- [Installing a memory module](#)
- [Installing a system fan](#)
- [Installing a riser card](#)
- [Installing the expansion-card riser module](#)
- [Installing a processor](#)

Restoring the Service Tag using Easy Restore

Use the Easy Restore feature if you do not know the Service Tag of your system. The Easy Restore feature allows you to restore your system's Service Tag, license, UEFI configuration, and the system configuration data after replacing the system board. All data is backed up in a backup flash device automatically. If BIOS detects a new system board and the Service Tag in the backup flash device, BIOS prompts the user to restore the backup information.

1. Turn on the system.
If BIOS detects a new system board, and if the Service Tag is present in the backup flash device, BIOS displays the Service Tag, the status of the license, and the **UEFI Diagnostics** version.
2. Do one of the following:
 - Press **Y** to restore the Service Tag, license, and diagnostics information.

- Press **N** to navigate to the Lifecycle Controller based restore options.
- Press **F10** to restore data from a previously created **Hardware Server Profile**.

After the restore process is complete, BIOS prompts to restore the system configuration data.

3. Do one of the following:

- Press **Y** to restore the system configuration data.
- Press **N** to use the default configuration settings.

After the restore process is complete, the system restarts.

Entering the system Service Tag using System Setup

If you know the system Service Tag, use the System Setup menu to enter the Service Tag.

1. Turn on the system.
2. Press **F2** to start the System Setup.
3. Click **Service Tag Settings**.
4. Enter the Service Tag.

 **NOTE:** You can enter the only when the **Service Tag** field is empty. Ensure that you enter the correct Service Tag. Once the Service Tag is entered, it cannot be updated or changed.

5. Click **OK**.
6. Import your new or existing iDRAC Enterprise license.

For more information, see Integrated Dell Remote Access Controller User's Guide at dell.com/idracmanuals.

Trusted Platform Module

The Trusted Platform Module (TPM) is used to generate/store keys, protect/authenticate passwords, and create/store digital certificates. TPM can also be used to enable the BitLocker HDD encryption feature in Windows Server.

 **CAUTION:** Do not attempt to remove the Trusted Platform Module (TPM) from the system board. Once the TPM is installed, it is cryptographically bound to that specific system board. Any attempt to remove an installed TPM breaks the cryptographic binding, and it cannot be re-installed or installed on another system board.

Installing the Trusted Platform Module

Prerequisites

1. Ensure that you read the [Safety instructions](#).
2. Complete the procedure listed in [Before working inside your system](#).

 **CAUTION:** Do not remove an installed Trusted Platform Module (TPM). Any attempt to remove an installed TPM from the system board may damage the TPM.

Steps

1. Align the edge connectors on the TPM with the slot on the TPM connector.
2. Insert the TPM into the TPM connector such that the plastic bolt aligns with the slot on the system board.

3. Press the plastic bolt until the bolt snaps into place.

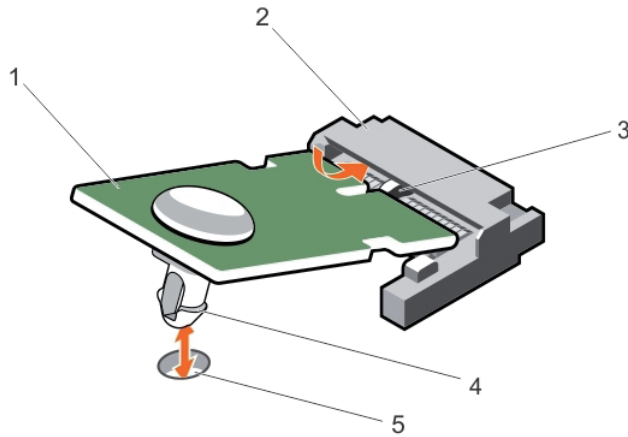

Figure 48. Installing the TPM

- | | | | |
|---|---------------------------|---|---------------|
| 1 | TPM | 2 | TPM connector |
| 3 | slot on the TPM connector | 4 | plastic bolt |
| 5 | slot on the system board | | |

Next steps

Complete the procedure listed in [After working inside your system](#).

Re-enabling the TPM for BitLocker users

Initialize the TPM.

For more information about initializing the TPM, see <http://technet.microsoft.com/en-us/library/cc753140.aspx>.

The **TPM Status** changes to **Enabled, Activated**.

Re-enabling the TPM for TXT users

1. While booting your system, press **F2** to enter System Setup.
2. In the **System Setup Main Menu**, click **System BIOS** → **System Security Settings**.
3. In the **TPM Security** option, select **On with Pre-boot Measurements**.
4. In the **TPM Command** option, select **Activate**.
5. Save the settings.
6. Restart your system.
7. Enter System Setup again.
8. In the **System Setup Main Menu**, click **System BIOS** → **System Security Settings**.
9. In the **Intel TXT** option, select **On**.

Troubleshooting your system

Safety first—for you and your system

 **CAUTION:** Many repairs may only be done by a certified service technician. You should only perform troubleshooting and simple repairs as authorized in your product documentation, or as directed by the online or telephone service and support team. Damage due to servicing that is not authorized by Dell is not covered by your warranty. Read and follow the safety instructions that came with the product.

Troubleshooting system startup failure

If you boot the system to the BIOS boot mode after installing an operating system from the UEFI Boot Manager, the system hangs. The reverse is also true. You must boot to the same boot mode in which you installed the operating system.

For all other startup issues, note the system messages that appear on the screen.

Troubleshooting external connections

Ensure that all external cables are securely attached to the external connectors on your system before troubleshooting any external devices.

Troubleshooting the video subsystem

1. Check the system and power connections to the monitor.
2. Check the video interface cabling from the system to the monitor.
3. Run the appropriate diagnostic test.

If the tests run successfully, the issue is not related to video hardware.

If the tests fail, see [Getting help](#).

Troubleshooting a USB device

About this task

Use the following steps to troubleshoot a USB keyboard/mouse. For other USB devices, go to step 7.

Steps

1. Disconnect the keyboard and mouse cables from the system and reconnect them.
2. If the issue persists, connect the keyboard/mouse to the other USB port(s) of the system.
3. If the issue is resolved, restart the system, start the System Setup, and check if the non-functioning USB ports are enabled.

Check if USB 3.0 is enabled in System Setup. If enabled, disable it and see if the issue is resolved (earlier OSs may not support USB 3.0).

4. In the **IDRAC Settings Utility**, ensure the **USB Management Port Mode** is configured as **Automatic** or **Standard OS Use**.
5. Replace the keyboard/mouse with a working keyboard/mouse.
If the issue is not resolved, proceed to the next step to begin troubleshooting other USB devices attached to the system.
6. Turn off all attached USB devices and disconnect them from the system.
7. Restart the system and, if your keyboard is functioning, start the System Setup.
8. Verify that all USB ports are enabled on the **Integrated Devices** screen, in the System Setup options.
9. Check if USB 3.0 is enabled in System Setup. If it is enabled, disable it and restart your system.
If your keyboard is not functioning, you can also use remote access.
10. If the system is not accessible, reset the NVRAM_CLR jumper inside your system and restore the BIOS to the default settings.
11. In the **IDRAC Settings Utility**, ensure the **USB Management Port Mode** is configured as **Automatic** or **Standard OS Use**.
12. Reconnect and turn on each USB device one at a time.
13. If a USB device causes the same issue, turn off the device, replace the USB cable with a known good cable, and turn on the device.

Next steps

If all troubleshooting fails, see [Getting help](#).

Troubleshooting a serial I/O device

Steps

1. Turn off the system and any peripheral devices connected to the serial port.
2. Swap the serial interface cable with a working cable, and turn on the system and the serial device.
If the issue is resolved, replace the interface cable with a known good cable.
3. Turn off the system and the serial device, and swap the device with a comparable device.
4. Turn on the system and the serial device.

Next steps

If the issue persists, see [Getting help](#).

Troubleshooting a NIC

Steps

1. Run the appropriate diagnostic test. See [Using system diagnostics](#) for available diagnostic tests.
2. Reboot the system and check for any system messages pertaining to the NIC controller.
3. Check the appropriate indicator on the NIC connector:
 - If the link indicator does not light, check all cable connections.

- If the activity indicator does not light, the network driver files might be damaged or missing. Remove and reinstall the drivers if applicable. See the NIC's documentation.
 - If applicable, change the autonegotiation setting.
 - Use another connector on the switch or hub.
4. Ensure that the appropriate drivers are installed and the protocols are bound. See the NIC's documentation.
 5. Start the System Setup and confirm that the NIC ports are enabled on the **Integrated Devices** screen.
 6. Ensure that the NICs, hubs, and switches on the network are all set to the same data transmission speed and duplex. See the documentation for each network device.
 7. Ensure that all network cables are of the proper type and do not exceed the maximum length.

Next steps

If all troubleshooting fails, see [Getting help](#).

Troubleshooting a wet system

Prerequisites



CAUTION: Many repairs may only be done by a certified service technician. You should only perform troubleshooting and simple repairs as authorized in your product documentation, or as directed by the online or telephone service and support team. Damage due to servicing that is not authorized by Dell is not covered by your warranty. Read and follow the safety instructions that came with the product.

Steps

1. Turn off the system and attached peripherals, and disconnect the system from the electrical outlet.
2. Remove the system cover and server sled.
3. Remove the following components from the system:
 - HDDs
 - HDD backplane
 - cooling shroud
 - expansion-card riser module (if present)
 - riser cards
 - expansion cards
 - PSUs
 - system fans
 - processor(s) and heat sink(s)
 - memory modules
4. Let the system dry thoroughly for at least 24 hours.
5. Reinstall the components you removed in step 3.
6. Install the system cover and server sled.
7. Turn on the system and attached peripherals.

If the system does not start properly, see [Getting help](#).

8. If the system starts properly, turn off the system, and reinstall all the expansion cards that you removed.
9. Run the appropriate diagnostic test. For more information, see [Using system diagnostics](#).

Next steps

If the tests fail, see [Getting help](#).

Troubleshooting a damaged system

Prerequisites



CAUTION: Many repairs may only be done by a certified service technician. You should only perform troubleshooting and simple repairs as authorized in your product documentation, or as directed by the online or telephone service and support team. Damage due to servicing that is not authorized by Dell is not covered by your warranty. Read and follow the safety instructions that came with the product.

Steps

1. Turn off the system and attached peripherals, and disconnect the system from the electrical outlet.
2. Remove the system cover and server sled.
3. Ensure that the following components are properly installed:
 - Cooling shroud
 - Expansion-card riser module (if present)
 - Riser cards
 - Expansion cards
 - PSUs
 - System fans
 - Processors and heat sinks
 - Memory modules
 - HDD carriers
 - HDD backplane
4. Ensure that all cables are properly connected.
5. Install the system cover and server sled.
6. Run the appropriate diagnostic test. For more information about the diagnostic test, see [Using system diagnostics](#).

Next steps

If the tests fail, see [Getting help](#).

Troubleshooting the system battery

Prerequisites

 **CAUTION:** Many repairs may only be done by a certified service technician. You should only perform troubleshooting and simple repairs as authorized in your product documentation, or as directed by the online or telephone service and support team. Damage due to servicing that is not authorized by Dell is not covered by your warranty. Read and follow the safety instructions that came with the product.

 **NOTE:** If the system is turned off for long periods of time (for weeks or months), the NVRAM may lose its system configuration information. This situation is caused by a defective battery.

Steps

1. Reenter the time and date in the System Setup.
2. Turn off the system and disconnect it from the electrical outlet for at least one hour.
3. Reconnect the system to the electrical outlet and turn on the system.
4. Start the System Setup.

If the date and time are not correct in the System Setup, check the SEL for system battery messages.

Next steps

If the issue persists, see [Getting help](#).

 **NOTE:** Some software may cause the system time to speed up or slow down. If the system seems to operate normally except for the time kept in the System Setup, the issue may be caused by software rather than by a defective battery.

Troubleshooting PSUs

 **CAUTION:** Many repairs may only be done by a certified service technician. You should only perform troubleshooting and simple repairs as authorized in your product documentation, or as directed by the online or telephone service and support team. Damage due to servicing that is not authorized by Dell is not covered by your warranty. Read and follow the safety instructions that came with the product.

Power source issues

1. Press the power button to ensure that your system is turned on. If the power indicator does not light up when the power button is pressed, press the power button firmly.
2. Plug in another working device to ensure that the system board is not faulty.
3. Ensure that no loose connections exist.
For example, loose power cables.
4. Ensure that the power source meets applicable standards.
5. Ensure that there are no short circuits.
6. Have a qualified electrician check the line voltage to ensure that it meets the required specifications.

PSU issues

1. Ensure that no loose connections exist.
For example, loose power cables.
2. Ensure that the PSU handle/LED indicates that the PSU is working properly.
3. If you have recently upgraded your system, ensure that the PSU has enough power to support the new system.
4. If you have a redundant PSU configuration, ensure that both the PSUs are of the same type and wattage.
5. Ensure that you use only PSUs with the Extended Power Performance (EPP) label on the back.
6. Reseat the PSU.

 NOTE: After installing a PSU, allow several seconds for the system to recognize the PSU and determine if it is working properly.

If the issue persists, see [Getting help](#).

Troubleshooting cooling issues

 **CAUTION:** Many repairs may only be done by a certified service technician. You should only perform troubleshooting and simple repairs as authorized in your product documentation, or as directed by the online or telephone service and support team. Damage due to servicing that is not authorized by Dell is not covered by your warranty. Read and follow the safety instructions that came with the product.

Ensure that the following conditions exist:

- System cover, cooling shroud, EMI filler panel, memory module blank, or back-filler bracket is not removed.
- Ambient temperature is not too high.
- External airflow is not obstructed.
- A system fan is not removed or has not failed.
- The expansion card installation guidelines have been followed.

Additional cooling can be added by one of the following methods:

On the iDRAC Web GUI

1. Click **Hardware** → **Fans** → **Setup**.
2. Set the minimum fan speed to a custom value.

From F2 System Setup

1. Click **iDRAC Settings** → **Thermal**, and set a higher fan speed from the minimum fan speed.

From RACADM commands

1. Run the command `racadm help system.thermalsettings`.

For more information, see the Integrated Dell Remote Access User's Guide at dell.com/idracmanuals.

Troubleshooting system fans

Prerequisites

 **CAUTION:** Many repairs may only be done by a certified service technician. You should only perform troubleshooting and simple repairs as authorized in your product documentation, or as directed by the online or telephone service and support team. Damage due to servicing that is not authorized by Dell is not covered by your warranty. Read and follow the safety instructions that came with the product.

 **NOTE:** In the event of an issue with a particular fan, the fan number is referenced by the system's management software, allowing you to easily identify and replace the proper fan by noting the fan numbers on the system fan assembly.

Steps

1. Remove the system cover.
2. Reseat the fan or the fan's power cable.
3. Install the system cover.
4. Restart your system.

Next steps

If the issue persists, see [Getting help](#).

Troubleshooting system memory

Prerequisites

 **CAUTION:** Many repairs may only be done by a certified service technician. You should only perform troubleshooting and simple repairs as authorized in your product documentation, or as directed by the online or telephone service and support team. Damage due to servicing that is not authorized by Dell is not covered by your warranty. Read and follow the safety instructions that came with the product.

Steps

1. If the system is operational, run the appropriate diagnostic test. See [Using system diagnostics](#) for available diagnostic tests.

If diagnostics indicate a fault, follow the corrective actions provided by the diagnostic program.

2. If the system is not operational, turn off the system and attached peripherals, and unplug the system from the power source. Wait at least 10 seconds and then reconnect the system to the power source.
3. Turn on the system and attached peripherals and note the messages on the screen.

If any message is displayed indicating that a fault with a specific memory module, go to step 12.

4. Start the System Setup and check the system memory setting. Make any changes to the memory settings, if required.

If the memory settings match the installed memory but the issue still persists, go to step 12.

5. Turn off the system and attached peripherals, and disconnect the system from the electrical outlet.
6. Remove the server sled.
7. Check the memory channels and ensure that they are populated correctly.



See the system event log or system messages for the location of the failed memory module. Reinstall the memory device.

8. Reseat the memory modules in their sockets.
9. Install the server sled.
10. Start the System Setup and check the system memory setting.
If the issue is not resolved, proceed with the next step.
11. Remove the server sled.
12. If a diagnostic test or error message indicates a specific memory module as faulty, swap or replace the module with a known good memory module.
13. To troubleshoot an unspecified faulty memory module, replace the memory module in the first DIMM socket with a module of the same type and capacity.
If any message is displayed indicating an issue with the installed DIMM types, incorrect DIMM installation, or defective DIMMs, complete the on-screen instructions to resolve the issue.
14. Install the server sled.
15. As the system boots, observe any message that is displayed and the diagnostic indicators on the front of the system.
16. If the memory issue persists, repeat step 12 – 15 for each memory module installed.

Next steps

If the issue persists after all memory modules have been checked, see [Getting help](#).

Troubleshooting HDDs

Prerequisites



CAUTION: Many repairs may only be done by a certified service technician. You should only perform troubleshooting and simple repairs as authorized in your product documentation, or as directed by the online or telephone service and support team. Damage due to servicing that is not authorized by Dell is not covered by your warranty. Read and follow the safety instructions that came with the product.



CAUTION: This troubleshooting procedure can erase data stored on the HDD. Before you proceed, back up all files on the HDD.

Steps

1. Run the appropriate diagnostic test. For more information, see [Using system diagnostics](#).
Depending on the results of the diagnostics test, proceed as needed through the following steps.
2. If your system has a RAID controller and your HDDs are configured in a RAID array, complete the following steps:
 - a. Reboot the system and press **Ctrl + A** during system startup to run the HBA utility to check the RAID configuration.
 - b. Ensure that the HDDs are configured correctly for the RAID array.
 - c. Take the HDD offline and reseat the drive.
 - d. Exit the configuration utility and allow the system to boot to the operating system.

3. Ensure that the required device drivers for your controller card are installed and are configured correctly. See the operating system documentation for more information.
4. Reboot the system and start the System Setup.
5. Verify that the controller is enabled and the drives are displayed in the System Setup.

Next steps

If the issue persists, try troubleshooting the expansion cards or see [Getting help](#).

Troubleshooting expansion cards

Prerequisites

 **CAUTION: Many repairs may only be done by a certified service technician. You should only perform troubleshooting and simple repairs as authorized in your product documentation, or as directed by the online or telephone service and support team. Damage due to servicing that is not authorized by Dell is not covered by your warranty. Read and follow the safety instructions that came with the product.**

 **NOTE:** When troubleshooting an expansion card, see the documentation for your operating system and the expansion card.

Steps

1. Run the appropriate diagnostic test. For more information, see [Using system diagnostics](#).
2. Turn off the system and attached peripherals, and disconnect the system from the electrical outlet.
3. Remove the server sled and expansion-card riser module.
4. Ensure that each expansion card is firmly seated in its connector.
5. Install the server sled and expansion-card riser module.
6. If the issue is not resolved, turn off the system and attached peripherals, and disconnect the system from the electrical outlet.
7. Remove the server sled and expansion-card riser module.
8. Remove all expansion cards installed in the system.
9. Install the server sled and expansion-card riser module.
10. Run the appropriate diagnostic test. For more information, see [Using system diagnostics](#).
If the tests fail, see [Getting help](#).
11. For each expansion card you removed in step 8, perform the following steps:
 - a. Turn off the system and attached peripherals, and disconnect the system from the electrical outlet.
 - b. Remove the server sled and expansion-card riser module.
 - c. Reinstall one of the expansion cards.
 - d. Install the server sled and expansion-card riser module.
 - e. Run the appropriate diagnostic test. For more information, see [Using system diagnostics](#).

Next steps

If the issue persists, see [Getting help](#).

Troubleshooting processors

Prerequisites



CAUTION: Many repairs may only be done by a certified service technician. You should only perform troubleshooting and simple repairs as authorized in your product documentation, or as directed by the online or telephone service and support team. Damage due to servicing that is not authorized by Dell is not covered by your warranty. Read and follow the safety instructions that came with the product.

Steps

1. Run the appropriate diagnostics test. See [Using system diagnostics](#) for available diagnostic tests.
2. Turn off the system and attached peripherals, and disconnect the system from the electrical outlet.
3. Remove the server sled and cooling shroud.
4. Ensure that the processor and heat sink are properly installed.
5. Install the server sled and cooling shroud.
6. Run the appropriate diagnostic test. For more information, see [Using system diagnostics](#).

Next steps

If the issue persists, see [Getting help](#).

Troubleshooting server sleds

If you encounter an issue when turning on a server sled, ensure that its related PSUs are installed properly.

When you are facing the back panel, from left to right: PSUs 1 and 2 are for sled B (upper sled); PSUs 3 and 4 are for sled A (lower sled).



NOTE: Features of sled B are for dual-node systems only.

Next steps

If the issue persists, see [Getting help](#).

System messages

For a list of event and error messages generated by the system firmware and agents that monitor system components, see the Dell Event and Error Messages Reference Guide at dell.com/idracmanuals.

Warning messages

A warning message alerts you to a possible issue and prompts you to respond before the system continues a task. For example, before you format an HDD, a message warns you that you may lose all data on the HDD. Warning messages usually interrupt the task and require you to respond by typing y (yes) or n (no).



NOTE: Warning messages are generated by either the application or the operating system. For more information, see the documentation that accompanied the operating system or application.

Diagnostic messages

The system diagnostic utilities may issue messages if you run diagnostic tests on your system. See [Using system diagnostics](#) for more information about system diagnostics.

Using system diagnostics

If you encounter an issue with your system, run the system diagnostics before contacting Dell for technical assistance. The purpose of running system diagnostics is to test your system hardware without requiring additional equipment or risking data loss. If you are unable to fix the issue yourself, service and support personnel can use the diagnostics results to help you solve the issue.

Dell Embedded System Diagnostics

 NOTE: The Dell Embedded System Diagnostics is also known as Enhanced Pre-boot System Assessment (ePSA) diagnostics.

The embedded system diagnostics provides a set of options for particular device groups or devices allowing you to:

- Run tests automatically or in an interactive mode
- Repeat tests
- Display or save test results
- Run thorough tests to introduce additional test options to provide extra information about the failed devices
- View status messages that inform you if tests are completed successfully
- View error messages that inform you of issues encountered during testing

When to use the Embedded System Diagnostics

If a major component or device in the system does not operate properly, running the embedded system diagnostics may indicate component failure.

Running the Embedded System Diagnostics from Boot Manager

1. As the system boots, press **F11**.
2. Use the up and down arrow keys to select **System Utilities** → **Launch Diagnostics**.

The **ePSA Pre-boot System Assessment** window is displayed, listing all devices detected in the system. The diagnostics starts executing the tests on all the detected devices.

Running the Embedded System Diagnostics from the Dell Lifecycle Controller

1. As the system boots, press **F10**.
2. Click **Hardware Diagnostics** → **Run Hardware Diagnostics**.

The **ePSA Pre-boot System Assessment** window is displayed, listing all devices detected in the system. The diagnostics starts executing the tests on all the detected devices.

System diagnostic controls

Menu	Description
Configuration	Displays the configuration and status information of all detected devices.
Results	Displays the results of all tests that are executed.
System health	Provides the current overview of the system performance.
Event log	Displays a time-stamped log of the results of all tests run on the system. This is displayed if at least one event description is recorded.





For information about embedded system diagnostics, see the ePSA Diagnostics Guide (Notebooks, Desktops and Servers) at dell.com/support.

Jumpers and connectors

System board jumper settings

For information about resetting the password jumper to disable a password, see [Disabling a forgotten password](#).

Table 6. System board jumper settings

Jumper	Setting	Description
PWRD_EN	 (default)	The password reset feature is enabled (pins 2 – 4).
		The password reset feature is disabled (pins 4 – 6). The iDRAC local access is unlocked at the next AC power cycle.
NVRAM_CLR	 (default)	The configuration settings are retained at the next system boot (pins 3 – 5).
		The configuration settings are cleared at system boot (pins 1 – 3).

System board connectors

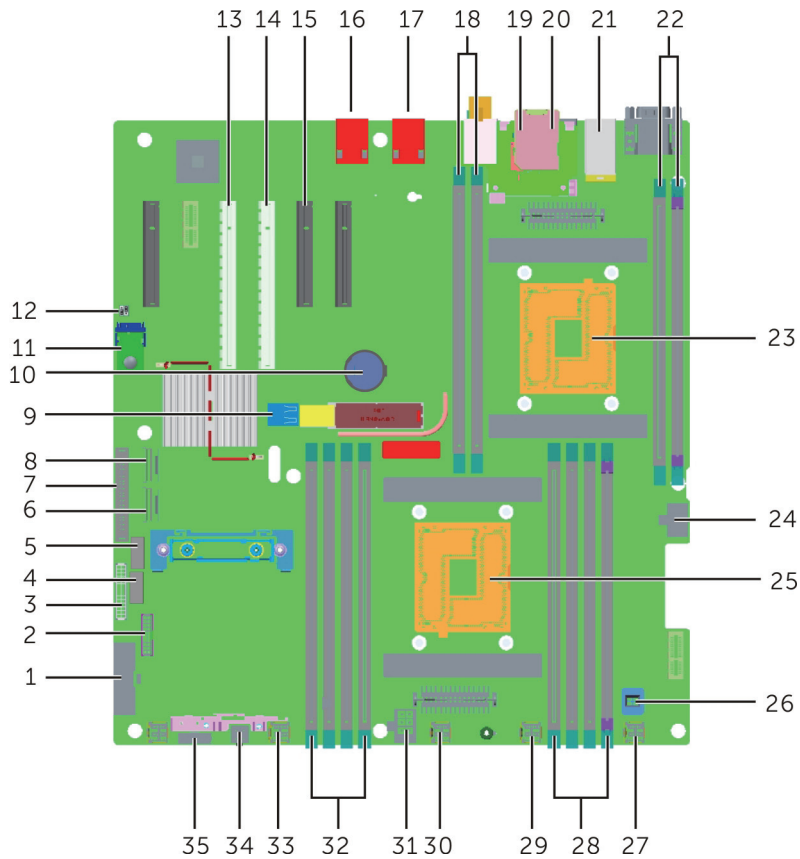

Figure 49. System board jumpers and connectors

Item	Connector	Description
1	SYS_PWR_CONN (P1)	24-pin power connector
2	FP_USB	Front-panel USB connector (reserved)
3	PIB_CONN	Hot/cool-interposer board connector
4	SATA_HDD	SATA boot drive B
5	SATA_HDD	SATA boot drive A
6	SW_RAID_B	Software RAID connector B (reserved)
7	CTRL_PNL	Control panel interface connector (reserved)
8	SW_RAID_A	Software RAID connector A
9	INT_USB_3.0	Internal USB connector

Item	Connector	Description
10	BATTERY	Battery connector
11	TPM_MODULE	Trusted platform module connector
12	J_PSWD_NVRAM	For more information, see System board jumper settings .
13	PCIE_G3_X16(CPU1)	PCIe card connector 3
14	PCIE_G3_X16(CPU1)	PCIe card connector 2
15	PCIE_G3_X8(CPU2)	PCIe card connector 1
		 NOTE: The PCIE_G3_X8 and PCIE_G3_X16 are the two different types of risers supported on DSS 7500 systems. You can install a riser card on the system board only using expansion-card riser module. Form more information about the installation guidelines, see Expansion card installation guidelines .
16	NIC4	Network connector
17	NIC3	Network connector
18	B1, B2	Memory module socket
19	USB2_3.0	USB connector
20	USB1	USB connector
21	NIC1 and NIC2	Network connector
22	B3, B4	Memory module socket
23	CPU2	Processor socket 2
24	PWR_CONN_C(P3)	8-pin power connector
25	CPU1	Processor socket 1
26	INTRUSION	Intrusion switch connector
27	FAN connector	System fan connector (reserved)
28	A1, A5, A2, A6	Memory module socket
29	FAN connector	System fan connector (reserved)
30	FAN connector	Connecting to system FAN1 and FAN4
31	PWR_CONN_B(P2)	8-pin power connector
32	A3, A7, A4, A8	Memory module socket

Item	Connector	Description
33	FAN connector	Connecting to system FAN2 and FAN5
34	FAN connector	Connecting to system FAN3 and FAN6
35	BP_SIG	Backplane signal connector (reserved)

Disabling a forgotten password

The system's software security features include a system password and a setup password. The password jumper enables these password features or disables them and clears any password(s) currently in use.

Prerequisites

 **CAUTION: Many repairs may only be done by a certified service technician. You should only perform troubleshooting and simple repairs as authorized in your product documentation, or as directed by the online or telephone service and support team. Damage due to servicing that is not authorized by Dell is not covered by your warranty. Read and follow the safety instructions that came with the product.**

Steps

1. Turn off the system, including any attached peripherals, and disconnect the system from the electrical outlet.
2. Remove the server sled and expansion-card riser.
3. Move the jumper on the system-board jumper from pins 4 and 6 to pins 2 and 4.
4. Install the server sled and expansion-card riser.

The existing passwords are not disabled (deleted) until the system boots with the jumper on pins 2 and 4. However, before you assign a new system and/or setup password, you must move the jumper back to pins 4 and 6.

 **NOTE:** If you assign a new system and/or setup password with the jumper on pins 2 and 4, the system disables the new password(s) the next time it boots.

5. Reconnect the system to its electrical outlet and turn the system on, including any attached peripherals.
6. Turn off the system, including any attached peripherals, and disconnect the system from the electrical outlet.
7. Remove the server sled and expansion-card riser.
8. Move the jumper on the system-board jumper from pins 2 and 4 to pins 4 and 6.
9. Install the server sled and expansion-card riser.
10. Reconnect the system to its electrical outlet and turn the system on, including any attached peripherals.
11. Assign a new system and/or setup password.

Technical specifications

Physical

Height	173.8 mm (6.84 inch)
Width	
With rack latches	482.4 mm (18.99 inch)
Without rack latches	448.0 mm (17.64 inch)
Depth (excludes bezel)	1098.4 mm (43.24 inch)
Weight (maximum)	129.6 kg (285.72 lb)
Weight (empty)	57.1 kg (125.88 lb)
Total depth of system with cable management (CMA) arm attached	1242.68 mm

Processor

Processor type	Intel Xeon EP E5-2600 v3 and v4 product families
----------------	--

Expansion Bus

Bus type	PCI Express Generation 3
----------	--------------------------

Expansion slots using the expansion-card riser module

PCIE_G3_X8	(Slot 1) one half-height, half-length x8 link for processor 2
PCIE_G3_X16	(Slot 2) one full-height, half-length x16 link for processor 1
PCIE_G3_X8	(Slot 3) one full-height, half-length x8 link for processor 1
PCIE_G3_X8	(Slot 4) one half-height, half-length x8 link for processor 1

Memory

Architecture	1333 MT/s, 1600 MT/s, 1866 MT/s, 2133 MT/s, or 2400 MT/s DDR4 Registered DIMMs Support for advanced ECC or memory optimized operation
Memory module sockets	12 288-pin
Memory module capacities (RDIMMs)	16 GB (single- and dual-rank) and 32 GB (single- and dual-rank)
Minimum RAM	16 GB with single processor 32 GB with dual processor
Maximum RAM	Up to 192 GB with single processor Up to 384 GB with dual processor

Power

AC power supply (per PSU)	
Wattage	1100 W (for dual-node systems) or 1600 W (for single-node systems)
Power rating per PSU	1100 W (for dual-node systems) (Platinum) AC (200 – 240 V, 50/60 Hz, 6.5 A) or 1600 W (for single-node systems) (Gold) AC (200 – 240 V, 50/60 Hz, 10.0 A)
Heat dissipation	4170 BTU/hr maximum (1100 W PSU) or 6060 BTU/hr maximum (1600 W PSU)
 NOTE: This system is also designed to be connected to IT power systems with a phase to phase voltage not exceeding 230 V.	
Voltage	200 – 240 V AC, autoranging, 50/60 Hz

RAID Controller

Controller type	PMC 8805, LSI 9361-8i or LSI 9311
-----------------	-----------------------------------

Drives

Single-node systems with one server sled	Up to 90 3.5-inch hot-swappable Serial Attached SCSI (SAS) HDDs, SATA HDDs, or SATA SSDs, or Up to 16 hot-swappable SAS SSDs Up to two 2.5-inch hot-swappable boot SATA SSDs
--	--

Drives

Dual-node systems with two server sleds	Up to 90 3.5-inch hot-swappable Serial Attached SCSI (SAS) HDDs, SATA HDDs, or SATA SSDs, or Up to 12 hot-swappable SAS SSDs Up to four 2.5-inch hot-swappable boot SATA SSDs
---	---

Connectors (per server sled)

Back

NIC	Four 10/100/1000 Mbps
Serial	9-pin, DTE, 16550-compatible
USB	One 9-pin, USB 3.0-compliant One 4-pin, USB 2.0-compliant
Video	15-pin VGA

Internal

USB	One 9-pin, USB 3.0-compliant
-----	------------------------------

Video

Video type	Integrated Matrox G200
Video memory	16 MB shared

Environmental specifications

 NOTE: For additional information about environmental measurements for specific system configurations, see dell.com/environmental_datasheets.

Temperature

Storage	-40°C to 65°C (-40°F to 149°F)
Continuous operation (for altitude less than 950 m or 3117 ft)	10°C to 35°C (50°F to 95°F) with no direct sunlight on the equipment.
Fresh air	For information about fresh air, see Expanded Operating Temperature section.
Maximum temperature gradient (operating and storage)	20°C/h (36°F/h)

Relative humidity

Storage	5 to 95 percent RH with 33°C (91°F) maximum dew point. Atmosphere must be non-condensing at all times.
---------	--

Environmental specifications

Operating	10 to 80 percent Relative Humidity with 29°C (84.2°F) maximum dew point.
-----------	--

Maximum vibration

Operating	0.26 Grms at 5 Hz to 350 Hz (all operation orientations).
-----------	---

Storage	1.88 Grms at 10 Hz to 500 Hz for 15 min (bottom side of shipment orientation only).
---------	---

Maximum shock

Operating	Four shock pulses per axis (the positive and negative x, y and z axes), 24 total shock pulses. 40 G, 2.3 ms for x and y axes. 36 G, 2.3 ms for z axe.
-----------	---

Storage	<ul style="list-style-type: none">• 71 G, 2 ms pulse shape is Half-Sine (bottom side of shipping orientation only).• 15 G, 165 in/sec pulse shape is Square-Wave (bottom side of shipping orientation only)
---------	--

Maximum altitude

Operating	3048 m (10,000 ft).
-----------	---------------------

Storage	12,000 m (39,370 ft).
---------	-----------------------

Operating temperature de-rating

Up to 35°C (95°F)	Maximum temperature is reduced by 1°C/300 m (1°F/547 ft) above 950 m (3,117 ft).
-------------------	--

35°C to 40°C (95°F to 104°F)	Maximum temperature is reduced by 1°C/175 m (1°F/319 ft) above 950 m (3,117 ft).
------------------------------	--

40°C to 45°C (104°F to 113°F)	Maximum temperature is reduced by 1°C/125 m (1°F/228 ft) above 950 m (3,117 ft).
-------------------------------	--

Particulate contamination

 NOTE: This section defines the limits to help avoid IT equipment damage and/or failure from particulates and gaseous contamination. If it is determined that levels of particulates or gaseous pollution are beyond the limits specified below and are the reason for the damage and/or failures to your equipment, it may be necessary for you to re-mediate the environmental conditions that are causing the damage and/or failures. Re-mediation of environmental conditions will be the responsibility of a customer.

Particulate contamination

Air filtration

 NOTE: Applies to data center environments only. Air filtration requirements do not apply to IT equipment designed to be used outside a data center, in environments such as an office or factory floor.

Data center air filtration as defined by ISO Class 8 per ISO 14644-1 with a 95 percent upper confidence limit.

 NOTE: Air entering the data center must have MERV11 or MERV13 filtration.

Conductive dust

 NOTE: Applies to data center and non-data center environments.

Air must be free of conductive dust, zinc whiskers, or other conductive particles.

Corrosive dust

 NOTE: Applies to data center and non-data center environments.

- Air must be free of corrosive dust.
- Residual dust present in the air must have a deliquescent point less than 60 percent relative humidity.

Gaseous contamination

 NOTE: Maximum corrosive contaminant levels measured at ≤ 50 percent relative humidity.

Copper coupon corrosion rate

$< 300 \text{ \AA/month}$ per Class G1 as defined by ANSI/ISA71.04-1985.

Silver coupon corrosion rate

$< 200 \text{ \AA/month}$ as defined by AHSRAE TC9.9.

Expanded Operating Temperature

 NOTE: When operating in the expanded temperature range, system performance may be impacted.

 NOTE: When operating in the expanded temperature range, ambient temperature warnings may be reported on the LCD and in the System Event Log.

< 10 percent of annual operating hours

5°C to 40°C at 5 to 85 percent RH with 26°C dew point.

 NOTE: Outside the standard operating temperature (10°C to 35°C), the system can operate down to 5°C or up to 40°C for a maximum of 10 percent of its annual operating hours.

For temperatures between 35°C and 40°C, de-rate maximum allowable dry bulb temperature by 1°C per 175 m above 950 m (1°F per 319 ft).

Expanded Operating Temperature

< 1 percent of annual operating hours

–5°C to 45°C at 5 to 90 percent RH with 26°C dew point.



NOTE: Outside the standard operating temperature (10°C to 35°C), the system can operate down to –5°C or up to 45°C for a maximum of 1 percent of its annual operating hours.

For temperatures between 40°C and 45°C, de-rate maximum allowable dry bulb temperature by 1°C per 125 m above 950 m (1°F per 228 ft).

Expanded Operating Temperature Restrictions

- Processors of 55 W and 65 W are not supported.
- Do not perform a cold startup at less than 5°C.
- Allow processor performance degrade.
- Non-redundant PSUs are not supported.
- Non-Dell qualified peripheral cards and/or peripheral cards are not supported.
- Maximum altitude for the operating temperature must be 3050 m (10,000 ft).

Getting help

Contacting Dell

Dell provides several online and telephone-based support and service options. If you do not have an active Internet connection, you can find contact information about your purchase invoice, packing slip, bill, or Dell product catalog. Availability varies by country and product, and some services may not be available in your area. To contact Dell for sales, technical support, or customer-service issues:

1. Go to **dell.com/support**.
2. Select your country from the drop-down menu on the bottom right corner of the page.
3. For customized support:
 - a. Enter your system Service Tag in the **Enter your Service Tag** field.
 - b. Click **Submit**.

The support page that lists the various support categories is displayed.

4. For general support:
 - a. Select your product category.
 - b. Select your product segment.
 - c. Select your product.

The support page that lists the various support categories is displayed.

Locating your system Service Tag

Your system is identified by a unique Express Service Code and Service Tag number. The Express Service Code and Service Tag are found on the information tag at each server sled on the rear of the system. Alternatively, the information may be on a sticker on the chassis of the system. This information is used by Dell to route support calls to the appropriate personnel.