

Alienware 17 Service Manual

Computer Model: Alienware 17 R3
Regulatory Model: P43F
Regulatory Type: P43F001

A L I E N W A R E 

Notes, cautions, and warnings



NOTE: A NOTE indicates important information that helps you make better use of your computer.



CAUTION: A CAUTION indicates either potential damage to hardware or loss of data and tells you how to avoid the problem.



WARNING: A WARNING indicates a potential for property damage, personal injury, or death.

Copyright © 2015 Dell Inc. All rights reserved. This product is protected by U.S. and international copyright and intellectual property laws. Dell™ and the Dell logo are trademarks of Dell Inc. in the United States and/or other jurisdictions. All other marks and names mentioned herein may be trademarks of their respective companies.

Contents

Before working inside your computer.....	12
Before you begin	12
Safety instructions.....	12
Recommended tools.....	13
After working inside your tablet.....	14
Removing the base panel.....	15
Procedure.....	15
Replacing the base panel.....	17
Procedure.....	17
Removing the memory modules.....	18
Prerequisites.....	18
Procedure.....	18
Replacing the memory modules.....	20
Procedure.....	20
Post-requisites.....	21
Removing the solid-state drives.....	22
Prerequisites.....	22
Procedure.....	22
Replacing the solid-state drives.....	24
Procedure.....	24
Post-requisites.....	24

Removing the hard drive.....	25
Prerequisites.....	25
Procedure.....	25
Replacing the hard drive.....	28
Procedure.....	28
Post-requisites.....	28
Removing the palm rest.....	29
Prerequisites.....	29
Procedure.....	30
Replacing the palm rest.....	36
Procedure.....	36
Post-requisites.....	36
Removing the power-button board.....	37
Prerequisites.....	37
Procedure.....	37
Replacing the power-button board.....	39
Procedure.....	39
Post-requisites.....	39
Removing the status-light board.....	40
Prerequisites.....	40
Procedure.....	40
Replacing the status-light board.....	42
Procedure.....	42
Post-requisites.....	42

Removing the keyboard.....	43
Prerequisites.....	43
Procedure.....	43
Replacing the keyboard.....	47
Procedure.....	47
Post-requisites.....	47
Removing the touch pad.....	48
Prerequisites.....	48
Procedure.....	49
Replacing the touch pad.....	51
Procedure.....	51
Post-requisites.....	51
Removing the display assembly.....	52
Prerequisites.....	52
Procedure.....	52
Replacing the display assembly.....	56
Procedure.....	56
Post-requisites.....	57
Removing the battery.....	58
Prerequisites.....	58
Procedure.....	58
Replacing the battery.....	61
Procedure.....	61
Post-requisites.....	61

Removing the I/O board.....	62
Prerequisites.....	62
Procedure.....	62
Replacing the I/O board.....	64
Procedure.....	64
Post-requisites.....	64
Removing the speakers.....	65
Prerequisites.....	65
Procedure.....	65
Replacing the speakers.....	68
Procedure.....	68
Post-requisites.....	68
Removing the front AlienFX LED boards.....	69
Prerequisites.....	69
Procedure.....	69
Replacing the front AlienFX LED board.....	71
Procedure.....	71
Post-requisites.....	71
Removing the processor fan.....	72
Prerequisites.....	72
Procedure.....	72
Replacing the processor fan.....	74
Procedure.....	74
Post-requisites.....	74

Removing the system board.....	75
Prerequisites.....	75
Procedure.....	75
Replacing the system board.....	79
Procedure.....	79
Post-requisites.....	79
Removing the wireless card.....	81
Prerequisites.....	81
Procedure.....	81
Replacing the wireless card.....	83
Procedure.....	83
Post-requisites.....	84
Removing the heat sink.....	85
Prerequisites.....	85
Procedure.....	85
Replacing the heat sink.....	87
Procedure.....	87
Post-requisites.....	87
Removing the coin-cell battery.....	88
Prerequisites.....	88
Procedure.....	88
Replacing the coin-cell battery.....	90
Procedure.....	90
Post-requisites.....	90

Removing the video-card fan.....	91
Prerequisites.....	91
Procedure.....	91
Replacing the video-card fan.....	93
Procedure.....	93
Post-requisites.....	93
Removing the power-adapter port.....	94
Prerequisites.....	94
Procedure.....	94
Replacing the power-adapter port.....	96
Procedure.....	96
Post-requisites.....	96
Removing the subwoofer.....	97
Prerequisites.....	97
Procedure.....	97
Replacing the subwoofer.....	99
Procedure.....	99
Post-requisites.....	99
Removing the display bezel.....	100
Prerequisites.....	100
Procedure.....	100
Replacing the display bezel.....	105
Procedure.....	105
Post-requisites.....	105

Removing the display panel.....	106
Prerequisites.....	106
Procedure.....	106
Replacing the display panel.....	109
Procedure.....	109
Post-requisites.....	109
Removing the display hinges.....	110
Prerequisites.....	110
Procedure.....	110
Replacing the display hinges.....	113
Procedure.....	113
Post-requisites.....	113
Removing the computer base.....	114
Prerequisites.....	114
Procedure.....	114
Replacing the computer base.....	116
Procedure.....	116
Post-requisites.....	116
Removing the logo board.....	117
Prerequisites.....	117
Procedure.....	118
Replacing the logo board.....	120
Procedure.....	120
Post-requisites.....	120



Removing the camera.....	121
Prerequisites.....	121
Procedure.....	121
Replacing the camera.....	123
Procedure.....	123
Post-requisites.....	123
Removing the display-panel AlienFX LEDs.....	124
Prerequisites.....	124
Procedure.....	125
Replacing the display-panel AlienFX LEDs.....	127
Procedure.....	127
Post-requisites.....	127
Removing the Alienware AlienHead LED board..	128
Prerequisites.....	128
Procedure.....	128
Replacing the Alienware AlienHead LED board....	131
Procedure.....	131
Post-requisites.....	131
Removing the display back-cover.....	132
Prerequisites.....	132
Procedure.....	132
Replacing the display back-cover.....	135
Procedure.....	135
Post-requisites.....	135

BIOS setup program.....	136
Overview.....	136
Entering BIOS setup program	136
BIOS setup program options.....	136
Boot sequence.....	142
Boot options.....	142
Changing boot sequence for the current boot.....	143
Changing boot sequence for future boots.....	143
Flashing the BIOS.....	144
Getting help and contacting Alienware.....	145
Self-help resources.....	145
Contacting Alienware.....	146

Before working inside your computer

 **NOTE:** The images in this document may differ from your computer depending on the configuration you ordered.

Before you begin

- 1 Save and close all open files and exit all open applications.
- 2 Shut down your computer.
 - Windows 10: Click or tap **Start** →  **Power** → **Shut down**.
 - Windows 8.1: On the **Start** screen, click or tap the power icon  → **Shut down**.
 - Windows 7: Click or tap **Start** → **Shut down**.

 **NOTE:** If you are using a different operating system, see the documentation of your operating system for shut-down instructions.

- 3 Disconnect your computer and all attached devices from their electrical outlets.
- 4 Disconnect all cables such as telephone cables, network cables and so on, from your computer.
- 5 Disconnect all attached devices and peripherals, such as keyboard, mouse, monitor, and so on, from your computer.
- 6 Remove any media card and optical disc from your computer, if applicable.

Safety instructions

Use the following safety guidelines to protect your computer from potential damage and ensure your personal safety.

 **WARNING:** Before working inside your computer, read the safety information that shipped with your computer. For more safety best practices, see the Regulatory Compliance home page at www.dell.com/regulatory_compliance.

 **WARNING:** Disconnect all power sources before opening the computer cover or panels. After you finish working inside the computer, replace all covers, panels, and screws before connecting to the power source.

 **CAUTION:** To avoid damaging the computer, ensure that the work surface is flat and clean.

 **CAUTION:** To avoid damaging the components and cards, handle them by their edges and avoid touching pins and contacts.

 **CAUTION:** You should only perform troubleshooting and repairs as authorized or directed by the Dell technical assistance team. Damage due to servicing that is not authorized by Dell is not covered by your warranty. See the safety instructions that shipped with the product or at www.dell.com/regulatory_compliance.

 **CAUTION:** Before touching anything inside your computer, ground yourself by touching an unpainted metal surface, such as the metal at the back of the computer. While you work, periodically touch an unpainted metal surface to dissipate static electricity, which could harm internal components.

 **CAUTION:** When you disconnect a cable, pull on its connector or on its pull tab, not on the cable itself. Some cables have connectors with locking tabs or thumb-screws that you must disengage before disconnecting the cable. When disconnecting cables, keep them evenly aligned to avoid bending any connector pins. When connecting cables, ensure that the ports and connectors are correctly oriented and aligned.

 **CAUTION:** Press and eject any installed card from the media-card reader.

Recommended tools

The procedures in this document may require the following tools:

- Phillips screwdriver
- Plastic scribe

After working inside your tablet



CAUTION: Leaving stray or loose screws inside your computer may severely damage your computer.

- 1** Replace all screws and ensure that no stray screws remain inside your tablet.
- 2** Connect any external devices, peripherals, and cables you removed before working on your tablet.
- 3** Replace any media cards, discs, and any other parts that you removed before working on your tablet.
- 4** Connect your tablet and all attached devices to their electrical outlets.
- 5** Turn on your tablet.

Removing the base panel

⚠ WARNING: Before working inside your computer, read the safety information that shipped with your computer and follow the steps in [Before working inside your computer](#). After working inside your computer, follow the instructions in [After working inside your computer](#). For more safety best practices, see the Regulatory Compliance home page at www.dell.com/regulatory_compliance.

Procedure

- 1 Close the display and turn the computer over.
- 2 Loosen the captive screws that secure the base panel to the computer base.
- 3 Gently release the tabs that secure the base panel to the computer base.
- 4 Slide and remove the base panel from the computer base.

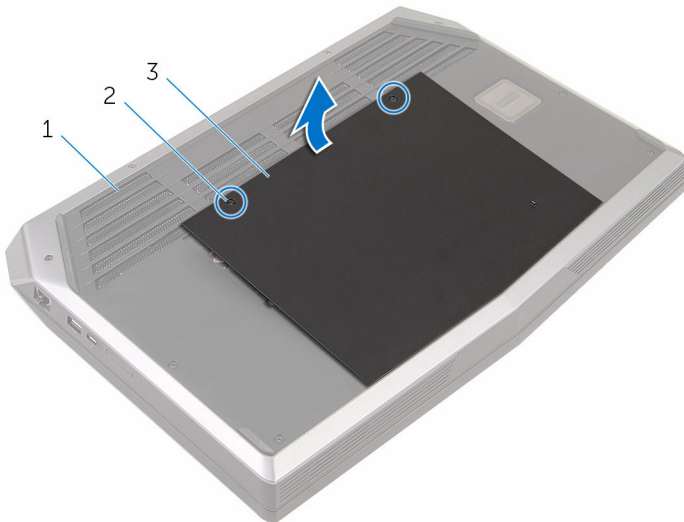

- 1 computer base
- 2 captive screws (2)
- 3 base panel

- 5 Disconnect the battery cable from the system board.

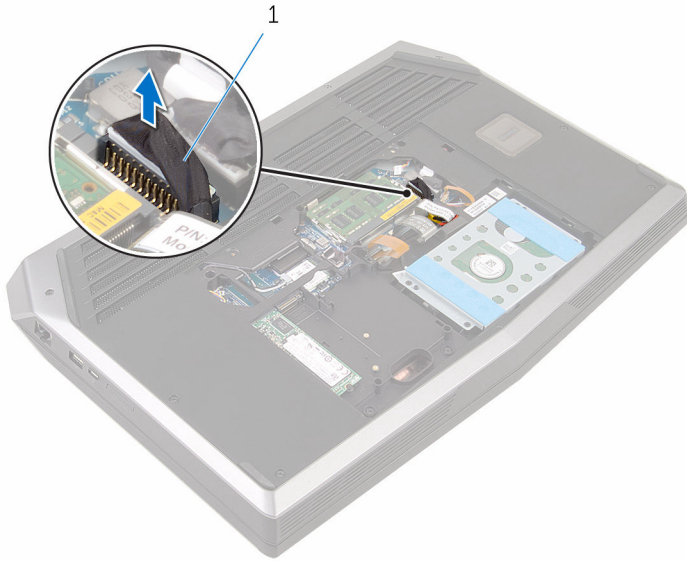

1 battery cable

- 6 Turn the computer over.
- 7 Press and hold the power button for 5 seconds to ground the system board.

Replacing the base panel



WARNING: Before working inside your computer, read the safety information that shipped with your computer and follow the steps in [Before working inside your computer](#). After working inside your computer, follow the instructions in [After working inside your computer](#). For more safety best practices, see the Regulatory Compliance home page at www.dell.com/regulatory_compliance.

Procedure

- 1 Connect the battery cable to the system board.
- 2 Slide the tabs on the base panel into the slots on the computer base and snap the base panel into place.
- 3 Tighten the captive screws that secure the base panel to the computer base.

Removing the memory modules



WARNING: Before working inside your computer, read the safety information that shipped with your computer and follow the steps in [Before working inside your computer](#). After working inside your computer, follow the instructions in [After working inside your computer](#). For more safety best practices, see the Regulatory Compliance home page at www.dell.com/regulatory_compliance.

Prerequisites

Remove the [base panel](#).

Procedure

- 1 Using your fingertips, carefully spread apart the securing clips on each end of the memory-module slot until the memory module pops up.

2 Slide and remove the memory module from the memory-module slot.

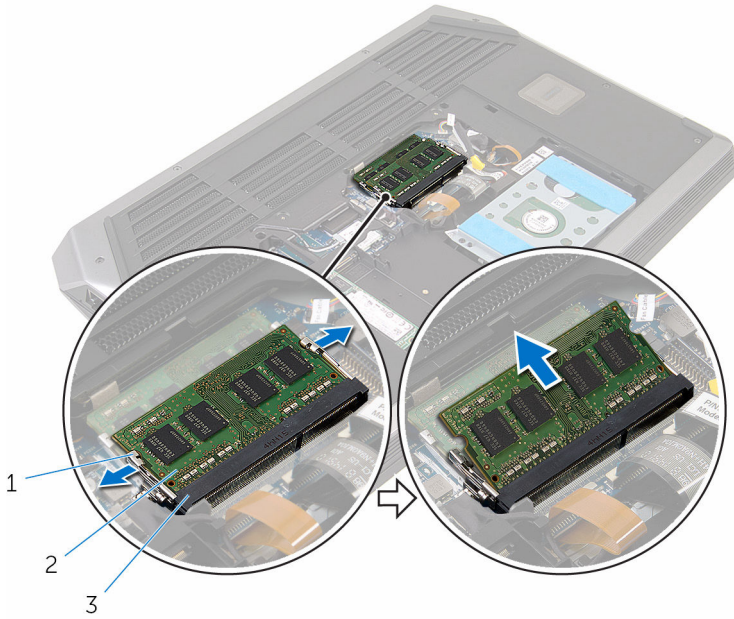

1 securing clips (2)

2 memory modules (2)

3 memory-module slot

Replacing the memory modules



WARNING: Before working inside your computer, read the safety information that shipped with your computer and follow the steps in [Before working inside your computer](#). After working inside your computer, follow the instructions in [After working inside your computer](#). For more safety best practices, see the Regulatory Compliance home page at www.dell.com/regulatory_compliance.

Procedure

- 1 Align the notch on the memory module with the tab on the memory-module slot.

- Slide the memory module firmly into the slot at an angle and press the memory module down until it clicks into place.

 **NOTE:** If you do not hear the click, remove the memory module and reinstall it.

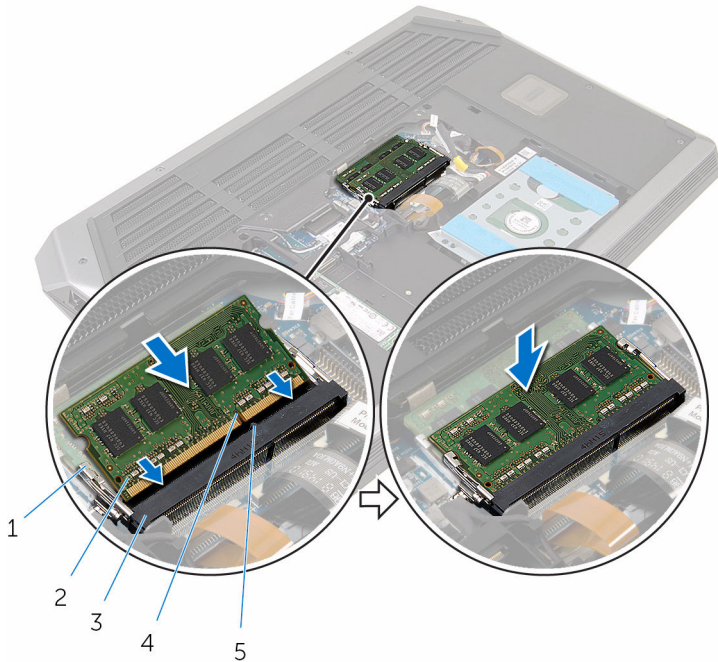



- securing clips (2)
- memory module
- memory-module slot
- notch
- tab

- memory module
- notch

Post-requisites

Replace the [base panel](#).

Removing the solid-state drives

-  **WARNING:** Before working inside your computer, read the safety information that shipped with your computer and follow the steps in [Before working inside your computer](#). After working inside your computer, follow the instructions in [After working inside your computer](#). For more safety best practices, see the Regulatory Compliance home page at www.dell.com/regulatory_compliance.
-  **CAUTION:** Solid-state drives are fragile. Exercise care when handling the hard drive.
-  **CAUTION:** To avoid data loss, do not remove the solid-state drive while the computer is in sleep or on state.

Prerequisites

Remove the [base panel](#).

Procedure

-  **NOTE:** Your computer can accommodate either one 2.5-inch hard drive or two solid-state drives.
- 1 Remove the screw that secures the solid-state drive to the computer base.

2 Slide and remove the solid-state drive from the solid-state drive slot.

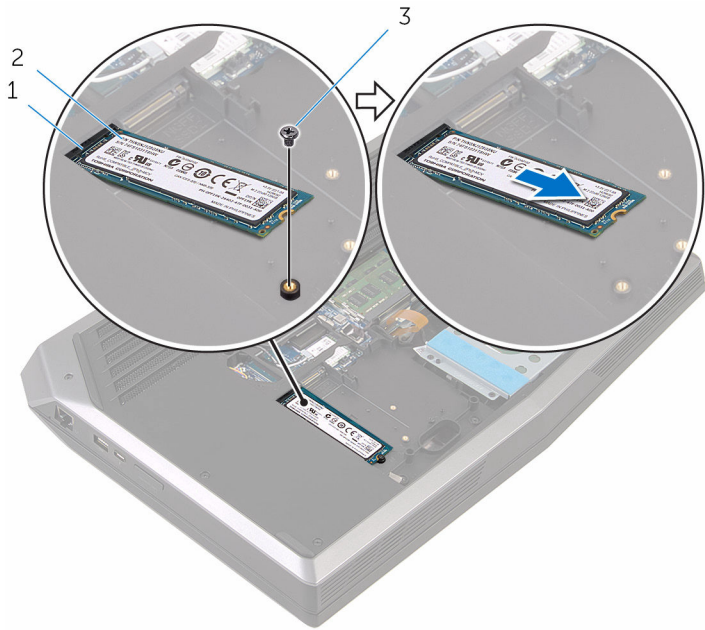

1 solid-state drive slot

2 solid-state drive

3 screw

Replacing the solid-state drives

 **WARNING:** Before working inside your computer, read the safety information that shipped with your computer and follow the steps in [Before working inside your computer](#). After working inside your computer, follow the instructions in [After working inside your computer](#). For more safety best practices, see the Regulatory Compliance home page at www.dell.com/regulatory_compliance.

 **CAUTION:** Solid-state drives are fragile. Exercise care when handling the hard drive.

Procedure

- 1 Slide the solid-state drive into the solid-state drive slot.
- 2 Replace the screw that secures the solid-state drive to the computer base.

Post-requisites

Replace the [base panel](#).

Removing the hard drive

 **WARNING:** Before working inside your computer, read the safety information that shipped with your computer and follow the steps in [Before working inside your computer](#). After working inside your computer, follow the instructions in [After working inside your computer](#). For more safety best practices, see the Regulatory Compliance home page at www.dell.com/regulatory_compliance.

 **CAUTION:** Hard drives are fragile. Exercise care when handling the hard drive.

 **CAUTION:** To avoid data loss, do not remove the hard drive while the computer is in sleep or on state.

Prerequisites

Remove the [base panel](#).

Procedure

 **NOTE:** Your computer can accommodate either one 2.5-inch hard drive or four solid-state drives.

- 1 Using the pull tab, disconnect the hard-drive cable from the system board.
- 2 Note the hard-drive cable routing and remove the cable from the routing guides on the computer base.
- 3 Remove the screws that secure the hard-drive assembly to the computer base.

- 4** Lift the hard-drive assembly off the computer base.

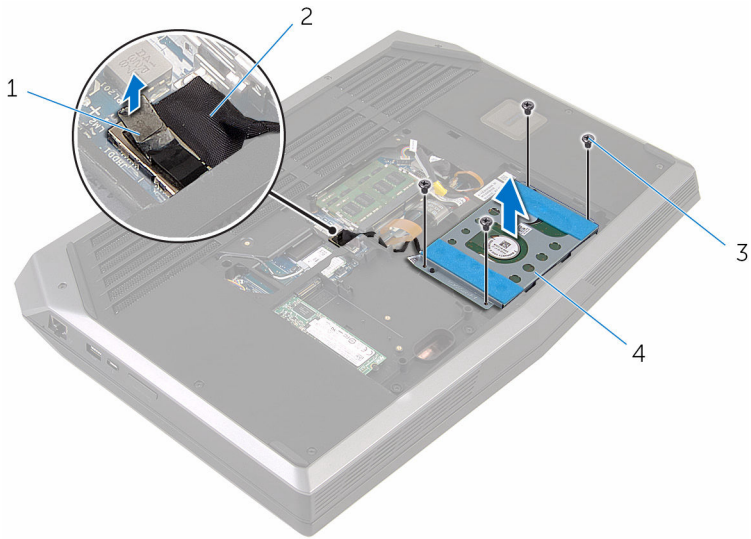

- | | | | |
|---|------------|---|---------------------|
| 1 | pull tab | 2 | hard-drive cable |
| 3 | screws (4) | 4 | hard-drive assembly |

- 5** Remove the screws that secure the hard-drive bracket to the hard drive.
6 Lift the hard-drive bracket off the hard-drive assembly.

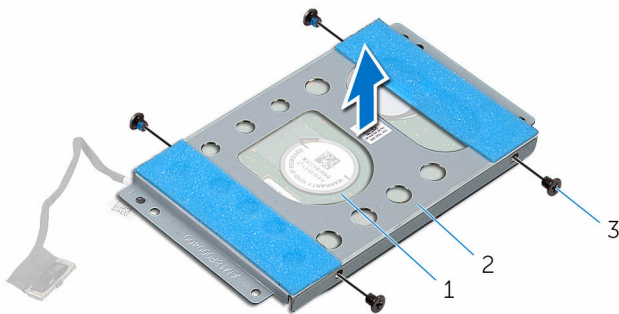

- | | | | |
|---|------------|---|--------------------|
| 1 | hard drive | 2 | hard-drive bracket |
| 3 | screws (4) | | |

7 Disconnect the interposer from the hard drive.

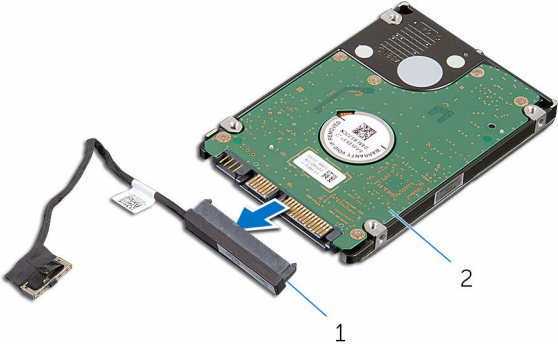

1 interposer

2 hard drive

Replacing the hard drive

 **WARNING:** Before working inside your computer, read the safety information that shipped with your computer and follow the steps in [Before working inside your computer](#). After working inside your computer, follow the instructions in [After working inside your computer](#). For more safety best practices, see the Regulatory Compliance home page at www.dell.com/regulatory_compliance.

 **CAUTION:** Hard drives are fragile. Exercise care when handling the hard drive.

Procedure

- 1 Connect the interposer to the hard drive.
- 2 Align the screw holes on the hard-drive bracket with the screw holes on the hard-drive assembly.
- 3 Replace the screws that secure the hard-drive bracket to the hard-drive assembly.
- 4 Align the screw holes on the hard-drive assembly with the screw holes on the computer base.
- 5 Replace the screws that secure the hard-drive assembly to the computer base.
- 6 Route the hard-drive cable through the routing guides on the computer base.
- 7 Connect the hard-drive cable to the system board.

Post-requisites

Replace the [base panel](#).

Removing the palm rest



WARNING: Before working inside your computer, read the safety information that shipped with your computer and follow the steps in [Before working inside your computer](#). After working inside your computer, follow the instructions in [After working inside your computer](#). For more safety best practices, see the Regulatory Compliance home page at www.dell.com/regulatory_compliance.

Prerequisites

Remove the [base panel](#).

Procedure

- 1 Lift the latches and disconnect the keyboard cable, keyboard-backlight cable and macro-keys cable and macro-keys backlight cable from the system board.

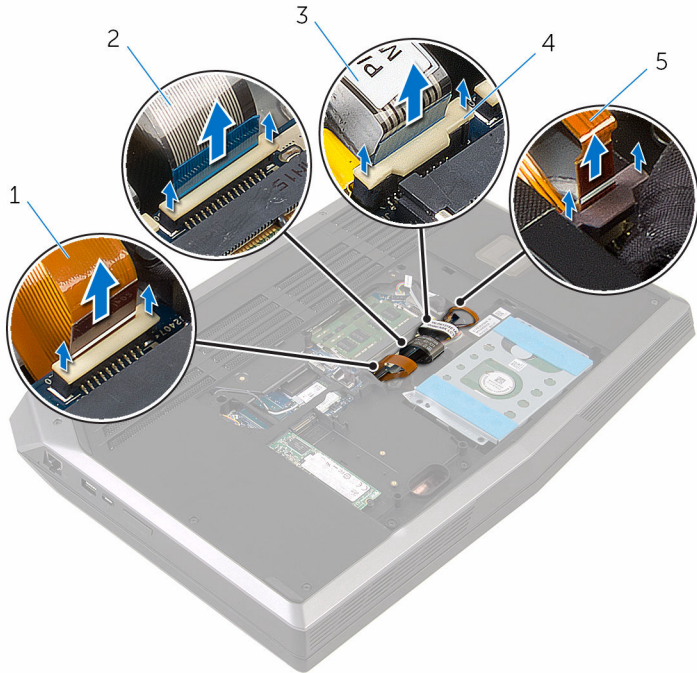

- | | | | |
|---|----------------------------|---|----------------|
| 1 | keyboard-backlight cable | 2 | keyboard cable |
| 3 | macro-keys cable | 4 | latches (4) |
| 5 | macro-keys backlight cable | | |

- 2** Remove the screws that secure the palm-rest assembly to the computer base.

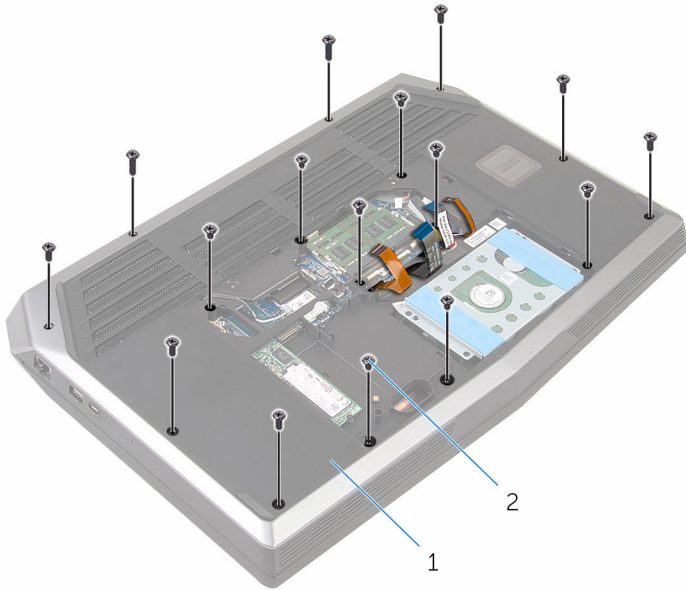

1 computer base

2 screws (16)

- 3** Lift the computer base slightly and push the palm-rest assembly through the slot on the computer base to release the tabs on the palm-rest assembly.

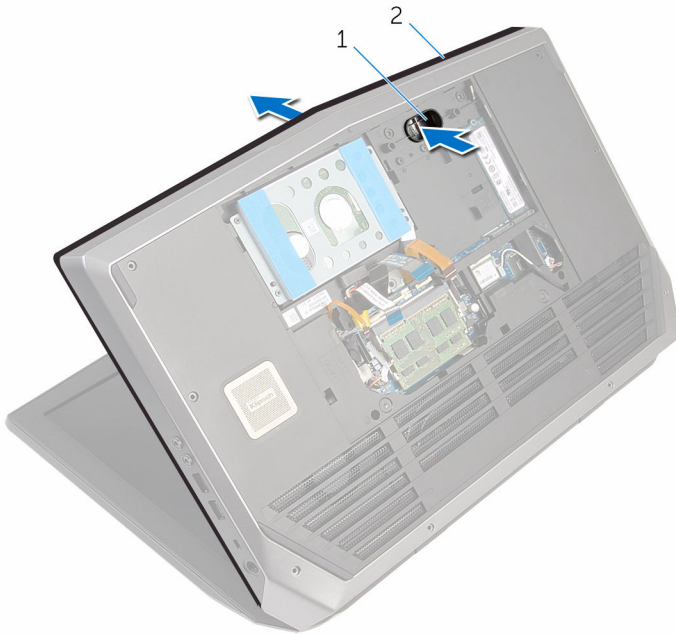

1 slot

2 palm-rest assembly

- 4** Turn the computer over and open the display as far as possible.
- 5** Using a plastic scribe, pry up along the edges of the palm-rest assembly.

- 6** Gently lift the palm-rest assembly and turn it over.

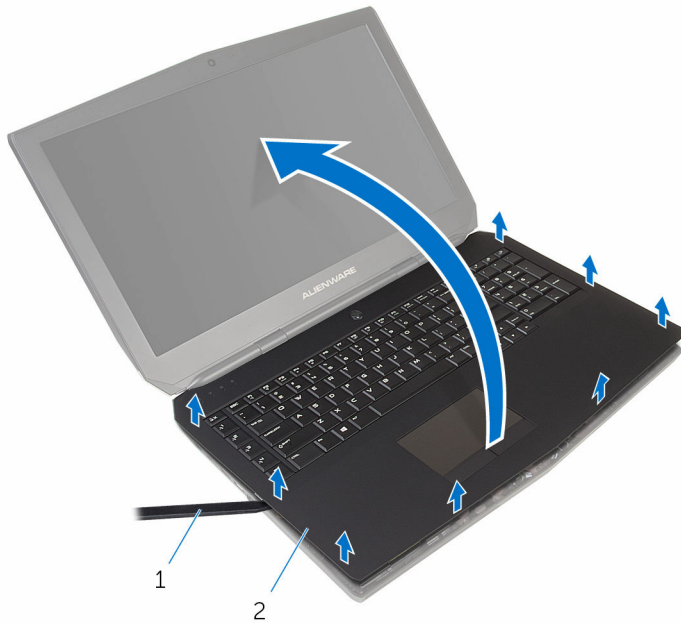

1 plastic scribe

2 palm-rest assembly

- 7** Peel the tape that secures the power-button board cable to the system board.
- 8** Disconnect the power-button board cable from the system board.

9 Lift the palm-rest assembly off the computer base.

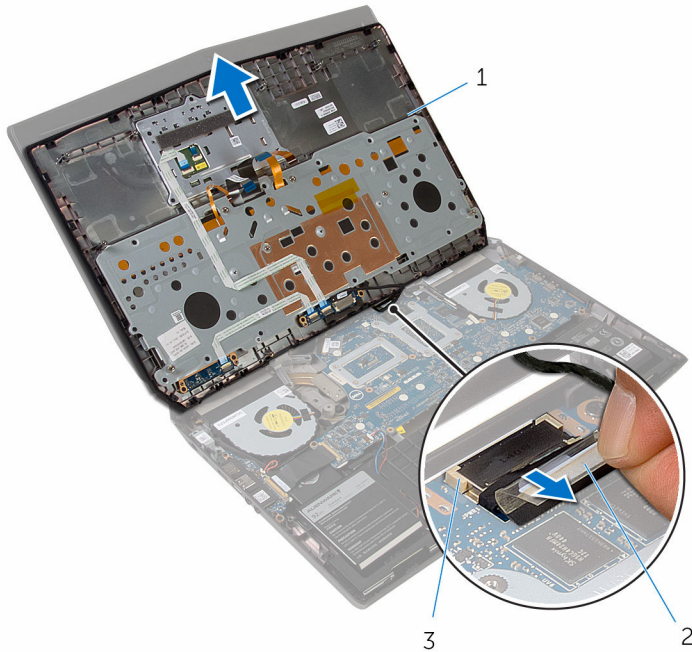

1 palm-rest assembly

2 power-button board cable

3 latch

10 Remove the [power-button board](#).

11 Remove the [status-light board](#).

12 Remove the [keyboard](#).

13 Remove the [touch pad](#).

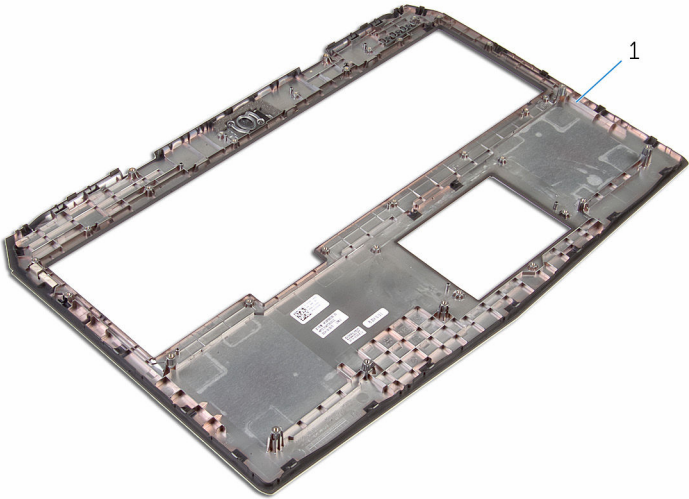

1 palm rest

Replacing the palm rest



WARNING: Before working inside your computer, read the safety information that shipped with your computer and follow the steps in [Before working inside your computer](#). After working inside your computer, follow the instructions in [After working inside your computer](#). For more safety best practices, see the Regulatory Compliance home page at www.dell.com/regulatory_compliance.

Procedure

- 1 Replace the [touch pad](#).
- 2 Replace the [keyboard](#).
- 3 Replace the [status-light board](#).
- 4 Replace the [power-button board](#).
- 5 Connect the power-button board cable to the system board.
- 6 Adhere the tape that secures the power-button board cable to the system board.
- 7 Slide the keyboard cable, keyboard-backlight cable, macro-keys cable, and macro-keys backlight cable through the slot on the computer base.
- 8 Align the palm-rest assembly on the computer base and snap it into place.
- 9 Close the display and turn the computer over.
- 10 Replace the screws that secure the palm-rest assembly to the computer base.
- 11 Slide the keyboard cable, keyboard-backlight cable, macro-keys cable and macro-keys backlight cable into their respective connectors and press down the latches to secure the cables to the system board.

Post-requisites

Replace the [base panel](#).

Removing the power-button board



WARNING: Before working inside your computer, read the safety information that shipped with your computer and follow the steps in [Before working inside your computer](#). After working inside your computer, follow the instructions in [After working inside your computer](#). For more safety best practices, see the Regulatory Compliance home page at www.dell.com/regulatory_compliance.

Prerequisites

- 1 Remove the [base panel](#).
- 2 Follow the procedure from step 1 to step 9 in "Removing the [palm rest](#)".

Procedure

- 1 Lift the latches and disconnect the touch-pad cable and the status-light cable from the power-button board.
- 2 Disconnect the power-button board cable from the power-button board.
- 3 Remove the screws that secure the power-button board to the palm-rest assembly.

4 Lift the power-button board off the palm-rest assembly.

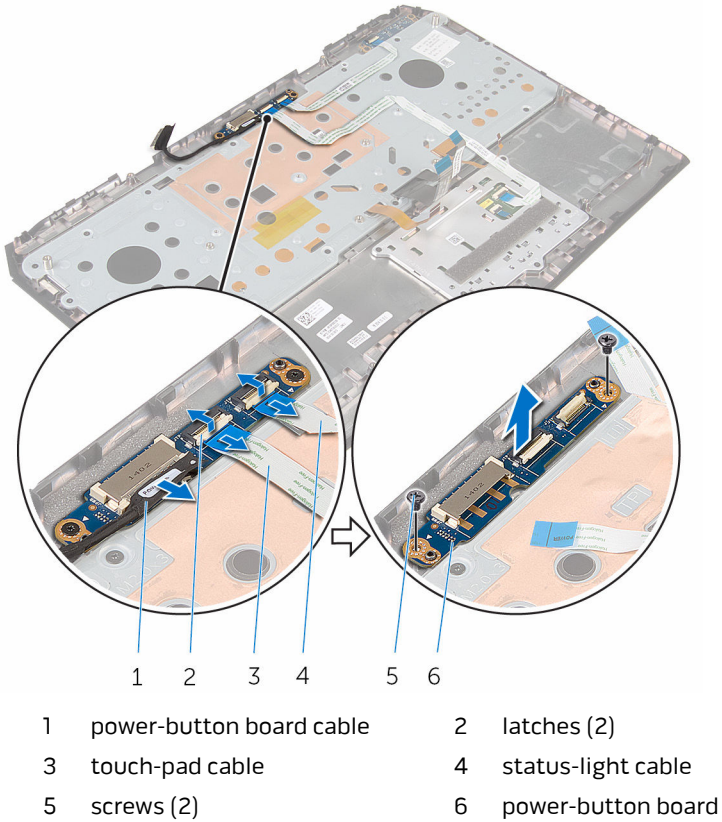

Replacing the power-button board



WARNING: Before working inside your computer, read the safety information that shipped with your computer and follow the steps in [Before working inside your computer](#). After working inside your computer, follow the instructions in [After working inside your computer](#). For more safety best practices, see the Regulatory Compliance home page at www.dell.com/regulatory_compliance.

Procedure

- 1 Align the screw holes on the power-button board with the screw holes on the palm-rest assembly.
- 2 Replace the screws that secure the power-button board to the palm-rest assembly.
- 3 Connect the power-button board cable to the power-button board.
- 4 Slide the touch-pad cable and the status-light cable into their respective connectors on the power-button board and press down the latches to secure the cables.

Post-requisites

- 1 Follow the procedure from step 5 to step 11 in “Replacing the [palm rest](#)”.
- 2 Replace the [base panel](#).

Removing the status-light board



WARNING: Before working inside your computer, read the safety information that shipped with your computer and follow the steps in [Before working inside your computer](#). After working inside your computer, follow the instructions in [After working inside your computer](#). For more safety best practices, see the Regulatory Compliance home page at www.dell.com/regulatory_compliance.

Prerequisites

- 1 Remove the [base panel](#).
- 2 Follow the procedure from step 1 to step 9 in "Removing the [palm rest](#)".

Procedure

- 1 Lift the latch and disconnect the status-light board cable from the status-light board.
- 2 Remove the screws that secure the status-light board to the palm-rest assembly.

3 Lift the status-light board off the palm-rest assembly.

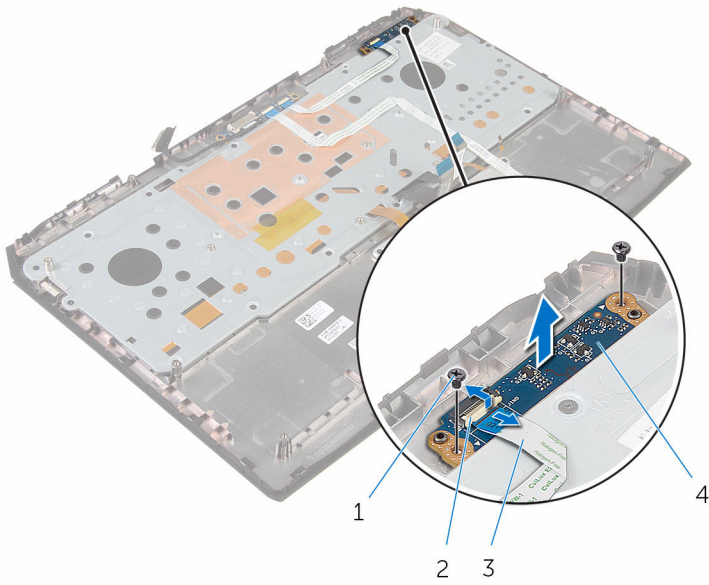

1 screws (2)

3 status-light board cable

2 latch

4 status-light board

Replacing the status-light board



WARNING: Before working inside your computer, read the safety information that shipped with your computer and follow the steps in [Before working inside your computer](#). After working inside your computer, follow the instructions in [After working inside your computer](#). For more safety best practices, see the Regulatory Compliance home page at www.dell.com/regulatory_compliance.

Procedure

- 1 Align the screw holes on the status-light board with the screw holes on the palm-rest assembly.
- 2 Replace the screws that secure the status-light board to the palm-rest assembly.
- 3 Slide the status-light board cable into the connector on the status-light board and press down the latch to secure the cable.

Post-requisites

- 1 Follow the procedure from step 5 to step 11 in “Replacing the [palm rest](#)”.
- 2 Replace the [base panel](#).

Removing the keyboard



WARNING: Before working inside your computer, read the safety information that shipped with your computer and follow the steps in [Before working inside your computer](#). After working inside your computer, follow the instructions in [After working inside your computer](#). For more safety best practices, see the Regulatory Compliance home page at www.dell.com/regulatory_compliance.

Prerequisites

- 1 Remove the [base panel](#).
- 2 Follow the procedure from step 1 to step 9 in "Removing the [palm rest](#)".

Procedure

- 1 Lift the latches and disconnect the touch-pad cable and the status-light cable from the power-button board.

- 2** Note the touch-pad cable and status-light cable routing and peel off the cables from the keyboard bracket.

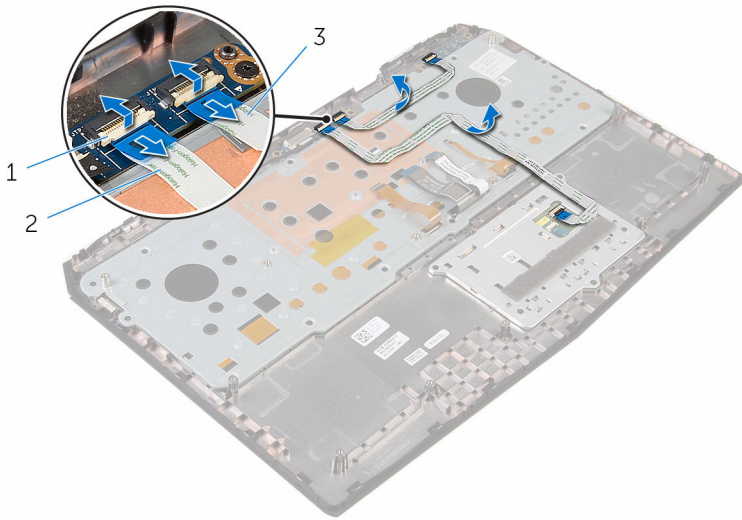

1 latches (2)

2 touch-pad cable

3 status-light cable

- 3** Remove the screws that secure the keyboard bracket to the palm-rest assembly.
- 4** Slide the keyboard cable, keyboard-backlight cable, macro-keys cable and macro-keys backlight cable through the slot on the keyboard bracket.

- 5** Lift the keyboard bracket off the palm-rest assembly.

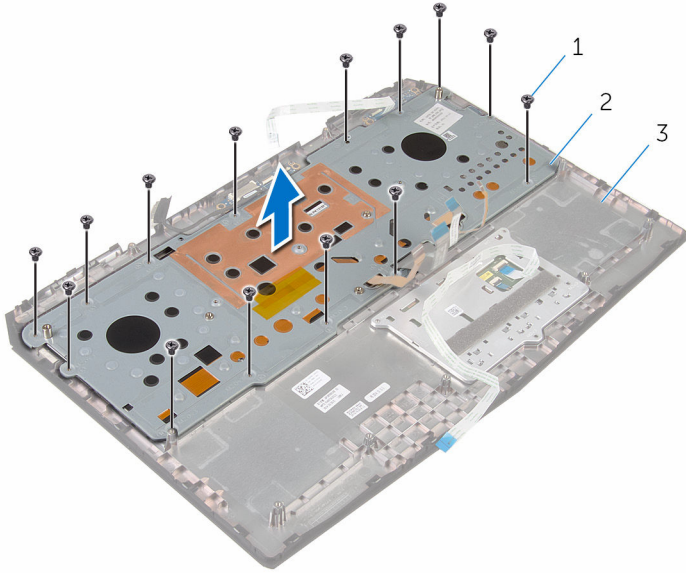

1 screws (14)

2 keyboard bracket

3 palm-rest assembly

- 6** Remove the screws that secure the keyboard to the palm-rest assembly.
7 Release the tabs that secure the keyboard to the palm-rest assembly.

- 8** Slide and lift the keyboard along with the cables off the palm-rest assembly.

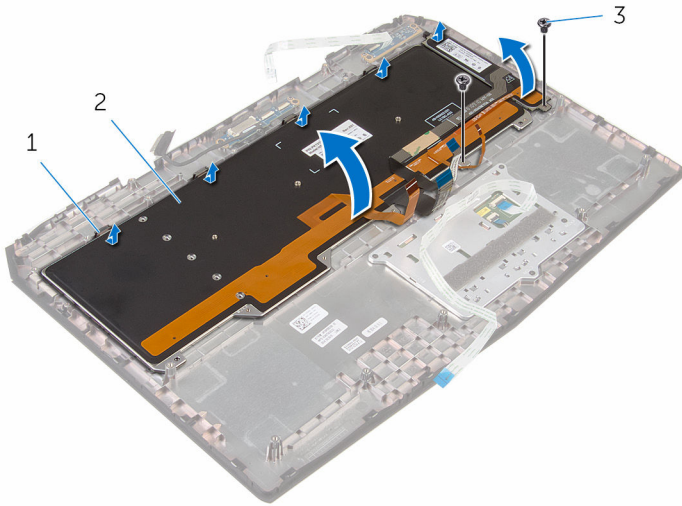

1 tabs (5)

2 keyboard

3 screws (2)

Replacing the keyboard



WARNING: Before working inside your computer, read the safety information that shipped with your computer and follow the steps in [Before working inside your computer](#). After working inside your computer, follow the instructions in [After working inside your computer](#). For more safety best practices, see the Regulatory Compliance home page at www.dell.com/regulatory_compliance.

Procedure

- 1 Slide the keyboard under the tabs on the palm-rest assembly.
- 2 Align the screw holes on the keyboard with the screw holes on the palm-rest assembly.
- 3 Replace the screws that secure the keyboard to the palm-rest assembly.
- 4 Route the keyboard cable, keyboard-backlight cable, macro-keys cable and macro-keys backlight cable through the slots on the keyboard bracket.
- 5 Align the screw holes on the keyboard bracket with the screw holes on the palm-rest assembly.
- 6 Replace the screws that secure the keyboard bracket to the palm-rest assembly.
- 7 Adhere the touch-pad cable and status-light cable to the keyboard bracket.
- 8 Slide the touch-pad cable and the status-light cable into their respective connectors on the power-button board and press down the latches to secure the cables.

Post-requisites

- 1 Follow the procedure from step 5 to step 11 in “Replacing the [palm rest](#)”.
- 2 Replace the [base panel](#).

Removing the touch pad



WARNING: Before working inside your computer, read the safety information that shipped with your computer and follow the steps in [Before working inside your computer](#). After working inside your computer, follow the instructions in [After working inside your computer](#). For more safety best practices, see the Regulatory Compliance home page at www.dell.com/regulatory_compliance.

Prerequisites

- 1 Remove the [base panel](#).
- 2 Follow the procedure from step 1 to step 9 in "Removing the [palm rest](#)".

Procedure

- 1 Lift the latches and disconnect the touch-pad cable and touch-pad button cable from the touch pad.

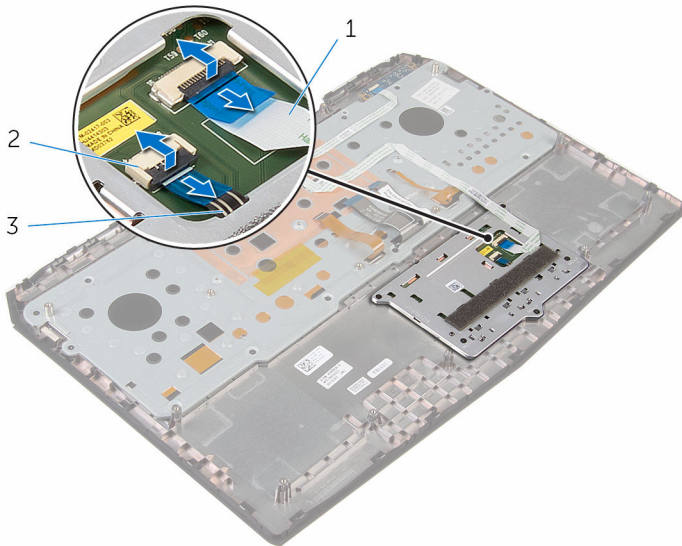

- | | | | |
|---|------------------------|---|-------------|
| 1 | touch-pad cable | 2 | latches (2) |
| 3 | touch-pad button cable | | |

- 2 Remove the screws that secure the touch-pad button bracket to the palm-rest assembly.

- 3** Lift the touch-pad button bracket off the palm-rest assembly.

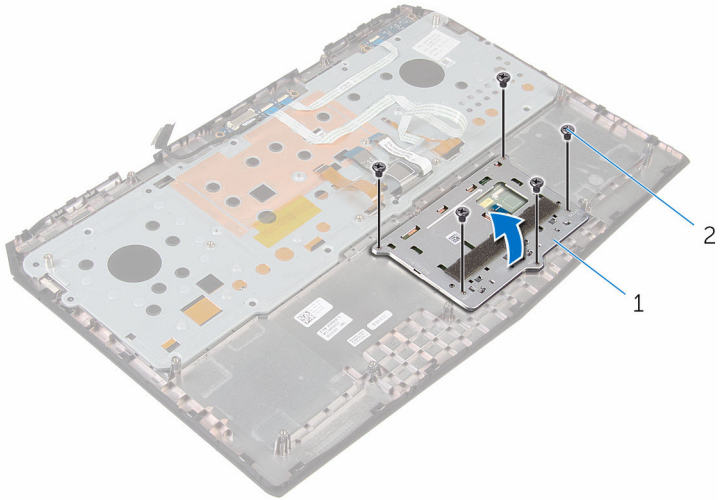

- 1 touch-pad button bracket 2 screws (5)

- 4** Lift the touch pad off the palm-rest assembly.

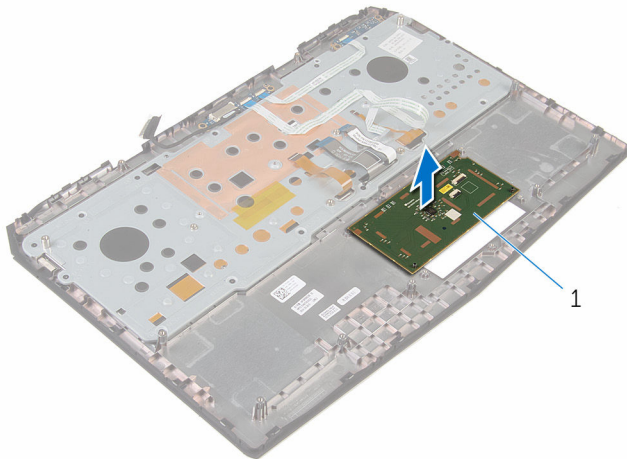

- 1 touch pad

Replacing the touch pad



WARNING: Before working inside your computer, read the safety information that shipped with your computer and follow the steps in [Before working inside your computer](#). After working inside your computer, follow the instructions in [After working inside your computer](#). For more safety best practices, see the Regulatory Compliance home page at www.dell.com/regulatory_compliance.

Procedure

- 1 Using the alignment posts on the palm-rest assembly, place the touch pad on the palm-rest assembly.
- 2 Slide the touch-pad button cable into the touch-pad button connector and press down the latch to secure the cable.
- 3 Align the screw holes on the touch-pad button bracket with the screw holes on the palm-rest assembly.
- 4 Replace the screws that secure the touch-pad button bracket to the palm-rest assembly.
- 5 Slide the touch-pad cable into the touch-pad connector and press down the latch to secure the cable.

Post-requisites

- 1 Follow the procedure from step 5 to step 11 in "Replacing the [palm rest](#)".
- 2 Replace the [base panel](#).

Removing the display assembly



WARNING: Before working inside your computer, read the safety information that shipped with your computer and follow the steps in [Before working inside your computer](#). After working inside your computer, follow the instructions in [After working inside your computer](#). For more safety best practices, see the Regulatory Compliance home page at www.dell.com/regulatory_compliance.

Prerequisites

- 1 Remove the [base panel](#).
- 2 Follow the procedure from step 1 to step 9 in "Removing the [palm rest](#)".

Procedure

- 1 Close the display and turn the computer over.
- 2 Remove the screws that secure the display assembly to the computer base.
- 3 Remove the screw that secures the wireless-card bracket and the wireless card to the system board.
- 4 Lift the wireless-card bracket off the wireless card.

- 5** Disconnect the antenna cables from the wireless card.

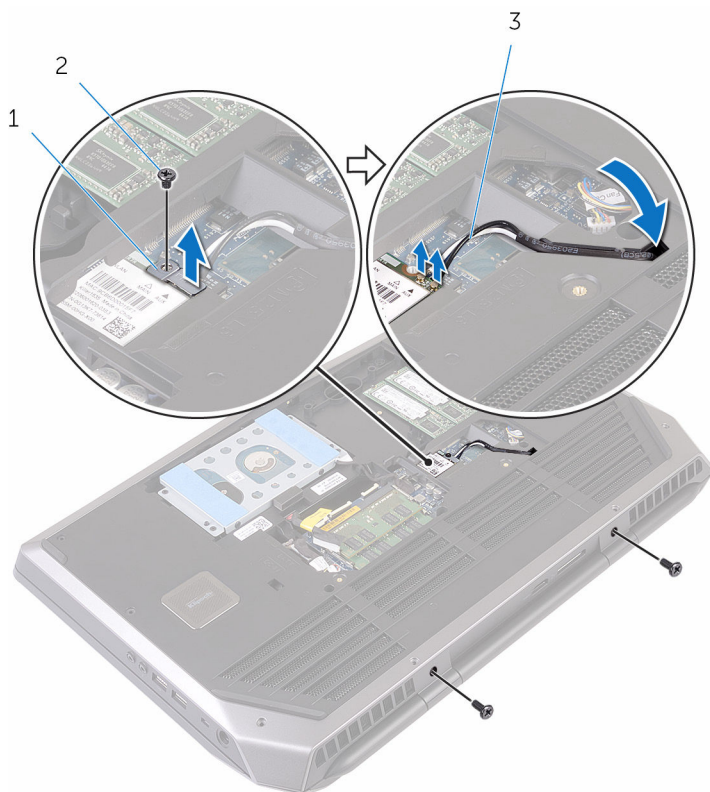

- 1 wireless-card bracket 2 screws (3)
3 antenna cables

- 6** Turn the computer over and open the display.
7 Peel off the adhesive tape that secures the antenna cables to the system board.
8 Carefully remove the antenna cables up from the computer base and remove it from the routing guides on the display hinges.
9 Lift the latch and disconnect the display cable from the system board.
10 Remove the display cable from the routing guide on the display hinge.

11 Disconnect the logo-board cable from the system board and remove it from the routing guide on the display hinge.

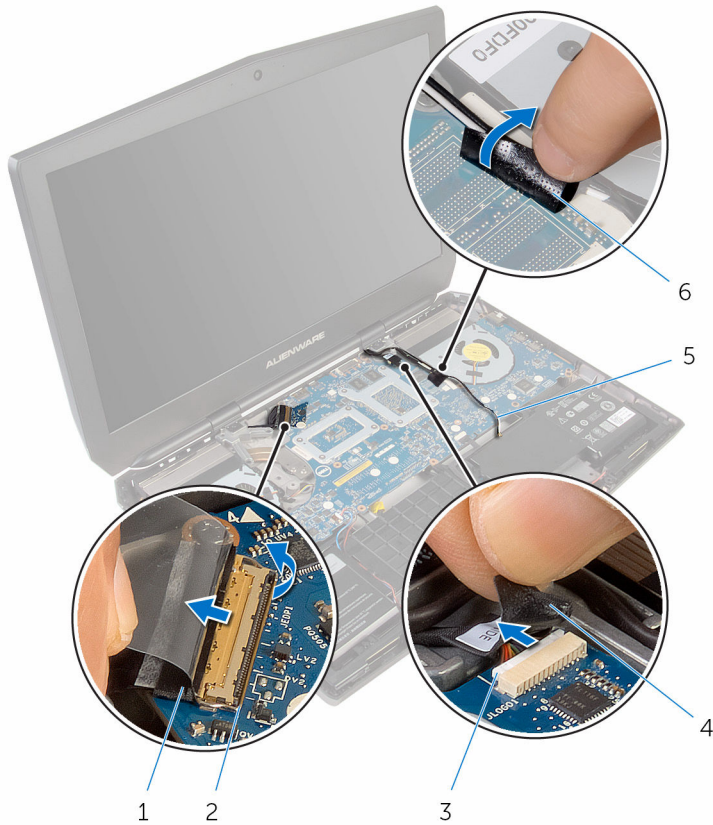

- | | | | |
|---|----------------|---|------------------|
| 1 | display cable | 2 | latch |
| 3 | connector | 4 | logo-board cable |
| 5 | antenna cables | 6 | tape |

12 Remove the screws that secure the display assembly to the computer base.

13 Lift the display assembly off the computer base.

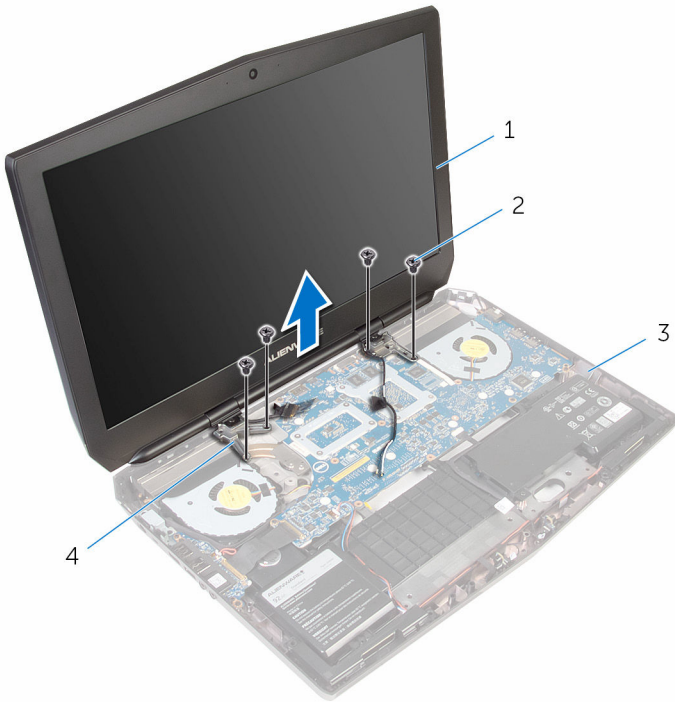

1 display assembly

2 screws (4)

3 computer base

4 display hinges (2)

Replacing the display assembly



WARNING: Before working inside your computer, read the safety information that shipped with your computer and follow the steps in [Before working inside your computer](#). After working inside your computer, follow the instructions in [After working inside your computer](#). For more safety best practices, see the Regulatory Compliance home page at www.dell.com/regulatory_compliance.

Procedure

- 1 Align the screw holes on the display hinges with the screw holes on the computer base.
- 2 Replace the screws that secure the display assembly to the computer base.
- 3 Route the logo-board cable through the routing guide on the display hinge and connect the logo-board cable to the system board.
- 4 Route the display cable through the routing guide on the display hinge.
- 5 Slide the display cable into the connector on the system board and press down on the latch to secure the cable.
- 6 Route the antenna cables through the routing guide on the display hinge and on the computer base.
- 7 Connect the antenna cables to the wireless card.

The following table provides the antenna-cable color scheme for the wireless card supported by your computer.

Connectors on the wireless card	Antenna-cable color
Main (white triangle)	White
Auxiliary (black triangle)	Black

- 8 Align the screw hole on the wireless-card bracket with the screw hole on the wireless card.
- 9 Replace the screw that secures the wireless-card bracket with the wireless card.
- 10 Close the display and turn the computer over.

- 11 Replace the screws that secure the display assembly to the computer base.

Post-requisites

- 1 Follow the procedure from step 5 to step 11 in “Replacing the [palm rest](#)”.
- 2 Replace the [base panel](#).

Removing the battery



WARNING: Before working inside your computer, read the safety information that shipped with your computer and follow the steps in [Before working inside your computer](#). After working inside your computer, follow the instructions in [After working inside your computer](#). For more safety best practices, see the Regulatory Compliance home page at www.dell.com/regulatory_compliance.

Prerequisites

- 1 Remove the [base panel](#).
- 2 Follow the procedure from step 1 to step 9 in “Removing the [palm rest](#)”.

Procedure

- 1 Disconnect the speaker cable and front AlienFX LED cable from the system board.
- 2 Remove the speaker cable from the routing guides on the battery.

- 3 Note the front AlienFX LED cable routing and peel off the cable from the battery.



- | | | | |
|---|-------------------------|---|---------------|
| 1 | system board | 2 | speaker cable |
| 3 | front AlienFX LED cable | | |

- 4 Remove the battery cable from the slot on the computer base.
- 5 Remove the screws that secure the battery to the computer base.

6 Lift the battery off the computer base.

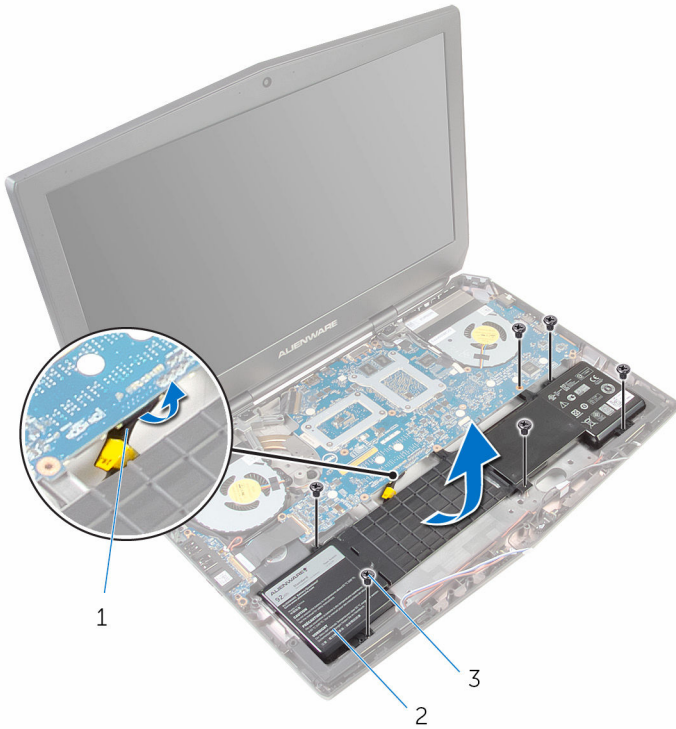

- 1 battery cable
- 2 battery
- 3 screws (6)

Replacing the battery



WARNING: Before working inside your computer, read the safety information that shipped with your computer and follow the steps in [Before working inside your computer](#). After working inside your computer, follow the instructions in [After working inside your computer](#). For more safety best practices, see the Regulatory Compliance home page at www.dell.com/regulatory_compliance.

Procedure

- 1 Align the screw holes on the battery with the screw holes on the computer base.
- 2 Replace the screws that secure the battery to the computer base.
- 3 Slide the battery cable through the slot on the computer base.
- 4 Adhere the front AlienFX LED cable to the battery.
- 5 Route the speaker cable through the routing guides on the battery.
- 6 Connect the speaker cable and front AlienFX LED cable to the system board.

Post-requisites

- 1 Follow the procedure from step 5 to step 11 in "Replacing the [palm rest](#)".
- 2 Replace the [base panel](#).

Removing the I/O board



WARNING: Before working inside your computer, read the safety information that shipped with your computer and follow the steps in [Before working inside your computer](#). After working inside your computer, follow the instructions in [After working inside your computer](#). For more safety best practices, see the Regulatory Compliance home page at www.dell.com/regulatory_compliance.

Prerequisites

- 1 Remove the [base panel](#).
- 2 Follow the procedure from step 1 to step 9 in “Removing the [palm rest](#)”.

Procedure

- 1 Disconnect the subwoofer cable from the I/O board.
- 2 Lift the latch and disconnect the I/O-board cable from the I/O board.
- 3 Remove the screws that secure the I/O board to the computer base.
- 4 Gently tilt and lift to release the I/O ports from the computer base.

5 Lift the I/O board off the computer base.

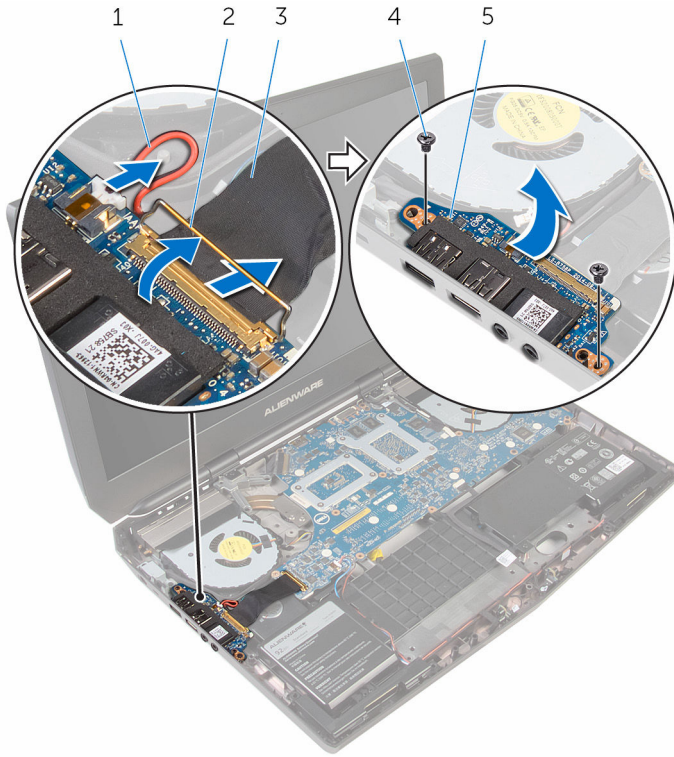

- 1 subwoofer cable
- 3 I/O-board cable
- 5 I/O board

- 2 latch
- 4 screws (2)

Replacing the I/O board



WARNING: Before working inside your computer, read the safety information that shipped with your computer and follow the steps in [Before working inside your computer](#). After working inside your computer, follow the instructions in [After working inside your computer](#). For more safety best practices, see the Regulatory Compliance home page at www.dell.com/regulatory_compliance.

Procedure

- 1 Align the ports on the I/O board with the slots on the computer base.
- 2 Align the screw holes on the I/O board with the screw holes on the computer base.
- 3 Replace the screws that secure the I/O board to the computer base.
- 4 Connect the I/O-board cable to the I/O board.
- 5 Connect the subwoofer cable to the I/O board.

Post-requisites

- 1 Follow the procedure from step 5 to step 11 in “Replacing the [palm rest](#)”.
- 2 Replace the [base panel](#).

Removing the speakers



WARNING: Before working inside your computer, read the safety information that shipped with your computer and follow the steps in [Before working inside your computer](#). After working inside your computer, follow the instructions in [After working inside your computer](#). For more safety best practices, see the Regulatory Compliance home page at www.dell.com/regulatory_compliance.

Prerequisites

- 1 Remove the [base panel](#).
- 2 Follow the procedure from step 1 to step 9 in "Removing the [palm rest](#)".

Procedure

- 1 Disconnect the front AlienFX LED cable from the system board.

-
- 2** Note the front AlienFX LED cable routing and peel off the cable from the battery.



1 connector

2 front AlienFX LED cable

-
-
- 3** Disconnect the speaker cable from the system board.
- 4** Remove the speaker cable from the routing guides on the battery and computer base.

- 5 Lift the speakers along with its cable off the computer base.

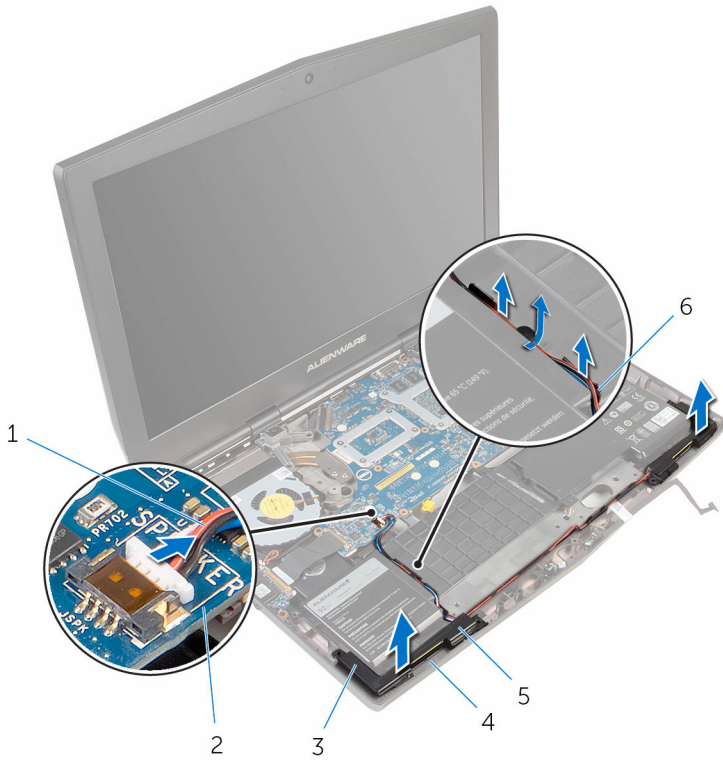

- | | | | |
|---|---------------------|---|----------------|
| 1 | speaker cable | 2 | system board |
| 3 | alignment posts (4) | 4 | computer base |
| 5 | speakers (2) | 6 | routing guides |

Replacing the speakers



WARNING: Before working inside your computer, read the safety information that shipped with your computer and follow the steps in [Before working inside your computer](#). After working inside your computer, follow the instructions in [After working inside your computer](#). For more safety best practices, see the Regulatory Compliance home page at www.dell.com/regulatory_compliance.

Procedure

- 1 Using the alignment posts, place the speakers on the computer base.
- 2 Route the speaker cable through the routing guides on the computer base and battery.
- 3 Route the front AlienFX LED cable through the routing guides on the battery.
- 4 Connect the speaker cable and front AlienFX LED cable to the system board.

Post-requisites

- 1 Follow the procedure from step 5 to step 11 in "Replacing the [palm rest](#)".
- 2 Replace the [base panel](#).

Removing the front AlienFX LED boards



WARNING: Before working inside your computer, read the safety information that shipped with your computer and follow the steps in [Before working inside your computer](#). After working inside your computer, follow the instructions in [After working inside your computer](#). For more safety best practices, see the Regulatory Compliance home page at www.dell.com/regulatory_compliance.

Prerequisites

- 1 Remove the [base panel](#).
- 2 Follow the procedure from step 1 to step 9 in "Removing the [palm rest](#)".

Procedure

- 1 Disconnect the front AlienFX LED board cables from the front AlienFX LED boards.
- 2 Remove the screws that secure the front AlienFX LED boards to the computer base.

3 Lift the front AlienFX LED boards off the computer base.

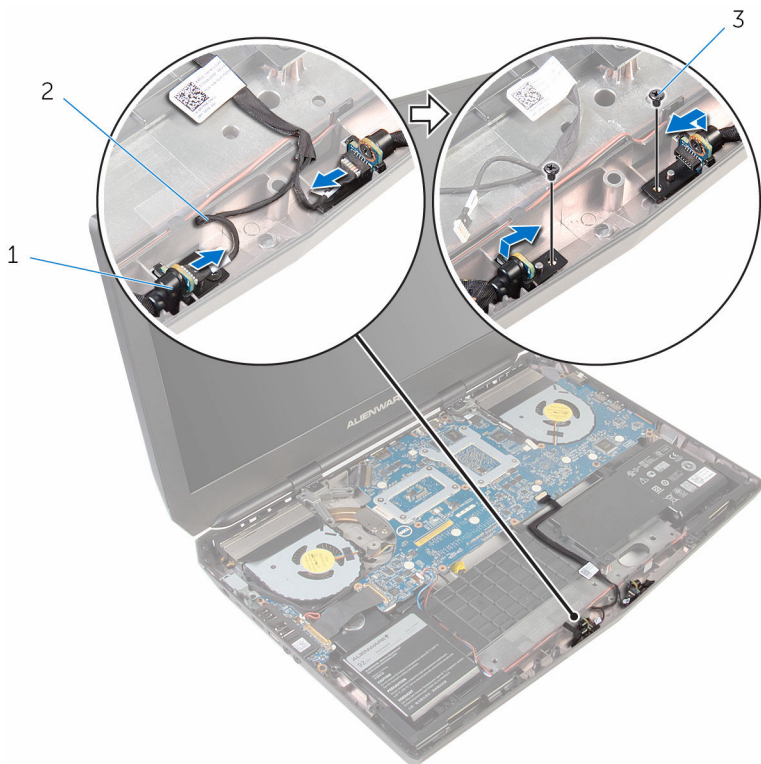

1 front AlienFX LED boards (2)

2 front AlienFX LED board cables (2)

3 screws (2)

Replacing the front AlienFX LED board

 **WARNING:** Before working inside your computer, read the safety information that shipped with your computer and follow the steps in [Before working inside your computer](#). After working inside your computer, follow the instructions in [After working inside your computer](#). For more safety best practices, see the Regulatory Compliance home page at www.dell.com/regulatory_compliance.

Procedure

- 1 Using the alignment posts on the computer base, place the front AlienFX LED boards on the computer base.
- 2 Align the screw holes on the front AlienFX LED boards with the screw holes on the computer base.
- 3 Replace the screws that secure the front AlienFX LED boards to the computer base.
- 4 Connect the front AlienFX LED board cables to the front AlienFX LED boards.

Post-requisites

- 1 Follow the procedure from step 5 to step 11 in “Replacing the [palm rest](#)”.
- 2 Replace the [base panel](#).

Removing the processor fan

⚠ WARNING: Before working inside your computer, read the safety information that shipped with your computer and follow the steps in [Before working inside your computer](#). After working inside your computer, follow the instructions in [After working inside your computer](#). For more safety best practices, see the Regulatory Compliance home page at www.dell.com/regulatory_compliance.

Prerequisites

- 1 Remove the [base panel](#).
- 2 Follow the procedure from step 1 to step 9 in “Removing the [palm rest](#)”.

Procedure

- 1 Close the display and turn the computer over.
- 2 Disconnect the processor-fan cable from the system board.



- 1 processor-fan cable

- 3 Turn the computer over and open the display.
- 4 Remove the screws that secure the processor fan to the computer base.
- 5 Peel off the Mylar from the processor heat-sink and processor fan.
- 6 Slide and lift the processor fan off the computer base.

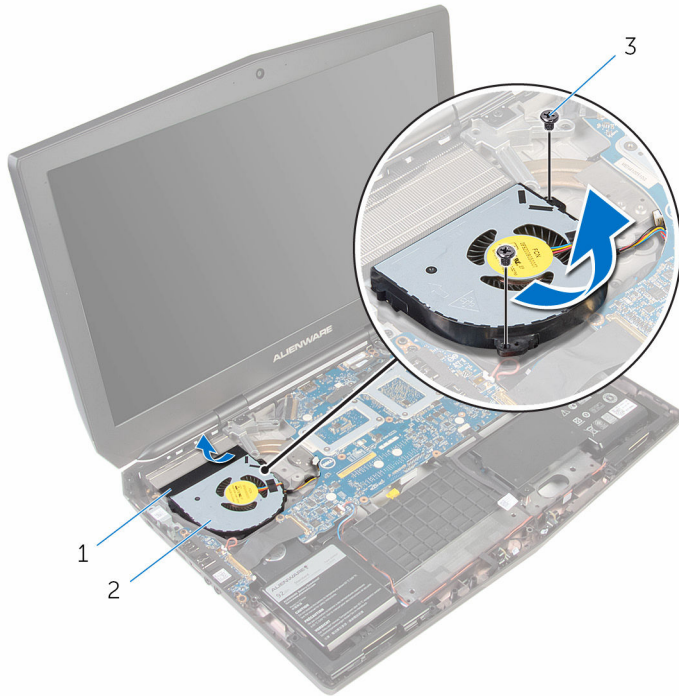

- 1 mylar
- 3 screws (2)

- 2 processor fan

Replacing the processor fan



WARNING: Before working inside your computer, read the safety information that shipped with your computer and follow the steps in [Before working inside your computer](#). After working inside your computer, follow the instructions in [After working inside your computer](#). For more safety best practices, see the Regulatory Compliance home page at www.dell.com/regulatory_compliance.

Procedure

- 1 Using the alignment posts on the computer base, slide and place the processor fan on the computer base.
- 2 Align the screw holes on the processor fan with the screw holes on the computer base.
- 3 Adhere the Mylar on the processor fan and processor heat-sink.
- 4 Replace the screws that secure the processor fan to the computer base.
- 5 Close the display and turn the computer over.
- 6 Connect the processor-fan cable to the system board.

Post-requisites

- 1 Follow the procedure from step 5 to step 11 in "Replacing the [palm rest](#)".
- 2 Replace the [base panel](#).

Removing the system board

 **WARNING:** Before working inside your computer, read the safety information that shipped with your computer and follow the steps in [Before working inside your computer](#). After working inside your computer, follow the instructions in [After working inside your computer](#). For more safety best practices, see the Regulatory Compliance home page at www.dell.com/regulatory_compliance.

 **NOTE:** Your computer's Service Tag is stored in the system board. You must enter the Service Tag in the BIOS setup program after you replace the system board.

 **NOTE:** Replacing the system board removes any changes you have made to the BIOS using the BIOS setup program. You must make the desired changes again after you replace the system board.

 **NOTE:** Before disconnecting the cables from the system board, note the location of the connectors so that you can reconnect the cables correctly after you replace the system board.

Prerequisites

- 1 Remove the [base panel](#).
- 2 Follow the procedure from step 1 to step 9 in "Removing the [palm rest](#)".
- 3 Remove the [display assembly](#).

Procedure

- 1 Turn the computer over.

- 2 Disconnect the processor-fan cable, video-card fan cable, hard-drive cable and power-adapter port cable from the system board.

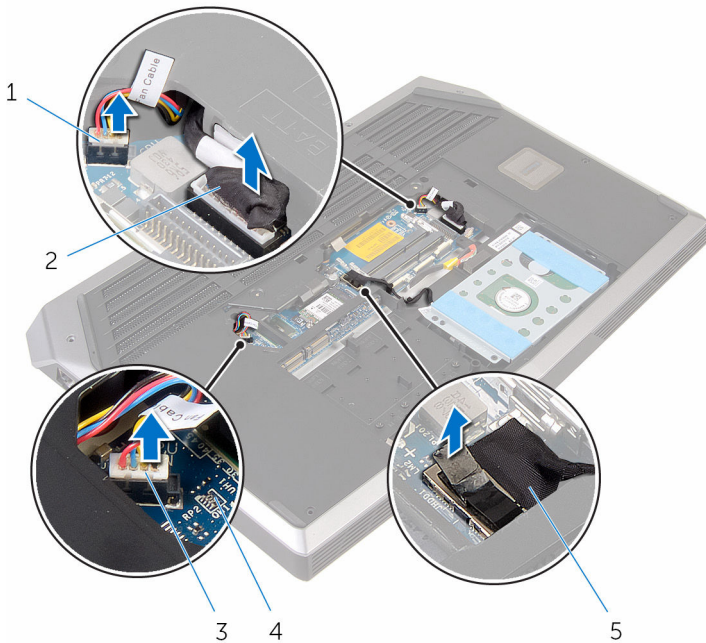

- | | | | |
|---|----------------------|---|--------------------------|
| 1 | processor-fan cable | 2 | power-adapter port cable |
| 3 | video-card fan cable | 4 | system board |
| 5 | hard-drive cable | | |

- 3 Turn the computer over.
- 4 Disconnect the speaker and front AlienFX LED cables from the system board.

- 5** Lift the latch and disconnect the I/O-board cable from the system board.

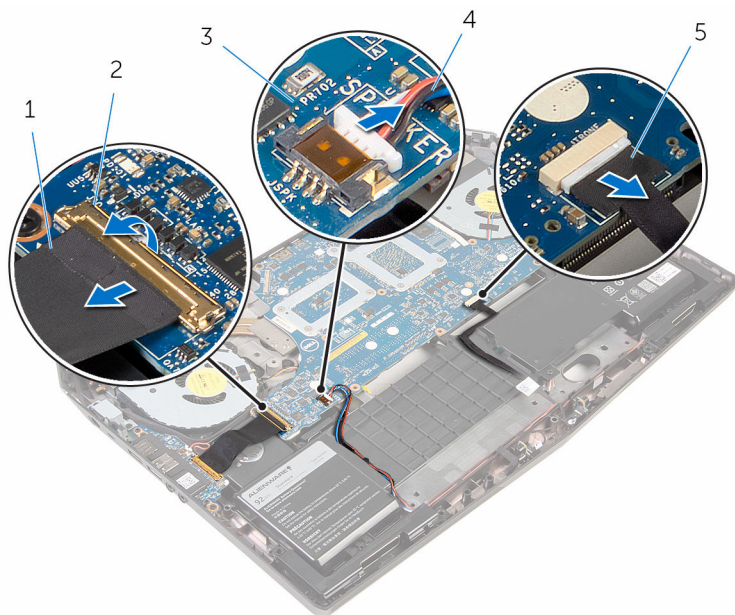

- | | | | |
|---|-------------------------|---|---------------|
| 1 | I/O-board cable | 2 | latch |
| 3 | system board | 4 | speaker cable |
| 5 | front AlienFX LED cable | | |

- 6** Remove the screws that secure the system board to the computer base.

7 Lift the system board off the computer base.

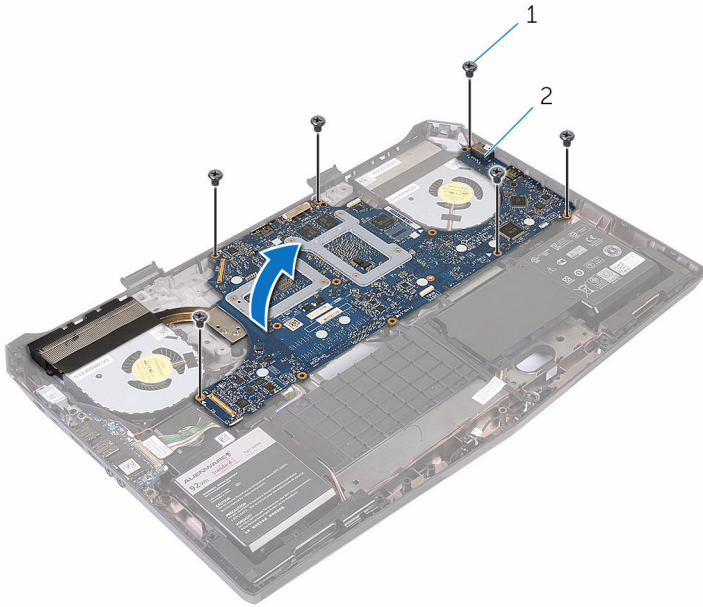

1 screws (6)

2 system board

8 Remove the [wireless card](#).

9 Remove the [heat sink](#).

10 Remove the [coin-cell battery](#).

Replacing the system board

 **WARNING:** Before working inside your computer, read the safety information that shipped with your computer and follow the steps in [Before working inside your computer](#). After working inside your computer, follow the instructions in [After working inside your computer](#). For more safety best practices, see the Regulatory Compliance home page at www.dell.com/regulatory_compliance.

 **NOTE:** Your computer's Service Tag is stored in the system board. You must enter the Service Tag in the BIOS setup program after you replace the system board.

 **NOTE:** Replacing the system board removes any changes you have made to the BIOS using the BIOS setup program. You must make the desired changes again after you replace the system board.

Procedure

- 1 Replace the [coin-cell battery](#).
- 2 Replace the [heat sink](#).
- 3 Replace the [wireless card](#).
- 4 Insert the ports on the system board into the slots on the computer base and gently place the system board on the computer base.
- 5 Align the screw holes on the system board with the screw holes on the computer base.
- 6 Replace the screws that secure the system board to the computer base.
- 7 Slide the I/O-board cable into the connector on the I/O board and press down the latch to secure the cable.
- 8 Connect the speaker and front AlienFX LED cables to the system board.
- 9 Turn the computer over.
- 10 Connect the processor-fan cable, video-card fan cable, hard-drive cable, and power-adaptor port cable to the system board.

Post-requisites

- 1 Replace the [display assembly](#).
- 2 Follow the procedure from step 5 to step 11 in "Replacing the [palm rest](#)".

3 Replace the [base panel](#).

Removing the wireless card



WARNING: Before working inside your computer, read the safety information that shipped with your computer and follow the steps in [Before working inside your computer](#). After working inside your computer, follow the instructions in [After working inside your computer](#). For more safety best practices, see the Regulatory Compliance home page at www.dell.com/regulatory_compliance.

Prerequisites

- 1 Remove the [base panel](#).
- 2 Follow the procedure from step 1 to step 9 in “Removing the [palm rest](#)”.
- 3 Remove the [display assembly](#).
- 4 Follow the procedure from step 1 to step 7 in “Removing the [system board](#)”.

Procedure

- 1 Peel the wireless card off the system board.

2 Lift and slide the wireless card from the wireless-card slot.

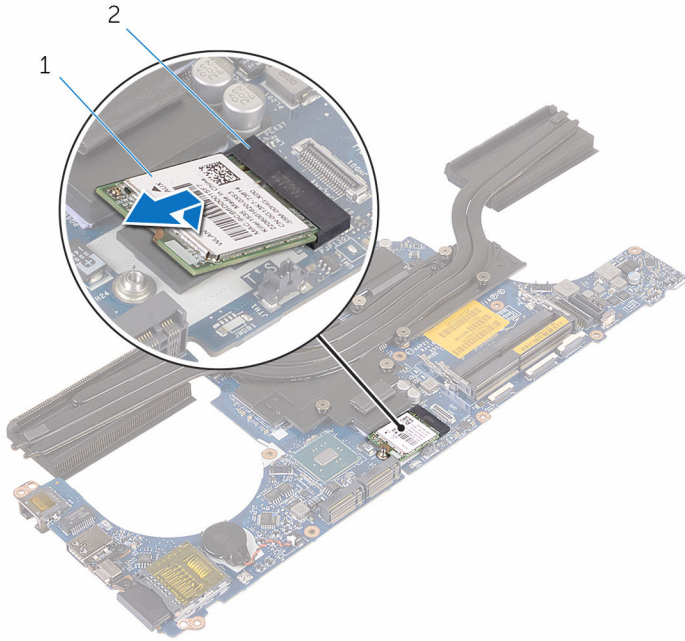

1 wireless card

2 wireless-card slot

Replacing the wireless card

 **WARNING:** Before working inside your computer, read the safety information that shipped with your computer and follow the steps in [Before working inside your computer](#). After working inside your computer, follow the instructions in [After working inside your computer](#). For more safety best practices, see the Regulatory Compliance home page at www.dell.com/regulatory_compliance.

Procedure

 **CAUTION:** To avoid damaging the wireless card, do not place any cables under it.

- 1 Align the notch on the wireless card with the tab on the wireless-card slot.

- 2 Slide the wireless card at an angle into the wireless-card slot and press down to adhere the wireless card to the system board.

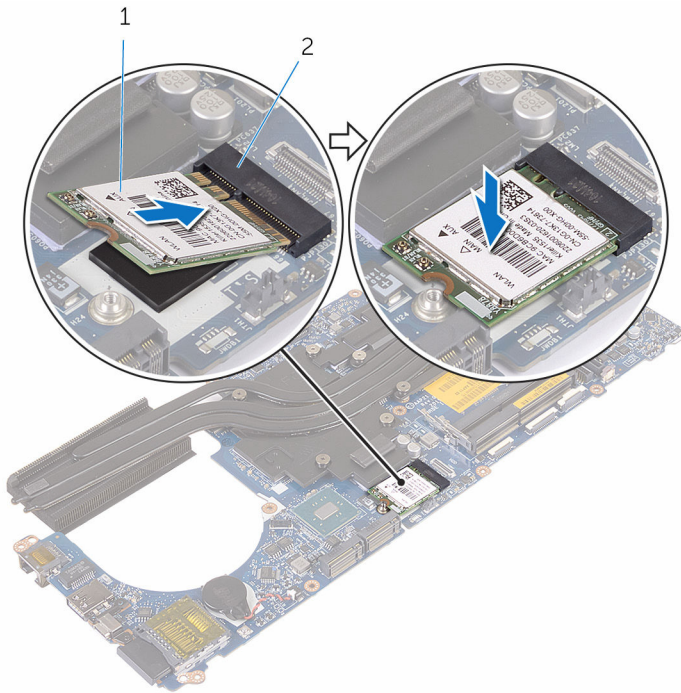



1 wireless card

2 wireless-card slot

Post-requisites

- 1 Follow the procedure from step 4 to step 10 in "[Replacing the system board](#)".
- 2 Replace the [display assembly](#).
- 3 Follow the procedure from step 5 to step 11 in "Replacing the [palm rest](#)".
- 4 Replace the [base panel](#).

Removing the heat sink

-  **WARNING:** Before working inside your computer, read the safety information that shipped with your computer and follow the steps in [Before working inside your computer](#). After working inside your computer, follow the instructions in [After working inside your computer](#). For more safety best practices, see the Regulatory Compliance home page at www.dell.com/regulatory_compliance.
-  **WARNING:** The heat sink may become hot during normal operation. Allow sufficient time for the heat sink to cool before you touch it.
-  **CAUTION:** For maximum cooling of the processor, do not touch the heat transfer areas on the heat sink. The oils in your skin can reduce the heat transfer capability of the thermal grease.

Prerequisites

- 1 Remove the [base panel](#).
- 2 Remove the [wireless card](#).
- 3 Follow the procedure from step 1 to step 9 in “Removing the [palm rest](#)”.
- 4 Remove the [display assembly](#).
- 5 Follow the procedure from step 1 to step 7 in “Removing the [system board](#)”.

Procedure

- 1 In sequential order (as indicated on the heat sink), loosen the captive screws that secure the heat sink to the system board.

2 Lift the heat sink off the system board.

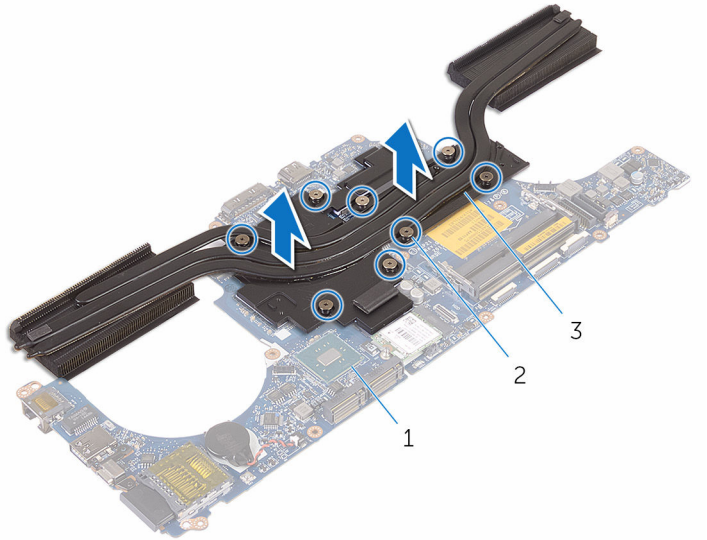

1 system board

2 captive screws (8)

3 heat sink

Replacing the heat sink

 **WARNING:** Before working inside your computer, read the safety information that shipped with your computer and follow the steps in [Before working inside your computer](#). After working inside your computer, follow the instructions in [After working inside your computer](#). For more safety best practices, see the Regulatory Compliance home page at www.dell.com/regulatory_compliance.

 **CAUTION:** Incorrect alignment of the heat sink can damage the system board and processor.

 **NOTE:** The original thermal grease can be reused if the original system board and heat sink are reinstalled together. If either the system board or the heat sink is replaced, use the thermal pad provided in the kit to ensure that thermal conductivity is achieved.

Procedure

- 1 Align the screw holes on the heat sink with the screw holes on the system board.
- 2 In sequential order (as indicated on the heat sink), tighten the captive screws that secure the heat sink to the system board.
- 3 Turn the system board over.

Post-requisites

- 1 Follow the procedure from step 4 to step 10 in "[Replacing the system board](#)".
- 2 Replace the [display assembly](#).
- 3 Follow the procedure from step 5 to step 11 in "Replacing the [palm rest](#)".
- 4 Replace the [wireless card](#).
- 5 Replace the [base panel](#).

Removing the coin-cell battery

 **WARNING:** Before working inside your computer, read the safety information that shipped with your computer and follow the steps in [Before working inside your computer](#). After working inside your computer, follow the instructions in [After working inside your computer](#). For more safety best practices, see the Regulatory Compliance home page at www.dell.com/regulatory_compliance.

 **CAUTION:** Removing the coin-cell battery resets the BIOS setup program's settings to default. It is recommended that you note the BIOS setup program's settings before removing the coin-cell battery.

Prerequisites

- 1 Remove the [base panel](#).
- 2 Remove the [wireless card](#).
- 3 Follow the procedure from step 1 to step 9 in "Removing the [palm rest](#)".
- 4 Remove the [display assembly](#).
- 5 Follow the procedure from step 1 to step 7 in "Removing the [system board](#)".

Procedure

- 1 Disconnect the coin-cell battery cable from the system board.

2 Peel the coin-cell battery off the system board.

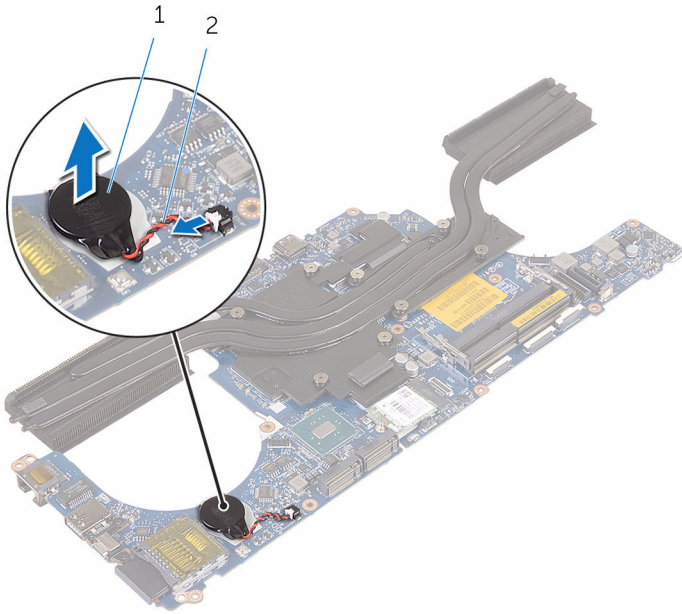

1 coin-cell battery

2 coin-cell battery cable

Replacing the coin-cell battery



WARNING: Before working inside your computer, read the safety information that shipped with your computer and follow the steps in [Before working inside your computer](#). After working inside your computer, follow the instructions in [After working inside your computer](#). For more safety best practices, see the Regulatory Compliance home page at www.dell.com/regulatory_compliance.

Procedure

- 1 Adhere the coin-cell battery to the system board.
- 2 Connect the coin-cell battery cable to the connector on the system board.

Post-requisites

- 1 Follow the procedure from step 4 to step 10 in "[Replacing the system board](#)".
- 2 Replace the [display assembly](#).
- 3 Follow the procedure from step 5 to step 11 in "Replacing the [palm rest](#)".
- 4 Replace the [wireless card](#).
- 5 Replace the [base panel](#).

Removing the video-card fan



WARNING: Before working inside your computer, read the safety information that shipped with your computer and follow the steps in [Before working inside your computer](#). After working inside your computer, follow the instructions in [After working inside your computer](#). For more safety best practices, see the Regulatory Compliance home page at www.dell.com/regulatory_compliance.

Prerequisites

- 1 Remove the [base panel](#).
- 2 Remove the [wireless card](#).
- 3 Follow the procedure from step 1 to step 9 in "Removing the [palm rest](#)".
- 4 Remove the [display assembly](#).
- 5 Follow the procedure from step 1 to step 7 in "Removing the [system board](#)".

Procedure

- 1 Remove the screws that secure the video-card fan to the computer base.

2 Lift the video-card fan off the computer base.

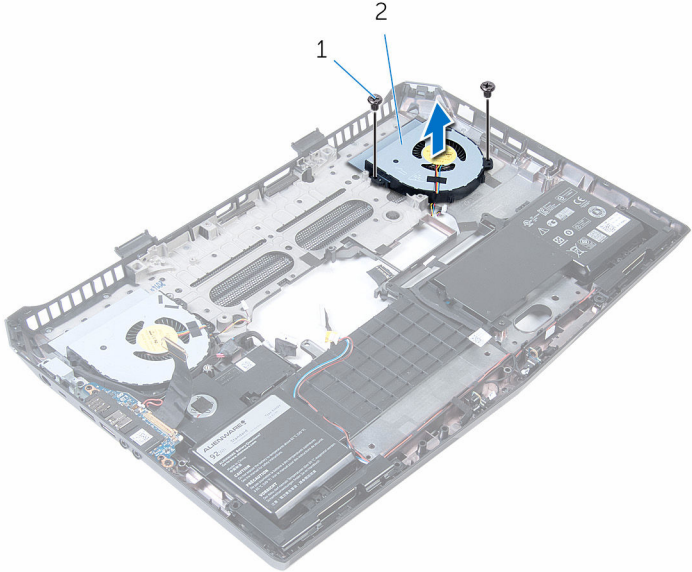

1 screws (2)

2 video-card fan

Replacing the video-card fan



WARNING: Before working inside your computer, read the safety information that shipped with your computer and follow the steps in [Before working inside your computer](#). After working inside your computer, follow the instructions in [After working inside your computer](#). For more safety best practices, see the Regulatory Compliance home page at www.dell.com/regulatory_compliance.

Procedure

- 1 Align the screw holes on the video-card fan with the screw holes on the computer base.
- 2 Replace the screws that secure the video-card fan to the computer base.

Post-requisites

- 1 Follow the procedure from step 4 to step 10 in "[Replacing the system board](#)".
- 2 Replace the [display assembly](#).
- 3 Follow the procedure from step 5 to step 11 in "Replacing the [palm rest](#)".
- 4 Replace the [wireless card](#).
- 5 Replace the [base panel](#).

Removing the power-adapter port



WARNING: Before working inside your computer, read the safety information that shipped with your computer and follow the steps in [Before working inside your computer](#). After working inside your computer, follow the instructions in [After working inside your computer](#). For more safety best practices, see the Regulatory Compliance home page at www.dell.com/regulatory_compliance.

Prerequisites

- 1 Remove the [base panel](#).
- 2 Remove the [wireless card](#).
- 3 Follow the procedure from step 1 to step 9 in "Removing the [palm rest](#)".
- 4 Remove the [display assembly](#).
- 5 Follow the procedure from step 1 to step 7 in "Removing the [system board](#)".

Procedure

- 1 Remove the screws that secure the power-adapter port bracket to the power-adapter port.
- 2 Lift the power-adapter port bracket off the power-adapter port.
- 3 Note the power-adapter port cable routing and remove the cable from the routing guides on the computer base.

4 Lift the power-adaptor port along with its cable off the computer base.

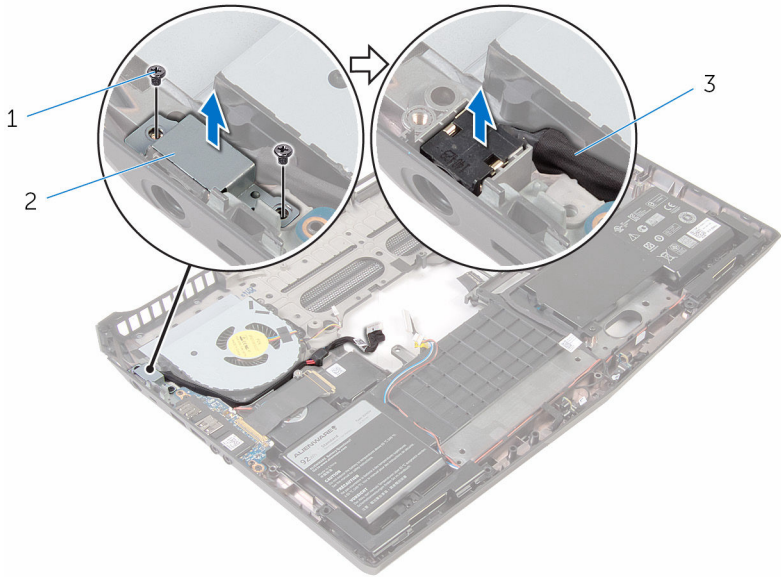

1 screws (2)

2 power-adaptor port
bracket

3 power-adaptor port

Replacing the power-adapter port

 **WARNING:** Before working inside your computer, read the safety information that shipped with your computer and follow the steps in [Before working inside your computer](#). After working inside your computer, follow the instructions in [After working inside your computer](#). For more safety best practices, see the Regulatory Compliance home page at www.dell.com/regulatory_compliance.

Procedure

- 1 Slide the power-adapter port into the slot on the computer base.
- 2 Align the screw holes on the power-adapter port bracket with the screw holes on the power-adapter port.
- 3 Replace the screws that secure the power-adapter port bracket to the power-adapter port.
- 4 Route the power-adapter port cable through the routing guides on the computer base.

Post-requisites

- 1 Follow the procedure from step 4 to step 10 in "[Replacing the system board](#)".
- 2 Replace the [display assembly](#).
- 3 Follow the procedure from step 5 to step 11 in "Replacing the [palm rest](#)".
- 4 Replace the [wireless card](#).
- 5 Replace the [base panel](#).

Removing the subwoofer



WARNING: Before working inside your computer, read the safety information that shipped with your computer and follow the steps in [Before working inside your computer](#). After working inside your computer, follow the instructions in [After working inside your computer](#). For more safety best practices, see the Regulatory Compliance home page at www.dell.com/regulatory_compliance.

Prerequisites

- 1 Remove the [base panel](#).
- 2 Remove the [wireless card](#).
- 3 Follow the procedure from step 1 to step 9 in "Removing the [palm rest](#)".
- 4 Remove the [I/O board](#).
- 5 Remove the [display assembly](#).
- 6 Follow the procedure from step 1 to step 7 in "Removing the [system board](#)".

Procedure

- 1 Remove the screws that secure the subwoofer to the computer base.

2 Lift the subwoofer off the computer base.

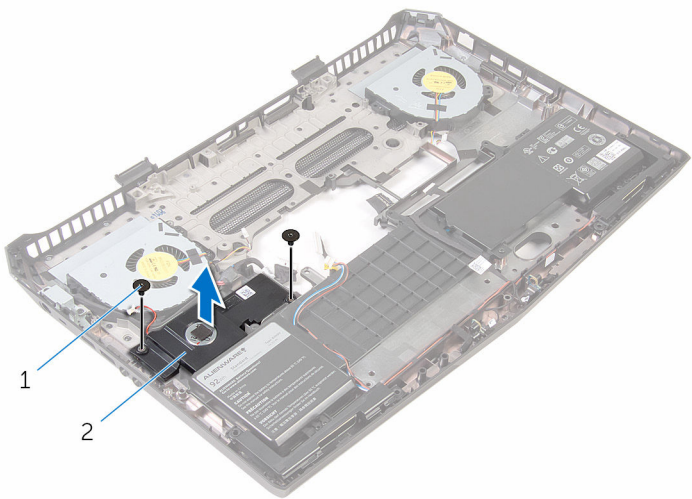

1 screws (2)

2 subwoofer

Replacing the subwoofer



WARNING: Before working inside your computer, read the safety information that shipped with your computer and follow the steps in [Before working inside your computer](#). After working inside your computer, follow the instructions in [After working inside your computer](#). For more safety best practices, see the Regulatory Compliance home page at www.dell.com/regulatory_compliance.

Procedure

- 1 Align the screw holes on the subwoofer with the screw holes on the computer base.
- 2 Replace the screws that secure the subwoofer to the computer base.

Post-requisites

- 1 Follow the procedure from step 4 to step 10 in "[Replacing the system board](#)".
- 2 Replace the [display assembly](#).
- 3 Replace the [I/O board](#).
- 4 Follow the procedure from step 5 to step 11 in "Replacing the [palm rest](#)".
- 5 Replace the [wireless card](#).
- 6 Replace the [base panel](#).

Removing the display bezel



WARNING: Before working inside your computer, read the safety information that shipped with your computer and follow the steps in [Before working inside your computer](#). After working inside your computer, follow the instructions in [After working inside your computer](#). For more safety best practices, see the Regulatory Compliance home page at www.dell.com/regulatory_compliance.

Prerequisites



NOTE: This chapter is applicable only if you have purchased a laptop with non-touchscreen display.

- 1 Remove the [base panel](#).
- 2 Remove the [wireless card](#).
- 3 Follow the procedure from step 1 to step 9 in "Removing the [palm rest](#)".
- 4 Remove the [display assembly](#).

Procedure

- 1 Using your fingertips, carefully pry up the inside edges of the display bezel.

- 2** Carefully lift the display bezel and turn it over.

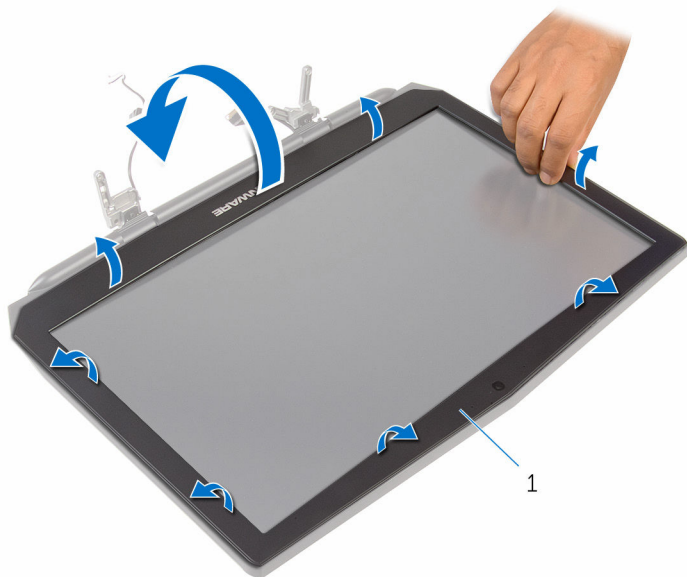

1 display bezel

- 3** Lift the latches and disconnect the display-board cables from the logo board.

- 4** Lift the display-bezel assembly away from the display assembly.

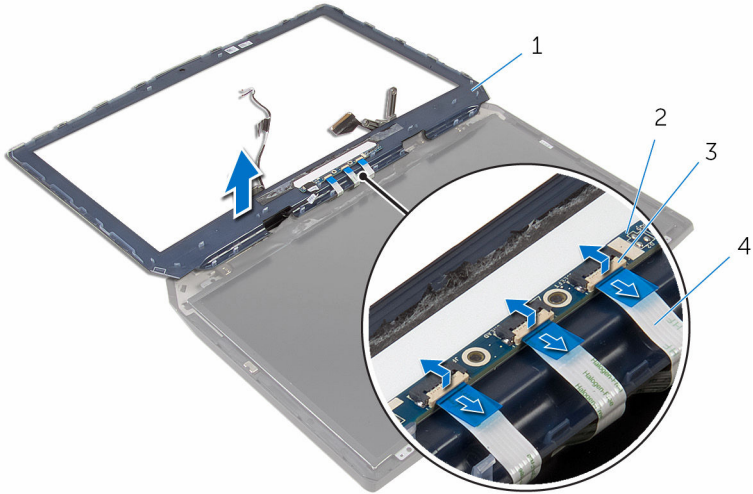

1 display bezel

2 logo board

3 latches (3)

4 display-board cables (3)

- 5** Peel off the tape that secures the logo-board cable to the logo board and disconnect the logo-board cable.

6 Peel off the logo board from the display bezel.

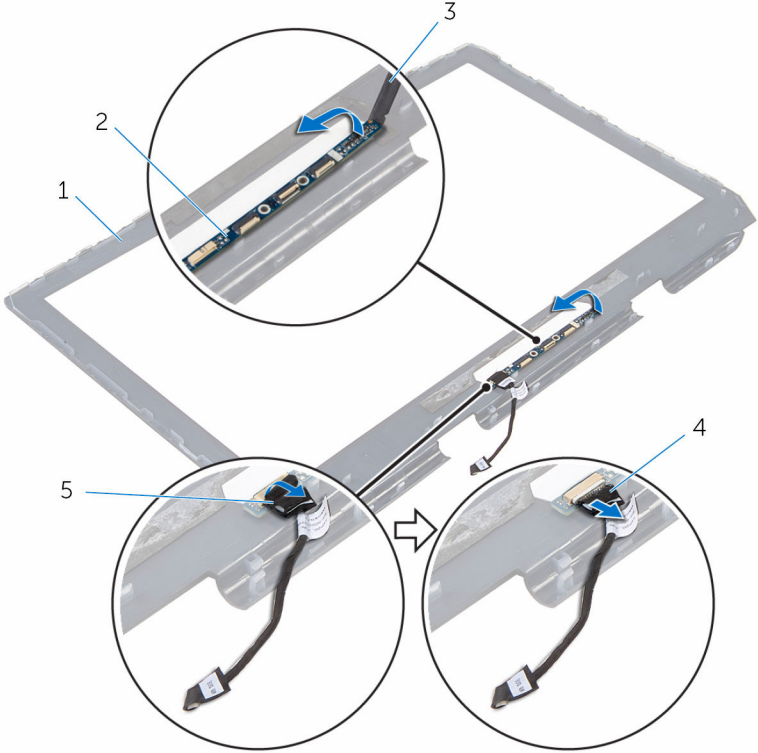

- 1 display bezel
- 3 plastic scribe
- 5 tape

- 2 logo board
- 4 logo-board cable

7 After performing the above steps, we are left with the display bezel.



1 display bezel

Replacing the display bezel



WARNING: Before working inside your computer, read the safety information that shipped with your computer and follow the steps in [Before working inside your computer](#). After working inside your computer, follow the instructions in [After working inside your computer](#). For more safety best practices, see the Regulatory Compliance home page at www.dell.com/regulatory_compliance.

Procedure



NOTE: This chapter is applicable only if you have purchased a laptop with non-touchscreen display.

- 1 Adhere the logo board on the display bezel.
- 2 Connect the logo-board cable to the logo board and adhere the adhesive tape.
- 3 Slide the display-board cables to their respective connectors on the logo board and press down the latches to secure the cables.
- 4 Turn the display bezel over.
- 5 Align the display bezel with the display back-cover and gently snap the display bezel into place.

Post-requisites

- 1 Replace the [display assembly](#).
- 2 Follow the procedure from step 5 to step 11 in “Replacing the [palm rest](#)”.
- 3 Replace the [wireless card](#).
- 4 Replace the [base panel](#).

Removing the display panel



WARNING: Before working inside your computer, read the safety information that shipped with your computer and follow the steps in [Before working inside your computer](#). After working inside your computer, follow the instructions in [After working inside your computer](#). For more safety best practices, see the Regulatory Compliance home page at www.dell.com/regulatory_compliance.

Prerequisites



NOTE: This chapter is applicable only if you have purchased a laptop with non-touchscreen display.

- 1 Remove the [base panel](#).
- 2 Remove the [wireless card](#).
- 3 Follow the procedure from step 1 to step 9 in "Removing the [palm rest](#)".
- 4 Remove the [display assembly](#).
- 5 Remove the [display bezel](#).

Procedure

- 1 Remove the screws that secure the display panel to the display back-cover.

- 2** Gently lift the display panel and turn it over.

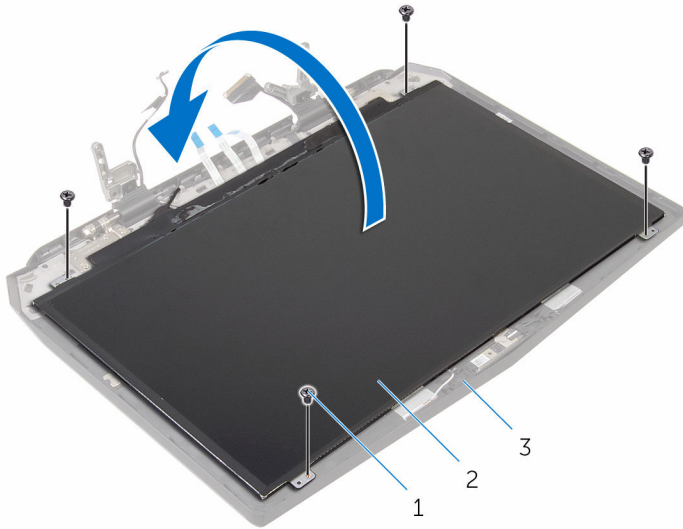

1 screws (4)

2 display panel

3 display back-cover

- 3** Lift the latch and disconnect the display cable from the display panel.

4 Lift the display panel off the display assembly.

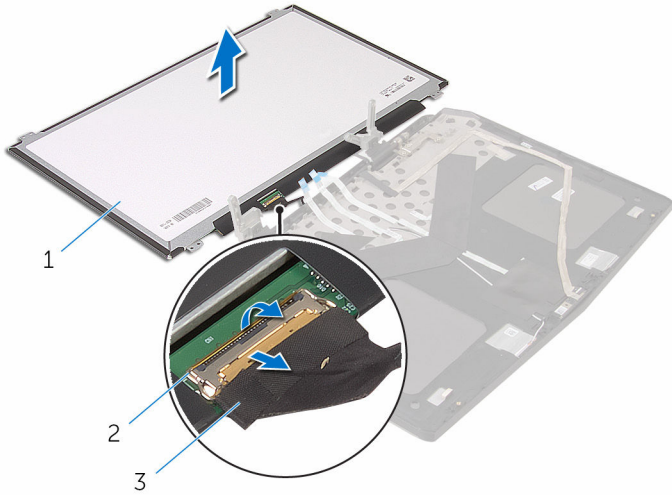

- 1 display panel
- 3 display cable

2 latch

Replacing the display panel



WARNING: Before working inside your computer, read the safety information that shipped with your computer and follow the steps in [Before working inside your computer](#). After working inside your computer, follow the instructions in [After working inside your computer](#). For more safety best practices, see the Regulatory Compliance home page at www.dell.com/regulatory_compliance.

Procedure



NOTE: This chapter is applicable only if you have purchased a laptop with non-touchscreen display.

- 1 Connect the display cable to the display panel and press down on the latch to secure the cable.
- 2 Turn the display panel over.
- 3 Align the screw holes on the display panel with the screw holes on the display back-cover.
- 4 Replace the screws that secure the display panel to the display back-cover.

Post-requisites

- 1 Replace the [display bezel](#).
- 2 Replace the [display assembly](#).
- 3 Follow the procedure from step 5 to step 11 in "Replacing the [palm rest](#)".
- 4 Replace the [wireless card](#).
- 5 Replace the [base panel](#).

Removing the display hinges



WARNING: Before working inside your computer, read the safety information that shipped with your computer and follow the steps in [Before working inside your computer](#). After working inside your computer, follow the instructions in [After working inside your computer](#). For more safety best practices, see the Regulatory Compliance home page at www.dell.com/regulatory_compliance.

Prerequisites



NOTE: This chapter is applicable only if you have purchased a laptop with non-touchscreen display.

- 1 Remove the [base panel](#).
- 2 Remove the [wireless card](#).
- 3 Follow the procedure from step 1 to step 9 in "Removing the [palm rest](#)".
- 4 Remove the [display assembly](#).
- 5 Remove the [display bezel](#).

Procedure

- 1 Remove the screws that secure the hinge caps to the display hinges.

2 Lift the hinge caps off the display hinges.

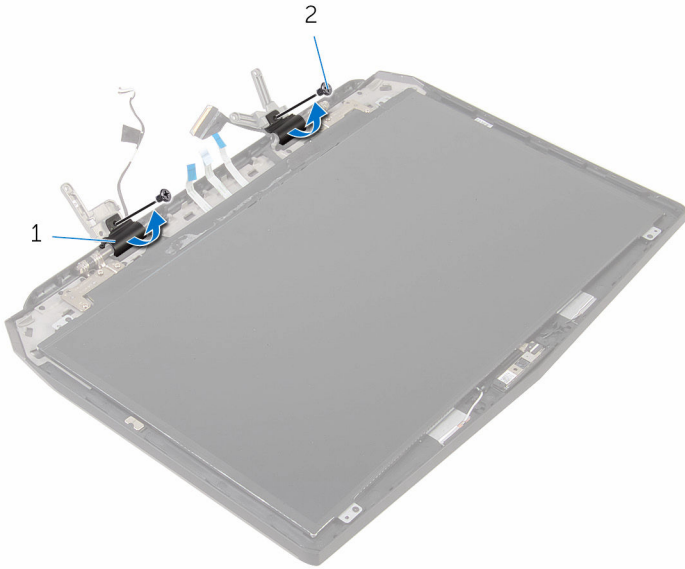

1 hinge caps (2)

2 screws (2)

3 Remove the screws that secure the display hinges to the display back-cover.

4 Lift the display hinges off the display back-cover.

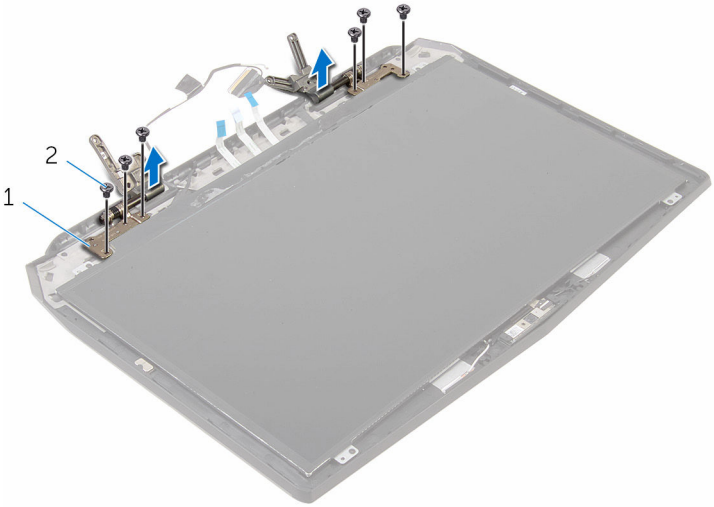

1 display hinges (2)

2 screws (6)

Replacing the display hinges

 **WARNING:** Before working inside your computer, read the safety information that shipped with your computer and follow the steps in [Before working inside your computer](#). After working inside your computer, follow the instructions in [After working inside your computer](#). For more safety best practices, see the Regulatory Compliance home page at www.dell.com/regulatory_compliance.

Procedure

 **NOTE:** This chapter is applicable only if you have purchased a laptop with non-touchscreen display.

- 1 Align the screw holes on the display hinges with the screw holes on the display back-cover.
- 2 Replace the screws that secure the display hinges to the display back-cover.
- 3 Align the screw holes on the hinge caps with the screw holes on the display hinges.
- 4 Replace the screws that secure the hinge caps to the display hinges.

Post-requisites

- 1 Replace the [display bezel](#).
- 2 Replace the [display assembly](#).
- 3 Follow the procedure from step 5 to step 11 in “Replacing the [palm rest](#)”.
- 4 Replace the [wireless card](#).
- 5 Replace the [base panel](#).

Removing the computer base



WARNING: Before working inside your computer, read the safety information that shipped with your computer and follow the steps in [Before working inside your computer](#). After working inside your computer, follow the instructions in [After working inside your computer](#). For more safety best practices, see the Regulatory Compliance home page at www.dell.com/regulatory_compliance.

Prerequisites

- 1 Remove the [base panel](#).
- 2 Remove the [wireless card](#).
- 3 Follow the procedure from step 1 to step 9 in "Removing the [palm rest](#)".
- 4 Remove the [display assembly](#).
- 5 Remove the [power-adapter port](#).
- 6 Remove the [battery](#).
- 7 Remove the [speakers](#).
- 8 Remove the [I/O board](#).
- 9 Remove the [subwoofer](#).

Procedure

After performing the prerequisites, we are left with the computer base.

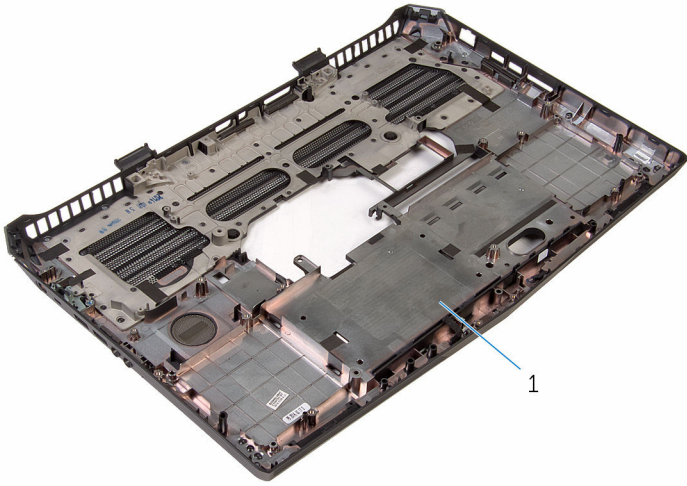

1 computer base

Replacing the computer base



WARNING: Before working inside your computer, read the safety information that shipped with your computer and follow the steps in [Before working inside your computer](#). After working inside your computer, follow the instructions in [After working inside your computer](#). For more safety best practices, see the Regulatory Compliance home page at www.dell.com/regulatory_compliance.

Procedure

Place the computer base on a flat surface.

Post-requisites

- 1 Replace the [subwoofer](#).
- 2 Replace the [I/O board](#).
- 3 Replace the [speakers](#).
- 4 Replace the [battery](#).
- 5 Replace the [power-adapter port](#).
- 6 Replace the [display assembly](#).
- 7 Follow the procedure from step 5 to step 11 in "Replacing the [palm rest](#)".
- 8 Replace the [wireless card](#).
- 9 Replace the [base panel](#).

Removing the logo board



WARNING: Before working inside your computer, read the safety information that shipped with your computer and follow the steps in [Before working inside your computer](#). After working inside your computer, follow the instructions in [After working inside your computer](#). For more safety best practices, see the Regulatory Compliance home page at www.dell.com/regulatory_compliance.

Prerequisites

- 1 Remove the [base panel](#).
- 2 Remove the [wireless card](#).
- 3 Follow the procedure from step 1 to step 9 in "Removing the [palm rest](#)".
- 4 Remove the [display assembly](#).
- 5 Follow the procedure from step 1 to step 2 in removing the [display bezel](#).

Procedure

- 1 Lift the latches and disconnect the display-board cables from the logo board.

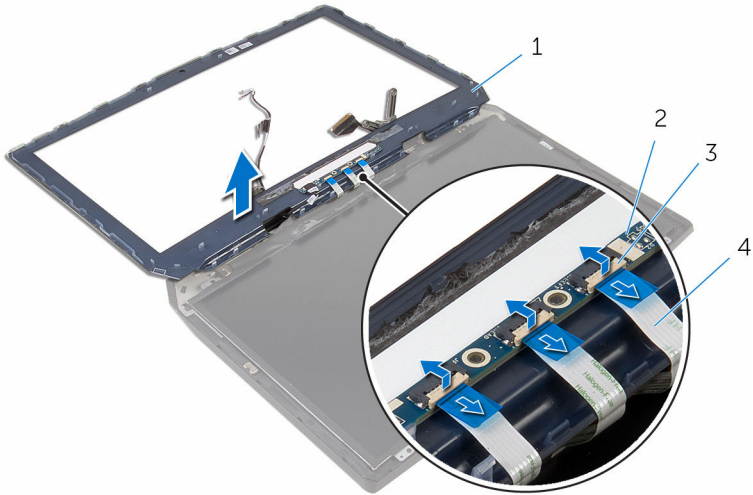

- | | | | |
|---|---------------|---|--------------------------|
| 1 | display bezel | 2 | logo board |
| 3 | latches (3) | 4 | display-board cables (3) |

- 2 Peel off the tape that secures the logo-board cable to the logo board and disconnect the logo-board cable.

3 Peel off the logo board from the display bezel.

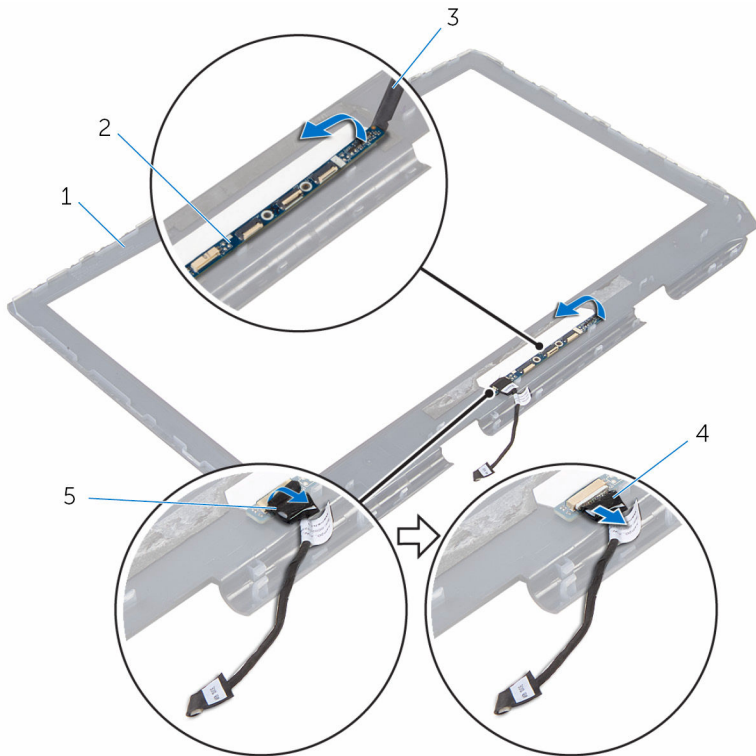

1 display bezel

3 plastic scribe

5 tape

2 logo board

4 logo-board cable

Replacing the logo board



WARNING: Before working inside your computer, read the safety information that shipped with your computer and follow the steps in [Before working inside your computer](#). After working inside your computer, follow the instructions in [After working inside your computer](#). For more safety best practices, see the Regulatory Compliance home page at www.dell.com/regulatory_compliance.

Procedure

- 1 Adhere the logo board on the display bezel.
- 2 Connect the logo-board cable to the logo board and adhere the adhesive tape.
- 3 Slide the display-board cables to their respective connectors on the logo board and press down the latches to secure the cables.

Post-requisites

- 1 Replace the [display bezel](#).
- 2 Replace the [display assembly](#).
- 3 Follow the procedure from step 5 to step 11 in “Replacing the [palm rest](#)”.
- 4 Replace the [wireless card](#).
- 5 Replace the [base panel](#).

Removing the camera



WARNING: Before working inside your computer, read the safety information that shipped with your computer and follow the steps in [Before working inside your computer](#). After working inside your computer, follow the instructions in [After working inside your computer](#). For more safety best practices, see the Regulatory Compliance home page at www.dell.com/regulatory_compliance.

Prerequisites



NOTE: This chapter is applicable only if you have purchased a laptop with non-touchscreen display.

- 1 Remove the [base panel](#).
- 2 Remove the [wireless card](#).
- 3 Follow the procedure from step 1 to step 9 in "Removing the [palm rest](#)".
- 4 Remove the [display assembly](#).
- 5 Remove the [display bezel](#).

Procedure

- 1 Place the display back-cover assembly on a flat surface.
- 2 Using a plastic scribe, pry the camera module off the display back-cover.

3 Disconnect the camera cable from the camera module.

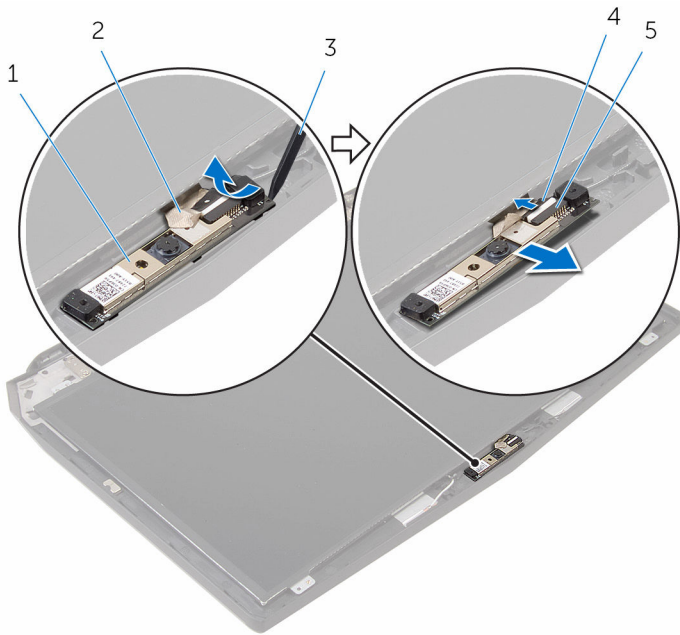

- 1 camera module
- 3 plastic scribe
- 5 connector

- 2 tape
- 4 camera cable

Replacing the camera



WARNING: Before working inside your computer, read the safety information that shipped with your computer and follow the steps in [Before working inside your computer](#). After working inside your computer, follow the instructions in [After working inside your computer](#). For more safety best practices, see the Regulatory Compliance home page at www.dell.com/regulatory_compliance.

Procedure



NOTE: This chapter is applicable only if you have purchased a laptop with non-touchscreen display.

- 1 Using the alignment posts, adhere the camera module to the display back-cover and snap it into place.
- 2 Connect the camera cable to the camera module.

Post-requisites

- 1 Replace the [display bezel](#).
- 2 Replace the [display assembly](#).
- 3 Follow the procedure from step 5 to step 11 in “Replacing the [palm rest](#)”.
- 4 Replace the [wireless card](#).
- 5 Replace the [base panel](#).

Removing the display-panel AlienFX LEDs



WARNING: Before working inside your computer, read the safety information that shipped with your computer and follow the steps in [Before working inside your computer](#). After working inside your computer, follow the instructions in [After working inside your computer](#). For more safety best practices, see the Regulatory Compliance home page at www.dell.com/regulatory_compliance.

Prerequisites

- 1 Remove the [base panel](#).
- 2 Remove the [wireless card](#).
- 3 Follow the procedure from step 1 to step 9 in "Removing the [palm rest](#)".
- 4 Remove the [display assembly](#).
- 5 Remove the [display bezel](#).
- 6 Remove the [display panel](#).

Procedure

- 1 Peel off the mylar that secures the display-board cables and the display-panel AlienFX LEDs to the display back-cover.

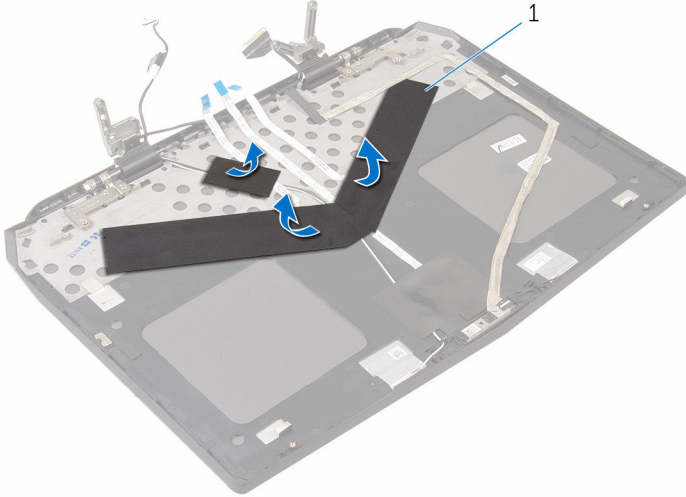

1 mylar

2 Lift the display-board cables and the display-panel AlienFX LEDs off the display back-cover.

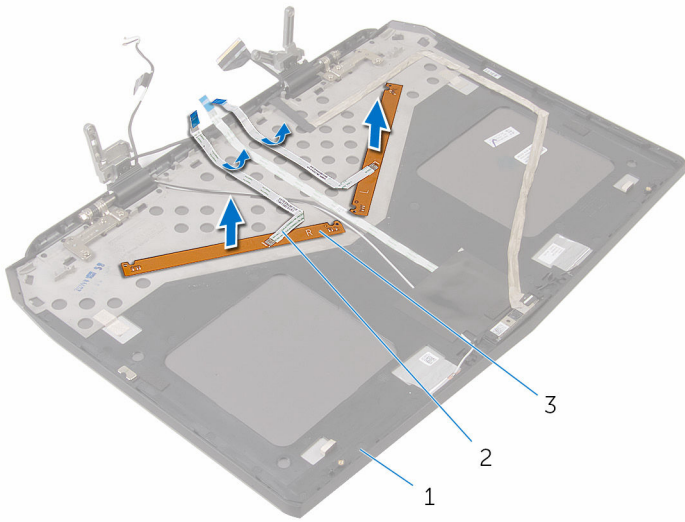

- 1 display back-cover
- 2 display-board cables (2)
- 3 display-panel AlienFX LEDs (2)

Replacing the display-panel AlienFX LEDs



WARNING: Before working inside your computer, read the safety information that shipped with your computer and follow the steps in [Before working inside your computer](#). After working inside your computer, follow the instructions in [After working inside your computer](#). For more safety best practices, see the Regulatory Compliance home page at www.dell.com/regulatory_compliance.

Procedure

- 1 Adhere the display-board cables and the display-panel AlienFX LEDs to the display back-cover.
- 2 Adhere the mylar that secures the display-board cables and the display-panel AlienFX LEDs to the display back-cover.

Post-requisites

- 1 Replace the [display panel](#).
- 2 Replace the [display bezel](#).
- 3 Replace the [display assembly](#).
- 4 Follow the procedure from step 5 to step 11 in "Replacing the [palm rest](#)".
- 5 Replace the [wireless card](#).
- 6 Replace the [base panel](#).

Removing the Alienware AlienHead LED board



WARNING: Before working inside your computer, read the safety information that shipped with your computer and follow the steps in [Before working inside your computer](#). After working inside your computer, follow the instructions in [After working inside your computer](#). For more safety best practices, see the Regulatory Compliance home page at www.dell.com/regulatory_compliance.

Prerequisites

- 1 Remove the [base panel](#).
- 2 Remove the [wireless card](#).
- 3 Follow the procedure from step 1 to step 9 in "Removing the [palm rest](#)".
- 4 Remove the [display assembly](#).
- 5 Remove the [display bezel](#).
- 6 Remove the [display panel](#).

Procedure

- 1 Peel off the mylar that secures the display-board cables and the display-panel AlienFX LEDs to the display back-cover.
- 2 Disconnect the camera cable from the camera module.

3 Peel off the mylar to access the Alienware AlienHead LED board.

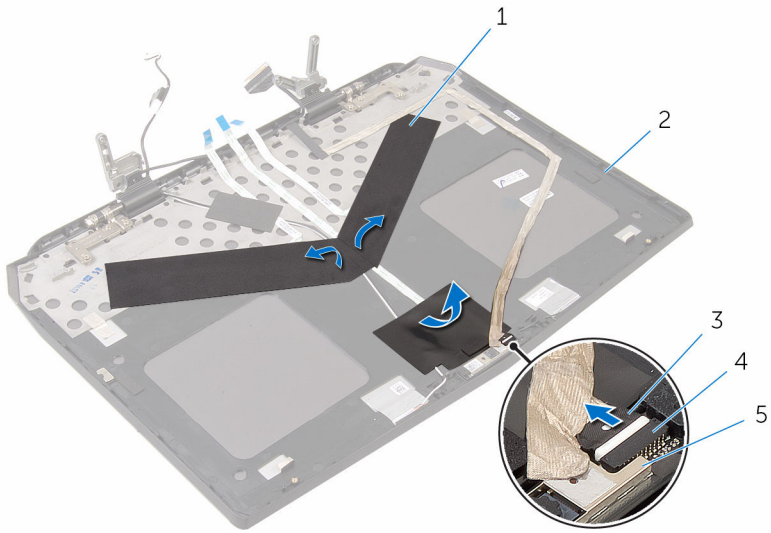

1 mylar

2 display back-cover

3 camera cable

4 connector

5 camera module

4 Lift the display-board cable and Alienware AlienHead LED board off the display back-cover.

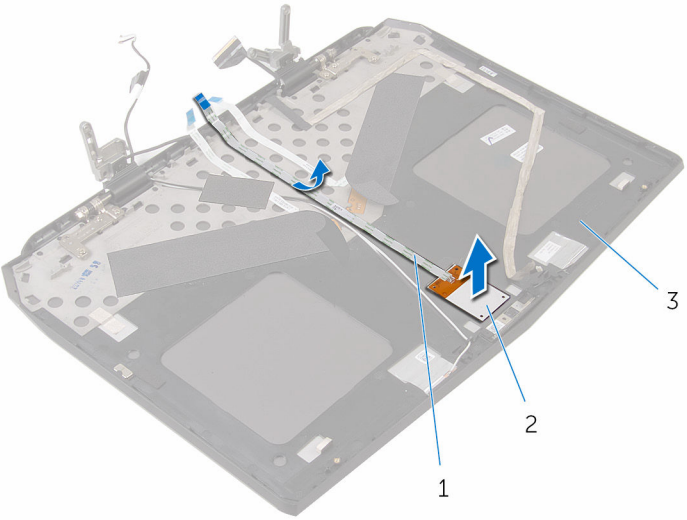

1 display-board cable

2 Alienware AlienHead LED board

3 display back-cover

Replacing the Alienware AlienHead LED board



WARNING: Before working inside your computer, read the safety information that shipped with your computer and follow the steps in [Before working inside your computer](#). After working inside your computer, follow the instructions in [After working inside your computer](#). For more safety best practices, see the Regulatory Compliance home page at www.dell.com/regulatory_compliance.

Procedure

- 1 Connect the camera cable to the camera module.
- 2 Adhere the Alienware AlienHead LED board and display-board cable to the display back-cover.
- 3 Adhere the mylar to secure the Alienware AlienHead LED board and display-board cable and to the display back-cover.
- 4 Adhere the mylar to secure the display-board cables and the display-panel AlienFX LEDs to the display back-cover.

Post-requisites

- 1 Replace the [display panel](#).
- 2 Replace the [display bezel](#).
- 3 Replace the [display assembly](#).
- 4 Follow the procedure from step 5 to step 11 in "Replacing the [palm rest](#)".
- 5 Replace the [wireless card](#).
- 6 Replace the [base panel](#).

Removing the display back-cover



WARNING: Before working inside your computer, read the safety information that shipped with your computer and follow the steps in [Before working inside your computer](#). After working inside your computer, follow the instructions in [After working inside your computer](#). For more safety best practices, see the Regulatory Compliance home page at www.dell.com/regulatory_compliance.

Prerequisites



NOTE: This chapter is applicable only if you have purchased a laptop with non-touchscreen display.

- 1 Remove the [base panel](#).
- 2 Remove the [wireless card](#).
- 3 Follow the procedure from step 1 to step 9 in “Removing the [palm rest](#)”.
- 4 Remove the [display assembly](#).
- 5 Remove the [display bezel](#).
- 6 Remove the [display panel](#).
- 7 Remove the [camera](#).
- 8 Remove the [display-panel AlienFX LEDs](#).
- 9 Remove the [Alienware AlienHead LED board](#).

Procedure

- 1 Disconnect the camera cable from the camera module.
- 2 Remove the display-board cable from the routing guides on the display back-cover.

- 3** Peel the display-board and camera cable off the display back-cover.

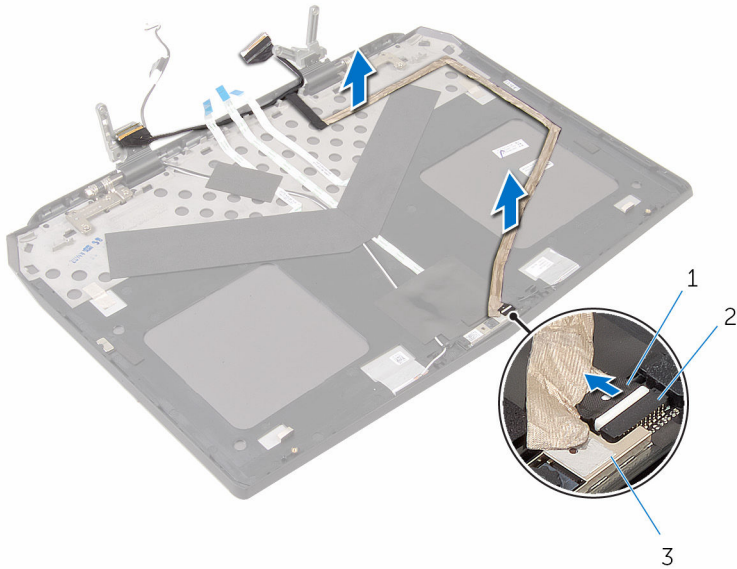

- 1 camera cable
3 camera module

- 2 connector

- 4** Remove the AlienFX Display light.
5 Remove the AlienFX AlienHead board.

6 We are left with the display back-cover.

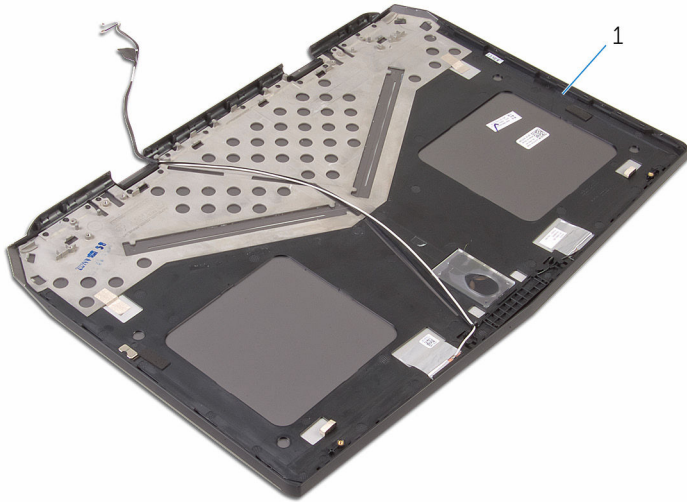

1 display back-cover

Replacing the display back-cover



WARNING: Before working inside your computer, read the safety information that shipped with your computer and follow the steps in [Before working inside your computer](#). After working inside your computer, follow the instructions in [After working inside your computer](#). For more safety best practices, see the Regulatory Compliance home page at www.dell.com/regulatory_compliance.

Procedure



NOTE: This chapter is applicable only if you have purchased a laptop with non-touchscreen display.

- 1 Replace the AlienFX AlienHead board.
- 2 Replace the AlienFX Display light.
- 3 Adhere the display-board and camera cable to the display back-cover.
- 4 Route the display-board cable through the routing guides on the display back-cover.
- 5 Connect the camera cable to the camera module.

Post-requisites

- 1 Replace the [Alienware AlienHead LED board](#).
- 2 Replace the [display-panel AlienFX LEDs](#).
- 3 Replace the [camera](#).
- 4 Replace the [display panel](#).
- 5 Replace the [display bezel](#).
- 6 Replace the [display assembly](#).
- 7 Follow the procedure from step 5 to step 11 in "Replacing the [palm rest](#)".
- 8 Replace the [wireless card](#).
- 9 Replace the [base panel](#).

BIOS setup program

Overview

 **CAUTION:** Unless you are an expert computer user, do not change the settings in the BIOS setup program. Certain changes can make your computer work incorrectly.

 **NOTE:** Before you change BIOS setup program, it is recommended that you write down the BIOS setup program screen information for future reference.

Use BIOS setup program to:

- Get information about the hardware installed in your computer, such as the amount of RAM, the size of the hard drive, and so on.
- Change the system configuration information.
- Set or change a user-selectable option, such as the user password, type of hard drive installed, enabling or disabling base devices, and so on.

Entering BIOS setup program

- 1 Turn on (or restart) your computer.
- 2 During POST, when the Alienware logo is displayed, watch for the F2 prompt to appear and then press F2 immediately.

 **NOTE:** The F2 prompt indicates that the keyboard has initialized. This prompt can appear very quickly, so you must watch for it, and then press F2. If you press F2 before the F2 prompt, this keystroke is lost. If you wait too long and the operating system logo appears, continue to wait until you see the operating system's desktop. Then, restart your computer and try again.

BIOS setup program options

 **NOTE:** Depending on your computer and its installed devices, the items listed in this section may or may not appear.



Main

System Time	Displays the current time in hh:mm:ss format.
System Date	Displays the current date in mm/dd/yyyy format.
BIOS Version	Displays the BIOS version.
Product Name	Displays the model number of your computer.
Service Tag	Displays the service tag of your computer.
Asset Tag	Displays the asset tag of your computer.
CPU Type	Displays the processor type.
CPU Speed	Displays the processor speed.
CPU ID	Displays the processor identification code.
L1 Cache	Displays the processor L1 cache size.
L2 Cache	Displays the processor L2 cache size.
L3 Cache	Displays the processor L3 cache size.
Integrated Graphics	Displays the integrated graphics.
Discrete Graphics 1	Displays the first discrete graphics installed on your computer.
Fixed HDD	Displays the type of hard-drive installed.
Second HDD	Displays the type of secondary hard-drive installed.
Third HDD	Displays the type of third hard-drive installed.
Fourth HDD	Displays the type of fourth hard-drive installed.
Fifth HDD	Displays the type of fifth hard-drive installed.
AC Adapter Type	Displays the type of AC adapter connected to your computer.

Main

System Memory	Displays the system memory.
Extended Memory	Displays the extended memory.
Memory Speed	Displays the memory speed.

Advanced

Intel(R) SpeedStep (TM)	<p>Allows you to disable or enable Intel (R) SpeedStep Technology.</p> <p> NOTE: If enabled, the processor clock speed and core voltage are adjusted dynamically based on the processor load.</p> <p>Default: Enabled</p>
Virtualization	<p>Allows you to disable or enable the Intel Virtualization technology. Default: Enabled</p>
VT for Direct I/O	<p>Allows you to disable or enable a Virtual Machine Monitor (VMM) to use the additional hardware capabilities provided by Intel(R) Virtualization Technology for Direct I/O. Default: Enabled</p>
Integrated NIC	<p>Allows you to disable or enable the on-board LAN controller. Default: Enabled</p>
USB Emulation	<p>Allows you to enable or disable the USB emulation feature. This feature defines how the BIOS, in the absence of a USB-aware operating system, handles USB devices. USB emulation is always enabled during POST. Default: Enabled</p> <p> NOTE: You cannot boot any type of USB device (floppy, hard drive, or memory key) when this option is disabled.</p>
USB PowerShare	<p>Allows you to charge USB devices when the computer is turned off or in standby mode. Default: Enabled</p>

Advanced

USB Wake Support	Allows you to enable USB devices to wake the computer from standby or to disable the USB wake support feature. Default: Disabled  NOTE: If USB PowerShare is enabled, a device connected to the USB PowerShare connector may not wake the computer.
SATA Operation	Allows you to configure the operating mode of the integrated SATA hard-drive controller. Default: AHCI
Adapter Warnings	Allows you to choose if the computer should display warning messages when you use AC adapters that are not supported by your computer. Default: Enabled
Function Key Behavior	Allows you to set function key or multimedia key as the default function key behavior. Default: Function key
Express Charge	Allows you to charge your computer battery using Standard Charge or Express Charge mode. Default: Express Charge
Touchpad Backlight	Allows you to set the touch pad backlight to be on or in auto mode.
Battery Health	Displays the battery health.



Advanced-Miscellaneous Devices

External USB Ports	Allows you to disable or enable the external USB ports. Default: Enabled
USB debug	Allows you to enable or disable USB port for Windows debugging. Default: Disabled

Advanced-Performance options with Alienware Graphics Amplifier

Overclocking Feature	Allows you to enable or disable global overclocking feature. Default: Disabled
	 NOTE: The following features are available only when the Overclocking Feature is enabled.
Non-Turbo Flex Support	Allows you to enable or disable non-turbo flex support. Default: Enabled
Flex Ratio Override	Allows you to set the flex ratio override value.
Override Turbo Settings	Allows you to enable or disable the override turbo settings. Default: Enabled
Long Duration PWR Limit	Allows you to set the turbo mode long duration power limit.
Long Duration Time Window	Allows you to set the turbo mode time value in seconds.
Short Duration PWR Limit	Allows you to enable or disable short duration power limit. Default: Enabled
Short Duration PWR Limit Options	Allows you to set the turbo mode power limit value in watts.
Bus Clock	
Current Frequency	Displays the current bus clock frequency.
New Frequency in 10KHz increments	Allows you to set the bus clock frequency in increments of 10 KHz.
Apply New Bus Clock Frequency	Applies the new bus clock frequency immediately, temporarily, or permanently.
Intel Graphics Turbo Overclocking	Allows you to disable or enable the Intel Graphics Turbo Overclocking feature.
Memory Override Support	Allows you to enable or disable the memory override option support. Default: Disabled

Security

Unlock Setup Status	Displays if the setup status is unlocked. Default: Unblocked.
Admin Password Status	Displays if the administrator password is clear or set. Default: Not set
System password Status	Displays if the system password is clear or set. Default: Not set
HDD password Status	Displays if the HDD password is clear or set. Default: Not set
	 NOTE: The password is set for all the installed hard drives on your computer.
Service Tag	Displays the Service Tag of the computer when the Service Tag is present. Displays a field to input the Service Tag manually when the Service Tag is absent.
	 NOTE: The Service Tag option is available only when the Service Tag is not set.
Admin Password	Allows you to set the administrator password. The administrator password controls access to the BIOS setup program utility.
System Password	Allows you to set the system password. The system password controls access to the computer at boot.
HDD password	Allows you to set, change, or delete the hard-drives password.
Password Change	Allows you to permit or deny system password or HDD password changes. Default: Permitted

Exit

Save Changes and Reset	Allows you to exit the BIOS setup program and save your changes.
Discard Changes and Reset	Allows you to exit the BIOS setup program and load previous values for all BIOS setup program options.
Restore Defaults	Allows you to restore default values for all BIOS setup program options.
Discard Changes	Allows you to load previous values for all BIOS setup program options.
Save Changes	Allows you to save the changes for all BIOS setup program options.

Boot sequence

This feature allows you to change the sequence of devices that your computer attempts to boot from. If the computer cannot boot from the device you select, it attempts to boot from the next bootable device. You can use this feature to change the:

- **Current Boot Sequence** — change the boot sequence for the current boot, for example, to boot from the optical drive to run Alienware Diagnostics from the Drivers and Utilities disc or to reinstall your operating system using an external media. The previous boot sequence is restored at the next boot.
- **Future Boot Sequence** — change the boot sequence for all future boots, for example, to boot from the primary hard drive.

Boot options

 **NOTE:** The following boot options are available only when the Boot List Option is set to Legacy.

Floppy (Diskette Drive) — The computer attempts to boot from the floppy disk drive. If no operating system is on the drive, the computer generates an error message.

Hard Drive — The computer attempts to boot from the primary hard drive. If no operating system is on the drive, the computer generates an error message.

CD/DVD/CD-RW Drive — The computer attempts to boot from the optical drive. If no disc is in the drive, or if the disc is not bootable, the computer generates an error message.

USB Storage Device — Insert the memory device into a USB connector and restart the computer. When **F12 Boot Options** appear in the lower-right corner of the screen, press F12. The BIOS detects the device and adds the USB flash option to the boot menu.

 **NOTE:** To boot to a USB device, the device must be bootable. To ensure that your device is bootable, check the device documentation.

Network — The computer attempts to boot from the network. If no operating system is found on the network, the computer generates an error message.

Changing boot sequence for the current boot

- 1 If you are booting from a USB device, connect the USB device to a USB port.
- 2 Turn on (or restart) your computer.
- 3 When **F2 Setup, F12 Boot Options** appear in the lower-right corner of the screen, press F12.

 **NOTE:** If you wait too long and the operating system logo appears, continue to wait until you see the Microsoft Windows desktop. Then, shut down your computer and try again.

The **Boot Options** appears, listing all available boot devices.

- 4 On the **Boot Options**, select the device you want to boot from and press Enter.
For example, if you are booting to a USB hard drive, highlight **USB Hard Disk** and press Enter.

Changing boot sequence for future boots

- 1 Enter BIOS setup program.
See "[Entering BIOS setup program](#)".
- 2 Use the arrow keys to highlight the **Boot** menu option and press Enter to access the menu.
 **NOTE:** Note your current boot sequence in case you want to restore it.
- 3 Navigate to **Set Boot Priority** to configure the boot priority.
- 4 Use the arrow keys to highlight the boot priority and press Enter to display the different devices.
- 5 Select the device and press Enter to set the boot priority.

Flashing the BIOS



You may need to flash (update) the BIOS when an update is available or when you replace the system board. To flash the BIOS:

- 1 Turn on the computer.
- 2 Go to **www.dell.com/support**.
- 3 Click **Product Support**, enter the Service Tag of your computer and click **Submit**.
 -  **NOTE:** If you do not have the Service Tag, use the auto-detect feature or manually browse for your computer model.
- 4 Click **Drivers & downloads**.
- 5 Select the operating system installed on your computer.
- 6 Scroll down the page and expand **BIOS**.
- 7 Click **Download File** to download the latest version of the BIOS for your computer.
- 8 Save the file and, once the download is complete, navigate to the folder where you saved the BIOS update file.
- 9 Double-click the BIOS update file icon and follow the instructions on the screen.

Getting help and contacting Alienware

Self-help resources

You can get information and help on Alienware products and services using these online self-help resources:

Information about Alienware products and services	www.alienware.com
Windows 8.1 and Windows 10	Dell Help & Support app 
Windows 10	Get started app 
Windows 8.1	Help + Tips app 
Accessing help in Windows 8, Windows 8.1, and Windows 10	In Windows search, type Help and Support, and press Enter.
Accessing help in Windows 7	Click Start → Help and Support.
Online help for operating system	www.dell.com/support/windows www.dell.com/support/linux
Troubleshooting information, user manuals, setup instructions, product specifications, technical help blogs, drivers, software updates, and so on	www.alienware.com/gamingservices
Videos providing step-by-step instructions to service your computer	www.youtube.com/alienwareservices

Contacting Alienware

To contact Alienware for sales, technical support, or customer service issues, see www.alienware.com.



NOTE: Availability varies by country and product, and some services may not be available in your country.



NOTE: If you do not have an active internet connection, you can find contact information on your purchase invoice, packing slip, bill, or Dell product catalog.