

Dell Venue Pro 11 -7130/7139

User's Guide

Regulatory Model: T07G
Regulatory Type: T07G001



Notes, Cautions, and Warnings

 **NOTE:** A NOTE indicates important information that helps you make better use of your computer.

 **CAUTION:** A CAUTION indicates either potential damage to hardware or loss of data and tells you how to avoid the problem.

 **WARNING:** A WARNING indicates a potential for property damage, personal injury, or death.

© 2014 Dell Inc. All Rights Reserved.

Trademarks used in this text: Dell™, the DELL logo, Venue™, and Wi-Fi Catcher™ are trademarks of Dell Inc. Intel®, Xeon®, Core™, and Atom™, are registered trademarks or trademarks of Intel Corporation in the U.S. and other countries. Microsoft®, Windows®, MS-DOS®, Windows Vista®, the Windows Vista start button, and Office Outlook® are either trademarks or registered trademarks of Microsoft Corporation in the United States and/or other countries. Wi-Fi® is a registered trademark of Wireless Ethernet Compatibility Alliance, Inc.

2014 -12

Rev. A02

Contents

1 Working on Your Tablet.....	5
Before Working Inside Your Tablet.....	5
Turning off Your Tablet.....	6
2 Setting Up Your Tablet.....	8
Charging the Tablet.....	8
Turning On Your Tablet.....	9
Turning off the Screen.....	10
Using power buttonUsing Charms.....	10
3 Using Your Tablet.....	11
Screen Orientation.....	11
How to lock / unlock the screen orientation.....	11
Adjusting the screen brightness.....	11
Gestures.....	12
Right-Click.....	14
The Windows Start Screen.....	14
How to access the Start screen.....	14
Get to know Windows 8.1.....	15
Swipe Right.....	15
Swipe Left.....	15
Swipe Up/Down.....	15
Split Screen.....	16
Using Headphones.....	16
Removing the Micro-SD card.....	17
Removing the Battery.....	17
Installing the Battery.....	18
Installing the micro-SIM Card.....	18
4 Managing your tablet settings.....	20
Wi-Fi setting.....	20
Turning On/Off Wi-FiConnecting to a network.....	20
Mobile broadband setting.....	21
Turning On/Off mobile broadbandConnecting to a mobile broadband networkDisconnecting from mobile broadband networkMobile broadband optionsService Provider hardware informationEnabling PIN lock.....	21
Refreshing / Recovering / Re-setting your tablet.....	23

Refresh your PC without affecting your files	
Remove everything and re-install Windows	
Advanced startup	24
5 Synchronizing your tablet	25
Using Microsoft account	25
Copying music, photos, and videos	25
6 Optional Stylus Features	26
Getting Your Stylus Ready for Use	26
Using the Optional Stylus with Your Tablet	27
7 Desktop Dock Features	28
Docking Your Tablet	29
Connecting the Power Adapter	30
8 Thin Travel Keyboard Dock Features	31
Docking Your Tablet to the Thin Travel Keyboard Dock	31
9 Mobile Keyboard Dock Features	33
Docking Your Tablet to the Keyboard Dock	33
Undocking Your Tablet from the Keyboard Dock	34
Charging the dock	34
Battery behavior	35
10 Cleaning Your Tablet	36
11 Troubleshooting	37
Battery problem	37
System problem	38
Touchscreen problem	39
Network problem	39
12 System Setup	40
System Setup (BIOS) Options	40
Updating the BIOS	49
13 Specifications	51
14 Contacting Dell	55

Working on Your Tablet

Before Working Inside Your Tablet

Use the following safety guidelines to help protect your tablet from potential damage and to help to ensure your personal safety. Unless otherwise noted, each procedure included in this document assumes that the following condition exists:

- You have read the safety information that shipped with your tablet.

 **WARNING:** Before working inside your tablet, read the safety information that shipped with your tablet. For additional safety best practices information, see the Regulatory Compliance Homepage at www.dell.com/regulatory_compliance

 **CAUTION:** Many repairs may only be done by a certified service technician. You should only perform troubleshooting and simple repairs as authorized in your product documentation, or as directed by the online or telephone service and support team. Damage due to servicing that is not authorized by Dell is not covered by your warranty. Read and follow the safety instructions that came with the product.

 **CAUTION:** To avoid electrostatic discharge, ground yourself by using a wrist grounding strap or by periodically touching an unpainted metal surface, such as a connector on the back of the tablet.

 **CAUTION:** Handle components and cards with care. Do not touch the components or contacts on a card. Hold a card by its edges or by its metal mounting bracket.

 **CAUTION:** When you disconnect a cable, pull on its connector or on its pull-tab, not on the cable itself. Some cables have connectors with locking tabs; if you are disconnecting this type of cable, press in on the locking tabs before you disconnect the cable. As you pull connectors apart, keep them evenly aligned to avoid bending any connector pins. Also, before you connect a cable, ensure that both connectors are correctly oriented and aligned.

 **NOTE:** The color of your tablet and certain components may appear differently than shown in this document.

To avoid damaging your tablet, perform the following steps before you begin working inside the tablet.

1. Ensure that your work surface is flat and clean to prevent the tablet cover from being scratched.
2. Turn off your tablet (see [Turning Off Your Tablet](#)).
3. If the tablet is connected to a docking device (docked) such as the optional docking station or keyboard dock, un-dock it.
4. Disconnect the power adapter from the tablet.
5. Turn the tablet upside-down on a flat work surface.
 -  **NOTE:** To avoid damaging the system board, you must remove the main battery before you service the tablet.
6. Remove the main battery.
7. Press and hold the power button for a few seconds to remove the flea power from the system board.

△ **CAUTION:** To guard against electrical shock, always unplug your tablet from the electrical outlet.

△ **CAUTION:** Before touching anything inside your tablet, ground yourself by touching an unpainted metal surface, such as the metal at the back of the tablet. While you work, periodically touch an unpainted metal surface to dissipate static electricity, which could harm internal components.

8. Remove the storage SD card from the tablet.

Turning off Your Tablet

Turning off your tablet completely shuts down your tablet. You can turn off your tablet by two ways:

- Using power button
- Using charms menu

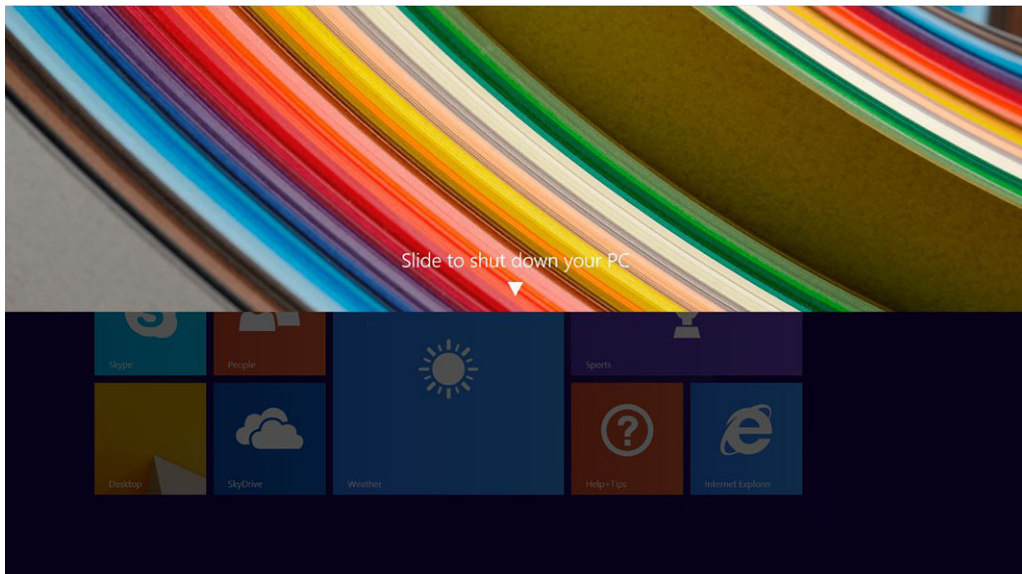

1. To turn off your tablet using power button:

- a. Press and hold the **Power** button  until you see "Slide to shut down your PC" on the screen.





 **NOTE:** After you press and hold the **Power** button, by default, the "Slide to shut down your PC" screen displays only in *Venue 11 Pro 7130*. For *Venue 11 pro 7130 vPro* and *Venue 11 Pro 7139*, by default, the tablet enters sleep mode. However, if you change the power button setting to shut down, the tablet shuts down. To change the power button setting, go to **Control Panel > Power Options > Change Plan Setting > Change Advanced Power Settings**. To access Control Panel, swipe at the right edge of the screen, tap **Search**, enter **Control Panel** in the search box, and then click **Control Panel**.

- b. Slide to shut down your tablet.

 **NOTE:** You can also turn off your tablet without sliding down the screen. Press and hold the **Power**  button for >10 seconds to turn off your tablet. You can perform this force shutdown, if your tablet is not responding / behaving unexpectedly or touch is not working.

2. To turn off your tablet using the charms menu:

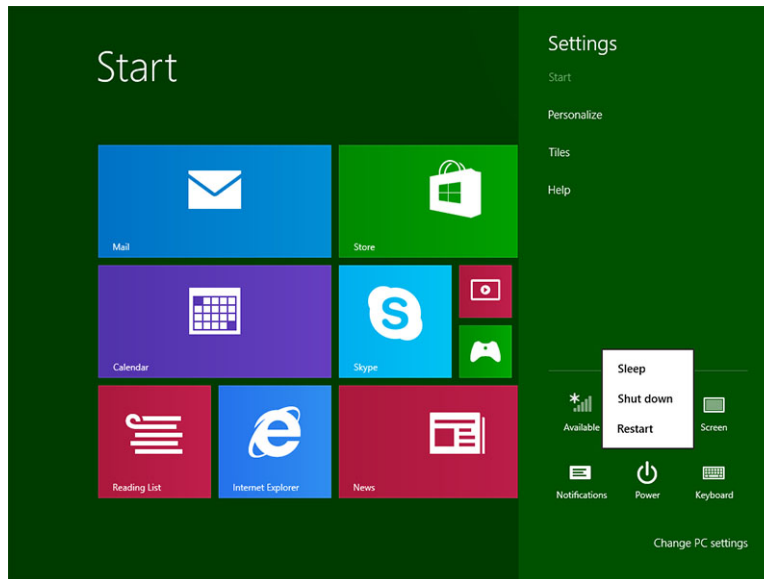

a. Swipe from the right edge of the display to access the **Charms** menu.

b. Touch **Settings**  → **Power**  → **Shut down** to turn off the tablet.



Setting Up Your Tablet



Charging the Tablet

-  **CAUTION:** Charge the battery in an ambient temperature of 0 °C to 40 °C.
-  **CAUTION:** Use only the power adapter and power cable that came with your tablet. Using unauthorized power adapters or power cables may cause severe damage to your tablet.
-  **NOTE:** The battery is not fully charged when you unpack your tablet.

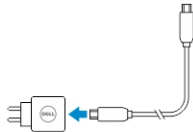
1. Connect the power cable into the power adapter.



2. Connect the power adapter to an electrical outlet and charge the tablet until the battery is fully charged.







-  **NOTE:** The tablet battery requires about 4 hours to fully charge.
-  **NOTE:** You can also trickle charge the tablet via micro-USB connection. The battery takes up to 24 hours to fully charge depending on the power output of the USB port.

You can check the tablet battery charge status from:

- Battery-charge light located on the front of the tablet:

LED Behavior	Description
Solid white color on	Battery is charging.
Off	Battery is not charging. Either no AC adapter is connected or battery is fully charged.
Amber color on Momentarily	<ul style="list-style-type: none"> – The LED will be solid amber for 2 seconds and then change to solid white. This is an indication that the system cannot power on with the current state of charge, but the battery is being charged. – Battery is charging – The tablet will not power on.

-  **NOTE:** You can check the exact battery charge level by booting to the operating system.
- Battery icons displayed on the screen:

Battery icon	Description
	Battery is fully charged and AC adapter is connected.
	Battery is charging with AC adapter.
	Your tablet is running on battery power and the battery is discharging.
	Your tablet is plugged in, and either no battery is detected or the battery is not working correctly.
	Battery is at low level.
	Battery is at critical level.

Turning On Your Tablet

 **NOTE:** Use this tablet in an ambient temperature between 0 °C and 40 °C.

1. Press and hold the **Power** button  for 2 seconds to turn on your tablet.
2. If the lock screen image displays, swipe your finger from the bottom of the display to switch to the login screen, and then enter password to log in to Windows.

The tablet is ready for use after the Windows Start screen displays.

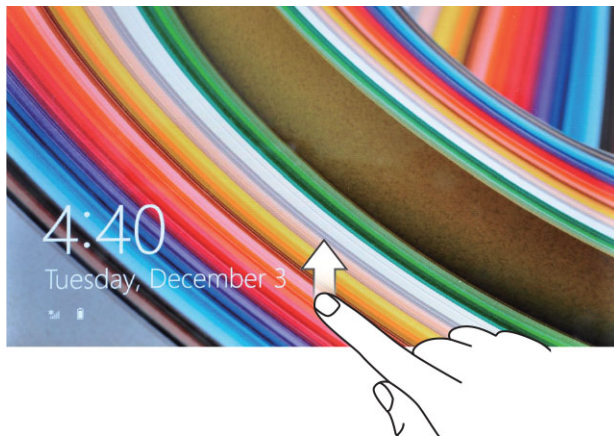

 **NOTE:** If the login screen is not enabled in Windows 8.1, you will be taken directly from the lock screen to the start screen.



 **NOTE:** The lock screen is only displayed when returning from a sleep state.



Turning off the Screen

Using power button

Press the **Power** button  to turn off the screen.

Using Charms

1. Swipe from the right edge of the display to access the Charms bar.
2. Touch **Settings**  → **Power**  → **Sleep** to turn off the screen.

 **NOTE:** If your tablet is in a sleep state, press the **Power** button  or **Windows** button  once to turn on the screen.





Using Your Tablet

Screen Orientation

For optimal viewing experience, the screen orientation changes automatically to portrait or landscape format depending on how you hold the tablet.

 **NOTE:** Some applications may not support automatic screen rotation to portrait or landscape format.

How to lock / unlock the screen orientation

1. Swipe from the right edge of the display to access the Charms bar.
2. Touch **Settings**  → **Screen** .
3. Touch  toggle to lock the screen orientation, or touch  toggle to unlock the screen orientation.

Adjusting the screen brightness

You can also adjust the screen brightness here by using the slider under the toggle  menu.





You can also adjust your screen automatically. To adjust the screen brightness automatically:

1. Swipe from the right edge of the display to access the Charms bar.
2. Touch **Settings**  → **PC settings** → **PC and devices** → **Power and sleep**.
3. Under Brightness, slide left or right to turn on / turn off the automatic brightness option.

 **NOTE:** You can turn on / turn off the slider to have the screen automatically adjust the brightness, based on the ambient light.

Gestures

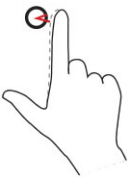
Your tablet has a multi-touch display. You can touch the screen to operate the tablet.

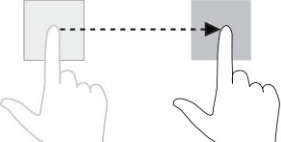
Gesture Actions	Functions
Touch Tap gently on the display with your fingertip.	<ul style="list-style-type: none">• Select items on the screen, including options, entries, images, and icons• Start applications• Touch buttons on the screen• Input text using the on-screen keyboard
	
Touch and Hold Touch and hold your finger on the display	<ul style="list-style-type: none">• Display detailed information about an item• Open the context menu of an item to perform further actions
	
Drag and Drop <ol style="list-style-type: none">1. Touch and hold your finger on an item on the screen2. Keeping your finger in contact with the display, move your fingertip to the desired location3. Take your finger off the display to drop the item in the desired location	Move item such as images and icons on the screen
	

Gesture Actions

Functions

Swipe or Slide

Move your finger in a vertical or horizontal direction on the display

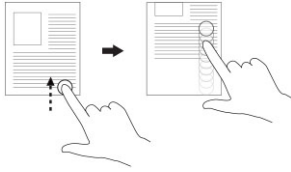

- Scroll through the Start screen, web pages, lists, entries, photos, contacts, and so on
- Close an application. (Swipe the application to the bottom of the display)

Zoom in

Touch the display with two fingers and then move the fingers apart

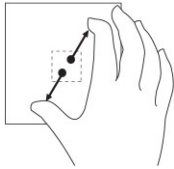

Enlarge the view of an image or web page

Zoom out

Touch the display with two fingers and then move the fingers closer

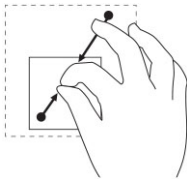

Reduce the view of an image or web page

Rotate

Touch the display with two or more fingers and then move the fingers in a clockwise or counter-clockwise arc

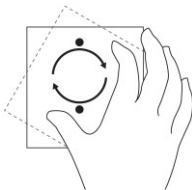

Rotate an object by 90 degrees

Right-Click

To perform a right-click on your tablet, Touch and Hold your finger for 2 seconds on any section of the screen or an icon and then release your finger.

The options menu appears on the screen.

The Windows Start Screen

The Windows Start screen displays a list of default and custom Live Tiles, which act as a shortcut to Control Panel, Windows Explorer, Weather application, RSS, Windows Store, Internet Explorer, and other installed applications.

Live Tiles on your Start screen change and update in real time so you can get real-time updates about news or sports, check what your friends are up to, and get the latest weather forecast.



The tile-based user interface gives you direct access to your most recently used applications, Emails, photos, music, videos, contacts, Facebook & Twitter updates, and frequently viewed websites. You can pin your favorite or frequently used applications as Live Tiles to customize the Start screen.

You also can personalize the Start screen by setting your favorite picture as a wallpaper.

 **NOTE:** Live Tiles can be added or removed by using Pin  or Unpin  options.

How to access the Start screen

Follow either method to access the Start screen:

- Press the **Windows** button .
- Swipe from the right edge of the display to access the Charms bar, and then touch the **Start** icon .

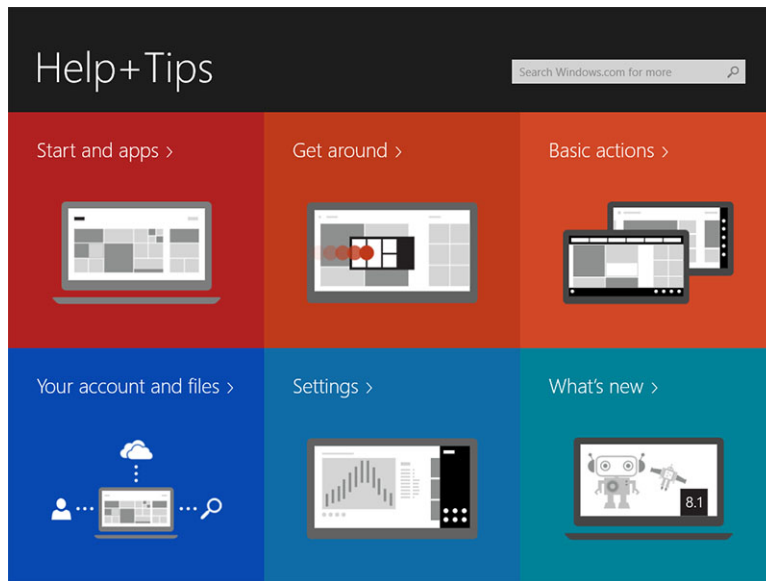

Get to know Windows 8.1

You can touch the Help+Tips tile on the Start screen to get help and tips on using Windows 8.1.



Swipe Right

Swiping-in from the right edge of the display reveals the Charms bar. Charms provide access to the system commands, such as Start, Search, Share, Devices, and Settings options.

If your tablet is running on an application or performing actions, pressing the **Start** icon  takes you back to the Start screen. If you are at the Start screen, pressing the **Start** icon  takes you to the most recently used application or most recently viewed screen.

 **NOTE:** The functionality of the **Start** icon  is same as **Windows** button .

Swipe Left

- Swiping slowly from the left edge to the right edge of the display reveals thumbnails of the open applications and cycles the thumbnails of the open applications.
- Swiping-in and out on the left edge of the display brings up a list of the most recently used applications.

Swipe Up/Down



- Swiping-in from the bottom or top edge of the display reveals the **All apps** icon . Touch **All apps** to show an alphabetical list of all applications installed on your tablet.
- Swiping-in from the top to the bottom of an application docks or closes the application.

For more information on using Windows Start screen, visit windows.microsoft.com/en-us/windows-8/start-screen-tutorial.

You can also enable the camera (front), when the screen is in lock mode. To enable the camera when the screen is in lock mode:

1. Swipe from the right edge of the display to access the Charms bar.
2. Click **Settings**  → **Change PC Settings** → **PC and Devices**
3. Scroll down and navigate to **Camera**.
4. Swipe to turn on, to use the camera during the lock screen mode.

To make sure you can use the camera during the lock screen mode:

1. Press **Power**  button to turn off the screen.
2. Press **Power**  button again to enable the lock screen mode.
3. Swipe down to enable the **camera**.

Split Screen

The split screen option enables you to open two applications on the same screen, which helps you in multitasking. To split the screen:

1. Open any two applications that you want to perform the split screen.
2. Swipe from the left to open the second application and hold your finger until the screen splits.
3. Release your finger to drop the second application.

 **NOTE:** Windows 8.1 enables you to split the screen in variable width.

Using Headphones

You can use headphones to listen to music and sounds, record audio, or make calls.

 **WARNING:** Listening to loud music for extended period of time can lead to hearing loss.

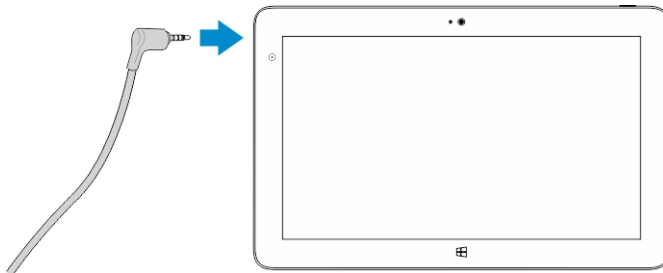

1. Connect the headphones to the audio port (3.5 mm) on the tablet.
2. Insert the earphones in your ears and adjust the volume level to a comfortable level.

 **NOTE:** When you connect a headphone or an external audio device to the audio connector, the integrated speakers on your tablet are muted automatically.

 **CAUTION:** To prevent damage to the headphones when disconnecting it from the tablet, pull the connector and not the cable.

 **NOTE:** It is recommended that you turn down the volume level before plugging the headphone, and then adjust to a comfortable level. Sudden exposure to loud sounds can cause hearing damage.

Removing the Micro-SD card

 **CAUTION:** Removing the Micro-SD card when transferring data may cause data loss or result in application errors. Make sure your tablet has finished all save operations to the Micro-SD card.

1. Enter the Desktop mode. Touch **Safely Remove Hardware**  in the notification area at the bottom-right corner of the screen.

 **NOTE:** If you don't see **Safely Remove Hardware** , touch **Show Hidden Icons** to display all icons in the notification area.

2. Touch **Eject SD Memory Card**. A message appears confirming that the Micro-SD card can be safely removed. If a warning message appears stating the Micro-SD card cannot be removed, ensure all data transfers involving the Micro-SD card are complete.
3. Insert the tip of a small bent paperclip into the small hole on the micro-SD slot cover.
4. Push the tip all the way into the hole until the micro-SD tray ejects. Pull the micro-SD card tray out.
5. Remove the micro-SD card from the tray.

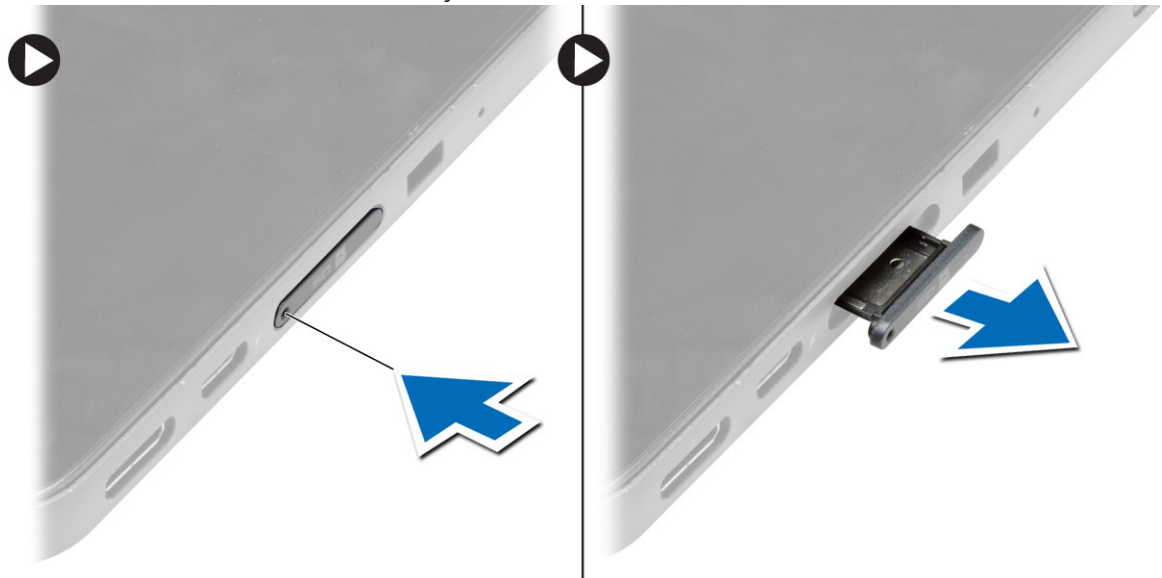

Removing the Battery

1. Follow the procedures in *Before Working Inside Your Tablet*.
2. Remove the base cover.
3. Perform the following steps:
 - a. Slide the release latch in the direction indicated to unlock the battery.
 - b. Push the battery forward to release it from its connector on the system board.
 - c. Lift and remove the battery from the tablet.

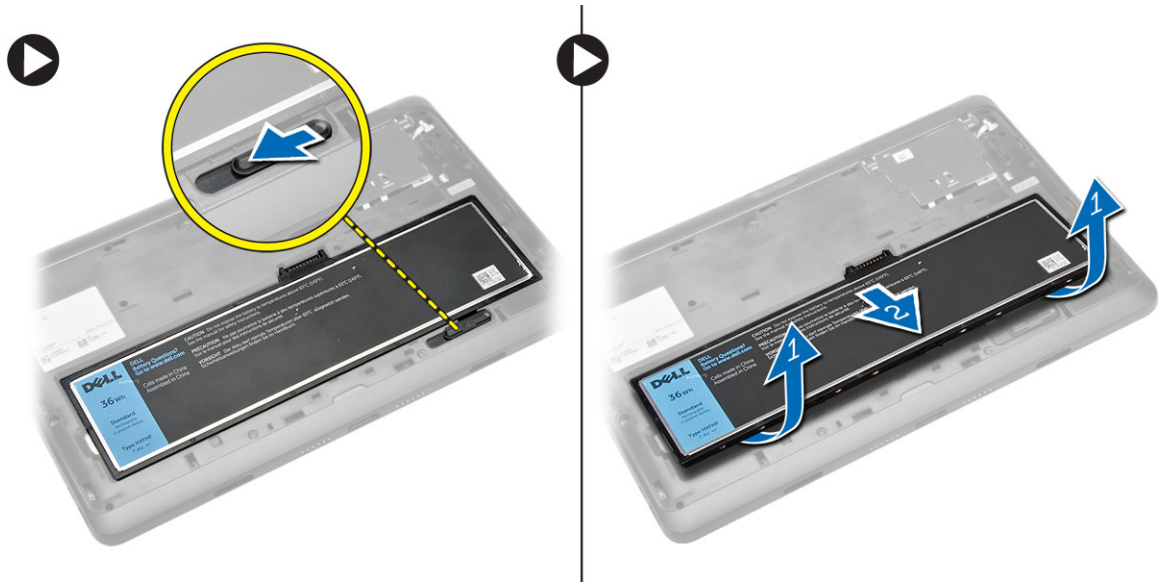

Installing the Battery

1. Slide the battery into its slot until it clicks into place.
2. Install the base cover.

Installing the micro-SIM Card

⚠ CAUTION: Removing the Micro-SIM card when the tablet is on may cause data loss or damage the card. Make sure your tablet is turned off or the network connections are disabled.

1. Turn off your tablet. For more information on turning off your tablet, see [Turning off Your Tablet](#).
2. Pry the base cover in the direction indicated and lift it at an upward angle to remove it from the tablet.

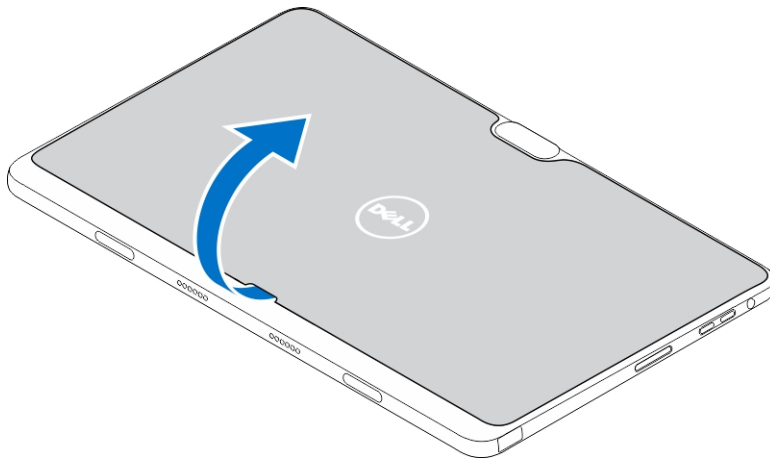

3. Slide the release latch in the direction indicated to unlock the battery. Lift and remove the battery from the tablet.

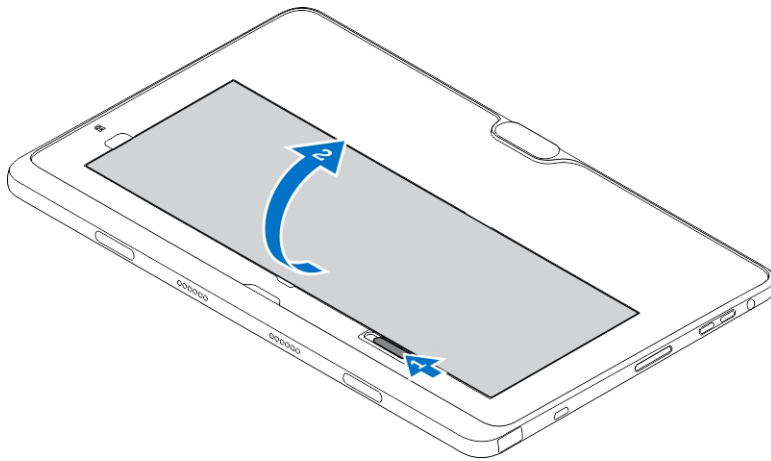

4. Insert the micro-SIM card into its slot.

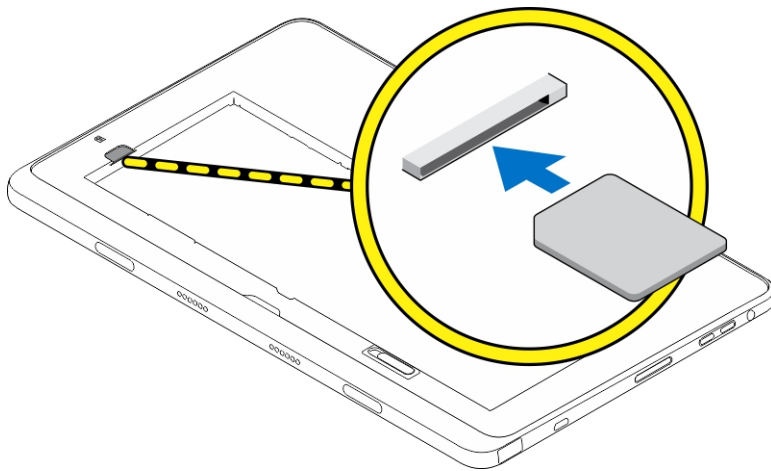

Managing your tablet settings

Wi-Fi setting

Turning On/Off Wi-Fi

1. Swipe from the right edge of the display to access the Charms bar.
2. Touch **Settings**  → **Change PC settings** → **Networks** → **Airplane mode**.
3. Swipe Wi-Fi icon right or left to turn Wi-Fi on or off.

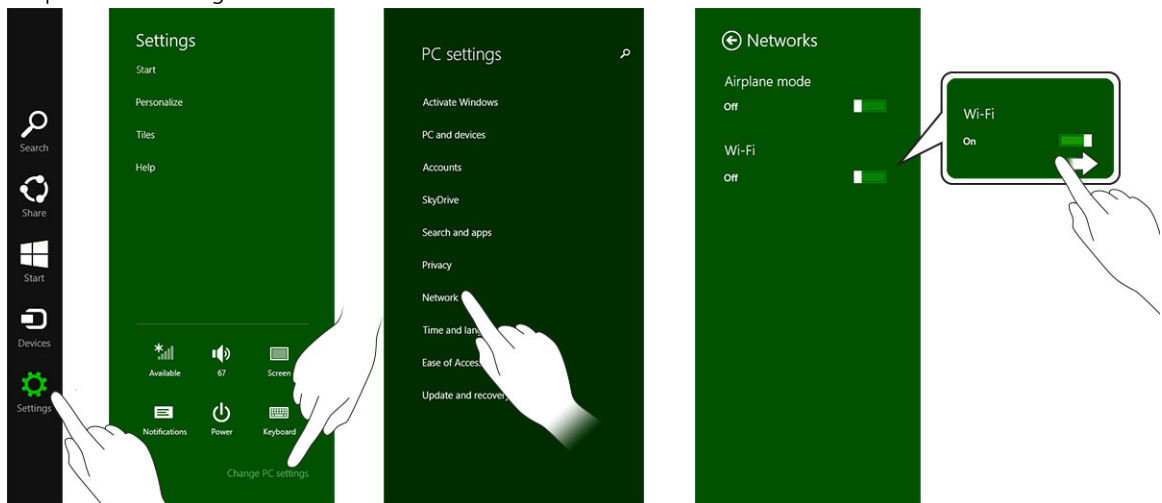

Connecting to a network

1. Swipe from the right edge of the display to access the Charms bar.
2. Touch **Settings**  → **Available**  → **Select an available network** → **Connect**

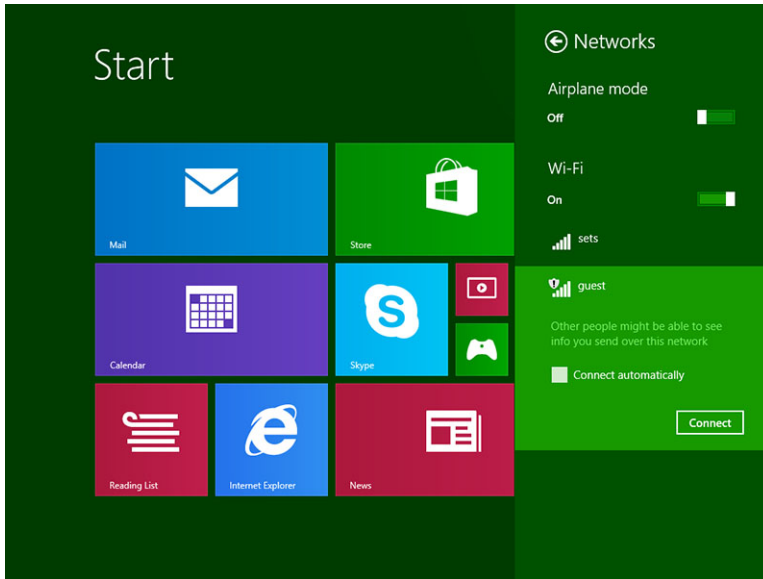

Mobile broadband setting

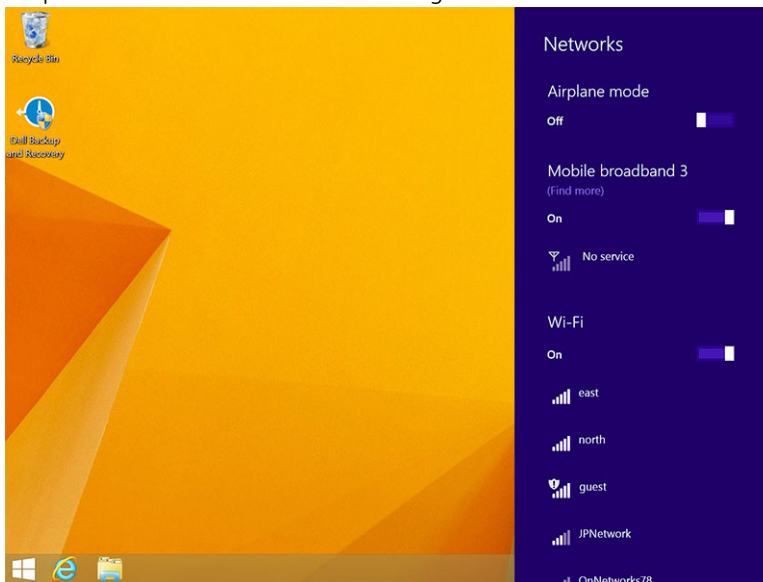

Turning On/Off mobile broadband

1. Swipe from the right edge of the display to access the Charms bar.
2. Touch **Settings**  → **Change PC settings** → **Networks** → **Airplane mode**.
3. Swipe **Mobile broadband** icon left or right to turn mobile broadband on or off.





Connecting to a mobile broadband network

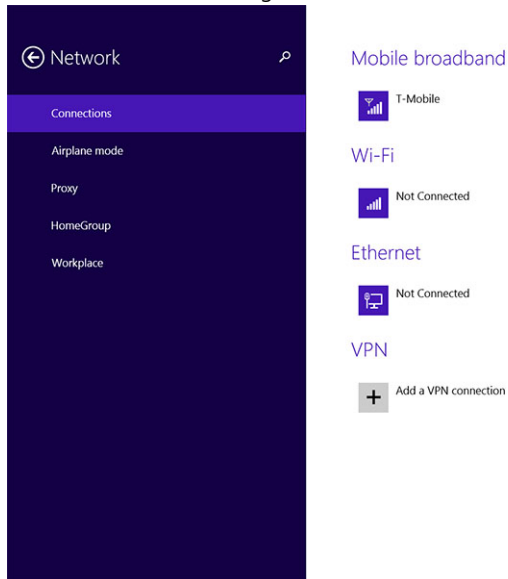

1. Ensure an active SIM card is inserted into the tablet.
2. Swipe from the right edge of the display to access the Charms bar.

3. Touch **Setting**  → **Network** → **Connections**  → **Your Service Provider** → **Connect**.
4. The estimated data usage will be shown once the mobile broadband network is enabled.





-  **NOTE:** You can choose the option **Connect automatically** to connect the mobile broadband automatically.
-  **NOTE:** Your tablet will automatically prioritize Wi-Fi networks over mobile broadband networks, when both are available. If your tablet is connected to the mobile broadband and any of saved Wi-Fi connections comes within range, it will disconnect from the mobile network and connect to the Wi-Fi automatically. For more information on turning on Wi-Fi network, see [Wi-Fi setting](#).

Disconnecting from mobile broadband network

1. Swipe from the right edge of the display to access the Charms bar.
2. Touch **Setting**  → **Network**  → **Your Service Provider** → **Disconnect**.

-  **NOTE:** Once your tablet has disconnected from mobile broadband, the option **Connect automatically** will be disabled as well.

Mobile broadband options

1. Swipe from the right edge of the display to access the Charms bar.
2. Touch **Settings**  → **Networks** .
3. Touch and hold **Your Service Provider** or right-click if docked.
 - Touch **Show estimated data usage/Hide estimated data usage** to show or hide your data usage.
 - Touch **Set as metered connection/Non metered connection** to set a particular connection as a metered/non-metered connection.
 - Touch **View connection properties** to view your connected mobile broadband properties.



-  **NOTE:** If the option **Set as metered connection** is enabled, Windows Update will not download updates automatically unless it is a high priority, critical security update.

Service Provider hardware information

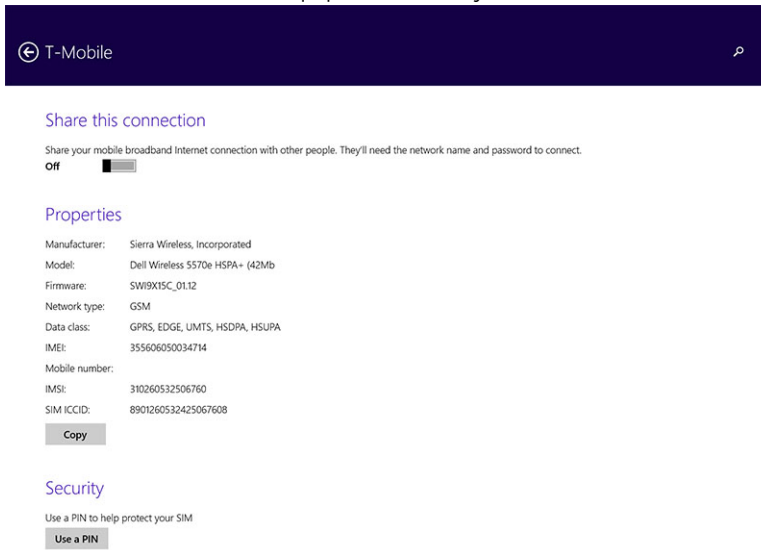
1. Swipe from the right edge of the display to access the Charms bar.
2. Touch **Settings**  → **Change PC settings** → **Network**.
3. Touch **Your Service Provider** to view the hardware information including the subscriber information and International Mobile Equipment Identity (IMEI) number.



Enabling PIN lock

1. Swipe from the right edge of the display to access the Charms bar.
2. Touch **Settings**  → **Network** .
3. Touch and hold **Your Service Provider** or right-clicked if docked.
4. Touch **View connection properties** → **Security** → **Use a PIN**.
5. Enter your **SIM PIN Code**.

 **NOTE:** **Your Service Provider** refers to the network service providers available in your location.

 **CAUTION:** If you enter the incorrect PIN code, your mobile broadband connection will not be established. If you unsuccessfully enter the code three times, your SIM card will be locked. To unlock the SIM card, contact your service provider to get a Personal Unblocking Key (PUK) to unlock the SIM card.

 **NOTE:** Before you contact your carrier, have your IMEI number ready.

Refreshing / Recovering / Re-setting your tablet

You can refresh / recover / restore your tablet to original factory settings.

1. Swipe from the right edge of the display to access the Charms bar.
2. Touch **Settings**  → **Change PC Settings** → **Update and recovery** → **Recovery**.

- **Refresh your PC without affecting your files**
 - **Remove everything and reinstall Windows**
 - **Advanced startup**
3. Select any recovery option to complete the task.

Refresh your PC without affecting your files

This option enables you to refresh your tablet without losing your photos, music, videos, and other personal files. If you want to perform this action:

1. Click **Get started**. The Refresh your PC window opens.
2. Click **Next**.
3. Click **Refresh**.

Click **Cancel** to cancel this action.

Remove everything and re-install Windows

This option enables you to recycle or start over your tablet completely, and you can reset to its default / factory settings. If you want to perform this action:

1. Click **Get Started**. The Rest your PC window opens.
2. Click **Next**.

After you click **Next**, you will now have to select any of the two below options to finish the task:

- **Just remove my files** — If you select this option, Windows removes all your files including your photos, music, videos, and other personal files.
- **Fully clean the drive** — If you select this option, Windows resets your tablet.

 **CAUTION: Resetting your tablet erases all data from your tablet, including your account configuration, music, pictures, files, and so on. Ensure that you back up all the required data before you proceed.**

Click **Cancel** to cancel this action.

Advanced startup

This option enables you to start up from a device or compact disc (such as DVD or USB drive) and change your tablet's firmware settings, change Windows startup settings, or restore Windows from the system image. If you want to perform this action, click **Restart Now**.



 **NOTE:** Third-party applications will be removed.

Synchronizing your tablet

Using Microsoft account

If your computer has Microsoft Windows 8.1 installed, you can synchronize user settings of your tablet with your computer using a Microsoft account. When you sign in with your Microsoft account on your tablet, you can automatically synchronize your settings, including internet browser history, application settings, and personal files etc., with other Windows 8.1 PCs and Windows 8.1 tablets.

 **NOTE:** You need a wireless connection for both your computer and tablet.

1. Go to Charms bar, then click **Settings**  → **PC Settings** → **Accounts** → **Switch to a Microsoft account** to switch your computer local account to your Microsoft account.
2. A new option will be added to **PC Settings** called **Sync your settings**.
3. Click **Settings**  → **PC Settings** → **More PC Settings** → **Sync your settings** to show all kind of toggles for synchronizing your data and settings.

Copying music, photos, and videos

1. Connect a USB key or a Micro-SD card to the computer and copy the required files.
2. After the copy is complete, use the **Safely Remove Hardware** wizard to remove your tablet from the computer.
3. You can also use the Skydrive feature of Win 8.1 to copy music, photos, and videos.

Optional Stylus Features

This section provides information about the features available on the Stylus.

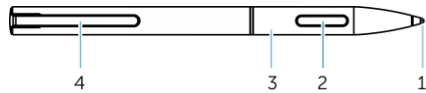

Feature	Functionality
1 Pen lead	Provides touch functionality.
2 Pen button	Used to perform a left-click and right-click.
3 Middle barrel	Provides access to the battery compartment.
4 Pen clip / Pen rear cap	Used to secure the stylus in your pocket.

 **NOTE:** The Stylus is optional and is sold separately.

 **NOTE:** This Stylus only works with the Dell Venue 11 pro-5130 and Dell Venue 11 pro-7130/7139 tablets. It is not designed to work the earlier family of Dell tablets. Also, the stylus purchased for use with any other Dell tablets is not supported by the Dell Venue 11 pro-5130 and Dell Venue 11 pro-7130/7139 tablets.

You can replace the Stylus pen lead, as shown in the below image.

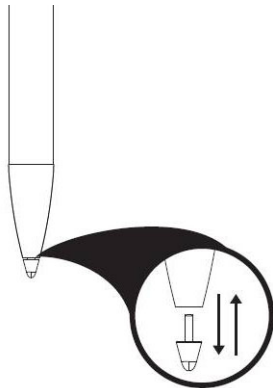

Getting Your Stylus Ready for Use

1. Twist the middle barrel in a counter clockwise direction.

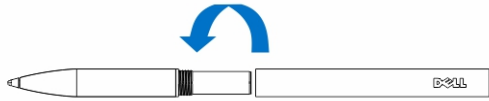

2. Insert a AAAA battery with the positive side facing the tip of the pen.



 **NOTE:** Follow your local and regional statutes and regulations on disposal of battery waste.

3. Re-assemble the barrel securely.

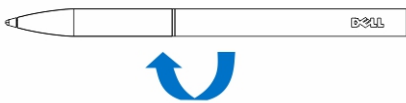

Using the Optional Stylus with Your Tablet

The Stylus is ergonomically designed to work with your tablet for long time periods. The user can seamlessly switch between pen and finger entry without any manual mode switching. The stylus supports features such as palm rejection, hovering, and pressure sensing, which allow for industry leading accuracy and ease of use with no calibration necessary. The two buttons are software configurable for using features such as erasing, highlighting, or performing mouse clicks. You can use the tip of the stylus to draw shapes, select text, turn a page and write or sign the documents on your tablet.

You can also press the button on the side of the stylus to perform the left-click and right-click functions on your tablet.

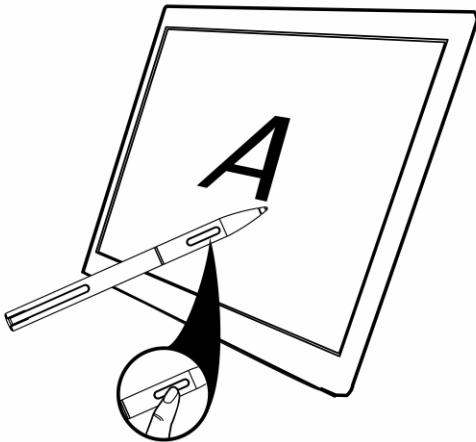

Desktop Dock Features

This section provides information about the features available on the Desktop dock.

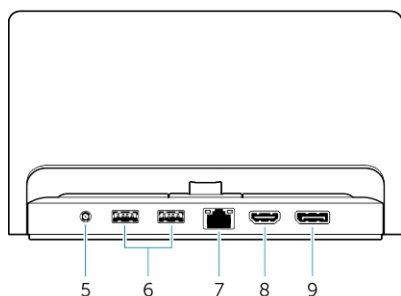
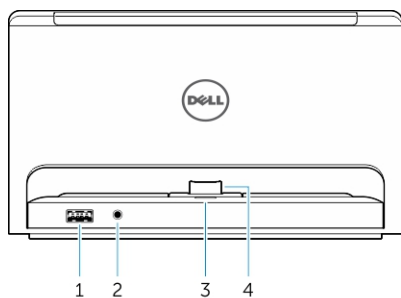

Feature

- 1 USB 3.0 connector
- 2 Audio connector
- 3 Power status light
- 4 Docking connector
- 5 Power connector
- 6 USB 3.0 connectors
- 7 Network connector
- 8 HDMI connector
- 9 DisplayPort connector

Functionality

- Connect USB devices, such as flash memory.
- Connect headphones or external speakers.
- Indicates the power status.
- Connect the docking connector on the tablet.
- Connect the AC adapter.
- Connect USB devices, such as flash memory.
- Connect an Ethernet cable for internet access.
- Connect HDMI-capable devices such as projectors, TV's, and monitors.
- Connect DisplayPort-capable devices such as projectors, TV's, and monitors.

 **NOTE:** Display port output supports only direct DisplayPort to DisplayPort or active DisplayPort adapters. Passive adapters are not supported by display port.

- ✎ **NOTE:** The desktop dock will only support USB 2.0 when docked with Venue Pro 11–5130.
- ✎ **NOTE:** The Desktop dock is sold separately and is not shipped with the tablet.
- ✎ **NOTE:** In Venue Pro 11–5130, you can use the HDMI connector or DisplayPort connector to mirror the same external display. You can use unique content display through the HDMI connector or DisplayPort connector only in Venue Pro 11 – 7130/7139.

Docking Your Tablet

The following images show how to dock your tablet:

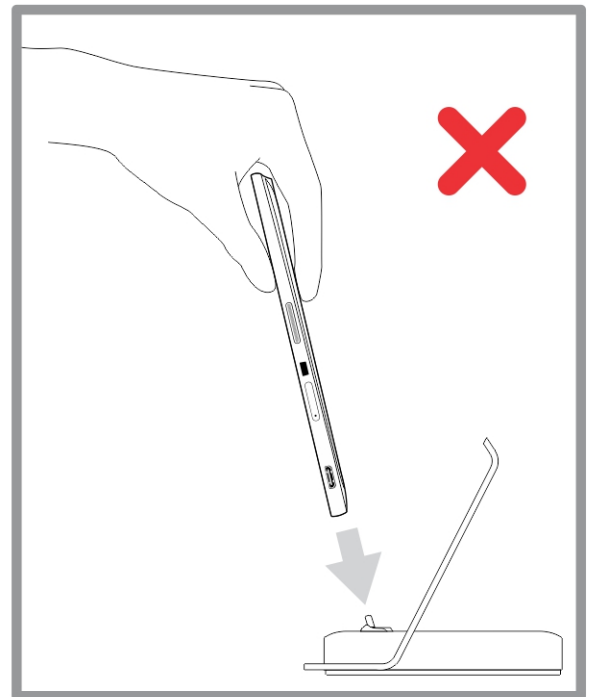
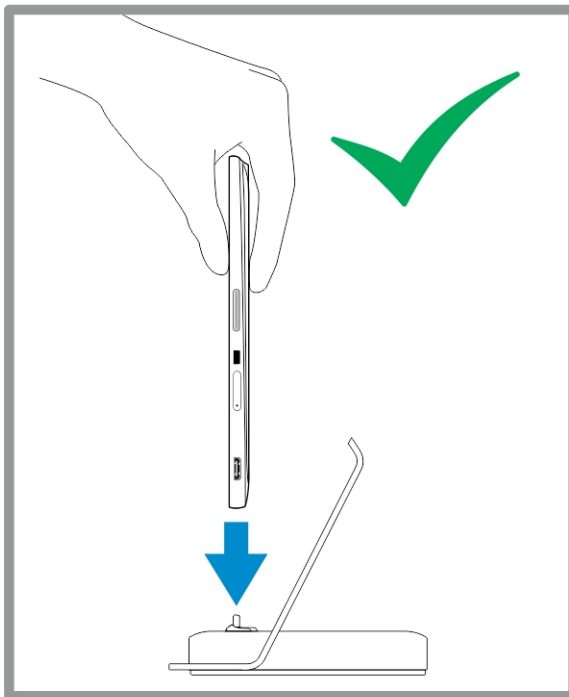

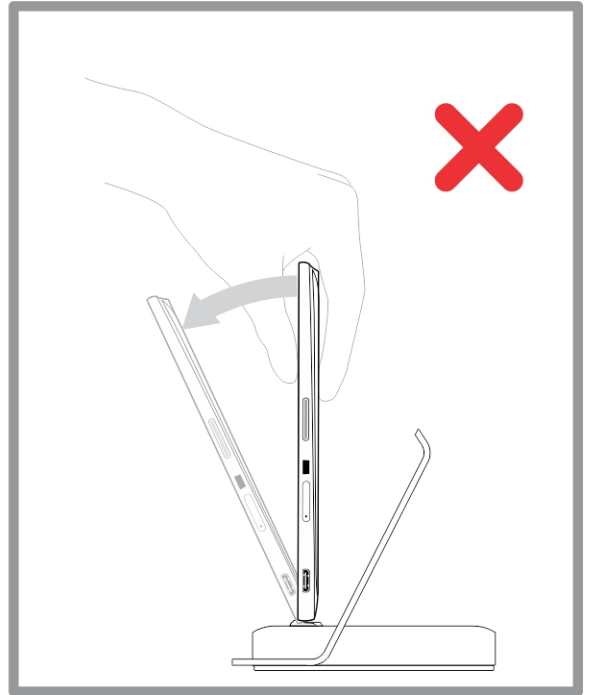
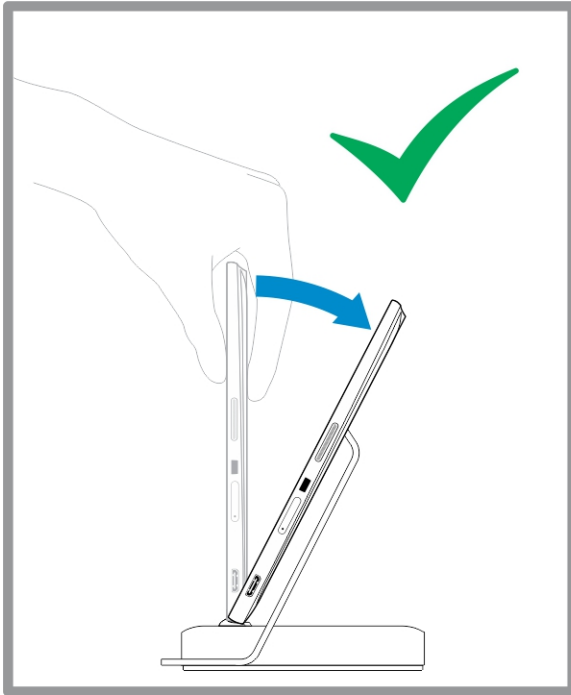

Connecting the Power Adapter

Connect one end of the power adapter to a wall socket and the other end to the power-connector port on the desktop dock.

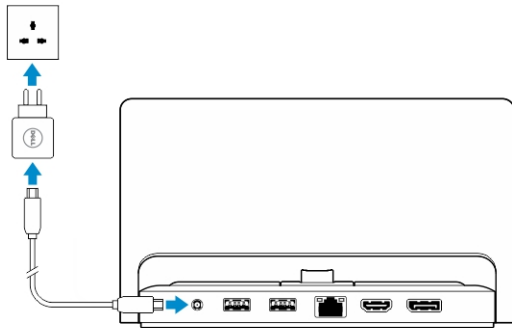

Thin Travel Keyboard Dock Features

This section provides information about the features available on the Thin keyboard dock.

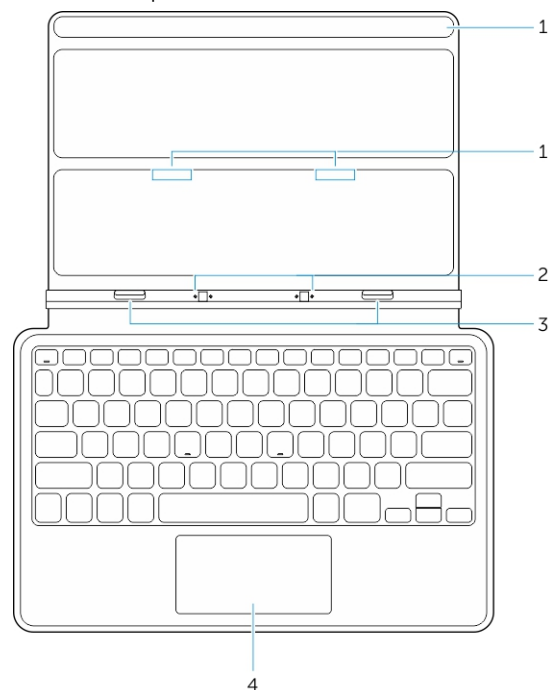

Table 1.

Feature	Functionality
1 Magnets	Magnets to enable docking.
2 Docking pins	Allows the tablet to make electrical contact with the dock.
3 Docking Connectors	Connect the docking connector on the tablet.
4 Touch pad	Allows you to move the mouse pointer on the screen and provides the function of a mouse.

 **NOTE:** The Thin travel keyboard dock is sold separately and is not shipped with the tablet.

Docking Your Tablet to the Thin Travel Keyboard Dock

1. Align the two docking connectors on the tablet to those on the dock.

- Slide the tablet downward until the tablet clicks into place..

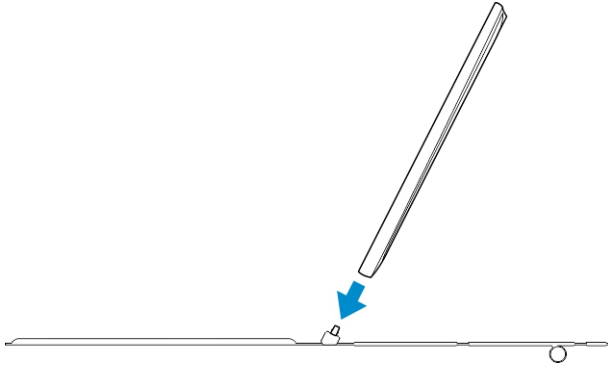

- Attach the keyboard cover and slide it down to attach the dock to the tablet.

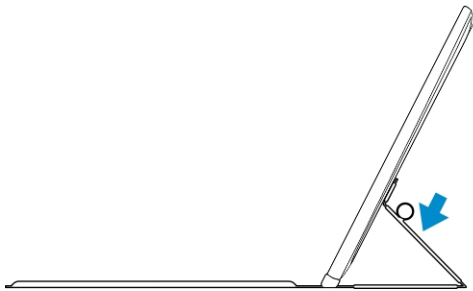
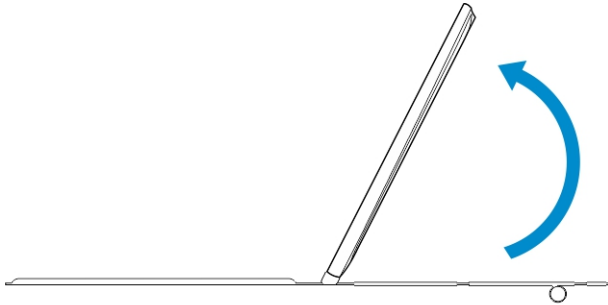

 **NOTE:** When the connection is made, you need to manually turn the on-screen keyboard off if it is displayed on the screen.

Mobile Keyboard Dock Features

This section provides information about the features available on the keyboard dock.

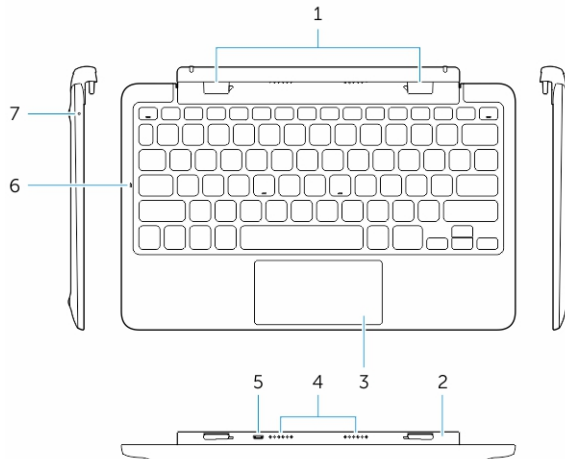

Feature	Functionality
1 Docking connectors	Connect the docking guide slots on the tablet.
2 Rotatable hinge	Allows the tablet to rotate around the hinges.
3 Touch pad	Allows you to move the mouse pointer on the screen and provides the function of a mouse.
4 Dock Pins	Allows the tablet to make electrical contact with the dock.
5 micro USB power connector	Connect a micro USB charger to charge the dock
6 Caps Lock LED	Indicates if the Caps Lock key on the keyboard is turned on.
7 Battery charge LED	Indicates if the battery is charging when connected to AC power.

 **NOTE:** It is recommended / easier to dock the tablet at a 90-degree angle.

 **NOTE:** The keyboard dock is sold separately and is not shipped with the tablet.

Docking Your Tablet to the Keyboard Dock

1. Rotate the keyboard dock to a 90-degree angle.



 **NOTE:** The hinge position will be open, when you dock your tablet to the keyboard dock.

2. Dock the tablet to the keyboard dock.

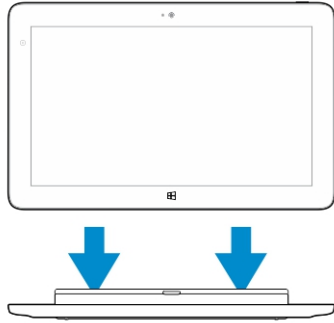

 **NOTE:** When the connection is made, you need to manually turn the on-screen keyboard off if it is displayed on the screen.

Undocking Your Tablet from the Keyboard Dock

1. Push and hold the button on the Mobile Keyboard dock.

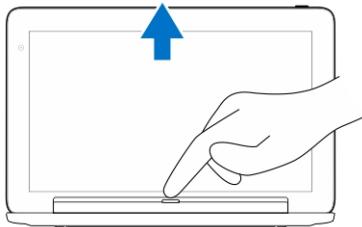

2. Lift the tablet from the Mobile Keyboard dock.

Charging the dock

 **CAUTION:** Use only the supplied power adapter and power cable to charge your tablet and dock. Using unauthorized power adapters or power cables may cause severe damage to your tablet and dock.

1. Connect the power adapter to the microUSB charging port on your keyboard dock.

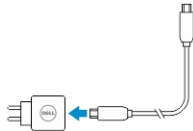

2. The keyboard dock charges through the tablet if AC power is attached to the tablet.

 **NOTE:** Power can't be directly attached to travel keyboard when the tablet is docked.

 **NOTE:** The dock battery requires about four hours to fully charge.

For more information on the tablet battery charging time, see [Charging the tablet](#).

You can check the keyboard dock battery status from:

- Battery-charge light located on the left side of the keyboard dock:

LED behavior	Description
Solid white color on	Battery is charging with AC power when AC adapter is connected directly to the dock.
Off	Battery is not charging, either no AC adapter is connected or battery is fully charged or the AC power is connected directly to the tablet.

For more information on checking the tablet battery status, see *tablet battery charge status*.

Battery behavior

When AC power is connected, the tablet gets charged first followed by the dock. During discharge or when AC power is not connected, the dock battery gets used first followed by the tablet.

Cleaning Your Tablet

 **CAUTION:** Before you clean your tablet, disconnect all cables. Clean your tablet with a soft cloth dampened with water. Do not use liquid or aerosol cleaners, which may contain flammable substances.

1. Turn off your tablet. For more information on turning off your tablet, see **Turning Off Your Tablet**.
2. Disconnect any attached devices, headphones, speakers, and keyboard dock from the tablet and from their electrical outlets.
3. Remove any installed Micro-SD and Micro-SIM card. For more information on removing the Micro-SD card and Micro-SIM card, see **Remove the Micro-SD card** and **Remove the Micro-Sim card**.
4. Moisten a soft, lint-free cloth with either water or a display cleaner, and wipe the surface of the tablet until it is clean. Do not allow water from the cloth to seep down to the tablet ports and surrounding **Windows** button.

 **NOTE:** To avoid damaging the tablet or display, follow the instructions that are included with the product.

 **NOTE:** Do not clean the keyboard with a moist cloth.

Troubleshooting

Battery problem

Problems

Battery does not charge

Possible causes

The tablet's temperature is below 0 °C or higher than 40 °C.

The battery or power adapter is damaged.

If the tablet is not in the range of a network it can connect to, the tablet continues to send out signals to locate a base station and drains the battery.

Battery drains quickly even when the tablet is in Standby mode

Possible solutions

- Unplug the Dell AC power adapter from the wall and verify that the outlet is functioning.
- Check all cable connections and plug back into the wall, then back into the tablet.
- Check the AC adapter LED light to ensure if the AC adapter is working.
- Check all connectors to ensure proper connectivity.

If the AC adapter works and the battery does not charge, try to:

- Remove and re-insert the battery to ensure the battery fits to its connectors properly.
- Replace with another battery, if available.

 **NOTE:** The tablet battery requires about 4 hours to fully charge.

Charge the battery in an ambient temperature between 0 °C to 40 °C.

Contact a Dell authorized reseller to replace the battery or power adapter.

- Temporarily turn off the tablet.
- Move the tablet in range of a network it can

connect to, or temporarily turn off the wireless connection on your tablet.

- Use your tablet in airplane mode.

System problem

Problems

Tablet does not turn on

Possible causes

The battery is completely discharged.

Possible solutions

1. Charge the tablet for at least 4 hours.
2. Press and hold the **Power** button for 4 seconds.

Tablet does not turn off

Press and hold the **Power** button for 11 seconds to perform a hard shut down.

Tablet locks up

1. Press and hold the power button for 11 seconds to perform a hard shut down.
2. Remove the power supply and unplug / plug the battery.

Tablet is not responding or behaving unexpectedly

- Driver failure
- Operating system failure
- Virus/Malware

1. Shut down and restart your tablet.
2. Refresh the tablet.
3. Contact Dell's support service. Go to dell.com/support or dell.com/contactdell.

Software or feature is not working as expected

Restart your tablet. Software updates may have been downloaded in the background. Swipe from the right edge of the display to access the Charms bar and touch **Settings**→**Power**→**Restart** to restart the tablet.

Docking station not working as expected

Un-dock / Re-dock your tablet. If the issue still continues, power cycle your tablet on the dock.

Touchscreen problem

Problems

Touchscreen responds slowly or improperly

Possible causes

Protective cover prevents the tablet from recognizing your inputs.

Possible solutions

- Shutdown and restart your tablet.
- Gently wipe the display with a clean dry cloth.
- Remove any protective covers from the touchscreen.
- If the operating system is re-installed, make sure all the drivers are installed.

Network problem

Problems

No wireless connection

Possible causes

- The mobile broadband has been capped.
- No signal from the service provider.

Possible solutions

1. Check if the wireless radio is on. See [Wi-Fi setting](#) .
2. Try to get closer to the wireless access point.
3. Reset the wireless router if using a private network; open the browser to view the landing page if using a public network.

No mobile broadband connection

1. Check if the mobile broadband is turned on. See [Turning On/Off mobile broadband](#)
2. Move your tablet to a different location for better signal reception.

Contact your service provider to change your broadband plan.

System Setup

System Setup enables you to manage your computer hardware and specify BIOS-level options. From the System Setup, you can:

- Change the NVRAM settings after you add or remove hardware
- View the system hardware configuration
- Enable or disable integrated devices
- Set performance and power management thresholds
- Manage your computer security

To access the system setup options (BIOS):

1. Connect your tablet to the keyboard dock or connect a USB enabled keyboard to your tablet.
2. Press the **Power**  button to turn on your tablet or restart your tablet, if you have already turned on your tablet.
3. Press **F2** after the Dell logo appears.

 **NOTE:** You might have to press **F2** repeatedly until the Windows redirects to the system setup options.

To access the setup options (BIOS) without an external keyboard :

1. Press the **Power**  button to turn on your tablet or restart your tablet, if you have already turned on your tablet.
2. Press and hold the **Volume Up** button when the Dell logo appears on the screen.
3. When the F12 Boot Selection menu appears, press the **Volume Up** button to change the boot selection to the BIOS Setup option.

 **NOTE:** The **Volume Up** button cycles through the menu options (Boot Options, BIOS Setup, Diagnostics, and so on. You can select the desired option by pressing the **Volume Up** button.)

4. Press the **Volume Down** button to select the option.

System Setup (BIOS) Options

Table 2. System Information

Option	Function
BIOS Version	Displays the BIOS revision.
Service Tag	Displays the service tag of your tablet.
Asset Tag	Displays the asset tag of your tablet.
Ownership Tag	Displays the ownership information.

Option	Function
Manufacture Date	Displays the date of manufacture
Ownership Date	Displays the ownership date.
Express Service Code	Displays the Express Service code of the tablet.
Memory Installed	Displays the memory installed on the tablet.
Memory Available	Displays the memory available on the tablet.
Memory Speed	Displays the memory speed.
Memory Channel Mode	Displays the memory capacities on the tablet.
Memory Technology	Displays new type of device file in Linux for interacting with flash memory.
Processor Type	Displays the processor type available on the tablet.
Core Count	Displays the core count of the tablet.
Processor ID	Displays the processor ID of the tablet.
Current Clock Speed	Displays the current clock speed of the tablet.
Minimum Clock Speed	Displays the minimum clock speed of the tablet.
Maximum Clock Speed	Displays the maximum clock speed of the tablet.
Processor L2 Cache	Displays the L2 cache of the tablet.
Processor L3 Cache	Displays the L3 cache of the tablet.
HT Capable	Displays the tablet is Hyper-Thread capable.
64-bit Technology	Displays the tablet functions with 64-bit

Option	Function
	technology (Intel EM64T).
Video Controller	Displays the video controller used in the tablet.
Video BIOS Version	Displays the BIOS version number of the tablet.
Video Memory	Displays the video memory of the tablet.
Panel Type	Displays the panel type used in the tablet.
Native Resolution	Displays the resolution of the tablet.
Audio Controller	Displays the audio controller used in the tablet.
Wi-Fi Device	Displays the Wi-Fi device in the tablet.
Cellular Device	Displays the cellular device in the tablet.
Bluetooth Device	Displays the Bluetooth device in the tablet.

Table 3. Battery Information

Option	Function
AC Adapter	Displays the AC Adapter information.
Battery Status	Displays the current battery status.
Battery Charge State	Displays if the battery is charging/discharging.
Battery Health	Displays the battery health.

Table 4. Boot Sequence

Option	Function
Boot Sequence	Displays the order that the BIOS searches devices when trying to find an operating system to boot. The options are: <ul style="list-style-type: none"> • Windows Boot Manager • UEFI
Boot List Option	Allows you to change the boot list option.

Option	Function
	<ul style="list-style-type: none"> Legacy UEFI <p>You can also perform other options. The options are:</p> <ul style="list-style-type: none"> Add Boot Option — This option allows you to add a boot option Delete Boot Option — This option allows you to delete an existing boot option View — This option allows you to view a boot option

Table 5. Advanced Boot Options

Option	Function
	<p style="text-align: center;">For Dell Venue Pro 11–7130/7139</p>
Enable Legacy Option ROMs	During the UEFI boot mode, the Enable Legacy Option ROMs option will allow legacy option ROMs to load. This option is not allowed if Secure Boot is enabled.
	<p style="text-align: center;">For Dell Venue Pro 11–5130</p>
Enable UEFI Network Stack	Enable UEFI Network Stack function with IPV4/ IPV6 PXE protocol support.

Table 6. Date/Time

Option	Function
System Date	Displays the system date.
System Time	Displays the system time.

Table 7. System Configuration

Option	Function
USB Configuration	<p>Allows you to configure the integrated USB controller. The options:</p> <ul style="list-style-type: none"> Enable Boot Support Enable USB3.0 Controller Enable External USB Port <p>By default, all the options are enabled.</p>
USB PowerShare	<p>Allows you to configure the USB PowerShare feature behavior.</p> <p>Default: Not enabled</p>

Option	Function
Audio	<p>This field allows you to enable or disable the integrated audio connector.</p> <ul style="list-style-type: none"> • Enable Audio. Default: Enabled
Miscellaneous Devices	<p>Allows you to enable or disable various on-board devices.</p> <ul style="list-style-type: none"> • Enable Microphone. Default: Enabled • Enable Camera. Default: Enabled • Enable Media Card. Default: Enabled • Disable Media Card

Table 8. Video

Option	Function
LCD Brightness	<p>Displays the panel brightness when the ambient light sensor is off.</p> <ul style="list-style-type: none"> • Brightness on Battery • Brightness on AC

Table 9. Security

Option	Description
Admin Password	<p>This field lets you set, change, or delete the administrator (admin) password (also known as the setup password). The admin password enables several security features.</p> <p>The drive does not have a password set by default.</p> <p>To add a new password:</p> <ul style="list-style-type: none"> • Enter the old password • Enter the new password • Confirm the new password <p>Click OK after entering the password details.</p>
System Password	<p>Allows you to set, change, or delete the tablet password (previously called the primary password).</p> <p>The drive does not have a password set by default.</p> <p>To add a new password:</p> <ul style="list-style-type: none"> • Enter the old password • Enter the new password • Confirm the new password <p>Click OK after entering the password details.</p>

Option	Description
Strong Password	Enable strong password - This option is disabled by default.
Password Configuration	<p>This field controls the minimum and maximum number of characters allowed for the admin and system passwords. Changes to these fields are not active until they are committed via the apply button or saving changes before exiting setup.</p> <ul style="list-style-type: none"> • Admin Password Min • Admin Password Max • System Password Min • System Password Max
Password Bypass	<p>This option lets you bypass the system (Boot) Password and the internal HDD password prompts during a system restart.</p> <ul style="list-style-type: none"> • Disabled • Reboot Bypass (Default Enabled)
Password Change	<p>Allows you to determine whether changes to the system and hard disk passwords are permitted when an administrator password is set.</p> <ul style="list-style-type: none"> • Allow Non-Admin Password Changes (Default)
Non-Admin Setup Changes	<p>This option lets you determine whether changes to the setup options are permitted when an administrator password is set.</p> <ul style="list-style-type: none"> • Allow Wireless Switch Changes (Default)
TPM Security	<p>This option lets you control whether the Trusted Platform Module (TPM) in the system is enabled and visible to the operating system.</p> <p>TPM Security (Default)</p> <ul style="list-style-type: none"> • TPM ACPI Support • Deactivate • Activate <p> NOTE: Activation, deactivation, and clear options are not affected if you load the setup program's default values. Changes to this option take effect immediately.</p>
PTT Security	<p>Allows you to enable or disable PTT Support.</p> <ul style="list-style-type: none"> • PTT Security (Default) • Revoke Trust (Default)
Computrace (R)	<p>This field lets you activate / de-activate or disable the BIOS module interface of the optional <i>Computrace Service</i> from <i>Absolute Software</i>.</p> <ul style="list-style-type: none"> • Deactivate (Default) • Disable • Activate
CPU XD Support	<p>This option enables or disables the Execute Disable mode of the Processor.</p>

Option	Description
	<ul style="list-style-type: none"> • Enable CPU XD Support (Default Enable)
Admin Setup Lockout	<p>Allows you to enable or disable the option to enter setup when an admin password is set.</p> <ul style="list-style-type: none"> • Enable Admin Setup Lockout (Default)

Table 10. Secure Boot

Option	Function
Secure Boot	<p>Allows you to enable or disable the secure boot feature. Default : Disabled</p>
Expert Key Management	<p>Allows you to manipulate the security key databases only if the system is in Custom Mode. The Enable Custom Mode option is disabled by default. The options are:</p> <ul style="list-style-type: none"> • PK • KEK • db • dbx <p>If you enable the Custom Mode, the relevant options for PK, KEK, db, and dbx appear. The options are:</p> <ul style="list-style-type: none"> • Save to File- Saves the key to a user-selected file • Replace from File- Replaces the current key with a key from a user-selected file • Append from File- Adds a key to the current database from a user-selected file • Delete- Deletes the selected key • Reset All Keys- Resets to default setting • Delete All Keys- Deletes all the keys <p> NOTE: If you disable the Custom Mode, all the changes made will be erased and the keys will restore to default settings.</p>

Table 11. Performance

Option	Description
Multi Core Support	<p>Specifies whether the processor will have one or all cores enabled. The performance of some applications will improve with the additional cores.</p> <ul style="list-style-type: none"> • All (Default) • 1 • 2
Intel SpeedStep	<p>Allows you to enable or disable the Intel SpeedStep mode of the processor.</p> <ul style="list-style-type: none"> • Enable Intel(R) SpeedStep (Default)

Option	Description
C States Control	Allows you to enable or disable the additional processor sleep states. <ul style="list-style-type: none"> • C states (Default)
Intel TurboBoost	Allows you to enable or disable Intel TurboBoost mode of the processor. <ul style="list-style-type: none"> • Enable Intel TurboBoost (Default) — Allows the Intel TurboBoost driver to increase the performance of the CPU or graphics processor.
HyperThread control	Allows you to enable or disable the HyperThreading in the processor. Default: Enabled
Rapid Start Technology	This option may improve the battery life by automatically putting the tablet into a low power state during the sleep state, for a user-specified amount of time. The options are: <ul style="list-style-type: none"> • Intel Rapid Start Feature • Transition to Rapid Start when using timer <p>By default, all the options are enabled.</p>

Table 12. Power Management

Option	Description
AC Behavior	Allows the tablet to power-on automatically, when AC adapter is plugged. The option is disabled. <ul style="list-style-type: none"> • Wake on AC
Auto On Time	Allows you to set the time at which the system must turn on automatically. The options are: <ul style="list-style-type: none"> • Disabled (Default) • Every Day • Weekdays • Select Days
Peak Shift	This option allows to use minimize AC consumption during peak power time of day. <ul style="list-style-type: none"> • Monday • Tuesday • Wednesday • Thursday • Friday • Saturday • Sunday
Advanced Battery Charge Configuration	This option places batteries in the system advanced battery charging mode to maximize battery health. <ul style="list-style-type: none"> • Monday • Tuesday • Wednesday • Thursday • Friday • Saturday

Option	Description
	<ul style="list-style-type: none"> • Sunday
Primary Battery Charge Configuration	<ul style="list-style-type: none"> • Adaptive • Standard • ExpressCharge • Primary AC Use • Custom <p> NOTE: Some of the battery settings may not be available for all battery types. To enable this option, you should disable the Advanced Battery Charge Configuration Mode.</p>
Intel Smart Connect Technology	This option, if enabled, will periodically sense the nearby wireless connections, while the tablet is asleep. Default: Disabled

Table 13. POST Behavior

Option	Description
Adapter Warnings	Allows you to activate the adapter warning messages when certain power adapters are used. The option is enabled by default. <ul style="list-style-type: none"> • Enable Adapter Warnings
Fastboot	This option can speed up the boot process by bypassing some compatibility steps. <ul style="list-style-type: none"> • Minimal • Thorough • Auto (Default Enable) <p> NOTE: Enabling the Fastboot will prevent F2 BIOS access through USB or Thin / Travel keyboard. You can still access the BIOS Setup, by pressing the Volume Up button after the Dell logo screen appears.</p>

Table 14. Virtualization Support

Option	Description
Virtualization	This option specifies whether a Virtual Machine Monitor (VMM) can utilize the additional hardware capabilities provided by Intel Virtualization technology. <ul style="list-style-type: none"> • Enable Intel Virtualization Technology (Default)
VT for Direct I/O	This option specifies whether a Virtual Machine Monitor (VMM) can utilize the additional hardware capabilities provided by Intel Virtualization Technology for Direct I/O. <ul style="list-style-type: none"> • Enable VT for Direct I/O (Default)
Trusted Execution	This option specifies whether a Measured Virtual Machine Monitor (MVMM) can utilize the additional hardware capabilities provided by Intel Trusted Execution Technology. Default: disabled

Table 15. Wireless

Option	Description
Wireless Device Enable	Allows you to enable or disable the wireless devices <ul style="list-style-type: none">• WWAN (Default Enable)• WLAN / WiGig

Table 16. Maintenance



Option	Description
Service Tag	Displays the service tag of your tablet.
Asset Tag	Allows you to create a system asset tag if an asset tag is not already set. This option is not set by default.

Table 17. System Logs

Option	Description
BIOS events	Displays the system event log and allows you to clear the log. <ul style="list-style-type: none">• Clear Log
Power events	Displays the power event log and allows you to clear the log. <ul style="list-style-type: none">• Clear Log

Updating the BIOS

It is recommended to update your BIOS (system setup), on replacing the system board or if an update is available. For tablet, ensure that the battery is fully charged and connected to a power outlet

1. Re-start the tablet.
2. Go to dell.com/support.
3. Enter the **Service Tag** or **Express Service Code** and click **Submit**.
 -  **NOTE:** To locate the Service Tag, click **Where is my Service Tag?**
 -  **NOTE:** If you cannot find your Service Tag, click **Detect My Product**. Proceed with the instructions on screen.
4. If you are unable to locate or find the Service Tag, you can select your product from the products list under the **General Support**.
5. Choose the **Product Type** from the list.
6. Select your product model and the **Product Support** page of your product appears.
7. Click **Get Drivers** and click **View All Drivers**.
The Drivers and Downloads page opens.
8. On the Drivers and Downloads screen, under the **Operating System** drop-down list, select **BIOS**.
9. Identify the latest BIOS file and click **Download File**.
You can also analyze which drivers need an update. To do this for your product, click **Analyze System for Updates** and follow the instructions on the screen.
10. Select your preferred download method in the **Please select your download method below window**; click **Download File**.

The **File Download** window appears.

11. Click **Save** to save the file on your tablet.
12. Click **Run** to install the updated BIOS settings on your tablet.
Follow the instructions on the screen.

Specifications

 **NOTE:** Offerings may vary by region. The following specifications are only those required by law to ship with your computer. For more information about the configuration of your computer, go to **Help and Support** in your Windows operating system and select the option to view information about your computer.

System Information	
Chipset	Intel Lynx Point
DRAM bus width	128 bit (64-bits x 2 channels)
Flash EPROM	128 Mbit Quad-SPI
Processor	
Type	Intel Haswell ULX Y-series CPU
External bus frequency	SOC no external bus connected chipset
Memory	
Memory capacity	4 GB/ 8 GB
Memory type	LPDDR3/DDR3L
Memory speed	1600 MHz
Minimum memory	4 GB
Maximum memory	8 GB
Audio	
Type	Side firing
Stereo conversion	24-bit
Speakers	AAC 25 x 9 x 3 mm, 1 W, speaker
Video	
Video type	integrated
Data bus	integrated
Video controller	iGPU GT2 graphics

Communications	
Network adapter	WLAN, LTE, HSPA+
Wireless	BT, NFC

Ports and Connectors	
Audio	one 3.5 mm jack
Video	one mini HDMI connector
USB	one USB 3.0 connector
Memory card reader	one microSD card reader
Docking port	one Dell 40-pin dock connector
Subscriber Identity Module (SIM) port	one micro SIM slot
Smart card	one smart card reader

Display	
Type	TFT-LCD with eDP interface , Full-HD (1920 x 1080)
Size	10.8 inches high definition (HD)
Dimensions:	
Height	250.20 mm (9.85 inches)
Width	149.25 mm (5.90 inches)
Diagonal	274.32 mm (10.08 inches)
Active area (X/Y)	239.04 mm / 134.46 mm
Maximum resolution	1920 pixels x 1080 pixels
Maximum brightness	400 nits
Refresh rate	60 Hz
Minimum viewing angles:	
Horizontal	80/80
Vertical	80/80
Pixel pitch	0.1245 mm x 0.1245 mm

Front camera	
Type	OV 2722 (2 MP)
Resolution	1920 pixels x 1080 pixels

Rear camera	
Type	IMX 175 (8 MP)
Resolution	3264 pixels x 2448 pixels

Storage	
Storage	NGFF SSD 128 GB / 256 GB
Battery	
Type	2-cell lithium ion (36 WHr)
Dimensions	
Length	240.85 mm (9.48 inches)
Height	7.17 mm (0.28 inch)
Width	70.60 mm (2.78 inches)
Weight	240.00 g (0.53 lb)
Voltage	7.4 VDC (nominal) and 8.7 VDC (maximum)
Temperature range	
Operating	0 °C to 50 °C (32° F to 158 °F)
Non-Operating	-20 °C to 65 °C (4 °F to 149 °F)
Coin-cell battery	3 V CR2025 lithium ion
AC Adapter	
Type	
Input voltage	100 VAC to 240 VAC
Input current (maximum)	0.60 A
Input frequency	50 Hz to 60 Hz
Output power	23.4 W
Output current (30 W)	1.2 A / 2.0 A
Rated output voltage	19.5 Vdc
Temperature range:	
Operating	0 °C to 40 °C (32 °F to 104 °F)
Non-operating	-40 °C to 70 °C (-40 °F to 158 °F)
Physical	
Height	279.74 mm (11.01 inches)
Width	176.76 mm (0.50 inches)
Weight (minimum)	889 grams (1.96 lb)
Environmental	
Temperature:	
Operating	0 °C to 40 °C

Environmental

Storage	-40 °C to 65 °C
Relative humidity (maximum):	
Operating	Operating 10% to 90% (noncondensing)
Storage	Storage 5% to 95% (noncondensing)
Altitude (maximum):	
Operating	-16 m to 3048 m (-50 to 10,000 ft)
Non-operating	-15.2 m to 10,668 m (-50 ft to 35,000 ft)
Airborne contaminant level	G1 as defined by ISA-71.04-1985

Contacting Dell

 **NOTE:** If you do not have an active Internet connection, you can find contact information on your purchase invoice, packing slip, bill, or Dell product catalog.

Dell provides several online and telephone-based support and service options. Availability varies by country and product, and some services may not be available in your area. To contact Dell for sales, technical support, or customer service issues:

1. Go to **dell.com/support**.
2. Select your support category.
3. Verify your country or region in the **Choose a Country/Region** drop-down list at the bottom of the page.
4. Select the appropriate service or support link based on your need.