

Dell Latitude E7450 Owner's Manual

Regulatory Model: P40G
Regulatory Type: P40G002



Notes, cautions, and warnings

 **NOTE:** A NOTE indicates important information that helps you make better use of your computer.

 **CAUTION:** A CAUTION indicates either potential damage to hardware or loss of data and tells you how to avoid the problem.

 **WARNING:** A WARNING indicates a potential for property damage, personal injury, or death.

Copyright © 2015 Dell Inc. All rights reserved. This product is protected by U.S. and international copyright and intellectual property laws. Dell™ and the Dell logo are trademarks of Dell Inc. in the United States and/or other jurisdictions. All other marks and names mentioned herein may be trademarks of their respective companies.

2015 -07

Rev. A01

Contents

1 Working on Your Computer.....	5
Before Working Inside Your Computer.....	5
Turning Off Your Computer.....	6
After Working Inside Your Computer.....	7
2 Docking Your Computer.....	8
3 Removing and Installing Components.....	9
Recommended Tools.....	9
System Overview.....	10
Removing the Battery.....	11
Installing the Battery.....	12
Removing the Base Cover.....	12
Installing the Base Cover.....	13
Removing the Hard Drive.....	13
Installing the Hard Drive.....	14
Removing the Coin-Cell Battery.....	14
Installing the Coin-Cell Battery.....	15
Removing the mSATA SSD.....	15
Installing the mSATA SSD.....	16
Removing the WWAN Card.....	16
Installing the mSATA SSD.....	17
Removing the WLAN Card.....	17
Installing the WLAN Card.....	17
Removing the System Fan.....	18
Installing the System Fan.....	18
Removing the Display Bezel.....	18
Installing the Display Bezel.....	19
Removing the Display Panel.....	19
Installing the Display Panel.....	21
Removing the Camera.....	21
Installing the Camera.....	22
Removing the Keyboard Trim.....	22
Installing the Keyboard Trim.....	23
Removing the Keyboard.....	23
Installing the Keyboard.....	24
Removing the Palmrest.....	24
Installing the Palmrest.....	26

Removing the Speakers.....	26
Installing the Speaker.....	27
Removing the I/O Board.....	28
Installing the I/O Board.....	28
Removing the Display-Hinge Cover.....	28
Installing the Display-Hinge Cover.....	29
Removing the Display Assembly.....	30
Installing the Display Assembly.....	31
Removing the System Board.....	32
Installing the System Board.....	33
Removing the Heatsink.....	34
Installing the Heatsink.....	34
Removing the Power-Connector Port.....	35
Installing the Power Connector.....	36
4 System Setup.....	37
Boot Sequence.....	37
Navigation Keys.....	37
System Setup Options.....	38
Updating the BIOS	47
System and Setup Password.....	48
Assigning a System Password and Setup Password.....	48
Deleting or Changing an Existing System and/or Setup Password.....	49
5 Diagnostics.....	50
Enhanced Pre-Boot System Assessment (ePSA) Diagnostics.....	50
Device Status Lights.....	51
Battery Status Lights.....	51
6 Specifications.....	53
7 Contacting Dell.....	58

Working on Your Computer

Before Working Inside Your Computer

Use the following safety guidelines to help protect your computer from potential damage and to help to ensure your personal safety. Unless otherwise noted, each procedure included in this document assumes that the following conditions exist:

- You have read the safety information that shipped with your computer.
- A component can be replaced or--if purchased separately--installed by performing the removal procedure in reverse order.

 **WARNING:** Disconnect all power sources before opening the computer cover or panels. After you finish working inside the computer, replace all covers, panels, and screws before connecting to the power source.

 **WARNING:** Before working inside your computer, read the safety information that shipped with your computer. For additional safety best practices information, see the Regulatory Compliance Homepage at www.dell.com/regulatory_compliance

 **CAUTION:** Many repairs may only be done by a certified service technician. You should only perform troubleshooting and simple repairs as authorized in your product documentation, or as directed by the online or telephone service and support team. Damage due to servicing that is not authorized by Dell is not covered by your warranty. Read and follow the safety instructions that came with the product.

 **CAUTION:** To avoid electrostatic discharge, ground yourself by using a wrist grounding strap or by periodically touching an unpainted metal surface, such as a connector on the back of the computer.

 **CAUTION:** Handle components and cards with care. Do not touch the components or contacts on a card. Hold a card by its edges or by its metal mounting bracket. Hold a component such as a processor by its edges, not by its pins.

 **CAUTION:** When you disconnect a cable, pull on its connector or on its pull-tab, not on the cable itself. Some cables have connectors with locking tabs; if you are disconnecting this type of cable, press in on the locking tabs before you disconnect the cable. As you pull connectors apart, keep them evenly aligned to avoid bending any connector pins. Also, before you connect a cable, ensure that both connectors are correctly oriented and aligned.

 **NOTE:** The color of your computer and certain components may appear differently than shown in this document.

To avoid damaging your computer, perform the following steps before you begin working inside the computer.

1. Ensure that your work surface is flat and clean to prevent the computer cover from being scratched.
2. Turn off your computer (see [Turning off Your Computer](#)).

3. If the computer is connected to a docking device (docked), undock it.

 **CAUTION: To disconnect a network cable, first unplug the cable from your computer and then unplug the cable from the network device.**

4. Disconnect all network cables from the computer.
5. Disconnect your computer and all attached devices from their electrical outlets.
6. Close the display and turn the computer upside-down on a flat work surface.

 **NOTE: To avoid damaging the system board, you must remove the main battery before you service the computer.**

7. Remove the base cover.
8. Remove the main battery.
9. Turn the computer top-side up.
10. Open the display.
11. Press and hold the power button for few seconds, to ground the system board.





 **CAUTION: To guard against electrical shock, always unplug your computer from the electrical outlet before opening the display.**

 **CAUTION: Before touching anything inside your computer, ground yourself by touching an unpainted metal surface, such as the metal at the back of the computer. While you work, periodically touch an unpainted metal surface to dissipate static electricity, which could harm internal components.**

12. Remove any installed ExpressCards or Smart Cards from the appropriate slots.

Turning Off Your Computer

 **CAUTION: To avoid losing data, save and close all open files and exit all open programs before you turn off your computer.**

1. Shut down the operating system:
 - In Windows 8 (touch-enabled device):
 1. Swipe in from the right edge of the screen, opening the Charms menu and select **Settings**.
 2. Select the  and then select **Shut down**.
 - Using a mouse:
 1. Point to upper-right corner of the screen and click **Settings**.
 2. Click the  and select **Shut down**.
 - In Windows 7:
 1. Click **Start** .
 2. Click **Shut Down**.
- Or
1. Click **Start** .

2. Click the arrow in the lower-right corner of the **Start** menu as shown below, and then click



Shut Down

2. Ensure that the computer and all attached devices are turned off. If your computer and attached devices did not automatically turn off when you shut down your operating system, press and hold the power button for about 6 seconds to turn them off.

After Working Inside Your Computer

After you complete any replacement procedure, ensure you connect any external devices, cards, and cables before turning on your computer.

△ CAUTION: To avoid damage to the computer, use only the battery designed for this particular Dell computer. Do not use batteries designed for other Dell computers.

1. Connect any external devices, such as a port replicator or media base, and replace any cards, such as an ExpressCard.
2. Connect any telephone or network cables to your computer.

△ CAUTION: To connect a network cable, first plug the cable into the network device and then plug it into the computer.

3. Replace the battery.
4. Connect your computer and all attached devices to their electrical outlets.
5. Turn on your computer.

Docking Your Computer

Follow the steps to dock your computer:

- Place the docking spacer until the docking spacer clicks in its place in the docking station.
- Place the computer on the docking spacer to dock your computer.

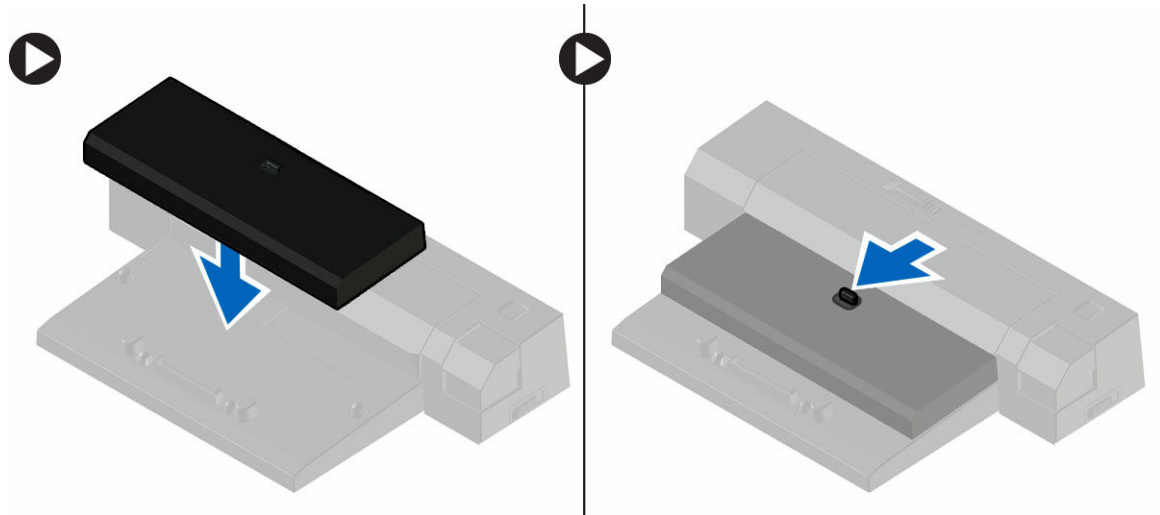

 **NOTE:** This docking spacer can be used to dock only the Latitude E7250 / Latitude E7450 computers. You cannot dock any other Dell computers using this docking station.

 **NOTE:** The docking spacer and the dock are optional items and do not ship standard with the computer.

Removing and Installing Components

This section provides detailed information on how to remove or install the components from your computer.

Recommended Tools

The procedures in this document may require the following tools:

- Small flat-blade screwdriver
- Phillips screwdriver
- Small plastic scribe

System Overview

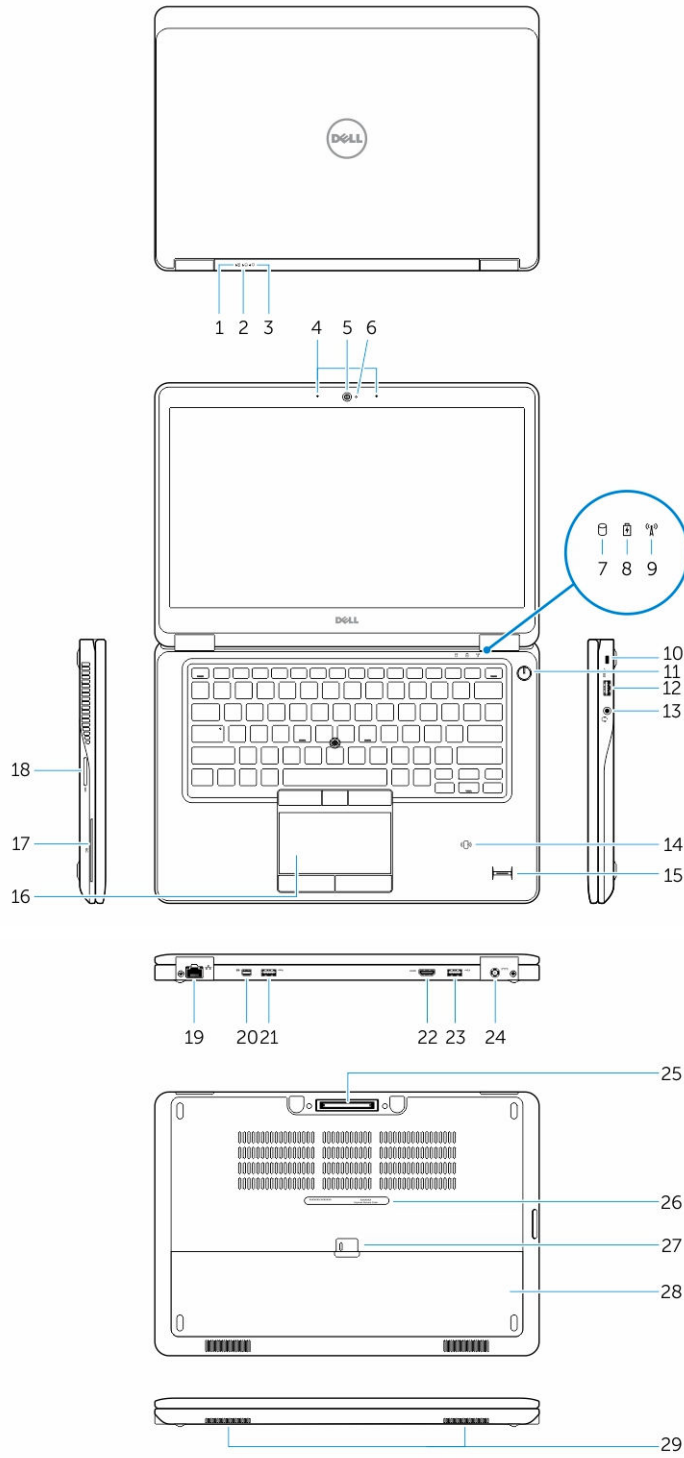

1. Battery-status light
3. Power-status light
5. Camera
7. Hard-drive activity light
9. Wireless-status light
11. Power button
13. Headset connector
15. Fingerprint reader (optional)
17. Smart card reader (optional)
19. Network connector
21. USB 3.0 connector
23. USB 3.0 connector with PowerShare
25. Dock connector
27. Battery release latch
29. Speakers
2. Hard-drive activity light
4. Microphones
6. Camera-status light
8. Battery-status light
10. Security-cable slot
12. USB 3.0 connector
14. Contactless smart-card reader / Near Field Communication (NFC) reader (optional)
16. Touchpad
18. Memory card reader
20. Mini-DisplayPort Connector
22. HDMI connector
24. Power connector
26. Service-tag label
28. Battery

Removing the Battery

1. Follow the procedures in [Before Working Inside Your Computer](#).
2. Slide the release latch to unlock the battery.

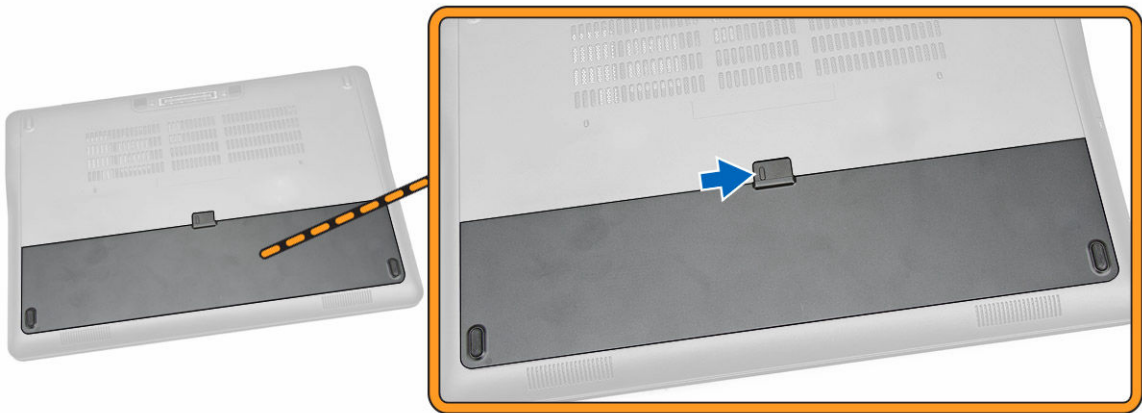

3. Remove the battery from the computer.

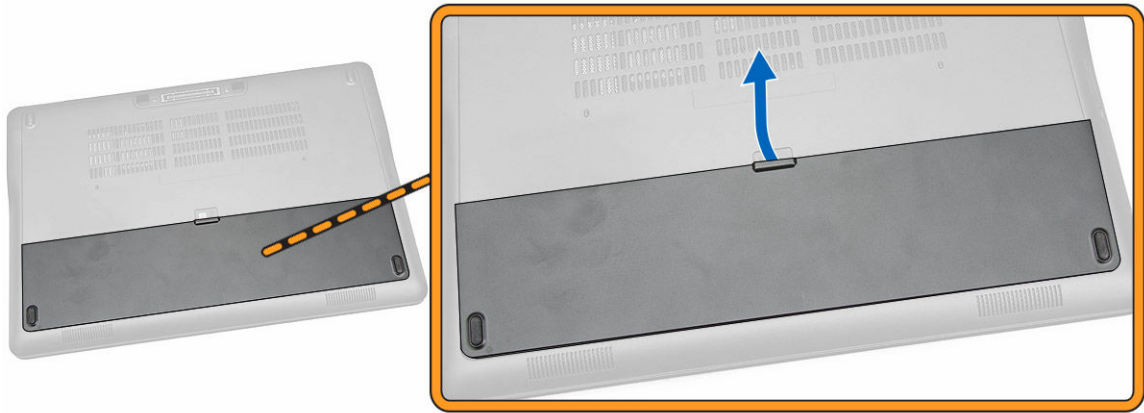

Installing the Battery

1. Slide the battery into its slot until it clicks into place.
2. Follow the procedures in [After Working Inside Your computer](#).

Removing the Base Cover

1. Follow the procedures in [Before Working Inside Your Computer](#).
2. Remove [battery](#).
3. Perform the following steps as shown in the illustration:
 - a. Remove the screws that secure the base cover to the computer [1].
 - b. Slide the base cover to release it from the computer [2].

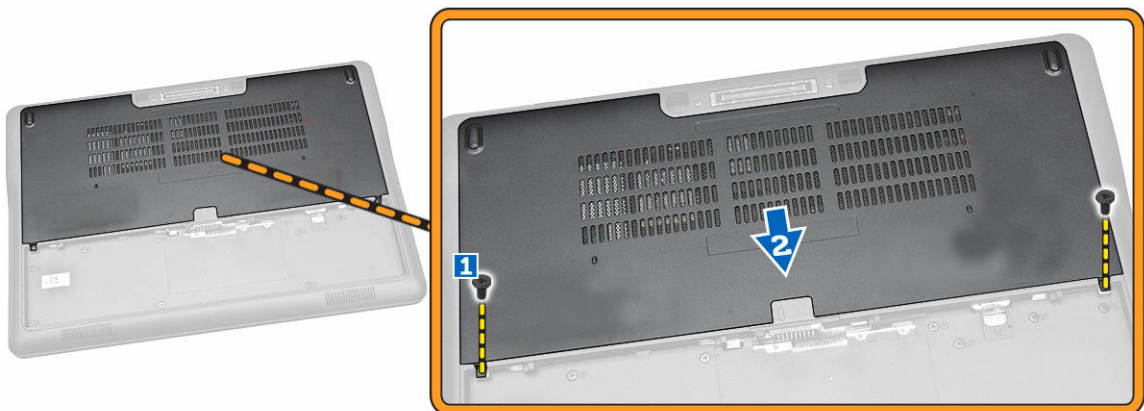

4. Remove the base cover from the computer.



Installing the Base Cover

1. Place the base cover to align with the screw holes correctly on the computer.
2. Tighten the screws to secure the base cover to the computer.
3. Install the [battery](#).
4. Follow the procedures in [After Working Inside Your computer](#).

Removing the Hard Drive

1. Follow the procedures in [Before Working Inside Your Computer](#).
2. Remove:
 - a. [battery](#)
 - b. [base cover](#)
3. Perform the following steps as shown in the illustration:
 - a. Disconnect the hard-drive cable from the computer [1].
 - b. Remove the screws that secure the hard-drive bracket to the hard drive [2].
 - c. Remove the hard-drive bracket to release the hard drive [3].

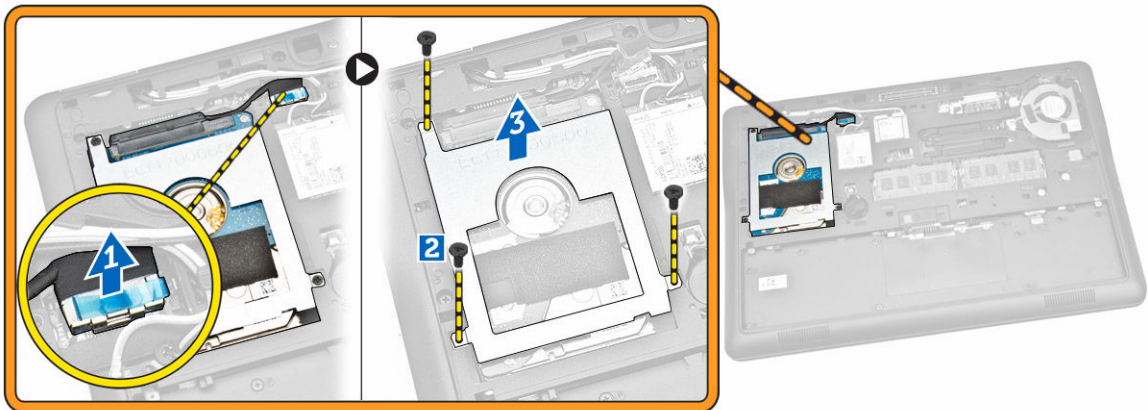

4. Remove the hard drive from the computer.

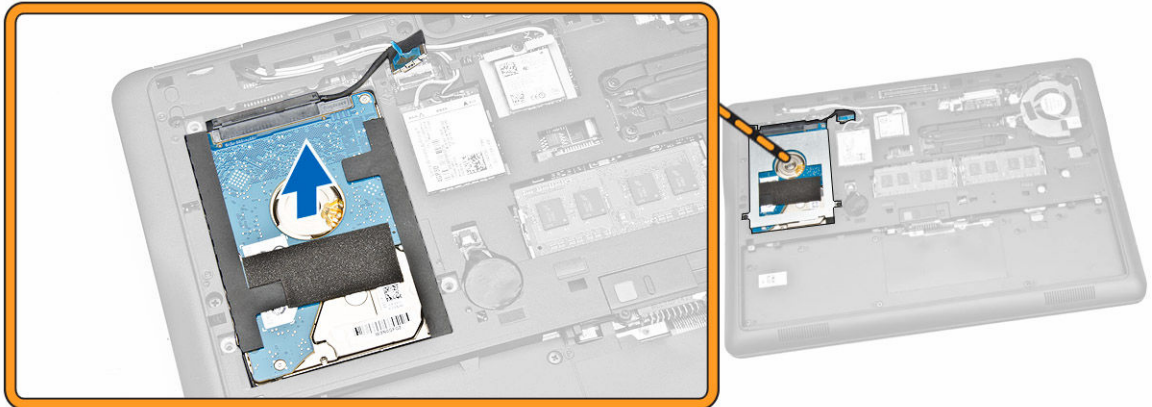

Installing the Hard Drive

1. Place the hard drive inside the computer.
2. Place the hard-drive bracket on the hard drive.
3. Tighten the screws to secure the hard drive to the computer.
4. Connect the hard-drive cable to its connector on the system board..
5. Install:
 - a. [base cover](#)
 - b. [battery](#)
6. Follow the procedures in [After Working Inside Your computer](#).

Removing the Coin-Cell Battery

1. Follow the procedures in [Before Working Inside Your Computer](#).
2. Remove:
 - a. [battery](#)
 - b. [base cover](#)
3. Perform the following steps as shown in the illustration:
 - a. Disconnect the coin-cell cable from its connector on the system board [1].
 - b. Pry the coin-cell to remove from the computer [2].

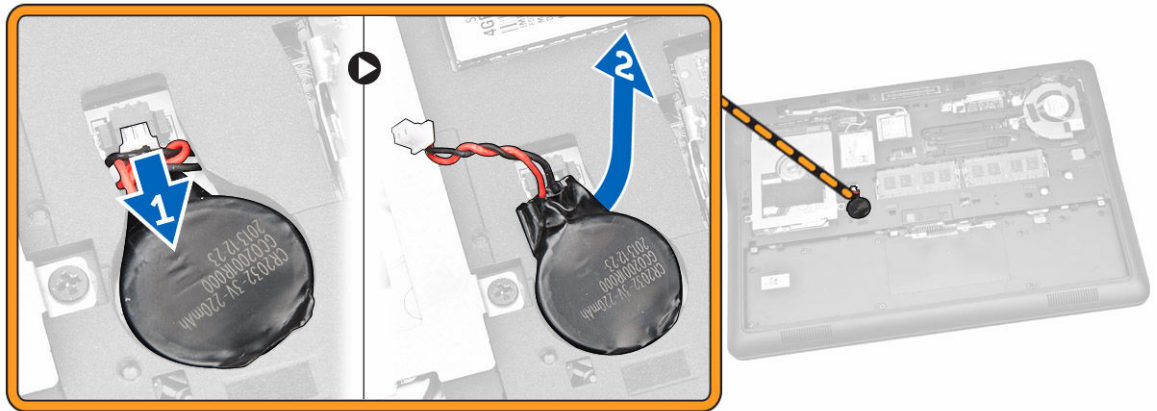

Installing the Coin-Cell Battery

1. Insert the coin-cell battery to its place on the computer.
2. Connect the coin-cell battery cable to its connector on the system board.
3. Install:
 - a. [base cover](#)
 - b. [battery](#)
4. Follow the procedures in [After Working Inside Your computer](#).

Removing the mSATA SSD

1. Follow the procedures in [Before Working Inside Your Computer](#).
2. Remove:
 - a. [battery](#)
 - b. [base cover](#)
3. Perform the following steps as shown in the illustration:
 - a. Remove the screw that secures the mSATA SSD card to the computer [1].
 - b. Lift and remove the mSATA SSD card from the computer [2].

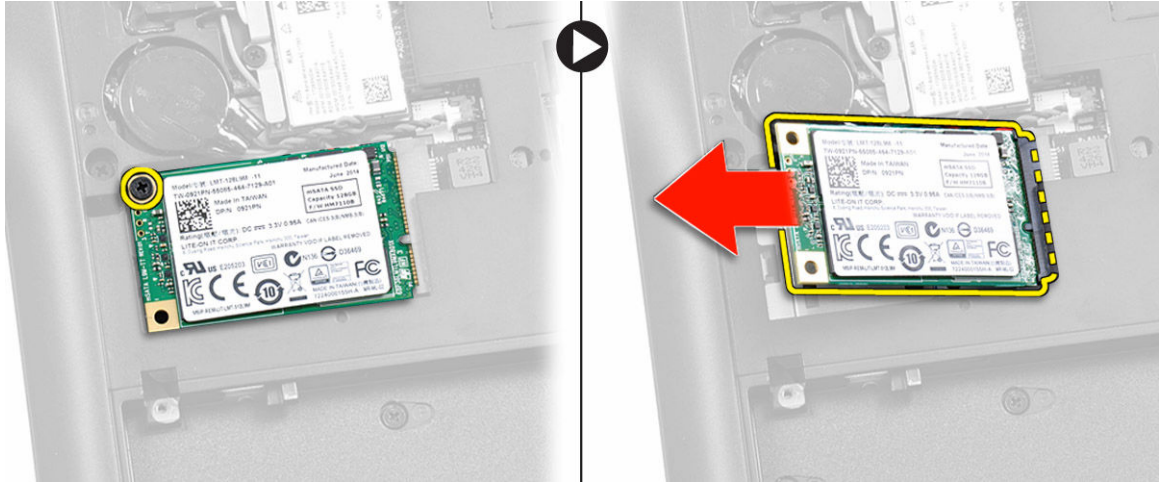

Installing the mSATA SSD

1. Place the mSATA SSD card in its slot in the computer.
2. Tighten the screw to secure the mSATA SSD card to the computer.
3. Install:
 - a. [base cover](#)
 - b. [battery](#)
4. Follow the procedures in [After Working Inside Your computer](#).

Removing the WWAN Card

1. Follow the procedures in [Before Working Inside Your Computer](#).
2. Remove:
 - a. [battery](#)
 - b. [base cover](#)
3. Perform the following steps as shown in the illustration:
 - a. Disconnect the WWAN cables from their connectors on the WWAN card [1].
 - b. Remove the screw that secures the WWAN card to the computer [2].
 - c. Remove the WWAN card from the computer [3].



Installing the mSATA SSD

1. Place the mSATA SSD card in its slot in the computer.
2. Tighten the screw to secure the mSATA SSD card to the computer.
3. Install:
 - a. [base cover](#)
 - b. [battery](#)
4. Follow the procedures in [After Working Inside Your computer](#).

Removing the WLAN Card

1. Follow the procedures in [Before Working Inside Your Computer](#).
2. Remove:
 - a. [battery](#)
 - b. [base cover](#)
3. Perform the following steps as shown in the illustration:
 - a. Remove the screw that secures the WLAN card to the computer [1].
 - b. Remove the metal bracket that secures the WLAN cables [2].
 - c. Disconnect the WLAN cables from their connectors on the WLAN card [3].
 - d. Remove the WLAN card from the computer [4].

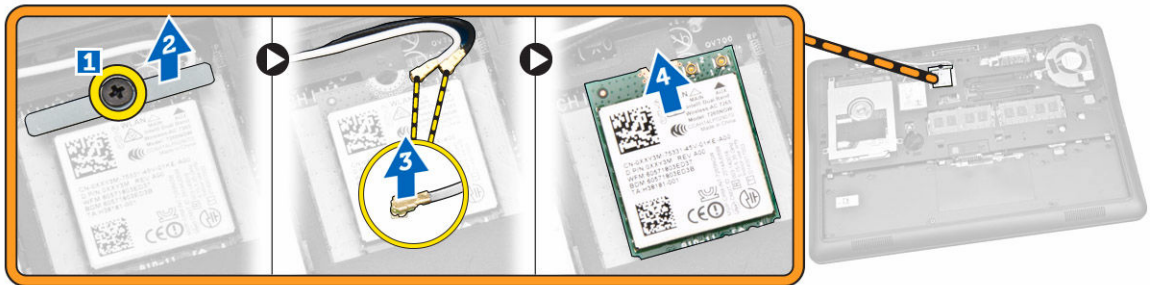

Installing the WLAN Card

1. Place the WLAN card into its slot on the computer.
2. Connect the WLAN cables to their connectors on the WLAN card.
3. Replace the metal bracket on the WLAN card.
4. Tighten the screw to secure the WLAN card to the computer.
5. Install:
 - a. [base cover](#)
 - b. [battery](#)
6. Follow the procedures in [After Working Inside Your computer](#).

Removing the System Fan

1. Follow the procedures in [Before Working Inside Your Computer.](#)
2. Remove:
 - a. [battery](#)
 - b. [base cover](#)
3. Perform the following steps as shown in the illustration:
 - a. Disconnect the system-fan cable from its connector on the system board [1].
 - b. Remove the screws that secure the system fan to the computer [2].
 - c. Remove the system fan from the computer [3].

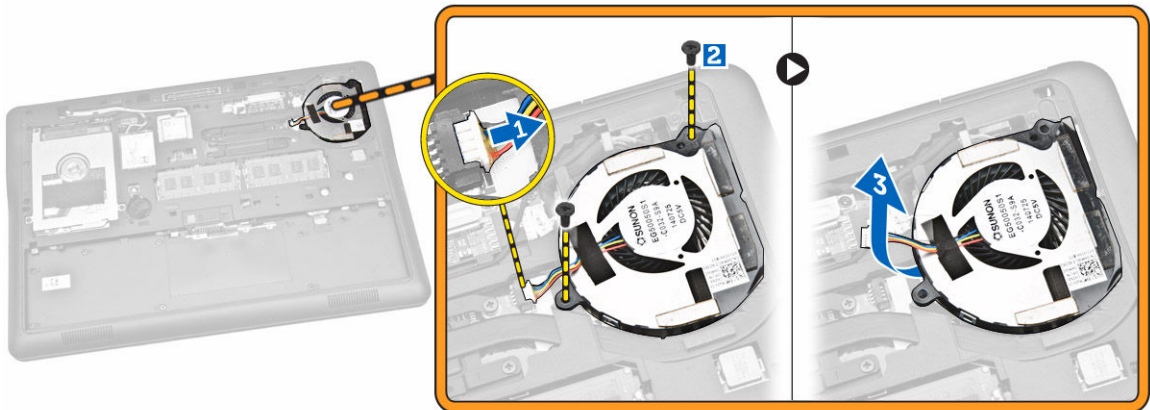

Installing the System Fan

1. Place the system fan into its slot on the computer.
2. Tighten the screws to secure the system fan to the computer.
3. Connect the system-fan cable to the computer.
4. Install:
 - a. [base cover](#)
 - b. [battery](#)
5. Follow the procedures in [After Working Inside Your computer.](#)

Removing the Display Bezel

1. Follow the procedures in [Before Working Inside Your Computer.](#)
2. Remove the [battery](#).
3. Pry the edges to release the display bezel from the display assembly.



4. Remove the display bezel from the display assembly.



Installing the Display Bezel

1. Place the display bezel on the display assembly.
2. Starting from the top corner, press on the display bezel and work around the entire bezel until it click on the display assembly.
3. Install the [battery](#).
4. Follow the procedures in [After Working Inside Your computer](#).

Removing the Display Panel

1. Follow the procedures in [Before Working Inside Your Computer](#).
2. Remove:
 - a. [battery](#)
 - b. [display bezel](#)
3. Perform the following steps as shown in the illustration:

- a. Remove the screws that secure the display panel to the display assembly [1].
- b. Lift the display panel to access the eDP cable [2].



4. Peel the adhesive tape [1] to access the eDP cable [2].

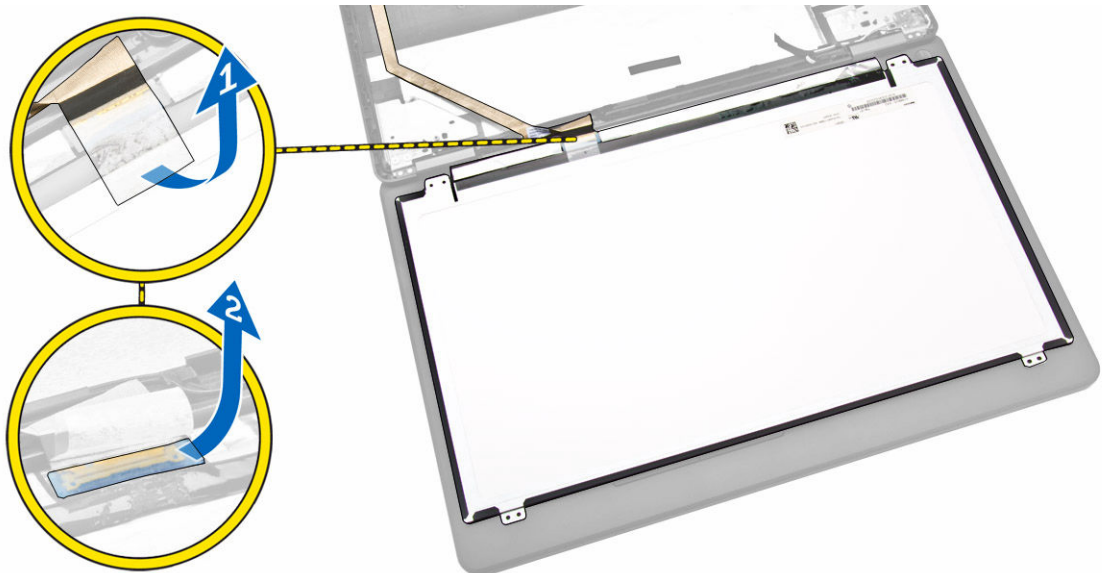

5. Perform the following steps as shown in the illustration:
 - a. Disconnect the eDP cable from its connector on the display assembly [2].
 - b. Remove the display panel from the display assembly [3].

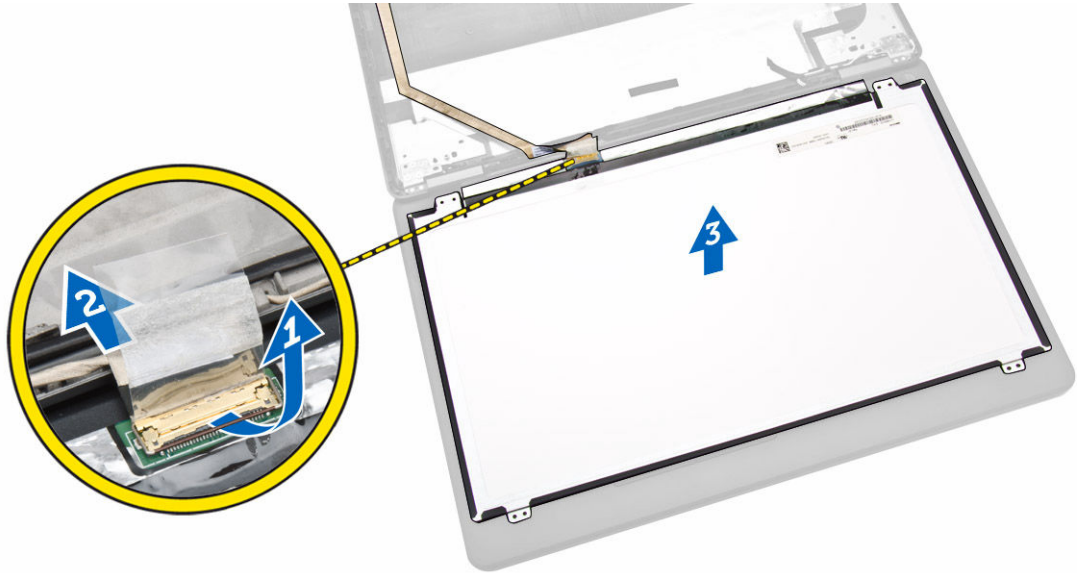

Installing the Display Panel

1. Connect the eDP to its connector on the display panel and affix the adhesive tape.
2. Place the display panel to its original position on the display assembly.
3. Tighten the screws to secure the display panel to the display assembly.
4. Install:
 - a. [display bezel](#)
 - b. [battery](#)
5. Follow the procedures in [After Working Inside Your computer](#).

Removing the Camera

1. Follow the procedures in [Before Working Inside Your Computer](#).
2. Remove:
 - a. [battery](#)
 - b. [display bezel](#)
 - c. [display panel](#)
3. Perform the following steps as shown in the illustration:
 - a. Disconnect the camera cable from its connector on the display assembly [1].
 - b. Remove the camera from the display assembly [2].



Installing the Camera

1. Install the camera into its slot on the display panel.
2. Connect the camera cable to its connector on the display assembly.
3. Install:
 - a. [display panel](#)
 - b. [display bezel](#)
 - c. [battery](#)
4. Follow the procedures in [After Working Inside Your computer](#).

Removing the Keyboard Trim

1. Follow the procedures in [Before Working Inside Your Computer](#).
2. Remove the [battery](#).
3. Using a plastic scribe, pry the keyboard trim from its edges to release it from the keyboard.

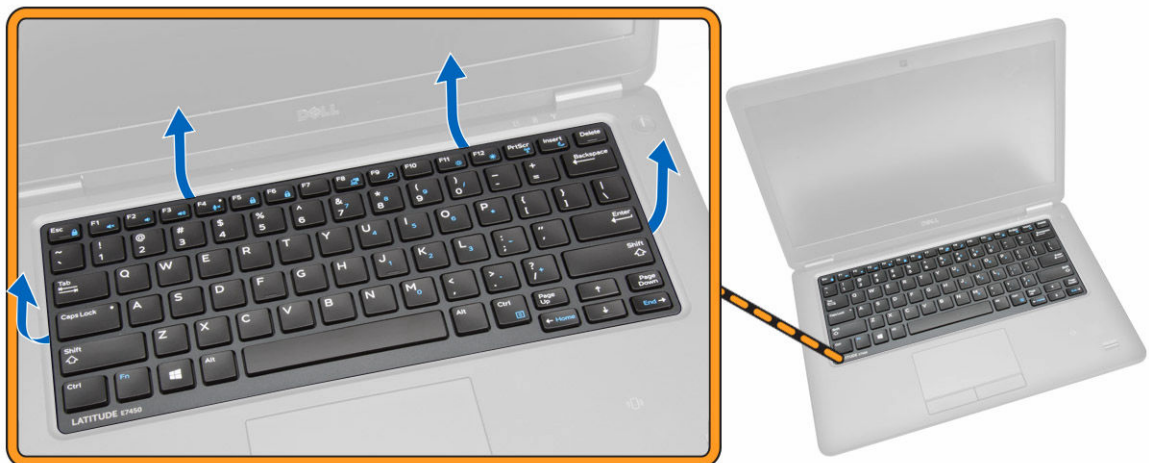

4. Remove the keyboard trim from the keyboard.



Installing the Keyboard Trim

1. Insert the keyboard trim on the keyboard.
2. Press along the sides of the keyboard trim until it clicks in place.
3. Install [battery](#).
4. Follow the procedures in [After Working Inside Your computer](#)

Removing the Keyboard

1. Follow the procedures in [Before Working Inside Your Computer](#)
2. Remove:
 - a. [battery](#)
 - b. [base cover](#)
 - c. [keyboard trim](#)
3. Perform the following steps as shown in the illustration:
 - a. Peel the adhesive tape to access the keyboard cable [1].
 - b. Disconnect the keyboard cable from its connector on the system board [2] [3].

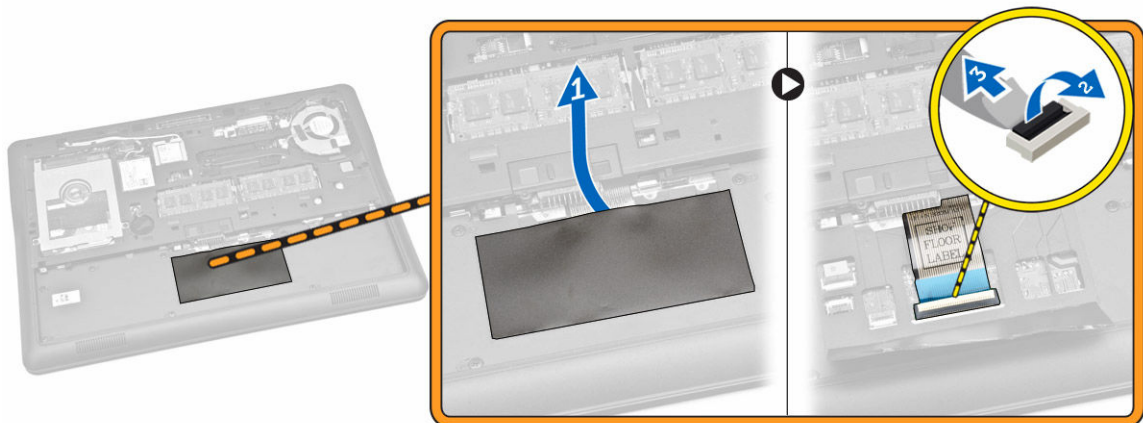

4. Remove the screws that secure the keyboard to the computer.

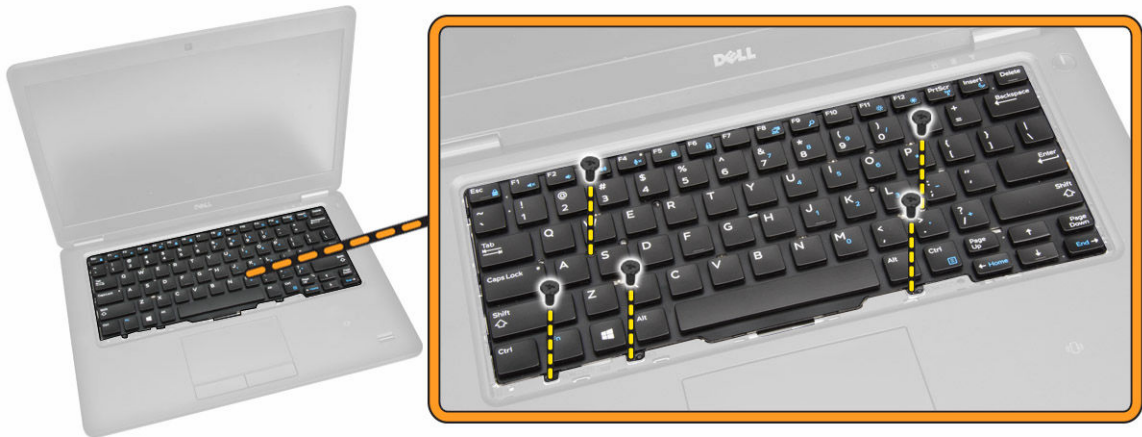

5. Perform the following steps as shown in the illustration:
 - a. Pry the keyboard to release it from the computer [1]
 - b. Remove the keyboard from the computer [2].



Installing the Keyboard

1. Place the keyboard to align with the screw holders to the computer.
2. Tighten the screws to secure the keyboard on the palmrest.
3. Connect the keyboard cable to its connector on the system board.
4. Install:
 - a. [keyboard trim](#)
 - b. [base cover](#)
 - c. [battery](#)
5. Follow the procedures in [After Working Inside Your computer](#)

Removing the Palmrest

1. Follow the procedures in [Before Working Inside Your Computer](#).
2. Remove:

- a. [battery](#)
 - b. [base cover](#)
 - c. [keyboard trim](#)
 - d. [keyboard](#)
3. Remove the screws that secure the palmrest to the computer.

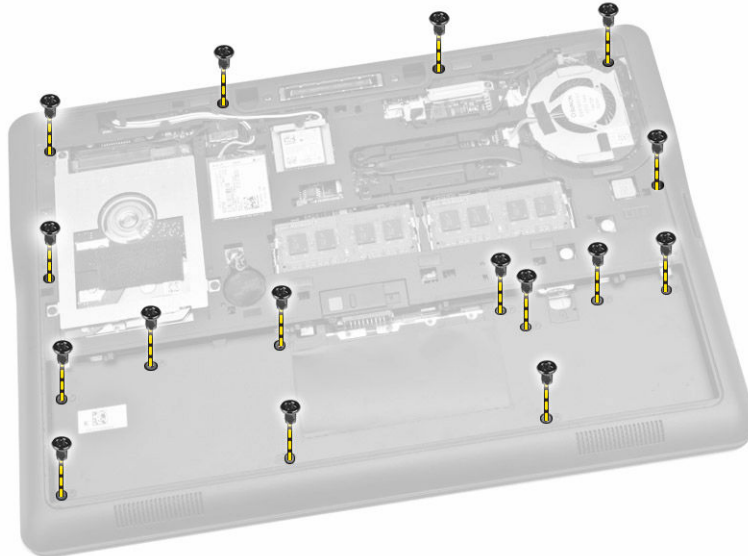

4. Perform the following steps as shown in the illustration:
- a. Flip the computer.
 - b. Disconnect touchpad and power LED cables from their connectors on the system board [1] [2].
 - c. Remove the screws that secure palmrest to the computer [3].

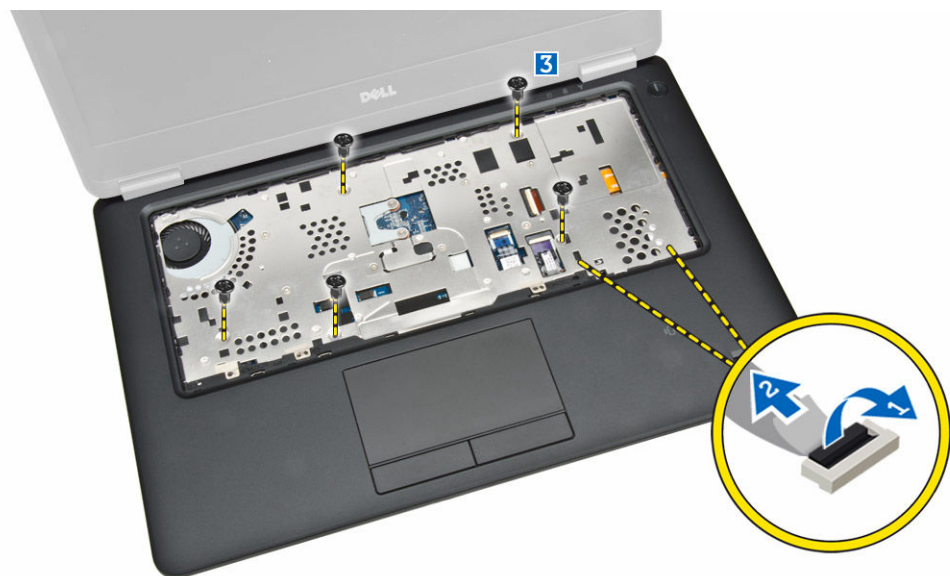

5. Perform the following steps as shown in the illustration:
- a. Pry the edges of the palmrest assembly [1]
 - b. Remove the palmrest from the computer [2].



Installing the Palmrest

1. Align the palmrest to its original position on the computer until it snaps in its place.
2. Connect the power LED and touchpad cables to their connectors on the system board.
3. Tighten the screws to secure the palmrest to the front of the computer.
4. Flip the computer and tighten the screws to secure the palmrest to the computer.
5. Install:
 - a. [keyboard](#)
 - b. [keyboard trim](#)
 - c. [base cover](#)
 - d. [battery](#)
6. Follow the procedures in [After Working Inside Your computer](#) .

Removing the Speakers

1. Follow the procedures in [Before Working Inside Your Computer](#).
2. Remove:
 - a. [battery](#)
 - b. [base cover](#)
 - c. [hard drive](#)
 - d. [keyboard trim](#)
 - e. [keyboard](#)
 - f. [palmrest](#)
3. Perform the following steps as shown in the illustration:
 - a. Disconnect the speaker cable from its connector on the system board [1].
 - b. Release the speaker cables from their routing channels [2].

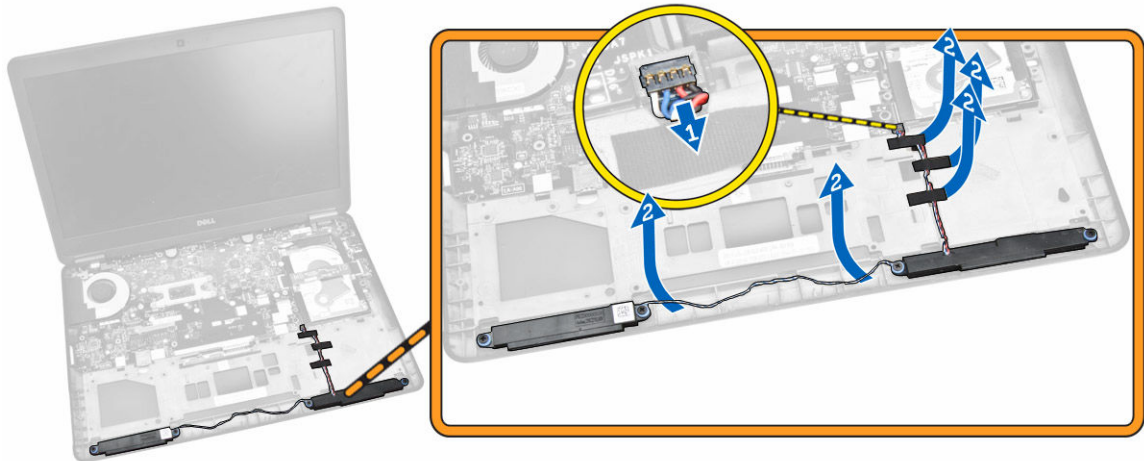

4. Perform the following steps as shown in the illustration:
 - a. Remove the screws that secure the speakers to the computer [1].
 - b. Remove the speakers from the computer [2].

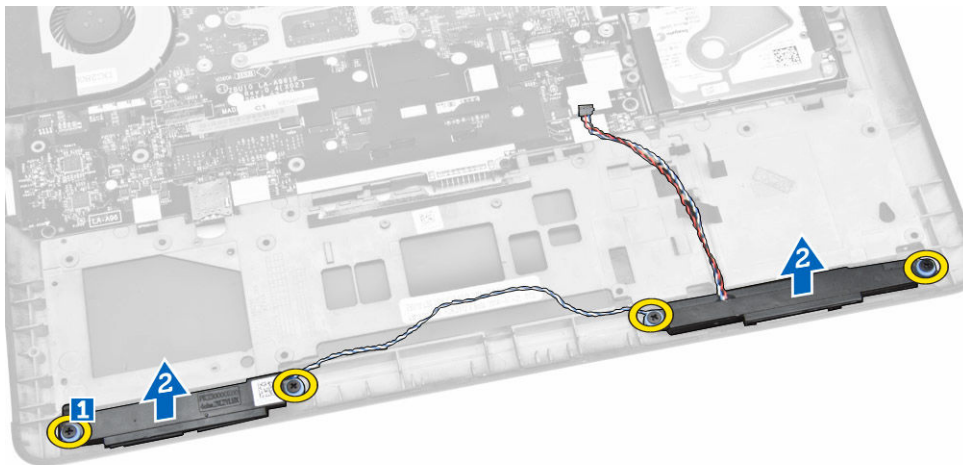

Installing the Speaker

1. Align the speakers to their original position and tighten the screws to secure the speakers to the computer.
2. Route the speaker cables to their routing channels on the computer.
3. Connect the speaker cable to its connector on the system board.
4. Install:
 - a. [palmrest](#)
 - b. [keyboard](#)
 - c. [keyboard trim](#)
 - d. [hard drive](#)
 - e. [base cover](#)
 - f. [battery](#)
5. Follow the procedures in [After Working Inside Your computer](#).

Removing the I/O Board

1. Follow the procedures in [Before Working Inside Your Computer.](#)
2. Remove:
 - a. [battery](#)
 - b. [base cover](#)
 - c. [hard drive](#)
 - d. [keyboard trim](#)
 - e. [keyboard](#)
 - f. [palmrest](#)
3. Perform the following steps as shown in the illustration:
 - a. Disconnect the I/O board cable from its connector on the system board [1] [2].
 - b. Remove the screws that secure the I/O board to the computer [3].
 - c. Remove the I/O board from the computer [4].

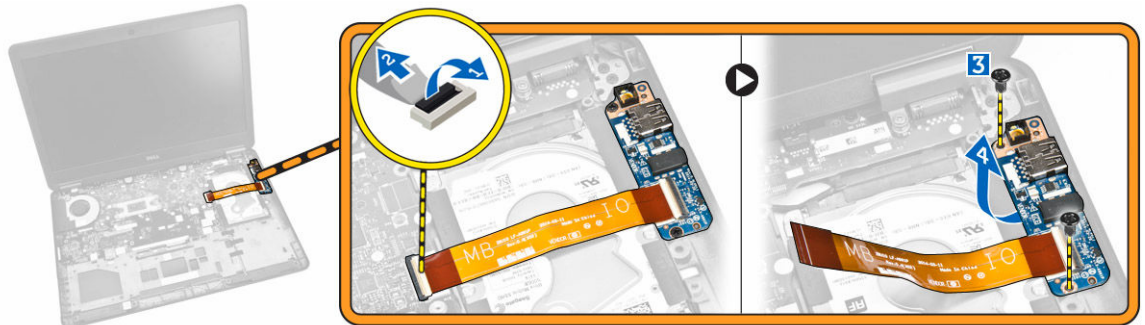

Installing the I/O Board

1. Insert the I/O board to its place on the computer.
2. Tighten the screws to secure the I/O board to the computer.
3. Connect the I/O board cable to its connector on the system board.
4. Install:
 - a. [palmrest](#)
 - b. [keyboard](#)
 - c. [keyboard trim](#)
 - d. [hard drive](#)
 - e. [base cover](#)
 - f. [battery](#)
5. Follow the procedures in [After Working Inside Your computer.](#)

Removing the Display-Hinge Cover

1. Follow the procedures in [Before Working Inside Your Computer.](#)
2. Remove:
 - a. [battery](#)
 - b. [base cover](#)

- c. [keyboard trim](#)
 - d. [keyboard](#)
 - e. [palmrest](#)
3. Remove the screws that secure the display-hinge covers to the computer.

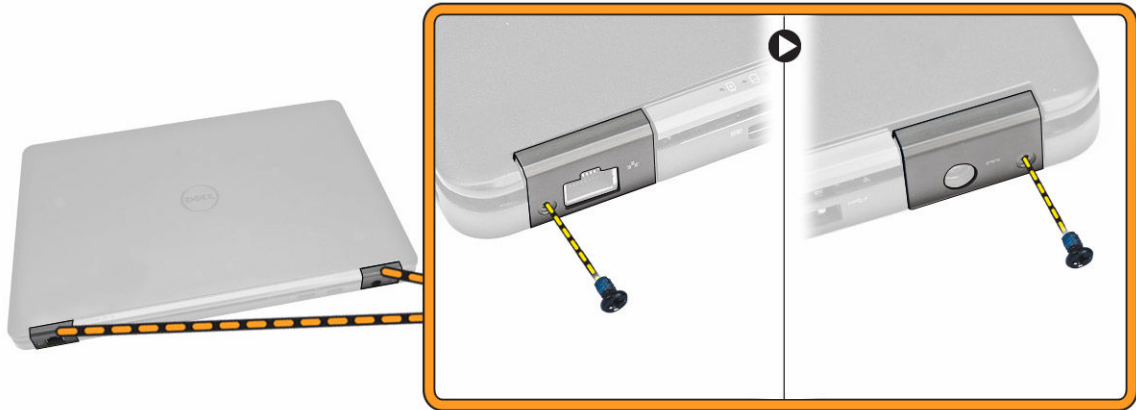

4. Perform the following steps as shown in the illustration:
- a. Remove the screws that secure display-hinge covers to the computer [1].
 - b. Remove the display-hinge covers from the computer [2].

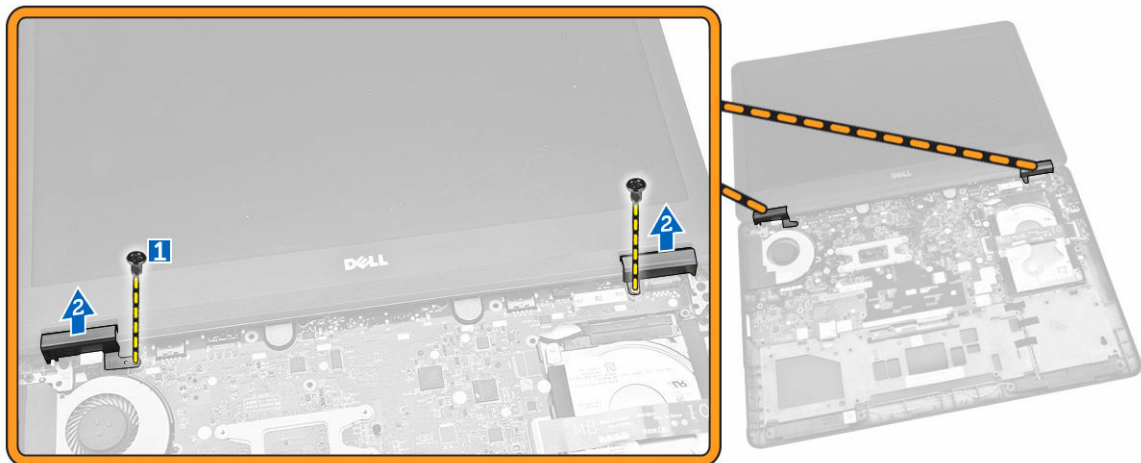

Installing the Display-Hinge Cover

1. Place the display-hinge covers on the system and tighten the screws to secure the display-hinge covers to the computer.
2. Tighten the screws to secure the display-hinge covers at the back of the computer.
3. Install:
 - a. [palmrest](#)
 - b. [keyboard](#)
 - c. [keyboard trim](#)
 - d. [base cover](#)

- e. [battery](#)
- 4. Follow the procedures in [After Working Inside Your computer.](#)

Removing the Display Assembly

1. Follow the procedures in [Before Working Inside Your Computer.](#)
2. Remove:
 - a. [battery](#)
 - b. [base cover](#)
 - c. [keyboard trim](#)
 - d. [keyboard](#)
 - e. [hard drive](#)
 - f. [palmrest](#)
3. Release the WWAN and WLAN cables from their routing channels.

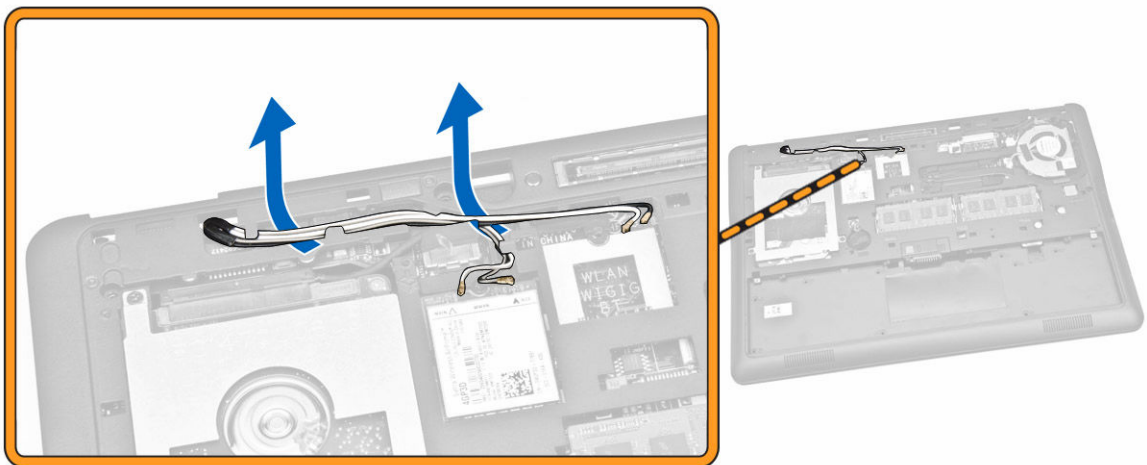

4. Perform the following steps as shown in the illustration:
 - a. Release the screw to release the metal bracket that secures the display-assembly cable [1].
 - b. Remove the metal bracket to access the display-assembly cable [2].
 - c. Disconnect the display-assembly cables from their connectors on the system board [3] [4].

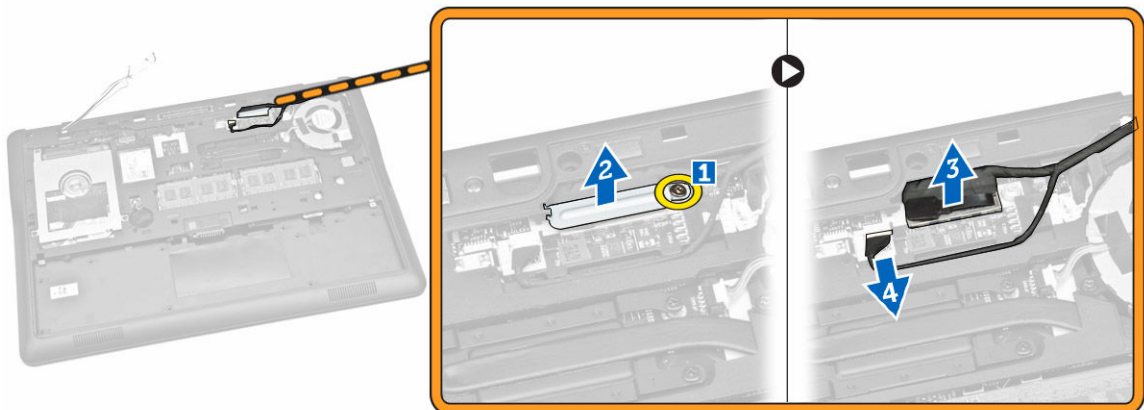

5. Pull the WLAN, WWAN and display-assembly cables from the holes on the base chassis that secure the display assembly to the computer.

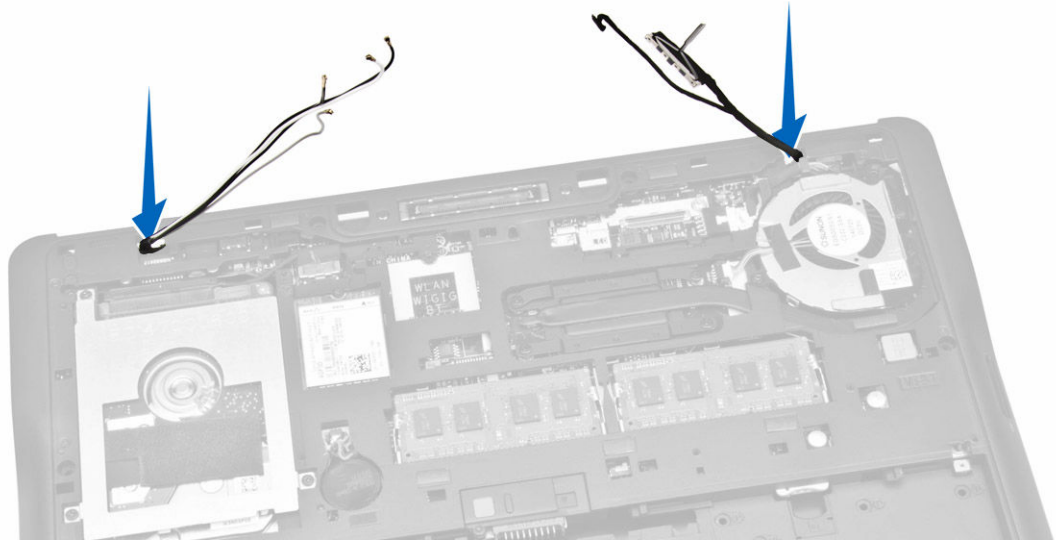

6. Perform the following steps as shown in the illustration:
 - a. Remove the screws that secure the display assembly to the computer [1].
 - b. Lift the display assembly to remove from the computer [2].



Installing the Display Assembly

1. Route the WWAN, WLAN, and display-assembly cables through their respective routing channels on the base chassis and connect to their connectors.
2. Place the display assembly onto the computer.
3. Tighten the screws to secure the display assembly to the computer.

4. Place the metal bracket on the display-assembly cable and tighten the screw to secure the display-assembly cable.
5. Install:
 - a. [palmrest](#)
 - b. [hard drive](#)
 - c. [keyboard](#)
 - d. [keyboard trim](#)
 - e. [base cover](#)
 - f. [battery](#)
6. Follow the procedures in [After Working Inside Your computer](#).

Removing the System Board

1. Follow the procedures in [Before Working Inside Your Computer](#).
2. Remove:
 - a. [battery](#)
 - b. [base cover](#)
 - c. [keyboard trim](#)
 - d. [keyboard](#)
 - e. [hard drive](#)
 - f. [palmrest](#)
 - g. [WWAN card](#)
 - h. [WLAN card](#)
 - i. [hinge cover](#)
 - j. [display assembly](#)
3. Disconnect the hard-drive cable [1] and power-connector port cable [2] from their connectors on the system board.

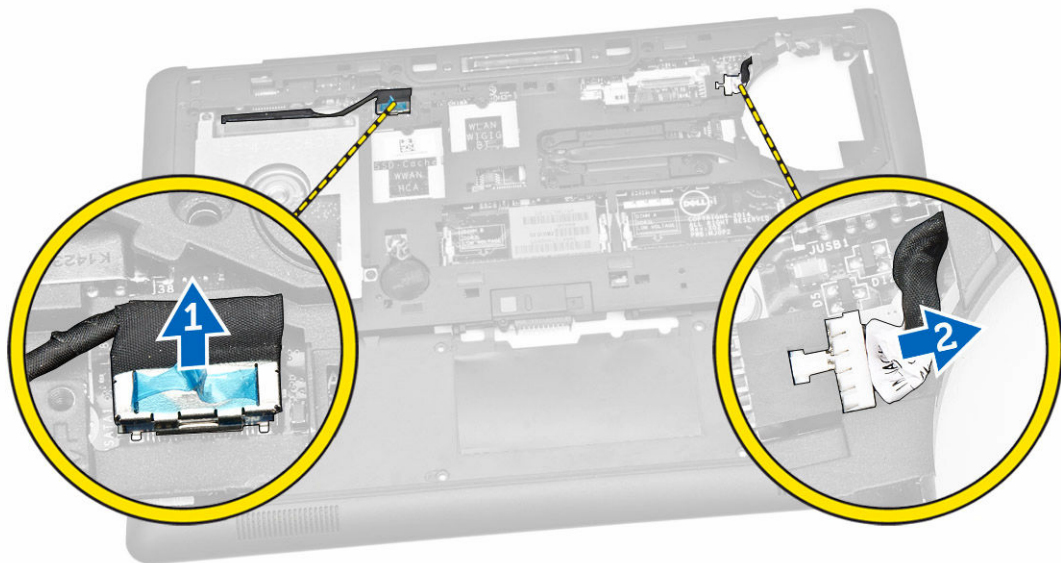

4. Disconnect the speaker cable [1] [2] and I/O board cable [3] from their connectors on the system board.

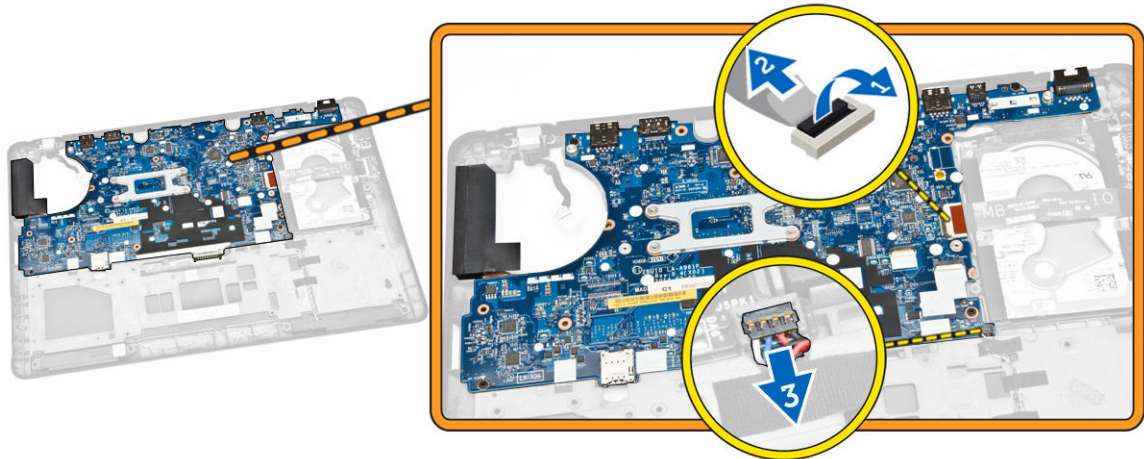

5. Perform the following steps as shown in the illustration:
 - a. Remove the screws that secure the system board to the computer chassis [1].
 - b. Remove the system board from the computer chassis [2].

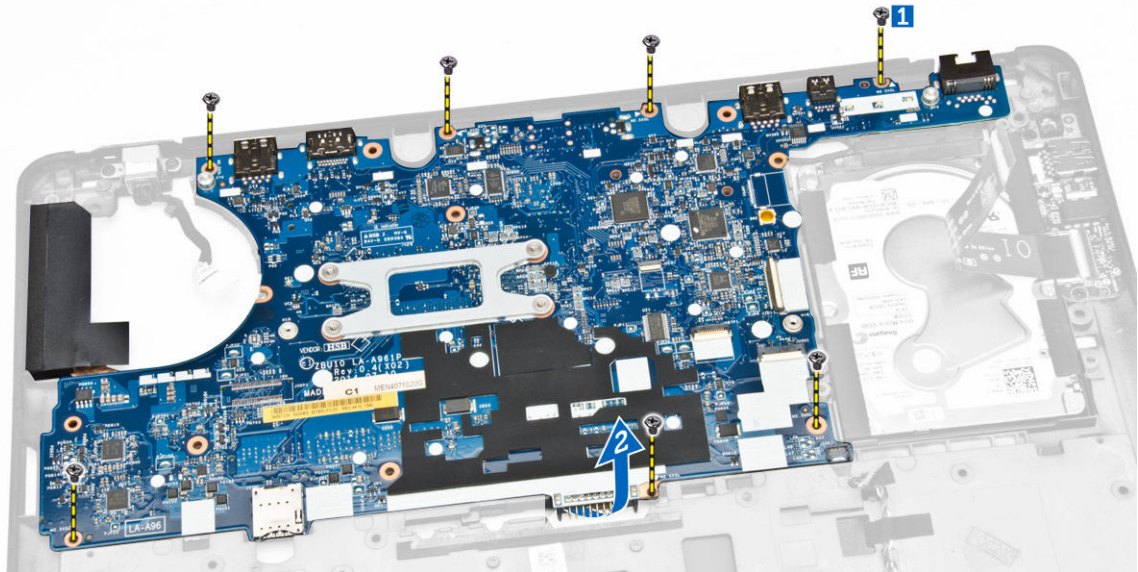

Installing the System Board

1. Place the system board on the computer chassis to align it with the screw holders.
2. Tighten the screws to secure the system board to the computer chassis.
3. Connect the speaker and I/O board cables to their connectors on the system board.
4. Connect the hard-drive cable and power-connector port cable to their connectors on the system board.
5. Install:
 - a. [display assembly](#)
 - b. [hinge cover](#)
 - c. [WLAN card](#)

- d. [WWAN card](#)
 - e. [palmrest](#)
 - f. [hard drive](#)
 - g. [keyboard trim](#)
 - h. [keyboard](#)
 - i. [base cover](#)
 - j. [battery](#)
6. Follow the procedures in [After Working Inside Your computer](#).

Removing the Heatsink

1. Follow the procedures in [Before Working Inside Your Computer](#).
2. Remove:
 - a. [battery](#)
 - b. [base cover](#)
 - c. [keyboard trim](#)
 - d. [keyboard](#)
 - e. [palmrest](#)
 - f. [hard drive](#)
 - g. [WWAN card](#)
 - h. [WLAN card](#)
 - i. [display assembly](#)
 - j. [system fan](#)
 - k. [system board](#)
3. Perform the following steps as shown in the illustration:
 - a. Remove the screws that secure the heatsink to the system board [1].
 - b. Remove the heatsink from the system board [2].

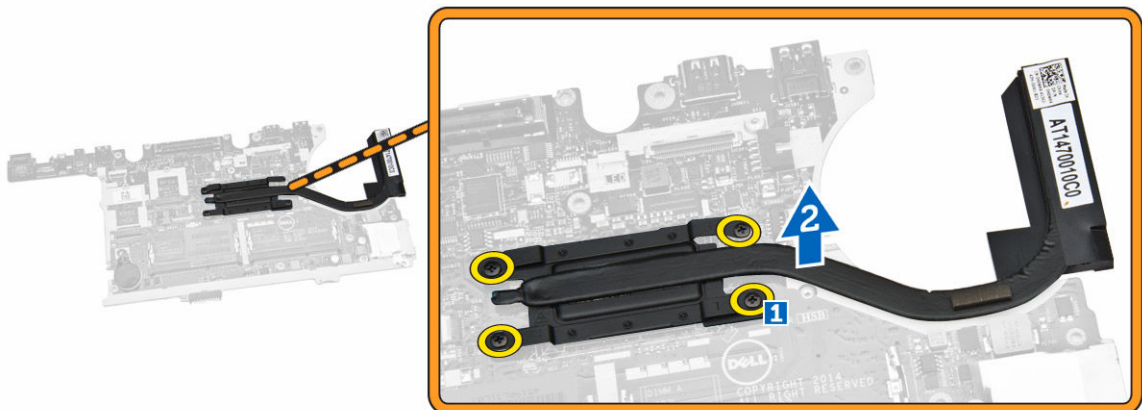

Installing the Heatsink

1. Place the heatsink into its original position on the system board.
2. Tighten the screws to secure the heatsink to the system board.
3. Install:

- a. [system board](#)
 - b. [system fan](#)
 - c. [display assembly](#)
 - d. [WLAN card](#)
 - e. [WWAN card](#)
 - f. [hard drive](#)
 - g. [palmrest](#)
 - h. [keyboard](#)
 - i. [keyboard trim](#)
 - j. [base cover](#)
 - k. [battery](#)
4. Follow the procedures in [After Working Inside Your computer](#).

Removing the Power-Connector Port

1. Follow the procedures in [Before Working Inside Your Computer](#).
2. Remove:
 - a. [battery](#)
 - b. [base cover](#)
 - c. [keyboard trim](#)
 - d. [keyboard](#)
 - e. [palmrest](#)
 - f. [hard drive](#)
 - g. [WWAN card](#)
 - h. [WLAN card](#)
 - i. [hinge cover](#)
 - j. [display assembly](#)
 - k. [camera](#)
 - l. [coincell battery](#)
 - m. [I/O board](#)
 - n. [speakers](#)
 - o. [system fan](#)
 - p. [system board](#)
3. Perform the following steps as shown in the illustration:
 - a. Remove the screws to release the metal bracket that secure the power-connector port [1].
 - b. Remove the metal bracket from the power-connector port [2].
 - c. Remove the power-connector port from the computer chassis [3].

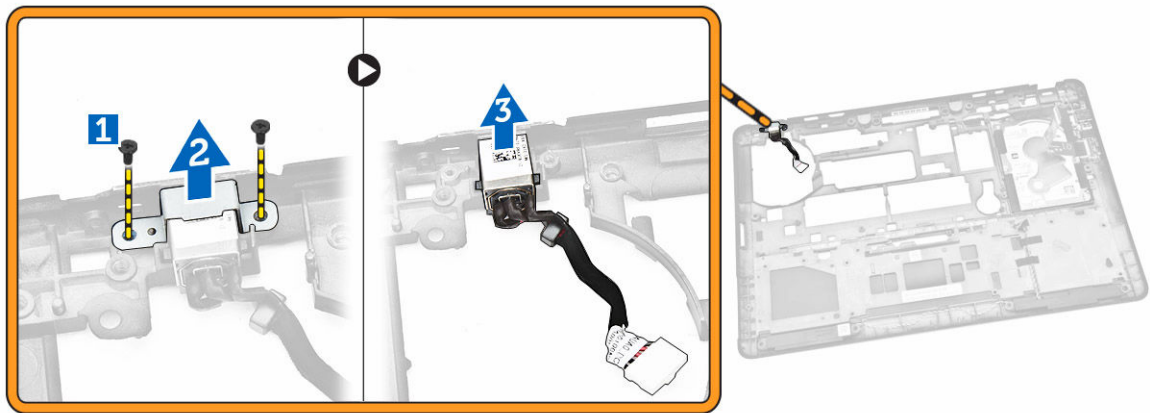

Installing the Power Connector

1. Insert the power connector in its slot on the computer chassis.
2. Place the metal bracket on the power-connector port.
3. Tighten the screws to secure the power-connector port to the computer chassis.
4. Install:
 - a. [system board](#)
 - b. [system fan](#)
 - c. [speaker](#)
 - d. [I/O board](#)
 - e. [coincell battery](#)
 - f. [camera](#)
 - g. [display assembly](#)
 - h. [hinge cover](#)
 - i. [WLAN card](#)
 - j. [WWAN card](#)
 - k. [hard drive](#)
 - l. [palmrest](#)
 - m. [keyboard](#)
 - n. [keyboard trim](#)
 - o. [base cover](#)
 - p. [battery](#)
5. Follow the procedures in [After Working Inside Your computer](#).

System Setup

Boot Sequence

Boot Sequence allows you to bypass the System Setup-defined boot device order and boot directly to a specific device (for example: optical drive or hard drive). During the Power-on Self Test (POST), when the Dell logo appears, you can:

- Access System Setup by pressing <F2> key
- Bring up the one-time boot menu by pressing <F12> key

The one-time boot menu displays the devices that you can boot from including the diagnostic option. The boot-menu options are:

- Removable Drive (if available)
- STXXXX Drive

 **NOTE:** XXX denotes the SATA drive number.

- Optical Drive
- Diagnostics

 **NOTE:** Choosing Diagnostics, will display the **ePSA diagnostics** screen.

The boot sequence screen also displays the option to access the System Setup screen.

Navigation Keys

The following table displays the system setup navigation keys.



 **NOTE:** For most of the system setup options, changes that you make are recorded but do not take effect until you re-start the system.

Table 1. Navigation Keys

Keys	Navigation
Up arrow	Moves to the previous field.
Down arrow	Moves to the next field.
<Enter>	Allows you to select a value in the selected field (if applicable) or follow the link in the field.
Spacebar	Expands or collapses a drop-down list, if applicable.
<Tab>	Moves to the next focus area.

Keys	Navigation
	 NOTE: For the standard graphics browser only.
<Esc>	Moves to the previous page till you view the main screen. Pressing <Esc> in the main screen displays a message that prompts you to save any unsaved changes and restarts the system.
<F1>	Displays the System Setup help file.

System Setup Options



 **NOTE:** Depending on your computer and its installed devices, the items listed in this section may or may not appear.

Table 2. General

Option	Description
System Information	<p>This section lists the primary hardware features of your computer.</p> <ul style="list-style-type: none"> • System Information: Displays BIOS Version, Service Tag, Asset Tag, Ownership Tag, Ownership Date, Manufacture Date, and the Express Service Code. • Memory Information: Displays Memory Installed, Memory Available, Memory Speed, Memory Channels Mode, Memory Technology, DIMM A Size, DIMM B Size, • Processor Information: Displays Processor Type, Core Count, Processor ID, Current Clock Speed, Minimum Clock Speed, Maximum Clock Speed, Processor L2 Cache, Processor L3 Cache, HT Capable, and 64-Bit Technology. • Device Information: Displays Primary Hard Drive, System eSATA Device, Dock eSATA Device, LOM MAC Address, Video Controller, Video BIOS Version, Video Memory, Panel Type, Native Resolution, Audio Controller, Modem Controller, Wi-Fi Device, WiGig Device, Cellular Device, Bluetooth Device.
Battery Information	Displays the battery status and the type of AC adapter connected to the computer
Boot Sequence	<p>Allows you to change the order in which the computer attempts to find an operating system.</p> <ul style="list-style-type: none"> • Diskette Drive • Internal HDD • USB Storage Device • CD/DVD/CD-RW Drive

Option	Description
	<ul style="list-style-type: none"> Onboard NIC
Advance Boot Option	<p>This option is required for Legacy boot mode. This option is not allowed if Secure Boot is enabled.</p> <ul style="list-style-type: none"> Enable Legacy Option ROMs — This option is disabled by default.
Date/Time	Allows you to set the date and time.

Table 3. System Configuration

Option	Description
Integrated NIC	<p>Allows you to configure the integrated network controller. The options are:</p> <ul style="list-style-type: none"> Disabled Enabled Enabled w/PXE: This option is enabled by default. Enable UEFI Network Stack: This allows you to enable UEFI Networking Protocols in pre-OS and early OS networking environment.
Parallel Port	<p>Allows you to define and set how the parallel port on the docking station operates. You can set the parallel port to:</p> <ul style="list-style-type: none"> Disabled AT PS2 ECP
Serial Port	<p>Identifies and defines the serial port settings. You can set the serial port to:</p> <ul style="list-style-type: none"> Disabled COM1 (Default Setting) COM2 COM3 COM4 <p> NOTE: The operating system may allocate resources even if the setting is disabled.</p>
SATA Operation	<p>Allows you to configure the internal SATA hard-drive controller. The options are:</p> <ul style="list-style-type: none"> Disabled AHCI RAID On (Default Setting)

Option	Description
Drives	<p> NOTE: SATA is configured to support RAID mode.</p> <p>Allows you to configure the SATA drives on board. The options are:</p> <ul style="list-style-type: none"> • SATA-0 • SATA-1 • SATA-2 • SATA-3 <p>Default Setting: All drives are enabled.</p>
SMART Reporting	<p>This field controls if the hard-drive errors for the integrated drives are reported during system startup. This technology is part of the SMART (Self Monitoring Analysis and Reporting Technology) specification.</p> <ul style="list-style-type: none"> • Enable SMART Reporting - This option is disabled by default.
USB Configuration	<p>Allows you to define the USB configuration. The options are:</p> <ul style="list-style-type: none"> • Enable Boot Support • Enable External USB Port • Enable USB3.0 Controller <p>Default Setting: All the options are enabled.</p>
USB PowerShare	<p>Allows you to configure the behavior of the USB PowerShare feature. The option is disabled by default.</p> <ul style="list-style-type: none"> • Enable USB PowerShare
Audio	<p>Allows you to enables or disables the integrated audio controller.</p> <ul style="list-style-type: none"> • Enable Audio—This option is enabled by default.
Unobtrusive Mode	<p>Allows you to set the mode that will turn off all light and sound emissions from the system. The option is disabled by default.</p> <ul style="list-style-type: none"> • Enable Unobtrusive Mode
Miscellaneous Devices	<p>Allows you enable or disable the various on board devices. The options are:</p> <ul style="list-style-type: none"> • Enable Microphone • Enable Hard Drive Free Fall Protection • Enable Camera



Option	Description
	<ul style="list-style-type: none"> • Enable Media Card • Disable Media Card <p>Default Setting: All devices are enabled</p>

Table 4. Video

Option	Description
LCD Brightness	Allows you to set the display brightness depending up on the power source (On Battery and On AC).

Table 5. Security

Option	Description
Admin Password	<p>This field lets you set, change, or delete the administrator (admin) password (sometimes called the setup password). The admin password enables several security features.</p> <ul style="list-style-type: none"> • Enter the old password • Enter the new password • Confirm the new password <p>Default Setting: Not set</p>
System Password	<p>Allows you to set, change, or delete the system password.</p> <ul style="list-style-type: none"> • Enter the old password • Enter the new password • Confirm the new password <p>Default Setting: Not set</p>
Internal HDD-1 Password	<p>Allows you to set, change, or delete the administrator password. The drive does not have a password set by default.</p> <ul style="list-style-type: none"> • Enter the old password • Enter the new password • Confirm the new password <p>Default Setting: Not set</p>
Strong Password	<p>Allows you to enforce the option to always set strong passwords. Default Setting: Enable Strong Password is not selected.</p>
Password Configuration	<p>You can define the length of your password. Min = 4 , Max = 32</p>
Password Bypass	<p>Allows you to disable the permission to bypass the System and the Internal HDD password, when they are set. The options are:</p> <ul style="list-style-type: none"> • Disabled (Default Setting) • Reboot bypass
Password Change	<p>Allows you to disable permission to the System and hard-drive passwords when the admin password is set.</p>

Option	Description
	Default Setting: Allow Non-Admin Password Changes is not selected
Non-Admin Setup Changes	<p>Allows you to determine whether changes to setup option are permitted when an administrator password is set. The option is disabled.</p> <ul style="list-style-type: none"> Allows Wireless Switch Changes
TPM Security	<p>Allows you to enable the Trusted Platform Module (TPM) during POST.</p> <p>Default Setting: The option is disabled.</p>
Computrace	<p>Allows you to activate or disable the optional Computrace software. The options are:</p> <ul style="list-style-type: none"> Deactivate (Default Setting) Disable Activate <p> NOTE: The Activate and Disable options will permanently activate or disable the feature and no further changes will be allowed</p>
CPU XD Support	<p>Allows you to enable the Execute Disable mode of the processor.</p> <p>Default Setting: Enable CPU XD Support</p>
OROM Keyboard Access	<p>Allows you to set access to enter the Option ROM Configuration screens using hotkeys during boot process. The options are:</p> <ul style="list-style-type: none"> Enable (Default Setting) One-Time Enable Disable
Admin Setup Lockout	<p>Allows you to prevent users from entering Setup when an Administrator password is set.</p> <p>Default Setting: Disabled</p>
Table 6. Secure Boot	
Secure Boot Enable	<p>Allows you to enable or disable Secure Boot feature</p> <ul style="list-style-type: none"> Disabled Enabled(Default Setting) <p> NOTE: To enable the Secure Boot, system needs to be UEFI boot mode and enable legacy option ROMs must be turned off.</p>
Expert key Management	<p>Allows you to manipulate the security key databases only if the system is in Custom Mode. The Enable Custom Mode option is disabled by default. The options are:</p> <ul style="list-style-type: none"> PK KEK db dbx

If you enable the Custom Mode, the relevant options for PK, KEK, db, and dbx appear. The options are:

- Save to File- Saves the key to a user-selected file
- Replace from File- Replaces the current key with a key from a user-selected file
- Append from File- Adds a key to the current database from a user-selected file
- Delete- Deletes the selected key
- Reset All Keys- Resets to default setting
- Delete All Keys- Deletes all the keys

 **NOTE:** If you disable the Custom Mode, all the changes made will be erased and the keys will restore to default settings.

Table 7. Performance

Option	Description
Multi-Core Support	This field specifies whether the process will have one or all cores enabled. The performance of some applications will improve with the additional cores. This option is enabled by default. Allows you to enable or disable multi-core support for the processor. The options are: <ul style="list-style-type: none"> • All (Default Setting) • 1 • 2
Intel SpeedStep	Allows you to enable or disable the Intel SpeedStep feature. Default Setting: Enable Intel SpeedStep
C-States Control	Allows you to enable or disable the additional processor sleep states. Default Setting: The option C-states is enabled.
Intel TurboBoost	Allows you to enable or disable the Intel TurboBoost mode of the processor. Default Setting: Enable Intel TurboBoost
Hyper-Thread Control	Allows you to enable or disable the HyperThreading in the processor. Default Setting: Enabled

Table 8. Power Management

Option	Description
AC Behavior	Allows the computer to power-on automatically, when AC adapter is plugged. The option is disabled.

Option	Description
Auto On Time	<ul style="list-style-type: none"> • Wake on AC <p>Allows you to set the time at which the computer must turn on automatically. The options are:</p> <ul style="list-style-type: none"> • Disabled (Default Setting) • Every Day • Weekdays • Select Days
USB Wake Support	<p>Allows you to enable the USB devices to wake the computer from standby mode. The option is disabled</p> <ul style="list-style-type: none"> • Enable USB Wake Support
Wireless Radio Control	<p>Allows you to control the WLAN and WWAN radio. The options are:</p> <ul style="list-style-type: none"> • Control WLAN radio • Control WWAN radio <p>Default Setting: Both the options are disabled.</p>
Wake on LAN/WLAN	<p>This option allows the computer to power up from the off state when triggered by a special LAN signal. Wake-up from the Standby state is unaffected by this setting and must be enabled in the operating system. This feature only works when the computer is connected to AC power supply.</p> <ul style="list-style-type: none"> • Disabled - Does not allow the system to power on by special LAN signals when it receives a wake-up signal from the LAN or wireless LAN. (Default Setting) • LAN Only - Allows the system to be powered on by special LAN signals. • WLAN Only • LAN or WLAN
Block Sleep	<p>Allows you to block the computer from entering into the sleep state. Option is disabled by default.</p> <ul style="list-style-type: none"> • Block Sleep (S3)
Peak Shift	<p>Peak Shift can be used to minimize AC consumption during peak powers times of day. Set the start and end time to run in Peak Shift mode.</p> <ul style="list-style-type: none"> • Enable Peak Shift (Disabled)
Advanced Battery Charge Configuration	<p>Allows batteries in the system in Advanced Battery Charge Mode to maximize battery health. This uses standard charging algorithm and other techniques during non-work hours to maximize battery health</p> <ul style="list-style-type: none"> • Enable Advanced Battery Charge Mode (Disabled)
Primary Battery Configuration	<p>Allows you to define how to use the battery charge, when AC is plugged in. The options are:</p> <ul style="list-style-type: none"> • Adaptive (Enabled) • Standard Charge • Express Charge

Option	Description
	<ul style="list-style-type: none"> Primary AC Use Custom Charge — you can set the percentage to which the battery must charge.
Intel Smart Connect Technology	<p>The option is disabled by default. If option enables will periodically sense nearby wireless connection while the system is asleep. It will synchronize emails or social media application that were open when system entered the sleep state.</p> <ul style="list-style-type: none"> Smart Connection (Disabled)

Table 9. POST Behavior

Option	Description
Adapter Warnings	<p>Allows you to activate the adapter warning messages when certain power adapters are used. The option is enabled by default.</p> <ul style="list-style-type: none"> Enable Adapter Warnings
Keypad (Embedded)	<p>Allows you to enable the keypad to embed in the internal keyboard..</p> <ul style="list-style-type: none"> Fn Key Only By Numlock <p> NOTE: When setup is running, this option has no effect, Setup works in the "Fn Key Only" mode.</p>
Mouse/Touchpad	<p>Allows you to define how the computer handles the mouse and touchpad input. The options are:</p> <ul style="list-style-type: none"> Serial Mouse PS2 Mouse Touchpad/PS-2 Mouse (Default Setting)
Numlock Enable	<p>Specifies if the NumLock function can be enabled when the computer boots. This option is enabled by default.</p> <ul style="list-style-type: none"> Enable Numlock
Fn Key Emulation	<p>Allows you to match the <Scroll Lock> key feature of PS-2 keyboard with the <Fn> key feature in an internal keyboard. The option is enabled by default.</p> <ul style="list-style-type: none"> Enable Fn Key Emulation
Fn Lock Option	<p>Allows you to hot keys combination toggle the primary behavior. The option are:</p> <ul style="list-style-type: none"> Fn Lock Lock Mode Disable/Standard Lock Mode Enable/Secondary
MEBx Hotkey	<p>Allows you to specify whether the MEBx Hotkey function should be enabled when the system boots. The option is enabled by default.</p>
Fastboot	<p>Allows you to speed up the boot process by by-passing some compatibility steps.</p> <ul style="list-style-type: none"> Minimal

Option	Description
	<ul style="list-style-type: none"> • Thorough • Auto
Extended BIOS POST Time	<p>Allows to creates an additional pre-boot delay and allows the user to see POST status message.</p> <ul style="list-style-type: none"> • 0 seconds • 5 seconds • 10 seconds

Table 10. Virtualization Support

Option	Description
Virtualization	<p>Allows you to enable or disable the Intel Virtualization Technology. Default Setting: Enable Intel Virtualization Technology</p>
VT for Direct I/O	<p>Enables or disables the Virtual Machine Monitor (VMM) from utilizing the additional hardware capabilities provided by Intel® Virtualization technology for direct I/O. Enable VT for Direct I/O — This option is enabled by default.</p>
Trusted Execution	<p>This option specifies whether a Measured Virtual Machine Monitor (MVMM) can utilize the additional hardware capabilities provided by Intel Trusted Execution Technology. The TPM virtualization Technology, and Virtualization technology for direct I/O must be enabled to use this feature. Trusted Execution — disabled by default.</p>

Table 11. Wireless

Option	Description
Wireless Switch	<p>Allows you to determine which wireless device can be controlled by the wireless switch. The options are:</p> <ul style="list-style-type: none"> • WWAN • WLAN/WiGi • Bluetooth • GPS (on WWAN module) <p>All options are enabled by default.</p>
Wireless Device Enable	<p>Allows you to enable or disable the wireless devices. The options are:</p> <ul style="list-style-type: none"> • WWAN/GPS • Bluetooth • WLAN/WiGig <p>All options are enabled by default.</p>

Table 12. Maintenance



Option	Description
Service Tag	Displays the service tag of your computer.
Asset Tag	Allows you to create a system asset tag if an asset tag is not already set. This option is not set by default.

Table 13. System Logs

Option	Description
BIOS events	Displays the system event log and allows you to clear the log. <ul style="list-style-type: none">• Clear Log
Thermal Events	Displays the thermal event log and allows you to clear the log. <ul style="list-style-type: none">• Clear Log
Power Events	Displays the power event log and allows you to clear the log. <ul style="list-style-type: none">• Clear Log

Updating the BIOS

It is recommended to update your BIOS (system setup), on replacing the system board or if an update is available. For laptops, ensure that your computer battery is fully charged and connected to a power outlet

1. Re-start the computer.
2. Go to dell.com/support.
3. Enter the **Service Tag** or **Express Service Code** and click **Submit**.
 -  **NOTE:** To locate the Service Tag, click **Where is my Service Tag?**
 -  **NOTE:** If you cannot find your Service Tag, click **Detect My Product**. Proceed with the instructions on screen.
4. If you are unable to locate or find the Service Tag, click the Product Category of your computer.
5. Choose the **Product Type** from the list.
6. Select your computer model and the **Product Support** page of your computer appears.
7. Click **Get drivers** and click **View All Drivers**.

The Drivers and Downloads page opens.
8. On the Drivers and Downloads screen, under the **Operating System** drop-down list, select **BIOS**.
9. Identify the latest BIOS file and click **Download File**.

You can also analyze which drivers need an update. To do this for your product, click **Analyze System for Updates** and follow the instructions on the screen.
10. Select your preferred download method in the **Please select your download method below** window, click **Download File**.

The **File Download** window appears.
11. Click **Save** to save the file on your computer.
12. Click **Run** to install the updated BIOS settings on your computer.

Follow the instructions on the screen.

System and Setup Password

You can create a system password and a setup password to secure your computer.

Password Type	Description
System password	Password that you must enter to log on to your system.
Setup password	Password that you must enter to access and make changes to the BIOS settings of your computer.

 **CAUTION:** The password features provide a basic level of security for the data on your computer.

 **CAUTION:** Anyone can access the data stored on your computer if it is not locked and left unattended.

 **NOTE:** Your computer is shipped with the system and setup password feature disabled.

Assigning a System Password and Setup Password

You can assign a new **System Password** and/or **Setup Password** or change an existing **System Password** and/or **Setup Password** only when **Password Status** is **Unlocked**. If the Password Status is **Locked**, you cannot change the System Password.

 **NOTE:** If the password jumper is disabled, the existing System Password and Setup Password are deleted and you need not provide the system password to log on to the computer.

To enter a system setup, press <F2> immediately after a power-on or re-boot.

1. In the **System BIOS** or **System Setup** screen, select **System Security** and press <Enter>. The **System Security** screen appears.
2. In the **System Security** screen, verify that **Password Status** is **Unlocked**.
3. Select **System Password**, enter your system password, and press <Enter> or <Tab>. Use the following guidelines to assign the system password:
 - A password can have up to 32 characters.
 - The password can contain the numbers 0 through 9.
 - Only lower case letters are valid, upper case letters are not allowed.
 - Only the following special characters are allowed: space, ("), (+), (.), (-), (,), (/), (:), (|), (\), (|), (').

Re-enter the system password when prompted.

4. Type the system password that you entered earlier and click **OK**.
5. Select **Setup Password**, type your system password and press <Enter> or <Tab>. A message prompts you to re-type the setup password.
6. Type the setup password that you entered earlier and click **OK**.
7. Press <Esc> and a message prompts you to save the changes.
8. Press <Y> to save the changes. The computer reboots.

Deleting or Changing an Existing System and/or Setup Password

Ensure that the **Password Status** is Unlocked (in the System Setup) before attempting to delete or change the existing System and/or Setup password. You cannot delete or change an existing System or Setup password, if the **Password Status** is Locked.

To enter the System Setup, press <F2> immediately after a power-on or reboot.

1. In the **System BIOS** or **System Setup** screen, select **System Security** and press <Enter>. The **System Security** screen is displayed.
2. In the **System Security** screen, verify that **Password Status** is **Unlocked**.
3. Select **System Password**, alter or delete the existing system password and press <Enter> or <Tab>.
4. Select **Setup Password**, alter or delete the existing setup password and press <Enter> or <Tab>.



NOTE: If you change the System and/or Setup password, re-enter the new password when promoted. If you delete the System and/or Setup password, confirm the deletion when promoted.

5. Press <Esc> and a message prompts you to save the changes.
6. Press <Y> to save the changes and exit from the System Setup. The computer reboots.

Diagnostics

If you experience a problem with your computer, run the ePSA diagnostics before contacting Dell for technical assistance. The purpose of running diagnostics is to test your computer's hardware without requiring additional equipment or risking data loss. If you are unable to fix the problem yourself, service and support personnel can use the diagnostics results to help you solve the problem.

Enhanced Pre-Boot System Assessment (ePSA) Diagnostics

The ePSA diagnostics (also known as system diagnostics) performs a complete check of your hardware. The ePSA is embedded with the BIOS and is launched by the BIOS internally. The embedded system diagnostics provides a set of options for particular devices or device groups allowing you to:

- Run tests automatically or in an interactive mode
- Repeat tests
- Display or save test results
- Run thorough tests to introduce additional test options to provide extra information about the failed device(s)
- View status messages that inform you if tests are completed successfully
- View error messages that inform you of problems encountered during testing





 **CAUTION: Use the system diagnostics to test only your computer. Using this program with other computers may cause invalid results or error messages.**

 **NOTE:** Some tests for specific devices require user interaction. Always ensure that you are present at the computer terminal when the diagnostic tests are performed.

1. Power-on the computer.
2. As the computer boots, press the <F12> key as the Dell logo appears.
3. On the boot menu screen, select the **Diagnostics** option.
The **Enhanced Pre-boot System Assessment** window is displayed, listing all devices detected in the computer. The diagnostics starts running the tests on all the detected devices.
4. If you wish to run a diagnostic test on a specific device, press <Esc> and click **Yes** to stop the diagnostic test.
5. Select the device from the left pane and click **Run Tests**.
6. If there are any issues, error codes are displayed.
Note the error code and contact Dell.

Device Status Lights

Table 14. Device Status Lights

	Turns on when you turn on the computer and blinks when the computer is in a power management mode.
	Turns on when the computer reads or writes data.
	Turns on steadily or blinks to indicate battery charge status.
	Turns on when wireless networking is enabled.

The device status LEDs are usually located either on the top or left side of the keyboard. They display the storage, battery and wireless devices connectivity and activity. Apart from that they can be useful as a diagnostic tool when there's a possible failure to the system.

The following table lists how to read the LED codes when possible errors occur.

Table 15. LED Lights

Storage LED	Power LED	Wireless LED	Fault Description
Blinking	Solid	Solid	A possible processor failure has occurred.
Solid	Blinking	Solid	The memory modules are detected but encountered an error.
Blinking	Blinking	Blinking	A system board failure has occurred.
Blinking	Blinking	Solid	A possible graphics card/video failure has occurred.
Blinking	Blinking	Off	System failed on hard drive initialization OR System failed in Option ROM initialization.
Blinking	Off	Blinking	The USB controller encountered a problem during initialization.
Solid	Blinking	Blinking	No memory modules are installed/detected.
Blinking	Solid	Blinking	The display encountered a problem during initialization.
Off	Blinking	Blinking	The modem is preventing the system from completing POST
Off	Blinking	Off	Memory failed to initialize or memory is unsupported.

Battery Status Lights

If the computer is connected to an electrical outlet, the battery light operates as follows:

Alternately blinking amber light and white light	An unauthenticated or unsupported non-Dell AC adapter is attached to your laptop.
Alternately blinking amber light with steady white light	Temporary battery failure with AC adapter present.
Constantly blinking amber light	Fatal battery failure with AC adapter present.
Light off	Battery in full charge mode with AC adapter present.
White light on	Battery in charge mode with AC adapter present.

Specifications

 **NOTE:** Offerings may vary by region. The following specifications are only those required by law to ship with your computer. For more information about the configuration of your computer, go to **Help and Support** in your Windows operating system and select the option to view information about your computer.

Table 16. System Information

Feature	Specification
Chipset	Wildcat Point LP
DRAM bus width	64-bit
Flash EPROM	SPI 32 Mbits, 64 Mbits
PCIe bus	100 MHz
External Bus Frequency	DMI (5GT/s)

Table 17. Processor

Feature	Specification
Types	Intel Core i3 / i5 / i7
L3 cache	3 MB, 4MB, 6 MB, and 8 MB

Table 18. Memory

Feature	Specification
Memory connector	Two SODIMM slots
Memory capacity	2GB, 4GB, or 8GB
Memory type	DDR3L SDRAM (1600 MHz)
Minimum memory	2 GB
Maximum memory	16 GB

Table 19. Audio

Feature	Specification
Type	Four-channel high-definition audio
Controller:	
Latitude E7450	Realtek ALC3235
Stereo conversion	24-bit (analog-to-digital and digital-to-analog)

Feature	Specification
Interface:	
Internal	High-definition audio
External	Microphone-in, stereo headphones, and headset combo connector
Speakers	Two
Internal speaker amplifier	2 W (RMS) per channel
Volume controls	Hot keys

Table 20. Video

Feature	Specification
Type	Integrated on system board
Controller:	
UMA	Intel HD Graphics 5500
Discrete	Nvidia GeForce 840M Graphics
Data bus	PCI-E Gen2 x4
External display support	<ul style="list-style-type: none"> • one HDMI • one mDP
	 NOTE: Support one VGA, two DP/DVI ports through Docking station.

Table 21. Camera

Features	Specification
Camera Resolution:	
HD camera resolution	1280 x 720 pixels (Non-Touch)
FHD camera resolution	1920 x 1080 pixels (Touch)
Video Resolution (maximum)	1280 x 720 pixels
Diagonal viewing angle	74 °

Table 22. Communications

Features	Specification
Network adapter	10/100/1000 Mb/s Ethernet (RJ-45)
Wireless	Internal wireless local area network (WLAN) and wireless wide area network (WWAN) <ul style="list-style-type: none"> • Bluetooth 4.0

Table 23. Ports and Connectors

Features	Specification
Audio	One microphone/stereo headphone/speakers connector
Video	<ul style="list-style-type: none"> • one HDMI • one mDP
Network adapter	RJ-45 connector
USB 3.0	One USB 3.0, one PowerShare
Memory-card reader	Supports upto SD4.0
Micro Subscriber Identity Module (uSIM) card	One
Docking port	One

Table 24. Display

Feature	Specification		
	HD	FHD	FHD W/Touch
Type			
Dimensions:			
Height	205.6 mm (8.09 inches)	205.6 mm (8.09 inches)	215.0 mm (8.46 inches)
Width	320.9 mm (12.6 inches)	320.9 mm (12.6 inches)	328.8 mm (12.9 inches)
Diagonal	3.0 mm (0.1 inch)	3.2 mm (0.1 inch)	4.15 mm (0.16 inch)
Maximum resolution	1366 x 768	1920 x 1080	1920 x 1080
Refresh rate	60 Hz/48 Hz	60 Hz/48 Hz	60 Hz/48 Hz
Minimum Viewing Angles:			
Horizontal	+/-40°	+/-80°	+/-80°
Vertical	+10°/-30°	+/-80°	+/-80°
Pixel pitch	0.2265 x 0.2265	0.161 x 0.161	0.161 x 0.161

Table 25. Keyboard

Feature	Specification
Number of keys	United States: 82 keys, United Kingdom: 83 keys, Brazil: 84 keys, and Japan: 86keys

Table 26. Touchpad

Feature	Specification
Active Area:	
X-axis	99.5 mm
Y-axis	53.0 mm

Table 27. Battery

Feature	Specification
Type	<ul style="list-style-type: none"> • 3-cell Lithium Polymer battery with ExpressCharge • 4-cell Lithium Polymer battery with ExpressCharge
Dimensions:	Latitude E7450
3-cell/4-cell	
Depth	74.75 mm (2.94 inches)
Height	8.00 mm (0.31 inch)
Width	308.50 mm (12.15 inches)
Weight:	
3-cell	247.00 g (0.54 lb)
4-cell	308.00 g (0.68 lb)
Life span	300 discharge/charge cycles
Temperature range:	
Operating	Charge: 0 °C to 50 °C (32 °F to 158 °F) Discharge: 0 °C to 70 °C (32 °F to 122 °F)
Non-Operating	-20 °C to 65 °C (4 °F to 149 °F)
Coin-cell battery	3 V CR2032 lithium coin cell

Table 28. AC Adapter

Feature	Specification
Type	65 W and 90 W
Input voltage	90 VAC to 264 VAC
Input current (maximum)	1.50 A
Input frequency	47 Hz to 63 Hz
Output power	65 W and 90 W
Output current	3.34 A and 4.62 A
Rated output voltage	19.5 VDC

Feature	Specification
Weight	230 g (65 W) and 285 g (90 W)
Dimensions	107*46*29.5 mm (65W) / 130*66 * 22 mm (90W)
Temperature range:	
Operating	0 °C to 40 °C (32 °F to 104 °F)
Non-Operating	-40 °C to 70 °C (-40 °F to 158 °F)

Table 29. Physical

Feature	Latitude E7450 Non-Touch	Latitude E7450 Touch
Front Height	18.8 mm (0.74 inch)	18.8 mm (0.74 inch)
Back Height	20.4 mm (0.8 inch)	22.6 mm (0.88 inch)
Width	337 mm (13.2 inches)	
Depth	231.5 mm (9.1 inches)	
Weight (with 3-cell battery)	1.55 kg (3.42lb)	1.71 kg (3.77lb)
Light Weight Configurable Items:		
Weight Bound	1.61 kg (3.56lb)	1.80 kg (3.97lb)
Weight Target	1.60 kg (3.54lb)	1.74 kg (3.84lb)

Table 30. Environmental

Feature	Specification
Temperature:	
Operating	0 °C to 60 °C (32 °F to 140 °F)
Storage	-51 °C to 71 °C (-59 °F to 159 °F)
Relative humidity (maximum):	
Operating	10 % to 90 % (non condensing)
Storage	5 % to 95 % (non condensing)
Altitude (maximum):	
Operating	-15.2 m to 3048 m (-50 to 10,000 ft) 0° to 35°C
Non-Operating	-15.24 m to 10,668 m (-50 ft to 35,000 ft)
Airborne contaminant level	G2 or lower as defined by ISA S71.04-1985

Contacting Dell

 **NOTE:** If you do not have an active Internet connection, you can find the contact information on your purchase invoice, packing slip, bill, or Dell product catalog.

Dell provides several online and telephone-based support and service options. Availability varies by country and product, and some services may not be available in your area. To contact Dell for sales, technical support, or customer service issues:

Go to **dell.com/contactdell**.