

Inspiron 3847

Owner's Manual

Computer model: Inspiron 3847
Regulatory model: D16M
Regulatory type: D16M001



Notes, Cautions, and Warnings



NOTE: A NOTE indicates important information that helps you make better use of your computer.



CAUTION: A CAUTION indicates potential damage to hardware or loss of data if instructions are not followed.



WARNING: A WARNING indicates a potential for property damage, personal injury, or death.

© 2013 Dell Inc.

Trademarks used in this text: Dell™, the DELL logo, and Inspiron™ are trademarks of Dell Inc.

Contents



Before You Begin	7
Safety Instructions.	7
Recommended Tools.	8
After Working Inside Your Computer	9
Technical Overview	10
Inside View of Your Computer.	10
System-Board Components	11
Removing the Computer Cover	12
Procedure	12
Replacing the Computer Cover	13
Procedure	13
Postrequisites.	13
Removing the Memory Module(s)	14
Prerequisites.	14
Procedure	14
Replacing the Memory Module(s)	15
Procedure	15
Postrequisites.	15
Removing the Graphics Card	16
Prerequisites.	16
Procedure	16
Replacing the Graphics Card	18
Procedure	18
Postrequisites.	18
Removing the Front Bezel	19
Prerequisites.	19
Procedure	19

Replacing the Front Bezel	20
Procedure	20
Postrequisites.	20
Removing the Wireless Mini-Card	21
Prerequisites.	21
Procedure	21
Replacing the Wireless Mini-Card	22
Procedure	22
Postrequisites.	22
Removing the Primary Hard-Drive	23
Prerequisites.	23
Procedure	23
Replacing the Primary Hard-Drive	25
Procedure	25
Postrequisites.	25
Removing the Secondary Hard-Drive	26
Prerequisites.	26
Procedure	26
Replacing the Secondary Hard-Drive	28
Procedure	28
Postrequisites.	28
Removing the Optical Drive	29
Prerequisites.	29
Procedure	29
Replacing the Optical Drive	31
Procedure	31
Postrequisites.	31
Removing the Front I/O Panel	34
Prerequisites.	34
Procedure	34

Replacing the Front I/O Panel	36
Procedure	36
Postrequisites.	36
Removing the Power-Button Module	37
Prerequisites.	37
Procedure	37
Replacing the Power-Button Module	39
Procedure	39
Postrequisites.	39
Removing the Chassis Fan	40
Prerequisites.	40
Procedure	40
Replacing the Chassis Fan	41
Procedure	41
Postrequisites.	41
Removing the Processor Fan and Heat Sink Assembly	42
Prerequisites.	42
Procedure	43
Replacing the Processor Fan and Heat Sink Assembly	44
Procedure	44
Postrequisites.	44
Removing the Processor	45
Prerequisites.	45
Procedure	45
Replacing the Processor	46
Procedure	46
Postrequisites.	47
Removing the Coin-Cell Battery	48
Prerequisites.	48







Procedure	48
Replacing the Coin-Cell Battery	49
Procedure	49
Postrequisites.	49
Removing the Power-Supply Unit	50
Prerequisites.	50
Procedure	50
Replacing the Power-Supply Unit	51
Procedure	51
Postrequisites.	51
Removing the System Board	52
Prerequisites.	52
Procedure	53
Replacing the System Board	54
Procedure	54
Postrequisites.	54
Entering the Service Tag in the BIOS.	54
Flashing the BIOS	55

Before You Begin

-  **CAUTION:** To avoid losing data, save and close all open files and exit all open programs before you turn off your computer.
- 1 Save and close all open files and exit all open programs.
 - 2 Move your mouse pointer to the upper-right or lower-right corner of the screen to open the Charms sidebar, and then click **Settings**→**Power**→**Shut down**.
 **NOTE:** If you are using a different operating system, see the documentation of your operating system for shut-down instructions.
 - 3 Disconnect your computer and all attached devices from their electrical outlets.
 - 4 Disconnect all telephone cables, network cables, and attached devices from your computer.
 - 5 After the computer is unplugged, press and hold the power button for 5 seconds to ground the system board.

Safety Instructions

Use the following safety guidelines to protect your computer from potential damage and ensure your personal safety.

-  **WARNING:** Before working inside your computer, read the safety information that shipped with your computer. For more safety best practices, see the Regulatory Compliance home page at dell.com/regulatory_compliance.
-  **WARNING:** Disconnect all power sources before opening the computer cover or panels. After you finish working inside the computer, replace all covers, panels, and screws before connecting to the power source.
-  **CAUTION:** To avoid damaging the computer, make sure that the work surface is flat and clean.
-  **CAUTION:** To avoid damaging the components and cards, handle them by their edges and avoid touching pins and contacts.
-  **CAUTION:** Only a certified service technician is authorized to remove the computer cover and access any of the components inside the computer. See the safety instructions for complete information about safety precautions, working inside your computer, and protecting against electrostatic discharge.
-  **CAUTION:** Before touching anything inside your computer, ground yourself by touching an unpainted metal surface, such as the metal at the back of the computer. While you work, periodically touch an unpainted metal surface to dissipate static electricity, which could harm internal components.

△ **CAUTION:** When you disconnect a cable, pull on its connector or on its pull-tab, not on the cable itself. Some cables have connectors with locking tabs or thumb-screws that you must disengage before disconnecting the cable. When disconnecting cables, keep them evenly aligned to avoid bending any connector pins. When connecting cables, make sure that the connectors and ports are correctly oriented and aligned.

△ **CAUTION:** To disconnect a network cable, first unplug the cable from your computer and then unplug the cable from the network device.

△ **CAUTION:** Press and eject any installed card from the media-card reader.

Recommended Tools

The procedures in this document may require the following tools:

- Phillips screwdriver
- Plastic scribe

After Working Inside Your Computer



CAUTION: Leaving stray or loose screws inside your computer may severely damage your computer.

- 1 Replace all screws and make sure that no stray screws remain inside your computer.
- 2 Place the computer in an upright position.
- 3 Connect any external devices, cables, cards, and any other part(s) you removed before working on your computer.
- 4 Connect your computer and all attached devices to their electrical outlets.

Technical Overview



WARNING: Before working inside your computer, read the safety information that shipped with your computer and follow the steps in "Before You Begin" on page 7. After working inside your computer, follow the instructions in "After Working Inside Your Computer" on page 9. For additional safety best practices information, see the Regulatory Compliance Homepage at dell.com/regulatory_compliance.

Inside View of Your Computer

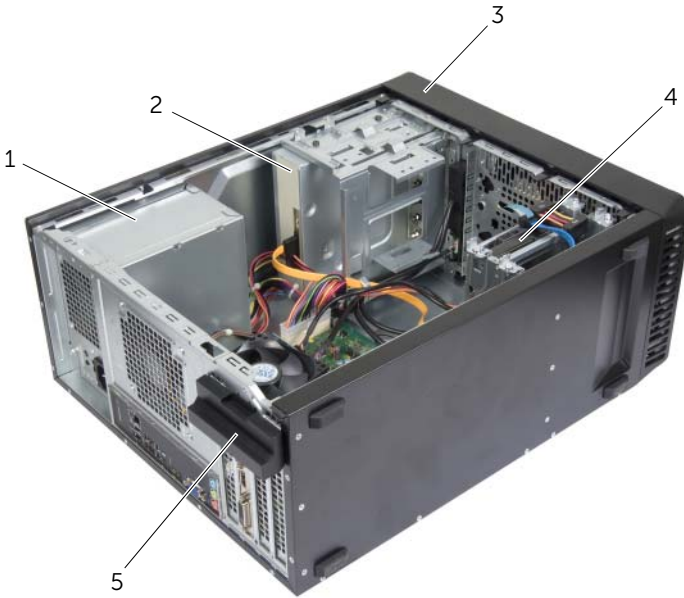

1	power supply	2	optical drive
3	front bezel	4	primary hard-drive
5	card retention bracket		

System-Board Components

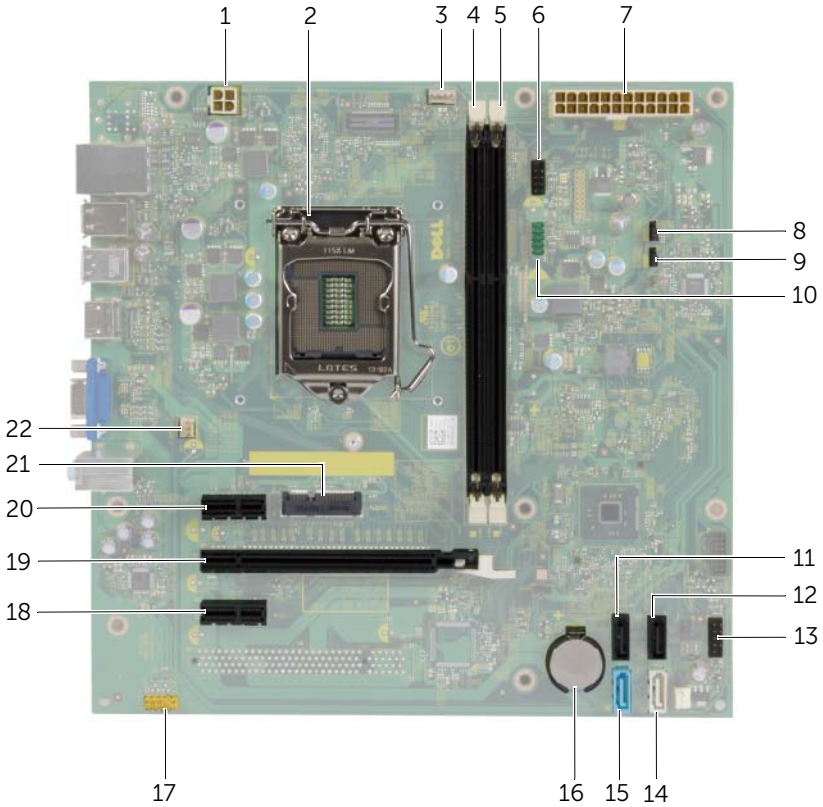

1	power connector (ATX12V)	2	processor socket
3	processor fan connector (FNCP1)	4	memory module connector (DIMM1)
5	memory module connector (DIMM2)	6	front panel USB connector (USBF1)
7	main power connector (ATX1)	8	CMOS reset jumper (CMCLR1)
9	password reset jumper (PWCLR1)	10	front panel USB connector (USBF3)
11	SATA connector (SATA 3)	12	SATA connector (SATA 2)
13	power button connector (LED H1)	14	SATA connector (SATA 1)
15	SATA connector (SATA 0)	16	battery socket (BT1)
17	front panel audio connector (AUDF1)	18	PCI Express x1 card slot (SLOT3)
19	PCI Express x16 card slot (SLOT2)	20	PCI Express x1 card slot (SLOT1)
21	Mini-Card slot (MINI1)	22	chassis fan connector (FANSYS2)

Removing the Computer Cover

⚠ WARNING: Before working inside your computer, read the safety information that shipped with your computer and follow the steps in "Before You Begin" on page 7. After working inside your computer, follow the instructions in "After Working Inside Your Computer" on page 9. For additional safety best practices information, see the Regulatory Compliance Homepage at dell.com/regulatory_compliance.

Procedure

- 1 Place the computer on its side with the computer cover facing up.
- 2 Using a screwdriver, remove the screws that secure the computer cover to the chassis.
- 3 Release the computer cover by sliding it away from the front of the computer.
- 4 Lift the cover away from the computer and set it aside.



1 screw

2 computer cover

Replacing the Computer Cover



WARNING: Before working inside your computer, read the safety information that shipped with your computer and follow the steps in "Before You Begin" on page 7. After working inside your computer, follow the instructions in "After Working Inside Your Computer" on page 9. For additional safety best practices information, see the Regulatory Compliance Homepage at dell.com/regulatory_compliance.

Procedure

- 1 Connect all the cables and fold the cables out of the way.
- 2 Ensure that no tools or extra parts are left inside the computer.
- 3 Align the tabs at the bottom of the computer cover with the slots located along the edge of the chassis.
- 4 Press the computer cover down and slide it towards the front of the computer.
- 5 Replace the screws that secure the computer cover to the chassis.
- 6 Place the computer in an upright position.

Postrequisites

Follow the instructions in "After Working Inside Your Computer" on page 9.

Removing the Memory Module(s)

⚠ WARNING: Before working inside your computer, read the safety information that shipped with your computer and follow the steps in "Before You Begin" on page 7. After working inside your computer, follow the instructions in "After Working Inside Your Computer" on page 9. For more safety best practices, see the Regulatory Compliance home page at dell.com/regulatory_compliance.

Prerequisites

Remove the computer cover. See "Removing the Computer Cover" on page 12.

Procedure

- 1 Locate the memory-module connector on the system board. See "System-Board Components" on page 11.
- 2 Press out the securing clip at each end of the memory-module connector.
🔧 NOTE: If the memory module is difficult to remove, gently ease the memory module back and forth to remove it from the connector.
- 3 Grasp the memory module and pull it upward.

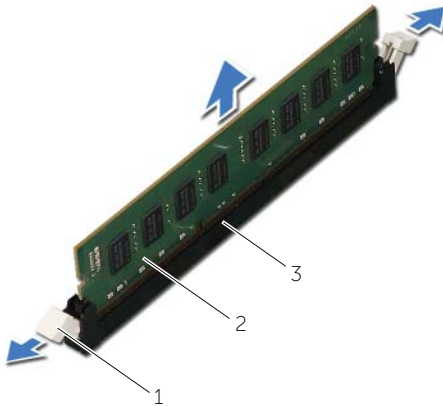

1	securing clips (2)	2	memory module
3	memory-module connector		

Replacing the Memory Module(s)

⚠ WARNING: Before working inside your computer, read the safety information that shipped with your computer and follow the steps in "Before You Begin" on page 7. After working inside your computer, follow the instructions in "After Working Inside Your Computer" on page 9. For more safety best practices, see the Regulatory Compliance home page at dell.com/regulatory_compliance.

Procedure

- 1 Press out the securing clip at each end of the memory-module connector.
- 2 Align the notch on the memory module with the tab on the memory-module connector.

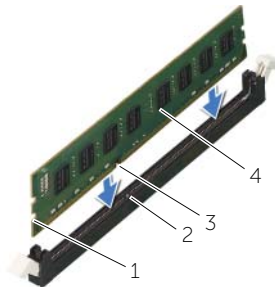

1	cutouts (2)	2	tab
3	notch	4	memory module

- 3 Insert the memory module into the memory-module connector, and press the memory module down until it snaps into position and the securing clips lock in place.

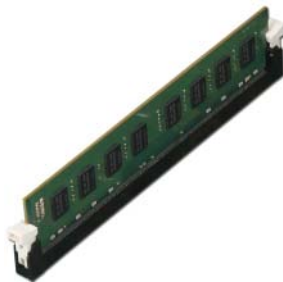

Postrequisites

Replace the computer cover. See "Replacing the Computer Cover" on page 13.

Removing the Graphics Card

⚠ WARNING: Before working inside your computer, read the safety information that shipped with your computer and follow the steps in "Before You Begin" on page 7. After working inside your computer, follow the instructions in "After Working Inside Your Computer" on page 9. For more safety best practices, see the Regulatory Compliance home page at dell.com/regulatory_compliance.

Prerequisites

Remove the computer cover. See "Removing the Computer Cover" on page 12.

Procedure

- 1 Push the release tab to release the card retention bracket from the chassis.

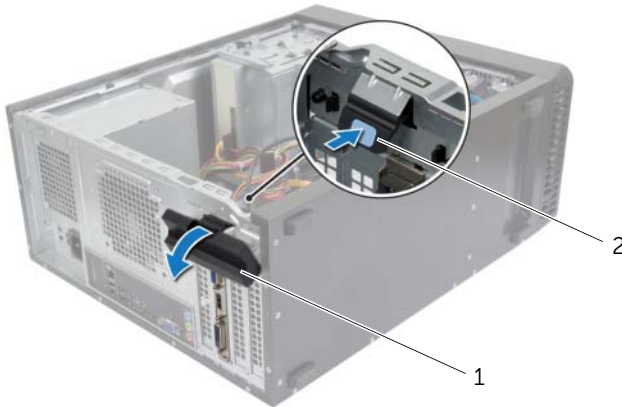

1 card retention bracket

2 release tab

- 2 Push the securing tab down to release the graphics card.
- 3 Grasp the card by its top corners, and then ease it out of the connector.



1 securing tab

2 graphics card

Replacing the Graphics Card



WARNING: Before working inside your computer, read the safety information that shipped with your computer and follow the steps in "Before You Begin" on page 7. After working inside your computer, follow the instructions in "After Working Inside Your Computer" on page 9. For more safety best practices, see the Regulatory Compliance home page at dell.com/regulatory_compliance.

Procedure

- 1 Locate the PCI-Express x16 card slot. See "System-Board Components" on page 11.
- 2 Align the graphics card with the PCI-Express x16 card slot on the system board.
- 3 Place the card in the slot and press down firmly. Ensure that the card is firmly seated in the slot.
- 4 Rotate the card retention bracket towards the computer until it snaps into place.

Postrequisites

Replace the computer cover. See "Replacing the Computer Cover" on page 13.

Removing the Front Bezel

⚠ WARNING: Before working inside your computer, read the safety information that shipped with your computer and follow the steps in "Before You Begin" on page 7. After working inside your computer, follow the instructions in "After Working Inside Your Computer" on page 9. For more safety best practices, see the Regulatory Compliance home page at dell.com/regulatory_compliance.

Prerequisites

Remove the computer cover. See "Removing the Computer Cover" on page 12.

Procedure

- 1 Place the computer in an upright position.
- 2 Grasp and release the front bezel tabs sequentially from the top, one at a time by moving them away from the front panel.
- 3 Rotate and pull the front bezel away from the front of the computer to release the front bezel clamps from the front panel slots.



1 front bezel tabs (4)

2 front bezel clamps (4)

3 front panel

4 front bezel

Replacing the Front Bezel



WARNING: Before working inside your computer, read the safety information that shipped with your computer and follow the steps in "Before You Begin" on page 7. After working inside your computer, follow the instructions in "After Working Inside Your Computer" on page 9. For more safety best practices, see the Regulatory Compliance home page at dell.com/regulatory_compliance.

Procedure

- 1 Align and insert the front bezel clamps into the front panel slots.
- 2 Rotate the front bezel towards the computer until the front bezel tabs snap into place.

Postrequisites

Replace the computer cover. See "Replacing the Computer Cover" on page 13.

Removing the Wireless Mini-Card

⚠ WARNING: Before working inside your computer, read the safety information that shipped with your computer and follow the steps in "Before You Begin" on page 7. After working inside your computer, follow the instructions in "After Working Inside Your Computer" on page 9. For additional safety best practices, see the Regulatory Compliance home page at dell.com/regulatory_compliance.

Prerequisites

Remove the computer cover. See "Removing the Computer Cover" on page 12.

Procedure

- 1 Locate the mini-card slot (MINI1) on the system board. See "System-Board Components" on page 11.
- 2 Disconnect the antenna cables from the wireless mini-card.
- 3 Remove the screw that secures the wireless mini-card to the system board.

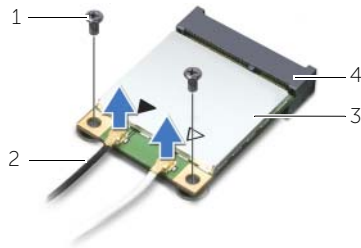

1	screw	2	antenna cables (2)
3	wireless mini-card	4	mini-card slot (MINI1)

- 4 Slide and remove the wireless mini-card from the mini-card connector.

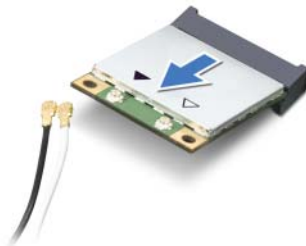

Replacing the Wireless Mini-Card

 **WARNING:** Before working inside your computer, read the safety information that shipped with your computer and follow the steps in "Before You Begin" on page 7. After working inside your computer, follow the instructions in "After Working Inside Your Computer" on page 9. For more safety best practices, see the Regulatory Compliance home page at dell.com/regulatory_compliance.

Procedure

 **CAUTION:** To avoid damage to the wireless mini-card, do not place any cables under it.

- 1 Align the notch on the wireless mini-card with the tab on the mini-card connector.
- 2 Slide the wireless mini-card at an angle into the system-board connector.
- 3 Press the other end of the wireless mini-card down and replace the screw that secures the wireless mini-card to the system board.
- 4 Connect the antenna cables to the wireless mini-card.

The following table provides the antenna-cable color scheme for the wireless mini-card supported by your computer.

Connectors on the wireless card	Antenna-cable color
Main (white triangle)	White
Auxiliary (black triangle)	Black

Postrequisites

Replace the computer cover. See "Replacing the Computer Cover" on page 13.

Removing the Primary Hard-Drive

⚠ WARNING: Before working inside your computer, read the safety information that shipped with your computer and follow the steps in "Before You Begin" on page 7. After working inside your computer, follow the instructions in "After Working Inside Your Computer" on page 9. For more safety best practices, see the Regulatory Compliance home page at dell.com/regulatory_compliance.

⚠ CAUTION: To avoid data loss, do not remove the hard drive while the computer is On or in Sleep state.

⚠ CAUTION: Hard drives are fragile. Exercise care when handling the hard drive.

Prerequisites

Remove the computer cover. See "Removing the Computer Cover" on page 12.

Procedure

- 1 Disconnect the power and data cables from the primary hard-drive.
- 2 Remove the screws that secure the primary hard-drive assembly to the chassis.
- 3 Slide the primary hard-drive assembly out of the computer.



1	power cable	2	data cable
3	primary hard-drive assembly	4	screws (2)

- 4 Remove the screws that secure the hard-drive brackets to the primary hard-drive.
- 5 Lift the primary hard-drive off the hard-drive brackets.



1 screws (2)

2 hard-drive brackets (2)

3 primary hard-drive

Replacing the Primary Hard-Drive

 **WARNING:** Before working inside your computer, read the safety information that shipped with your computer and follow the steps in "Before You Begin" on page 7. After working inside your computer, follow the instructions in "After Working Inside Your Computer" on page 9. For more safety best practices, see the Regulatory Compliance home page at dell.com/regulatory_compliance.

 **CAUTION:** Hard drives are fragile. Exercise care when handling the hard drive.

Procedure

- 1 Align the screw holes on the primary hard-drive with the screw holes on the hard-drive brackets.
- 2 Replace the screws that secure the hard-drive brackets to the primary hard-drive.
- 3 Slide the primary hard-drive assembly into the computer.
- 4 Replace the screws that secure the primary hard-drive assembly to the chassis.
- 5 Connect the power and data cables to the primary hard-drive assembly.

Postrequisites

Replace the computer cover. See "Replacing the Computer Cover" on page 13.

Removing the Secondary Hard-Drive

 **WARNING:** Before working inside your computer, read the safety information that shipped with your computer and follow the steps in "Before You Begin" on page 7. After working inside your computer, follow the instructions in "After Working Inside Your Computer" on page 9. For more safety best practices, see the Regulatory Compliance home page at dell.com/regulatory_compliance.

 **CAUTION:** To avoid data loss, do not remove the hard drive while the computer is On or in Sleep state.

 **CAUTION:** Hard drives are fragile. Exercise care when handling the hard drive.

Prerequisites

Remove the computer cover. See "Removing the Computer Cover" on page 12.

Procedure

- 1 Disconnect the power and data cables from the secondary hard-drive assembly.
- 2 Remove the screws that secure the secondary hard-drive assembly to the chassis.

- 3 Slide the secondary hard-drive assembly out of the computer.



1	power cable	2	data cable
3	secondary hard-drive assembly	4	screw

- 4 Remove the screws that secure the hard-drive brackets to the secondary hard-drive.
- 5 Lift the secondary hard-drive off the hard-drive brackets.



1	screws (2)	2	hard-drive brackets (2)
3	secondary hard-drive		

Replacing the Secondary Hard-Drive

 **WARNING:** Before working inside your computer, read the safety information that shipped with your computer and follow the steps in "Before You Begin" on page 7. After working inside your computer, follow the instructions in "After Working Inside Your Computer" on page 9. For more safety best practices, see the Regulatory Compliance home page at dell.com/regulatory_compliance.

 **CAUTION:** Hard drives are fragile. Exercise care when handling the hard drive.

Procedure

- 1 Align the screw holes on the secondary hard-drive with the screw holes on the hard-drive brackets.
- 2 Replace the screws that secure the hard-drive brackets to the secondary hard-drive.
- 3 Slide the secondary hard-drive assembly into the computer.
- 4 Replace the screws that secure the secondary hard-drive assembly to the chassis.
- 5 Connect the power and data cables to the secondary hard-drive assembly.

Postrequisites

Replace the computer cover. See "Replacing the Computer Cover" on page 13.

Removing the Optical Drive



WARNING: Before working inside your computer, read the safety information that shipped with your computer and follow the steps in "Before You Begin" on page 7. After working inside your computer, follow the instructions in "After Working Inside Your Computer" on page 9. For additional safety best practices information, see the Regulatory Compliance Homepage at dell.com/regulatory_compliance.

Prerequisites

- 1 Remove the computer cover. See "Removing the Computer Cover" on page 12.
- 2 Remove the front bezel. See "Removing the Front Bezel" on page 19.

Procedure

- 1 Disconnect the power and data cables from the optical drive.
- 2 Remove the screws that secure the optical drive to the chassis.

3 Push and slide the optical drive out through the front of the computer.

 **NOTE:** Repeat steps 1 to 3 to remove secondary optical-drive, if applicable.

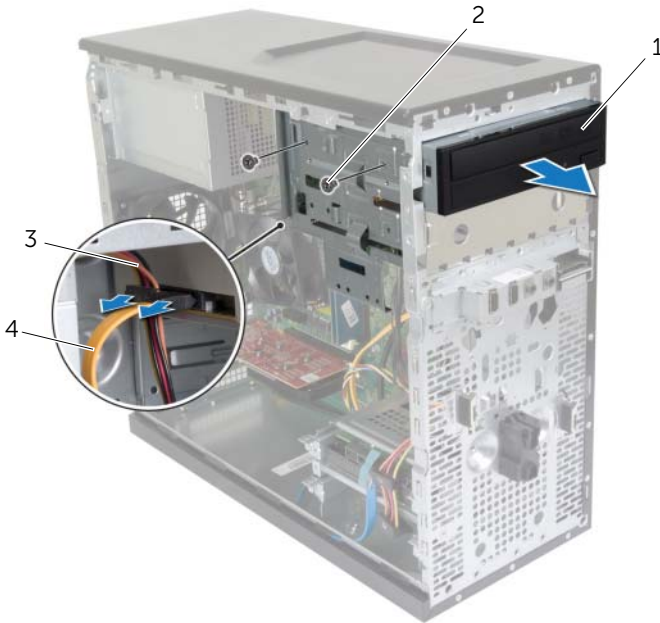

1	optical drive	2	screws (2)
3	power cable	4	data cable

4 Set aside the optical drive.

Replacing the Optical Drive

 **WARNING:** Before working inside your computer, read the safety information that shipped with your computer and follow the steps in "Before You Begin" on page 7. After working inside your computer, follow the instructions in "After Working Inside Your Computer" on page 9. For additional safety best practices information, see the Regulatory Compliance Homepage at dell.com/regulatory_compliance.

Procedure

- 1 Gently slide the optical drive into the optical-drive bay through the front of the computer.
- 2 Align the screw holes on the optical drive with the screw holes on the chassis.
- 3 Replace the screws that secure the optical drive to the chassis.
- 4 Connect the power and data cables to the optical drive.

 **NOTE:** Repeat steps 1 to 4 to replace secondary optical-drive, if applicable.

Postrequisites

- 1 Replace the front bezel. See "Replacing the Front Bezel" on page 20.
- 2 Replace the computer cover. See "Replacing the Computer Cover" on page 13.

Installing a Secondary Optical Drive (optional)

- 1 To install a secondary optical-drive, pull the break-away metal plate off the chassis.



1 metal plate

- 2 Gently slide the secondary optical-drive into the optical drive bay through the front of the computer.
- 3 Align the screw holes on the secondary optical-drive with the screw holes on the chassis.
- 4 Replace the screws that secure the secondary optical-drive to the chassis.
- 5 Connect the power and data cables to the secondary optical drive.

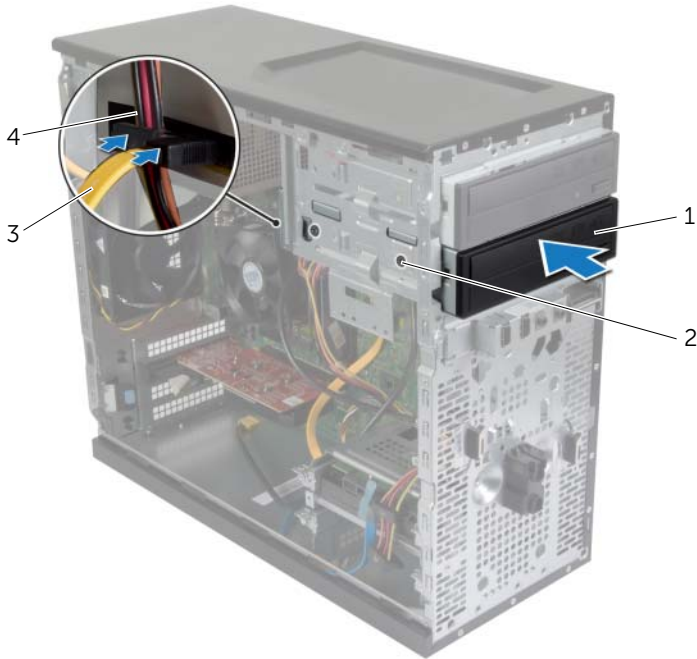

1	secondary optical drive	2	screws (2)
3	data cable	4	power cable

Removing the Front I/O Panel

 **WARNING:** Before working inside your computer, read the safety information that shipped with your computer and follow the steps in "Before You Begin" on page 7. After working inside your computer, follow the instructions in "After Working Inside Your Computer" on page 9. For additional safety best practices information, see the Regulatory Compliance Homepage at dell.com/regulatory_compliance.

Prerequisites

- 1 Remove the computer cover. See "Removing the Computer Cover" on page 12.
- 2 Remove the front bezel. See "Removing the Front Bezel" on page 19.

Procedure

 **CAUTION:** When sliding the front I/O panel out of the computer, be extremely careful. Carelessness may result in damage to the cable connectors and the cable routing clips.

 **NOTE:** Note the routing of all cables as you remove them so that you can re-route them correctly after you replace the front I/O panel.

- 1 Disconnect the front I/O panel cables from the system board connectors (AUDF1, USBF1, and USBF3). See "System-Board Components" on page 11.
- 2 Remove the screw that secures the front I/O panel to the front panel.

- 3 Slide the front I/O panel towards the side as shown in the illustration to release the clamps from the front panel and pull it away.

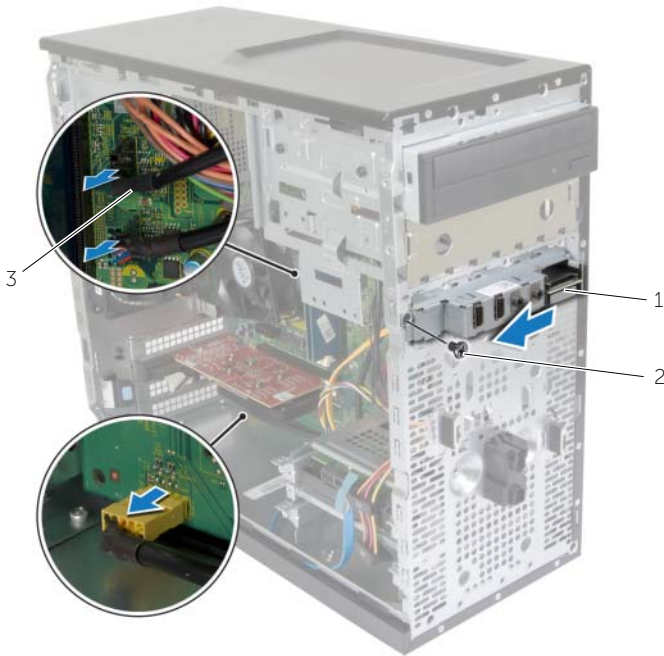

1 front I/O panel

2 screw

3 I/O panel cables (3)

Replacing the Front I/O Panel



WARNING: Before working inside your computer, read the safety information that shipped with your computer and follow the steps in "Before You Begin" on page 7. After working inside your computer, follow the instructions in "After Working Inside Your Computer" on page 9. For additional safety best practices information, see the Regulatory Compliance Homepage at dell.com/regulatory_compliance.

Procedure

- 1 Align and slide the front I/O panel clamps into the front I/O panel clamp slot.
- 2 Replace the screw that secures the front I/O panel to the front panel.
- 3 Connect the front I/O panel cables to the system board connectors (AUDF1, USBF1, and USBF3). See "System-Board Components" on page 11.

Postrequisites

- 1 Replace the front bezel. See "Replacing the Front Bezel" on page 20.
- 2 Replace the computer cover. See "Replacing the Computer Cover" on page 13.

Removing the Power-Button Module

 **WARNING:** Before working inside your computer, read the safety information that shipped with your computer and follow the steps in "Before You Begin" on page 7. After working inside your computer, follow the instructions in "After Working Inside Your Computer" on page 9. For more safety best practices, see the Regulatory Compliance home page at dell.com/regulatory_compliance.

Prerequisites

- 1 Remove the computer cover. See "Removing the Computer Cover" on page 12.
- 2 Remove the front bezel. See "Removing the Front Bezel" on page 19.

Procedure

 **NOTE:** Note the routing of the cable as you remove it so that you can re-route it correctly after you replace the power-button module.

- 1 Disconnect the power-button module cable from the system-board connector (LEDH1). See "System-Board Components" on page 11.

- 2 Press the tabs on the power-button module and pull the power-button module to release it from the front panel.



1 tabs

2 power-button module

3 power-button cable

- 3 Set aside the power-button module.

Replacing the Power-Button Module



WARNING: Before working inside your computer, read the safety information that shipped with your computer and follow the steps in "Before You Begin" on page 7. After working inside your computer, follow the instructions in "After Working Inside Your Computer" on page 9. For more safety best practices, see the Regulatory Compliance home page at dell.com/regulatory_compliance.

Procedure

- 1 Align and push the power-button module tabs into the slots on the front panel.
- 2 Connect the power-button module cable to the system board connector (LEDH1). See "System-Board Components" on page 11.
- 3 Route the power-button module cable through its routing guide.

Postrequisites

- 1 Replace the front bezel. See "Replacing the Front Bezel" on page 20.
- 2 Replace the computer cover. See "Replacing the Computer Cover" on page 13.

Removing the Chassis Fan

⚠ WARNING: Before working inside your computer, read the safety information that shipped with your computer and follow the steps in "Before You Begin" on page 7. After working inside your computer, follow the instructions in "After Working Inside Your Computer" on page 9. For more safety best practices, see the Regulatory Compliance home page at dell.com/regulatory_compliance.

Prerequisites

Remove the computer cover. See "Removing the Computer Cover" on page 12.

Procedure

- 1 Disconnect the chassis-fan cable from the system board connector (FANSYS2). See "System-Board Components" on page 11.
- 2 Remove the screws that secure the chassis fan to the chassis.
- 3 Slide and lift the chassis fan away from the computer as shown in the illustration.



1 screws (4)

2 chassis fan

3 chassis-fan cable

Replacing the Chassis Fan



WARNING: Before working inside your computer, read the safety information that shipped with your computer and follow the steps in "Before You Begin" on page 7. After working inside your computer, follow the instructions in "After Working Inside Your Computer" on page 9. For more safety best practices, see the Regulatory Compliance home page at dell.com/regulatory_compliance.



Procedure

- 1 Align the screw holes on the chassis fan with the screw holes on the chassis.
- 2 Replace the screws that secure the chassis fan to the chassis.
- 3 Connect the chassis-fan cable to the system board connector (FANSYS2). See "System-Board Components" on page 11.

Postrequisites

- 1 Replace the front bezel. See "Replacing the Front Bezel" on page 20.
- 2 Replace the computer cover. See "Replacing the Computer Cover" on page 13.

Removing the Processor Fan and Heat Sink Assembly

-  **WARNING:** Before working inside your computer, read the safety information that shipped with your computer and follow the steps in "Before You Begin" on page 7. After working inside your computer, follow the instructions in "After Working Inside Your Computer" on page 9. For more safety best practices, see the Regulatory Compliance home page at dell.com/regulatory_compliance.
-  **WARNING:** The heat sink may become hot during normal operation. Allow sufficient time for the heat sink to cool before you touch it.
-  **CAUTION:** To ensure maximum cooling for the processor, do not touch the heat transfer areas on the heat sink. The oils in your skin can reduce the heat transfer capability of the thermal grease.

Prerequisites

Remove the computer cover. See "Removing the Computer Cover" on page 12.

Procedure

- 1 Disconnect the processor-fan cable from the system board connector (FNCPU1). See "System-Board Components" on page 11.
- 2 Using a phillips screwdriver loosen the captive screws that secure the processor fan and heat-sink assembly to the system board.
- 3 Lift the processor fan and heat-sink assembly out of the computer.



1	processor fan and heat-sink assembly	2	captive screws (4)
3	processor-fan cable		

Replacing the Processor Fan and Heat Sink Assembly

 **WARNING:** Before working inside your computer, read the safety information that shipped with your computer and follow the steps in "Before You Begin" on page 7. After working inside your computer, follow the instructions in "After Working Inside Your Computer" on page 9. For more safety best practices, see the Regulatory Compliance home page at dell.com/regulatory_compliance.

 **CAUTION:** Incorrect alignment of the heat sink can cause damage to the system board and processor.

Procedure

 **NOTE:** The original thermal grease can be reused if the original processor and heat sink are reinstalled together.

 **CAUTION:** If either the processor or the heat sink is replaced, use the thermal grease provided in the kit to make sure that thermal conductivity is achieved.

- 1 Place the processor fan and heat-sink assembly over the processor.
- 2 Connect the processor-fan cable to the system board connector (FNCP1). See "System-Board Components" on page 11.
- 3 Align the captive screws on the processor fan heat-sink assembly with the screw holes on the system board.
- 4 Tighten the captive screws that secure the processor fan and heat-sink assembly to the system board.

Postrequisites

Replace the computer cover. See "Replacing the Computer Cover" on page 16.

Removing the Processor

⚠ WARNING: Before working inside your computer, read the safety information that shipped with your computer and follow the steps in "Before You Begin" on page 7. After working inside your computer, follow the instructions in "After Working Inside Your Computer" on page 9. For more safety best practices, see the Regulatory Compliance home page at dell.com/regulatory_compliance.

⚠ CAUTION: Processors are fragile. Handle the processor only by the edges and do not touch the metal pins.

Prerequisites

- 1 Remove the computer cover. See "Removing the Computer Cover" on page 12.
- 2 Remove the processor fan and heat sink. See "Removing the Processor Fan and Heat Sink Assembly" on page 42.

Procedure

- 1 Press the release-lever down and then pull it outwards to release it from the securing tab.
- 2 Extend the release-lever completely to open the processor cover.
- 3 Gently lift the processor and remove it from the processor socket.

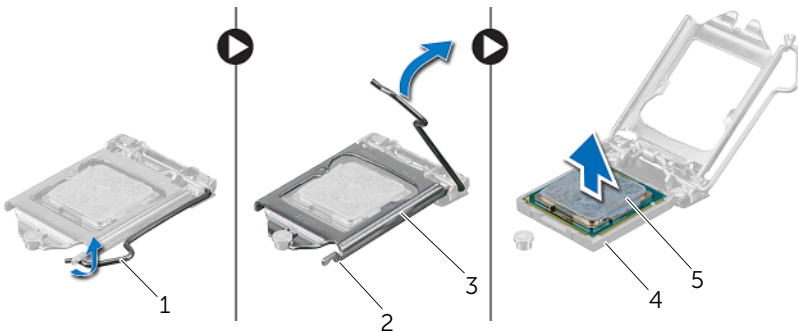

1	release lever	2	securing tab
3	processor cover	4	socket
5	processor		

Replacing the Processor

⚠ WARNING: Before working inside your computer, read the safety information that shipped with your computer and follow the steps in "Before You Begin" on page 7. After working inside your computer, follow the instructions in "After Working Inside Your Computer" on page 9. For more safety best practices, see the Regulatory Compliance home page at dell.com/regulatory_compliance.

Procedure

✎ NOTE: A new processor ships with a thermal pad in the package. In some cases, the processor may ship with the thermal pad attached to it.

- 1 Ensure that the release lever on the processor socket is fully extended in the open position.
- 2 Align the pin-1 corner on the processor with the pin-1 corner on the processor socket, and then place the processor in the processor socket.

✎ NOTE: The pin-1 corner of the processor has a triangle that aligns with the triangle on the pin-1 corner on the processor socket. When the processor is properly seated, all four corners are aligned at the same height. If one or more corners of the processor are higher than the others, the processor is not seated properly.

- 3 When the processor is fully seated in the socket, close the processor cover.
- 4 Pivot the release-lever down and place it under the tab on the processor cover.

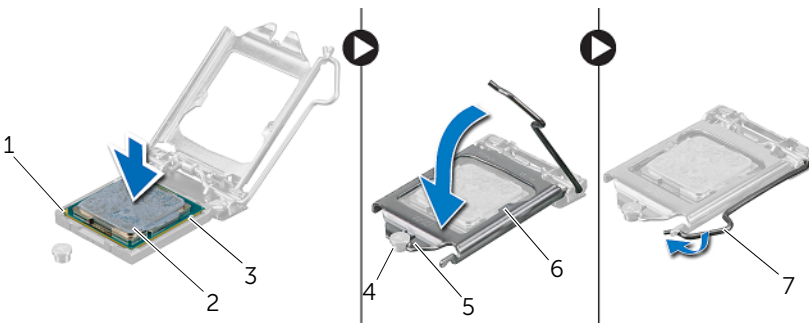

1	processor pin-1 indicator	2	processor
3	alignment tabs (2)	4	alignment post
5	processor-cover notch	6	processor cover
7	release lever		

Postrequisites

- 1 Replace the processor fan and heat sink. See "Replacing the Processor Fan and Heat Sink Assembly" on page 44.
- 2 Replace the computer cover. See "Replacing the Computer Cover" on page 16.

Removing the Coin-Cell Battery

⚠ WARNING: Before working inside your computer, read the safety information that shipped with your computer and follow the steps in "Before You Begin" on page 7. After working inside your computer, follow the instructions in "After Working Inside Your Computer" on page 9. For more safety best practices, see the Regulatory Compliance home page at dell.com/regulatory_compliance.

⚠ CAUTION: Removing the coin-cell battery resets the BIOS settings to default. It is recommended that you note the BIOS settings before removing the coin-cell battery.

Prerequisites

Remove the computer cover. See "Removing the Computer Cover" on page 12.

Procedure

- 1 Locate the battery socket (BT1). See "System-Board Components" on page 11.
- 2 Press the battery-release lever away from the coin-cell battery until the coin-cell battery pops up.

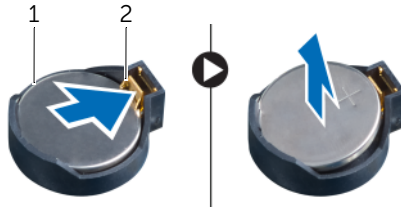



1 coin-cell battery

2 securing clip

- 3 Lift the coin-cell battery out of its socket.

Replacing the Coin-Cell Battery

 **WARNING:** Before working inside your computer, read the safety information that shipped with your computer and follow the steps in "Before You Begin" on page 7. After working inside your computer, follow the instructions in "After Working Inside Your Computer" on page 9. For more safety best practices, see the Regulatory Compliance home page at dell.com/regulatory_compliance.

 **WARNING:** The battery may explode if installed incorrectly. Replace the battery only with the same or equivalent type. Discard used batteries according to the manufacturer's instructions.

Procedure

Insert a new coin-cell battery (CR2032) into the battery socket with the positive side facing up, and press the battery into place.

Postrequisites

Replace the computer cover. See "Replacing the Computer Cover" on page 13.

Removing the Power-Supply Unit

⚠ WARNING: Before working inside your computer, read the safety information that shipped with your computer and follow the steps in "Before You Begin" on page 7. After working inside your computer, follow the instructions in "After Working Inside Your Computer" on page 9. For additional safety best practices information, see the Regulatory Compliance Homepage at dell.com/regulatory_compliance.

Prerequisites

Remove the computer cover. See "Removing the Computer Cover" on page 12.

Procedure

- 1 Disconnect the DC power cables from the system board (ATX1), hard drive, and optical drive. See "System-Board Components" on page 11.
- 2 Remove the screws that secure the power-supply unit to the chassis.
- 3 Press the power-supply clamp to release the power-supply unit from the chassis.
- 4 Slide and lift the power-supply unit away from the chassis



1 screws (4)

2 power-supply unit

3 power-supply clamp

Replacing the Power-Supply Unit



WARNING: Before working inside your computer, read the safety information that shipped with your computer and follow the steps in "Before You Begin" on page 7. After working inside your computer, follow the instructions in "After Working Inside Your Computer" on page 9. For additional safety best practices information, see the Regulatory Compliance Homepage at dell.com/regulatory_compliance.

Procedure

- 1 Slide the power supply towards the back of the chassis.
- 2 Align the screw holes on the power-supply unit with the screw holes on the chassis.
- 3 Replace the screws that secure the power-supply unit to the chassis.
- 4 Connect the DC power cables to the system board and the drives. See "System-Board Components" on page 11.

Postrequisites

Replace the computer cover. See "Replacing the Computer Cover" on page 13.

Removing the System Board

 **WARNING:** Before working inside your computer, read the safety information that shipped with your computer and follow the steps in "Before You Begin" on page 7. After working inside your computer, follow the instructions in "After Working Inside Your Computer" on page 9. For more safety best practices, see the Regulatory Compliance home page at dell.com/regulatory_compliance.

 **NOTE:** Your computer's Service Tag is stored in the system board. You must enter the Service Tag in the BIOS after you replace the system board.

 **NOTE:** Before disconnecting the cables from the system board, note the location of the connectors so that you can reconnect them correctly after you replace the system board.

Prerequisites

- 1 Remove the computer cover. See "Removing the Computer Cover" on page 12.
- 2 Remove the wireless mini-card. See "Removing the Wireless Mini-Card" on page 21.
- 3 Remove the coin-cell battery. See "Removing the Coin-Cell Battery" on page 48.
- 4 Remove the graphics card. See "Removing the Graphics Card" on page 16.
- 5 Remove the processor fan and heat sink. See "Removing the Processor Fan and Heat Sink Assembly" on page 42.
- 6 Remove the processor. See "Removing the Processor" on page 45.
- 7 Remove the memory modules. See "Removing the Memory Module(s)" on page 14.
- 8 Disconnect all cables connected to the system board. See "System-Board Components" on page 11.

Procedure

- 1 Make note of the cable routing and remove the cables from the routing guides.
- 2 Remove the screws that secure the system board to the chassis.
- 3 Lift the system board out of the chassis.

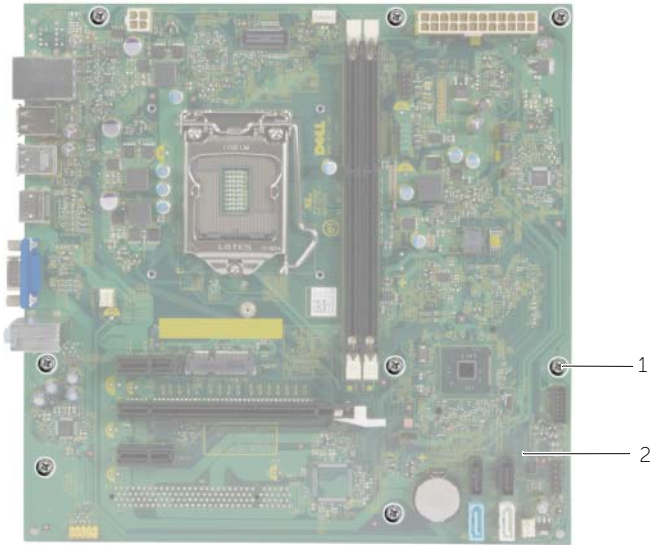

1 screws (8)

2 system board

Replacing the System Board

 **WARNING:** Before working inside your computer, read the safety information that shipped with your computer and follow the steps in "Before You Begin" on page 7. After working inside your computer, follow the instructions in "After Working Inside Your Computer" on page 9. For more safety best practices, see the Regulatory Compliance home page at dell.com/regulatory_compliance.

 **NOTE:** Your computer's Service Tag is stored in the system board. You must enter the Service Tag in the system setup after you replace the system board.

Procedure

- 1 Gently place the system board into the chassis and slide it towards the back of the computer.
- 2 Replace the screws that secure the system board to the chassis.

Postrequisites

- 1 Route and connect the cables that you disconnected from the system board. See "System-Board Components" on page 11.
- 2 Replace the memory modules. See "Replacing the Memory Module(s)" on page 15.
- 3 Replace the processor. "Replacing the Processor" on page 46.
- 4 Replace the processor fan and heat sink. See "Replacing the Processor Fan and Heat Sink Assembly" on page 44.
- 5 Replace the graphics card. See "Replacing the Graphics Card" on page 18.
- 6 Replace the coin-cell battery. See "Replacing the Coin-Cell Battery" on page 49.
- 7 Replace the wireless mini-card. See "Replacing the Wireless Mini-Card" on page 22.
- 8 Replace the computer cover. See "Replacing the Computer Cover" on page 13.

Entering the Service Tag in the BIOS

- 1 Turn on the computer.
- 2 Press <F2> when the DELL logo is displayed to enter System Setup.
- 3 Navigate to the main tab and enter the Service Tag in the **Service Tag Input** field.

Flashing the BIOS

You may need to flash (update) the BIOS when an update is available or when you replace the system board. To flash the BIOS:

- 1 Turn on the computer.
- 2 Go to **dell.com/support**.
- 3 If you have your computer's Service Tag, type your computer's Service Tag and click **Submit**.

If you do not have your computer's Service Tag, click **Detect Service Tag** to allow automatic detection of the Service Tag.



NOTE: If the Service Tag cannot be detected automatically, select your product under the product categories.

- 4 Click **Drivers and Downloads**.
- 5 In the **Operating System** drop-down, select the operating system installed on your computer.
- 6 Click **BIOS**.
- 7 Click **Download File** to download the latest version of the BIOS for your computer.
- 8 On the next page, select **Single-file download** and click **Continue**.
- 9 Save the file and once the download is complete, navigate to the folder where you saved the BIOS update file.
- 10 Double-click the BIOS update file icon and follow the instructions on the screen.