

PRIMERGY RX300 S7 Server

Operating manual

Comments... Suggestions... Corrections...

The User Documentation Department would like to know your opinion of this manual. Your feedback helps us optimize our documentation to suit your individual needs.

Feel free to send us your comments by e-mail to manuals@ts.fujitsu.com.

Certified documentation according to DIN EN ISO 9001:2008

To ensure a consistently high quality standard and user-friendliness, this documentation was created to meet the regulations of a quality management system which complies with the requirements of the standard DIN EN ISO 9001:2008.

cognitas. Gesellschaft für Technik-Dokumentation mbH
www.cognitas.de

Copyright and Trademarks

Copyright © 2012 Fujitsu Technology Solutions GmbH.

All rights reserved.

Delivery subject to availability; right of technical modifications reserved.

All hardware and software names used are trademarks of their respective manufacturers.

- The contents of this manual may be revised without prior notice.
- Fujitsu assumes no liability for damages to third party copyrights or other rights arising from the use of any information in this manual.
- No part of this manual may be reproduced in any without the prior written permission of Fujitsu.

Microsoft, Windows, Windows Server, and Hyper V are trademarks or registered trademarks of Microsoft Corporation in the USA and other countries.

Intel and Xeon are trademarks or registered trademarks of Intel Corporation or its subsidiaries in the USA and other countries.

Before reading this manual

For your safety

This manual contains important information for safely and correctly using this product.

Carefully read the manual before using this product. Pay particular attention to the accompanying manual "Safety Notes and Regulations" and ensure these safety notes are understood before using the product. Keep this manual and the manual "Safety Notes and Regulations" in a safe place for easy reference while using this product.

Radio interference

This product is a "Class A" ITE (Information Technology Equipment). In a domestic environment this product may cause radio interference, in which case the user may be required to take appropriate measures. VCCI-A

Aluminum electrolytic capacitors

The aluminum electrolytic capacitors used in the product's printed circuit board assemblies and in the mouse and keyboard are limited-life components. Use of these components beyond their operating life may result in electrolyte leakage or depletion, potentially causing emission of foul odor or smoke.

As a guideline, in a normal office environment (25°C) operating life is not expected to be reached within the maintenance support period (5 years). However, operating life may be reached more quickly if, for example, the product is used in a hot environment. The customer shall bear the cost of replacing replaceable components which have exceeded their operating life. Note that these are only guidelines, and do not constitute a guarantee of trouble-free operation during the maintenance support period.

High safety use

This product has been designed and manufactured to be used in commercial and/or industrial areas as a server.

When used as visual display workplace, it must not be placed in the direct field of view to avoid incommoding reflections (applies only to TX server systems).

The device has not been designed or manufactured for uses which demand an extremely high level of safety and carry a direct and serious risk of life or body if such safety cannot be assured.

These uses include control of nuclear reactions in nuclear power plants, automatic airplane flight control, air traffic control, traffic control in mass transport systems, medical devices for life support, and missile guidance control in weapons systems (hereafter, "high safety use"). Customers should not use this product for high safety use unless measures are in place for ensuring the level of safety demanded of such use. Please consult the sales staff of Fujitsu if intending to use this product for high safety use.

Measures against momentary voltage drop

This product may be affected by a momentary voltage drop in the power supply caused by lightning. To prevent a momentary voltage drop, use of an AC uninterruptible power supply is recommended.

(This notice follows the guidelines of Voltage Dip Immunity of Personal Computer issued by JEITA, the Japan Electronics and Information Technology Industries Association.)

Technology controlled by the Foreign Exchange and Foreign Trade Control Law of Japan

Documents produced by Fujitsu may contain technology controlled by the Foreign Exchange and Foreign Trade Control Law of Japan. Documents which contain such technology should not be exported from Japan or transferred to non-residents of Japan without first obtaining authorization in accordance with the above law.

Harmonic Current Standards

This product conforms to harmonic current standard JIS C 61000-3-2.

Only for the Japanese market: About SATA hard disk drives

The SATA version of this server supports hard disk drives with SATA / BC-SATA storage interfaces. Please note that the usage and operation conditions differ depending on the type of hard disk drive used.

Please refer to the following internet address for further information on the usage and operation conditions of each available type of hard disk drive:

<http://jp.fujitsu.com/platform/server/primergy/harddisk/>

Only for the Japanese market:



Although described in this manual, some sections do not apply to the Japanese market. These options include:

- CSS (Customer Self Service)



Contents

1	Introduction	11
1.1	Concept and target groups for this manual	11
1.2	Documentation overview	12
1.3	Notational conventions	14
2	Functional overview	15
2.1	Features	15
2.2	Server specification	25
3	Installation steps, overview	35
4	Important information	37
4.1	Safety instructions	37
4.2	ENERGY STAR	45
4.3	CE conformity	45
4.4	FCC Class A Compliance Statement	46
4.5	Transporting the server	47
4.6	Notes on installing the server in the rack	48
4.7	Environmental protection	49
5	Hardware installation	51
5.1	Unpacking the server	52
5.2	Installing/removing the server in/from the rack	53
5.3	Connecting devices to the server	55
5.4	Connecting the server to the power source	57
5.4.1	Connecting the server to the mains	57

Contents

5.4.2	Connecting the server to the direct current (optional DC hot-plug power supply unit)	58
5.4.3	Using the cable clamp	59
5.5	Notes on connecting/disconnecting cables	60
6	Starting up and operation	63
6.1	Controls and indicators	63
6.1.1	Front of server	63
6.1.1.1	Control elements	64
6.1.1.2	Indicators on the control panel	66
6.1.1.3	Indicators on the drives	68
6.1.2	Rear of server	70
6.1.3	Indicators of the hot-plug fans	74
6.2	Switching the server on and off	75
6.3	Configuring the server	78
6.3.1	Configuring the onboard SAS/SATA controller	78
6.3.2	Configuring the SAS/SATA RAID controller	79
6.3.3	Configuring the server and installing the operating system with the ServerView Installation Manager	80
6.3.4	Configuring the server and installing the operating system without the ServerView Installation Manager	81
6.4	Cleaning the server	82
7	Property and data protection	83
7.1	BIOS Setup security functions	83
8	Troubleshooting and tips	85
8.1	Power-on indicator remains unlit	85
8.2	Server switches itself off	86
8.3	Screen remains blank	86
8.4	Flickering stripes on monitor screen	87
8.5	No screen display or display drifts	87
8.6	Incorrect date and time	88

8.7	System will not boot	88
8.8	Drives reported as "dead" when starting system	88
8.9	Added drive reported as defective	89
8.10	Error message on screen	89
8.11	Expansion cards or onboard devices not recognized	89
8.12	Temperature warning	89
8.13	No effect of keyboard or mouse	90
8.14	Optical drive cannot read data	90

Contents

1 Introduction

The PRIMERGY RX300 S7 is a dual socket rack server, focusing on versatility and scalability. The new modular concept supports excellent expandability with up to 16 hard disk drives, up to 7 PCIe Gen 3 cards and up to 768 GB RAM, all in one single 2 height units (HU) rack housing. Furthermore, the new Intel® Xeon® E5 product family delivers the top performance to ensure today's demand while being prepared for future requirements thanks to the upgrade kits as well as the cost-saving LAN options. Thanks to the power supply units with 94% efficiency and the new power management this will result in lower operational costs. This 2HU power house is the right choice for all types of business applications and consolidations.

1.1 Concept and target groups for this manual

This operating manual describes how to install, set up and operate your server.

This operating manual is intended for those responsible for installing the hardware and ensuring that the system runs smoothly. It contains all the information you need to put your PRIMERGY RX300 S7 into operation.

To understand the various expansion options, you will need to be familiar with the fields of hardware and data transmission and you will require a basic knowledge of the underlying operating system.

1.2 Documentation overview

More information on your PRIMERGY RX300 S7 can be found in the following documents:

- "Quick Start Hardware - PRIMERGY RX300 S7" leaflet
(only included as a printed copy)
- "Quick Start Software - Quick Installation Guide" DVD booklet
(only included with the ServerView Suite as a printed copy)
- "Safety Notes and Regulations" manual
" 安全上のご注意 " for the Japanese market
- "Warranty" manual
" 保証書 " for the Japanese market
- "ServerView Suite Local Service Concept - LSC" manual
- "Returning used devices" manual and "Service Desk" leaflet
" サポート&サービス " for the Japanese market
- "PRIMERGY RX300 S7 Server Upgrade and Maintenance Manual"
- "D2939 BIOS Setup Utility for PRIMERGY RX300 S7 Reference Manual"
- "Integrated RAID for SAS User Guide"
- "LSI MegaRAID - SAS Software User Guide"
- "Modular RAID Controller / Modular SAS HBA Installation Guide"



PRIMERGY manuals are available in PDF format on the ServerView Suite DVD 2. The ServerView Suite DVD 2 is part of the ServerView Suite supplied with every server.

If you no longer have the ServerView Suite DVDs, you can obtain the relevant current versions using the order number U15000-C289 (the order number for the Japanese market: please refer to the configurator of the server <http://jp.fujitsu.com/platform/server/primergy/system/>).

The PDF files of the manuals can also be downloaded free of charge from the Internet. The overview page showing the online documentation available on the Internet can be found using the URL (for EMEA market): <http://manuals.ts.fujitsu.com>. The PRIMERGY server documentation can be accessed using the *Industry standard servers* navigation option.

For the Japanese market:

Please refer to the following URL for the latest product manuals:
<http://jp.fujitsu.com/platform/server/primergy/manual/>



Before using the product, please check for additional information that may be available under the following URL:
<http://jp.fujitsu.com/platform/server/primergy/products/note/>

Further sources of information:

- ServerView Suite Glossary on the ServerView Suite DVD 2
- Manual for the monitor
- Documentation for the boards and drives
- Operating system documentation
- Information files in your operating system

1.3 Notational conventions

The following notational conventions are used in this manual:

<i>Text in italics</i>	indicates commands or menu items.
"Quotation marks"	indicate names of chapters and terms that are being emphasized.
▶	describes activities that must be performed in the order shown.
 CAUTION!	pay particular attention to texts marked with this symbol. Failure to observe this warning may endanger your life, destroy the system or lead to the loss of data.
	indicates additional information, notes and tips.

2 Functional overview

This section provides information on the features and technical data of the PRIMERGY RX300 S7 server. For information on key characteristics and layout of the system board, see the "PRIMERGY RX300 S7 Server Upgrade and Maintenance Manual".

2.1 Features

Customer Self Service (CSS)

The PRIMERGY Customer Self Service (CSS) concept enables you to identify and replace the affected component yourself in the case of certain error scenarios.

In the CSS concept, you can replace the following components yourself in the event of an error:

- Hot-plug hard disk drives
- Hot-plug power supply units
- Memory modules
- Hot-plug system fans
- Expansion cards

For information on replacing these components, see the "PRIMERGY RX300 S7 Server Upgrade and Maintenance Manual".

CSS indicators on the control panel and on the back of the PRIMERGY server provide you with information if a CSS event arises.

You can also fit your server with a ServerView Local Service Panel, which enables you to identify the type of component affected by the error directly on the server.

In addition, CSS errors are displayed in the ServerView Operations Manager, the server management software from Fujitsu.

In the event of errors, the ServerView Operations Manager refers you directly to the affected component and its order information in the Illustrated Spares catalog of the server in question. (This feature is not available for the Japanese market.)



Further information on the CSS concept is provided in the "PRIMERGY ServerView Suite Local Service Concept - LSC" manual on the PRIMERGY ServerView Suite DVD 2.

For the latest information on optional products provided for the RX300 S7 see the configurator of the server:

http://ts.fujitsu.com/products/standard_servers/index.html
(for the EMEA market)

<http://jp.fujitsu.com/platform/server/primergy/system/>
(for the Japanese market)

System board

The features of the system board are described in the "D2939 BIOS Setup Utility for PRIMERGY RX300 S7 Reference Manual" for the firmware.

USB Flash Module (UFM) (option)

The system board is equipped with a UFM slot by the manufacturer.



The "internal USB stick" and "UFM" slots must not be used in parallel. Either an internal USB stick **or** a UFM may be used.

Trusted Platform Module (TPM)

A Trusted Platform Module (TPM) for safer storage of keys can be implemented as an option. This module enables programs from third party manufacturers to store key information (e.g. drive encryption using Windows Bitlocker Drive Encryption).

The TPM is activated via the BIOS system (for more information, refer to the "D2939 BIOS Setup Utility for PRIMERGY RX300 S7 Reference Manual").



CAUTION!

- When using the TPM, note the program descriptions provided by the third party manufacturers.
- You must also create a backup of the TPM content. To do this, follow the third party manufacturer's instructions. Without this backup, if the TPM or the system board is faulty you will not be able to access your data.

- If a failure occurs, please inform your service about the TPM activation before it takes any action, and be prepared to provide them with your backup copies of the TPM content.

Slots for expansion cards

The server can be flexibly expanded via seven slots (two PCIe Gen3 x16 and five PCIe Gen3 x8).

One of these slots (slot 7) is occupied with one of two possible SAS/SATA RAID controllers.

Hard disk drives

The server is available in the following drive configurations:

- 6*3.5-inch SAS/SATA hard disk drives:
up to six (2x3) HDD modules, each with a 3.5-inch SAS/SATA hard disk drive with a maximum height of 1 inch. Slot for an optional 3.5-inch DAT or RDX drive.
- 4*2.5-inch SAS/SATA hard disk drives:
up to four HDD modules, each with a 2.5-inch SAS/SATA hard disk drive with a maximum height of 15 mm.
- 4*2.5-inch SAS/SATA hard disk drives + LTO drive:
up to four HDD modules, each with a 2.5-inch SAS/SATA hard disk drive with a maximum height of 15 mm, and a 5.25-inch LTO drive.
- 8*2.5-inch SAS/SATA hard disk drives:
up to eight (2x4) HDD modules, each with a 2.5-inch SAS/SATA hard disk drive with a maximum height of 15 mm.
- 8*2.5-inch SAS/SATA hard disk drives + RDX/DAT drive:
up to eight (2x4) HDD modules, each with a 2.5-inch SAS/SATA hard disk drive with a maximum height of 15 mm, and a 3.5-inch DAT or RDX drive.
- 8*2.5-inch SAS/SATA hard disk drives + LTO drive:
up to eight (2x4) HDD modules, each with a 2.5-inch SAS/SATA hard disk drive with a maximum height of 15 mm, and a 5.25-inch LTO drive.
- 12*2.5-inch SAS/SATA hard disk drives:
up to twelve (3x4) HDD modules, each with a 2.5-inch SAS/SATA hard disk drive with a maximum height of 15 mm.

Functional overview

- 16*2.5-inch SAS/SATA hard disk drives:
up to sixteen (4x4) HDD modules, each with a 2.5-inch SAS/SATA hard disk drive with a maximum height of 15 mm.

The module is connected to the SAS/SATA backplane without cables. This allows HDD modules to be simply plugged in or pulled out (for further details see the "PRIMERGY RX300 S7 Server Upgrade and Maintenance Manual").

The hard disk subsystem is designed for SAS/SATA, each with one channel for each hard disk drive.

If the server has a RAID configuration, the HDD modules can be exchanged during operation (hot-swap).

Onboard SAS/SATA controller

A SAS/SATA controller is integrated on the system board; up to four SAS or SATA hard disk drives can be connected to the controller. The LSI Embedded MegaRAID software (Software RAID) supports RAID levels 0, 1 and 10. The SAS functionality needs to be enabled separately by using a onboard SAS enabling key.

For more information on configuring the controller, see section ["Configuring the onboard SAS/SATA controller" on page 78](#).

SAS/SATA RAID controller

The server is available with the following SAS/SATA RAID controllers for operating the internal SAS/SATA hard disk drives:

- Modular RAID 0/1 controller with "MegaRAID functionality" (SAS MegaRAID) for SAS1.0 and SAS2.0

RAID levels 0, 1, 10 and 1E are supported for internal hard disk drive configurations.

- Modular RAID 5/6 controller with "MegaRAID functionality" (SAS MegaRAID) for SAS1.0 and SAS2.0

RAID levels 0, 1, 10, 1E, 5, 50, 6 and 60 are supported for internal hard disk drive configurations. As an option, a battery backup unit (BBU) or a flash backup unit (FBU) can save the memory content even if the power fails. Cache memory size of 512 Mbyte or 1 Gbyte is available.



For more information on configuring the controller, see section ["Configuring the SAS/SATA RAID controller" on page 79](#).

Further information on SAS/SATA RAID controllers is provided in the "Modular RAID Controller Installation Guide" (on ServerView Suite DVD 2 under *Industry Standard Servers - Expansion Cards - Storage Adapters - LSI SAS / SCSI RAID Controllers*).

Further information on other SAS/SATA RAID controllers (e.g. for operating external SAS/SATA hard disk drives or tape drives) is available on ServerView Suite DVD 2 under *Industry Standard Servers - Expansion Cards - Storage Adapters - LSI SAS / SCSI RAID Controllers*.

Accessible drives / components

For all configurations, except those with 16*2.5-inch HDD modules or 8*2.5-inch HDD modules + LTO drive, a number of mounting locations is available:

- One 3.5-inch slimline bay for an optional Local Service Module:ServerView Local Service Display (LSD)
- One 3.5-inch slimline bay for an optional optical drive

For a configuration with 3.5-inch HDD modules, an optional DAT or RDX drive can be installed in the right-hand drive cage. This means that the top two bays of the drive cage are occupied and are no longer available for HDD modules.



The accessible drives/components described in this section cannot be replaced during operation.

USB connectors

Two USB 2.0 connectors on the front of the device support activities carried out by the service technician. The maximum length of the external cable is two meters for the USB connectors on the front.

Another four USB 2.0 connectors are available on the rear of the device.

Power supply

In its basic configuration, the server has a hot-pluggable power supply unit that adjusts automatically to any power voltage in the range from 100 V to 240 V. As an option, the power supply can be expanded with an extra power supply unit to create a redundant power supply. If a power supply unit fails, the redundant configuration assures continued operation. The defective power supply unit can be replaced during operation (for further details see the "PRIMERGY RX300 S7 Server Upgrade and Maintenance Manual").



As an option, the server can be equipped with a DC hot-plug power supply unit that adjusts automatically to any power voltage in the range from -40.5 V to -57 V.

Cooling

The Cool-safe™ cooling concept with improved air flow cooling technology (honeycomb design) ensures the highest possible performance of the processors at work; at the same time, the system is extremely reliable thanks to the reduced heat dissipation.

The server is equipped with five separate hot-plug fan modules. The redundant fan configuration allows one fan to fail and the system still works. To ensure the redundancy of the fan system the faulty fan has to be replaced immediately.

Defective fans can be replaced during operation (for further details see the "PRIMERGY RX300 S7 Server Upgrade and Maintenance Manual").

Each processor has a heat sink.

High level of availability and data security

When memory data is accessed, 1-bit errors are identified in the main memory and automatically corrected with the error correcting code (ECC) method. The patented memory scrubbing function regularly starts up the EDC mechanism, ensuring continuous data integrity.

The memory modules used support SDDC technology (Chipkill™), which further increases the effectiveness of memory error monitoring and correction.

Rank sparing memory technology is also supported, whereby one memory module is used as a replacement for two other memory modules. If a memory module fails, the module with the defective memory is deactivated automatically and the replacement module is activated (provided that it has been configured accordingly in BIOS; see *BIOS Setup*). The deactivated memory module is no longer used and the faulty memory module can be replaced at the next opportunity. The spare rank module must have identical or larger memory capacity than all the other ranks on the same channel.

Memory modules can be protected against failure by mirroring (Memory Mirroring). Memory Mirroring is roughly comparable to RAID level 1 for hard disk arrays.



For further information according to memory module population please refer to the technical manual of the system board D2939.

ASR&R (Automatic Server Reconfiguration and Restart) restarts the system in the event of an error and automatically "hides" the defective system components.

The PDA (Prefailure Detection and Analysing) technology from Fujitsu analyzes and monitors all components that are critical for system reliability.

The RAID functionality of the SAS RAID controller increases the availability of the system.

The hot-plug HDD modules provide additional availability.

iRMC S3 with integrated management LAN connector

The iRMC S3 (integrated **R**emote **M**anagement **C**ontroller) is a Baseboard Management Controller (BMC) with integrated management LAN connector and expanded functionality that was previously only available with additional plug-in cards. In this way, the iRMC S3 enables complete control of PRIMERGY servers, regardless of system status, and thus particularly the control of PRIMERGY servers that are in the "out-of-band" system status.

Major functions supported by the iRMC S3 include the following:

- Browser access via iRMC S3's own Web server
- Secure communication (SSH, SSL)
- Power Management for the managed server (depending on its system status)
- Power Consumption Management
- Connecting virtual drives as remote storage
- Text-based and graphic console bypass (Advanced Video Redirection)
- Remote Storage
- Command Line Interface (CLI)
- Simple, interactive or script-based iRMC S3 configuration
- Customer Self Service (CSS)
- iRMC S3's own user management
- Multi-computer, global iRMC S3 user administration using an LDAP Directory Service
- Automatic network configuration via DNS / DHCP

Functional overview

- Power supply of the iRMC S3 via the system standby supply
- Full-coverage alarm management
- System Event Log (SEL) reading and processing

More information about the iRMC S3 can be found in the "iRMC S2/3 - integrated Remote Management Controller" user guide (on the ServerView Suite DVD 2 under *Industry Standard Servers - Software - ServerView Suite - Out-Of-Band Management*).

Server management

Server management is implemented using the ServerView Operations Manager supplied and the PDA (Prefailure Detection and Analysis) technology from Fujitsu. PDA reports the threat of a system error or overload at an early stage, allowing preventive measures to be taken.

The ServerView Operations Manager enables the management of all PRIMERGY servers in the network via a central console. The ServerView Operations Manager supports the following functions:

- Round-the-clock monitoring, regardless of server status
- High-performance, graphical console bypass (AVR) protected by HTTPS/SSL (128 bit)
- Remote storage via USB
- Remote power on
- Temperature monitoring of the CPU and the surrounding area
- Detailed status and error reports for processors and main memory
- Watchdog timer for Automatic Server Reconfiguration and Restart (ASR&R) in the event that memory modules or processors fail
- Power monitoring
- End-of-life monitoring of fans with prompt notification before failure
- Watchdog timer for monitoring the operating system with ASR&R

Further information on the ServerView Operations Manager is provided in the associated documentation.

ServerView Installation Manager

You can configure the PRIMERGY server quickly and precisely with the ServerView Installation Manager software provided. User-guided menus are available for installing the server operating system (for further details see section "[Configuring the server](#)" on page 78).

Service and support

PRIMERGY servers are easy to maintain and modular, thus enabling quick and simple maintenance.

The handles and locks (touch points) used to exchange components are colored green to ensure simple and immediate recognition.

In order to prevent the components from being damaged by incorrect handling when they are being installed and removed, the areas of all components that can be touched without damaging them are also marked green.

PRIMERGY diagnostic LEDs fitted on the system board indicate which component (memory module, processor, fan or expansion card) is not functioning properly.

The Flash EPROM program supplied with the Fujitsu utilities supports a fast BIOS update.

With the iRMC S3 (integrated Remote Management Controller) on the system board, the PRIMERGY RX300 S7 server can also be maintained and serviced remotely. This enables remote diagnosis for system analysis, remote configuration and remote restart should the operating system or hardware fail.

ServerView Remote Management

ServerView Remote Management is the remote management solution from Fujitsu for PRIMERGY servers. ServerView Remote Management and the relevant hardware components integrated on the system board allow remote monitoring and maintenance as well as fast restoration of operation in the event of errors.

Remote monitoring and maintenance avoids time-consuming and costly on-site repairs and reduces service costs. This leads to a reduction in the total cost of ownership and an excellent return on investment for the remote management solution.

The administrator can access all system information and information from the sensors such as fan speeds or voltages via the iRMC S3's Web interface (see section ["iRMC S3 with integrated management LAN connector" on page 21](#)). You can also start the text-based or graphic console bypass (Advanced Video Redirection, AVR) and connect virtual drives as remote storage.



More information about the iRMC S3 can be found in the "iRMC S2/3 - integrated Remote Management Controller" user guide (on the ServerView Suite DVD 2 under *Industry Standard Servers - Software - ServerView Suite - Out-Of-Band Management*).

2.2 Server specification

This section explains the specifications for the server. The specifications for this server are liable to be updated without any notice. Please be forewarned.

System Board

System board type	D2939
Chipset	Intel C602

Processor

Processor quantity and type	1 or 2 Intel E5-2600 family processors
-----------------------------	--

Memory Modules Configuration

Memory slots	24
Memory slot type	DDR3
Memory capacity (min. - max.)	2 GB - 768 GB
Memory protection	Memory Scrubbing; SDDC (Chipkill™); Memory Mirroring support; Rank sparing memory support
Memory notes	<p>Max. 8 memory modules/CPU with UDIMM (low voltage or standard) OR quad-rank RDIMM; max. 12 memory modules/CPU with single or dual-rank RDIMM or LRDIMM.</p> <p>Memory Mirroring with identical modules in both channel pairs of a bank (4 modules per bank), Rank sparing or Performance Mode with the spare rank module having identical or larger memory capacity than all the other ranks on the same channel.</p>

Functional overview

Interfaces

USB connectors	10 x USB 2.0 (2 x front, 4 x rear, 2 x internal for backup devices plus 1 x USB stick, 1 x USSD)
Graphics (15-pin)	2 x VGA (thereof 1x front optional)
Serial	1 x serial RS-232-C, usable for iRMC S3 or system or shared
LAN / Ethernet (RJ45)	2 x 1 Gbit/s Ethernet as default. Modular On-Board LAN with upgrade options to 2 x 1 Gbit/s (RJ45), 4 x 1 Gbit/s (RJ45) or 2 x 10 Gbit/s (SFP+).
Management LAN (RJ45)	1 x dedicated management LAN connector for iRMC S3 (10/100/1000 Mbit/s). Management LAN traffic can be switched to shared onboard Gbit LAN connector. Shared 10Gbit/s (SFP+) Management LAN as option if Modular On-Board LAN 2 x 10 Gbit/s is configured. Front management LAN connector as option.

Onboard or integrated controllers

RAID controller	4 port for internal 3G SATA and SAS (as upgrade option "Patsburg B") for HDDs with RAID 0/1/10 or SAS LTO device (Intel C600). For additional RAID controller options are described under " RAID controllers (expansion cards) " on page 27
SATA controller	Intel C600, 1 x SATA channel for ODD
LAN Controller	Intel Ethernet Controller I350, 2 x 10/100/1000 Mbit/s Ethernet (I/O acceleration), in addition 2 x 1 Gbit/s as default. Modular On-Board LAN with upgrade options to 4 x 1 Gbit/s or 2 x 10 Gbit/s. PXE-Boot via LAN from PXE server, iSCSI boot (also diskless).

Remote Management Controller	Integrated Remote Management Controller (iRMC S3, 32 MB attached memory incl. graphics controller), IPMI 2.0 compatible
Trusted Platform Module (TPM)	Infineon / separate module; TCG V1.2 compliant (option)

RAID controllers (expansion cards)

RAID controllers	RAID 5/6 Ctrl., HDD SAS 6 Gb, LSI , 8 ports ext. RAID level: 0, 1, 10, 5, 50, 6, 60, 512 MB Cache, Optional BBU (based on LSI SAS2108).
	RAID 5/6 Ctrl., HDD SAS 6 Gb, Fujitsu , 8 ports int. RAID level: 0, 1, 10, 5, 50, 6, 60, 1024 MB Cache, Optional FBU (based on LSI SAS2208).
	RAID 5/6 Ctrl., HDD SAS 6 Gb, Fujitsu , 8 ports int. RAID level: 0, 1, 10, 5, 50, 6, 60, 512 MB Cache, Optional BBU (based on LSI SAS2108).
	RAID 0/1 Ctrl., SAS/SATA 6 Gb, Fujitsu , 8 ports int. RAID level: 0, 1, 10, No BBU support (based on LSI SAS2008)

Slots

PCI-Express 3.0 x8	5 x low profile
PCI-Express 3.0 x16	2 x low profile (2nd processor required)
Slot notes	<p>One PCIe Gen3 x8 slot (slot 1) may be occupied with a Modular On-Board LAN controller if configured. This slot is marked with a color-coded connector (white) and a special LAN sticker on the rear of the chassis.</p> <p>One PCIe Gen3 x8 slot may be occupied with a Modular RAID controller if configured.</p> <p>Important: 5 PCIe x8 slots are supported with the first processor. 7 PCIe slots (including 2 PCIe x16) are supported with two processors.</p>

Functional overview

Drive bays

Hard disk bay configuration	6x 3.5-inch, for SAS / SATA or 4x 2.5-inch, 8x 2.5-inch, 12x 2.5-inch, 16x 2.5-inch for SAS/SATA/SSD optional
Accessible drive bays	1 x 5.25-inch for LTO drive or 1 x 3.5-inch for DAT/RDX drive or 1 x 3.5-inch for ODD drive or 1 x 3.5/0.5-inch for ServerView Local Service Display
Notes accessible drives	all possible options described in relevant system configurator

Operating Panel

Operating buttons	On/off button
	Reset button
	NMI button
	ID button
Status LEDs	Global error indicator (orange)
	ID indicator (blue)
	HDD/SSD activity indicator (green)
	Power-on indicator (orange / yellow / green)
	HDD/SSD error indicator (orange)
	PSU error indicator (orange)
	Temperature error indicator (orange)
	CPU error indicator (orange)
	Memory error indicator (orange)
	Fan error indicator (orange)
	ID indicator (blue)
	CSS indicator (yellow)

Status LED at system rear side:	Global error / CSS / ID indicator (orange / yellow / blue)
	LAN connection indicator (green)
	LAN speed indicator (green / yellow)
Service displays (optional):	ServerView Local Service Display (LSD)

Dimensions / Weight

Rack (W x D x H)	482.6 mm (bezel) / 445 mm (body) x 770 mm x 86.9 mm
Mounting depth rack	735 mm
Height unit rack	2 U
19" rackmount	Yes
Mounting cable depth rack	100 mm (1000 mm rack recommended)
Weight	25 kg
Weight notes	actual weight may vary depending on configuration
Rack mounting kit	rack mounting kit as option

Ambient conditions

Environment class 3K2	EN 60721 / IEC 721 Part 3-3
Environment class 2K2	EN 60721 / IEC 721 Part 3-2
Temperature:	
Operation (3K2)	10°C ... 35°C
Transport (2K2)	- 25°C ... 60°C
Humidity	10% ... 85% (non condensing)

Condensation during operation must be avoided!

Functional overview

Noise level (depending on the configuration)

The acoustic noise values are depending on the system configuration.

	min. configuration (specpwr config)	low noise mode configuration	max. configuration
Sound power level L_{WAAd} (ISO 9296)	< 4.1 B (standby) < 4.1 B (operation)	< 4.5 B (standby) < 4.9 B (operation)	< 6.5 B (standby) < 6.5 B (operation) < 8.5 B (full fan speed)
Sound pressure level at adjacent workstation L_{pAm} (ISO 9296)	< 25 dB(A)(standby) < 27 dB(A)(operation)	< 29 dB(A)(standby) < 32 dB(A)(operation)	< 48 db(A) (standby) < 48 db(A) (operation) < 68 db(A) (full fan speed)

You can switch on/off the low noise mode (LNM) via the IRMC S3 web user interface. The LNM option is only shown in the IRMC S3, if the server's configuration fits the following:

- CPU(s) max. 80W TDP (thermal design power)
- only 1 memory module per channel (i.e. max 8 memory modules)
- Only one expansion card (slot 7 has to be used)



In low noise mode, the CPU performance is limited by P15 (performance state 15).



When the environment temperature exceeds 25°C, the LNM is automatically disabled until the temperature is below this point again.

Electrical data (AC hot-plug power supply unit)

Rated voltage range	100 V - 240 V
Frequency	50 Hz - 60 Hz
Max. rated current	8.2 A - 3.3 A / 100 V - 240 V
Effective power	450/800 W
Apparent power	873 VA - 829 VA / 100 V - 240 V
Heat dissipation	2638.8 kJ/h (2501.7 btu/h)
Main power fuse	16 A
Protection class	I

Electrical data (optional DC hot-plug power supply unit)

Rated voltage range	-40.5 V ... -57 V
Frequency	DC
Max. rated current	23.8 A - 16.4 A / 40.5 V - 57 V
Effective power	800 W
Main power fuse	16 A

Functional overview

Screen resolution

The screen resolutions in the following table refer to the graphics controller on the system board. The graphics controller is integrated in the iRMC S3 (integrated Remote Management Controller).

Screen resolution (pixel)	Maximum refresh rate (Hz)	Max. number of colours
640x480	85	32 bit
800x600	85	32 bit
1024x768	75	32 bit
1152x864	60	16 bit
1280x1024	60	24 bit
1600x1200	60	16 bit
1920x1080	60	16 bit

If you are using an external graphics controller, you will find details of supported screen resolutions in the Operating Manual or Technical Manual supplied with the graphics controller.

Compliance with regulations and standards

Product safety and ergonomics	
International	IEC 60950-1 2ed.
Europe	
Safety	EN 60950-1 2ed. EN 50371 EN 50392
Ergonomics	ISO 9241-3 EN 2941-3 EK1-ITB 2003:2007
USA / Canada	CSA-C22.2 No. 60950-1-07 2ed. UL 60950-1 2ed.
Taiwan	CNS 14336
China	GB 4943
Electromagnetic compatibility	
International	CISPR 22
Europe	EN 55022 Class A EN 55024 EN 61000-3-2 EN 61000-3-3 ETSI 300386
USA / Canada	47CFR part 15 Class A / ICES-003
Taiwan	CNS 13438 Class A
China	GB 9245 / GB 17625
Japan	VCCI Class A / JEITA
Korea	KN 22 / KN 24
CE marking to EU directives	Low Voltage Directive 2006/95/EC Electromagnetic compatibility 2004/108/EC

3 Installation steps, overview

This chapter contains an overview of the steps necessary to install your server. Links take you to sections where you can find more detailed information about the respective steps:

- ▶ First of all, carefully read the safety instructions in ["Important information" on page 37](#) and following.
- ▶ Transport the server to the place where you want to set it up.
- ▶ Unpack the system, check the contents of the package for visible transport damage and check whether the items delivered correspond to the details on the delivery note (see ["Unpacking the server" on page 52](#)).
- ▶ Make sure that you have all necessary manuals (see ["Documentation overview" on page 12](#)); print out the PDF files if required.
- ▶ Components that have been ordered additionally may be delivered loose with the server. For mounting refer to the original component documentation.
- ▶ Mount the server into the rack (see ["Installing/removing the server in/from the rack" on page 53](#)).
- ▶ Wire the server. To do this, refer to sections ["Connecting devices to the server" on page 55](#) and ["Notes on connecting/disconnecting cables" on page 60](#).
- ▶ Connect the server to the mains (see ["Connecting the server to the power source" on page 57](#)).
- ▶ Familiarize yourself with the controls and indicators on the front and rear of the server (see section ["Controls and indicators" on page 63](#)).

Installation steps, overview

- ▶ Configure the server and install the desired operating system and applications. The following options are available:
 - Remote installation with the ServerView Installation Manager:

With the ServerView Suite DVD 1 provided, you can configure the server and install the operating system in a convenient manner.

Details on how to operate the ServerView Installation Manager, as well as some additional information, are included in the "ServerView Suite Installation Manager" user's guide (on ServerView Suite DVD 2 under *Industry Standard Servers - Software - ServerView Suite - Server Installation and Deployment*).

Configuration information can also be found in section "[Configuring the server and installing the operating system with the ServerView Installation Manager](#)" on page 80.
 - Local configuration and installation with or without the ServerView Installation Manager (see section "[Configuring the server and installing the operating system with the ServerView Installation Manager](#)" on page 80 or section "[Configuring the server and installing the operating system without the ServerView Installation Manager](#)" on page 81).



You will find more information on installing the server remotely or locally in the "ServerView Suite Installation Manager" user's guide (on the ServerView Suite DVD 2 under *Industry Standard Servers - Software - ServerView Suite - Server Installation and Deployment*).

4 Important information

In this chapter you will find essential information regarding safety when working on your server.

4.1 Safety instructions



The following safety instructions are also provided in the manual "Safety Notes and Regulations" or "安全上のご注意".

This device meets the relevant safety regulations for IT equipment. If you have any questions about whether you can install the server in the intended environment, please contact your sales outlet or our customer service team.



CAUTION!

- The actions described in this manual shall be performed by technical specialists. A technical specialist is a person who is trained to install the server including hardware and software.
- Repairs to the device that do not relate to CSS failures shall be performed by service personnel. Please note that unauthorized interference with the system will void the warranty and exempt the manufacturer from all liability.
- Any failure to observe the guidelines in this manual, and any improper repairs could expose the user to risks (electric shock, energy hazards, fire hazards) or damage the equipment.
- Before installing/removing internal options to/from the server, turn off the server, all peripheral devices, and any other connected devices. Also unplug all power cords from the power outlet. Failure to do so can cause electric shock.

Important information

Before starting up



CAUTION!

- During installation and before operating the device, observe the instructions on environmental conditions for your device (see ["Ambient conditions" on page 29](#)).
- If the server has been moved from a cold environment, condensation may form both inside and on the outside of the machine.

Wait until the server has acclimatized to room temperature and is absolutely dry before starting it up. Material damage may be caused to the server if this requirement is not met.

- Only transport the server in the original packaging or in packaging that protects it from impacts and jolts.

Installation and operation



CAUTION!

- This unit should not be operated in ambient temperatures above 35 °C.
- If the unit is integrated into an installation that draws power from an industrial power supply network with an IEC309 connector, the power supply's fuse protection must comply with the requirements for non-industrial power supply networks for type A connectors.
- The unit automatically adjusts itself to a mains voltage in a range of 100 V - 240 V. Ensure that the local mains voltage lies within these limits.
- This device must only be connected to properly grounded power outlets or insulated sockets of the rack's internal power supply with tested and approved power cords.
- Ensure that the device is connected to a properly grounded power outlet close to the device.



CAUTION!

- Ensure that the power sockets on the device and the properly grounded power outlets are freely accessible.
- The On/Off button or the main power switch (if present) does not isolate the device from the mains power supply. To disconnect it completely from the mains power supply, unplug all network power plugs from the properly grounded power outlets.
- Always connect the server and the attached peripherals to the same power circuit. Otherwise you run the risk of losing data if, for example, the server is still running but a peripheral device (e.g. memory subsystem) fails during a power outage.
- Data cables must be adequately shielded.
- Ethernet cabling has to comply with EN 50173 and EN 50174-1/2 standards or ISO/IEC 11801 standard respectively. The minimum requirement is a Category 5 shielded cable for 10/100 Ethernet, or a Category 5e cable for Gigabit Ethernet.
- Route the cables in such a way that they do not create a potential hazard (make sure no-one can trip over them) and that they cannot be damaged. When connecting the server, refer to the relevant instructions in this manual.
- Never connect or disconnect data transmission lines during a storm (risk of lightning hazard).
- Make sure that no objects (e.g. jewelry, paperclips etc.) or liquids can get inside the server (risk of electric shock, short circuit).
- In emergencies (e.g. damaged casing, controls or cables, penetration of liquids or foreign bodies), switch off the server immediately, remove all power plugs and contact your sales outlet or customer service team.
- Before removing the airduct unplug all network power plugs from the properly grounded power outlets (rotating fans).



CAUTION!

- Proper operation of the system (in accordance with IEC 60950-1/2 resp. EN 60950-1/2) is only ensured if the casing is completely assembled and the rear covers for the installation slots have been fitted (electric shock, cooling, fire protection, interference suppression).
- Only install system expansions that satisfy the requirements and rules governing safety and electromagnetic compatibility and those relating to telecommunication terminals. If you install other expansions, they may damage the system or violate the safety regulations. Information on which system expansions are approved for installation can be obtained from our customer service center or your sales outlet.
- The components marked with a warning notice (e.g. lightning symbol) may only be opened, removed or exchanged by authorized, qualified personnel. Exception: CSS components can be replaced.
- The warranty is void if the server is damaged during installation or replacement of system expansions.
- Only set screen resolutions and refresh rates that are specified in the operating manual for the monitor. Otherwise, you may damage your monitor. If you are in any doubt, contact your sales outlet or customer service center.
- Before installing/removing internal options to/from the server, turn off the server, all peripheral devices, and any other connected devices. Also unplug all power cords from the outlet. Failure to do so can cause electric shock.
- Do not damage or modify internal cables or devices. Doing so may cause a device failure, fire, or electric shock.
- Devices inside the server remain hot after shutdown. Wait for a while after shutdown before installing or removing internal options.
- The circuit boards and soldered parts of internal options are exposed and can be damaged by static electricity. Before handling them, first touch a metal part of the server to discharge static electricity from your body.
- Do not touch the circuitry on boards or soldered parts. Hold the metallic areas or the edges of the circuit boards.



CAUTION!

- Install the screw removed during installation/detaching Internal Options in former device/position. To use a screw of the different kind causes a breakdown of equipment.
- The installation indicated on this note is sometimes changed to the kind of possible options without notice.

Batteries



CAUTION!

- Incorrect replacement of batteries may lead to a risk of explosion. The batteries may only be replaced with identical batteries or with a type recommended by the manufacturer (refer to the "PRIMERGY RX300 S7 Server Upgrade and Maintenance Manual").
- Do not throw batteries into the trash can.
- Batteries must be disposed of in accordance with local regulations concerning special waste.
- Replace the lithium battery on the system board in accordance with the instructions in the "PRIMERGY RX300 S7 Server Upgrade and Maintenance Manual".
- All batteries containing pollutants are marked with a symbol (a crossed-out garbage can). In addition, the marking is provided with the chemical symbol of the heavy metal decisive for the classification as a pollutant:

Cd Cadmium

Hg Mercury

Pb Lead

Working with CDs/DVDs/BDs and optical drives

When working with devices with optical drives, these instructions must be followed.



CAUTION!

- Only use CDs/DVDs/BDs that are in perfect condition, in order to prevent data loss, equipment damage and injury.
- Check each CD/DVD/BD for damage, cracks, breakages etc. before inserting it in the drive.

Note that any additional labels applied may change the mechanical properties of a CD/DVD/BD and cause imbalance.

Damaged and imbalanced CDs/DVDs/BDs can break at high drive speeds (data loss).

Under certain circumstances, sharp CD/DVD/BD fragments can pierce the cover of the optical drive (equipment damage) and can fly out of the device (danger of injury, particularly to uncovered body parts such as the face or neck).

- High humidity and airborne dust levels are to be avoided. Electric shocks and/or server failures may be caused by liquids such as water, or metallic items, such as paper clips, entering a drive.
- Shocks and vibrations are also to be avoided.
- Do not insert any objects other than the specified CDs/DVDs/BDs.
- Do not pull on, press hard, or otherwise handle the CD/DVD/BD tray roughly.
- Do not disassemble the optical drive.
- Before use, clean the optical disk tray using a soft, dry cloth.
- As a precaution, remove disks from the optical drive when the drive is not to be used for a long time. Keep the optical disk tray closed to prevent foreign matter, such as dust, from entering the optical drive.
- Hold CDs/DVDs/BDs by their edges to avoid contact with the disk surface.

- Do not contaminate the CD/DVD/BD surface with fingerprints, oil, dust, etc. If dirty, clean with a soft, dry cloth, wiping from the center to the edge. Do not use benzene, thinners, water, record sprays, antistatic agents, or silicone-impregnated cloth.
- Be careful not to damage the CD/DVD/BD surface.
- Keep the CDs/DVDs/BDs away from heat sources.
- Do not bend or place heavy objects on CDs/DVDs/BDs.
- Do not write with ballpoint pen or pencil on the label (printed) side.
- Do not attach stickers or similar to the label side. Doing so may cause rotational eccentricity and abnormal vibrations.
- When a CD/DVD/BD is moved from a cold place to a warm place, moisture condensation on the CD/DVD/BD surface can cause data read errors. In this case, wipe the CD/DVD/BD with a soft, dry cloth in a radial way then let it air dry. Do not dry the CD/DVD/BD using devices such as a hair dryer.
- To avoid dust, damage, and deformation, keep the CD/DVD/BD in its case whenever it is not in use.
- Do not store CDs/DVDs/BDs at high temperatures. Areas exposed to prolonged direct sunlight or near heating appliances are to be avoided.



You can prevent damage from the optical drive and the CDs/DVDs/BDs, as well as premature wear of the disks, by observing the following suggestions:

- Only insert disks in the drive when needed and remove them after use.
- Store the disks in suitable sleeves.
- Protect the disks from exposure to heat and direct sunlight.

Laser information

The optical drive complies with IEC 60825-1 laser class 1.



CAUTION!

The optical drive contains a light-emitting diode (LED), which under certain circumstances produces a laser beam stronger than laser class 1. Looking directly at this beam is dangerous.

Never remove parts of the optical drive casing!

Modules with Electrostatic-Sensitive Devices

Modules with electrostatic-sensitive devices are identified by the following sticker:

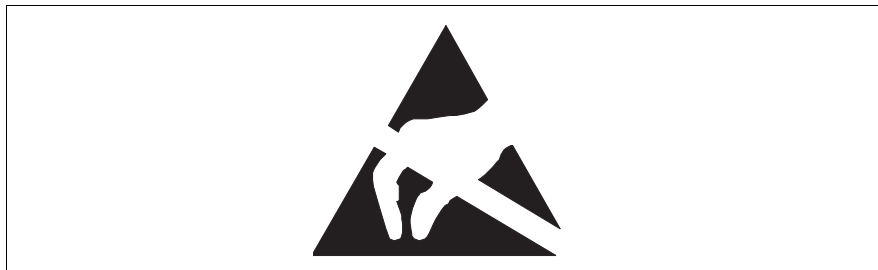

Figure 1: ESD label

When you handle components fitted with ESDs, you must always observe the following points:

- Switch off the system and remove the power plugs from the power outlets before installing or removing components with ESDs.
- You must always discharge static build-up (e.g. by touching a grounded object) before working with such components.
- Any devices or tools that are used must be free of electrostatic charge.
- Wear a suitable grounding cable that connects you to the external chassis of the system unit.
- Always hold components with ESDs at the edges or at the points marked green (touch points).
- Do not touch any connectors or conduction paths on an ESD.
- Place all the components on a pad which is free of electrostatic charge.



For a detailed description of how to handle ESD components, see the relevant European or international standards (EN 61340-5-1, ANSI/ESD S20.20).

Other important information:

- During cleaning, observe the instructions in section "[Cleaning the server](#)" on [page 82](#).
- Keep this operating manual and the other documentation close to the device. All documentation must be included if the equipment is passed on to a third party.

4.2 ENERGY STAR



Products that have been certified compliant with ENERGY STAR and identified as such are in full compliance with the specification at shipping. Note that energy consumption can be affected by software that is installed or any changes that are made to the hardware configuration or BIOS or energy options subsequently. In such cases, the properties guaranteed by ENERGY STAR can no longer be assured.

The "ServerView Operations Manager" user guide contains instructions for reading out measurement values, including those relating to current energy consumption and air temperatures. Either the Performance Monitor or the Task Manager can be used to read out CPU utilization levels.

4.3 CE conformity



The system complies with the requirements of the EC directives 2004/108/EC regarding "Electromagnetic Compatibility" and 2006/95/EC "Low Voltage Directive". This is indicated by the CE marking (CE = Communauté Européenne).

4.4 FCC Class A Compliance Statement

If there is an FCC statement on the device, it applies to the products covered in this manual, unless otherwise specified herein. The statement for other products will appear in the accompanying documentation.

NOTE:

This equipment has been tested and found to comply with the limits for a "Class A" digital device, pursuant to Part 15 of the FCC rules and meets all requirements of the Canadian Interference-Causing Equipment Standard ICES-003 for digital apparatus. These limits are designed to provide reasonable protection against harmful interference in a residential installation. This equipment generates, uses and can radiate radio frequency energy and, if not installed and used in strict accordance with the instructions, may cause harmful interference to radio communications. However, there is no warranty that interference will not occur in a particular installation. If this equipment does cause harmful interference to radio or television reception, which can be determined by turning the equipment off and on, the user is encouraged to try to correct the interference by one or more of the following measures:

- Reorient or relocate the receiving antenna.
- Increase the separation between equipment and the receiver.
- Connect the equipment into an outlet on a circuit different from that to which the receiver is connected.
- Consult the dealer or an experienced radio/TV technician for help.

Fujitsu is not responsible for any radio or television interference caused by unauthorized modifications of this equipment or the substitution or attachment of connecting cables and equipment other than those specified by Fujitsu. The correction of interferences caused by such unauthorized modification, substitution or attachment will be the responsibility of the user.

The use of shielded I/O cables is required when connecting this equipment to any and all optional peripheral or host devices. Failure to do so may violate FCC and ICES rules.

WARNING:

This is a class A product. In a domestic environment this product may cause radio interference in which case the user may be required to take adequate measures.

4.5 Transporting the server



CAUTION!

Only transport the server in its original packaging or in packaging that protects it from impacts and jolts. Do not unpack the server until it is at its installation location.

If you need to lift or transport the server, ask other people to help you.

Never lift or carry the device by the Quick Release Levers (QRLs) on the front panel.

4.6 Notes on installing the server in the rack



CAUTION!

- For safety reasons, at least two people are required to install the server in the rack because of its weight and size.
(For the Japanese market, please refer to "安全上のご注意".)
- Never lift the server into the rack using the QRLs (Quick Release Levers) on the front panel.
- When connecting and disconnecting cables, observe the relevant instructions in the "Important Information" chapter of the technical manual for the corresponding rack. The technical manual is supplied with the corresponding rack.
- When installing the rack, make sure that the anti-tilt mechanism is correctly fitted.
- Do not extend more than one unit out of the rack simultaneously even if the tilt protection is in place. If several units are simultaneously extended from the rack, there is a risk that the rack could tip over. See the safety information of the rack and the warning label.
- Only for the EMEA market:
The rack must be connected to the power supply by an authorized specialist (electrician).
- If the server is integrated into an installation that draws power from an industrial power supply network with an IEC309 type connector, the power supply's fuse protection must comply with the requirements for non-industrial power supply networks for the type A connector.

4.7 Environmental protection

Environmentally-friendly product design and development

This product has been designed in accordance with the Fujitsu standard for "environmentally friendly product design and development". This means that key factors such as durability, selection and labeling of materials, emissions, packaging, ease of dismantling and recycling have been taken into account.

This saves resources and thus reduces the harm done to the environment. Further information can be found at:

- http://ts.fujitsu.com/products/standard_servers/index.html (for the EMEA market)
- <http://jp.fujitsu.com/platform/server/primergy/concept/> (for the Japanese market)

Energy-saving information

Devices that do not need to be constantly switched on should be switched off until they are needed as well as during long breaks and after completion of work.

Packaging information

This packaging information doesn't apply to the Japanese market.

Do not throw away the packaging. You may need it later for transporting the system. If possible, the equipment should only be transported in its original packaging.

Information on handling consumables

Please dispose of printer consumables and batteries in accordance with the applicable national regulations.

In accordance with EU directives, batteries must not be disposed of with unsorted domestic waste. They can be returned free of charge to the manufacturer, dealer or an authorized agent for recycling or disposal.

All batteries containing pollutants are marked with a symbol (a crossed-out garbage can). They are also marked with the chemical symbol for the heavy metal that causes them to be categorized as containing pollutants:

Cd Cadmium
Hg Mercury
Pb Lead

Important information

Pb Lead

Labels on plastic casing parts

Please avoid sticking your own labels on plastic parts wherever possible, since this makes it difficult to recycle them.

Returns, recycling and disposal

Please handle returns, recycling and disposal in accordance with local regulations.



The device must not be disposed of with domestic waste. This device is labeled in compliance with European directive 2002/96/EC on waste electrical and electronic equipment (WEEE).

This directive sets the framework for returning and recycling used equipment and is valid across the EU. When returning your used device, please use the return and collection systems available to you. Further information can be found at

<http://ts.fujitsu.com/recycling>.

Details regarding the return and recycling of devices and consumables within Europe can also be found in the "Returning used devices" manual, via your local Fujitsu branch or from our recycling center in Paderborn:

Fujitsu Technology Solutions
Recycling Center
D-33106 Paderborn

Tel. +49 5251 525 1410
Fax +49 5251 525 32 1410

5 Hardware installation



CAUTION!

- Follow the safety instructions in the chapter "[Important information](#)" on page 37.
- Do not expose the server to extreme environmental conditions (see "[Ambient conditions](#)" on page 29). Protect the server from dust, humidity and heat.
- Make sure that the server is acclimatized for the time indicated in this table before putting it into operation.

Temperature difference (°C)	Minimum acclimatization time (hours)
5	3
10	5
15	7
20	8
25	9
30	10

Table 1: Acclimatization time

In the [table "Acclimatization time"](#), the temperature difference refers to the difference between the operating environment temperature and the temperature to which the server was exposed previously (outside, transport or storage temperature).

5.1 Unpacking the server



CAUTION!

Follow the safety instructions in ["Introduction" on page 11](#).

The server must always be lifted or carried by at least two people.
(For the Japanese market, please refer to "安全上のご注意".)

Do not unpack the server until it is at its installation location.

- ▶ Transport the server to the place where you want to set it up.
- ▶ Unpack all individual parts.

Keep the original packaging in case you want to transport the server again (applies only to EMEA market).

- ▶ Check the delivery for any damage during transport.
- ▶ Check whether the items delivered match the details on the delivery note.

The product name and serial number of the product can be found on the ID card (see section ["Front of server" on page 63](#)).

- ▶ Notify your supplier immediately should you discover that the items delivered do not correspond to the delivery note.

5.2 Installing/removing the server in/from the rack



CAUTION!

- Please observe the safety information and notes on rack mounting in chapter "Important information" on page 37 and section "Notes on installing the server in the rack" on page 48.
- At least two people are needed to install / remove the server in the rack. (For the Japanese market, please refer to "安全上のご注意".)
- Do not extend more than one unit out of the rack simultaneously even if the tilt protection is in place. If several units are simultaneously extended out of the rack, there is a risk that the rack could tip over.

Fujitsu rack systems

The rack systems from Fujitsu support the installation of PRIMERGY servers:

- PRIMECENTER rack
- PRIMECENTER M1 rack
- DataCenter rack
- 19-inch standard rack (for the Japanese market)
- 19-inch slimline rack (for the Japanese market)



For information on mounting the server in the rack please refer to the Mounting Instructions provided with the Rack Mounting Kit. Further information you find in the manual of your rack system.

For the Japanese market, please refer also to the "Rack system structure guide."



Online documentation for rack installation can be found on:

<http://manuals.ts.fujitsu.com/index.php?id=5406-5605-5606>
(for the EMEA market)

http://jp.fujitsu.com/platform/server/primergy/manual/peri_rack.html
(for the Japanese market).

To accommodate the ventilation concept and ensure proper ventilation, any unused areas in the rack must be sealed using dummy covers.

The power is supplied via the multiple socket outlets fitted in the rack (for the EMEA market).

Hardware installation

The main features of Fujitsu rack systems are as follows:

- rail systems that can be mounted without tools
- support systems having a linear alignment feature to ensure that they can be adjusted to different rack depths

Asymmetrical PRIMECENTER Rack and DataCenter Rack provide an enhanced cable management in the lateral rack area.

3rd party racks



Installation in most current rack systems from other manufacturers (3rd party racks) is also supported. For details please contact your sales representative.

5.3 Connecting devices to the server

The connectors for external devices are on the front and rear of the server. The additional connectors available on your server depend on the expansion cards installed. For further information refer to the "PRIMERGY RX300 S7 Server Upgrade and Maintenance Manual".

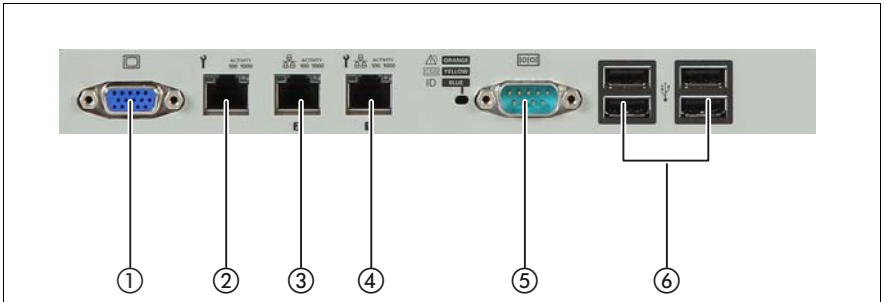

Figure 2: Connection panel on the rear

1	Video connector (blue)	4	Shared LAN connector (LAN 1)
2	Management LAN connector	5	Serial connector COM1* (turquoise)
3	Standard LAN connector (LAN 2)	6	4 USB connectors (black)

* The serial interface COM1 can be used as the standard interface or for communication with iRMC S3.

i Some of the devices that can be connected may require the installation and setting up of special software (e.g. drivers) (see the documentation for the connected device).

► Connect the desired devices to the server.

Hardware installation

One optional video connector (1), one optional Front LAN connector (2) and two additional USB connectors (3) are located on the front of the server (figure 3):



Figure 3: Front side connectors

i If components with large power requirements (e.g. external USB hard disk drives) are connected simultaneously, these USB connectors may be switched off.

Connecting the keyboard, mouse and monitor

- ▶ Connect the monitor, keyboard and mouse to the standard connectors of the server (see table and [figure 2 on page 55](#)).

i If a separate graphics card is installed in a slot, the graphic controller on the system board is automatically deactivated. The corresponding video connector (VGA) can not be used. Plug the data cable of the monitor into the video connector of the graphics card.

- ▶ Connect the power cable of the monitor to the mains socket strip of the rack.



CAUTION!

The rated current for the monitor is indicated on the technical data label on the monitor or in the operating manual for the monitor.

5.4 Connecting the server to the power source

In its basic configuration level the server has a hot-plug power supply unit.

A second hot-plug power supply unit can be added to ensure a redundant power supply. If one power supply unit is defective, the other then guarantees unimpaired operation. Each hot-plug power supply unit can be replaced during operation (see the "PRIMERGY RX300 S7 Server Upgrade and Maintenance Manual").



CAUTION!

The server is automatically set to a mains voltage in the range 100 V - 240 V. You may only operate the server if its rated voltage range corresponds to the local mains voltage.



As an option, the server can be equipped with a DC hot-plug power supply unit that adjusts automatically to any power voltage in the range from -40.5 V to -57 V.

5.4.1 Connecting the server to the mains

- ▶ Connect the power cord with the insulated connector to the power supply unit of the server, and plug the power plug into a grounded outlet on the mains socket strip on the rack (see Technical Manual of the rack).



A phase redundancy in the power supply of the server can be set up if two hot-plug power supply units are installed.

In this case, each of the power supply units is either connected to two different phases or to two separate circuits of the internal power supply network.

5.4.2 Connecting the server to the direct current (optional DC hot-plug power supply unit)

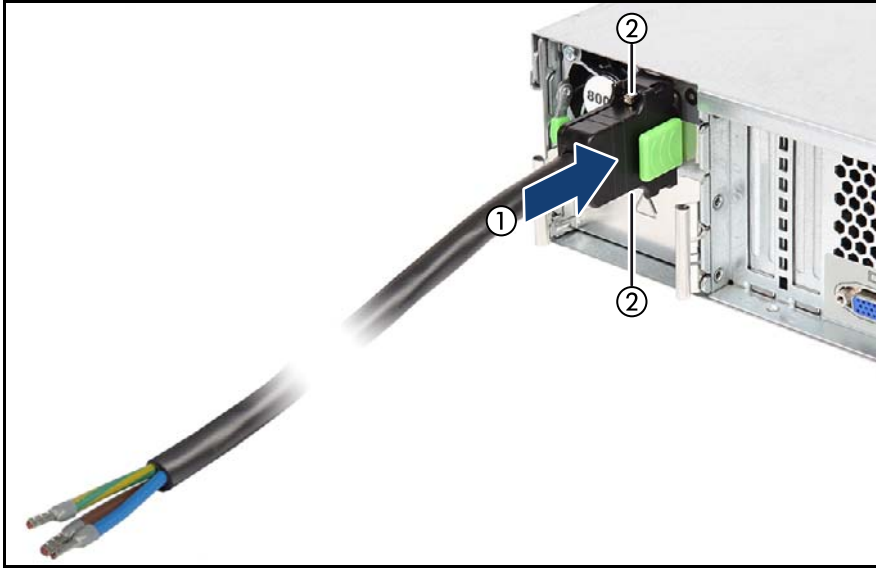

Figure 4: Connecting the server to the dc voltage

- ▶ Connect the power cord with the connector to the power supply unit of the server (1).
- ▶ Attach the connector with the 2 screws (2).
- ▶ Connect the wire labeled "Ground" to an appropriate earth ground.
- ▶ Connect the other two wires of the power cable to the current bar on the rack (see Technical Manual of the rack).

5.4.3 Using the cable clamp

You can secure the power cords in a cable clamp to ensure that the insulated connectors cannot be disconnected from the server accidentally.

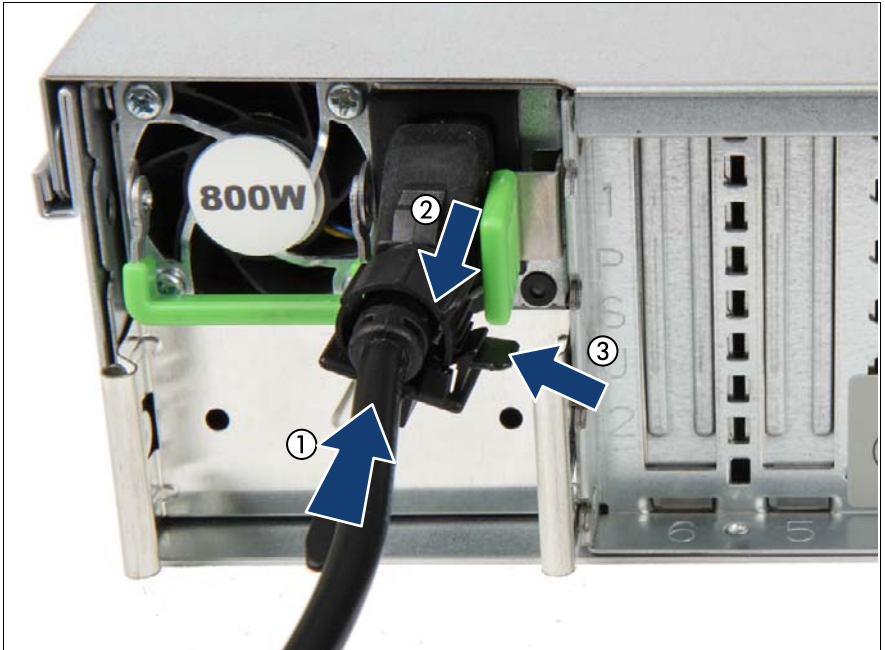

Figure 5: Cable clamp (example AC power supply unit)

- ▶ Pull the cable clamp up (1).
- ▶ Thread the power cord through the cable clamp (2).
- ▶ Press the cable clamp down until it engages to secure the cable (3).

5.5 Notes on connecting/disconnecting cables



CAUTION!

Always read the documentation supplied with the device you wish to connect.

Never connect, or disconnect cables during a thunderstorm.

Never pull on a cable when disconnecting it. Always take hold of the cable by the plug.

Follow the sequence described below to connect or disconnect external devices to or from the server:

Be sure to wait for 10 seconds or more after shutdown before turning the server on.

Connecting cables

- ▶ Turn off all power and equipment switches.
- ▶ Disconnect all power plugs from the properly grounded power outlets.
- ▶ Connect all cables to the server and peripherals.
- ▶ Plug all data communication cables into the utility sockets.
- ▶ Plug all power cords into the properly grounded power outlets.

Disconnecting cables

- ▶ Turn off all power and equipment switches.
- ▶ Disconnect all power plugs from the properly grounded power outlets.
- ▶ Unplug all data communication cables from the utility sockets.
- ▶ Disconnect the relevant cables from the server and all the peripherals.



For connecting or disconnecting LAN cables, the server does not need to be powered off. To avoid loss of data teaming function has to be enabled.

Information for ensuring electromagnetic compatibility

All data and signal cables must have sufficient shielding. The use of cable type S/FTP Cat5 or better is recommended.

Use of unshielded or badly shielded cables may lead to increased emission of interference and/or reduced fault-tolerance of the device.

6 Starting up and operation



CAUTION!

Please note the safety instructions in chapter ["Important information"](#) on page 37

6.1 Controls and indicators

6.1.1 Front of server

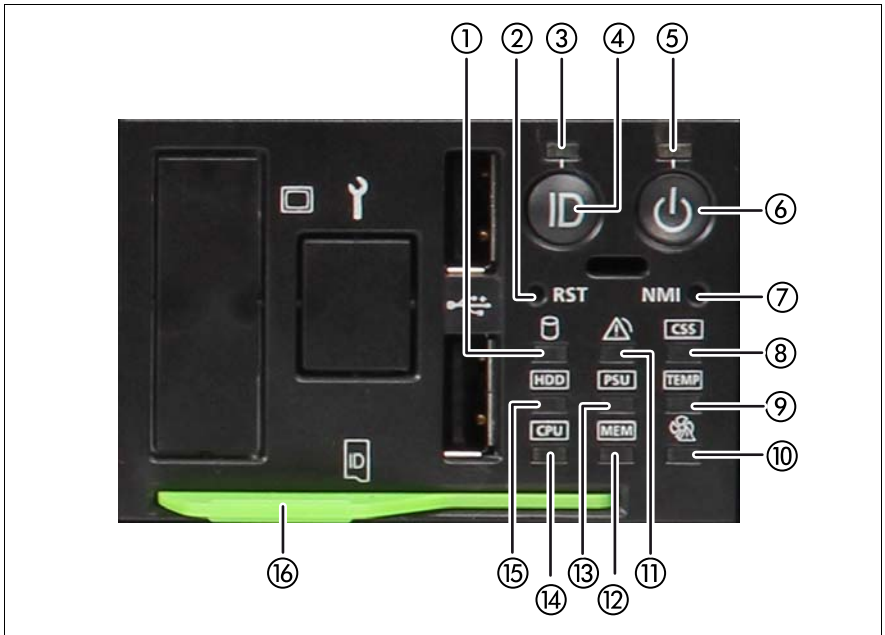

Figure 6: Front side: indicators and controls

1	HDD/SSD activity indicator	5	Power-on indicator
2	Reset button	6	On/Off button
3	ID indicator	7	NMI button
4	ID button	8	CSS indicator

Starting up and operation

9	Temperature error indicator	13	PSU error indicator
10	Fan error indicator	14	CPU error indicator
11	Global Error indicator	15	HDD/SSD error indicator
12	Memory error indicator	16	ID card

ID card

You can pull out the ID card as far as it will go and push it back again.

The ID card contains various system information, such as the product name, serial number, order number, MAC addresses and DNS name (in the Japanese market, only the product name and the serial number).

6.1.1.1 Control elements



On/Off button

When the system is switched off, it can be switched on again by pressing the On/Off button.

When the system is operating, pressing the On/Off button will switch off the system.



CAUTION!

Risk of loss of data!



The On/Off button does not disconnect the server from the mains voltage. To disconnect from the mains completely, remove the power plug(s).

NMI NMI button



CAUTION!

Do not press! Risk of loss of data! The NMI button may only be used by service personnel.

RST Reset button

Pressing the reset button reboots the system.



CAUTION!

Risk of loss of data!

ID ID button

Lights up (blue) on the front and on the rear of the server when the ID button is pressed. Both ID indicators are synchronized.

6.1.1.2 Indicators on the control panel



Power-on indicator (two colors)

Lights up green when the server is switched ON.

Lights up orange when the server is switched OFF, but mains voltage is present (standby mode).



HDD/SSD activity indicator (green)

Lights up green when an internal drive (HDD or backup drive) is being accessed.



Global Error indicator (orange)

- **Lights up orange** if a prefailure event has been detected that requires (precautionary) service intervention.
- **Flashes orange** if an error was detected that requires service intervention.
- **Does not light up** if there is no critical event.

If the event is still acute after a power cycle, the indicator is activated after the restart.

The indicator also lights up in standby mode.

You can find more details on the indicated errors in the System Event Log (SEL), on the ServerView Local Service Panel, in the ServerView Operations Manager or via the iRMC S3's Web interface.

CSS CSS indicator (yellow)

- **Lights up yellow** if a prefailure event was detected for a CSS component that you can fix yourself (for reasons of precaution) with the CSS concept.
- **Flashes yellow** if an error was detected that you can fix yourself with the CSS concept.
- **Does not light up** when the system is OK.

If the event is still acute after a power cycle, the indicator is activated after the restart.

The indicator also lights up in standby mode.

For more information on the CSS concept, see "[Customer Self Service \(CSS\)](#)" on page 15.

ID ID indicator (blue)

Lights up blue when the system has been selected by pressing the ID button. To deactivate, press the button again.

The ID indicator can also be activated via the ServerView Operations Manager and the iRMC S3 Web interface and its status reported to the ServerView Operations Manager and the iRMC S3.

6.1.1.3 Indicators on the drives

Optical drive activity indicator

Lights up green when the storage medium is being accessed.

Hard disk drive indicators



Figure 7: Indicators on the 3.5 inch and 2.5 inch HDD modules

1	LED green	HDD BUSY <ul style="list-style-type: none">– Lights up: HDD in active phase– Does not light: HDD inactive (drive inactive)
2	LED orange	HDD FAULT (orange) (in conjunction with a RAID controller) <ul style="list-style-type: none">– Does not light: no HDD error– Lights up: HDD Faulty or Rebuild Stopped (drive defective/needs replacing, a rebuild process was stopped or the HDD module is not correctly inserted)– Slow flashing: HDD Rebuild (the data is being restored after changing a drive)– Fast flashing: HDD Identify

Solid state disk indicators



Figure 8: Indicators on the SSD modules

1	LED green	BUSY <ul style="list-style-type: none"> – Lights up: SSD in active phase – Does not light: SSD inactive (drive inactive)
2	LED orange	FAULT (orange) (in conjunction with a RAID controller) <ul style="list-style-type: none"> – Does not light: no error – Lights up: Faulty or Rebuild Stopped (drive defective/needs replacing, a rebuild process was stopped or the module is not correctly inserted) – Slow flashing: Rebuild (the data is being restored after changing a drive) – Fast flashing: Identify

6.1.2 Rear of server

CSS, Global Error and ID indicators

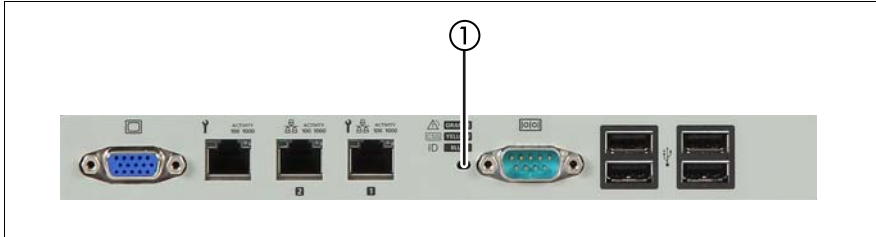

Figure 9: Indicator on the connection panel: Global Error/CSS/ID indicator

1	Global Error/CSS/ID indicator (orange, yellow and blue)
---	---



Global Error indicator (orange)

- **Lights up orange** if a prefailure event has been detected that requires (precautionary) service intervention.
- **Flashes orange** if an error was detected that requires service intervention.
- **Does not light up** if there is no critical event.

If the event is still acute after a power cycle, the indicator is activated after the restart.

The indicator also lights up in standby mode.

You can find more details on the indicated errors in the System Event Log (SEL), on the ServerView Local Service Panel, in the ServerView Operations Manager or via the iRMC S3's Web interface.

CSS CSS indicator (yellow)

- **Lights up yellow** if a prefailure event was detected for a CSS component that you can fix yourself (for reasons of precaution) with the CSS concept.
- **Flashes yellow** if an error was detected that you can fix yourself with the CSS concept.
- **Does not light up** when the system is OK.

If the event is still acute after a power cycle, the indicator is activated after the restart.

The indicator also lights up in standby mode.

For more information on the CSS concept, see ["Customer Self Service \(CSS\)" on page 15](#).

ID ID indicator (blue)

Lights up blue when the system has been selected by pressing the ID button. To deactivate, press the button again.

The ID indicator can also be activated via the ServerView Operations Manager and the iRMC S3 Web interface and its status reported to the ServerView Operations Manager and the iRMC S3.

LAN indicators

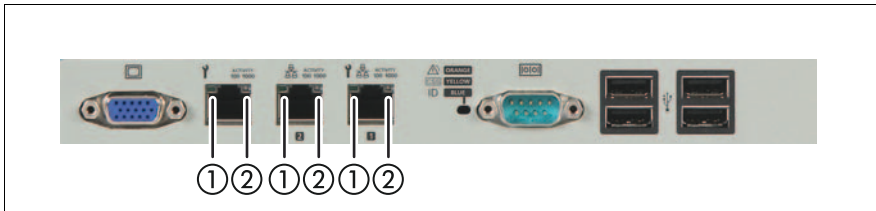

Figure 10: Indicators on the connection panel: LAN indicators

1	LAN link/transfer	Steady green signal when a LAN connection exists. Remains dark when no LAN connection exists. Flashes green when LAN transfer takes place.
2	LAN speed	Steady yellow signal in the event of a LAN transfer rate of 1 Gbit/s Steady green signal in the event of a LAN transfer rate of 100 Mbit/s. Remains dark in the event of a LAN transfer rate of 10 Mbit/s.



Depending on the settings in the BIOS, the standard LAN connector 1 may also be used as a service LAN connector. You will find further information in the "D2939 BIOS Setup Utility for PRIMERGY RX300 S7 Reference Manual".

Indicators on the hot-plug power supply unit



Figure 11: Indicator on hot-plug power supply unit (example AC power supply unit)

1	<p>Indicator on hot-plug power supply unit (two colors)</p> <p>Flashes green when the server is switched off, but voltage is present (standby mode).</p> <p>Lights up green when the server is switched on and functioning properly.</p> <p>Flashes orange when a predictable error has been detected, but the power supply unit is still running.</p> <p>Lights up orange in case of OCP/OVP or when the fan of the power supply unit has failed.</p>
---	--

6.1.3 Indicators of the hot-plug fans

A status indicator (LED on the system board) is assigned to each fan. The status indicators are not visible unless the housing is open. The respective LED is set with commands in Server Management.

LED (orange)	Meaning
does not light up	Fan is operational
flashing	Fan failure
lights up	Fan prefailure

6.2 Switching the server on and off



CAUTION!

- If nothing appears on the screen but flickering stripes after switching on the server, switch the server off immediately (see chapter "[Troubleshooting and tips](#)" on page 85).
- The On/Off button does not disconnect the server from the mains voltage. To completely disconnect it from the mains voltage, remove the power plug(s) from all PSU inlet connectors.
- Do not move, strike, or shake the server when it is turned on. This can damage the hard disk in the server and cause data loss.
- Turn the server on when the temperature is within its operating environment range (10–35°C). For details on the operating environment, refer to "Safety Precautions". When operating the device outside of this operating environment, the server may operate improperly and data loss may occur. Furthermore, Fujitsu cannot be held responsible for any related damage, malfunction, or loss of data, etc.
- Be sure to wait for 10 seconds or more after shutdown before turning the server on again.
- After connecting all power cords, wait at least 10 seconds before pressing the On/Off button.

Switching the server on

The Power-on indicator lights up orange (standby mode) when the server is connected to the mains.



The controls and indicators are shown in figure [6 on page 63](#).

– Starting up for the first time:

For the Japanese market, please refer to "はじめにお読みください".

- ▶ Press the On/Off button.
- ▶ Insert ServerView Suite DVD 1 in the DVD drive.

Starting up and operation

- ▶ Follow the on-screen instructions (see also section ["Configuring the server and installing the operating system with the ServerView Installation Manager" on page 80](#) or section ["Configuring the server and installing the operating system without the ServerView Installation Manager" on page 81](#)).
- **System already installed:**
 - ▶ Press the On/Off button.

The server is switched on, performs a system test and boots the operating system.



In the case of configurations with a large memory size, the boot process may be prolonged and the screen may remain dark for several minutes.

Switching the server off

The Power-on indicator (see figure [6 on page 63](#)) lights up green.

- ▶ Shut down the operating system properly.

The server is switched off automatically and enters standby mode. The power-on indicator lights up orange.



If the operating system does not switch off the server automatically, press the On/Off button for at least four seconds and/or send a corresponding control signal for power button override.

Other On/Off options

Besides the On/Off button, the server can be switched ON and OFF in the following ways:

- **Timer-controlled switch-on/off**

Using the ServerView Operations Manager or iRMC S3, you can configure that the server is switched on/off controlled by an internal timer.

- **Ring indicator**

The server is switched on by an internal or external modem.

- **Wake up On LAN (WOL)**

The server is switched on by a command via the LAN (Magic Packet™).

- **After power failure**

The server automatically reboots following a power failure (depending on the settings in the BIOS or in iRMC S3).

– Power button override

The system can be switched off (hard power off) by keeping the On/Off button (approximately 4 - 5 seconds).



CAUTION!

There is a risk that data may be lost.

– iRMC S3

iRMC S3 offers various options for switching the server on and off, e.g. via the *Power On Off* page of the iRMC S3 Web interface.



CAUTION when turning off the power (Windows Server 2008)!

The operation of the power switch can be specified as "Do Nothing", "Stand by", "Hibernate", and "Shutdown" depending on the OS settings. The default is "Shutdown".

On this server, functions corresponding to "Stand by" and "Hibernate" are supported as BIOS and hardware functions. However, some drivers and software installed in the server do not support these functions. For this reason, functions corresponding to "Stand by" and "Hibernate" are unavailable on this server. When the operating mode is set to "Stand by" or "Hibernate", the system may operate improperly or hard disk data may be corrupted.

For details about operating mode settings, refer to the manual supplied with the OS.





6.3 Configuring the server

This section contains information about configuring the server and installing the operating system.

-  Make sure that the power saving functions are disabled in the *Power* menu of the BIOS Setup during operation.

6.3.1 Configuring the onboard SAS/SATA controller

A SAS/SATA controller is integrated on the system board. You can configure the onboard controller either before or during installation with the ServerView Installation Manager. Using the ServerView Installation Manager is recommended.

-  The controller has its own configuration utility. For further information, refer to the “Embedded MegaRAID Software User’s Guide” (on the ServerView Suite DVD 2 under *Industry Standard Servers - Expansion Cards - Storage Adapters - LSI SAS / SCSI RAID Controllers*).
-  The SAS functionality needs to be enabled separately by using a onboard SAS enabling key.
-  Descriptions of operating systems not covered in the controller manual are provided in the corresponding readme under:
<http://www.fujitsu.com/global/services/computing/server/ia/driver/index.html>
(for the EMEA market).
<http://www.fmworld.net/cgi-bin/drviasearch/drviaindex.cgi>
(for the Japanese market).
-  In the system BIOS the onboard SAS/SATA controller can be configured as "RAID" (default) or "non-RAID".

6.3.2 Configuring the SAS/SATA RAID controller

The server has a SAS/SATA RAID controller with "MegaRAID functionality". You can configure the SAS/SATA RAID controller either before or during installation with the ServerView Installation Manager. Using the ServerView Installation Manager is recommended.

 A separate utility is available to the controller for MegaRAID configuration. For further information, refer to the "SAS Software User's Guide" (on the ServerView Suite DVD 2 under *Industry Standard Servers - Expansion Cards - Storage Adapters - LSI Configuration Software*).

Further information on modular RAID controllers is provided in the "Modular RAID Controller Installation Guide" (on the ServerView Suite DVD 2 under *Industry Standard Servers - Expansion Cards - Storage Adapters - LSI SAS / SCSI RAID Controllers*).

 Descriptions of operating systems not covered in the controller manual are provided in the corresponding readme under:

<http://www.fujitsu.com/global/services/computing/server/ia/driver/index.html>
(for the EMEA market).

<http://jp.fujitsu.com/platform/server/primergy/downloads/>
(for the Japanese market).

6.3.3 Configuring the server and installing the operating system with the ServerView Installation Manager

Using the ServerView Installation Manager on the ServerView Suite DVD 1 provided, you can conveniently configure the server and install the operating system. This includes configuring the server-specific settings using the ServerView Configuration Manager and configuring the RAID controller using the **ServerView RAID Manager**.

Advantages of the ServerView Installation Manager

- Wizard assisted configuration of your server hardware and disk arrays
- Wizard assisted installation of all leading server operating systems
- Wizard-assisted creation of configuration files for unattended installation of several PRIMERGY servers with identical hardware configurations.
- Installation of drivers and additional software.



The software that can be installed depends on your server's hardware configuration. This configuration is detected automatically.



Descriptions of operating systems not covered in the RAID controller manual are provided in the corresponding readme files under:

<http://www.fujitsu.com/global/services/computing/server/ia/driver/index.html>
(for the EMEA market).

<http://jp.fujitsu.com/platform/server/primergy/downloads/>
(for the Japanese market).

To find out how to operate the ServerView Installation Manager and for further information, refer to the associated manual.

If you are using the ServerView Installation Manager, you can skip the following section on how to configure the server and install the operating system.

Continue from section "[Cleaning the server](#)" on page 82.

6.3.4 Configuring the server and installing the operating system without the ServerView Installation Manager

Configuring SAS/SATA RAID controller with "Integrated Mirroring Enhanced"

Configure the controller as described in section "[Configuring the SAS/SATA RAID controller](#)" on page 79.

Configuring SAS/SATA RAID controller with "MegaRAID functionality"

Configure the controller as described in section "[Configuring the SAS/SATA RAID controller](#)" on page 79.

Installing the operating system

- ▶ Insert the CD/DVD for the operating system you want to install.
- ▶ Reboot the server.
- ▶ Follow the instructions on screen and in the manual for the operating system.

6.4 Cleaning the server



CAUTION!

Switch off the server and disconnect the power plugs from the properly grounded power outlets.

Do not clean any interior parts yourself; leave this job to a service technician.

Do not use any cleaning agents that contain abrasives or may corrode plastic.

Ensure that no liquid enters the system. Ensure that the ventilation areas of the server and the monitor are clear.

Do not use any cleaning sprays (including flammable types). It may cause a device failure or a fire.

Clean the keyboard and the mouse with a disinfecting cloth.

Wipe the server and monitor casing with a dry cloth. If particularly dirty, use a cloth that has been moistened in a mild domestic detergent and then carefully wrung out.

7 Property and data protection

The rack model is protected against unauthorized access by a lockable rack door.

To protect your system and data internally against unauthorized access, you can use the BIOS Setup security functions.

7.1 BIOS Setup security functions

The *Security* menu in BIOS Setup offers various options for protecting your data from unauthorized access. By combining these options, you can also achieve optimum protection for your system.



A detailed description of the *Security* menu and how to assign passwords can be found in the "D2939 BIOS Setup Utility for PRIMERGY RX300 S7 Reference Manual".

8 Troubleshooting and tips



CAUTION!

Follow the safety instructions in the "Safety notes and regulations" manual or "安全上のご注意" and in chapter ["Important information" on page 37](#).

If a fault occurs, attempt to resolve it using the measures described:

- in this chapter,
- in the documentation for the connected devices,
- in the help systems of the software used.

If you fail to correct the problem, proceed as follows:

- ▶ Make a list of the steps performed and the circumstances that led to the fault. Also make a list of any error messages that were displayed.
- ▶ Switch off the server.
- ▶ Contact our customer service team.

8.1 Power-on indicator remains unlit

The power-on indicator remains dark after you switch on your device.

Power cable incorrectly connected

- ▶ Make sure that the power cable(s) is/are correctly connected to the server and the grounded power outlet(s).

Power supply overloaded

- ▶ Disconnect the server power plug(s) from the grounded power outlet(s).
- ▶ Wait a few minutes before you plug it/them into the grounded power outlet(s) again.
- ▶ Switch on your server.

8.2 Server switches itself off

Server Management has detected an error

- ▶ Check the error list of System Event Log in ServerView Operations Manager or in the iRMC S3 web interface, and attempt to eliminate the error.

8.3 Screen remains blank

Monitor is switched off

- ▶ Switch on your monitor.

Screen has gone blank

- ▶ Press any key on the keyboard.
or
- ▶ Deactivate screen saver. Enter the appropriate password.

Brightness control is set to dark

- ▶ Set the brightness control on the monitor to light. For detailed information, refer to the operating manual supplied with your monitor.

Power cable or monitor cable not connected

- ▶ Switch off the monitor and the server.
- ▶ Check whether the power cable is properly connected to the monitor and to the grounded power outlet.
- ▶ Check whether the monitor cable is properly connected to the server and monitor (if it is plugged in with a connector). If a separate graphics card is installed in the server, then the monitor cable must be connected to the graphics card.
- ▶ Switch on the monitor and the server.

8.4 Flickering stripes on monitor screen



CAUTION!

Switch off the server immediately. Risk of damaging the server.

Monitor does not support the set horizontal frequency

- ▶ Find out which horizontal frequency your monitor screen supports. You will find the horizontal frequency (also known as line frequency or horizontal deflection frequency) in the documentation for your monitor.
- ▶ Refer to the documentation for your operating system or the software for the screen controller for details of how to set the correct horizontal frequency for your monitor, and follow the procedure accordingly.

8.5 No screen display or display drifts

The wrong horizontal frequency or resolution has been selected for the monitor or for the application program.

- ▶ Find out which horizontal frequency your monitor screen supports. You will find the horizontal frequency (also known as line frequency or horizontal deflection frequency) in the documentation for your monitor.
- ▶ Refer to the documentation for your operating system or the software for the screen controller for details of how to set the correct horizontal frequency for your monitor, and follow the procedure accordingly.

8.6 Incorrect date and time

- ▶ Set the date and time in the operating system or in the BIOS Setup under the Main menu, using System Date and System Time respectively.

i Note that the operating system may affect the system time. For example, the operating system time may deviate from the system time under Linux, and would overwrite the system time in the default setting on shutdown.

If the date and time are still wrong after the server has been switched off and back on again, replace the lithium battery (for a description refer to the PRIMERGY RX300 S7 Server Upgrade and Maintenance Manual) or contact our customer service team.

8.7 System will not boot

The system will not boot after installing a new hard disk drive.

SAS configuration incorrect

- ▶ Check the settings for the hard disk drives (SAS Device Configuration) and the additional settings in the SAS configuration menu.

8.8 Drives reported as "dead" when starting system

This error message may occur when the drives are operated with a RAID controller.

RAID controller configuration incorrect

- ▶ Check and correct the settings for the drives using the RAID controller utility.

Further information is provided in the manual for the RAID controller.

8.9 Added drive reported as defective

RAID controller is not configured for this drive

The drive was probably installed when the system was switched off.

- ▶ Reconfigure the RAID controller for the drive using the corresponding utility. Information is provided in the documentation for the RAID controller.

or

- ▶ Remove and reinstall the drive while the system is switched ON.

If the drive continues to be shown as defective, then replace it.

8.10 Error message on screen

The meaning of the error message is explained in the documentation for the relevant components and programs on the ServerView Suite DVD 2.

8.11 Expansion cards or onboard devices not recognized

When an expansion card is added, other expansion cards or onboard devices might not be recognized.

- ▶ Reinstall the drivers for the expansion cards or onboard devices that are not recognized.

8.12 Temperature warning

A temperature warning is output to the hardware event log and OS event log, or ServerView issues a notification of a temperature warning such as by a popup message

The above log is output or the above notification is issued by ServerView when the ambient temperature is within 30 to 35°C, which is near the upper limit of the temperature boundaries (10 to 35°C). This is to notify the administrator before the ambient temperature actually exceeds the range of the temperature boundaries.

- ▶ Although continued use within the temperature boundaries poses no problems within itself, reconsider the surrounding environment conditions if this log is output or if ServerView issues this notification.

8.13 No effect of keyboard or mouse

Typing the keyboard does not display any characters, or the mouse cursor does not move.

- ▶ Check to see whether the keyboard and mouse are connected properly. If they are not connected or you replaced them yourself, then connect the cables to the server.

8.14 Optical drive cannot read data

- ▶ Check to see whether the CD/DVD/BD is inserted properly. If the CD/DVD/BD is not inserted, correctly insert the disk so that the label is facing up.
- ▶ Check to see whether the CD/DVD/BD is not dirty. If the CD/DVD/BD is dirty, wipe it in a radial way with a soft, dry cloth.
- ▶ Check to see whether the CD/DVD/BD is not scratched or bent. If scratched or damaged, replace the CD/DVD/BD.