

TravelMate B113 Series
SERVICE GUIDE

acer

Table of Contents

Chapter 1. Hardware Specifications and Configurations

Features	1-2
Notebook Tour	1-6
Top View	1-6
Front View	1-7
Left View	1-8
Right View	1-9
Base View	1-10
Touchpad Basics	1-11
Keyboard Basics	1-12
System Block Diagram	1-15
Specifications Table	1-16

Chapter 2. System Utilities

BIOS Setup Utility	2-2
Navigating the Bios Setup Utility	2-2
BIOS	2-3
Information	2-3
Main	2-5
Security	2-7
Boot	2-11
Exit	2-12
BIOS Flash Utilities	2-13
DOS Flash Utility	2-14
WinFlash Utility	2-17
Miscellaneous Tools	2-20
Using DMI Tools	2-20
HDD/BIOS Password	2-22
Unlocking the HDD	2-22
Clearing the Password Check and BIOS Password	2-24
Crisis Utility SOP	2-26
When to Use the Crisis SOP	2-26
Creating a USB Flash Crisis Disk	2-26
Using the Crisis Utility Disk	2-28

Chapter 3. Jumper and Connector Locations

Mainboard Top View	3-2
Mainboard Bottom View	3-3
LED Board View	3-4
IO Board View	3-5
HDD Board View	3-6
Clear CMOS Jumper	3-7

Chapter 4. Troubleshooting

General Information	4-2
Power On Issues	4-3
No Display Issues	4-4
LCD Picture Failure	4-6
Internal Keyboard Failure	4-7
Touchpad Failure	4-8
Internal Speaker Failure	4-9

Internal Microphone Failure	4-11
USB Failure (USB 2.0)	4-12
Wireless/BT Function Test Failure	4-13
2-in-1 Card Function Test Failure	4-14
Unit Thermal Failure	4-15
Cosmetic Failure	4-16
Other Functions Failure	4-17
BIOS Problems	4-17
Intermittent Problems	4-18
Undetermined Problems	4-18

Chapter 5. Service and Maintenance

Introduction	5-3
Recommended Equipment	5-3
Maintenance Flowchart	5-4
Getting Started	5-6
Battery Pack Removal	5-7
Battery Pack Installation	5-8
Dummy Card Removal	5-9
Dummy Card Installation	5-10
Base Door Removal	5-11
Base Door Installation	5-13
HDD Module Removal	5-15
HDD Module Installation	5-16
HDD Board Removal	5-17
HDD Board Installation	5-19
Fan Removal	5-21
Fan Installation	5-23
DIMM Module Removal	5-25
DIMM Module Installation	5-26
WLAN Module Removal	5-27
WLAN Module Installation	5-29
Upper Case Removal	5-31
Upper Case Installation	5-36
Mainboard Removal	5-39
Mainboard Installation	5-41
IO Board Removal	5-43
IO Board Installation	5-45
LED Board Removal	5-47
LED Board Installation	5-49
Speaker Removal	5-51
Speaker Installation	5-53
Keyboard Removal	5-55
Keyboard Installation	5-57
Touchpad Removal	5-59
Touchpad Installation	5-61
Thermal Module Removal	5-63
Thermal Module Installation	5-64
LCD Module Removal	5-66
LCD Module Installation	5-69
DC-In Cable Removal	5-72
DC-In Cable Installation	5-73
LCD Bezel Removal	5-74
LCD Bezel Installation	5-76
LCD Panel Removal	5-78

LCD Panel Installation	5-82
CCD Module Removal	5-86
CCD Module Installation	5-87
LCD Panel Brackets Removal	5-88
LCD Panel Brackets Installation	5-89
Microphone Removal	5-90
Microphone Installation	5-91
WLAN Antenna (Main) Removal	5-92
WLAN Antenna (Main) Installation	5-94
WLAN Antenna (Auxiliary) Removal	5-96
WLAN Antenna (Auxiliary) Installation	5-97

Chapter 6. FRU (Field Replaceable Unit) List

Exploded Diagram	6-3
Main Assembly	6-3
Lower Case Assembly	6-5
Upper Case Assembly	6-6
LCD Assembly	6-8
HDD Assembly	6-10
FRU List	6-11
Screw List	6-16

Chapter 7. Test Compatible Components

Microsoft® Windows® 7 Environment Test	7-2
TravelMate B113 Series	7-2

Chapter 8. Online Support Information

Introduction	8-2
------------------------	-----

Revision History

Please refer to the table below for the updates made on this service guide.

Date	Chapter	Updates

Service guide files and updates are available on the Acer/CSD website. The information in this guide is subject to change without notice.

Copyright

Copyright © 2012 by Acer Incorporated. All rights reserved. No part of this publication may be reproduced, transmitted, transcribed, stored in a retrieval system, or translated into any language or computer language, in any form or by any means, electronic, mechanical, magnetic, optical, chemical, manual or otherwise, without the prior written permission of Acer Incorporated.

Disclaimer

The information in this guide is subject to change without notice.

Acer Incorporated makes no representations or warranties, either expressed or implied, with respect to the contents hereof and specifically disclaims any warranties of merchantability or fitness for any particular purpose. Any Acer Incorporated software described in this manual is sold or licensed "as is". Should the programs prove defective following their purchase, the buyer (and not Acer Incorporated, its distributor, or its dealer) assumes the entire cost of all necessary servicing, repair, and any incidental or consequential damages resulting from any defect in the software.

Acer is a registered trademark of Acer Corporation.
Intel is a registered trademark of Intel Corporation, Inc.
Other brand and product names are trademarks and/or registered trademarks of their respective holders.

Conventions

The following conventions are used in this manual:

WARNING:

Indicates a potential for personal injury.

CAUTION:

Indicates a potential loss of data or damage to equipment.

IMPORTANT:

Indicates information that is important to know for the proper completion of a procedure, choice of an option, or completing a task.

NOTE:

Gives bits and pieces of additional information related to the current topic.

The following typographical conventions are used in this document:

- Book titles, directory names, file names, path names, and program/process names are shown in *italics*.

Example:

the DRS5 User's Guide
/usr/local/bin/fd
the /TPH15spool_M program

- Computer output (text that represents information displayed on a computer screen, such as menus, prompts, responses to input, and error messages) are shown in constant width.

Example:

```
[01] The server has been stopped
```

- User input (text that represents information entered by a computer user, such as command names, option letters, and words) are shown in constant width **bold**. Variables contained within user input are shown in square brackets ([]).

Example:

At the prompt, type run [**file name**] **-m**

- Keyboard keys are shown in bold italics.

Example:

After entering data, press ***Enter***.

- Screen output (text that represents information displayed on the system, such as menus, prompts, responses to input, and error messages) are shown in bold.

Example:

On the main menu, select **OK**.

General Information

This Service Guide provides all technical information relating to the basic configuration for Acer's global product offering. To better fit local market requirements and enhance product competitiveness, your regional office may have decided to extend the functionality of a machine (e.g. add-on card, modem, or extra memory capabilities). These localized features are not covered in this generic service guide. In such cases, contact your regional offices or the responsible personnel/channel to provide you with further technical details.

When ordering FRU parts:

Check the most up-to-date information available on your regional web or channel. If, for whatever reason, a part number change is made, it may not be noted in this printed service guide.

For Acer-authorized service providers:

Your Acer office may have a different part number code than those given in the FRU list of this printed service guide. The list provided by your regional Acer office must be used to order FRU parts for repair and service of customer machines.

Hardware Specifications and Configurations

Hardware Specifications and Configurations	1-2
Features	1-2
Notebook Tour	1-6
Top View	1-6
Front View	1-7
Left View	1-8
Right View	1-9
Base View	1-10
Touchpad Basics	1-11
Keyboard Basics	1-12
System Block Diagram	1-15
Specifications Table	1-16

Hardware Specifications and Configurations

Features

The following is a summary of the computer's many features:

Operating System

- Genuine Windows® 7 Home Basic (32-bit)
- Genuine Windows® 7 Home Premium (64-bit)
- Genuine Windows® 7 Professional (32-bit)
- Genuine Windows® 7 Professional (64-bit)
- Genuine Windows® XP Professional
- Linpus
- Support Genuine Windows® 8

Platform

- Mobile Intel® HM77/70 Express Chipset
- Intel® Core™ i7-3667U Dual Core processor (3 MB L3 cache, 2.0GHz with Turbo Boost up to 3.20GHz, DDR3 1333 MHz, 17 W), supporting Intel® 64 architecture, Intel® Smart Cache
- Intel® Core™ i5-2467M / i5-3317U Dual Core processor (3 MB L3 cache, 1.60GHz / 1.70GHz with Turbo Boost up to 1.15GHz / 2.40GHz, DDR3 1333 MHz, 17 W), supporting Intel® 64 architecture, Intel® Smart Cache
- Intel® Core™ i3-2367M / i3-2377M / i3-3217U Dual Core processor (3 MB L3 cache, DDR3 1333 MHz, 17 W), supporting Intel® 64 architecture, Intel® Smart Cache
- Intel® Pentium™ 967 / 987 Dual Core processor (2 MB L3 cache, DDR3 1333 MHz, 17 W), supporting Intel® 64 architecture, Intel® Smart Cache
- Intel® Celeron™ 877 Dual Core processor (2 MB L3 cache, DDR3 1333 MHz, 17 W), supporting Intel® 64 architecture, Intel® Smart Cache

System Memory

Dual-channel DDR3 SDRAM support:

- Up to 4 GB of DDR3 system memory, upgradable to 8 GB using two soDIMM modules

Display

- 11.6" HD 1366 x 768 resolution
- LED-backlight TFT LCD
- Mercury-free, environment-friendly
- 16:9 aspect ratio

Privacy Control

- BIOS user, supervisor, HDD passwords
- Kensington lock slot

Storage Subsystem

- Hard Disk Drive
 - 320/500GB or larger
- 2-in-1 card reader, supporting:
 - Secure Digital™ (SD) Card, MultiMedia Card™ (MMC)

Graphics

- Dual independent display support
- 16.7 million colors
- External resolution / refresh rates:
 - HDMI® port up to 1920 x 1080: 60 Hz
- MPEG-2/DVD decoding
- WMV9 (VC-1) and H.264 (AVC) decoding
- HDMI® (High-Definition Multimedia Interface) with HDCP (High-bandwidth Digital Content Protection) support

Audio Subsystem

- High-definition audio support
- Two built-in stereo speakers
- MS-Sound compatible
- Built-in microphone

Communication

Webcam

- High-definition Camera

WLAN

- 802.11 a/g/n+BT4.0 combo module

WPAN

- Bluetooth® 4.0

LAN

- Gigabit Ethernet, Broadcom BCM57785 (LAN + Card Reader)

Dimensions and Weight

Dimension

- 285 (L) x 202 (W) x 20.95 (H) mm (11.22 x 7.95 x 0.82 inches)

Weight

- 1.4 kg (3.09 lbs.) with 4-cell battery pack

Power Adapter and Battery

- ACPI 2.0 CPU power management standard: supports Standby and Hibernation power-saving modes

Battery

- 37W 2500mAh 4-cell Li-Polymer battery pack
- Battery life: 5.2 hours for Core i CPU; 4.2 hours for ICP and PDC CPU @MM07 utility
- ENERGY STAR®

Power Adapter

- 40W / 19V AC adapter
- Voltage range/frequency: 100 ~ 240V AC, 50/60 Hz

I/O Ports

- 2-in-1 card reader
- One USB 3.0 port with Two USB 2.0 ports for HM70 SKU
- Three USB 2.0 ports for HM77 SKU
- HDMI[®] port with HDCP support
- One Headphone jack, supporting 3.5 mm headset, Universal jack
- One Ethernet (RJ-45) port
- DC-in jack for AC adapter
- One VGA port (D-sub), 15-pin
- One Kensington Lock

Special Keys and Controls

Keyboard

- 84 / 85 / 88-key Fine Tip keyboard
- International language support

Touchpad

- Multi-gesture touchpad, supporting two-finger scroll, pinch, rotate, accidental cursor jumps, page flipping

Environment

Temperature

- Operating: 0° C to 40° C
- Non-operating: -20°C to 85°C

Humidity (non-condensing)

- Operating: 8% to 90%
- Non-operating: 5% to 95%

Warranty

- One-year International Travellers Warranty (ITW)

Optional Accessories

- 1/2/4 GB DDR3 soDIMM module
- 40W / 19V AC adapter
- 4-cell Li-ion battery pack

Notebook Tour

Top View





Figure 1:1. Top View

#	Icon	Item	Description
1		Webcam	Web camera used for video communications.
2		Microphone	Receives audio input for sound recording or voice chatting.
3	⏻	Power Button	Press to turn on the system.
4		Touchpad	Touch-sensitive pointing device that functions like a computer mouse.
5		Keyboard	Use to enter data into the computer.
6		Display Screen	Also called Liquid-Crystal Display (LCD) screen, displays computer output.

Front View



Figure 1:2. Closed Front View

#	Icon	Item	Description
1		2-in-1 Card Reader	Insert a memory card such as Secure Digital (SD) and MultiMedia Card (MMC) for external storage. ⇒ NOTE: Only one card can be inserted at a time.
2		Power Indicator	Indicates the computer power status: <ul style="list-style-type: none"> • Off: System is off. • Blue: System is on. • Amber (flashing): S3 state
		Battery Indicator	Indicates the computer battery status: <ul style="list-style-type: none"> • Amber (flashing): Battery low. • Amber: Battery is charging. • Blue: Battery is fully charged.

Left View

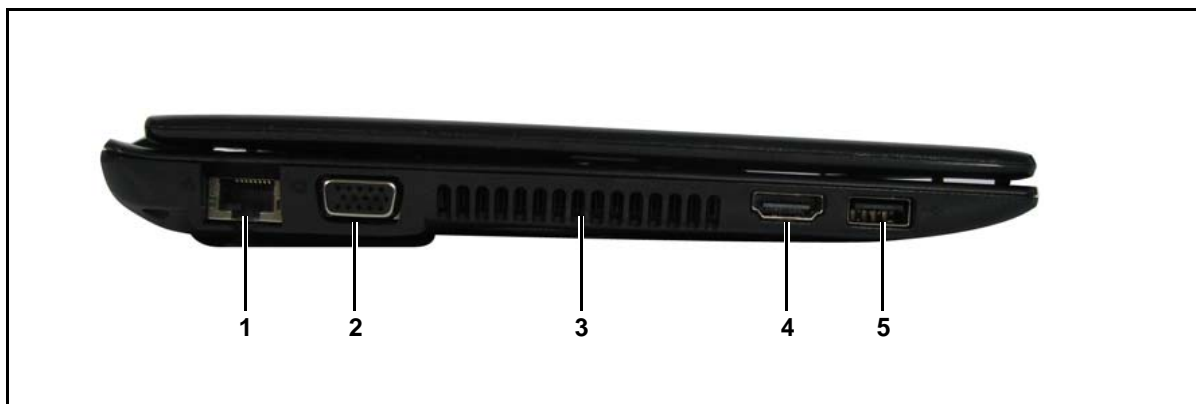









Figure 1:3. Left View

#	Icon	Item	Description
1		Ethernet (RJ-45) Port	Connects to an Ethernet 10/100/1000-based network.
2		VGA Port	Connects to a VGA cable for external video output.
3		Air Vents	Use for air flow. ⚠ CAUTION: Do not cover the air vents.
4	HDMI	HDMI Port	Supports high-definition digital video connections.
5		USB Ports	Connects to USB 2.0 devices (AO756). Connects to USB 3.0 devices (V5-171).

Right View

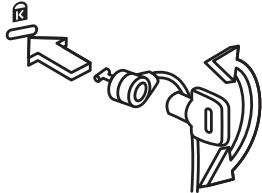

Figure 1:4. Right View

#	Icon	Item	Description
1		Headset Jack	Connects to a headset.
2		USB Ports	Connects to USB 2.0 devices.
3		DC-In Jack	Connects to an AC adapter.
4		Kensington Lock Slot	<p>Connects to a Kensington-compatible computer security lock.</p> <p>⇒ NOTE: Wrap the computer security lock cable around an immovable object such as a table or handle of a locked drawer. Insert the lock into the notch and turn the key to secure the lock. Some keyless models are also available.</p> 

Base View



Figure 1:5. Base View

#	Icon	Item	Description
1		Battery Bay	Houses the computer battery pack.
2		Battery Release Latch	Insert a suitable tool into the latch and slide to release the battery.
3		Base Door	Houses the computer HDD, main memory, and antenna module.

Touchpad Basics

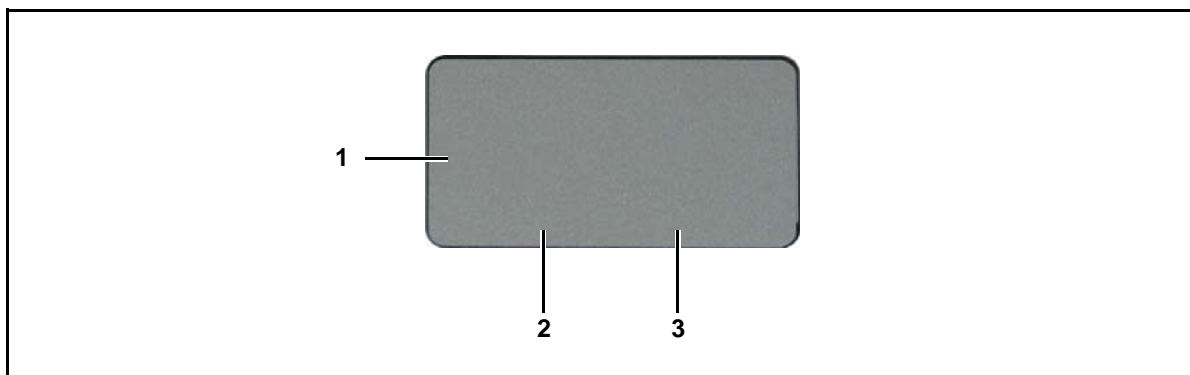

Figure 1:6. Touchpad

#	Item	Description
1	Touchpad	Move your finger across the touchpad to move the cursor. Tapping on the touchpad is the same as clicking the left mouse button.
2	Left Button	Press the left button to perform selection and execution functions. This button is equivalent to the left button on a mouse.
3	Right Button	Press the right button to perform selection and execution functions. This button is equivalent to the right button on a mouse.

Using the Touchpad

⇒ NOTE:

- The touchpad is sensitive to finger movements; hence, the lighter the touch, the better the response. Tapping too hard will not increase the touchpad sensitiveness.
- When using the touchpad, keep the touchpad and your fingers dry and clean.

Below is a description of basic touchpad operations:



Table 1:1. Touchpad Operations

Function	Touchpad	Left Button	Right Button
Execute	Tap twice (same speed as double-clicking a mouse button).	Quickly click twice.	
Select	Tap once.	Click once.	
Drag	Tap twice; on the second tap, rest your finger on the touchpad and drag the cursor.	Press and hold, then use your finger on the touchpad to drag the cursor.	
Access context menu			Click once.

Keyboard Basics

















Figure 1:7. Keyboard

#		Item	Description
1		Caps Lock Key	When Caps Lock is on, all alphabetic characters are typed in uppercase.
2	Fn	Function Key	Use with other key combinations to perform special functions.
3		Windows Key	<ul style="list-style-type: none">Press to launch the Start menu.When used with other keys, provides a variety of functions. See Windows Key on page 1-13.
4		Application Key	Press to open the context menu of the current application. This key has the same effect as clicking the right mouse button.

Windows Key

The table below shows the different functions that Windows key combinations can do:











Table 1:2. Windows Key Combinations

Key Combination	Description
	Opens or closes the Start menu.
 + <R>	Opens the Run dialog box.
 + <M>	Minimizes all windows.
<Shift> +  + <M>	Undo immunize all windows.
 + <F1>	Shows the help window.
 + <E>	Opens Windows Explorer.
 + <F>	Searches for a file or folder.
 + <D>	Shows the desktop.
 + <L>	Locks the computer (if you are connected to a network domain), or switch users (if you are not connected to a network domain).
<CTRL> +  + <F>	Searches for computers (if you are on a network).
<CTRL> +  + <TAB>	Moves focus from the Start menu to the Quick Launch toolbar and to the system tray. Use the right and left arrow keys to move focus to items on the Quick Launch toolbar and the system tray.
 + <TAB>	Cycles through programs on the toolbar.
 + <Pause Break>	Displays the system properties dialog box.
 + <U>	Opens Ease of Access Center (for Windows XP only).

Hotkeys

Hotkeys or function key combinations can be used to access computer control functions such as screen brightness, volume, and multimedia playback controls.

Table 1:3. Hotkey Combinations

Function	Key Combination	Icon	Description
Communication Switch	<Fn> + <F3>		Enables/disables wireless connectivity of your computer.
Sleep	<Fn> + <F4>		Puts the computer in Sleep mode.
Display Toggle	<Fn> + <F5>		Switches the display output between the display screen, external monitor (if connected), and both.
Screen Blank	<Fn> + <F6>		Turns the display screen backlight off to save power. Press any key to return.
Touchpad Toggle	<Fn> + <F7>		Turns the touchpad on and off.
Speaker Toggle	<Fn> + <F8>		Turns the speaker on or off.
Num Lock	<Fn> + <F11>	NumLk	Turns num lock on or off.
Scroll Lock	<Fn> + <F12>	Scr Lk	Turns scroll lock on or off.
Volume Up	<Fn> + Up key		Increases audio volume.
Volume Down	<Fn> + Down key		Decreases audio volume.
Brightness Up	<Fn> + Right key		Increases screen brightness.
Brightness Down	<Fn> + Left key		Decreases screen brightness.
Home	<Fn> + <Pg Up>		Goes to the start of a line.
End	<Fn> + <Pg Dn>		Goes to the end of a line.
D2D Recovery	<Alt> + <F10>		Enter D2D recovery during POST

System Block Diagram

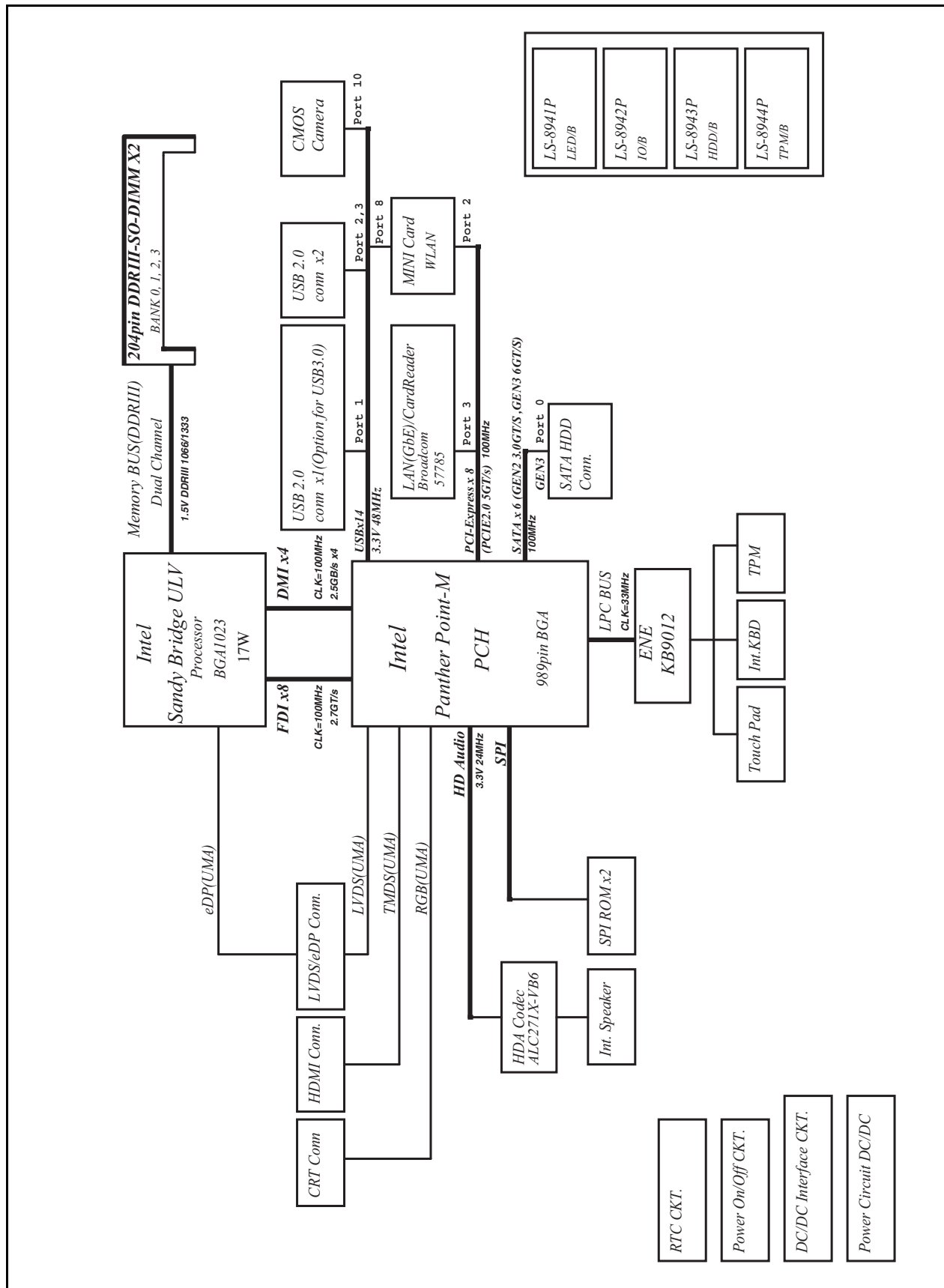

Figure 1:8. System Block Diagram

Specifications Table

Computer specifications

Item	Metric	Imperial
Dimensions		
Length	285 mm	11.22 in
Width	202 mm	7.95 in
Height (front to rear)	20.95 mm	0.82 in
Weight (equipped with optical drive, flash drive, and battery)	1.4 kg	3.09 lbs
Input power		
Operating voltage	18.55 V ~ 19.95V	
Operating current	40W: 2.15A (Max)	
Temperature		
Operating (not writing to optical disc)	0°C ~ 40°C	32°F ~ 104°F
Operating (writing to optical disc)	N/A	N/A
Non-operating	-20°C ~ 85°C	-4° ~ 185°F
Relative humidity		
Operating	8% ~ 90%	
Non-operating	5% ~ 95%	
Maximum altitude (unpressurized)		
Operating	-15 m ~ 3,048 m	-50 ft ~ 10,000 ft
Non-operating	-15 m ~ 12,192 m	-50 ft ~ 40,000 ft
Shock		
Operating	60 g, 11 ms, half-sine	
Non-operating	240 g, 2 ms, half-sine	
Random vibration		
Operating	The adapter shall be subjected to 10 Hz to 60 Hz test at a level of peak 0.5G	
Non-operating	A peak 2G acceleration shall be applied with a frequency swept from 7Hz to 50Hz. A peak 4G acceleration shall be applied with a frequency swept form 50 to 60Hz.	

Item	Metric	Imperial
⇒ NOTE: Applicable product safety standards specify thermal limits for plastic surfaces. The computer operates well within this range of temperatures.		

System Board Major Chips

Item	Specification
Core logic	Intel Panther Point-M PCH
VGA	Intel integrated
LAN	Broadcom BCM57785XB0KMLG QFN 68P E-LAN CTRL
USB 2.0 / 3.0	One USB 3.0 port with Two USB 2.0 ports for HM70 SKU Three USB 2.0 ports for HM77 SKU
Super I/O controller	N/A
Bluetooth & Wireless	Foxconn T77H365.00(Broadcom 43228+20702) Foxconn T77H348.02 WB222(Athors) LITE-ON (Broadcom 43228+20702) LITE-ON WCBN611AH-AA_WB222(Broadcom WB222)
PCMCIA	N/A
Audio codec	Realtek ALC271X-VB6-CG

Processor

Item	Specification
CPU	Intel Sandy/Ivy Bridge Dual Core Processor
CPU package	BGA1023
Core logic	Intel Panther Point-M PCH
Chipset	Intel HM77/70 Express Chipset

Processor Specifications

Item	CPU Speed	Cores	Bus Speed (FSB/DMI/QBI)	Mfg Tech	Cache Size	Package	Core Voltage
Intel Celeron 877	1.4G	dual	5GT/s	32nm	2MB	BGA1023	0.7-1.2V
Pentium Dual Core 987	1.5G	dual	5GT/s	32nm	2MB	BGA1023	0.7-1.2V
Pentium Dual Core 967	1.3G	dual	5GT/s	32nm	2MB	BGA1023	0.7-1.2V
i5-2467M	1.6G	dual	5GT/s	32nm	3MB	BGA1023	0.7-1.2V
i3-2367M	1.4G	dual	5GT/s	32nm	3MB	BGA1023	0.7-1.2V
i3-2377M	1.5G	dual	5GT/s	32nm	3M	BGA1023	0.7-1.2V
i5-3317U	1.7G	dual	5GT/s	22nm	3M	BGA1023	0.7-1.2V
i3-3217U	1.8G	dual	5GT/s	22nm	3M	BGA1023	0.7-1.2V
i7-3667U	2.0G	dual	5GT/s	22nm	3M	BGA1023	0.7-1.2V

CPU Fan True Value Table (Tj=100)

CPU Temp	Fan Speed (RPM)	SPL Spec (dBA)
50	3400	25
57	3700	28
64	4100	31
71	4700	34
78	5200	37
85	5400	40
Pro-hot: On= 99°C; OFF= 91°C		
OS shut down at 100°C; H/W shut down at 92°C		

CPU Fan True Value Table (Tj=105)

CPU Temp	Fan Speed (RPM)	SPL Spec (dBA)
50	3400	25
57	3700	28
64	4100	31
71	4700	34
78	5200	34
85	5400	40
Pro-hot: On= 104°C; OFF= 96°C		
OS shut down at 105°C; H/W shut down at 92°C		

System Memory

Item	Specification
Memory controller	Intel Sandy/IVY Bridge Processor
Memory size	N/A
DIMM socket number	x 2 Socket Channel A DIMM 1 Channel B DIMM 2
Supports memory size per socket	1GB/2GB/4GB
Supports maximum memory size	Total 8GB
Supports DIMM type	SODIMM
Supports DIMM Speed	DDR3 1333/1600
Support DIMM voltage	1.5V
Supports DIMM package	DDR3 SODIMM 204 Pin

Memory Combinations

Slot 1 (MB)	Slot 2 (MB)	Total Memory (MB)
1024	1024	2048
2048	N/A	2048
1024	2048	3096
2048	2048	4096
4096	N/A	4096
2048	4096	6154
4096	4096	8192

Video Interface

Item	Specification
Chipset	N/A
Package	N/A
Interface	N/A
Compatibility	N/A
Sampling rate	N/A

BIOS

Item	Specification
BIOS vendor	MXIC
BIOS Version	1.00
BIOS ROM type	SPI
BIOS ROM size	4MB*1, 1MB*1
Features	<ul style="list-style-type: none"> • Insyde code base • Flash ROM 5 MB • Support Acer UI • Support multi-boot • Suspend to RAM (S3)/Disk (S4) • Various hot-keys for system control • Support SMBIOS 2.7, PCI2.3 • DMI utility for BIOS serial number configurable • Support PXE • Support WinFlash • Wake on LAN from S3 • Wake on LAN from S5 in AC mode • System information • Refer to Acer BIOS specification

LAN Interface

Item	Specification
LAN Chipset	Broadcom BCM57785XB0KMLG
LAN connector type	RJ45
LAN connector location	RJ45 on the left side
Features	Supports 10/100/1000BASE-T full-duplex/half-duplex MAC

Keyboard

Item	Specification
Type	AF1S
Total number of keypads	84-US/85-UK /88-JA
Windows logo key	Yes
Internal & external keyboard work simultaneously	Plug USB keyboard to the USB port directly: Yes
Features	<ul style="list-style-type: none">• Phantom key auto detect• Support independent pgdn/pgup keys• Support reverse T cursor keys• Factory configurable different languages by OEM customer

Hard Disk Drive (List all AVL components)

Item	Specification			
Vendor & Model Name	HTS543232A7A 384 ST320LT012 ST320LT020 WD3200LPVT- 22G33T	HTS545050A7E 380 WD5000LPVT- 22G33T		
Capacity (GB)	320G	500G		
Bytes per sector	512Bytes 4096Bytes 4096Bytes 4096Bytes	4096Bytes 4096Bytes		
Data heads	2	2		
Drive Format				
Disks	1	2		
Spindle speed (RPM)	5400RPM			
Performance Specifications				
Buffer size	8MB			
Interface	SATA			
Fast data transfer rate (Mbits/sec, max)	3.0Gbits/s	3.0Gbits/s		
Media data transfer rate (Mbytes/sec max)	124.25Mbytes/sec 130.5Mbytes/s 144 Mbytes/sec 147 Mbytes/sec	125.5Mbytes/sec 144 Mbytes/sec		
DC Power Requirements				
Voltage tolerance	5V			

Super-Multi Drive Interface (N/A)

Item	Specification	
Vendor & Model name		
Performance Specification		
Transfer rate (KB/sec)		
Buffer Memory		
Interface		
Applicable disc format		
Loading mechanism		
Power Requirement		
Input Voltage		

LED 11.6"

Item	Specification																			
Vendor/Model name	LCD AUO B116XTN04.0 (H/W:0A)																			
Screen Diagonal (mm)	293.8 mm																			
Active Area (mm)	256.125 mm x 144.0 mm																			
Display resolution (pixels)	1366 x 3(RGB) x 768																			
Pixel Pitch (mm)	0.1875 mm x 0.1875 mm																			
White Luminance (ILED=20mA) (Note: ILED is LED current)	200 typ. (5 points average) 170 min. (5 points average)																			
Contrast Ratio	400 typ																			
Response Time	8 typ / 16 ms max																			
Power Consumption (watt)	TBD (Include Logic and BLU power)																			
Weight	235 max																			
Physical Size include bracket (mm)	<table border="1"> <thead> <tr> <th></th> <th>Min.</th> <th>Typ.</th> <th>Max.</th> </tr> </thead> <tbody> <tr> <td>Length</td> <td>277.5</td> <td>278.0</td> <td>278.5</td> </tr> <tr> <td>Width</td> <td>167.5</td> <td>168.0</td> <td>168.5</td> </tr> <tr> <td>Thickness</td> <td>-</td> <td>-</td> <td>3.6</td> </tr> </tbody> </table>					Min.	Typ.	Max.	Length	277.5	278.0	278.5	Width	167.5	168.0	168.5	Thickness	-	-	3.6
	Min.	Typ.	Max.																	
Length	277.5	278.0	278.5																	
Width	167.5	168.0	168.5																	
Thickness	-	-	3.6																	
Electrical Interface	1 channel LVDS																			
Viewing Angle (degree) Horizontal (Right) CR = 10 (Left) Vertical (Upper) CR = 10 (Lower)	40 (Right) / 40 (Left) / 10 (Upper) / 30 (Lower) min. 45 (Right) / 45 (Left) / 15 (Upper) / 35 (Lower) typ.																			

LED 11.6" (Con't.)

Item	Specification																				
Vendor/Model name	LCD CMI N116BGE-L32																				
Screen Diagonal (mm)	293.8 mm																				
Active Area (mm)	259.125 mm x 146.80 mm																				
Display resolution (pixels)	1366 x 3(RGB) x 768																				
Pixel Pitch (mm)	0.1875 mm x 0.1875 mm																				
Luminance, wHITE	200 typ.																				
Contrast Ratio	500 typ																				
Response Time	8 typ / 12 ms max																				
Power Consumption	2.578W (max.)																				
Weight	215 max.																				
Physical Size include bracket (mm)	<table border="1"> <thead> <tr> <th></th> <th>Min.</th> <th>Typ.</th> <th>Max.</th> </tr> </thead> <tbody> <tr> <td>Horizontal w/o Bracket</td> <td>267.5</td> <td>268</td> <td>268.5</td> </tr> <tr> <td>Vertical with PCB</td> <td>167.3</td> <td>168</td> <td>168.7</td> </tr> <tr> <td>Vertical w/o PCB</td> <td>157</td> <td>157.5</td> <td>158</td> </tr> <tr> <td>Thickness</td> <td>-</td> <td>-</td> <td>3.4</td> </tr> </tbody> </table>		Min.	Typ.	Max.	Horizontal w/o Bracket	267.5	268	268.5	Vertical with PCB	167.3	168	168.7	Vertical w/o PCB	157	157.5	158	Thickness	-	-	3.4
	Min.	Typ.	Max.																		
Horizontal w/o Bracket	267.5	268	268.5																		
Vertical with PCB	167.3	168	168.7																		
Vertical w/o PCB	157	157.5	158																		
Thickness	-	-	3.4																		
Electrical Interface	1 channel LVDS																				
Viewing Angle (degree) Horizontal (Right) CR = 10 (Left) Vertical (Upper) CR = 10 (Lower)	40 (Right) / 40 (Left) / 15 (Upper) / 40 (Lower) min. 45 (Right) / 45 (Left) / 20 (Upper) / 45 (Lower) typ.																				

LED 11.6 (Con't.)

Item	Specification																
Vendor/Model name	AUO B116XW03 V2 (H/W:1B)																
Screen Diagonal (mm)	293.8 mm																
Active Area (mm)	256.125 mm x 144.0 mm																
Display resolution (pixels)	1366 x 3(RGB) x 768																
Pixel Pitch (mm)	0.1875 mm x 0.1875 mm																
White Luminance (ILED=20mA) (Note: ILED is LED current)	200 typ. (5 points average) 170 min. (5 points average)																
Contrast Ratio	500 type																
Response Time	8 ms type / 16 ms max																
Power Consumption	2.9W max. (include Logic and BLU power)																
Weight	235 max																
Physical Size include bracket (mm)	<table border="1"> <thead> <tr> <th></th> <th>Min.</th> <th>Typ.</th> <th>Max.</th> </tr> </thead> <tbody> <tr> <td>Length</td> <td>267.5</td> <td>268.0</td> <td>268.5</td> </tr> <tr> <td>Width</td> <td>174</td> <td>174.5</td> <td>175</td> </tr> <tr> <td>Thickness</td> <td>-</td> <td>-</td> <td>3.6</td> </tr> </tbody> </table>		Min.	Typ.	Max.	Length	267.5	268.0	268.5	Width	174	174.5	175	Thickness	-	-	3.6
	Min.	Typ.	Max.														
Length	267.5	268.0	268.5														
Width	174	174.5	175														
Thickness	-	-	3.6														
Electrical Interface	1 channel LVDS																
Viewing Angle (degree) Horizontal (Right) CR = 10 (Left) Vertical (Upper) CR = 10 (Lower)	40 (Right) / 40 (Left) / 10 (Upper) / 30 (Lower) min. 45 (Right) / 45 (Left) / 15 (Upper) / 35 (Lower) typ.																

LED 11.6" (Con't.)

Item	Specification																				
Vendor/Model name	CMI N116BGE-L42																				
Screen Diagonal (mm)	293.8 mm																				
Active Area (mm)	259.125 mm x 146.80 mm																				
Display resolution (pixels)	1366 x 3(RGB) x 768																				
Pixel Pitch (mm)	0.1875 mm x 0.1875 mm																				
Luminance, wHITE	200 cd/m ² typ.																				
Contrast Ratio	500 type																				
Response Time	8 ms type / 16 ms max																				
Power Consumption	2.552W (max.)																				
Weight	215 max.																				
Physical Size include bracket (mm)	<table border="1"> <thead> <tr> <th></th> <th>Min.</th> <th>Typ.</th> <th>Max.</th> </tr> </thead> <tbody> <tr> <td>Horizontal w/o Bracket</td> <td>267.5</td> <td>268</td> <td>268.5</td> </tr> <tr> <td>Vertical with PCB</td> <td>167.3</td> <td>168</td> <td>168.7</td> </tr> <tr> <td>Vertical w/o PCB</td> <td>157</td> <td>157.5</td> <td>158</td> </tr> <tr> <td>Thickness</td> <td>-</td> <td>-</td> <td>3.4</td> </tr> </tbody> </table>		Min.	Typ.	Max.	Horizontal w/o Bracket	267.5	268	268.5	Vertical with PCB	167.3	168	168.7	Vertical w/o PCB	157	157.5	158	Thickness	-	-	3.4
	Min.	Typ.	Max.																		
Horizontal w/o Bracket	267.5	268	268.5																		
Vertical with PCB	167.3	168	168.7																		
Vertical w/o PCB	157	157.5	158																		
Thickness	-	-	3.4																		
Electrical Interface	1 channel LVDS																				
Viewing Angle (degree) Horizontal (Right) CR = 10 (Left) Vertical (Upper) CR = 10 (Lower)	40 (Right) / 40 (Left) / 10 (Upper) / 30 (Lower) min. 45 (Right) / 45 (Left) / 20 (Upper) / 45 (Lower) typ.																				

Graphics Controller and VRAM (N/A)

Item	Specification
Graphics Controller Chip	Integrated
Supports	N/A
VRAM Chipset	N/A
Memory Size	N/A
Interface	N/A

Supported Resolution (GPU: Include all supported resolution)

Resolution	16 bits	32 bits			
640x480p/60Hz 16:9	V	V			
800x600p/60Hz 16:9	V	V			
1024x768p/60Hz 16:9	V	V			
1280x600/60Hz 16:9	V	V			
1280x720/60Hz 16:9	V	V			
1280x768/60Hz 16:9	V	V			
1360x768/60Hz 16:9	V	V			
1366x768/60Hz 16:9	V	V			

Legend: V = Supported; X = Not supported

Bluetooth Interface (N/A)

Item	Specification
Chipset	
Data throughput	
Protocol	
Interface	
Connector type	
Supported protocol	

Bluetooth Module

Item	Specification
Controller	Foxconn combo module with Broadcom43228+20702 Foxconn combo module with Athors LITE-ON combo module with Broadcom 43228+20702 LITE-ON combo module with Broadcom WB222 Intel combo module
Features	BT4.0

Camera

Item	Specification
Vendor and Model	<ul style="list-style-type: none">• Chicony, CNFB1D921004970LH• Chicony, CNFB1D721004970LH• Lite-on, 11P2SF167• Lite-on, 12P2SF105• Suyin, HF1016-A21U-OV02• Suyin, HF1016-T821-HN01
Type	HD

Mini Card

Item	Specification
Number supported	2
Features	1 mini card slot (1 for WLAN & BT or WLAN)

3G Card (N/A)

Item	Specification
Features	N/A

Audio Codec and Amplifier

Item	Specification
Audio Controller	Audio codec: Realtek ALC271X-VB6-CG

Audio Interface

Item	Specification
Audio Controller	Realtek ALC271X-VB6-CG
Audio onboard or optional	On board
Mono or Stereo	Stereo
Resolution	Support 16/20/24bit PCM
Compatibility	HD audio Interface
Sampling rate	Sample rate up to 192Khz resolution VSR (Variable Sampling Rate)
Internal microphone	Yes
Internal speaker/quantity	Yes / (1W, 8 ohm speakers x2)

Wireless Module 802.11 a/b/g/n

Item	Specification	
Chipset	Qualcomm	Broadcomm
Data throughput	1 transmitter and 1 receiver allow data rates supporting up to 150 Mbps downstream and 150 Mbps upstream PHY rates.	<ul style="list-style-type: none">• 802.11g: 54Mbps with fall back of 48, 36, 24, 18, 12, 9, 6Mbps• 802.11b: 11Mbps with fall back rates of 5.5, 2, and 1Mbps• 802.11n: HT20 (800ns GI): (MCS0-MCS7) 6.5M, 13M, 19.5M, 26M, 39M, 52M, 58.5M, 65M
Protocol	802.11 a/b/g/n	
Interface	PCI bus (mini PCI socket for wireless module)	

Battery

Item	Specification	
Vendor & Model name	SANYO AL12B32	
Battery Type	Li-ion	
Pack capacity	2500 mAh	
Number of battery cell	4	
Package configuration	4S1P	

USB Port

Item	Specification
USB compliance level	USB2.0 / USB 3.0
Protocol	EHCI / XHCI
Number of USB port(s)	3 Total MB: 1 for USB 2.0 or USB 3.0 SB: 2 for USB 2.0
Location	JUSB1 on MB BOT JUSB1, JUSB2 on SB BOT
Output Current	2.0A

HDMI Port

Item	Specification
Compliance level	HDMI 1.4
Data throughput	Up to 16.7 million colors
Number of HDMI port(s)	1
Location	JHDMI1 at the bottom

AC Adapter

Item	Specification
Input rating	40 W
Maximum input AC current	40 W: 1.2A at 100V
Inrush current	No damage; meet fuse and bridge diode I ² t de-rating specified
Efficiency	Meet EPA 2.0 level V

System Power Management

Item	Specification
Mech. Off (G3)	All devices in the system are turned off completely.
Soft Off (G2/S5)	OS initiated shutdown. All devices in the system are turned off completely.
Working (G0/S0)	Individual devices such as the CPU and hard disk may be power managed in this state.
Suspend to RAM (S3)	<ul style="list-style-type: none">• CPU Set Power Down• VGA Suspend• Audio Power Down• Hard Disk Power Down• CD-ROM Power Down• Super I/O Low Power mode
Save to Disk (S4)	Also called Hibernation Mode. System saves all system states and data onto the disc prior to power off the whole system.

Card Reader

Item	Specification
Chipset	BCM57785XA0KMLG
Package	QFN68
Maximum supported size	<ul style="list-style-type: none"> SD, miniSD, microSD™ SDHC, miniSDHC, microSDHC SDXC, microSDXC
Features	2 in 1 card reader, supporting: <ul style="list-style-type: none"> Secure Digital™ (SD) Card MultiMediaCard™ (MMC)

System LED Indicator

Item	Specification
Lock	N/A
System state	<ul style="list-style-type: none"> Blue color solid on: System on Blue color off: System off
Battery state	<p>Charging</p> <ul style="list-style-type: none"> Amber solid on - Battery charging with AC Blue color solid on - Battery full Amber color blinking - Battery abnormal stop charging or battery in low power state <p>Discharging</p> <ul style="list-style-type: none"> Amber color blinking - Battery in critical low state Amber color off - Discharging state

System DMA Specification

Hardware DMA	System Function
DMA0	Not applicable
DMA1	Not applicable
DMA2	Not applicable
DMA3	Not applicable
DMA4	Direct memory access controller
DMA5	Not assigned
DMA6	Not assigned
DMA7	Not assigned
<p>⇒ NOTE: Express Card controller can use DMA 1, 2, or 5.</p>	

System Interrupt Specification

Hardware IRQ	System Function
IRQ0	
IRQ1	
IRQ2	
IRQ3	
IRQ4	
IRQ6	
IRQ7*	
IRQ8	
IRQ9*	
IRQ10*	
IRQ11	
IRQ12	
IRQ13	
IRQ14	
IRQ15	
⇒ NOTE: *Default configuration, audio possible configurations are IRQ5, IRQ7, IRQ9, IRQ10, or none.	

System IO Address Map

I/O Address (hex)	System Function (Shipping Configuration)
000 - 00F	DMA controller no. 1 & PCI bus
010 - 01F	Motherboard resources no. 1
020 - 021	Interrupt controller no. 1
022 - 024	Unused
025 - 03F	Unused
02E - 02F	Motherboard resources no. 2
040 - 05F	System timer
044 - 05F	Unused
060	Standard PS/2 Keyboard
061	System speaker
062	Microsoft ACPI-Compliant Embedded Controller no. 1
064	Standard PS/2 Keyboard
066	Microsoft ACPI-Compliant Embedded Controller no. 2
070 - 071	System CMOS/RTC
072 - 073	Motherboard resources no. 3
080 - 080	Motherboard resources no. 4
081-08F	DMA controller no. 2
092	Motherboard resources no. 5
093 - 09F	Unused
0A0 - 0A1	Interrupt controller no. 2
0B0 0B	Motherboard resources no. 6
0C0 - 0DF	DMA controller no. 3
0E0 - 0EF	Unused
0F0 - 0FE	Numeric data processor
0F2 - 3AF	Unused
3B0 - 3BB	
3BC - 3BF	
3C0 - 3DF	
3E0 - 3E1	

System IO Address Specification (N/A)

I/O Address (hex)	System Function (Shipping Configuration)
3E2 - 3FF	
400-4CF	
4D0-4D1	
4D6	
680-6FF	
77A	
840-847	
C00-C01	
C14	
C50-C52	
C6C	
C6F	
CD0-CDB	
D00-FFFF	
2000-207F	
2000-207F	
3000-30FF	
3100-310F	
3110-3117	
3118-311F	
3120-3123	
3124-2127	
FD60-FD63	

System Utilities	2-2
BIOS Setup Utility	2-2
Navigating the Bios Setup Utility	2-2
BIOS	2-3
Information	2-3
Main	2-5
Security	2-7
Boot	2-11
Exit	2-12
BIOS Flash Utilities	2-13
DOS Flash Utility	2-14
WinFlash Utility	2-17
Miscellaneous Tools	2-20
Using DMI Tools	2-20
HDD/BIOS Password	2-22
Unlocking the HDD	2-22
Clearing the Password Check and BIOS Password	2-24
Crisis Utility SOP	2-26
When to Use the Crisis SOP	2-26
Creating a USB Flash Crisis Disk	2-26
Using the Crisis Utility Disk	2-28

System Utilities

BIOS Setup Utility

The *BIOS Setup Utility* is a hardware configuration program built into a computer's BIOS (Basic Input/Output System).

The BIOS utility is pre-configured and optimized so most users do not need to run this utility. However, if configuration problems occur, you may need to run the BIOS utility.

To activate the BIOS Utility, press **F2** during POST (power-on-self-test) when the "Press <F2> to enter Setup." message is prompted on the bottom of screen.

To change the boot device without entering the BIOS utility, press **F12** during POST to enter the multi-boot menu. In this menu, users can change the boot device without entering *BIOS Setup Utility*.

Navigating the Bios Setup Utility

The BIOS utility has five menu options: **Information**, **Main**, **Security**, **Boot**, and **Exit**.

To navigate through the menus options, perform the following:

- To choose a menu, use the left and right arrow keys.
- To choose an item, use the up and down arrow keys.
- To change the value of a parameter, press **F5** or **F6**.
- A plus sign (+) indicates the item has sub-items.
- Press **Enter** to expand this item.
- Press **Esc** while you are in any of the menu options to go to the Exit menu.
- In any menu, you can load default settings by pressing **F9**. You can also press **F10** to save any changes made and exit the *BIOS Setup Utility*.

⇒ NOTE:

- Parameter values can be changed if enclosed in square brackets []. Navigation keys for a particular menu are shown on the bottom of the screen. Help for parameters are found in the Item Specific Help part of the screen. Read this carefully when making changes to parameter values.
- System information is subject to specific models.

BIOS

The following is a description of the menu tabs found on the *InsydeH20 BIOS Setup Utility* screen.

⇒ NOTE:

The screens provided are for reference only. Actual values may differ by model.

Information

The Information tab displays a summary of the computer hardware information.



Figure 2:1. BIOS Information

Parameter	Description
CPU Type	Displays the CPU (Central Processing Unit) type.
CPU Speed	Displays the speed of the system.
HDD Model Name	Displays the model name of the HDD (hard disk drive) installed on primary SATA master.
HDD Serial Number	Displays the serial number of the HDD installed on primary SATA master.
ATAPI Model Name	Displays the ODD (optical disc drive) model name installed in the system.
System BIOS Version	Displays the system BIOS version.
VGA BIOS Version	Displays the VGA (video graphics array) firmware version.
Serial Number	Displays the serial number of the unit.

Parameter	Description
Asset Tag Number	Displays the tag number of the system.
Product Name	Displays the product name of the system.
Manufacturer Name	Displays the system manufacturer.
UUID	Displays the UUID (Universally Unique Identifier).

Main

The Main tab allows the user to set the system time and date, enable or disable boot option, and enable or disable recovery.

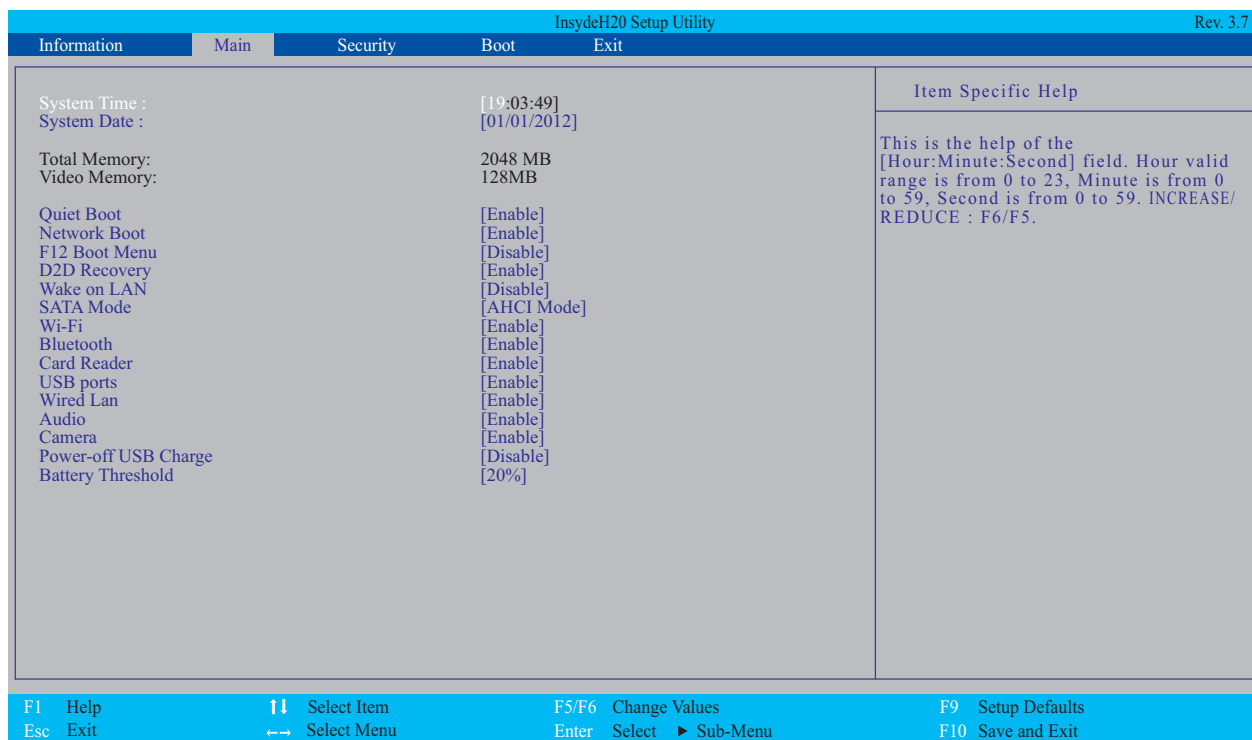

Figure 2.2. BIOS Main

Parameter	Description
System Time	Sets the system time in 24-hour format.
System Date	Sets the system date.
Total Memory	Displays the total memory installed.
Video Memory	Displays the video memory installed.
Quiet Boot	When enabled, displays the OEM (original equipment manufacturer) screen during system boot instead of the traditional POST screen.
Network Boot	Enable or disable system boot from LAN (local area network).
F12 Boot Menu	Enable or disable the use of boot menu during POST.
D2D Recovery	Enable or disable disc-to-disc recovery by pressing Alt+F10 key during POST.
Wake on LAN	Enable or disable system to wake up from LAN.
SATA Mode	Select the SATA controller mode: AHCI or IDE.
Wi-Fi	Enable or disable the Wi-Fi.
Bluetooth	Enable or disable the Bluetooth.
Card Reader	Enable or disable the Card Reader.

Parameter	Description
USB ports	Enable or disable the USB ports.
Wired Lan	Enable or disable the Wired LAN.
Audio	Enable or disable the Audio.
Camera	Enable or disable the Camera.
Power-off USB Charge	Enable or disable the Power-off USB Charge.
Battery Threshold	Set Battery Threshold of Power-off USB charge.

Security

The Security tab allows the user to configure and protect the computer from unauthorized use.

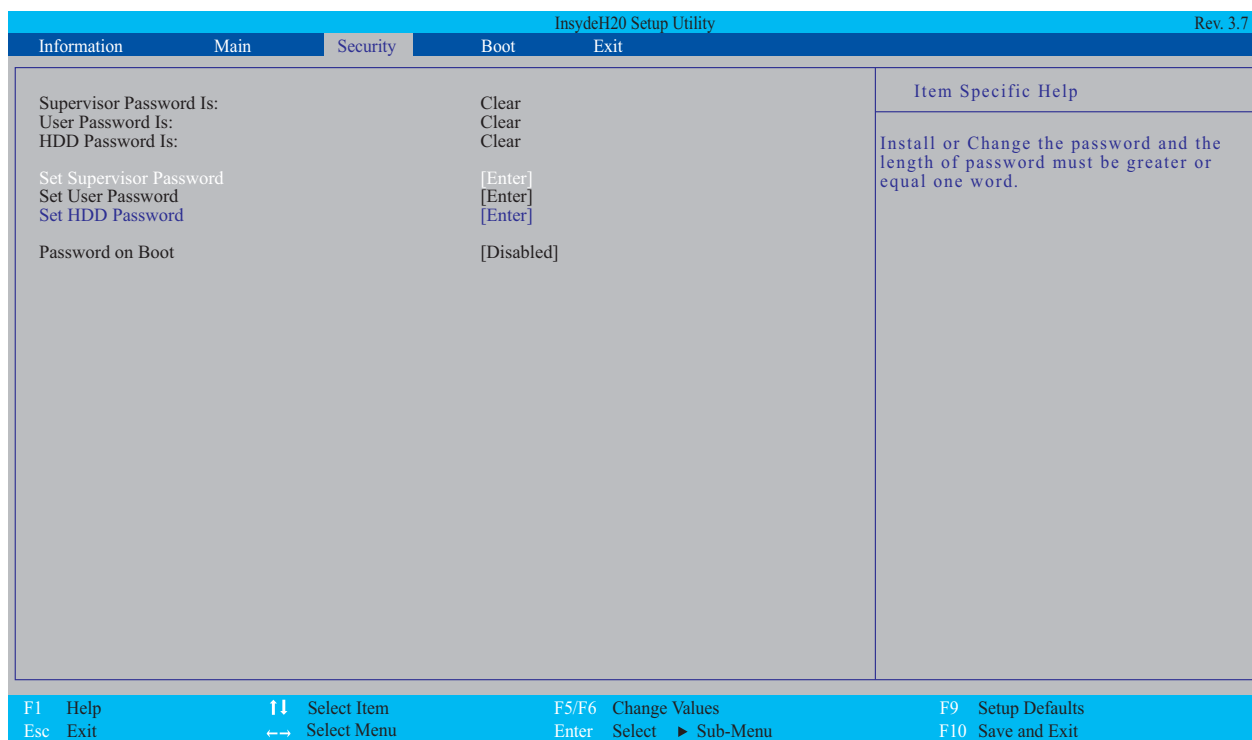

Figure 2:3. BIOS Security

Parameter	Description
Supervisor Password Is	Displays “Set” if the supervisor password is set and “Clear” if the supervisor password is not set.
User Password Is	Displays “Set” if the user password is set and “Clear” if the user password is not set.
HDD Password Is	Displays “Set” if the HDD password is set and “Clear” if the HDD password is not set.
Set Supervisor Password	Option to set the supervisor password.
Set User Password	Option to set the user password. Enabled only when the supervisor password is set.
Set HDD Password	Option to set the HDD password.
Password on Boot	Enable or disable the computer to prompt for the password on system boot. When disabled, the password is only prompted when entering the <i>BIOS Setup Utility</i> .

⇒ NOTE:

When prompted to enter the password, three attempts are allowed before system halts. Resetting the BIOS password may require the computer to be returned to the dealer.

Setting a Password

Perform the following to set the supervisor password:

1. Use the \uparrow and \downarrow keys to highlight the `Set Supervisor Password` parameter and press **Enter**. The `Set Supervisor Password` dialog box appears.

A blue dialog box titled "Set Supervisor Password". It contains two input fields: "Enter New Password" and "Confirm New Password". The "Enter New Password" field is empty, and the "Confirm New Password" field is filled with black dots.

Figure 2:4. Set Supervisor Password

2. Type the password in the `Enter New Password` field.

⇒ NOTE:

Passwords are not case sensitive and the length must not exceed 12 characters. The following characters may be used in a password.

A - Z	Alphabets A through Z (Not Case Sensitive)
0 - 9	Numerical Characters
-	Dash
=	Equal Sign
[Left Bracket
]	Right Bracket
.	Period
,	Comma
;	Semi-colon
/	Slash
\	Back-slash

🚨 IMPORTANT:

Use care when typing a password. Characters do not appear on the screen.

3. Retype the password in the `Confirm New Password` field.
4. Press **Enter**. The `Setup Notice` dialog box appears.

A blue dialog box titled "Setup Notice". It contains the text "Changes have been saved." and a button labeled "[Continue]".

Figure 2:5. Setup Notice

5. Press **Enter** to complete the password setting. After setting the supervisor password, the computer sets the `Supervisor Password Is` parameter to `Set`.
6. Press **F10** to save changes and exit *BIOS Setup Utility*.

⇒ **NOTE:**

The same procedures apply in setting the user password and HDD password.

When the supervisor password is set, the `Set User Password` and `Password on Boot` parameters are enabled for users to configure.

Changing a Password

Perform the following to change a password:

⇒ **NOTE:**

Below are the procedures for changing the supervisor password. The same procedures apply in changing the user and HDD passwords.

1. Use the `↑` and `↓` keys to highlight the `Set Supervisor Password` parameter and press **Enter**. The `Set Supervisor Password` dialog box appears.

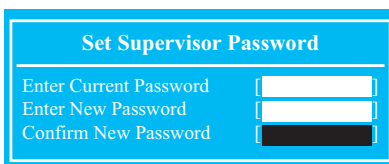

Figure 2:6. Set Supervisor Password

2. Type the current password in the `Enter Current Password` field and press **Enter**.
3. Type the new password in the `Enter New Password` field and press **Enter**.
4. Retype the new password in the `Confirm New Password` field.
5. Press **Enter**. If the passwords match, the `Setup Notice` dialog box appears.



Figure 2:7. Setup Notice

6. Press **Enter** to complete the password setting. The computer sets the `Supervisor Password Is` parameter to `Set`.
7. Press **F10** to save changes and exit *BIOS Setup Utility*.

Removing a Password

Perform the following to remove a password:

⇒ NOTE:

Below are the procedures for removing the supervisor password. The same procedures apply in removing the user and HDD passwords.

When the supervisor password is removed, the user password is automatically removed.

1. Use the ↑ and ↓ keys to highlight the Set Supervisor Password parameter and press **Enter**. The Set Supervisor Password dialog box appears.

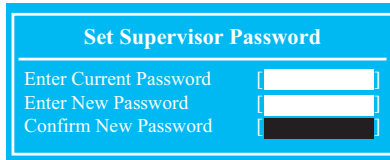

The image shows a blue dialog box titled "Set Supervisor Password". It contains three input fields: "Enter Current Password", "Enter New Password", and "Confirm New Password". The "Enter New Password" and "Confirm New Password" fields are currently empty, while the "Enter Current Password" field has a cursor in it.

Figure 2:8. Set Supervisor Password

2. Type the current password in the Enter Current Password field and press **Enter**.
3. Press **Enter** twice without typing anything in the Enter New Password and Confirm New Password fields. The Setup Notice dialog box appears.

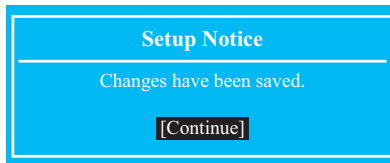

The image shows a blue dialog box titled "Setup Notice". It contains the text "Changes have been saved." and a button labeled "[Continue]".

Figure 2:9. Setup Notice

4. Press **Enter** to complete the password setting. The computer sets the Supervisor Password Is parameter to Clear.
5. Press **F10** to save changes and exit *BIOS Setup Utility*.

Boot

The Boot tab allows the user to configure the order of boot devices used to load the operating system.

Use **↑** and **↓** keys to select a device and press **F5** or **F6** to change the value.



Figure 2:10. BIOS Boot

Exit

The Exit tab allows the user to save or discard changes and quit the *BIOS Setup Utility*.

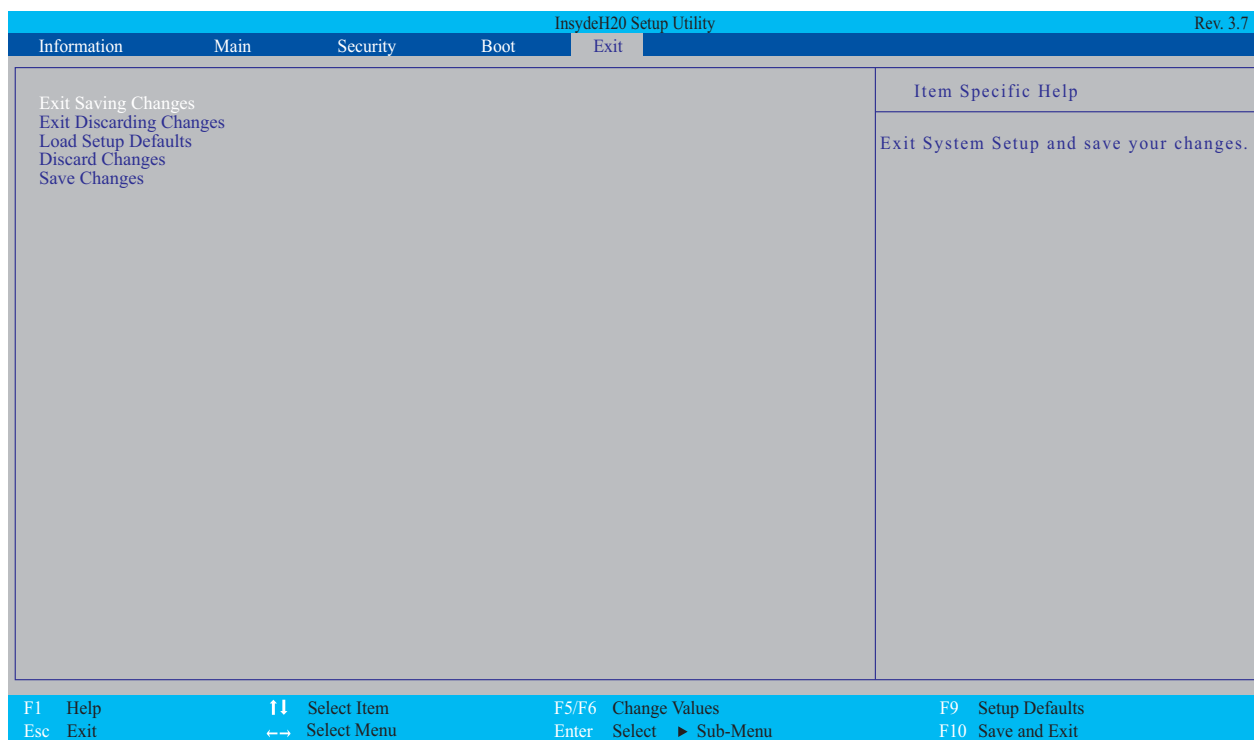

Figure 2:11. BIOS Exit

Parameter	Description
Exit Saving Changes	Save the changes and exit the BIOS utility.
Exit Discarding Changes	Exit the BIOS utility without saving the changes to the system.
Load Setup Defaults	Load the default values of all setup items.
Discard Changes	Load the previous values of all setup items.
Save Changes	Save all changes to the system.

BIOS Flash Utilities

BIOS Flash memory updates are required for the following conditions:

- New versions of system programs
- New features or options
- Restore a BIOS when it becomes corrupted.

Use the Flash utility to update the system BIOS Flash ROM.

Perform the following to run a BIOS Flash update:

1. Prepare a bootable USB HDD/FDD.
2. Download and copy the Flash utilities to the bootable USB HDD/FDD.

BIOS Flash may be performed by one of the following:

- DOS Flash Utility
- WinFlash Utility

NOTE:

- If a Crisis Recovery Disc is not available, create one before BIOS Flash utility is used. See [Creating a USB Flash Crisis Disk](#) on page [2-26](#).
- Do not install memory related drivers (XMS, EMS, DPML) when BIOS Flash is used
- Use an AC adapter power supply when running BIOS Flash utility. If the battery pack does not contain power to finish loading BIOS Flash, do not boot the system.
- Flash utility has auto execution function.

DOS Flash Utility

⇒ NOTE:

Plug the AC power adapter to a power source before performing the DOS Flash Utility.

Perform the following to use the DOS Flash Utility:

1. In *Windows OS*, unzip the compressed BIOS ROM package (e.g. in this case, "Q1VZC102.zip").
2. Copy the folder "Q1VZC102" to the root directory of the DOS-bootable USB flash disk.

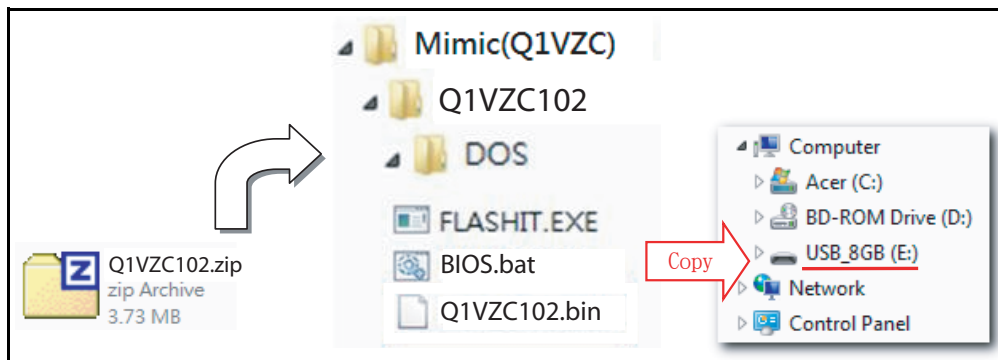

Figure 2:12. Copy Folder to USB Disk

3. Reboot the system and press **F2** during boot to enter the *BIOS Setup Utility*.
4. Select **Boot** menu to modify the boot priority order.
5. Move the USB HDD to position 1 (refer to **Boot** on page 2-11).



Figure 2:13. Changing the BIOS Boot Priority Order

6. Insert the USB HDD and reboot the computer in DOS mode.
7. If necessary, execute the “**dir**” command to find the batch file.

```
C:\Q1VZC102\DOS>dir

Volume in drive C is USB_8GB
Volume Serial Number is 3666-33A4
Directory of C:\Q1VZC102\DOS

.                <DIR>          03-27-2012  18:46  .
..               <DIR>          03-27-2012  18:46  ..
FLASHIT  EXE           102,912   07-19-2011  17:49  FLASHIT.EXE
BIOS     BAT             338      03-30-2011  13:15  BIOS.BAT
Q1VZC102 BIN       4,194,304 03-30-2010 17:37  Q1VZC102.BIN
          3 file(s)         4,297,554 bytes
          2 dir(s)       2,524,848,128 bytes free

C:\Q1VZC102\DOS>_
```

Figure 2:14. Execute DIR

8. At the command prompt, execute “**BIOS.bat**” and press **Enter** to update BIOS. Flash process begins.

```
C:\Q1VZC102\DOS>BIOS.bat

Please do not remove the AC power!

Insyde Flash Utility for InsydeH20
                               Version 1.5o

Initializing

File loading   100 %

Current BIOS Model name : Q1VZC
New    BIOS Model name : Q1VZC

Current BIOS version: V1.01
New    BIOS version: V1.02

Updating Block at FFFFF000
```

Figure 2:15. Updating Flash BIOS

Once Flash BIOS is complete, the utility automatically updates EC.

```
C:\Q1VZC102\DOS>BIOS.bat

Please do not remove the AC power!

Insyde Flash Utility for InsydeH20
                               Version 1.5o

Initializing

File loading   100 %

Current BIOS Model name : Q1VZC
New    BIOS Model name : Q1VZC

Current BIOS version: V1.01
New    BIOS version: V1.02

Updating Block at FFFFF000
Flash Complete!
Start EC update
```

Figure 2:16. Updating EC

The system restarts automatically when finished.

 **IMPORTANT:**

- Ensure the AC power adapter is connected to the power source.
- If the Warning message below is shown, check if the AC power adapter is properly connected or not.

```
C:\>cd Q1VZC102\DOS
C:\Q1VZC102\DOS>BIOS.bat

Warning: No AC Connected
This process requires AC power to avoid an accidental power-off
during an update.

C:\Q1VZC102\DOS>
```

Figure 2:17. Warning Message

- Do not disconnect the AC power adapter.

WinFlash Utility

⇒ NOTE:

Plug the AC power adapter to a power source before performing the WinFlash Utility.

Perform the following to use the WinFlash Utility:

1. Boot into Windows OS and search for WinFlash Utility file.

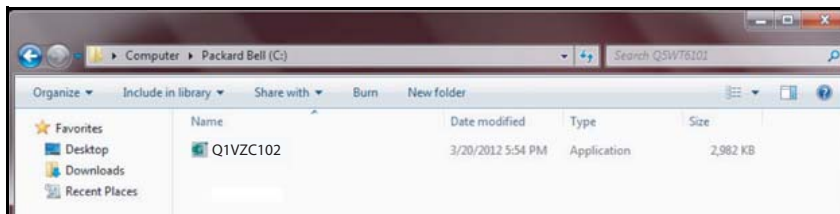

Figure 2:18. Browsing for WinFlash Utility

2. Double-click on the utility file.

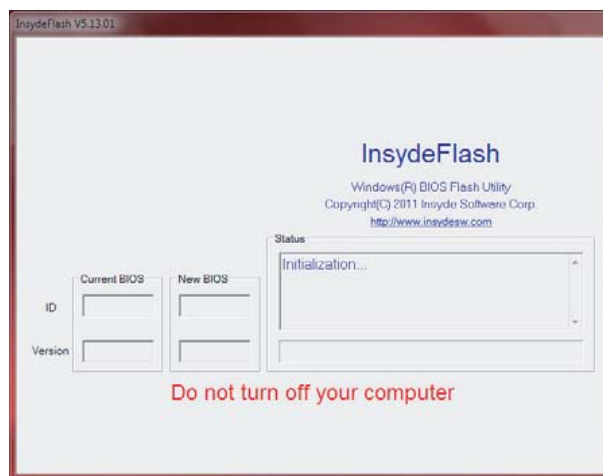

Figure 2:19. Initializing WinFlash Utility

3. A message is displayed. Click **OK** to continue.

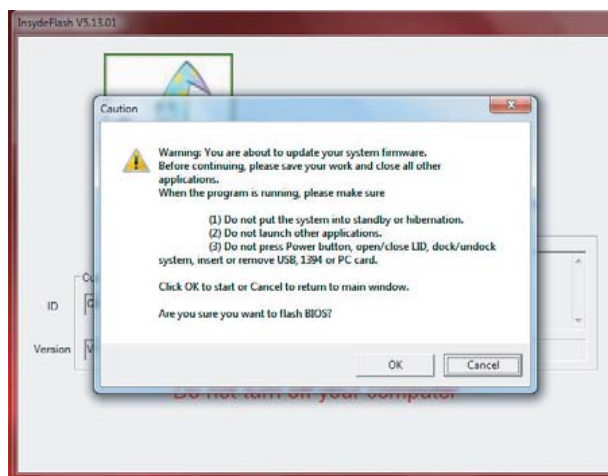

Figure 2:20. Warning Message

After clicking **OK**, it will auto flash BIOS and EC.

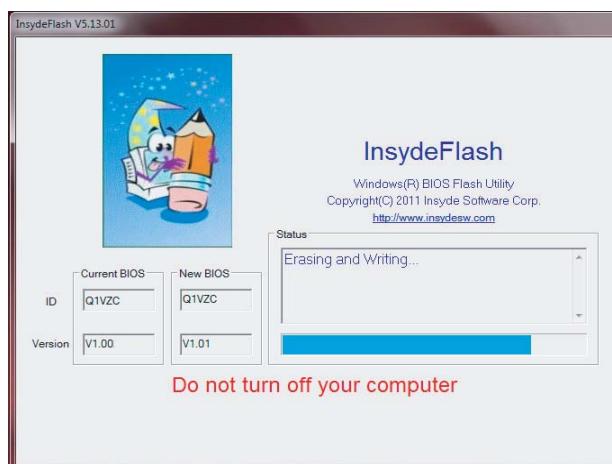

Figure 2:21. Updating Flash BIOS

When flashing is complete, WinFlash will close all AP and restart the system.

⚠ CAUTION:

- Do not turn off the computer during the Flash process.
- Do not put the system into standby or hibernation mode.
- Do not launch other applications.
- Do not press the Power button, open/close the lid, dock/undock the system, insert or remove USB, 1394, or PC card.

Winflash Error and Warning Messages

- If the AC adapter is not plugged in before Winflash starts, the following message is shown:



Figure 2:22. AC Detect Error Message

- After executing Winflash, if the AC adapter is not plugged and the battery power is low, the following message is shown:

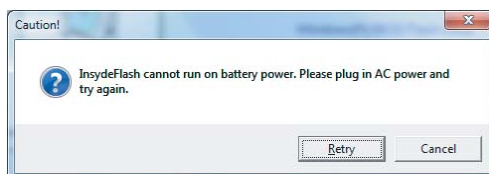

Figure 2:23. Battery Power Warning Message

- Check the BIOS ROM file size. If the BIOS ROM file size is different from the ROM part size, the following message is shown:



Figure 2:24. BIOS ROM File Size Error Message

Miscellaneous Tools

Using DMI Tools

The *DMI (Desktop Management Interface) Tool* copies BIOS information to EEPROM and used in the DMI pool for hardware management.

When the BIOS shows *Verifying DMI pool data*, it is checking that the table correlates with the hardware before sending it to the operating system (Windows, etc.).

To update the DMI Pool, perform the following:

1. Boot from DOS.
2. At the command prompt, execute **dmitools [argument] [string]** with one of the following arguments:
 - `/r ==>` Read DMI information from memory
 - `/wm ==>` Write Manufacturer Name to EEPROM (max. 16 characters)
 - `/wp ==>` Write Product Name to EEPROM (max. 16 characters)
 - `/ws ==>` Write Serial Number to EEPROM (max. 22 characters)
 - `/wu ==>` Write UUID to EEPROM (ignore string)
 - `/wa ==>` Write Asset Tag to EEPROM (max. 32 characters)

The following examples show the commands and the corresponding output information:

1. Read DMI Information from Memory:

Input:

```
dmitools /r
```

Output:

```
Manufacturer (Type1, Offset04h): Acer
Product Name (Type1, Offset05h): TravelMate B113
Serial Number (Type1, Offset07h): 01234567890123456789
UUID String (Type1, Offset08h): xxxxxxxx-xxxx-xxxx-xxxx-
                                xxxxxxxxxxxxxxxx
```

2. Write Product Name to EEPROM

Input:

```
dmitools /wp TravelMate B113
```

3. Write Serial Number to EEPROM

Input:

```
dmitools /ws 01234567890123456789
```

4. Write UUID to EEPROM (Create UUID from *Intel WFM20.pdf*)

Input:

```
dmitools /wu
```

5. Write Asset Tag to EEPROM

Input:

```
dmitools /wa Acer Asstag
```

⇒ **NOTE:**

When running examples 2 ~ 5, restart the system to make the new DMI data effective.

HDD/BIOS Password

This section provides details about unlocking HDD password and removing the BIOS passwords.

Unlocking the HDD

⇒ NOTE:

If the HDD password is incorrectly entered three times, the HDD is locked and the `Harddisk Security` dialog box appears.



Figure 2:25. Password Error Status

Perform the following to unlock the HDD:

1. On the `Harddisk Security` dialog (**Figure 2:25**), press **Enter** to continue. The `Select Item` dialog box appears.

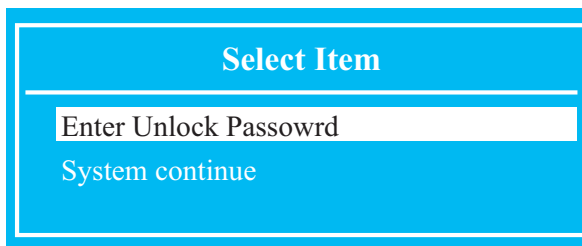

Figure 2:26. Select Item

2. Use the \uparrow and \downarrow keys to highlight `Enter Unlock Password` and press **Enter**. The `Enter Unlock Password` dialog box appears.

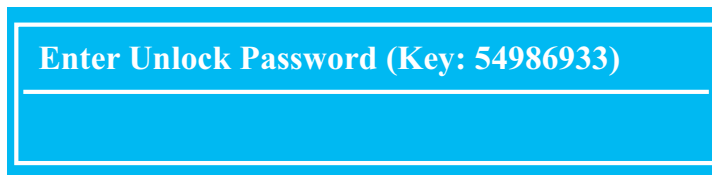

Figure 2:27. Enter Unlock Password

3. Take note of the generated key code. In **Figure 2:27** example, the key code is 54986933.

⇒ NOTE:

A separate computer is required to generate the unlock password.

4. On the separate computer, boot to DOS.

- Execute *UnlockHD.exe* to generate an unlock password.
Use the following command: **UnlockHD [key code]** with the code noted in step 3, [Figure 2:27](#).

```
C:\UnlockHD 54986933
Password: 41684315

C:\
```

Figure 2:28. Execute UnlockHD.exe

- Take note of the generated unlock password.
- On the original device, enter the unlock password in the Enter Unlock Password dialog box.



Figure 2:29. Enter Unlock Password

Clearing the Password Check and BIOS Password

Clearing the Password Check

The password check can be removed by shorting the “R74” point with a metal instrument.

1. Open the base door.
2. Locate R74 point near the memory module and fan module.
3. Use an electronic conductivity tool to bridge the two points of the jumper.

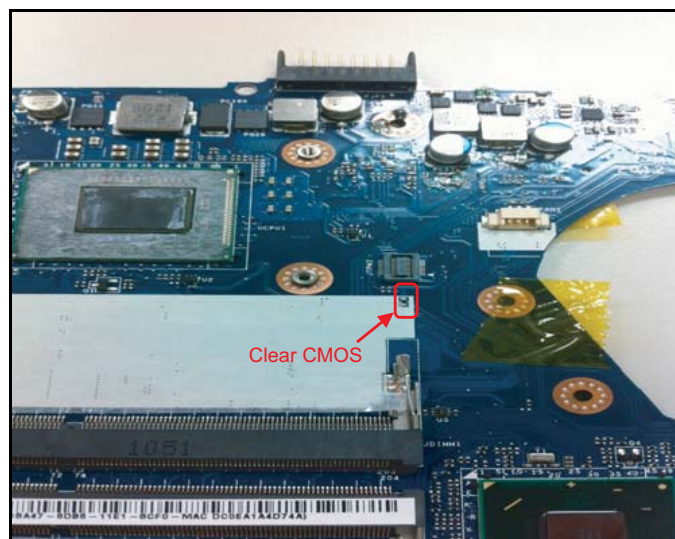
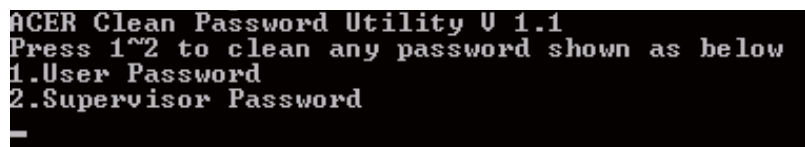

Figure 2:30. R74 Jumper

Cleaning BIOS Passwords

To clean the User or Supervisor password, perform the following:

1. At the command prompt, type **CP.exe**. The Clean Password Utility is shown.



```
ACER Clean Password Utility U 1.1
Press 1~2 to clean any password shown as below
1.User Password
2.Supervisor Password
_
```

Figure 2:31. Clean BIOS Password

2. Press **1** or **2** to clean the desired password shown on the screen.

The screen displays if the function is successful or a failure.

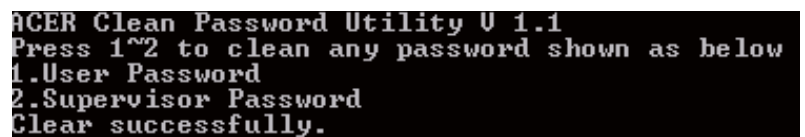

```
ACER Clean Password Utility U 1.1
Press 1~2 to clean any password shown as below
1.User Password
2.Supervisor Password
Clear successfully.
```

Figure 2:32. Clean BIOS Password Status

Crisis Utility SOP

When to Use the Crisis SOP

- When the system hangs while updating BIOS
- When power failure occurs and the system shuts down while updating BIOS
- When the system cannot boot normally after updating BIOS (e.g. a black screen appears without a POST logo, etc.)

Creating a USB Flash Crisis Disk

To create a Crisis USB flash disk, perform the following:

1. On a machine with *Windows OS*, plug in the USB flash disk.
2. Launch *Windows Explorer* and search for the USB flash disk. Right-click on the USB disk, and select *Format* to format the USB disk.

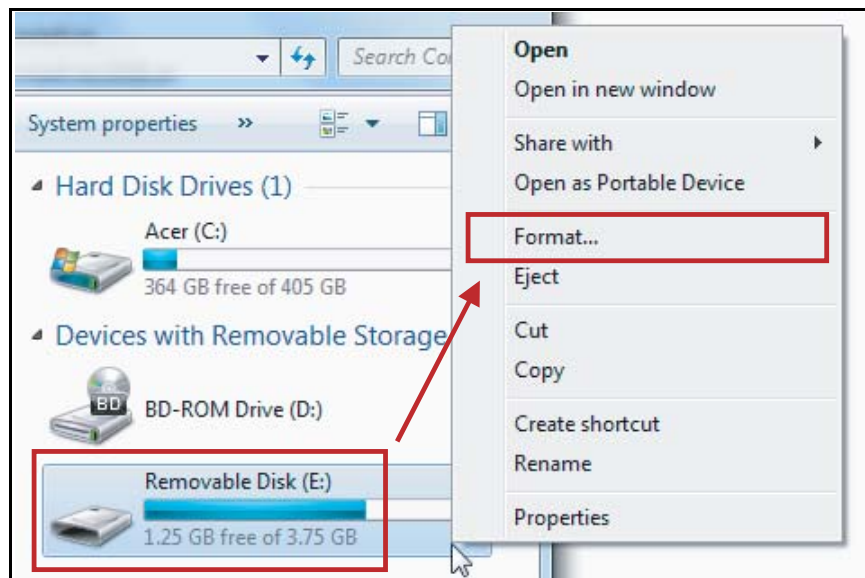

Figure 2:33. Format USB Flash Disk (1 of 2)

3. In the dialog shown below, set the following options:
 - File System: Choose “FAT32”
 - Format Options: Select “Quick Format”Then, click **Start** to execute the formatting operation.

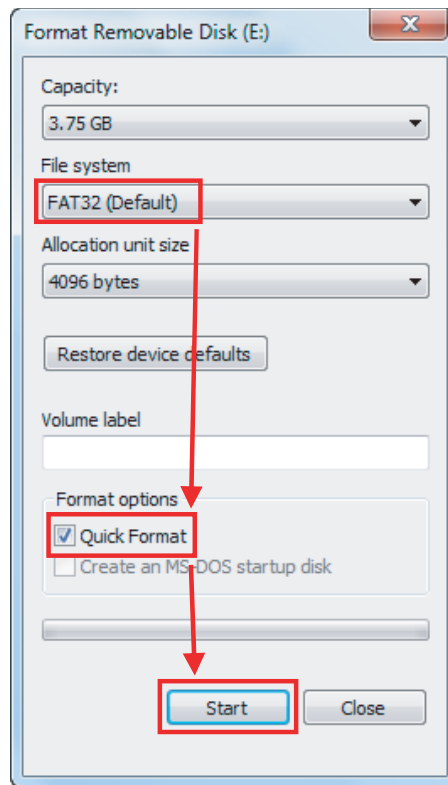

Figure 2:34. Format USB Flash Disk (2 of 2)

4. Click **OK** to confirm when the following dialog is shown.

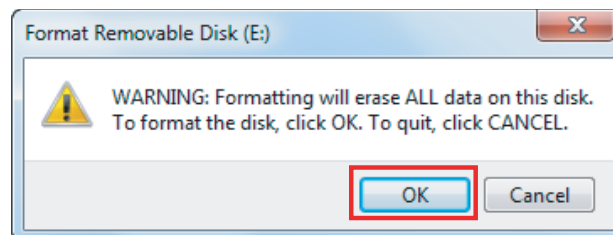

Figure 2:35. Confirm Format

5. When formatting is complete, click **OK** to close the dialog.

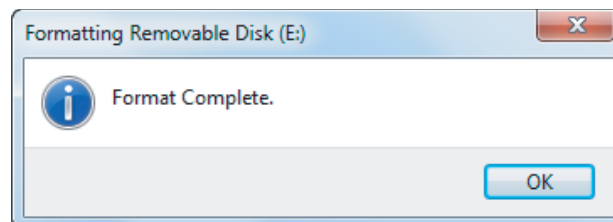

Figure 2:36. Format Complete

- In *Windows* OS, unzip the compressed BIOS ROM package (e.g. in this case, "Q1VZC102.zip").
- Copy the files "Q1VZC102.bin" and "KAFE102A.rom" to the root directory of the USB flash disk.

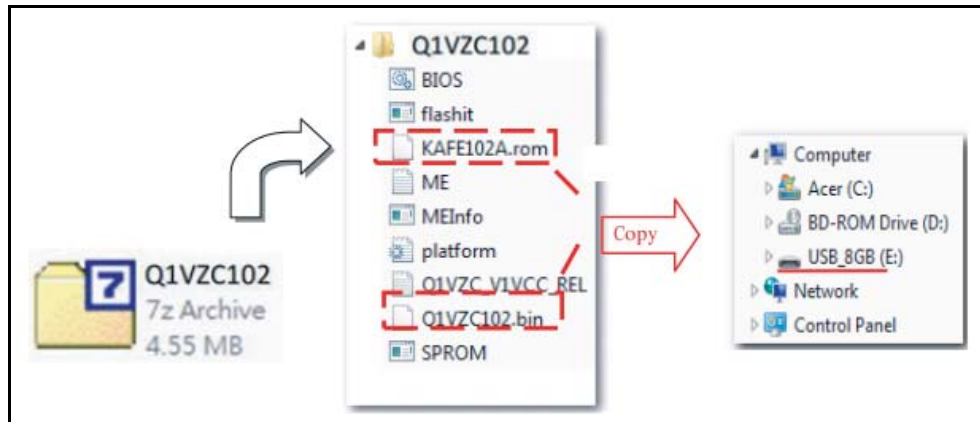

Figure 2:37. Copy *.BIN and *.ROM Files to USB Disk

- Press **⊞ + <R>** and type "cmd" to bring out the Command Line window.

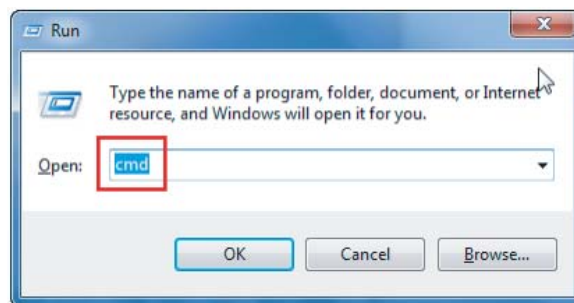

Figure 2:38. Command Line Window

- Combine EC (128 KB) and BIOS (5120 KB) into one ROM (5248 KB) file by typing the following:

```
Copy /b [EC ROM filename] + [BIOS ROM filename] BIOS.fd
```

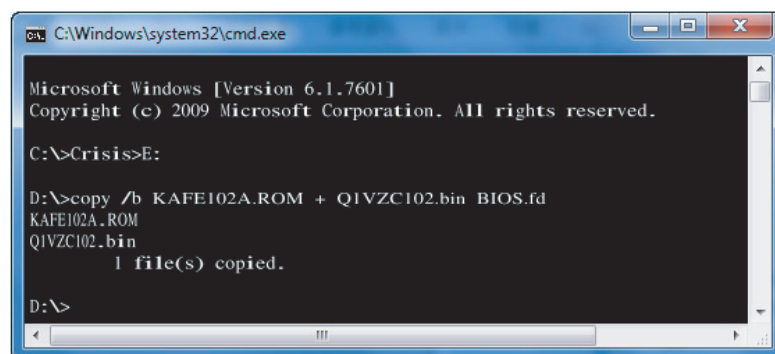

Figure 2:39. Combine EC and BIOS Files

⇒ NOTE:

Make sure the size of BIOS.fd is 5.12 MB, and check that there is no other *.FD file in the root directory of the USB flash disk.



Using the Crisis Utility Disk

1. Turn off the target machine and unplug the AC adapter.

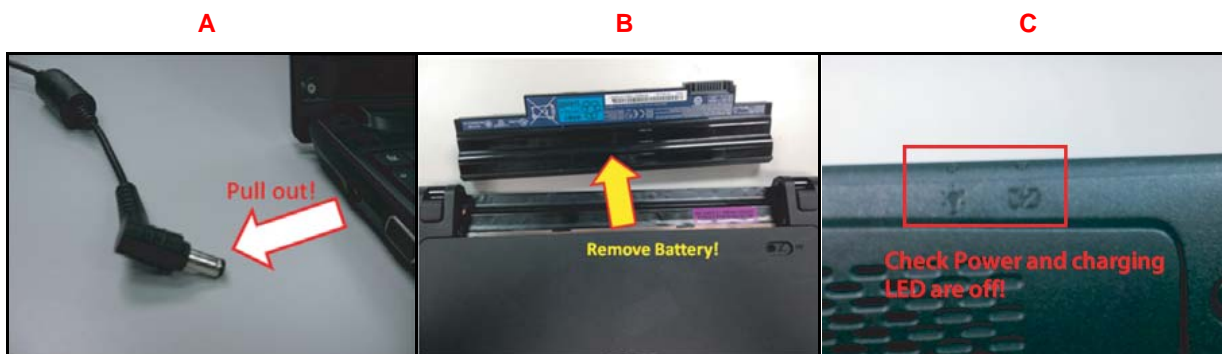

Figure 2:40. Ensure Power is Off

2. Plug the USB flash disk.



Figure 2:41. Plug the USB Flash Disk

3. Press and hold **<Fn>** and **<Esc>**, then plug in the AC adapter.

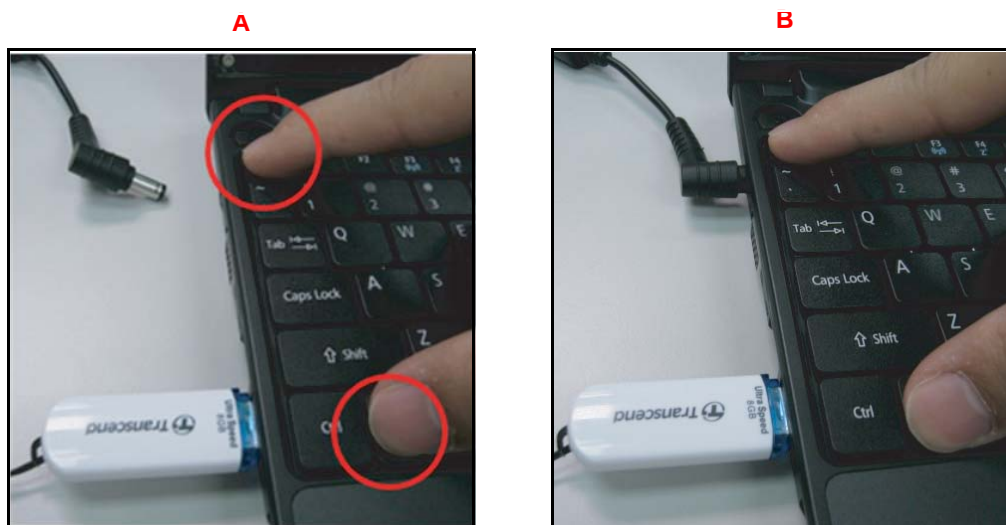

Figure 2:42. Hold Down **<Fn>** + **<Esc>** and Plug AC Adapter

4. As **<Fn>** and **<Esc>** keys are pressed, press the **Power** button to turn on the target machine. Wait for 3~5 seconds to make sure the system fan is in full speed before releasing **<Fn>** and **<Esc>** keys.



Figure 2:43. Press the Power Button

5. Wait for 3~5 minutes for the system to complete the crisis operation.

⇒ NOTE:

If the waiting time takes more than 5 minutes, the system recovery might have failed. Please check the following:

- BIOS filename (i.e. BIOS.fd) is correct on the USB flash Crisis disk.
- Pull out the AC adapter and remove the battery to reset the embedded controller status
- Repeat steps 1~5.

Jumper and Connectors Location

Jumper and Connector Locations	3-2
Mainboard Top View	3-2
Mainboard Bottom View	3-3
LED Board View	3-4
IO Board View	3-5
HDD Board View	3-6
Clear CMOS Jumper	3-7

Jumper and Connector Locations

Mainboard Top View

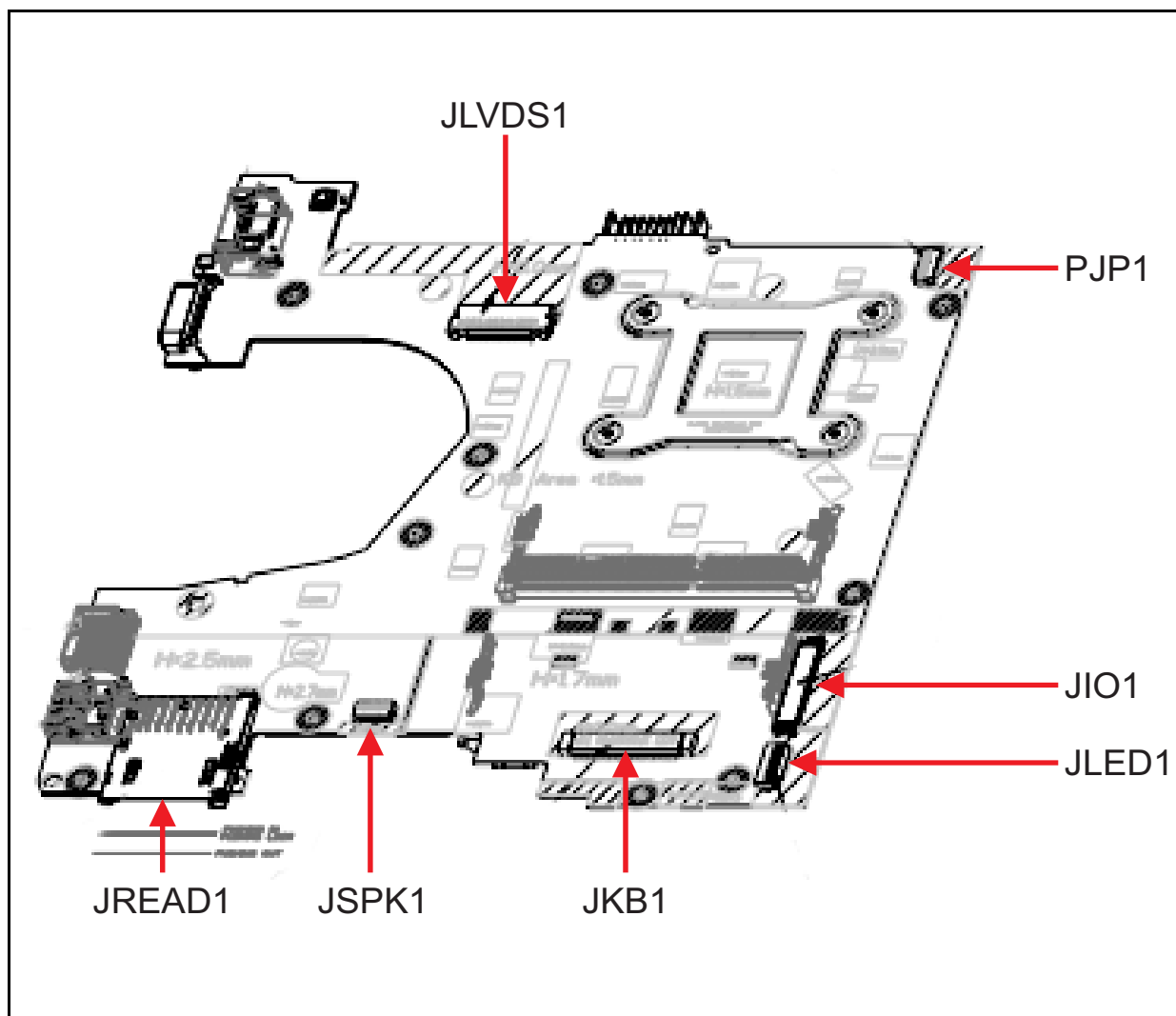

Figure 3:1. Mainboard Top

Table 3:1. Mainboard Top Jumper and Connectors

Item	Description
JLVD1	LVDS Connector
JREAD1	2 in 1 Card Reader Connector
JSPK1	Speaker Connector
JKB1	Keyboard Connector
JLED1	LED/B Connector
JIO1	IO/B Connector
PJP1	DC-In Connector

Mainboard Bottom View

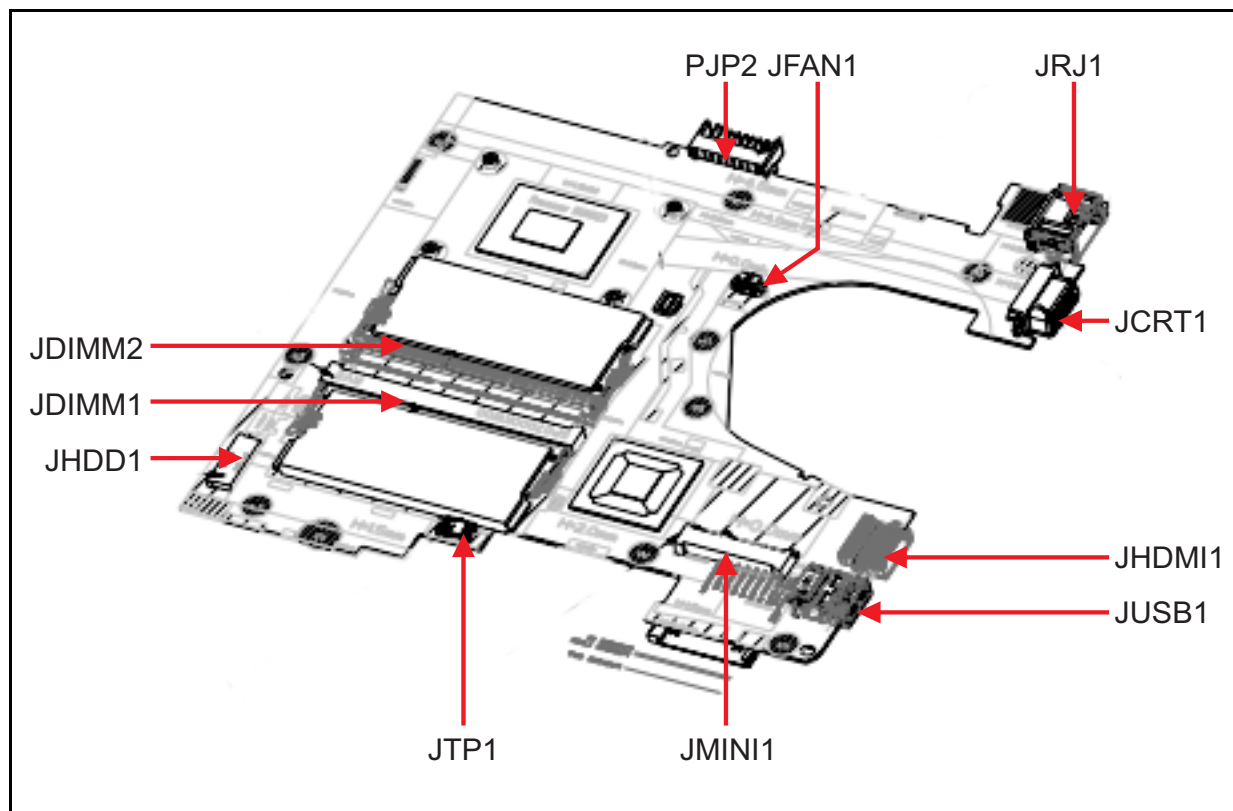

Figure 3:2. Mainboard Bottom

Table 3:2. Mainboard Bottom Jumper and Connectors

Item	Description	Item	Description
PJP2	Battery Connector	JMINI1	Mini Card Connector
JFAN1	Fan Connector	JCRT1	D-SUB Connector
JRJ1	RJ45 Connector	JHDMI1	HDMI Connector
JDIMM2	DDR3 STD Connector	JUSB1	USB2.0 / USB3.0 Connector
JDIMM1	DDR3 REV Connector		
JHDD1	HDD/B Connector		
JTP1	Touchpad Connector		

LED Board View

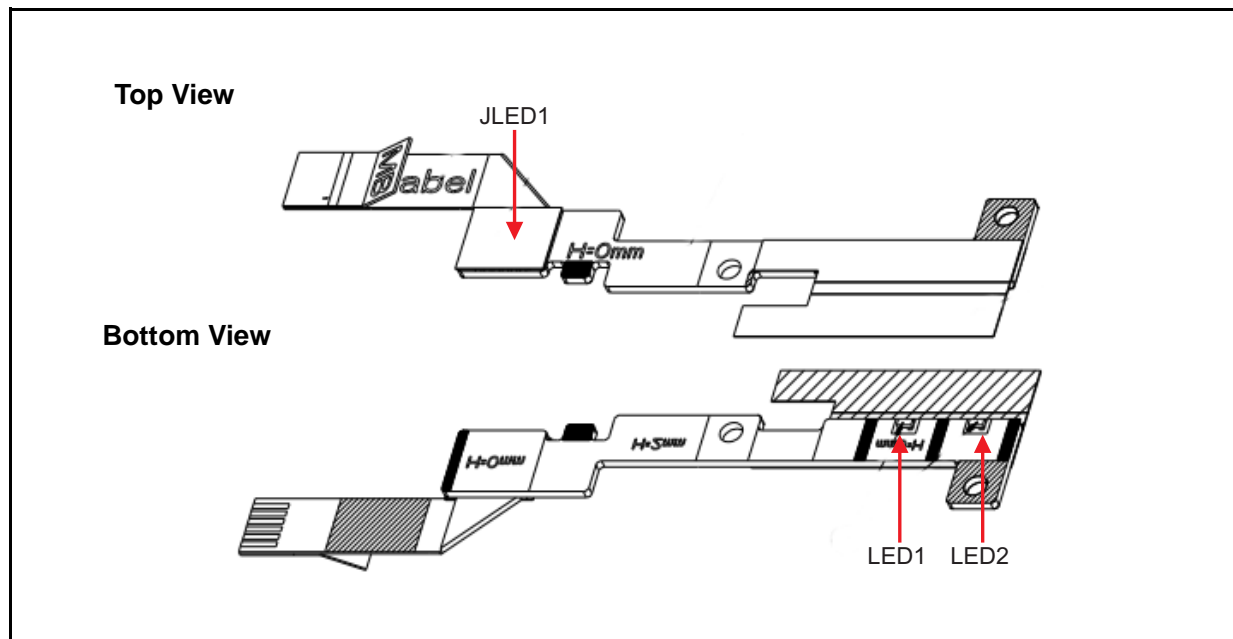

Figure 3:3. LED Board Jumper

Table 3:3. LED Board Jumper

Item	Description
JLED1	LED/B FFC Hot-bar
LED1	System State LED
LED2	Battery State LED

IO Board View

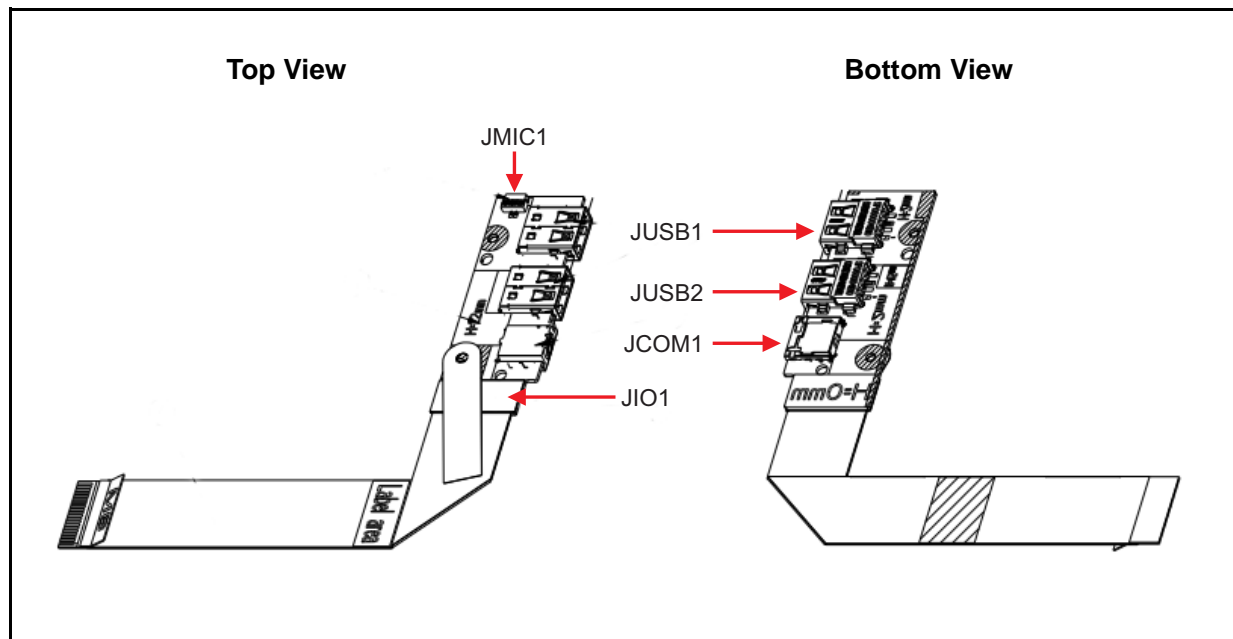

Figure 3:4. IO Board Jumper

Table 3:4. IO Board Jumper

Item	Description
JMIC1	Internal MIC Connector
JUSB1	USB2.0 Connector
JUSB2	USB2.0 Connector
JCOM1	Combo Jack Connector
JIO1	IO/B FFC Hot-bar

HDD Board View

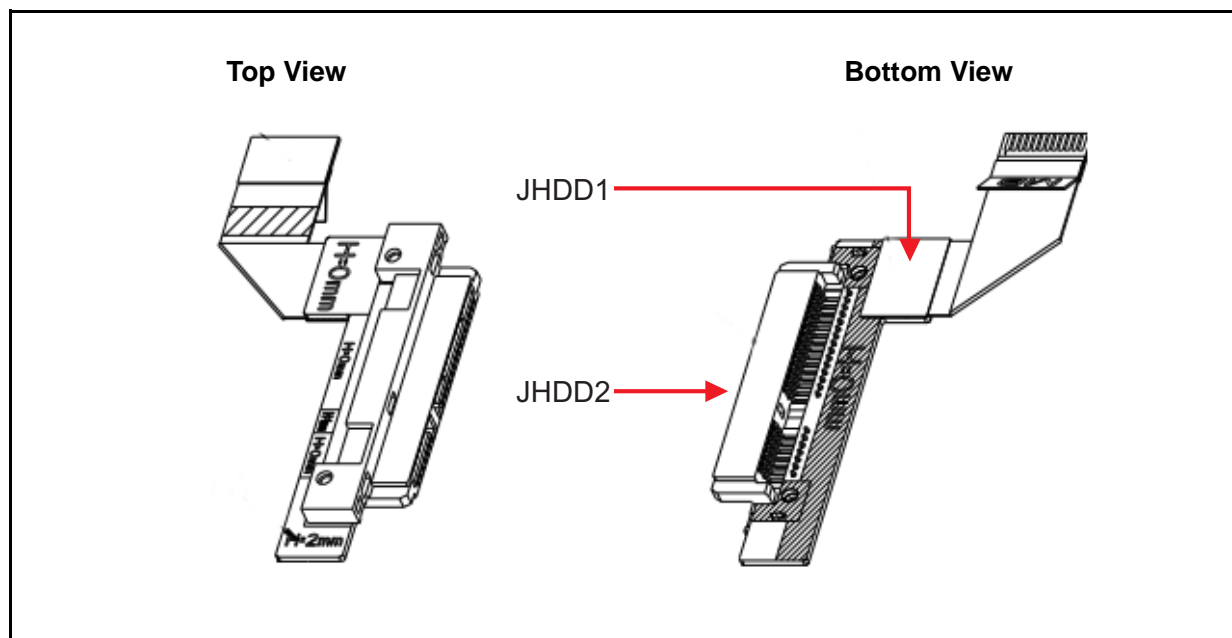

Figure 3:5. IO Board Jumper

Table 3:5. IO Board Jumper

Item	Description
JHDD1	HDD Connector
JHDD2	HDD/B FFC Hot-bar

Clear CMOS Jumper

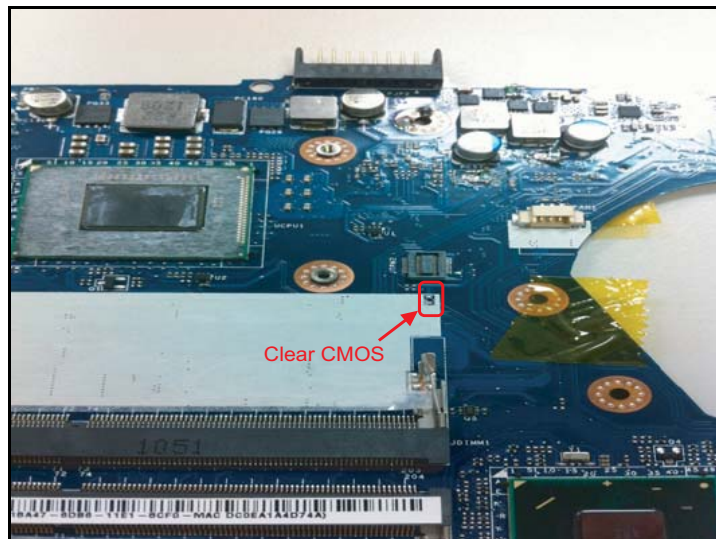

Figure 3:6. Clear CMOS

Table 3:6. Clear CMOS Jumper

Item	Description
R74	Clear CMOS Jumper (BOT)
C163	Clear CMOS Jumper (TOP)

Troubleshooting	4-2
General Information	4-2
Power On Issues	4-3
No Display Issues	4-4
LCD Picture Failure	4-6
Internal Keyboard Failure	4-7
Touchpad Failure	4-8
Internal Speaker Failure	4-9
Internal Microphone Failure	4-11
USB Failure (USB 2.0)	4-12
Wireless/BT Function Test Failure	4-13
2-in-1 Card Function Test Failure	4-14
Unit Thermal Failure	4-15
Cosmetic Failure	4-16
Other Functions Failure	4-17
BIOS Problems	4-17
Intermittent Problems	4-18
Undetermined Problems	4-18

Troubleshooting

This chapter contains information about troubleshooting common problems associated with the tablet.

General Information

The following procedures are a guide for troubleshooting computer problems. The step by step procedures are designed to be performed as described.

⇒ **NOTE:**

- The diagnostic tests are intended to test only Acer products. Non-Acer products, prototype cards, or modified options can give false errors and invalid system responses.
 - Do not replace a non-defective FRU.
1. Obtain as much detail as possible about the problem.
 2. If possible, verify the symptoms by re-creating the failure through diagnostic tests or by repeating the operation that led to the problem.
 3. Use Table 4-1 with the verified symptom(s) to determine the solution.

Table 4:1. Verified Symptoms

Symptoms	See
Power on Issues	Figure 4:1. Power On Issues on page 4-3
No Display Issues	Figure 4:2. No Display Issues on page 4-4
LCD Picture Failure	Figure 4:3. LCD Picture Failure on page 4-6
Internal Keyboard Failure	Figure 4:4. Internal Keyboard Failure on page 4-7
Touchpad Failure	Figure 4:5. Touchpad Failure on page 4-8
Internal Speaker Failure	Figure 4:6. Internal Speaker Failure on page 4-9
Internal Microphone Failure	Figure 4:7. Internal Microphone Failure on page 4-11
USB Failure	Figure 4:8. USB Failure on page 4-12
Wireless Function Failure	Figure 4:9. Wireless/BT Function Failure on page 4-13
2-in-1 Card Function Failure	Figure 4:10. 2-in-1 Card Function Failure on page 4-14
Units Thermal Failure	Figure 4:11. Unit Thermal Failure on page 4-15
Cosmetic Failure	Figure 4:12. Cosmetic Failure on page 4-16
Other Functions Failure	Page 4-17

4. If the issue is still not resolved, see [Online Support Information](#) on page [8-2](#).

Power On Issues

If the system does not power on, perform the following:

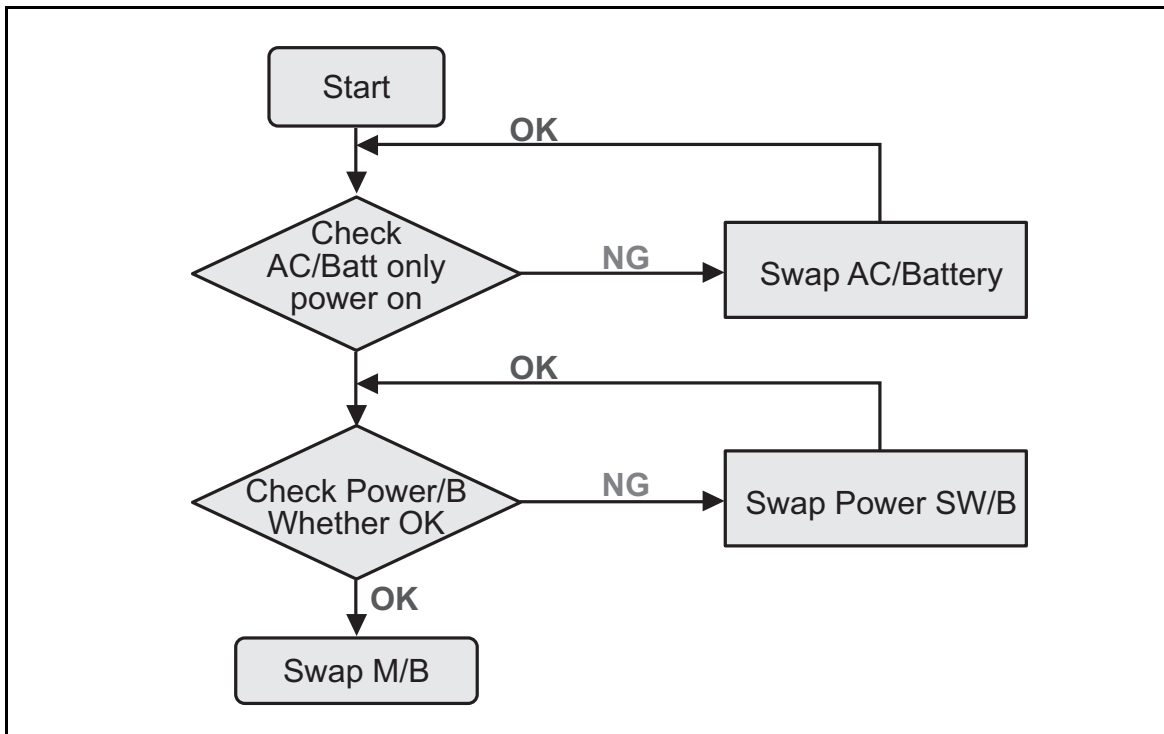

Figure 4:1. Power On Issues

Computer Shuts Down Intermittently

If the system powers off at intervals, perform the following.

1. Makes sure the power cable is properly connected to the computer and the electrical outlet.
2. Remove all extension cables between the computer and the outlet.
3. Remove all surge protectors between the computer and the electrical outlet. Plug the computer directly into a known serviceable electrical outlet.
4. Disconnect the power and open the casing to check the Thermal Unit (See [Unit Thermal Failure](#) on page 4-15) and fan airways are free of obstructions.
5. Remove all external and non-essential hardware connected to the computer that are not necessary to boot the computer to the failure point.
6. Remove any recently installed software.
7. If the issue is still not resolved, refer to [Online Support Information](#) on page 8-2.

No Display Issues

If the system does not display, perform the following:

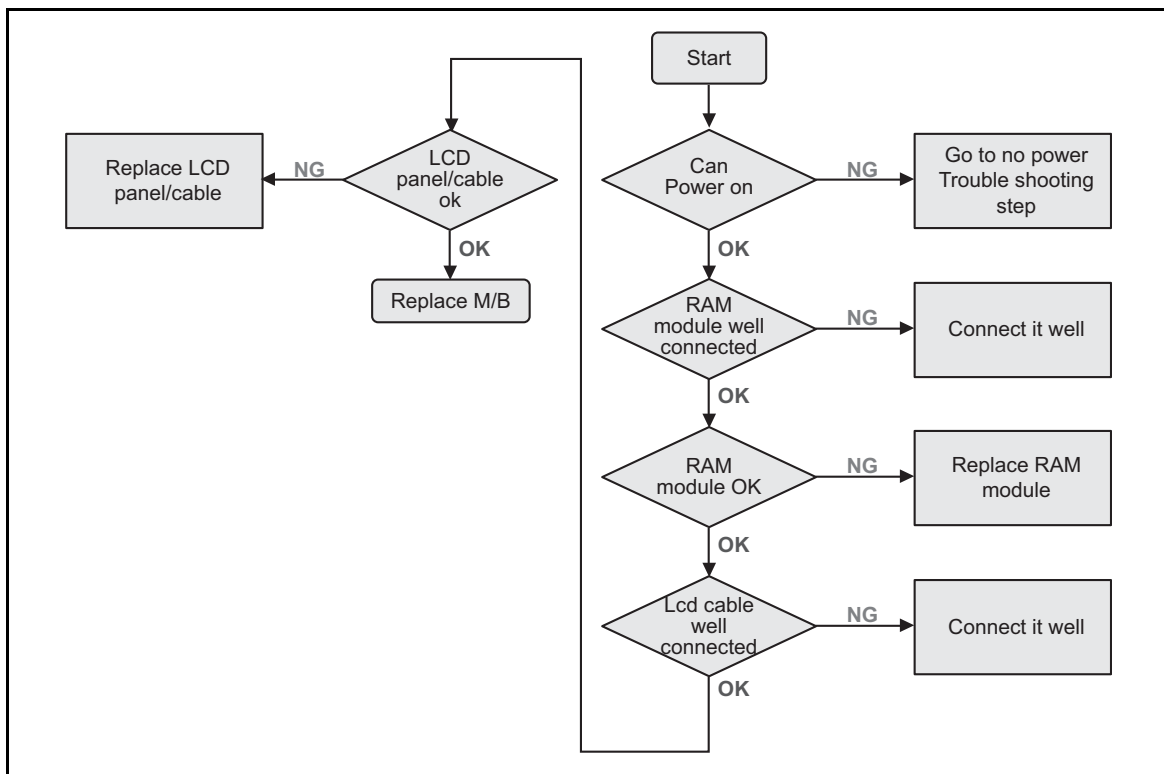

Figure 4:2. No Display Issues

No POST or Video

If the POST or video does not appear, perform the following:

1. Make sure that internal display is selected. Switching between internal and external by pressing Fn+F5. Reference Product pages for specific model procedures.
2. Make sure the computer has power by checking for one of the following:
 - Fans start up
 - Status LEDs illuminate
3. If there is no power, refer to [Power On Issues](#) on page 4-3. Otherwise, continue to the next step.
4. If there is power, drain the stored power by removing the power cable. Hold the power button for 10 seconds.
5. Connect the power and reboot the computer.
6. Connect an external monitor to the computer and switch between the internal display and the external display is by pressing Fn+F5.
7. If the POST or video appears on the external display only, refer to [LCD Picture Failure](#) on page 4-6. Otherwise, continue to the next step.
8. Disconnect the power and all external devices including port replicators or docking stations.
9. Remove any memory cards and CD/DVD discs.
10. Start the computer. If the computer boots correctly, add the devices one by one until the failure point is discovered.

11. Reseat the memory modules.
12. Remove the drives (refer to [Maintenance Flowchart](#) on page 5-4).
13. If the issue is still not resolved, refer to [Online Support Information](#) on page 8-2.

Abnormal Video

If the video appears abnormal, perform the following:

1. Boot the computer.
 - If permanent vertical/horizontal lines or dark spots appear in the same location, the LCD is faulty and should be replaced.
 - If extensive pixel damage is present (different colored spots in the same locations on the screen), the LCD is faulty and should be replaced.

⇒ NOTE:

Make sure that the computer is not running on battery alone as this may reduce display brightness.

2. Adjust the brightness to its highest level. Refer to the User Manual for instructions on adjusting the settings. If the display is too dim at the highest brightness setting, the LCD is faulty and should be replaced.
3. Check the display resolution is correctly configured:
 - Minimize or close all Windows.
 - If display size is only abnormal in an application, check the view settings and control/mouse wheel zoom feature in the application.
 - If desktop display resolution is not normal, right-click on the desktop and select *Personalize Display Settings*.
 - Click and drag the Resolution slider to the desired resolution.
 - Click **Apply** and check the display. Readjust if necessary.
4. Roll back the video driver to the previous version if updated.
5. Remove and reinstall the video driver.
6. Check the Device Manager to determine that:
 - The device is properly installed. There are no red Xs or yellow exclamation marks
 - There are no device conflicts
 - No hardware is listed under *Other Devices*
7. Run the *Windows Memory Diagnostic* from the operating system DVD and follow the on-screen prompts.
8. If the issue is still not resolved, refer to [Online Support Information](#) on page 8-2.

LCD Picture Failure

If the LCD picture fails, perform the following:

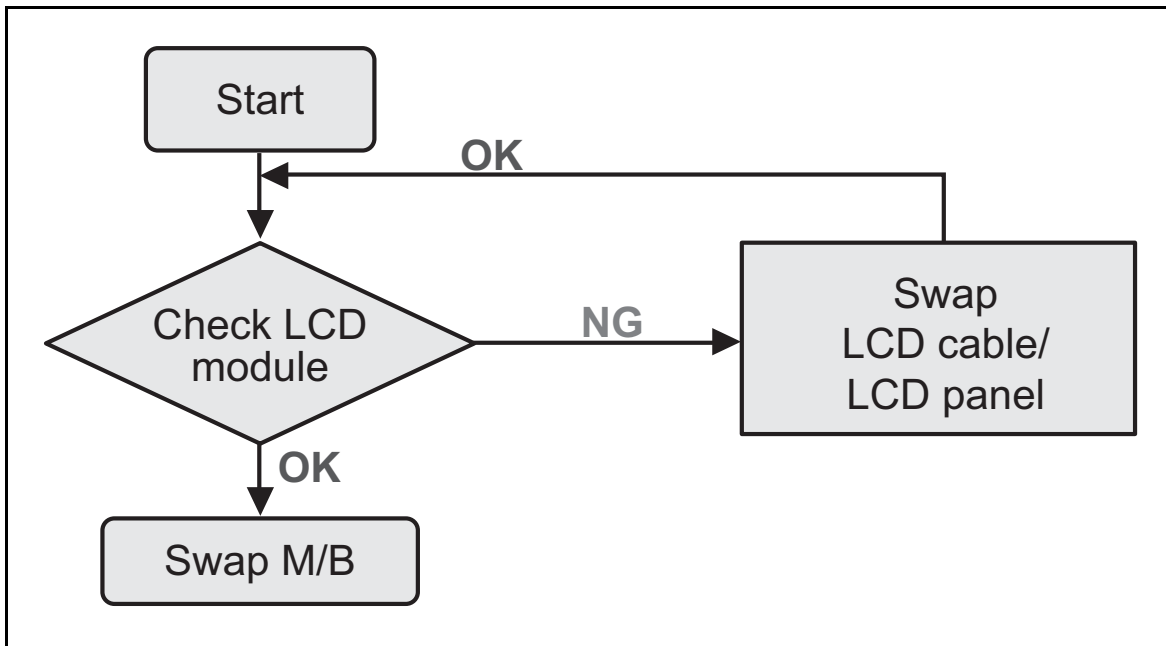

Figure 4:3. LCD Picture Failure

Internal Keyboard Failure

If the internal keyboard fails, perform the following:

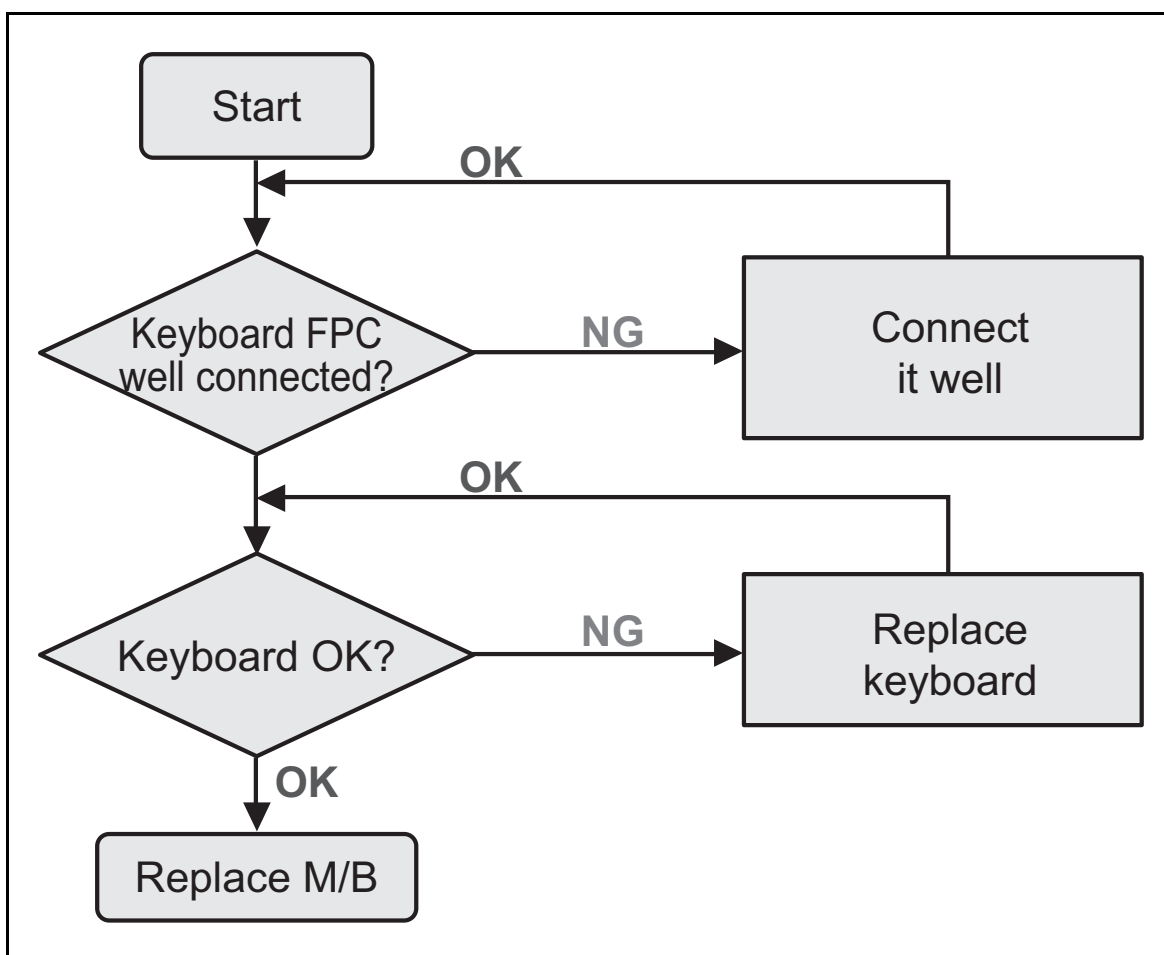

Figure 4:4. Internal Keyboard Failure

Touchpad Failure

If the touchpad fails, perform the following:

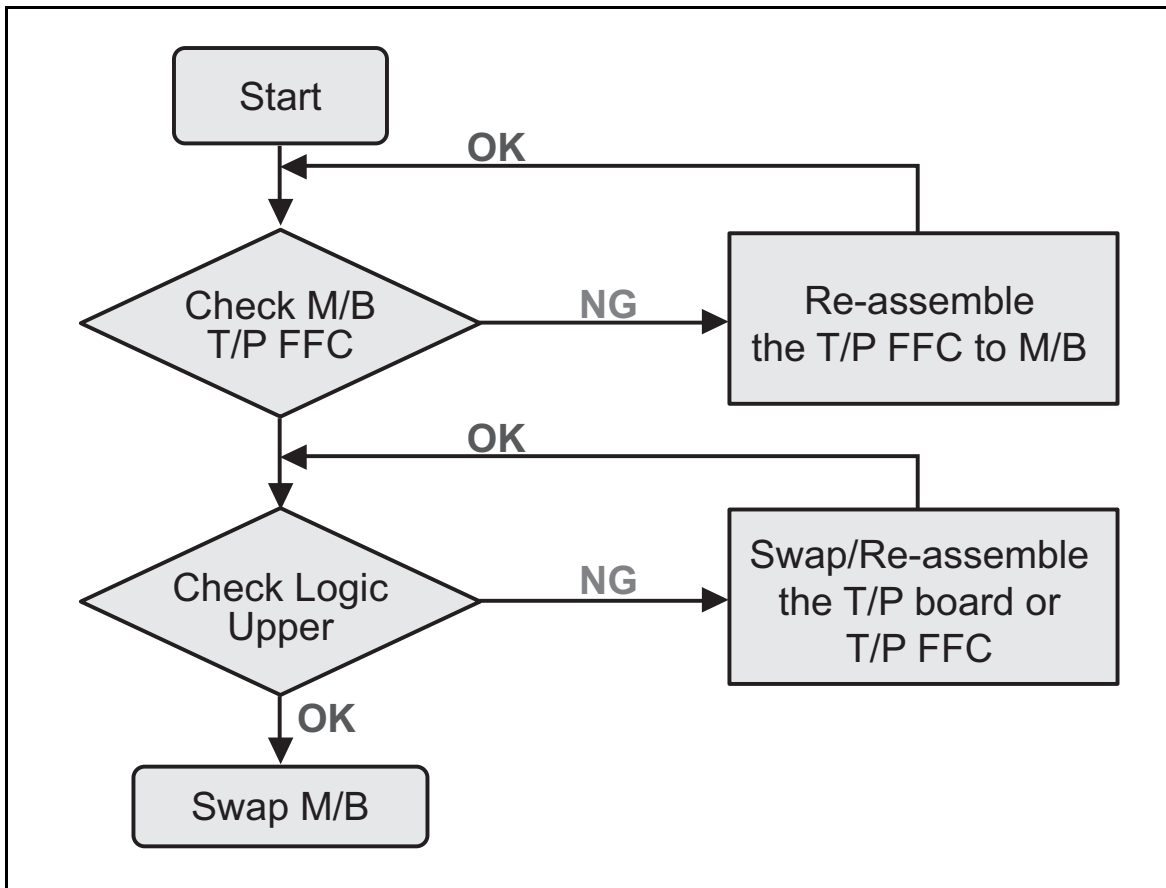

Figure 4:5. Touchpad Failure

Internal Speaker Failure

If the internal speakers fail, perform the following:

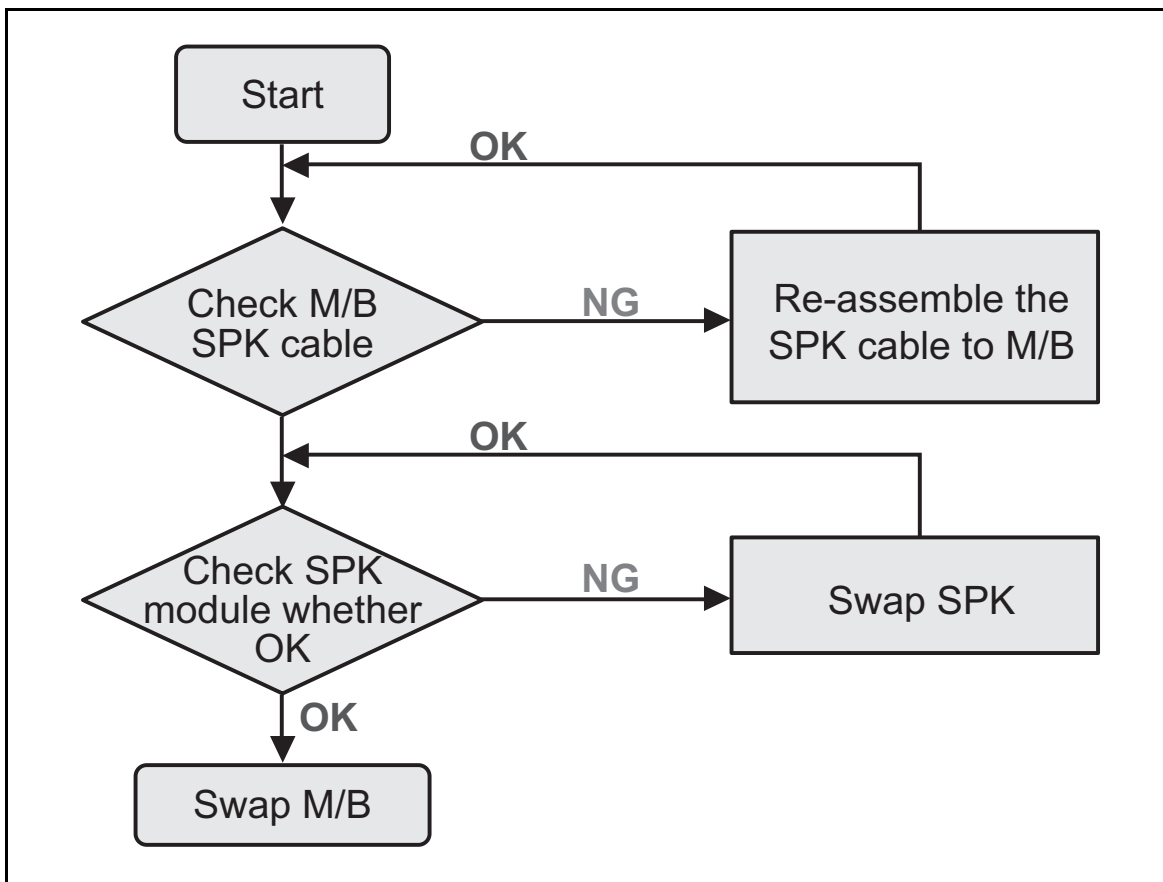

Figure 4:6. Internal Speaker Failure

Sound Problems

Perform the following:

1. Boot the computer.
2. Navigate to **Start > Control Panel > System and Maintenance > System > Device Manager**. Check the Device Manager to determine that:
 - The device is properly installed
 - There are no red Xs or yellow exclamation marks
 - There are no device conflicts
 - No hardware is listed under Other Devices
3. If updated recently, roll back the audio driver to the previous version.
4. Remove and reinstall the audio driver.
5. Make sure that all volume controls are set mid range:
 - Click the volume icon on the taskbar
 - Drag the slider to 50. Confirm that the volume is not muted.
 - Click Mixer to verify that other audio applications are set to 50 and not muted.

6. Navigate to **Start > Control > Panel > Hardware and Sound > Sound**. Confirm that Speakers is selected as the default audio device (green check mark).

⇒ **NOTE:**

If **speakers** is not shown, right-click on the **Playback** tab and select **Show Disabled Devices** (clear by default).

7. Select **speakers** and click **Configure** to start **Speaker Setup**. Follow the on-screen prompts to configure the speakers.
8. Remove any recently installed hardware or software.
9. Restore system and file settings from a known good date using **System Restore**.
10. If the issue is remains, repeat step 9, selecting an earlier time and date.
11. Reinstall the Operating System.
12. If the issue is still not resolved, refer to **Online Support Information** on page **8-2**.

Internal Microphone Failure

If the internal microphone fails, perform the following:

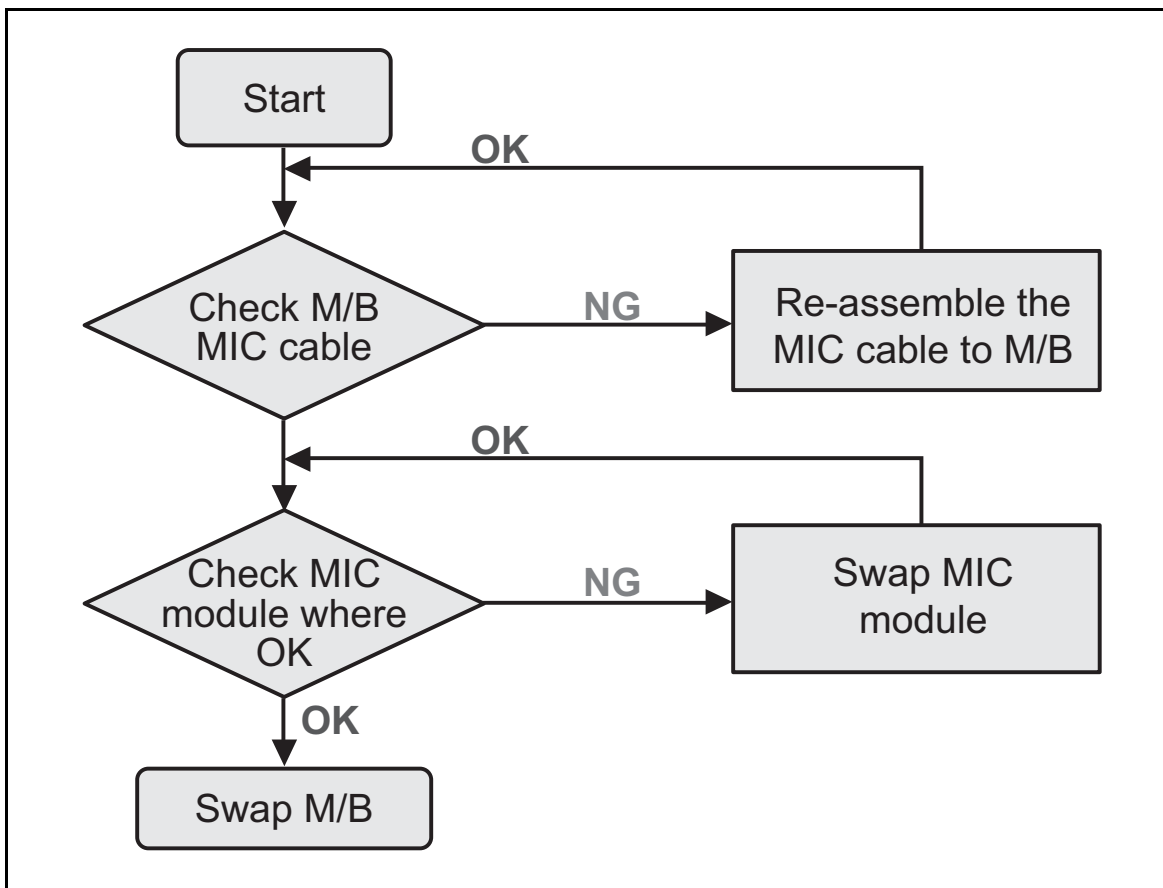

Figure 4:7. Internal Microphone Failure

1. Check that the microphone is enabled. Navigate to **Start > Control Panel > Hardware and Sound > Sound** and select the **Recording** tab.
2. Right click on the **Recording** tab and select **Show Disabled Devices** (clear by default). The microphone appears on the **Recording** tab.
3. Right click on the microphone and select **Enable**.
4. Select the microphone then click **Properties**. Select the **Levels** tab.
5. Increase the volume to the maximum setting and click **OK**.
6. Test the microphone hardware:
 - Select the microphone and click **Configure**.
 - Select **Set up microphone**.
 - Select the microphone type from the list and click **Next**.
 - Follow the on-screen prompts to complete the test.
7. If the issue is still not resolved, refer to [Online Support Information](#) on page **8-2**.

USB Failure (USB 2.0)

If the USB fails, perform the following:

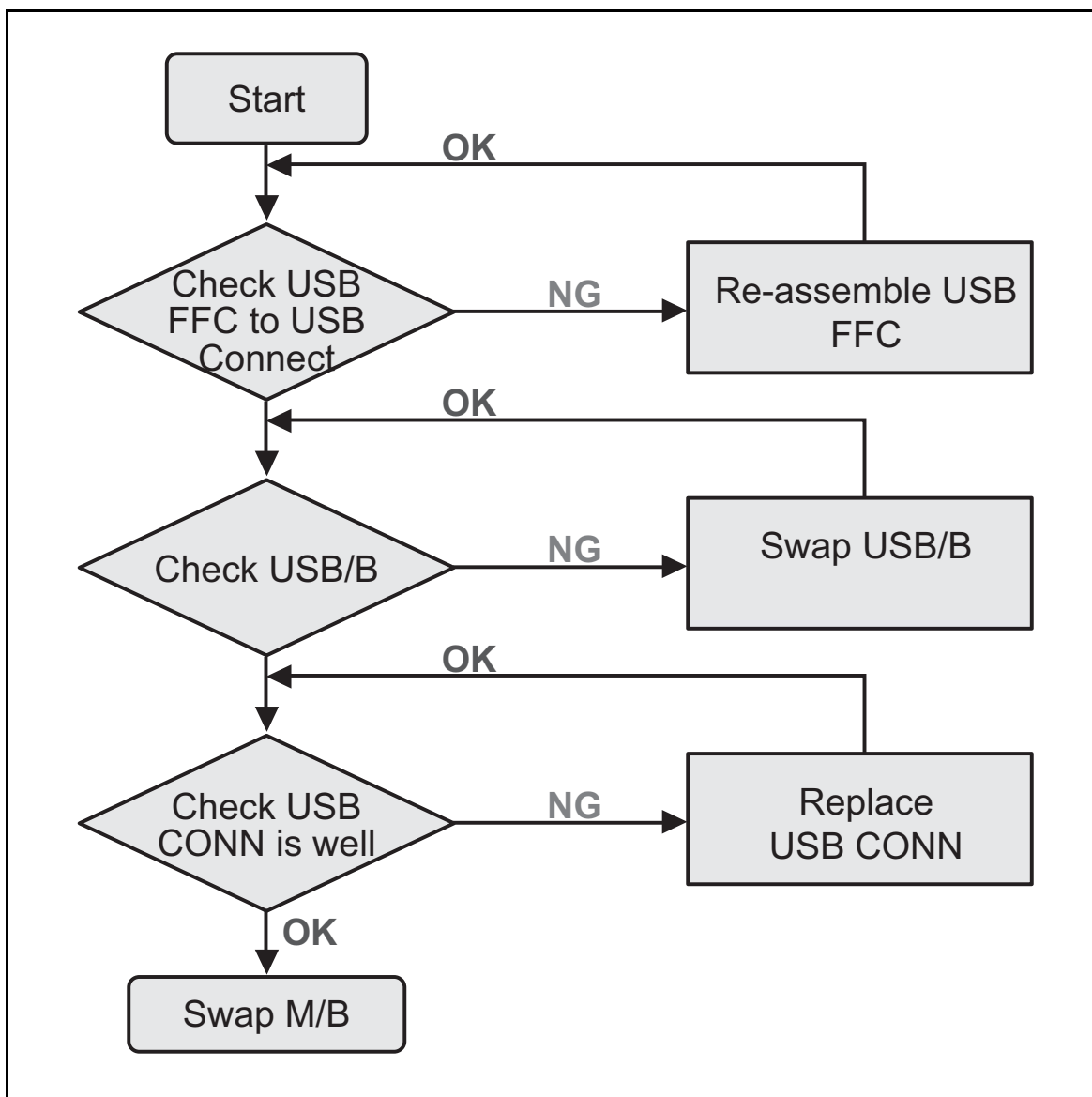

Figure 4:8. USB Failure

Wireless/BT Function Test Failure

If the wireless/BT function fails, perform the following:

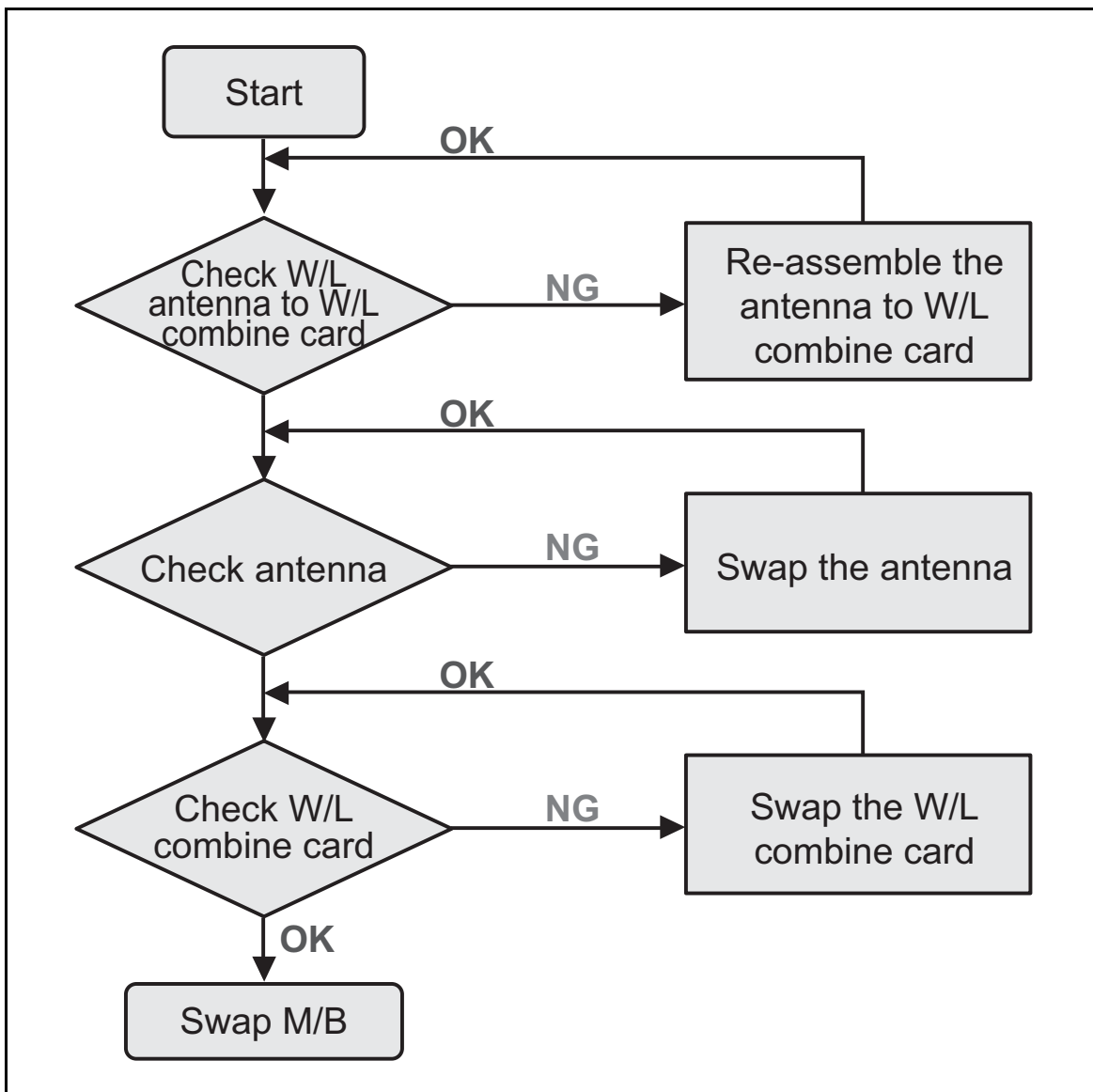

Figure 4:9. Wireless/BT Function Failure

2-in-1 Card Function Test Failure

If the 2-in-1 card function fails, perform the following:

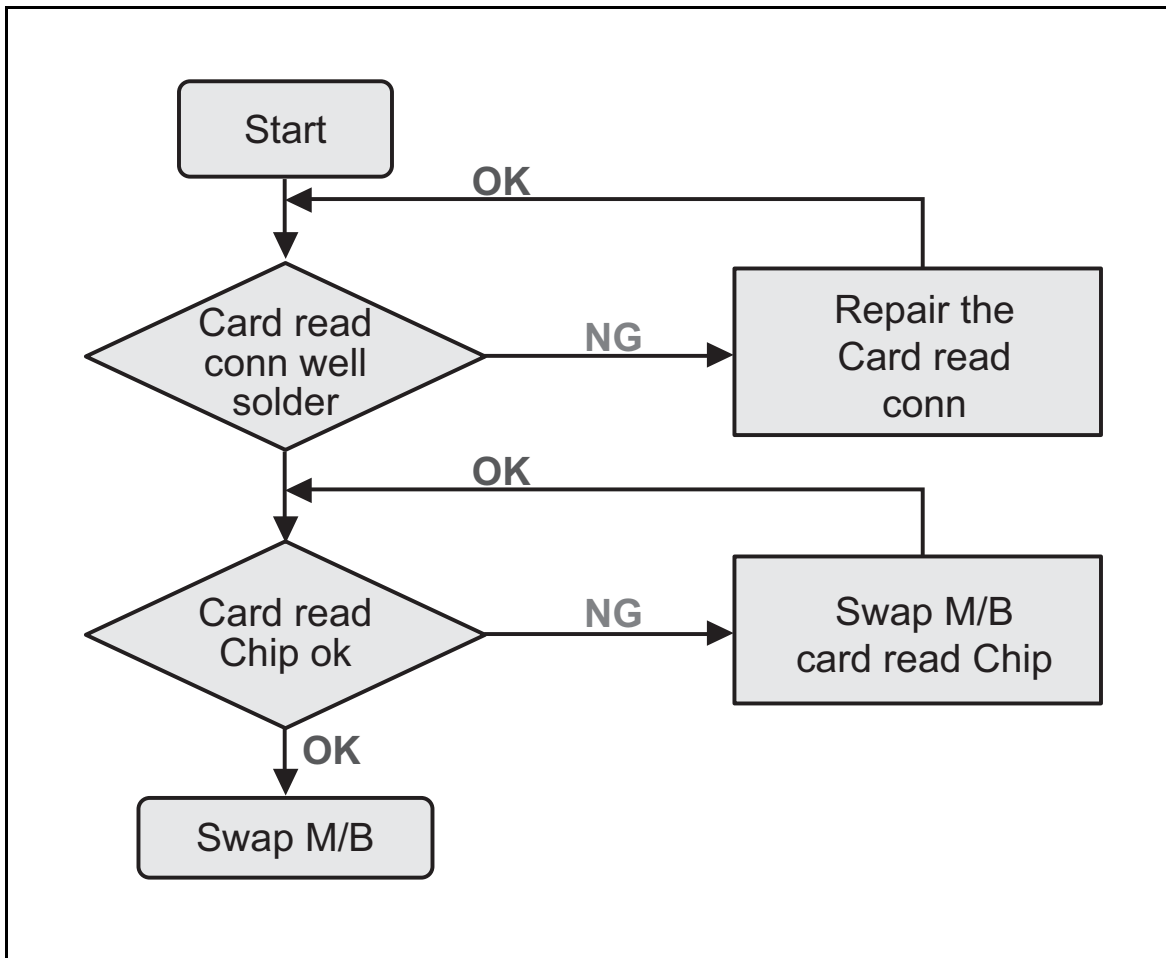

Figure 4:10. 2-in-1 Card Function Failure

Unit Thermal Failure

If the unit thermal fails, perform the following:

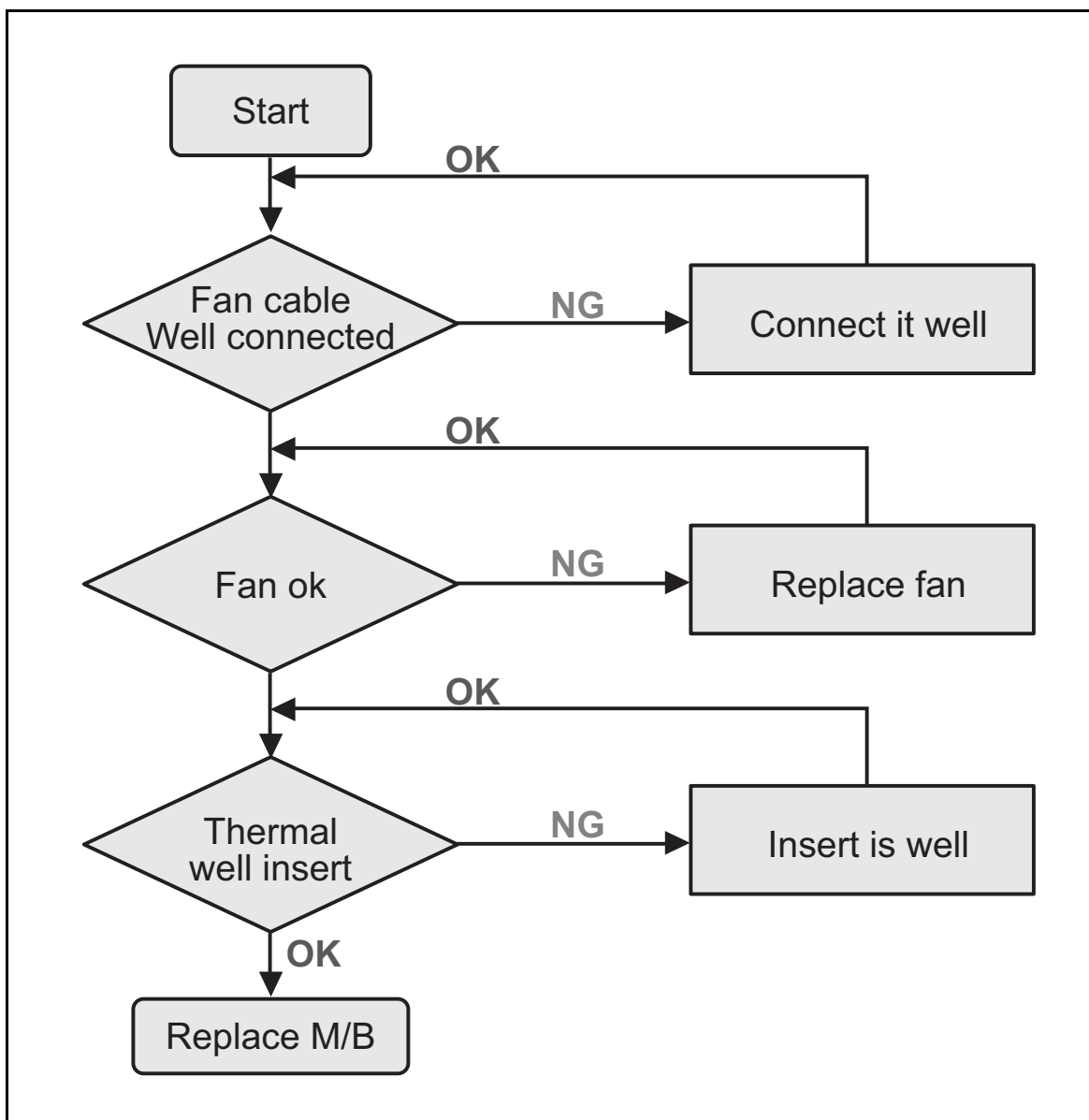

Figure 4:11. Unit Thermal Failure

Cosmetic Failure

If the cosmetic fails, perform the following:

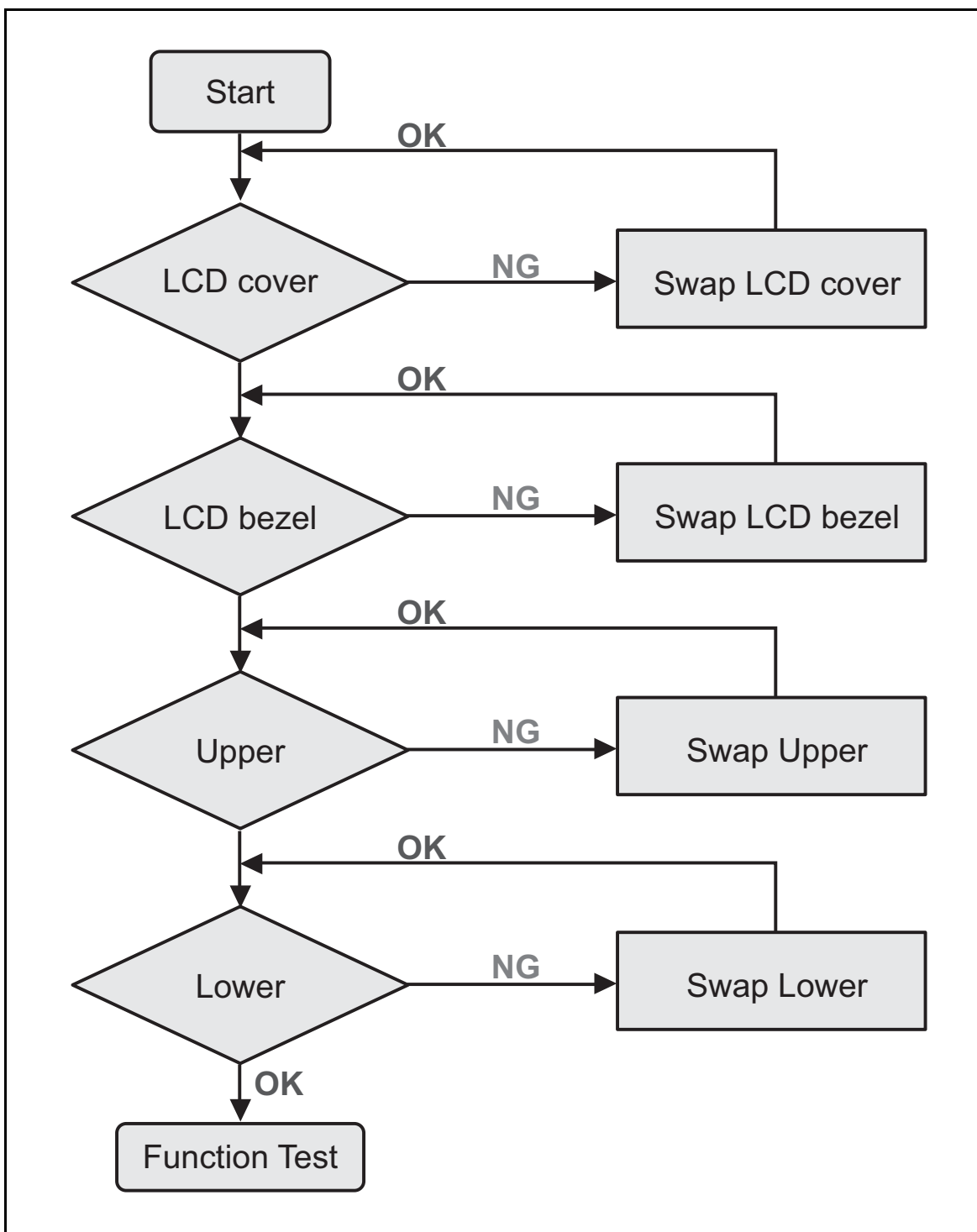

Figure 4:12. Cosmetic Failure

Other Functions Failure

If other functions such as the CRT switch, HDMI switch, LAN connection, external microphone, or external speaker fail, perform the following:

1. Check if the drive is ok.
2. Check if the test fixture is ok.
3. Swap the mainboard.

BIOS Problems

Forget BIOS Password

If the user forgets the BIOS password, discharge CMOS by shorting the CMOS connector.

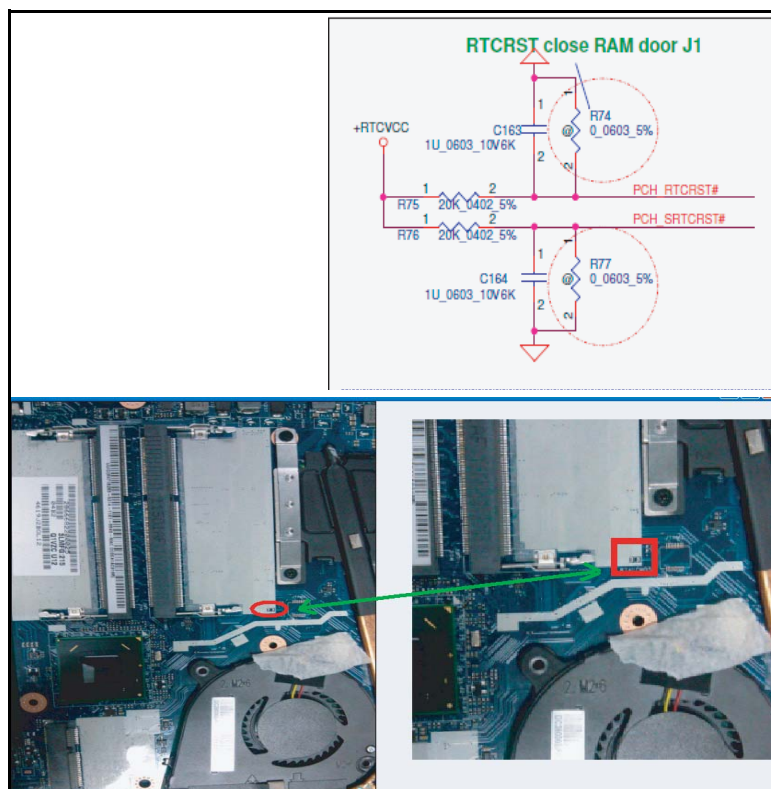

Figure 4:13. Discharge MB CMOS

Refer to [Clearing the Password Check and BIOS Password](#) on page 2-24.

Random Loss of BIOS Settings

If the computer is experiencing intermittent loss of BIOS information, perform the following:

1. If the computer is more than one year old, replace the CMOS battery.
2. Run a complete virus scan using up to date software to confirm the computer is virus free.
3. If the computer is experiencing HDD or ODD BIOS information loss, disconnect and reconnect the power and data cables between devices.
4. If the BIOS settings are still lost, replace the cables.

5. If HDD information is missing from the BIOS, the drive may be defective and should be replaced.
6. Replace the Motherboard.
7. If the issue is still not resolved, refer to [Online Support Information](#) on page [8-2](#).

Intermittent Problems

Intermittent system hang problems can be caused by a variety of reasons that have nothing to do with a hardware defect, such as: cosmic radiation, electrostatic discharge, or software errors. FRU replacement should be considered only when a recurring problem exists.

When analyzing an intermittent problem, perform the following:

1. Run the advanced diagnostic test (refer to [System Utilities](#) on page [2-2](#)) for the system board in loop mode at least 10 times.
2. If no error is detected, do not replace any FRU.
3. If an error is detected, replace the FRU. Rerun the test to verify that there are no more errors.

Undetermined Problems

The diagnostic problems do not identify which adapter or device failed, which installed devices are incorrect, whether a short circuit is suspected, or whether the system is inoperative.

⇒ NOTE:

- Verify that all attached devices are supported by the computer.
- Verify that the power supply being used at the time of the failure is operating correctly. (refer to [Power On Issues](#) on page [4-3](#)).

Perform the following procedures to isolate the failing FRU:

1. Remove power from the computer.
2. Visually check FRUs for damage. If any problems are found, replace the FRU.
3. Remove or disconnect all of the following devices:
 - Non-Acer devices
 - Printer, mouse, and other external devices
 - Battery pack
 - Hard disk drive
 - DIMM
 - CD-ROM/Diskette drive Module
 - PC Cards
4. Apply power to the computer.
5. Determine if the problem has changed.
6. If the problem does not recur, connect the removed devices until failing FRU is found.
7. If the problem remains, replace the following:
 - System board
 - LCD assembly

Service and Maintenance	5-3
Introduction	5-3
Recommended Equipment	5-3
Maintenance Flowchart	5-4
Getting Started	5-6
Battery Pack Removal	5-7
Battery Pack Installation	5-8
Dummy Card Removal	5-9
Dummy Card Installation	5-10
Base Door Removal	5-11
Base Door Installation	5-13
HDD Module Removal	5-15
HDD Module Installation	5-16
HDD Board Removal	5-17
HDD Board Installation	5-19
Fan Removal	5-21
Fan Installation	5-23
DIMM Module Removal	5-25
DIMM Module Installation	5-26
WLAN Module Removal	5-27
WLAN Module Installation	5-29
Upper Case Removal	5-31
Upper Case Installation	5-36
Mainboard Removal	5-39
Mainboard Installation	5-41
IO Board Removal	5-43
IO Board Installation	5-45
LED Board Removal	5-47
LED Board Installation	5-49
Speaker Removal	5-51

Service and Maintenance (cont.)

Speaker Installation	5-53
Keyboard Removal	5-55
Keyboard Installation	5-57
Touchpad Removal	5-59
Touchpad Installation	5-61
Thermal Module Removal	5-63
Thermal Module Installation	5-64
LCD Module Removal	5-66
LCD Module Installation	5-69
DC-In Cable Removal	5-72
DC-In Cable Installation	5-73
LCD Bezel Removal	5-74
LCD Bezel Installation	5-76
LCD Panel Removal	5-78
LCD Panel Installation	5-82
CCD Module Removal	5-86
CCD Module Installation	5-87
LCD Panel Brackets Removal	5-88
LCD Panel Brackets Installation	5-89
Microphone Removal	5-90
Microphone Installation	5-91
WLAN Antenna (Main) Removal	5-92
WLAN Antenna (Main) Installation	5-94
WLAN Antenna (Auxiliary) Removal	5-96
WLAN Antenna (Auxiliary) Installation	5-97

Service and Maintenance

Introduction









This chapter contains general information about the notebook, a list of tools needed to perform the required maintenance and step by step procedures on how to remove and install components on the notebook computer.

Recommended Equipment

The following tools are required to perform maintenance on the notebook:

- Wrist grounding strap and conductive mat
- Flat screwdriver
- Philips screwdrivers
- Pointed plastic pry or similar object

Table 5:7. Main Screw List

Screw Name	Screw Type	Quantity
M 2.0 x 2.5		6
M 2.0 x 3.0		10
M 2.0 x 3.0		9
M 2.0 x 6.0		21
M 3.0 x 3.0		2
M 2.0 x 3.0		4
M 1.7 x 2.5		11
M 2.0 x 4.0		2

Maintenance Flowchart

The flowchart in Figure3-1 provides a graphic representation of the module removal and installation sequences. It provides information on what components need to be removed and installed during servicing.

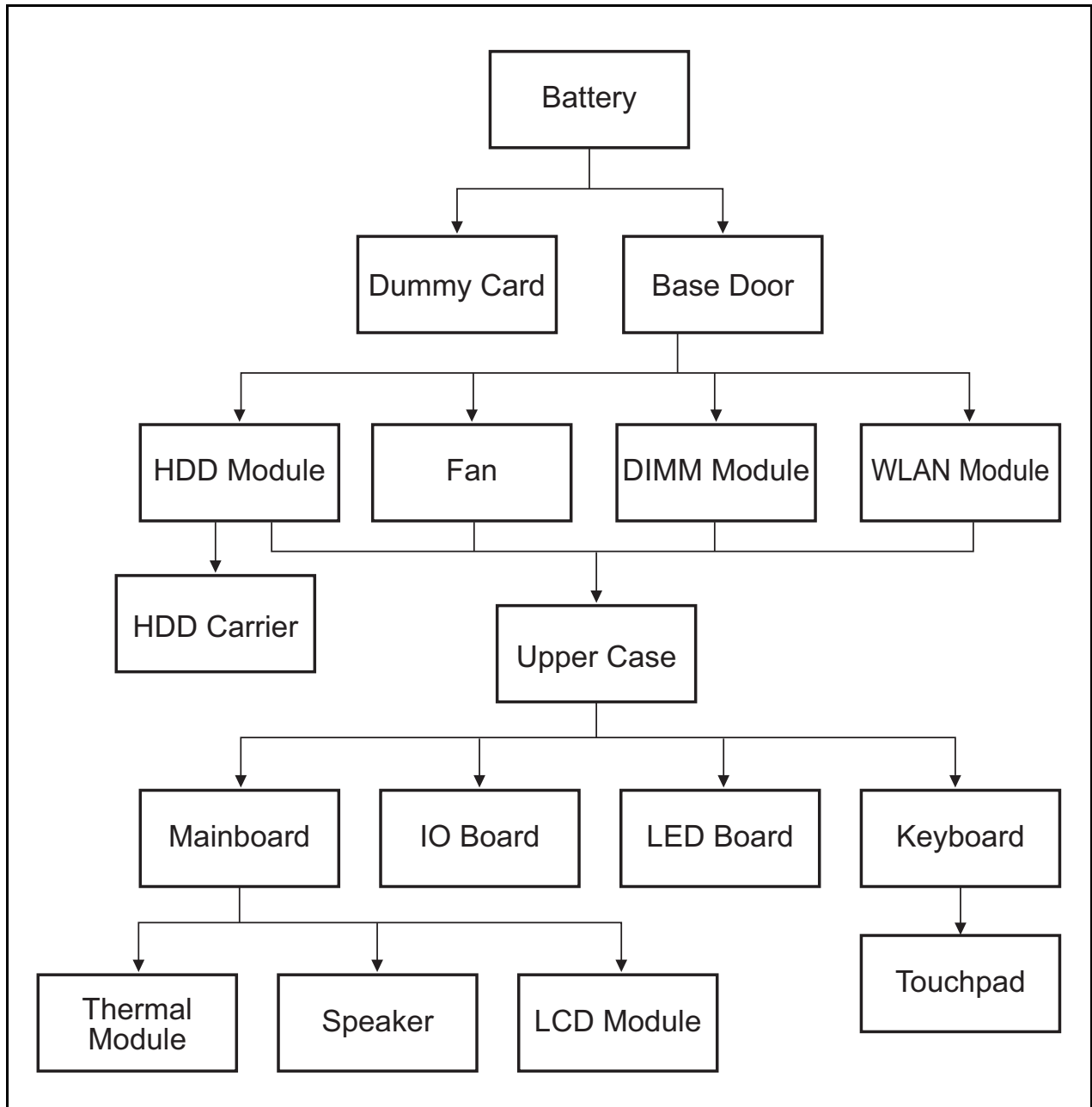

Figure 5:1. Maintenance Flow

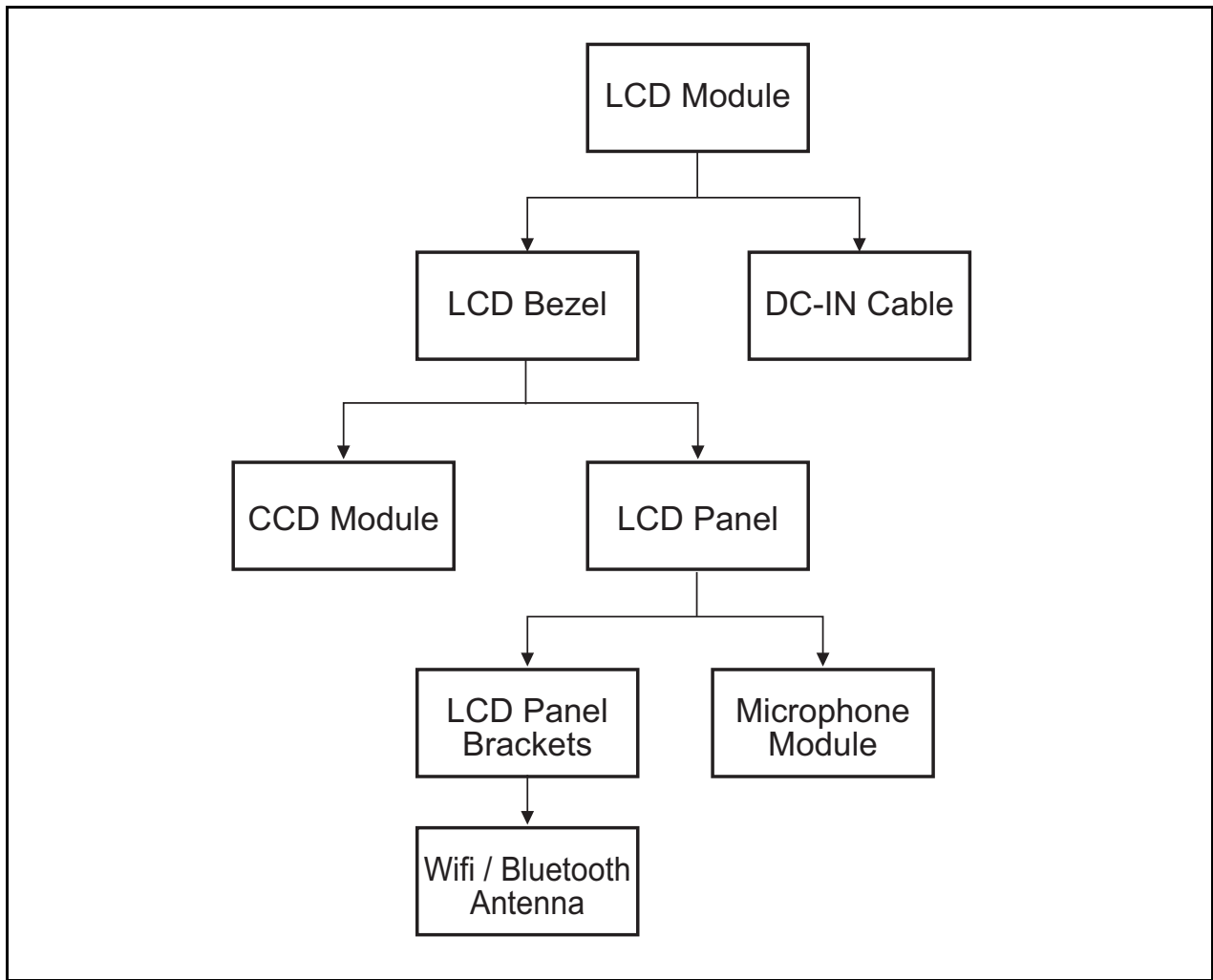

Figure 5:2. LCD Module Maintenance Flow

Getting Started

The flowchart ([Figure 5:1](#), page [5-4](#)) identifies sections illustrating the entire removal and installation sequence. Observe the order of the sequence to avoid damage to any of the hardware components.

Perform the following prior to performing any maintenance procedures:

1. Place the system on a flat work surface.
2. Make sure the system is completely powered down.
 - a. If the device is in powered up mode, shut down the system normally.
 - b. If the device is in sleep mode, wait for the Home Screen to clear. Then, shut down normally.
3. Disconnect the AC adapter and remove all cables from the system and its peripherals.



Figure 5:3. Disconnecting the Power Adapter

Battery Pack Removal

1. Place the computer on a flat surface with the battery side up.
2. Insert the plastic pry into the battery latch and slide to release the lock.
3. Slide to remove the battery pack

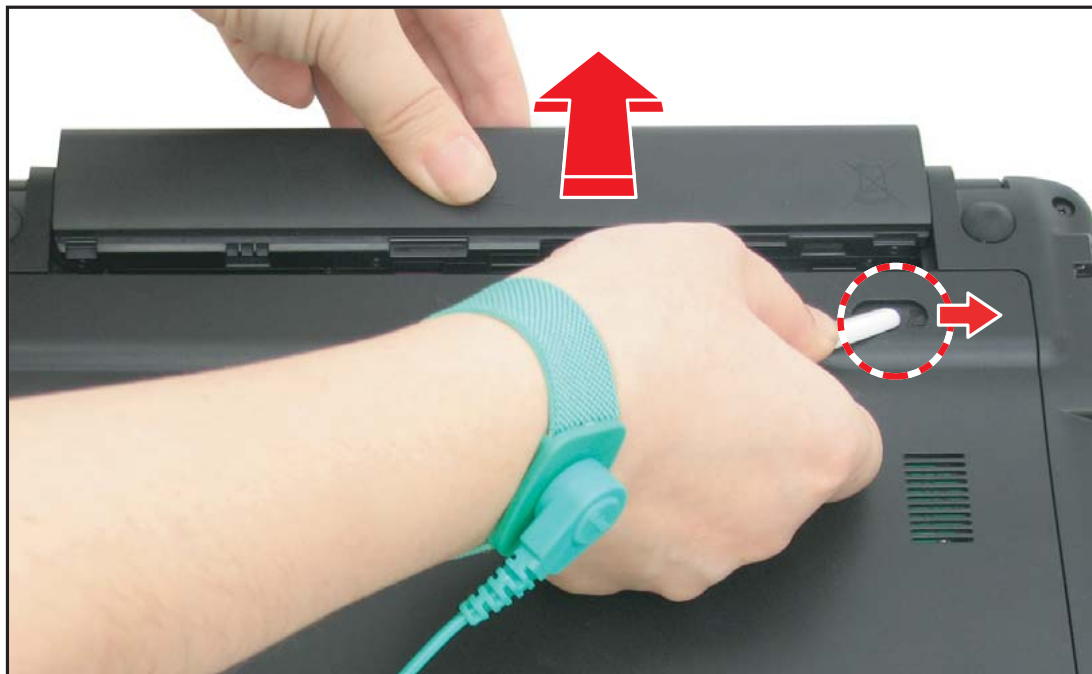

Figure 5:4. Removing the Battery Pack

Battery Pack Installation

Slide the battery pack into the battery compartment until it locks into place.



Figure 5:5. Installing the Battery Pack

Dummy Card Removal

1. Push the dummy card to eject the card from the slot.
2. Remove the card.



Figure 5:6. Removing the Dummy Card

Dummy Card Installation

Push the dummy card into the slot until it clicks into place.



Figure 5:7. Installing the SD Card

Base Door Removal

Prerequisite:

* [Battery Pack Removal](#) on page 5-7

1. Remove the 15 screws securing the upper and lower case.



Figure 5:8. Removing the Base Door Screw

2. Slide the base door to release its latches.



Figure 5:9. Removing the Base Door

The following modules are housed under the base door:

- HDD (Hard Disk Drive) module (A), see [HDD Module Removal](#) on page [5-15](#)
- DIMM (Dual-In Memory Module) (B), see [DIMM Module Removal](#) on page [5-25](#)
- Fan module (C), see [Fan Removal](#) on page [5-21](#)
- WLAN module (D), see [WLAN Module Removal](#) on page [5-27](#)

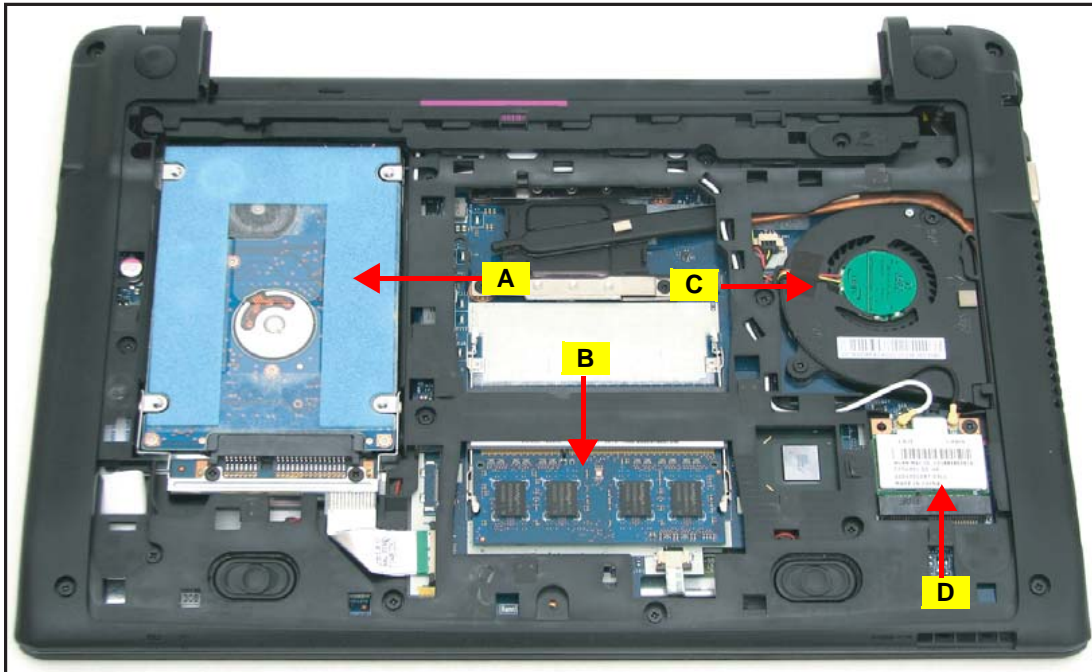

Figure 5:10. Mainboard Bottom Side Overview

Base Door Installation

1. Connect the Microphone cable connector to the mainboard connector.



Figure 5:11. Installing the Base Door

2. Secure the base door screw.



Figure 5:12. Securing the Base Door Screw

3. Install the battery pack (see [Battery Pack Installation](#) on page 5-8).

Table 5:8. Base Door Screw

Screw Name	Screw Type	Quantity
M 2.0 x 6.0		1

HDD Module Removal

Prerequisite:

※ [Base Door Removal](#) on page 5-11

1. Locate the HDD module (see [Figure 5:10](#), page 5-12).
2. Using a plastic pointed pry, push the mainboard connector clips outwards to release the HDD cable, and then pull the HDD cable to disconnect.



Figure 5:13. Disconnecting the HDD Cable

3. Insert your finger on the gap (A) then lift the HDD out from its bay.

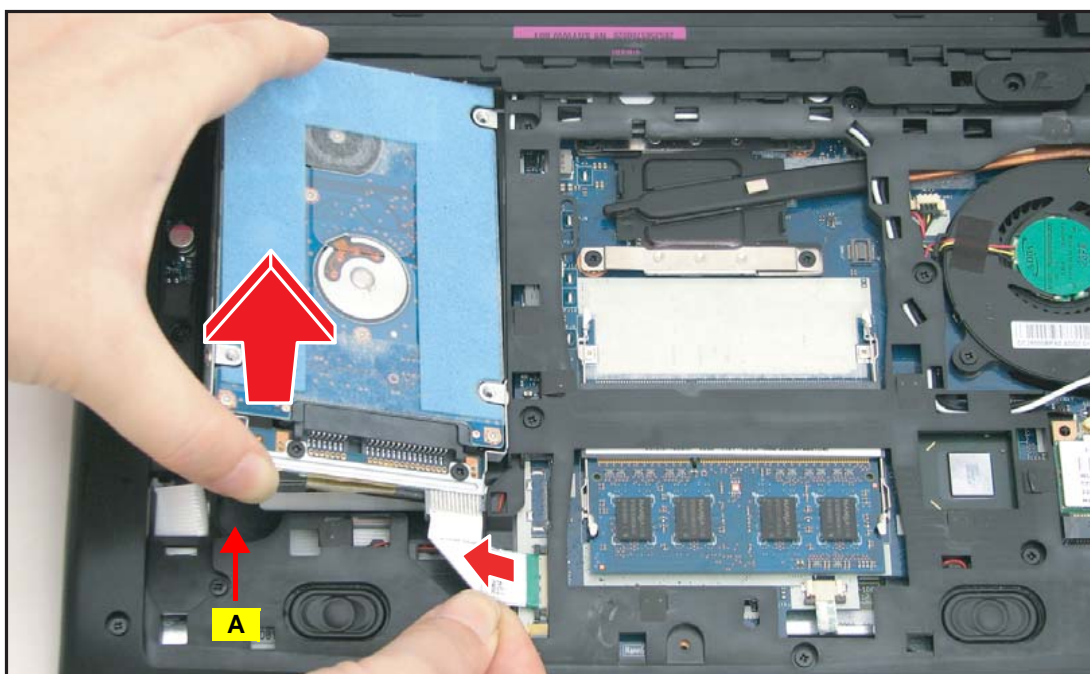

Figure 5:14. Removing the HDD Module

HDD Module Installation

1. Place the HDD module into the bay.

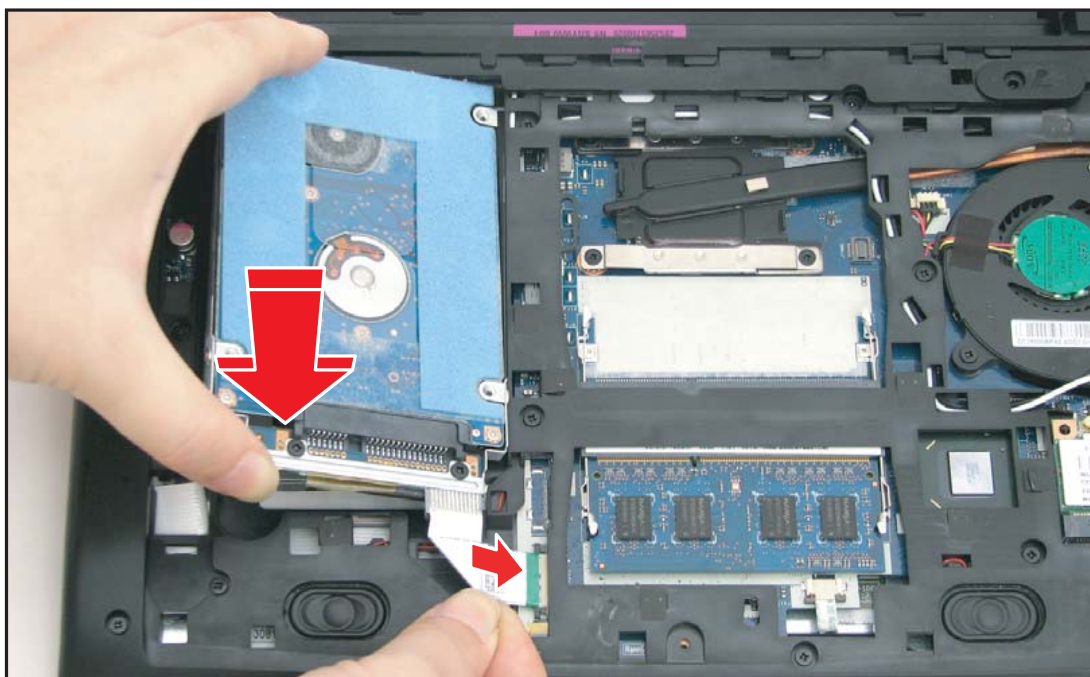

Figure 5:15. Installing the HDD Module

2. With the mainboard connector clips in outward position, connect the HDD cable connector. Then, push the connector clips inwards to lock.

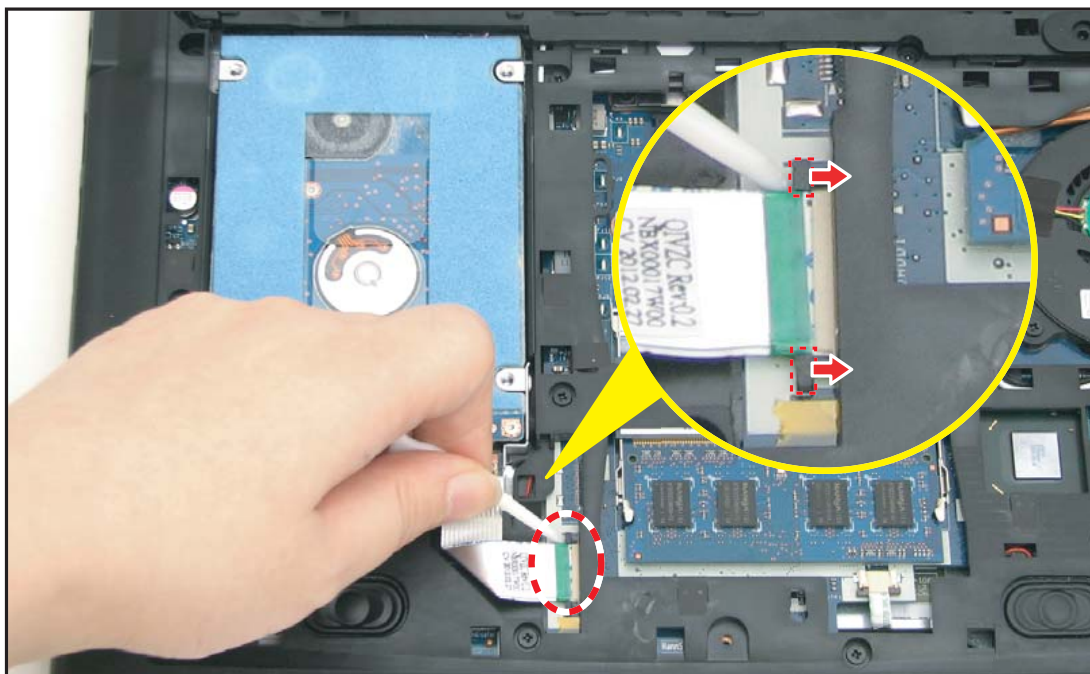

Figure 5:16. Connecting the HDD Cable

3. Install the base door (see [Base Door Installation](#) on page [5-13](#)).

HDD Board Removal

Prerequisite:

※ [Mainboard Removal](#) on page [5-39](#)

1. Remove the two (2) screws securing the HDD bracket to the HDD.



Figure 5:17. Removing the HDD Brackets

2. Pull to disconnect the HDD board connector from the HDD.

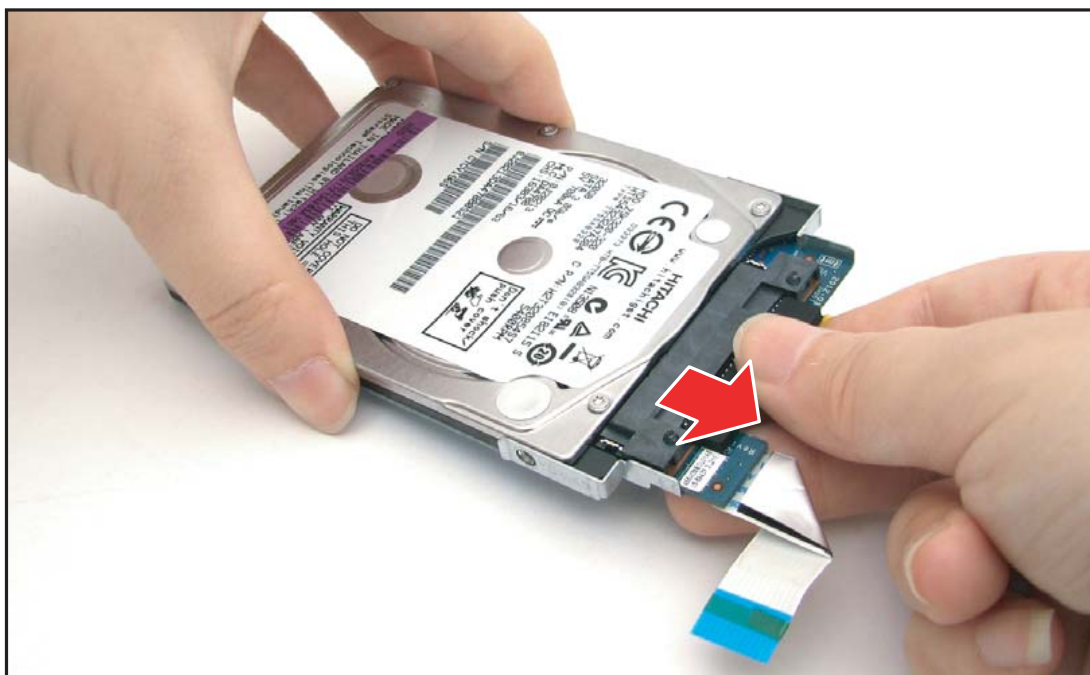

Figure 5:18. Disconnecting the HDD Connector

3. Remove the two (2) screws securing the HDD board to the HDD bracket.

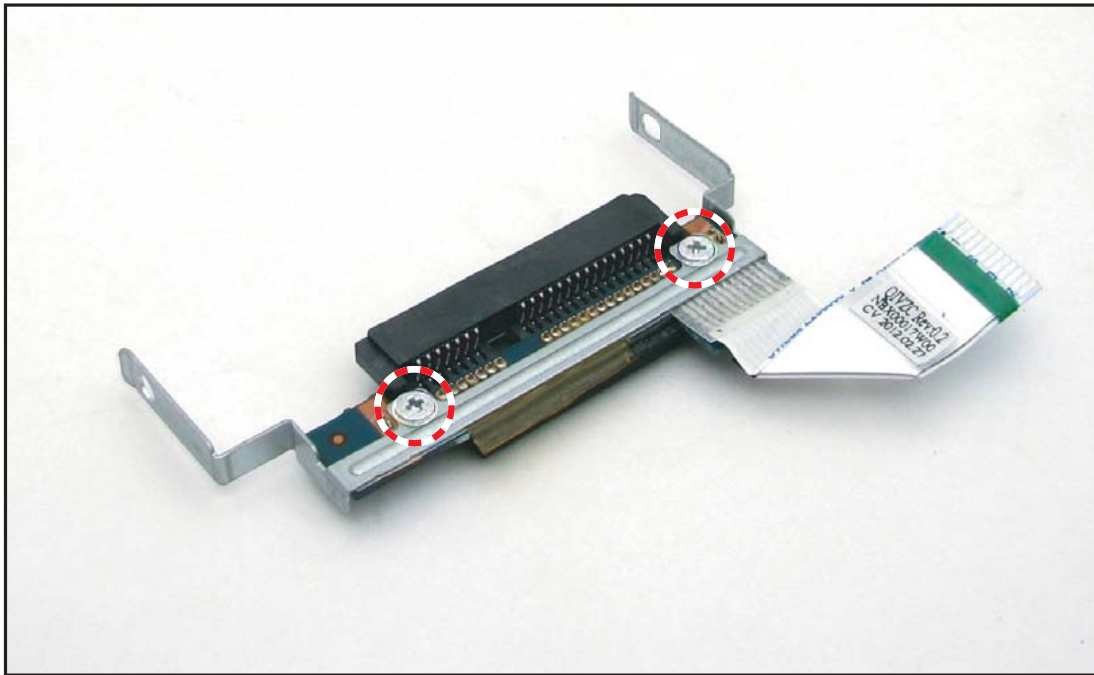

Figure 5:19. Removing the HDD Board Screws

HDD Board Installation

1. Attach the two (2) screws to secure the HDD board to the HDD bracket.

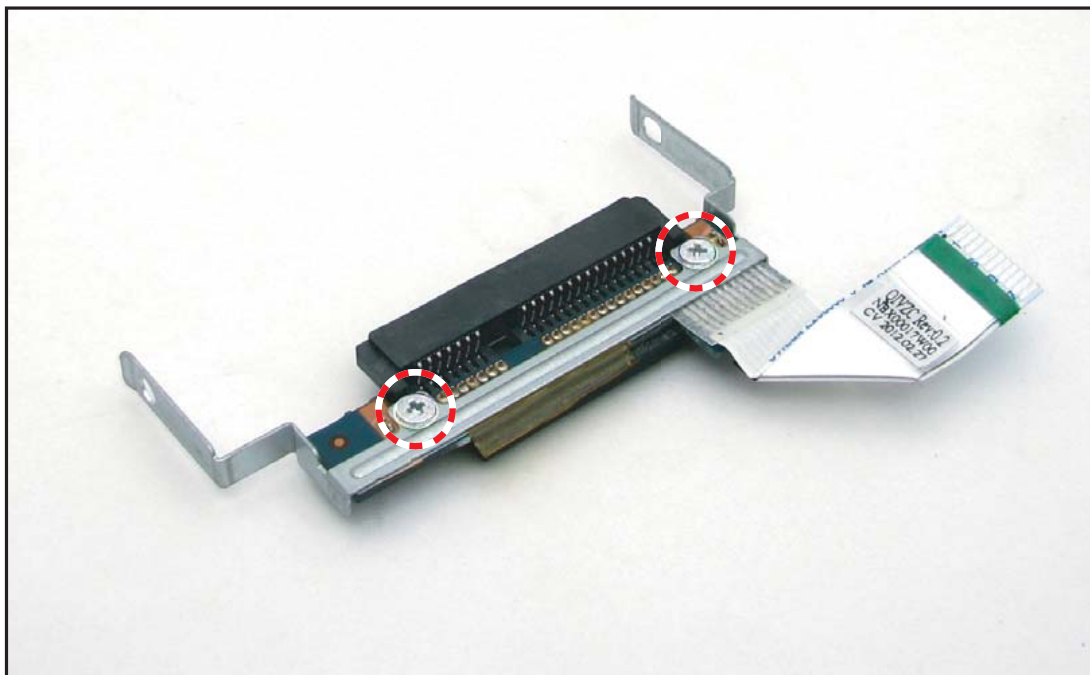

Figure 5:20. Securing the HDD Board Screws

2. Connect the HDD board connector to the HDD connector.



Figure 5:21. Connecting the HDD Board Connector



3. Attach the two (2) screws to secure the HDD bracket to the HDD.



Figure 5:22. Installing the HDD Bracket

4. Install the HDD module (see [HDD Module Installation](#) on page [5-16](#)).

Table 5:9. HDD Board and Bracket Screws

Screw Name	Screw Type	Quantity
M 2.0 x 4.0		2
M 3.0 x 3.0		2

Fan Removal

Prerequisite:

※ [Base Door Removal](#) on page 5-11

1. Locate the fan module (see [Figure 5:10](#), page 5-12).
2. Using the plastic pry, disconnect the fan cable connector from the mainboard connector.



Figure 5:23. Disconnecting the Fan Cable

3. Remove the two (2) screws securing the fan.

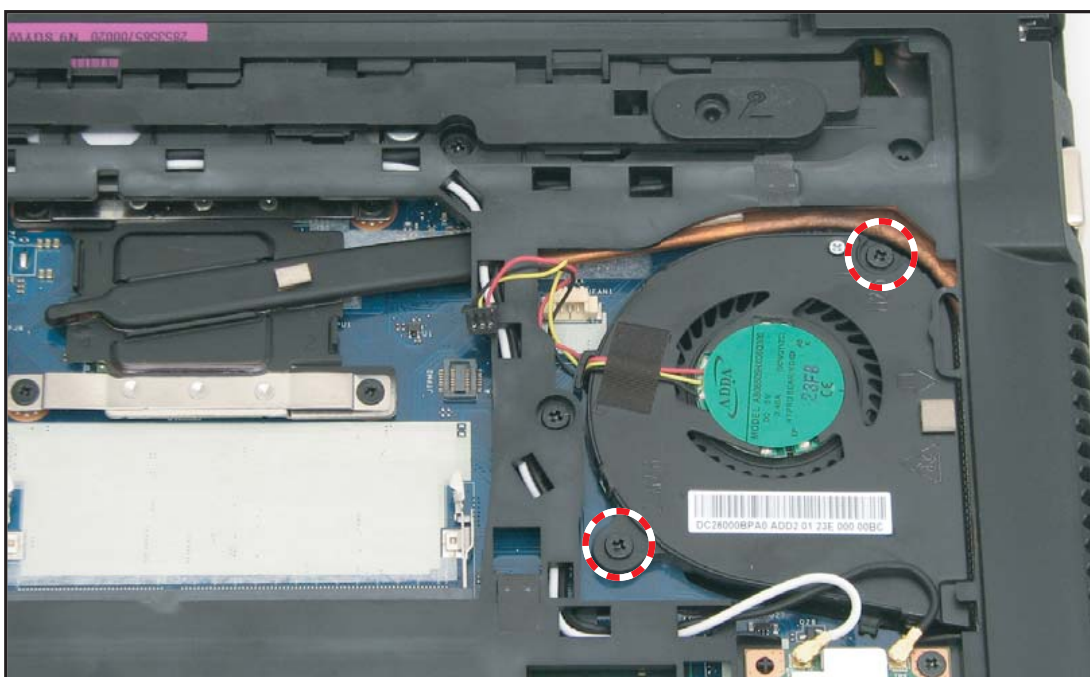

Figure 5:24. Removing the Fan Screws

4. Lift the fan by the fan cable to remove from its bay.

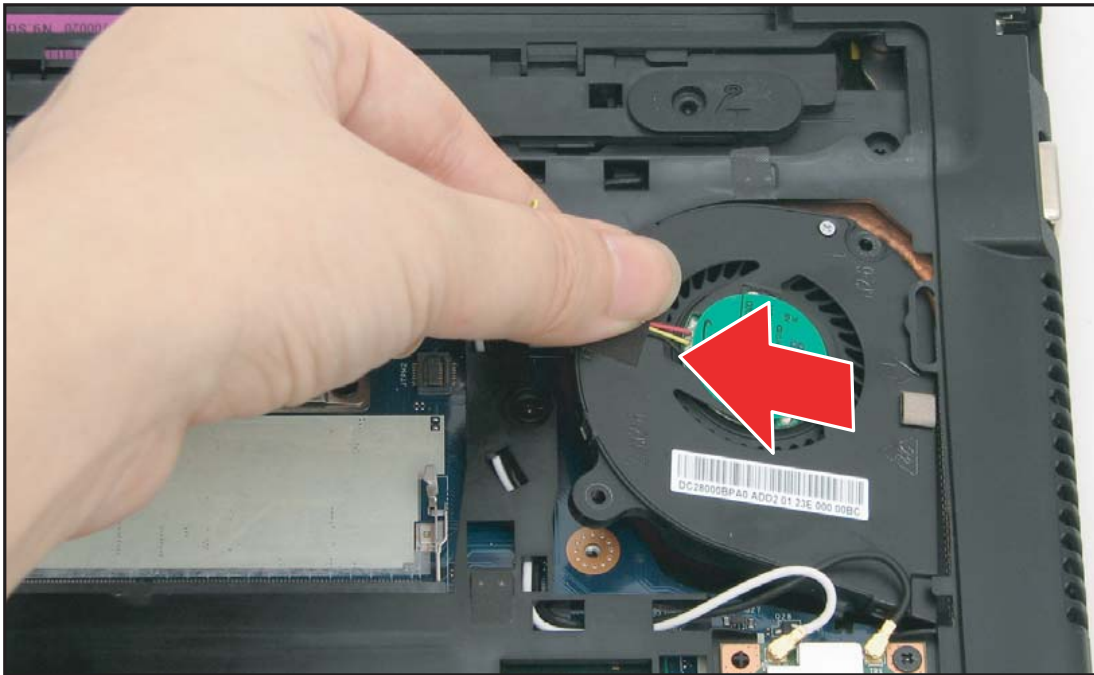

Figure 5:25. Removing the Fan

Fan Installation

1. Connect the fan cable connector to the mainboard connector.

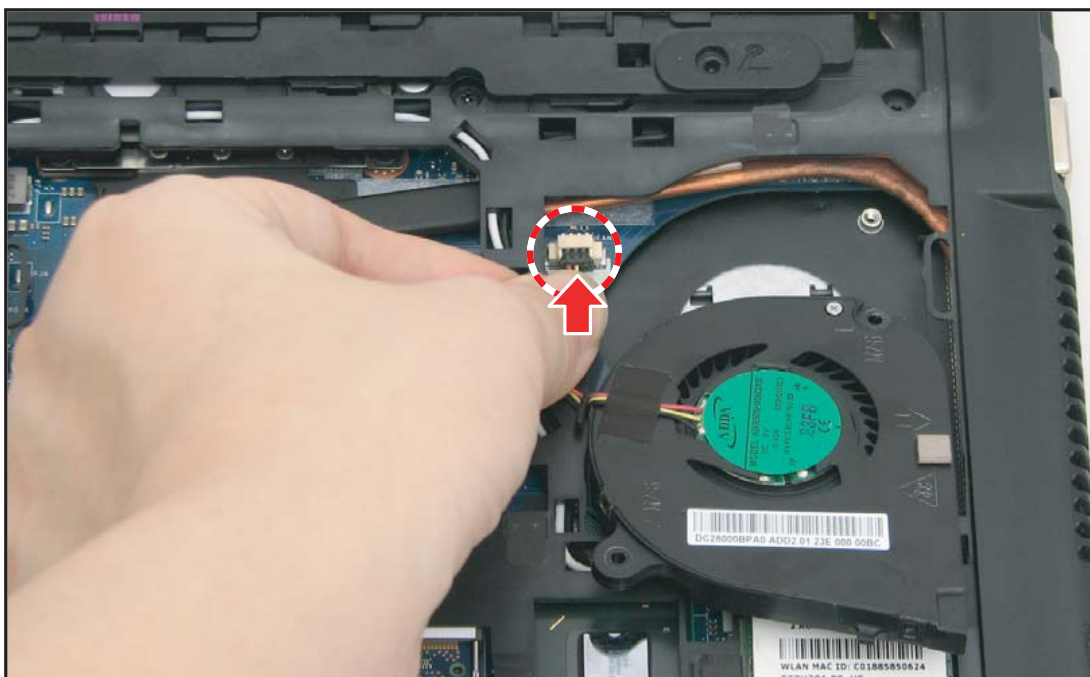

Figure 5:26. Installing the Fan

2. Align and place the fan on the fan bay.

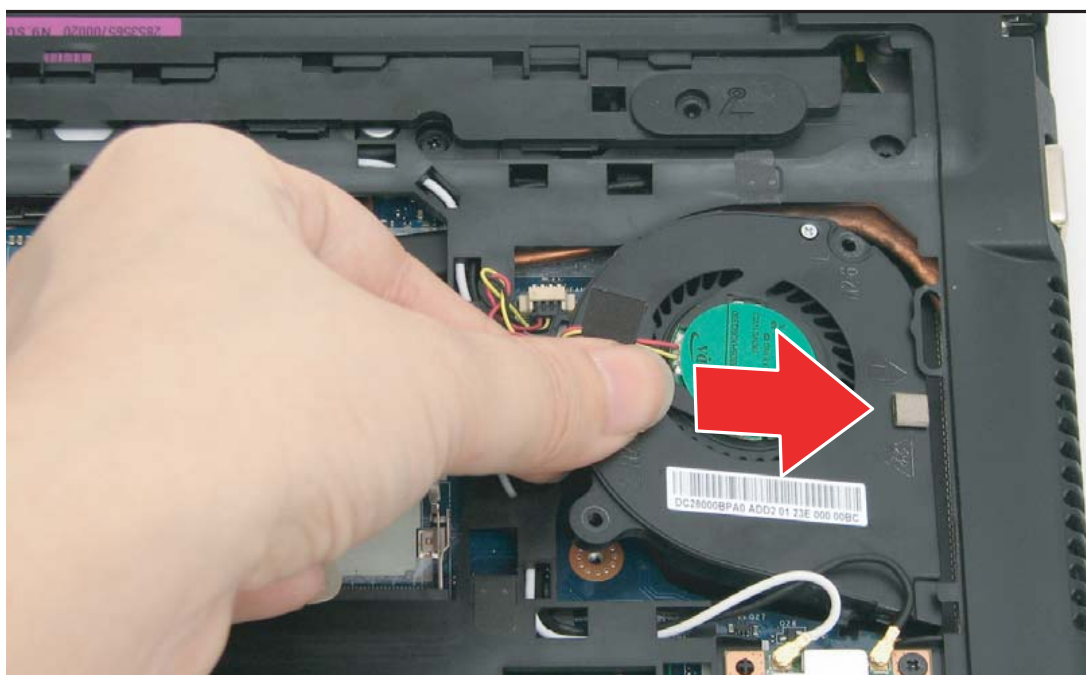

Figure 5:27. Installing the Fan

- Attach the two (2) screws to secure the fan.

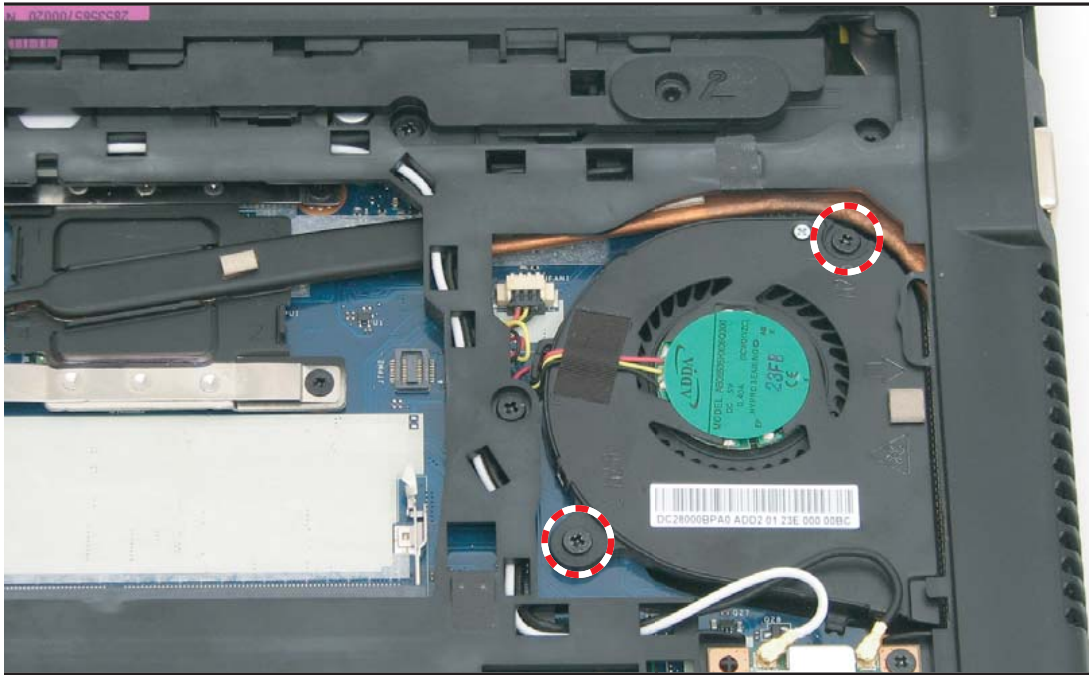



Figure 5:28. Securing the Fan Screws

- Install the base door (see [Base Door Installation](#) on page [5-13](#)).

Table 5:10. Fan Screws

Screw Name	Screw Type	Quantity
M 2.0 x 6.0		2

DIMM Module Removal

Prerequisite:

※ [Base Door Removal](#) on page [5-11](#)

1. Locate the DIMM module (see [Figure 5:10](#), page [5-12](#)).
2. Push the clips outwards.

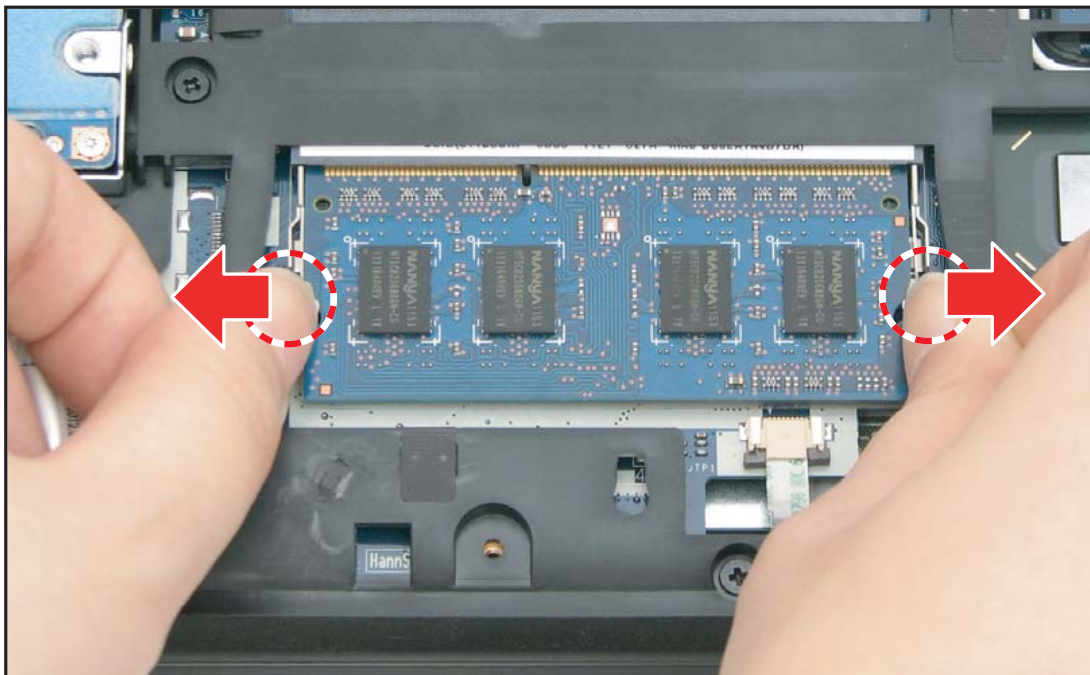

Figure 5:29. Removing the DIMM Module (1 of 2)

3. Pull to remove the memory module from the slot.

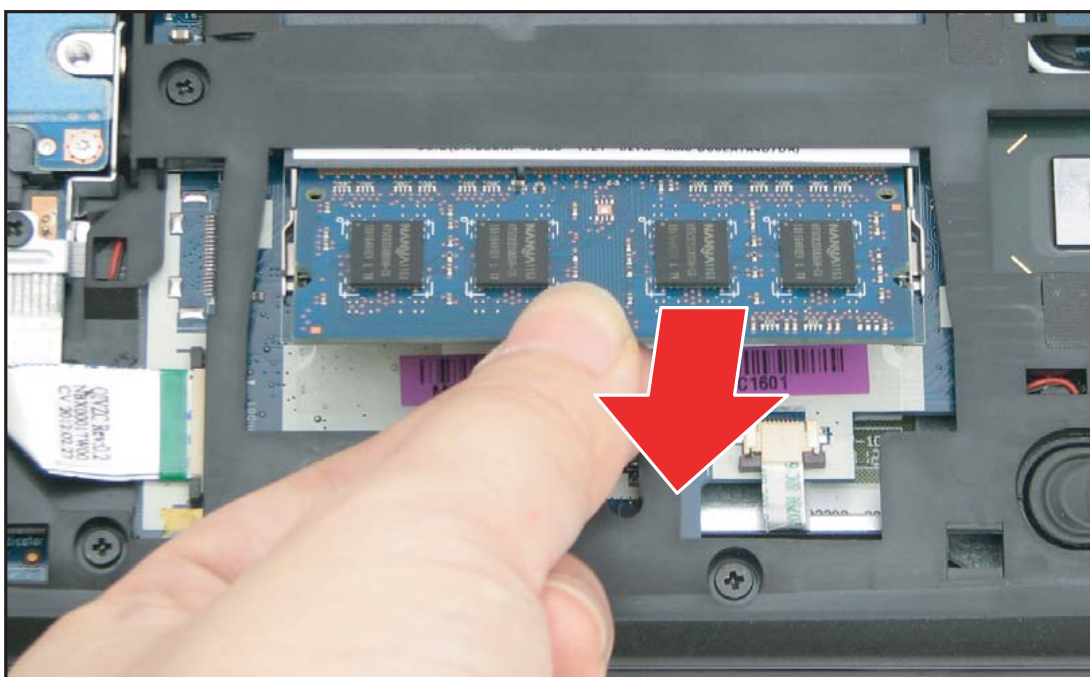

Figure 5:30. Removing the DIMM Module (2 of 2)

DIMM Module Installation

1. Connect the memory module connector to the mainboard connector.

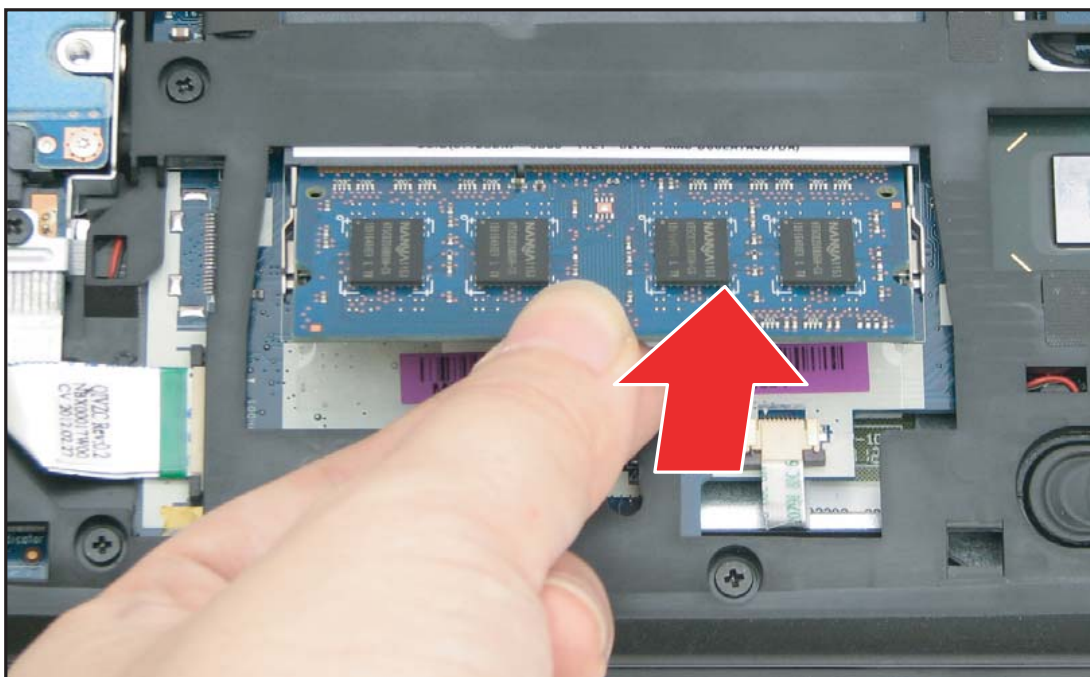

Figure 5:31. Installing the DIMM Module (1 of 2)

2. Push down the memory module to lock the clips in place.

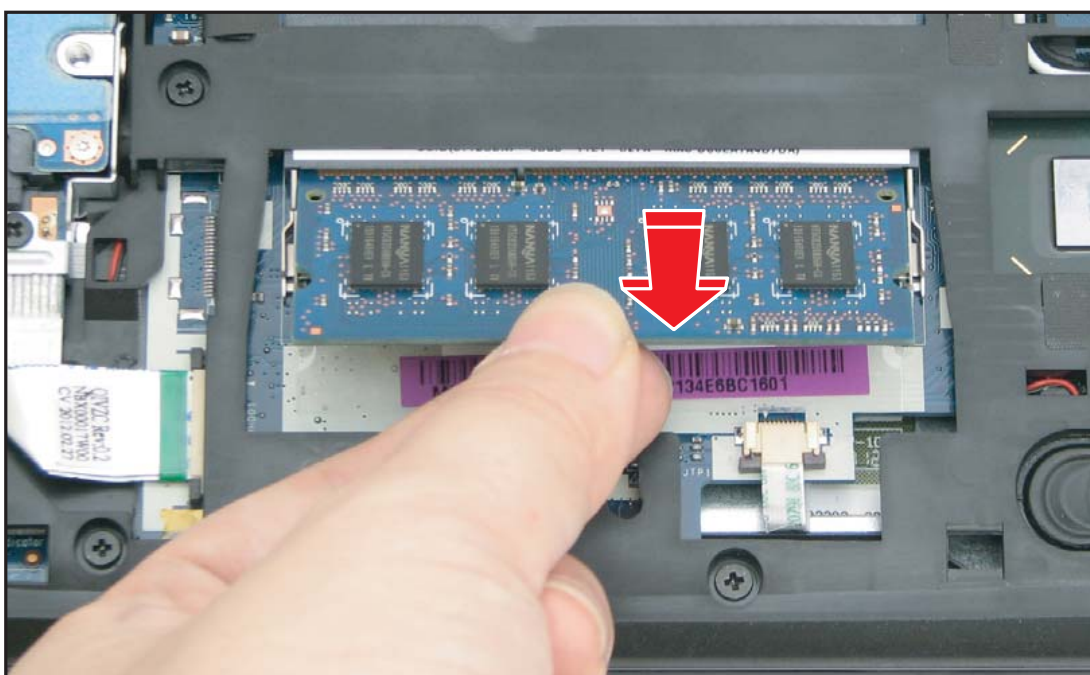

Figure 5:32. Installing the DIMM Module (2 of 2)

3. Install the base door (see [Base Door Installation](#) on page 5-13).

WLAN Module Removal

Prerequisite:

※ [Base Door Removal](#) on page [5-11](#)

1. Locate the WLAN module (see [Figure 5:10](#), page [5-12](#)).
2. Disconnect the main (black) and auxiliary (white) antenna connectors from the WLAN module connectors.

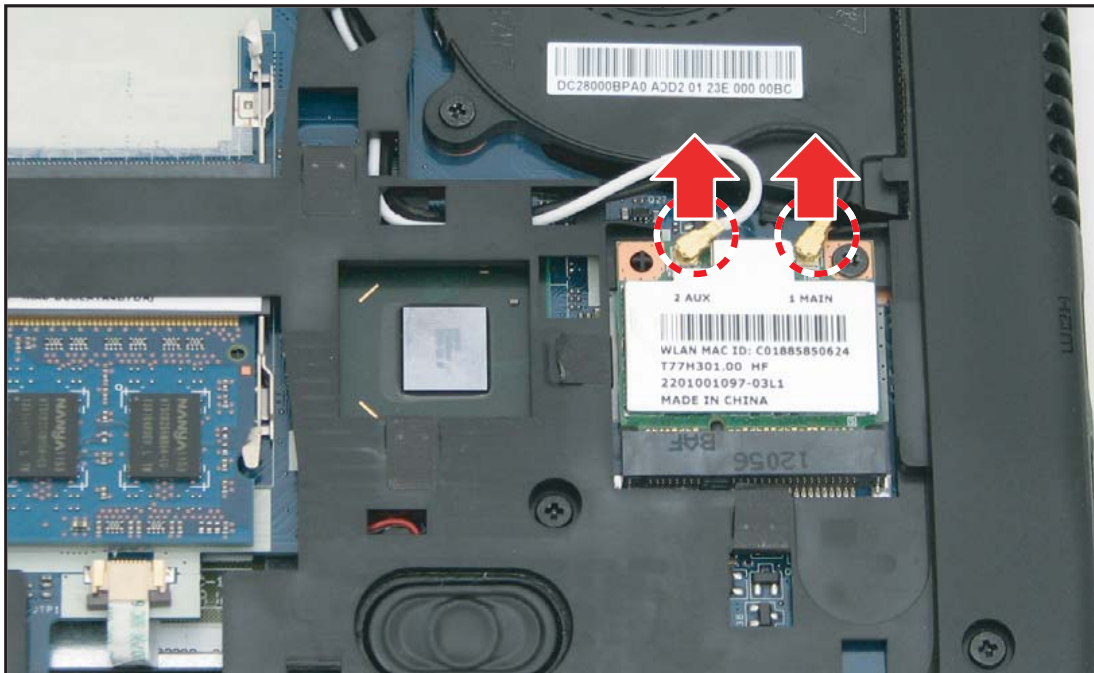

Figure 5:33. Disconnecting the Antenna Cables

3. Remove the screw securing the WLAN module.



Figure 5:34. Removing the WLAN Module Screw

4. Disconnect the WLAN module from the mainboard connector.



Figure 5:35. Removing the WLAN Module

WLAN Module Installation

1. Connect the WLAN module to the mainboard connector.



Figure 5:36. Installing the WLAN Module

2. Attach the screw to secure the WLAN module.



Figure 5:37. Securing the WLAN Module Screw

3. Connect the antenna cables to the WLAN module connectors:
 - Auxiliary (A - white) antenna cable to the left connector.
 - Main (B - black) antenna cable to the right connector.

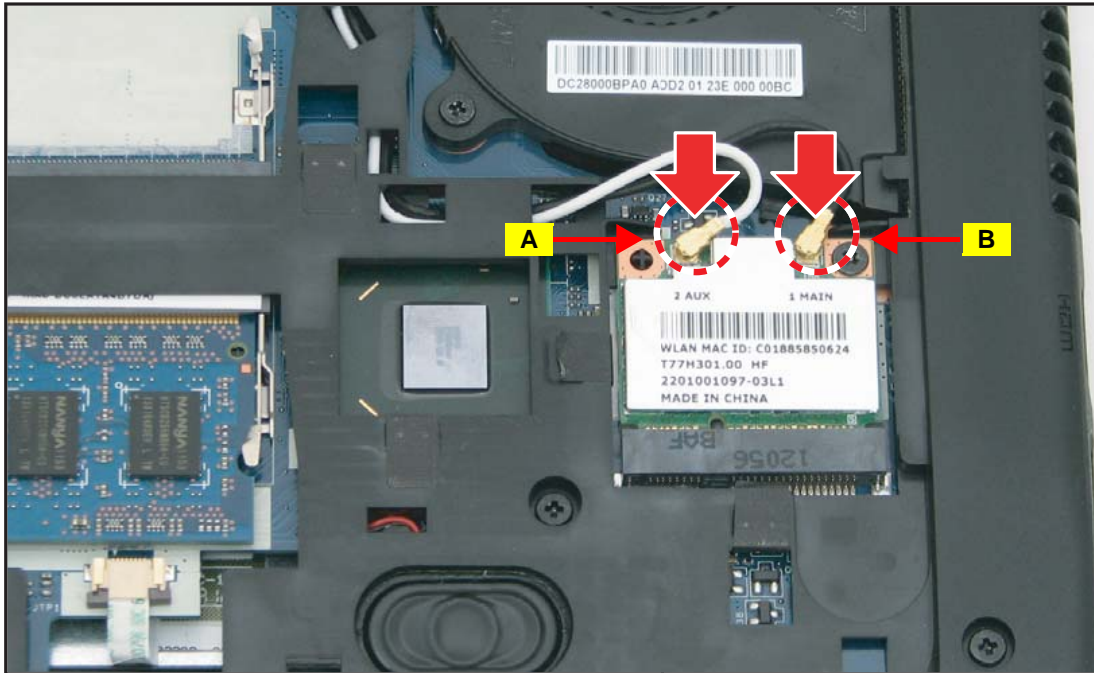



Figure 5:38. Securing the WLAN Module Screw

4. Install the base door (see [Base Door Installation](#) on page 5-13).

Table 5:11. WLAN Module Screw

Screw Name	Screw Type	Quantity
M 2.0 x 3.0		1

2. Remove the 15 screws securing the upper and lower case.



Figure 5:40. Removing the Upper and Lower Case Screws

3. Open the notebook lid to its maximum angle.
4. From top to bottom, pry the right side of the upper case to release the latches.



Figure 5:41. Removing the Upper Case (1 of 3)

- From top to bottom, pry the left side of the upper case to release the latches.



Figure 5:42. Removing the Upper Case (2 of 3)

- Continue to pry to release the top and bottom side latches.

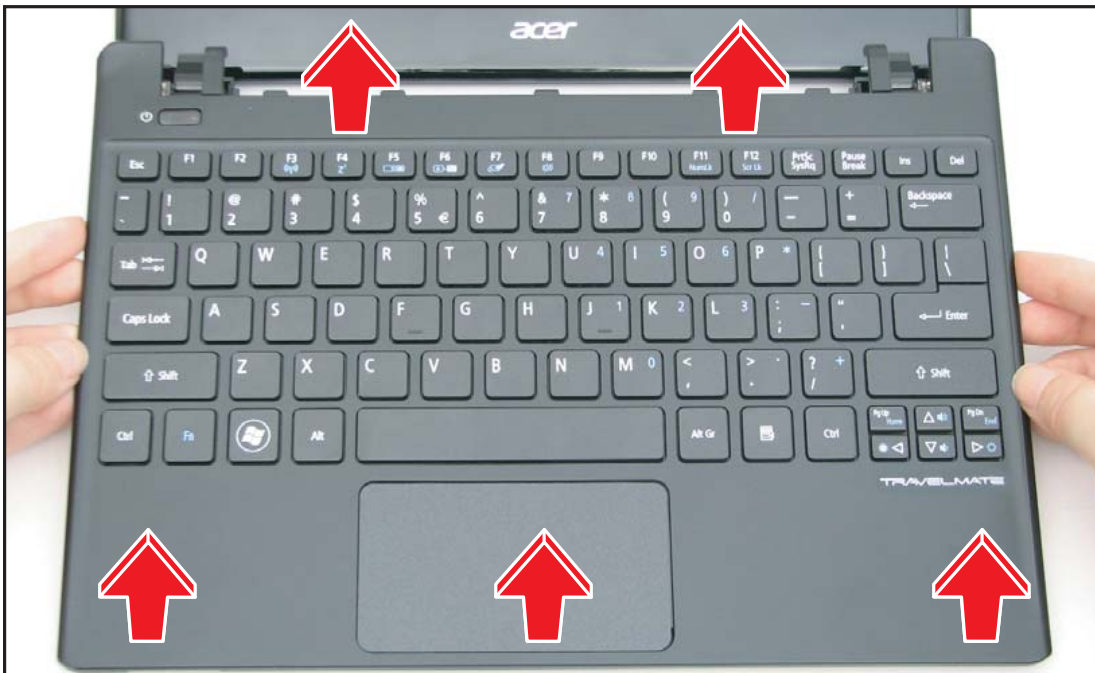

Figure 5:43. Removing the Upper Case (3 of 3)

⚠ CAUTION:

A cable is still connected under the upper case, do not completely lift the upper case.

7. From the bottom side, partially lift the upper case to locate the keyboard cable connector.
8. Push the connector clips up to disconnect the keyboard cable connector from the mainboard connector.

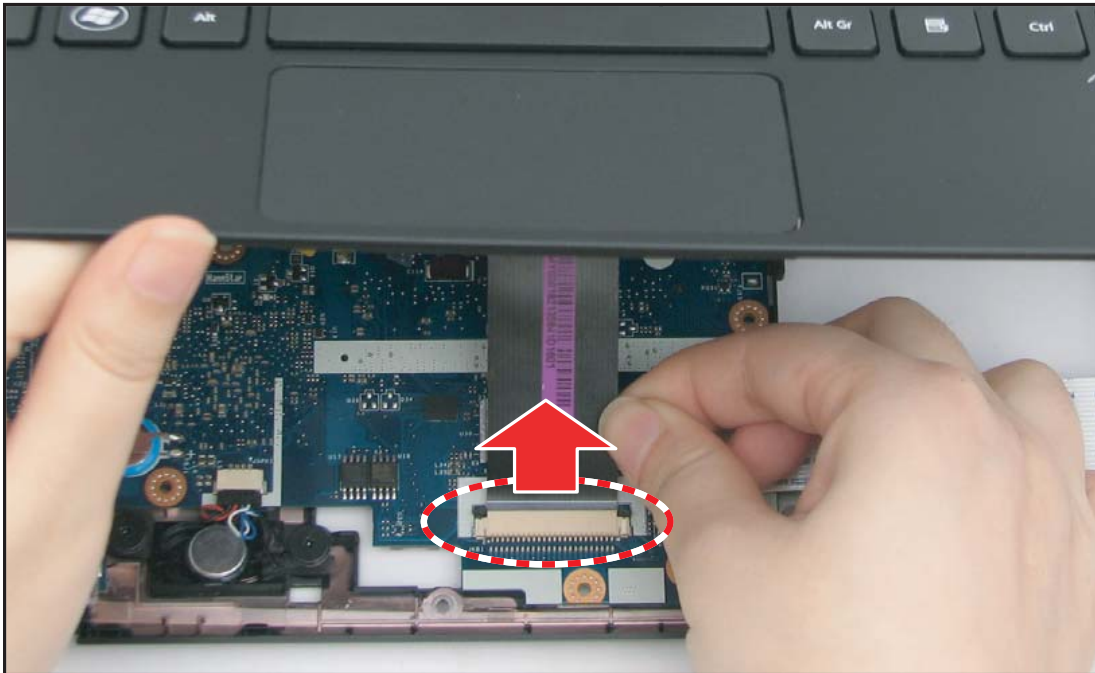

Figure 5:44. Disconnecting the Keyboard Cable

9. Lift the upper case to find the following modules:

- LVDS Cable Connector (A)
- DC-In Module (B)
- IO board Module (C)
- Speakers (D)
- LED Board Module (E)

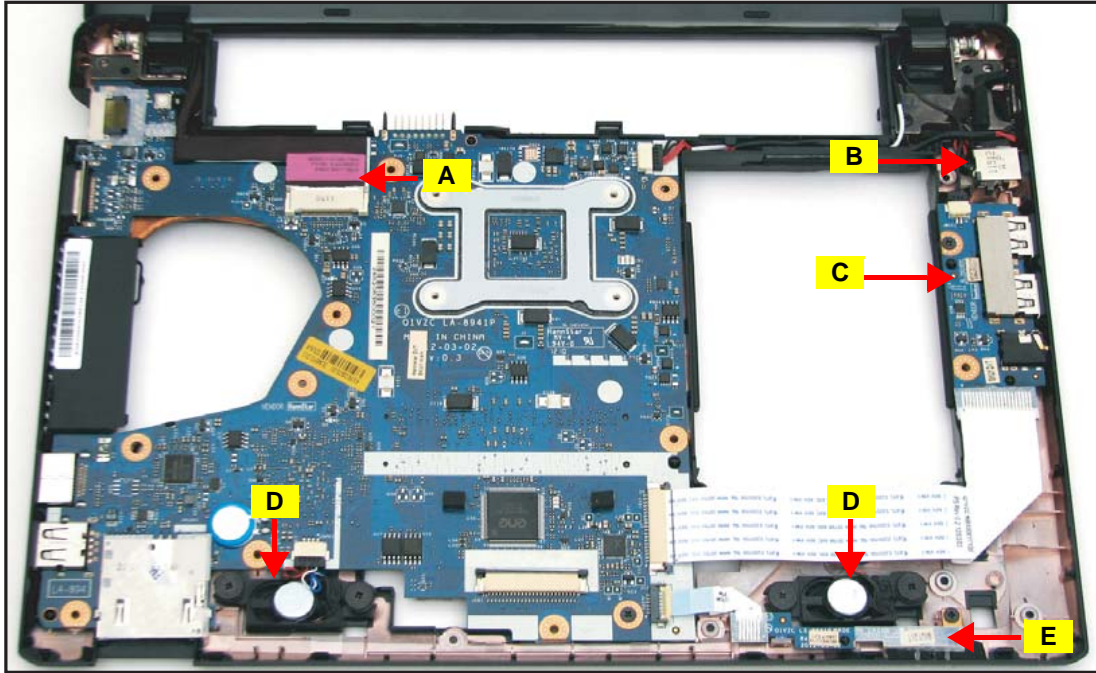

Figure 5:45. Mainboard Overview

Upper Case Installation

1. With the connector clips up, connect the keyboard cable connector to the mainboard connector, then push the connector clips down to lock.

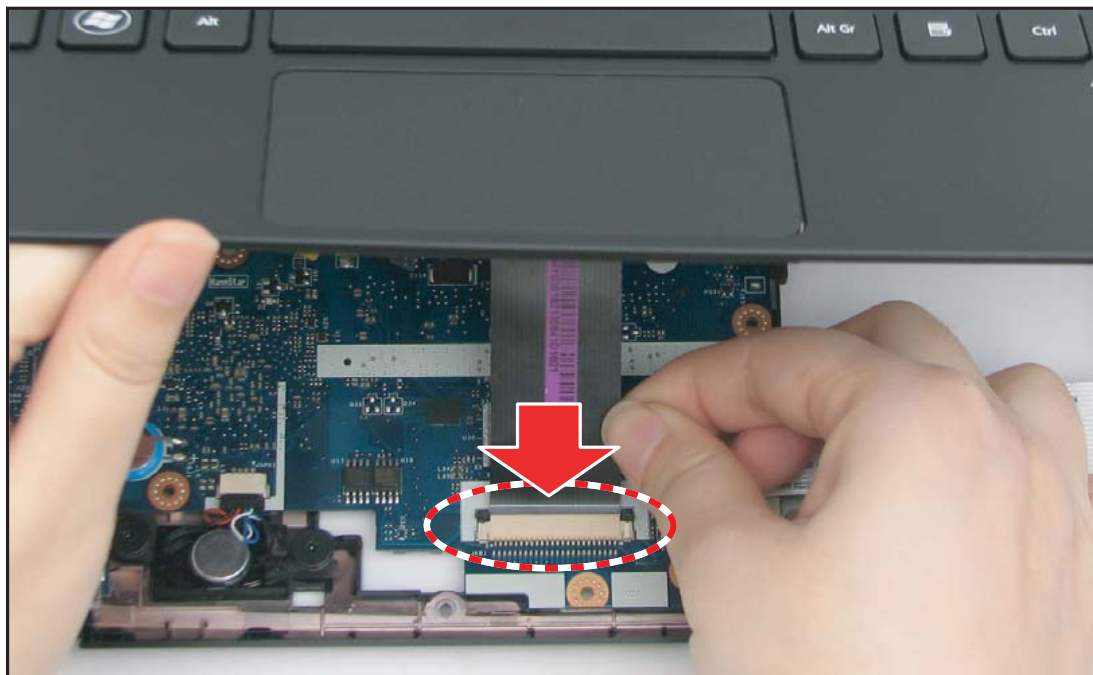

Figure 5:46. Connecting the Keyboard Cable

2. Align the upper case to the lower case and then push to secure the latches.

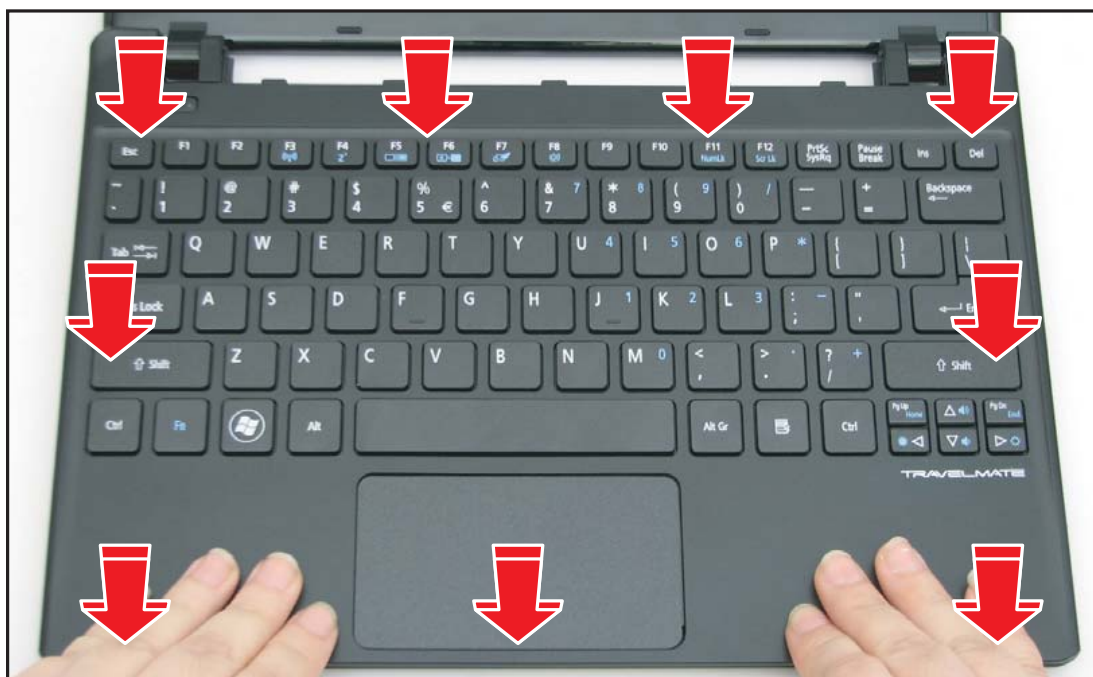

Figure 5:47. Installing the Upper Case

3. Attach one M2.03 x 3.0 screw at point (A) and 14 M2.0 x 6.0 screws to the screw holes marked below to secure the upper case to the lower case.

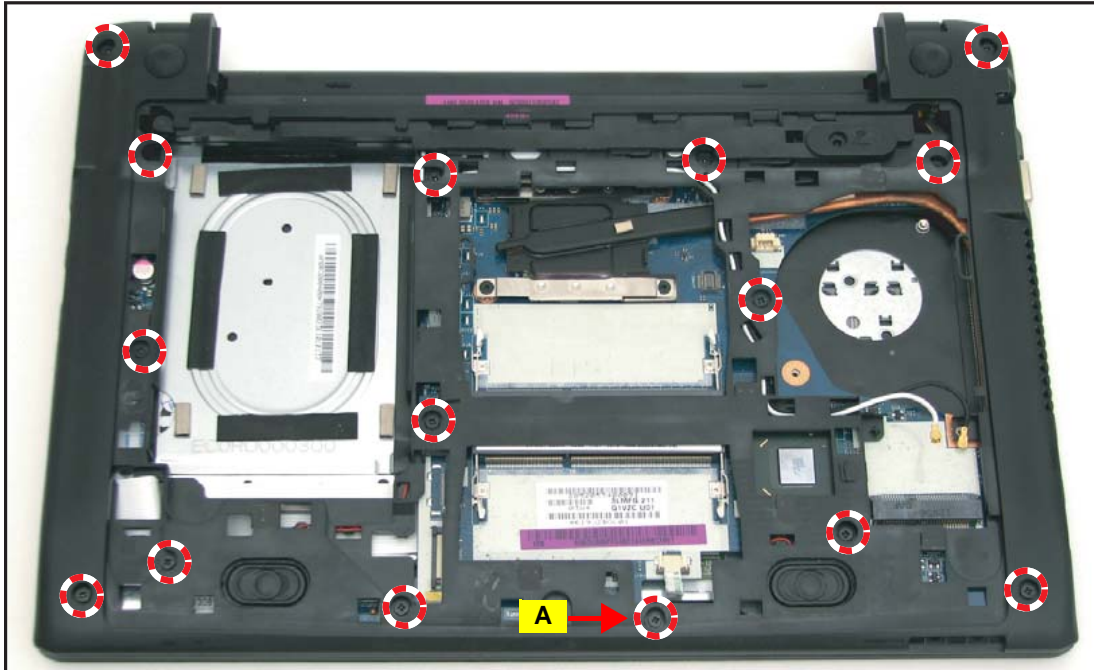

Figure 5:48. Securing the Upper and Lower Case Screws

4. With the connector clips down, connect the touchpad cable connector to the mainboard connector with the metallic contacts side up. Then push the connector clips up to lock.

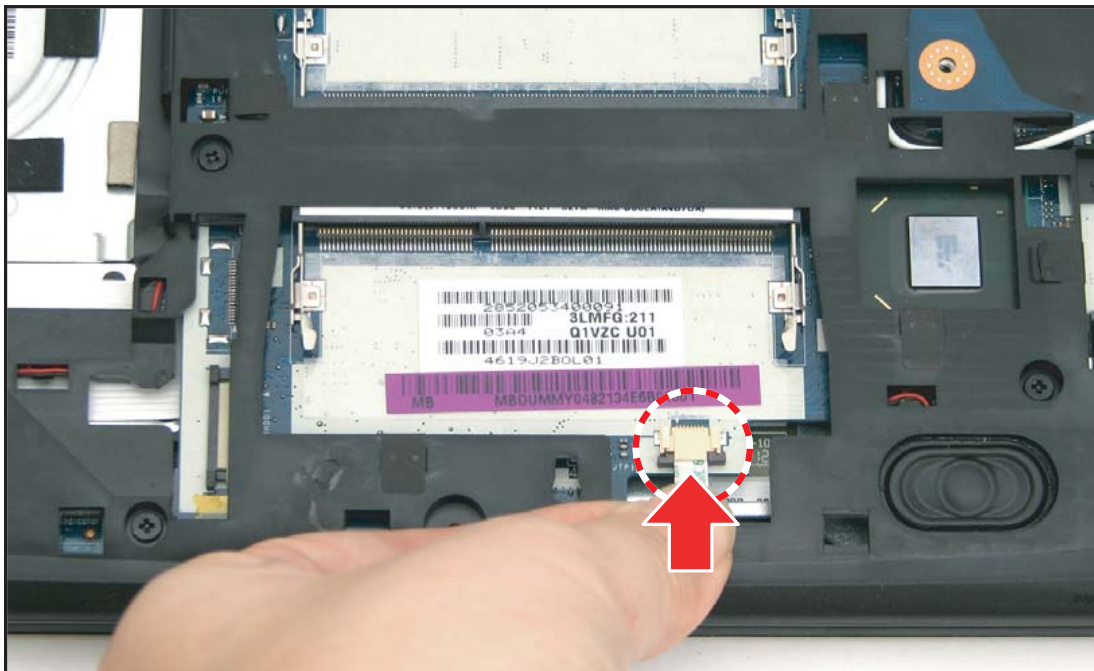

Figure 5:49. Connecting the Touchpad Cable

5. Install the HDD module (see [HDD Module Installation](#) on page [5-16](#)).
6. Install the fan (see [Fan Installation](#) on page [5-23](#)).
7. Install the DIMM module (see [DIMM Module Installation](#) on page [5-26](#)).

8. Install the WLAN module (see [WLAN Module Installation](#) on page [5-29](#)).

Table 5:12. Upper and Lower Case Screws

Screw Name	Screw Type	Quantity
M 2.0 x 6.0		14
M 2.0 x 3.0		1

Mainboard Removal

Prerequisite

※ [Upper Case Removal](#) on page 5-31

1. Disconnect the LVDS cable connector (A), DC-In cable connector (B), speaker cable connector (C), IO board cable connector (D), and the LED board cable connector from the mainboard connectors.

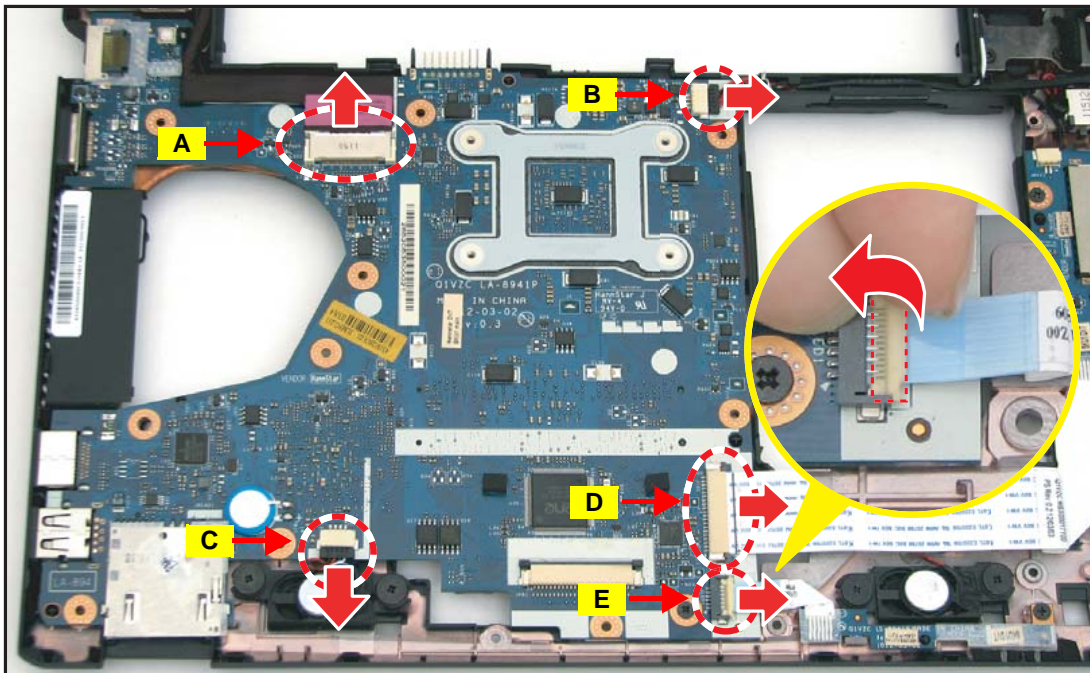

Figure 5:50. Disconnecting the Cables

TIP: Lift the LVDS cable from the mainboard to detach the adhesives underneath the cable.

2. Remove the screw securing the mainboard to the lower case.

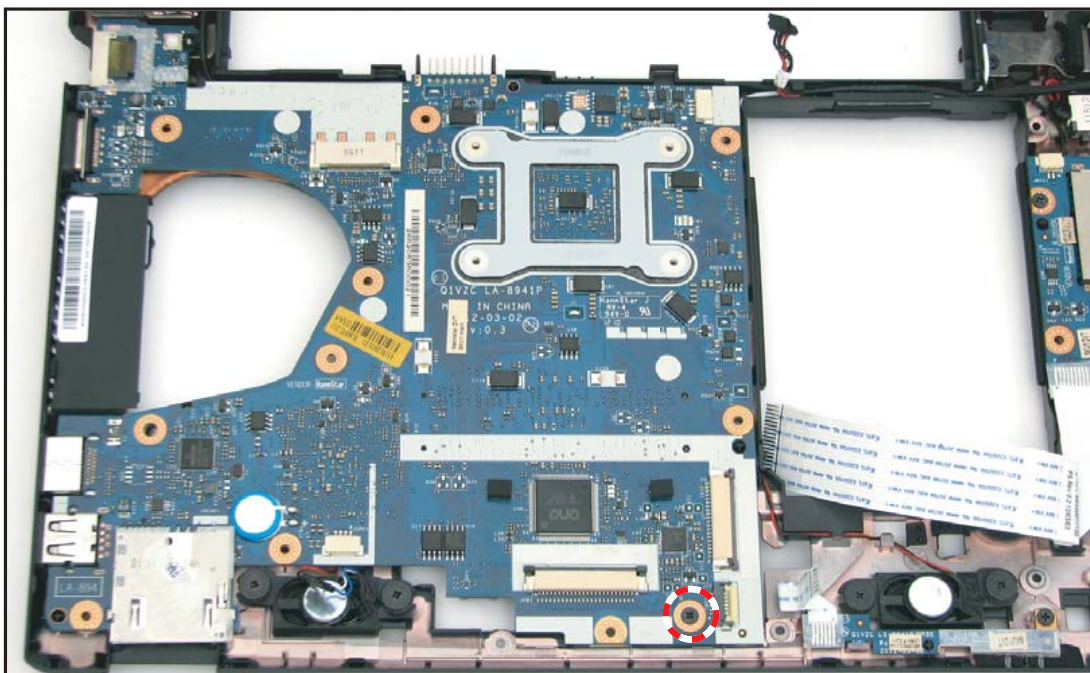

Figure 5:51. Removing the Mainboard Screw

3. Pull the mainboard by the right side to release the connectors from the slots on the lower case.

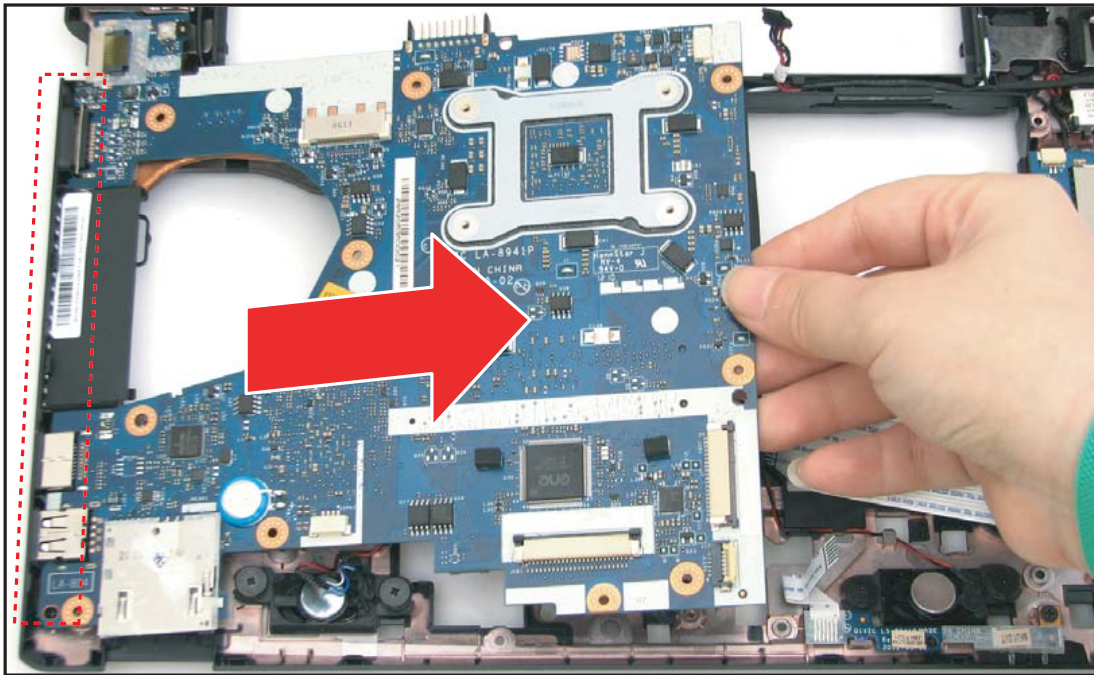

Figure 5:52. Removing the Mainboard

Mainboard Installation

1. Align the left side connectors of the mainboard to the slots on the lower case, and then push to install the mainboard.

TIP: Ensure the LVDS, DC-In, speaker, IO board, and LED board cable connectors are above the mainboard before installing the mainboard.

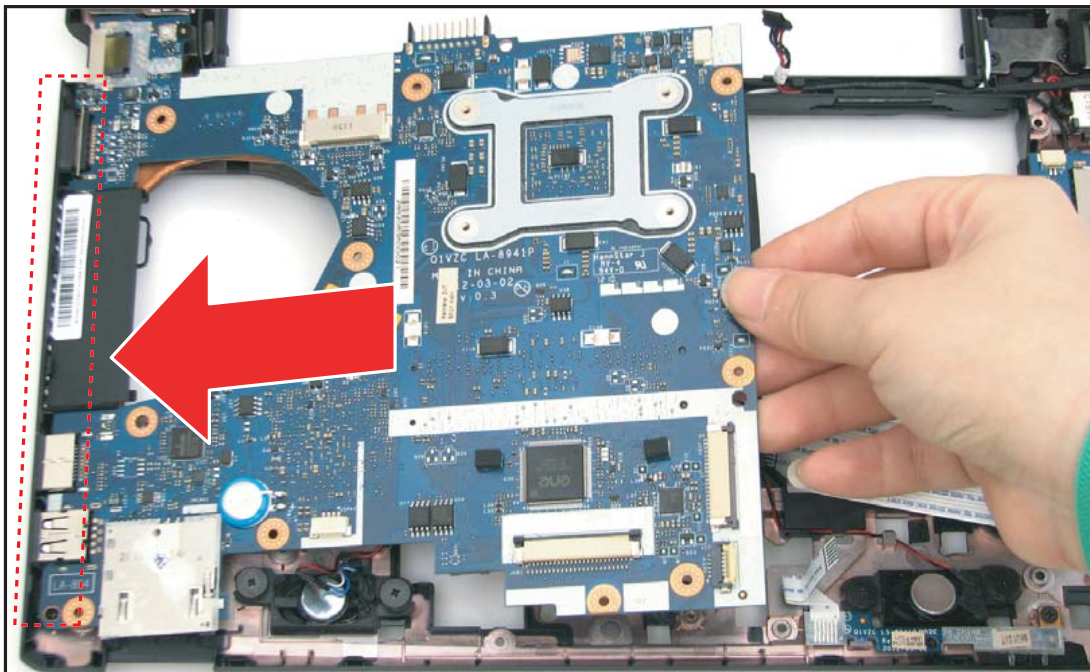

Figure 5:53. Connecting the DC-In Cable

2. Attach the screw to secure the mainboard to the lower case.

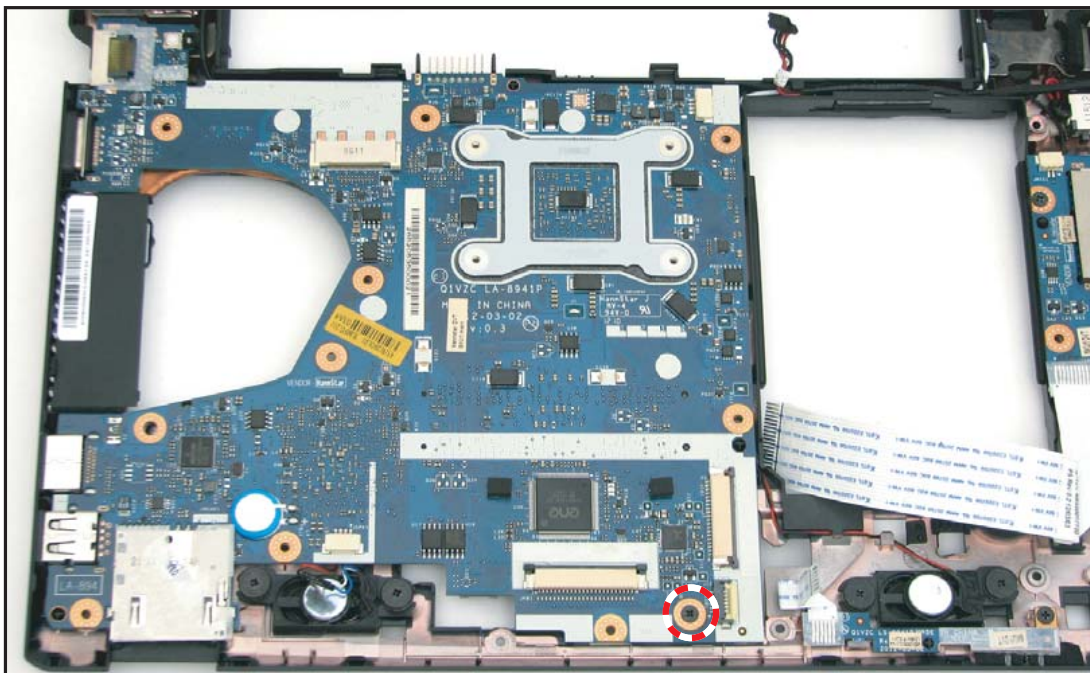

Figure 5:54. Securing the Mainboard Screw

3. Connect the following to the mainboard connectors:

- LVDS cable connector (A)
- DC-In cable connector (B)
- Speaker cable connector (C)
- IO board cable connector (D)
- LED board cable connector (E)

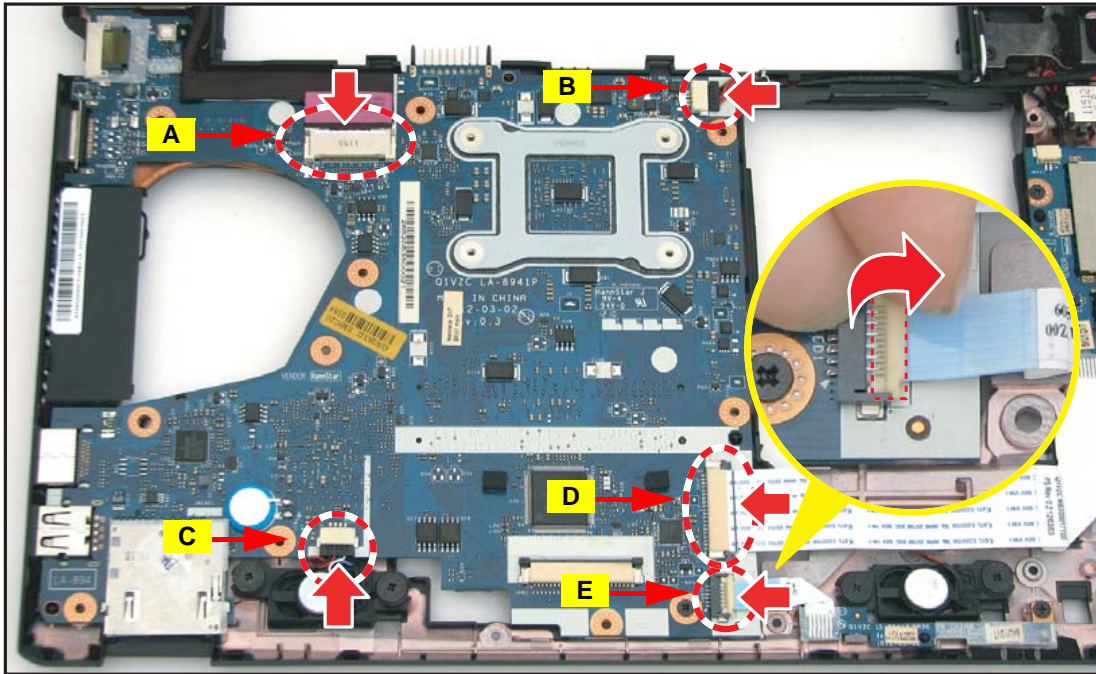



Figure 5:55. Connecting the Cable Connectors

4. Install the upper case (see [Upper Case Installation](#) on page 5-36).

Table 5:13. Mainboard Screw

Screw Name	Screw Type	Quantity
M 2.0 x 3.0		1

IO Board Removal

Prerequisite:

※ [Upper Case Removal](#) on page 5-31

1. Locate the IO board module (see [Figure 5:45](#), page 5-35).
2. Disconnect the IO board cable connector (A) from the mainboard connector and the microphone cable connector (B) from the IO board connector.

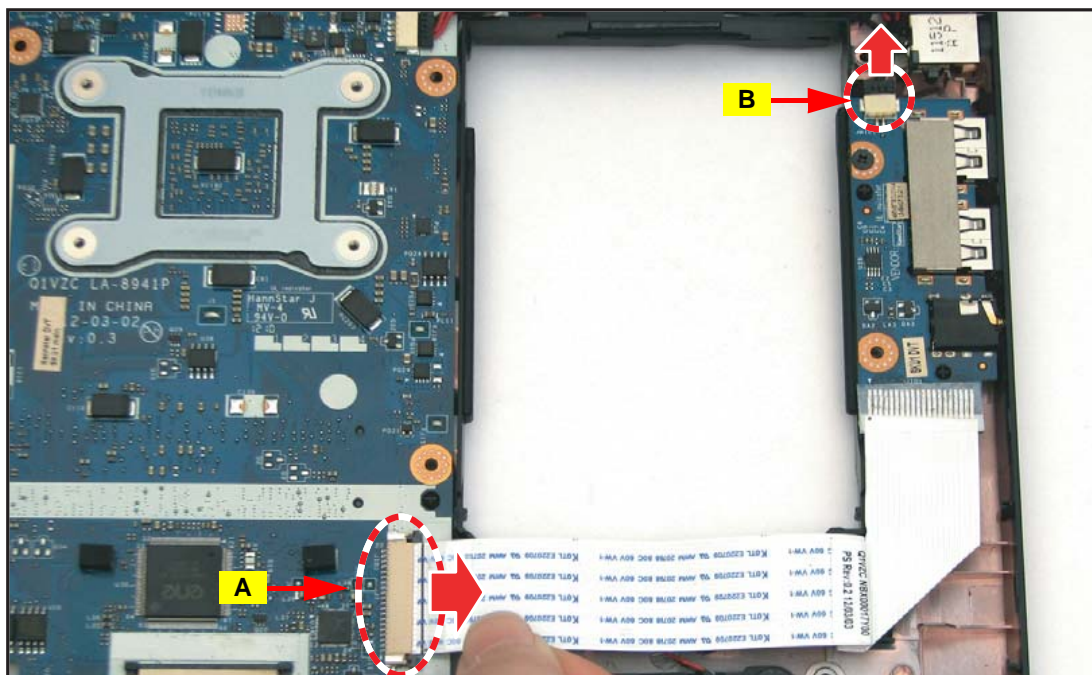

Figure 5:56. Disconnecting the Cables

3. Remove the screw securing the IO board to the lower case.

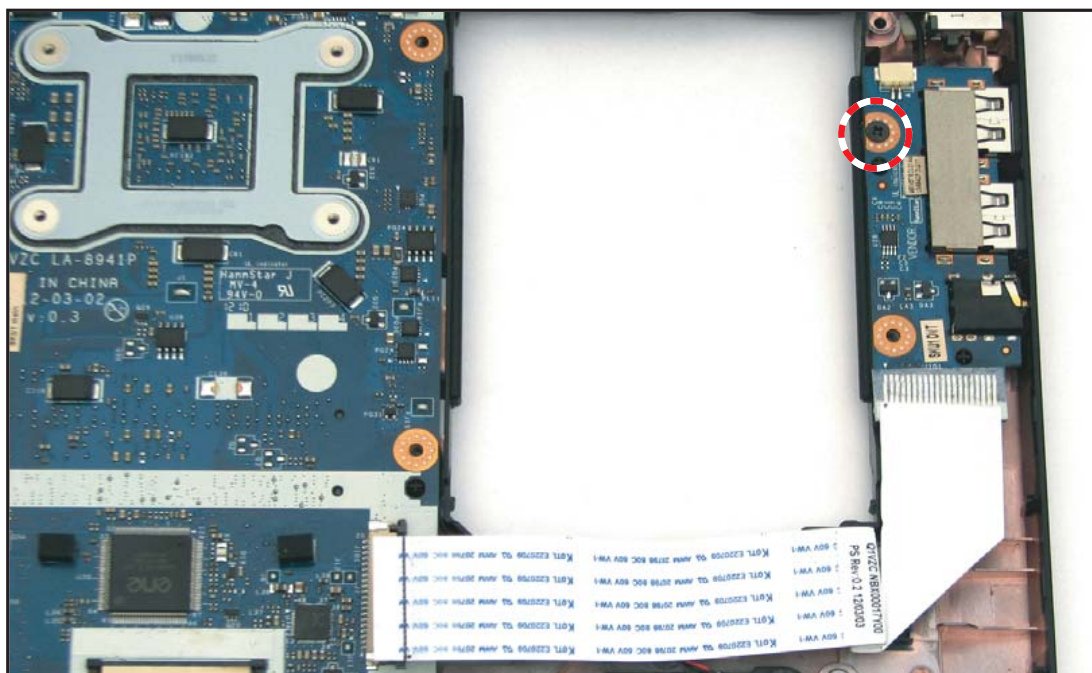

Figure 5:57. Removing the IO Board Screw

4. Lift to remove the IO board from the lower case.

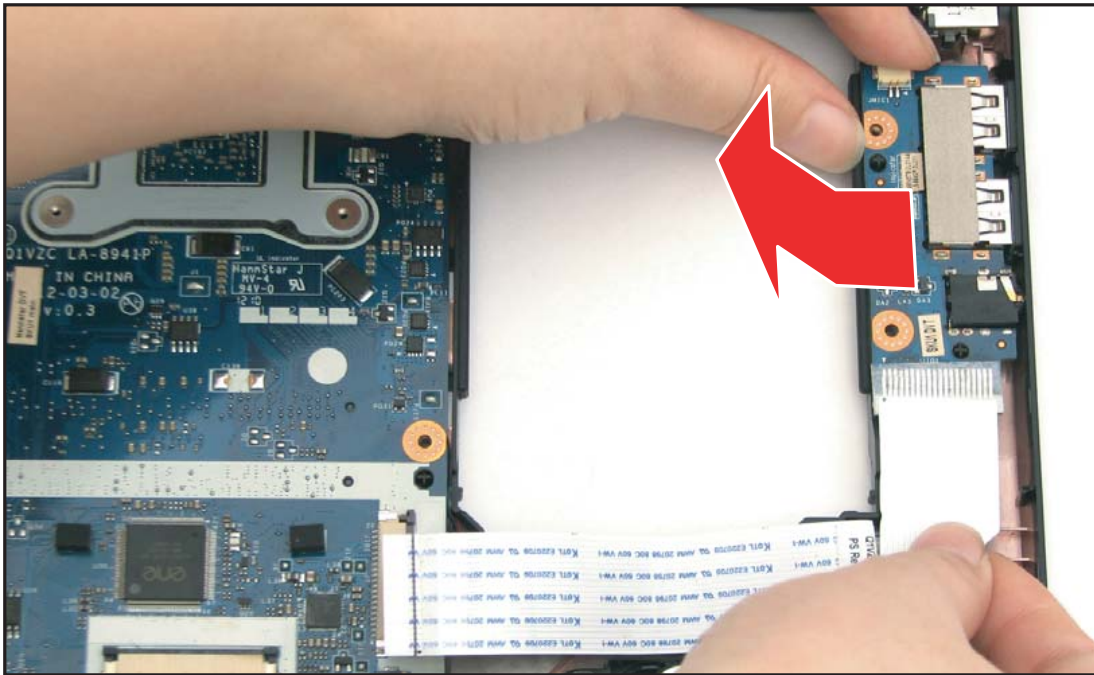

Figure 5:58. Removing the IO Board

IO Board Installation

1. Align and place the IO board to the lower case by the marked areas below.

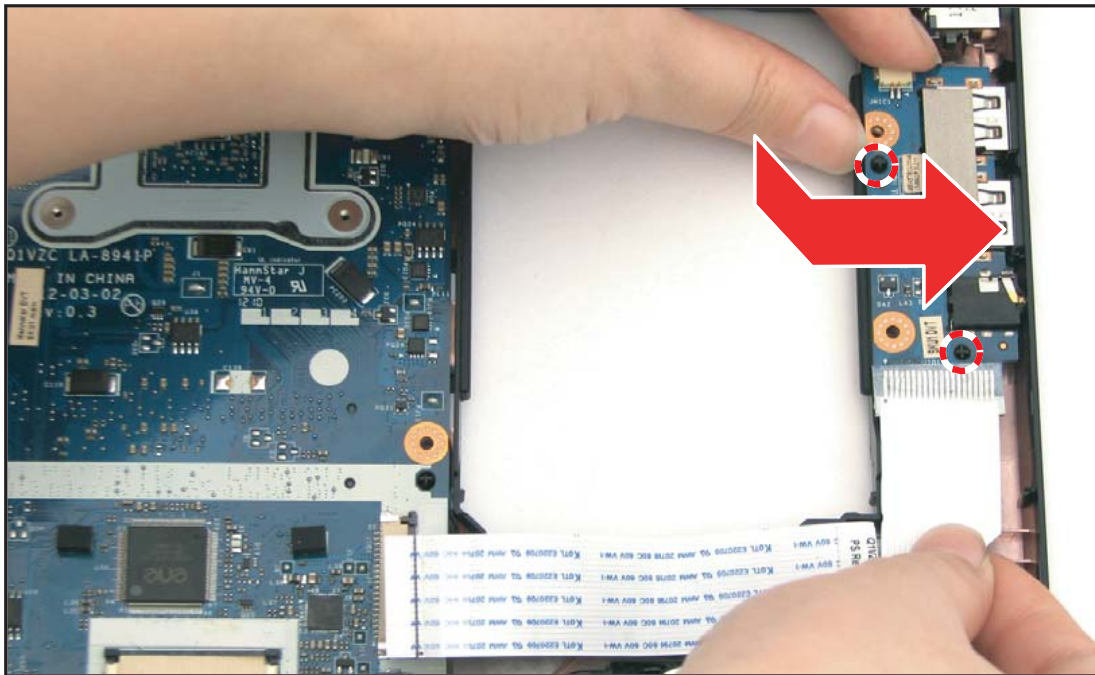

Figure 5:59. Installing the IO Board

2. Attach the screw to secure the IO board to the lower case.

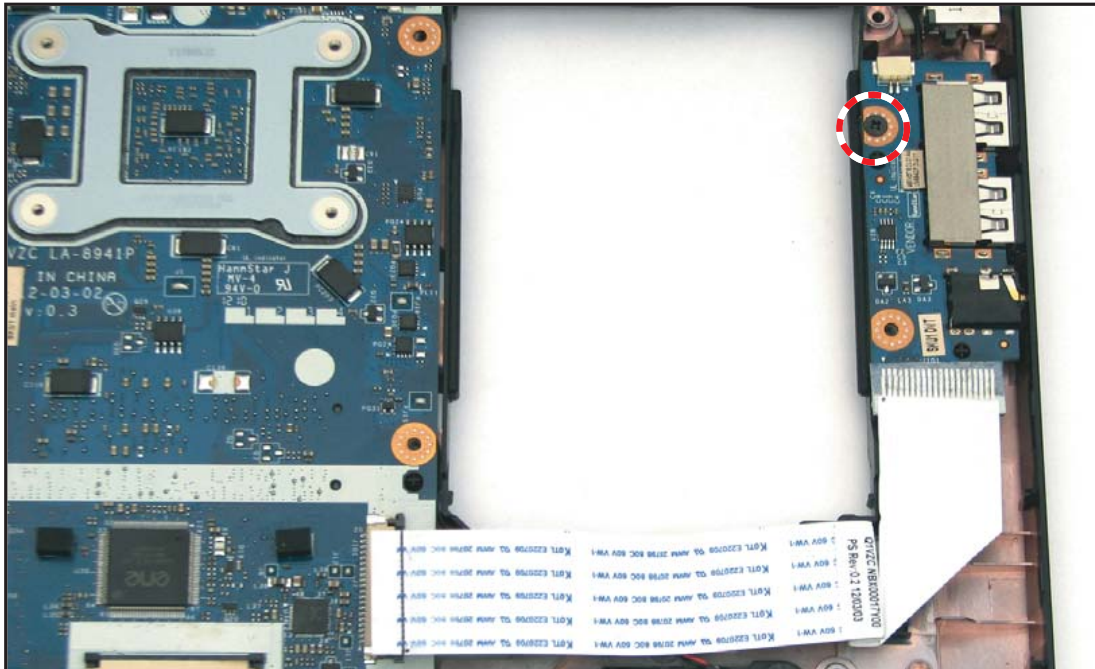

Figure 5:60. Installing the IO Board Screw

3. Connect the IO board cable connector (A) to the mainboard connector and the microphone cable connector (B) to the IO board connector.

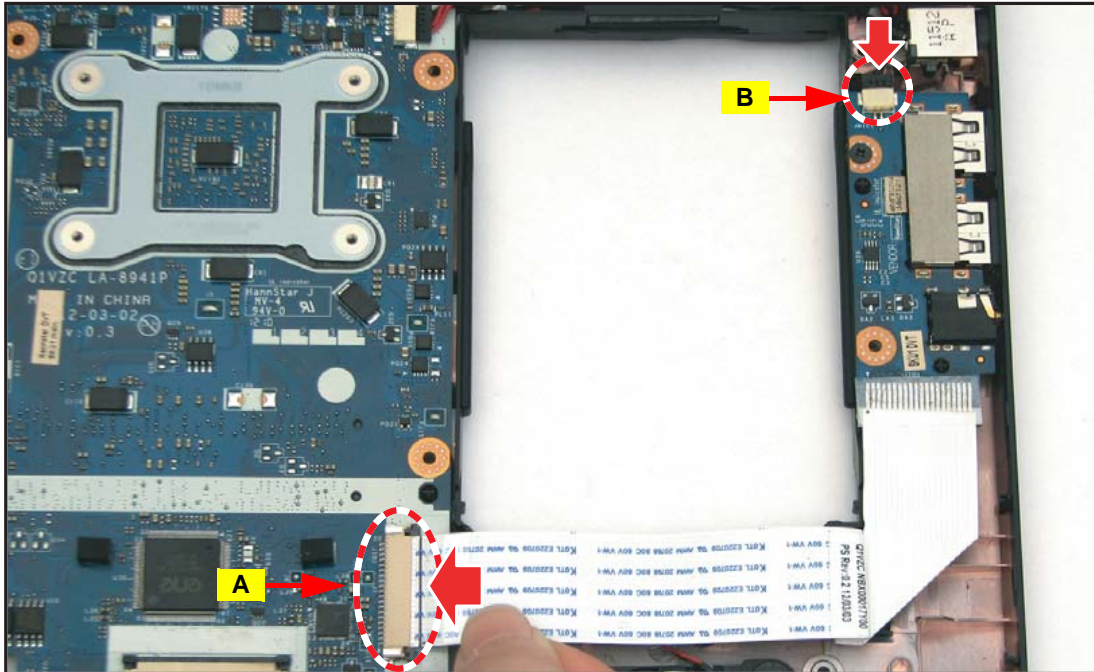



Figure 5:61. Connecting the Cables

4. Install the upper case (see [Upper Case Installation](#) on page 5-36).

Table 5:14. IO Board Screw

Screw Name	Screw Type	Quantity
M 2.0 x 3.0		1

LED Board Removal

Prerequisite:

※ [Upper Case Removal](#) on page 5-31

1. Locate the LED board module (see [Figure 5:45](#), page 5-35).
2. Disconnect the LED board cable connector from the mainboard connector.

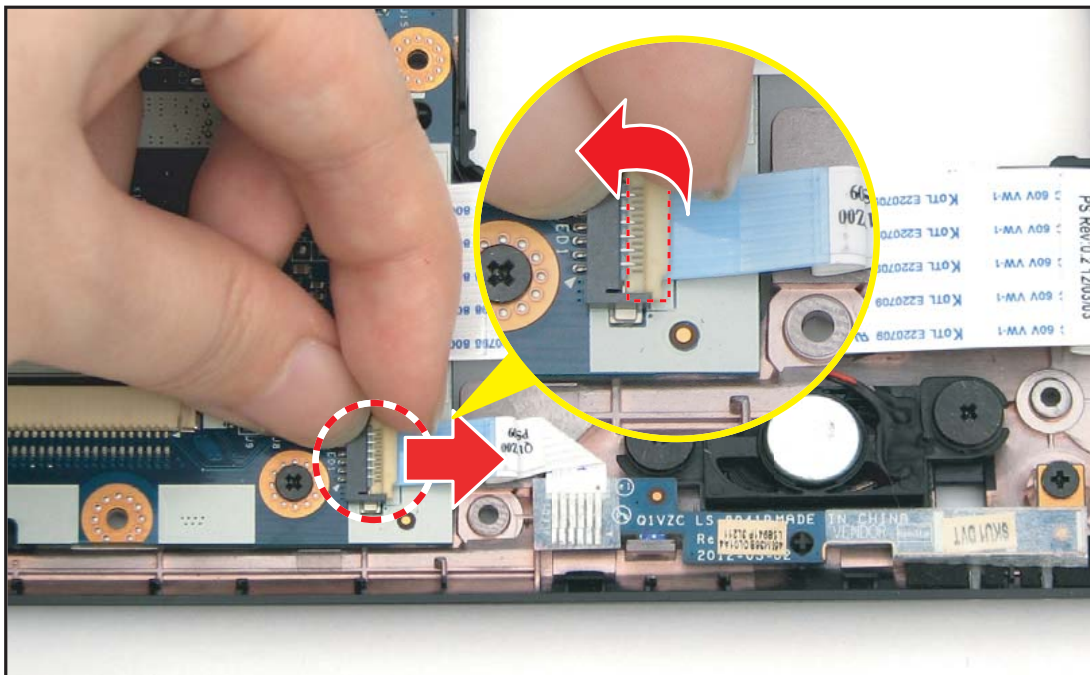

Figure 5:62. Disconnecting the LED Board Cable

3. Remove the screw securing the LED board to the lower case.

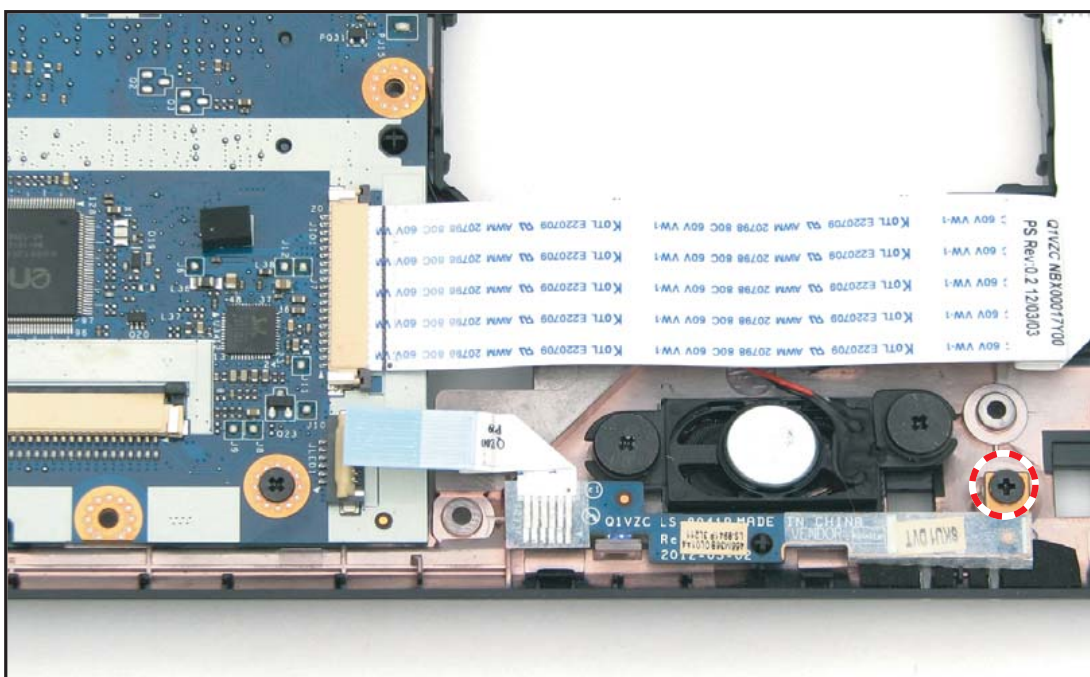

Figure 5:63. Removing the LED Board Screw

4. The LED board is latched on the lower case as marked below. Lift the LED board by the right side and slant it towards you to release the latch.

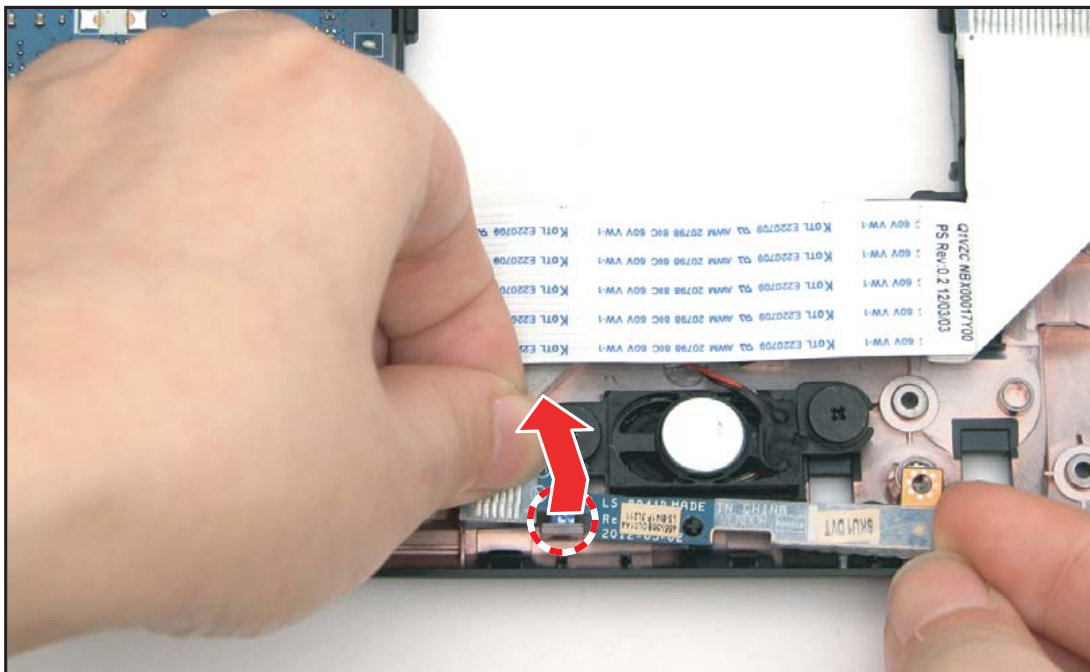

Figure 5:64. Removing the LED Board

LED Board Installation

1. At a slanted angle, align and place the LED board on point (A), then slant towards point (B) to latch the LED board on the lower case.

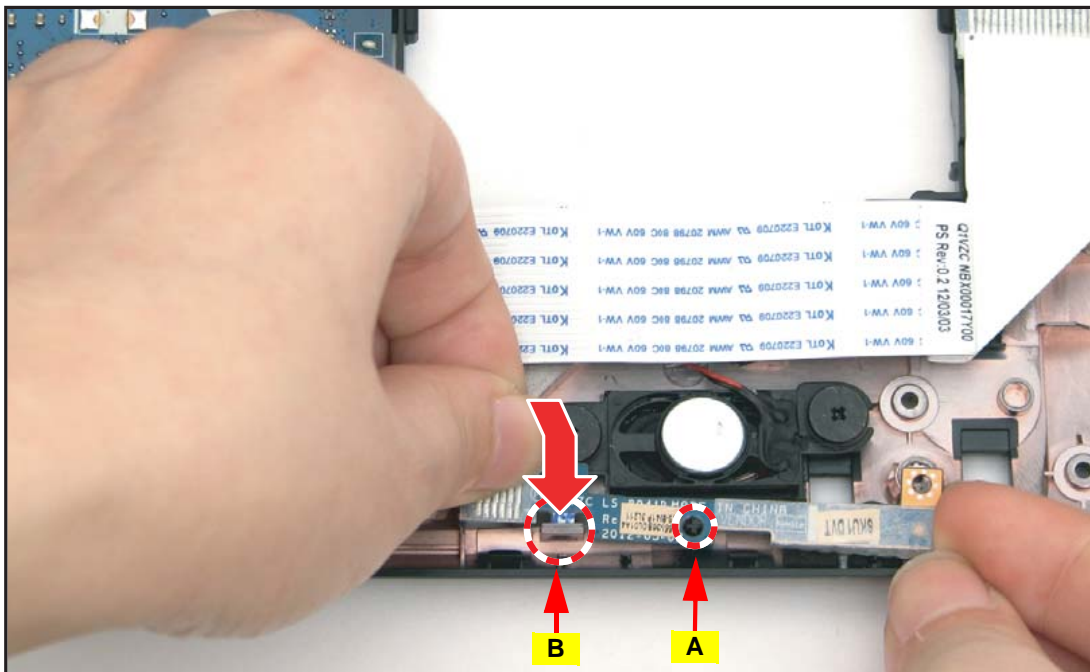

Figure 5:65. Installing the LED Board

2. Attach the screw to secure the LED board to the lower case.

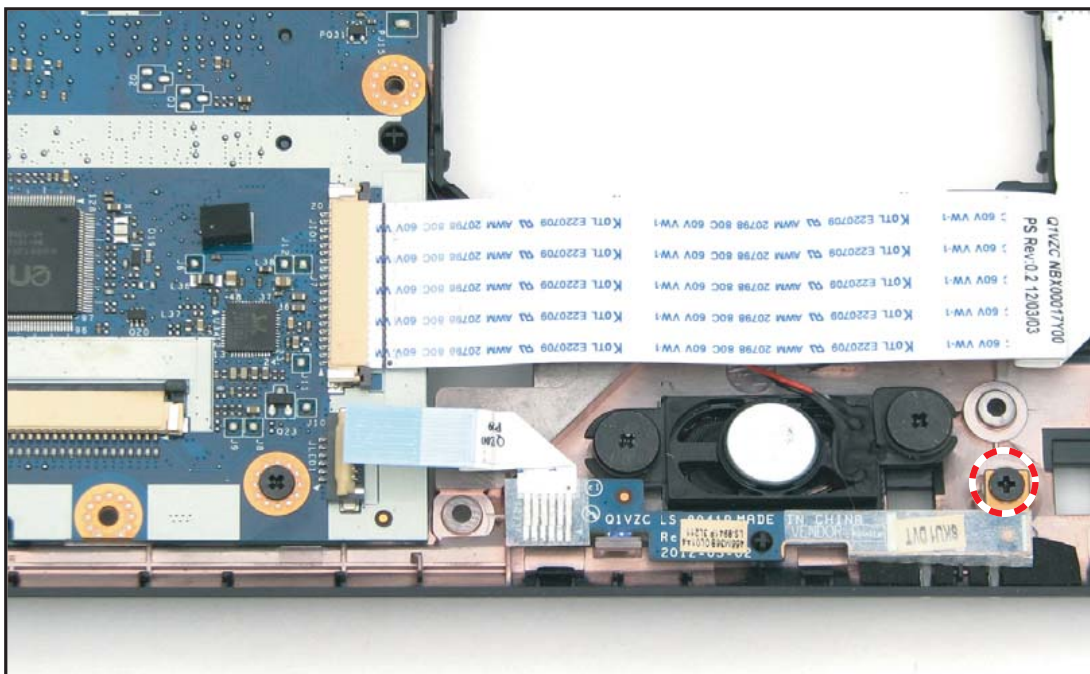

Figure 5:66. Installing the LED Board Screw

3. With mainboard connector clips flipped up, connect the LED board cable connector to the mainboard connector, then flip the clips down to lock.

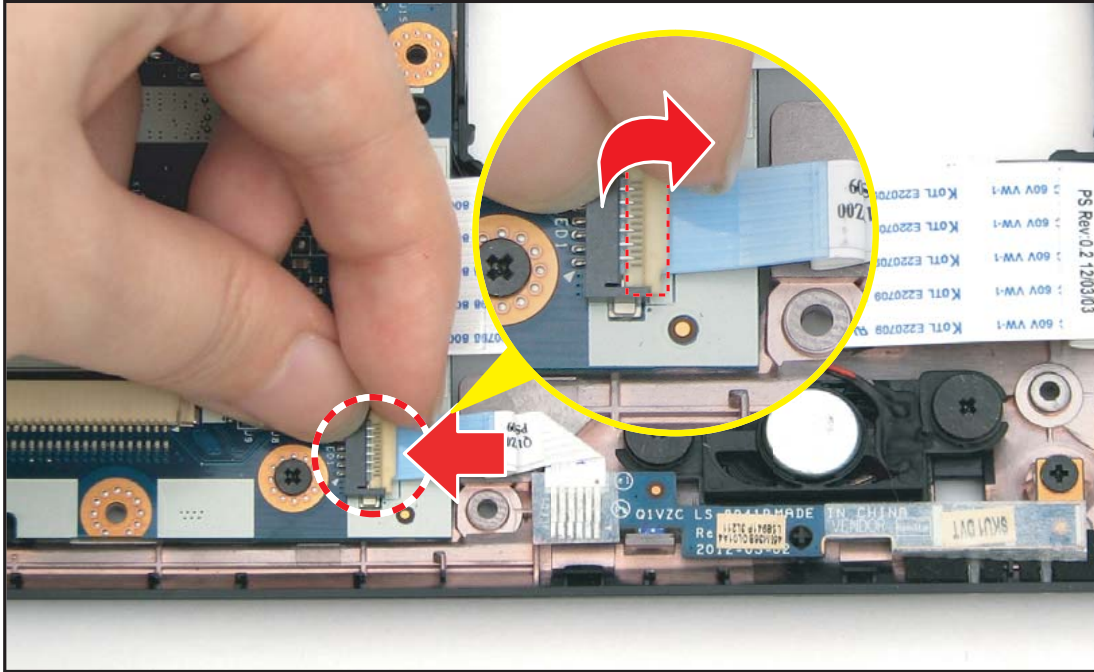



Figure 5:67. Connecting the LED Board Cable

4. Install the upper case (see [Upper Case Installation](#) on page 5-36).

Table 5:15. LED Board Screw

Screw Name	Screw Type	Quantity
M 2.0 x 3.0		1

Speaker Removal

Prerequisite:

※ [Mainboard Removal](#) on page [5-39](#)

1. Remove the four (4) screws securing the speakers to the lower case.

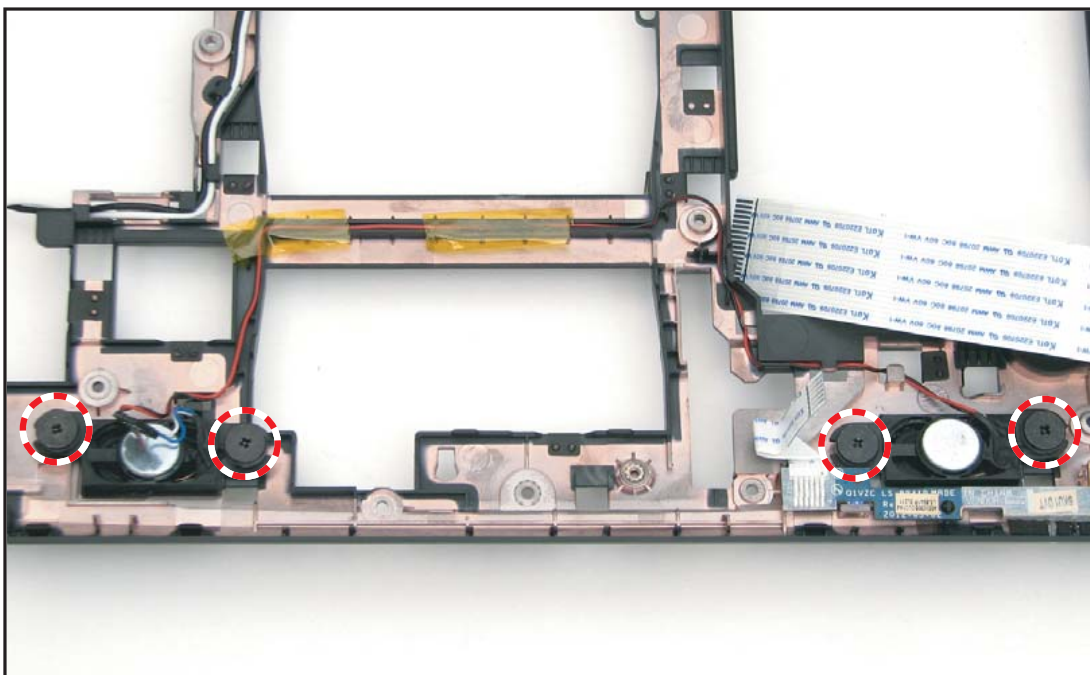

Figure 5:68. Removing the Speaker Screws

2. Lift to remove the right speaker, release the speaker cable from the guides on the lower case and remove the tapes securing the speaker cable.

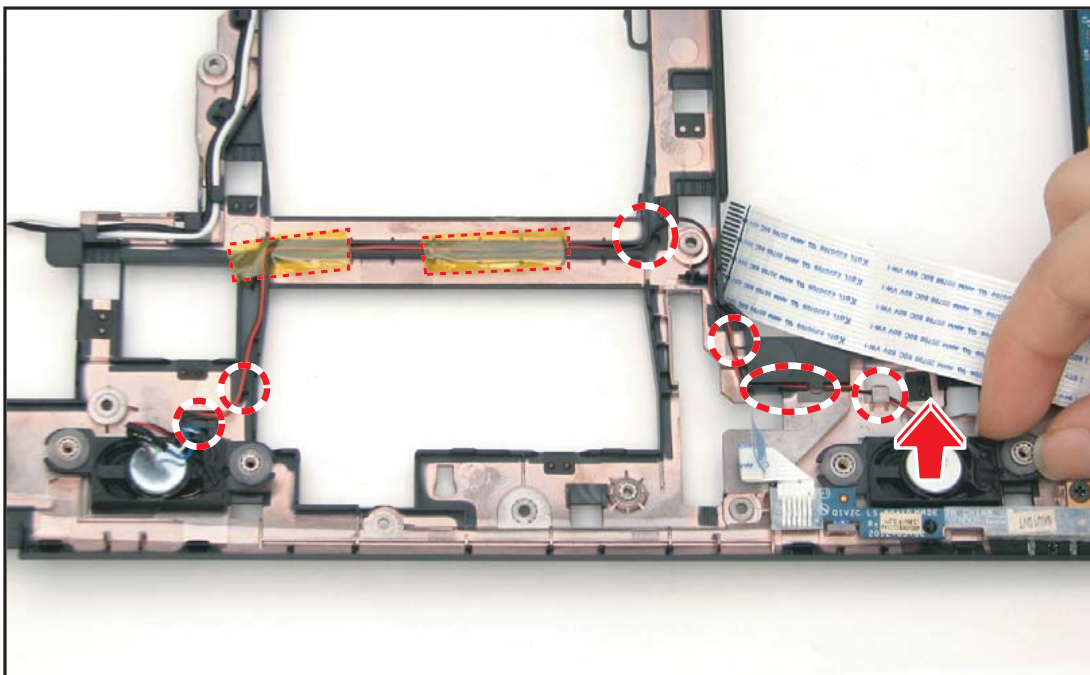

Figure 5:69. Removing the Speakers (1 of 2)

3. Lift to remove the left speaker.

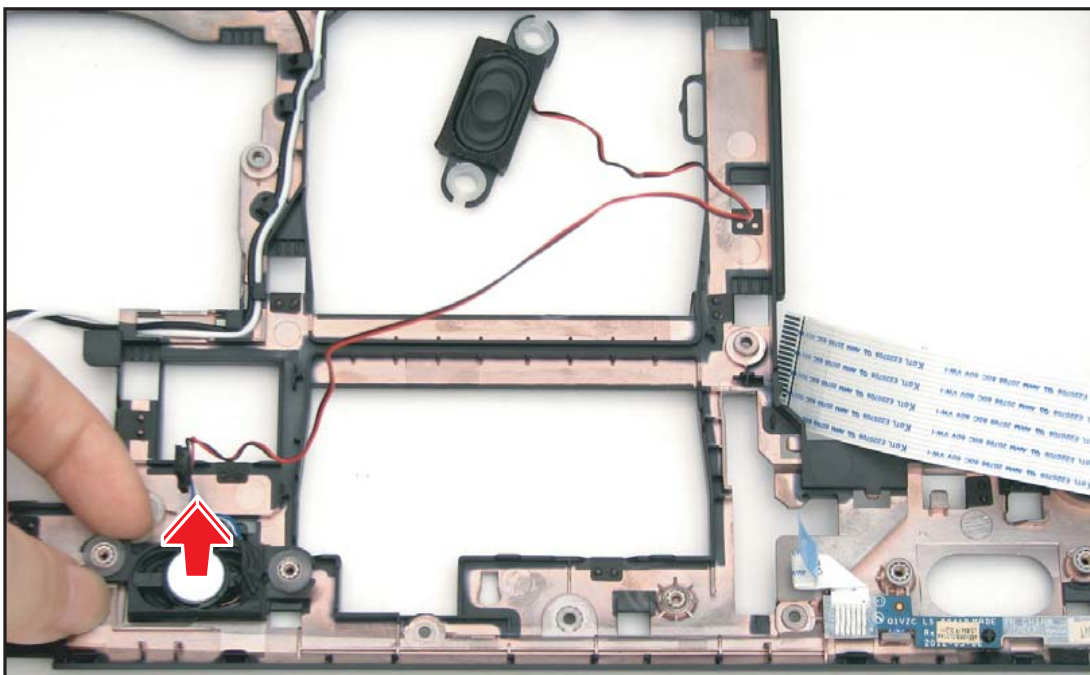

Figure 5:70. Removing the Speakers (2 of 2)

Speaker Installation

1. Align and place the left speaker on its slot on the lower case.

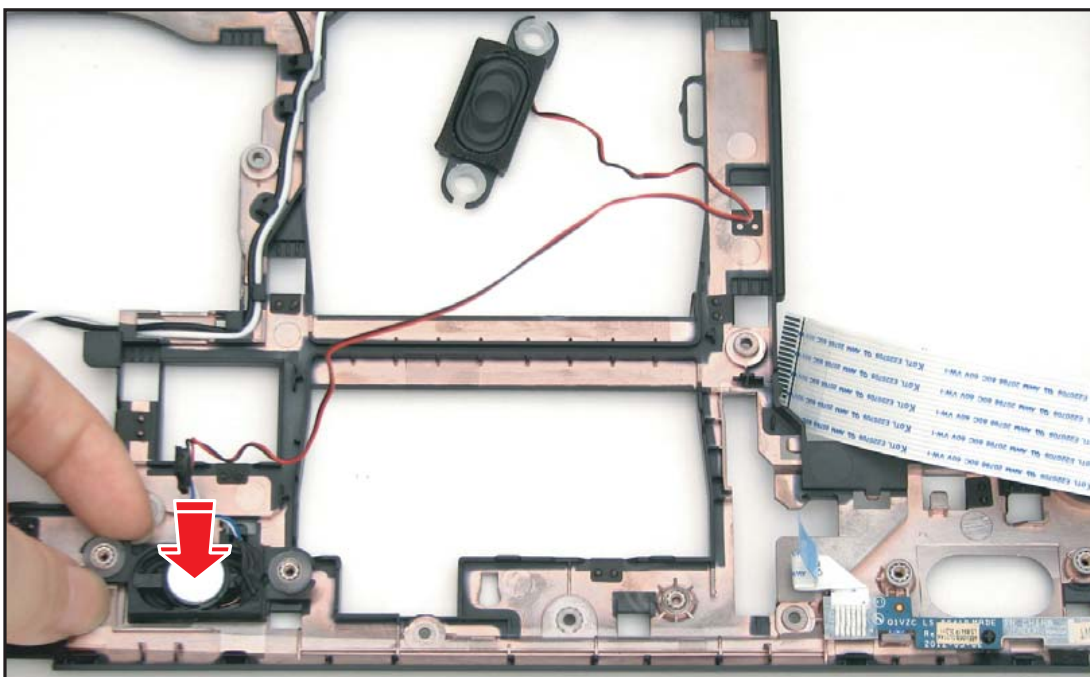

Figure 5:71. Installing the Speakers (1 of 2)

2. Do the following:
 - a. Route the speaker cable through the guides on the lower case.
 - b. Place the right speaker to its slot.
 - c. Attach the tapes to secure the speaker cable.

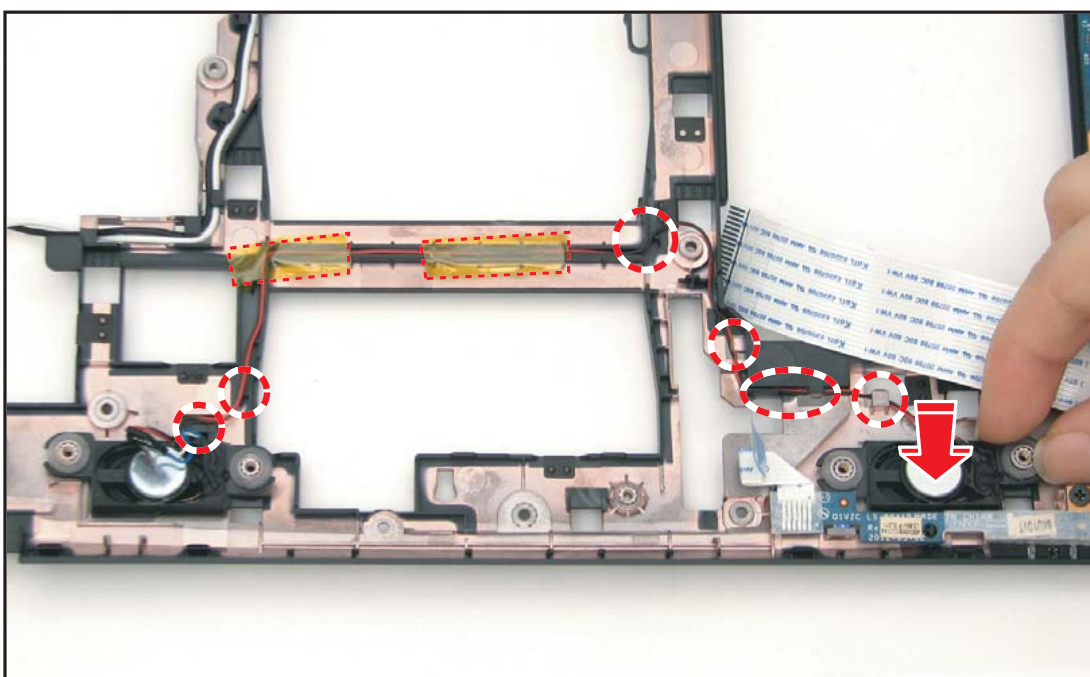

Figure 5:72. Installing the Speakers (2 of 2)

3. Attach the four (4) screws to the speakers to secure them on the lower case.

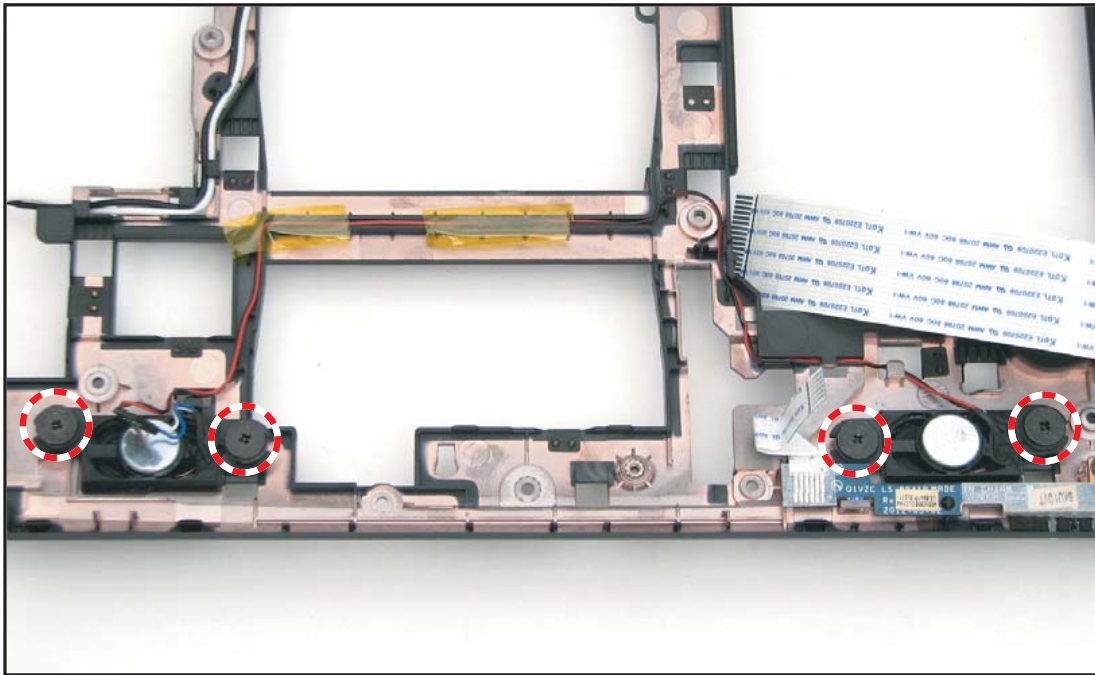



Figure 5:73. Attaching the Speaker Screws

Table 5:16. Speaker Screws

Screw Name	Screw Type	Quantity
M 2.0 x 3.0		4

Keyboard Removal

Prerequisite:

※ [Upper Case Removal](#) on page 5-31

1. Remove the 17 screws securing the keyboard plate and the keyboard to the upper case.

TIP: Some screws are located under the mylar.

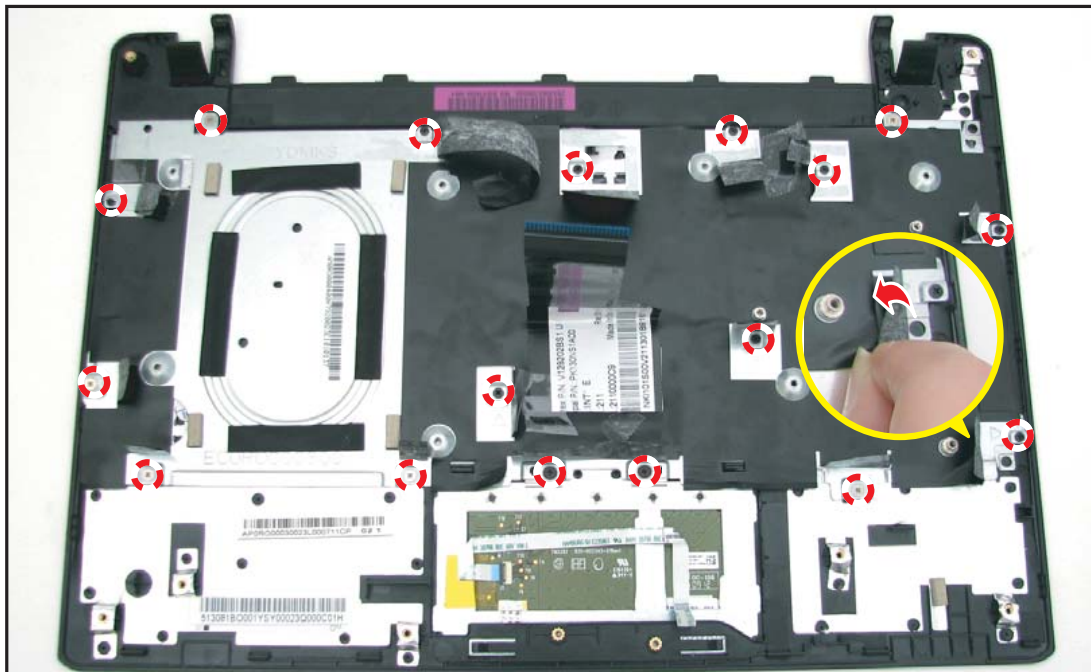

Figure 5:74. Removing the Keyboard Screws

2. Lift to remove the keyboard plate.

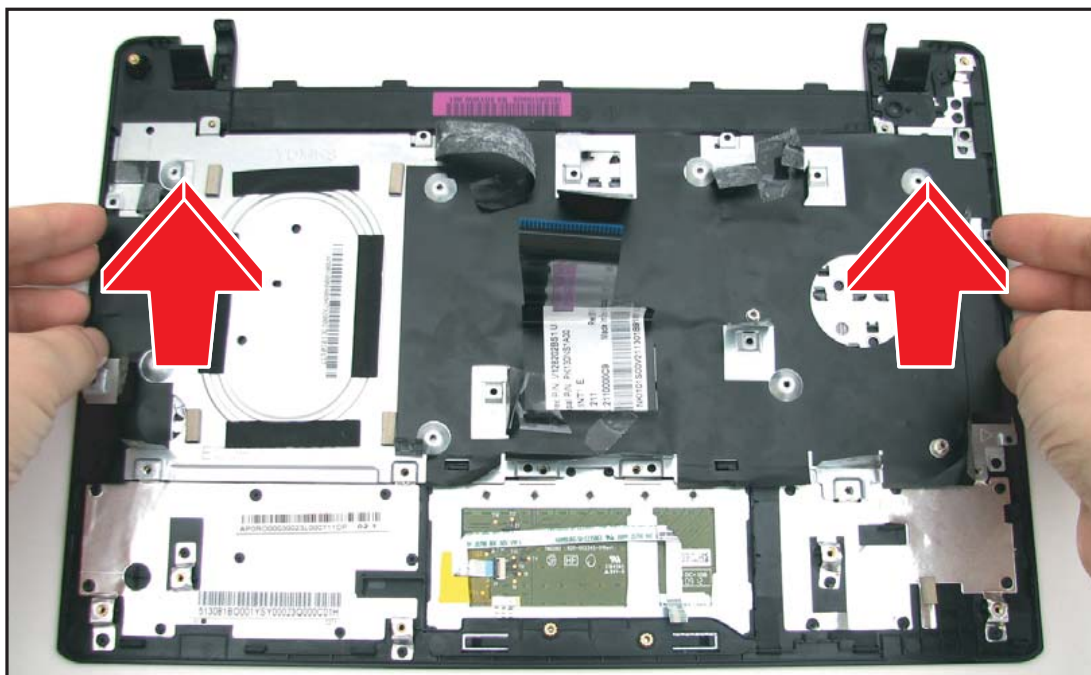

Figure 5:75. Removing the Keyboard Plate

Keyboard Installation

1. Align the keyboard to the upper case.

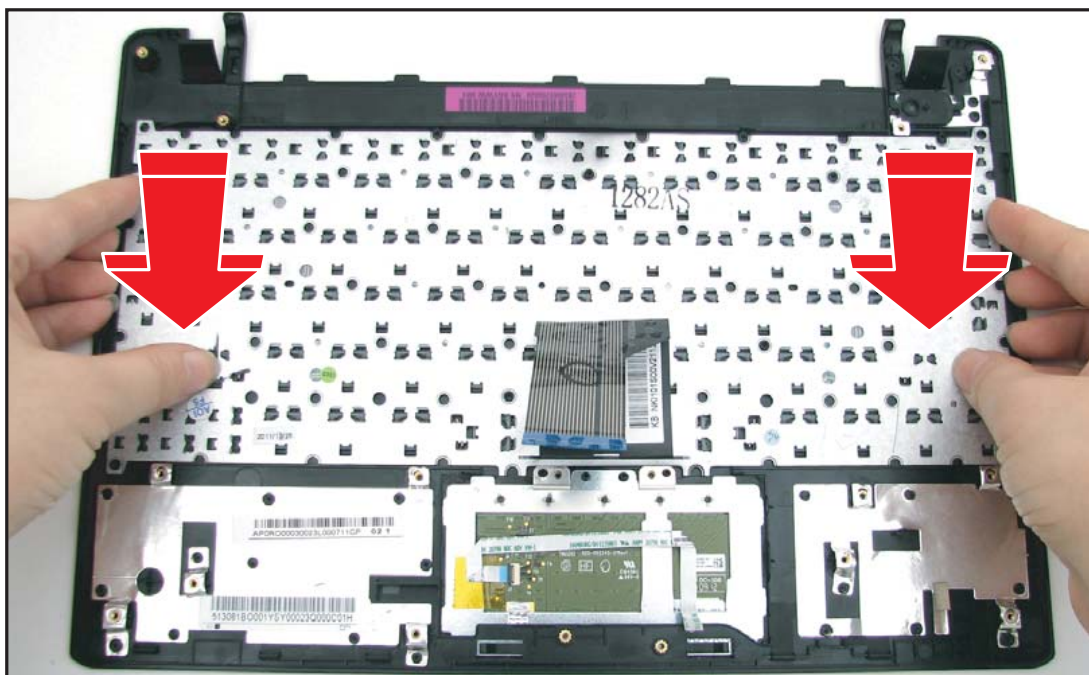

Figure 5:77. Installing the Keyboard

2. Align and install the keyboard plate to the keyboard. And route the keyboard cable to pass through the keyboard plate.

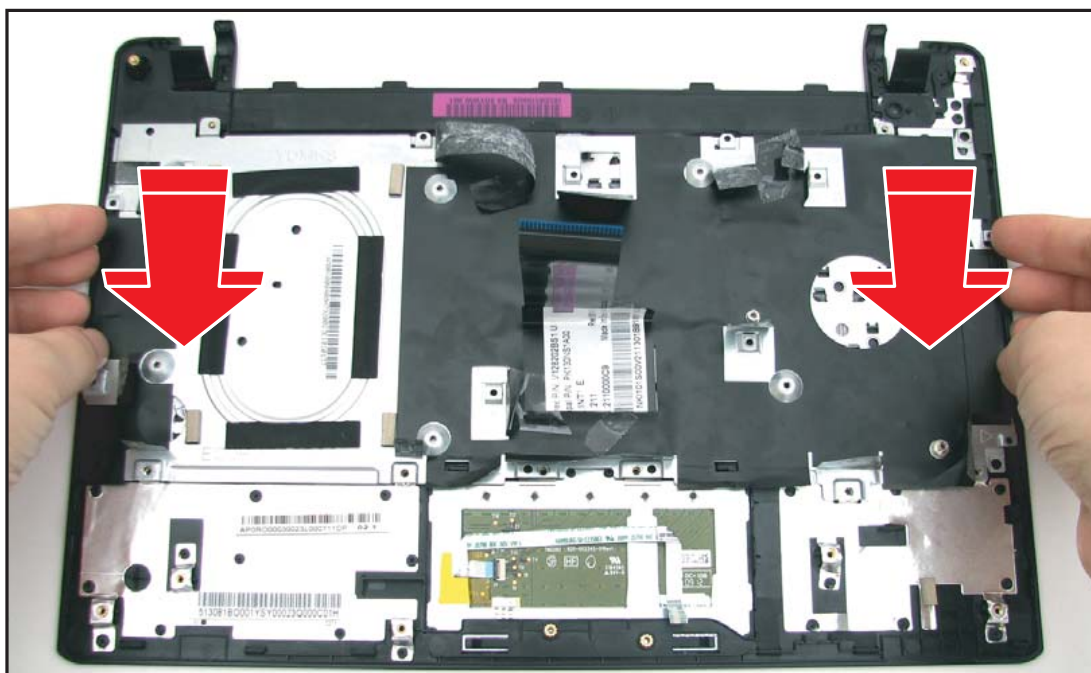

Figure 5:78. Installing the Keyboard Plate

- Attach the six (6) M2.0 x 2.5 screws (marked as A) and the eleven (11) M1.7 x 2.5 screws to secure the keyboard plate and the keyboard to the upper case.

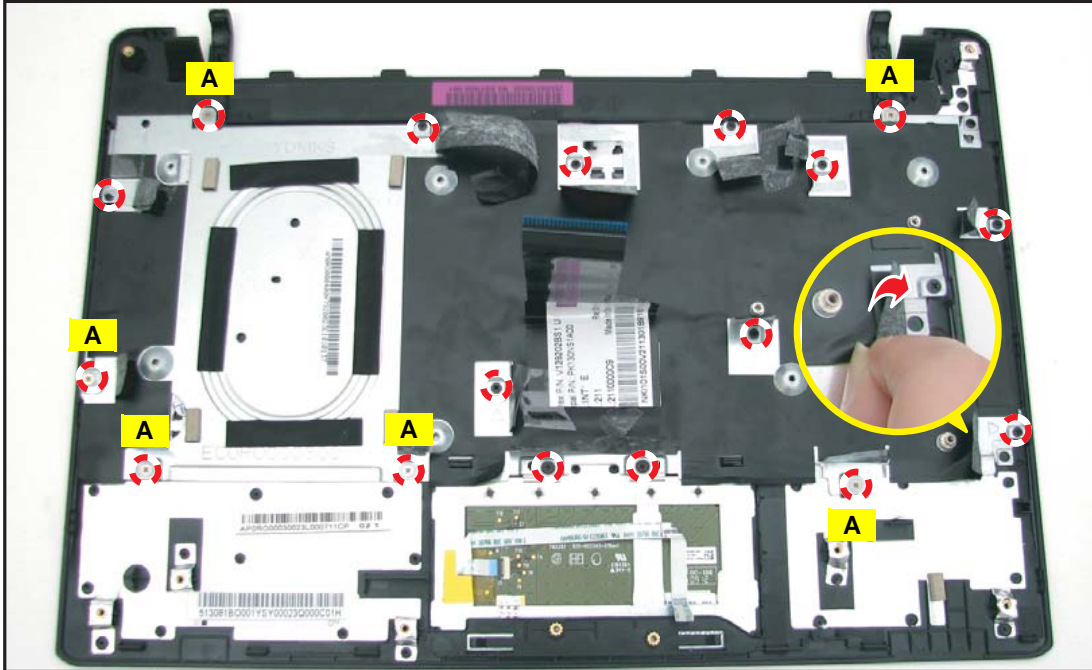



Figure 5:79. Securing the Keyboard Plastic

- Install the upper case (see [Upper Case Installation](#) on page [5-36](#)).

Table 5:17. Keyboard Screws

Screw Name	Screw Type	Quantity
M 1.7 x 2.5		11
M 2.0 x 2.5		6

Touchpad Removal

Prerequisite:

※ [Keyboard Removal](#) on page 5-55

1. Locate the touchpad module on the underside of the upper case.
2. Lift the touchpad cable to detach the adhesives under the cable.

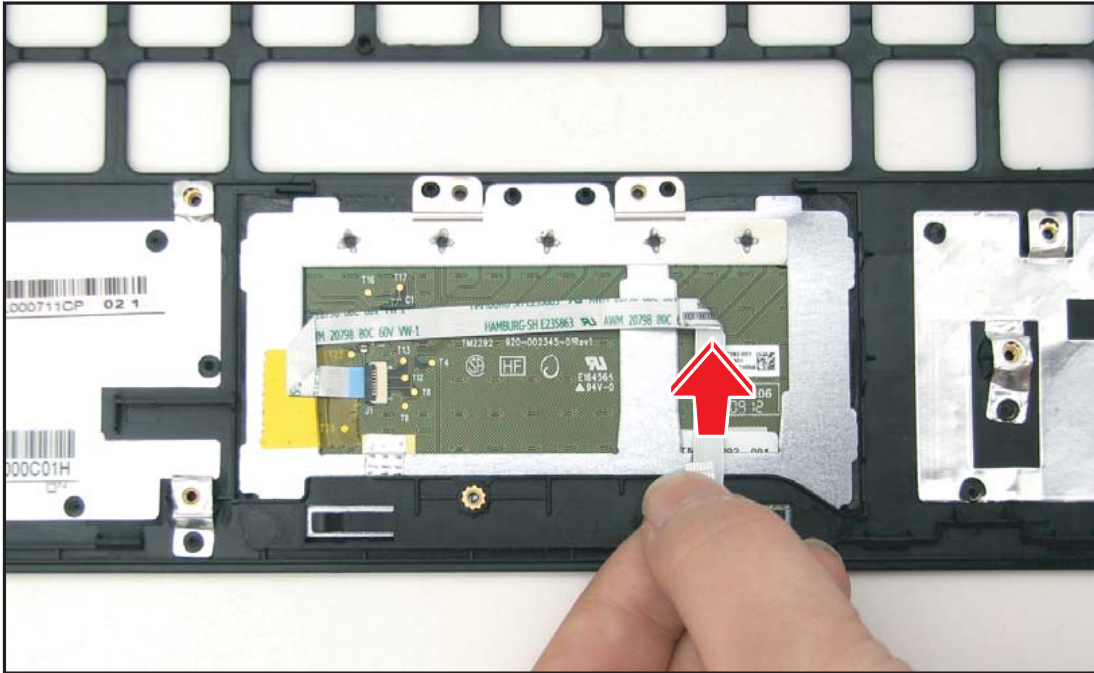

Figure 5:80. Removing the Touchpad Cable (1 of 2)

3. Flip up the connector clip to disconnect the touchpad cable connector.

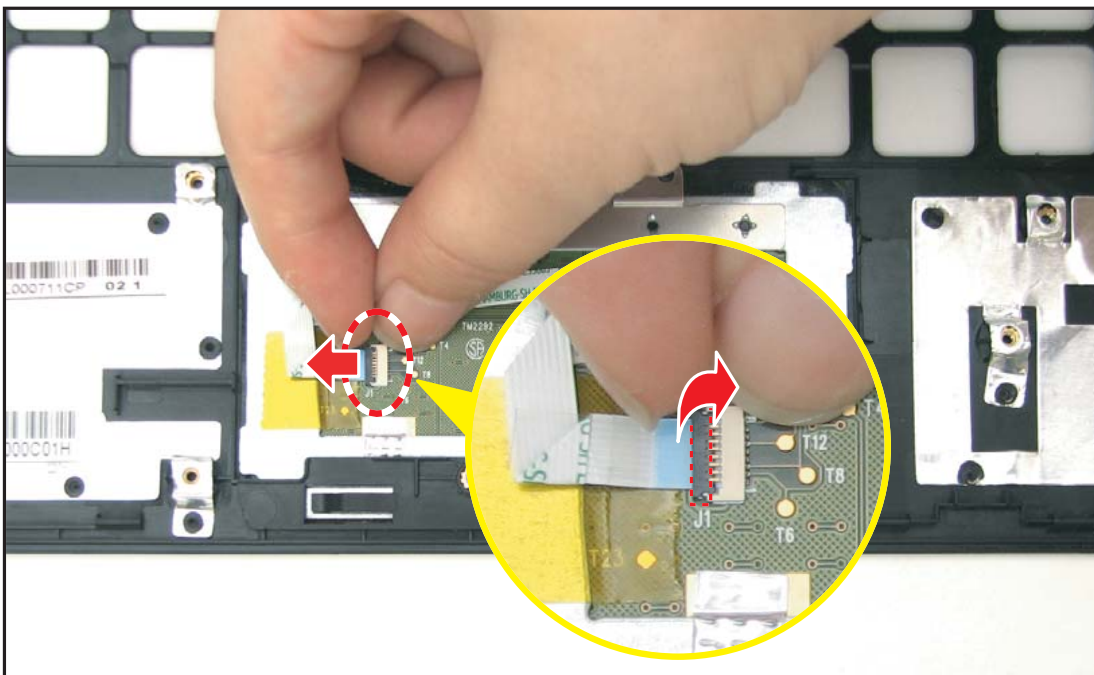

Figure 5:81. Removing the Touchpad Cable (2 of 2)

4. From the front side of the upper case, push the touchpad with your fingers to detach it from the upper case.

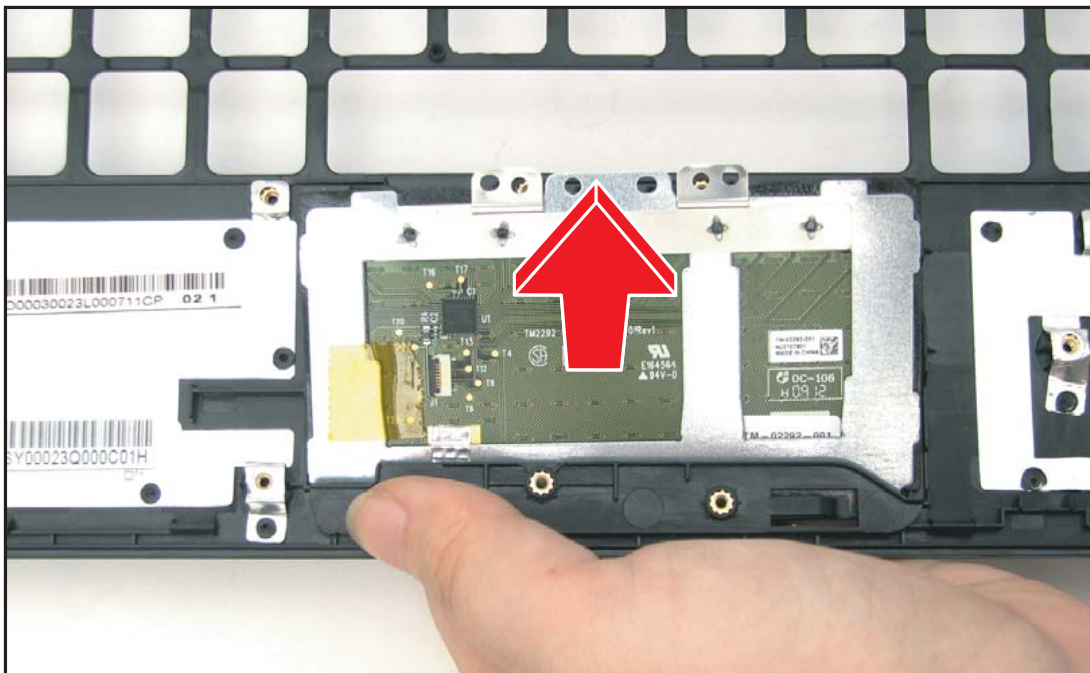

Figure 5:82. Removing the Touchpad

Touchpad Installation

1. Align and install the touchpad to its bay on the upper case.

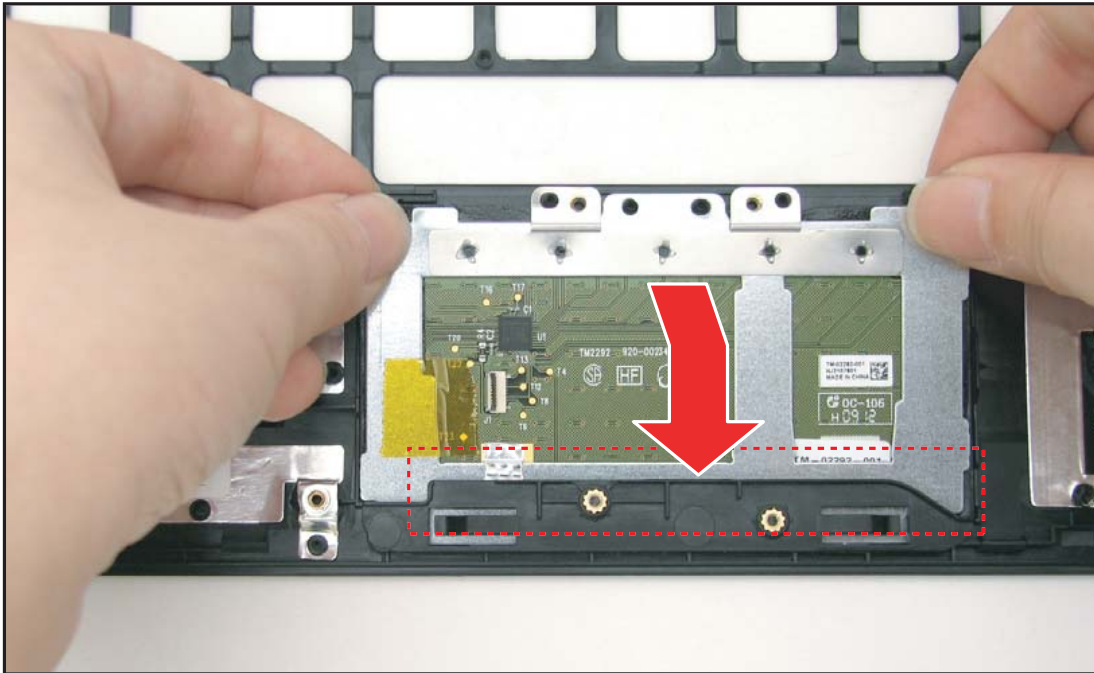

Figure 5:83. Installing the Touchpad

2. Connect the touchpad cable connector then flip the connector clip down to lock.

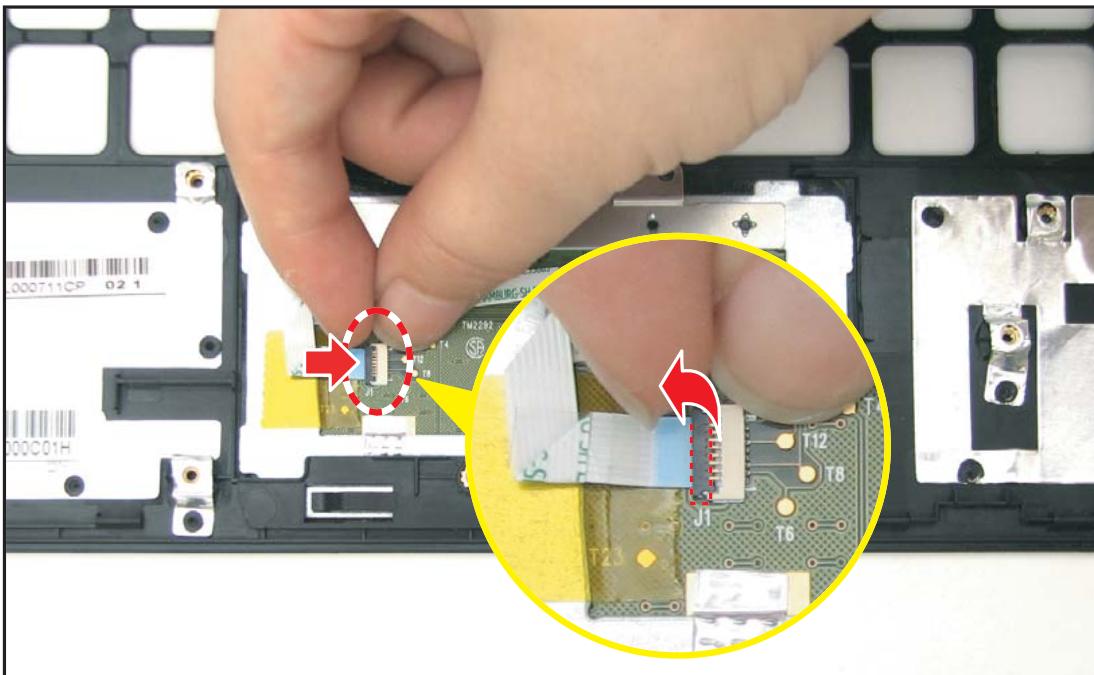

Figure 5:84. Connecting the Touchpad Cable

3. Press the touchpad cable to attach the adhesives and secure the cable on the upper case.

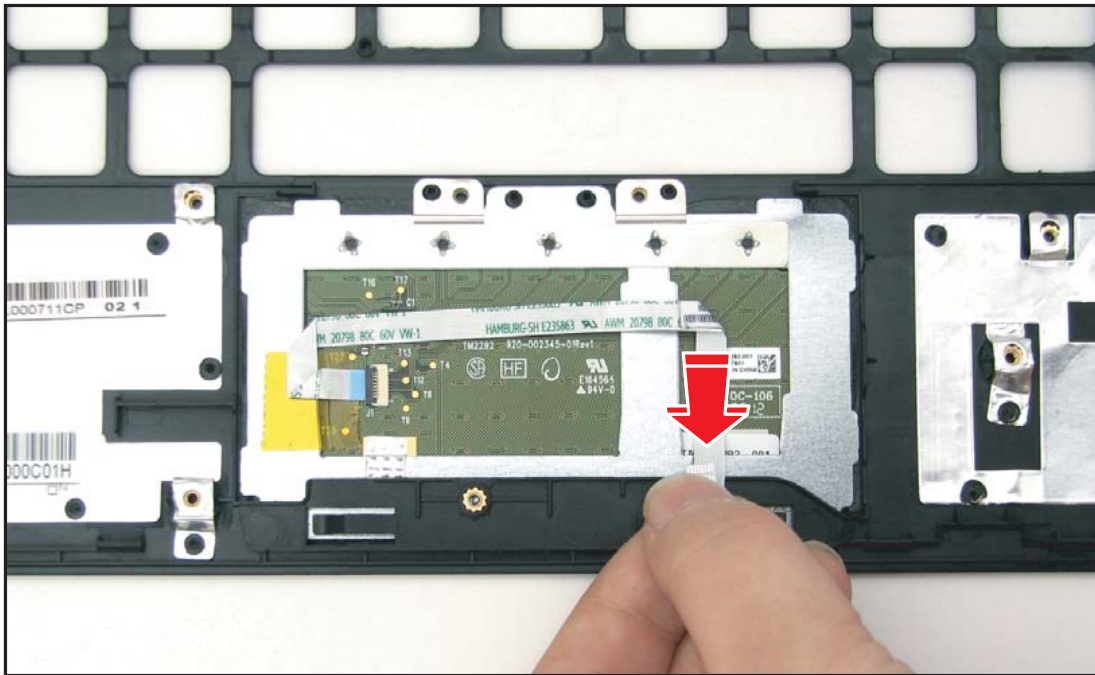

Figure 5:85. Securing the Touchpad Cable

Thermal Module Removal

Prerequisite:

※ [Mainboard Removal](#) on page [5-39](#)

1. On the underside of the mainboard, remove the four (4) screws securing the thermal module to the mainboard.

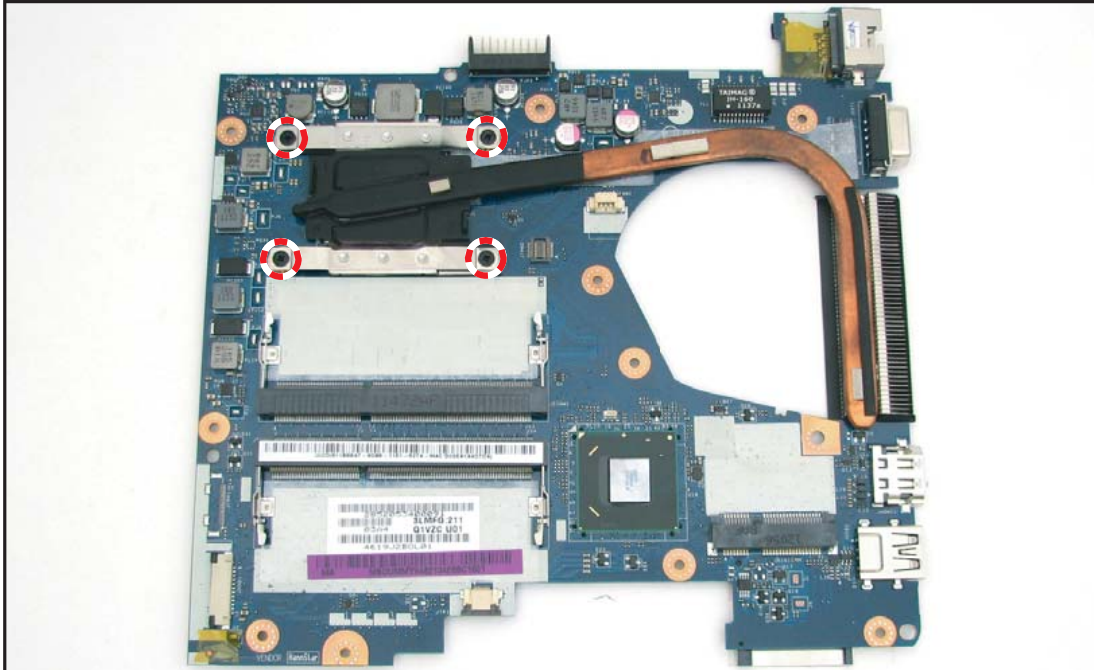

Figure 5:86. Removing the Thermal Module Screws

2. Lift to remove the thermal module.

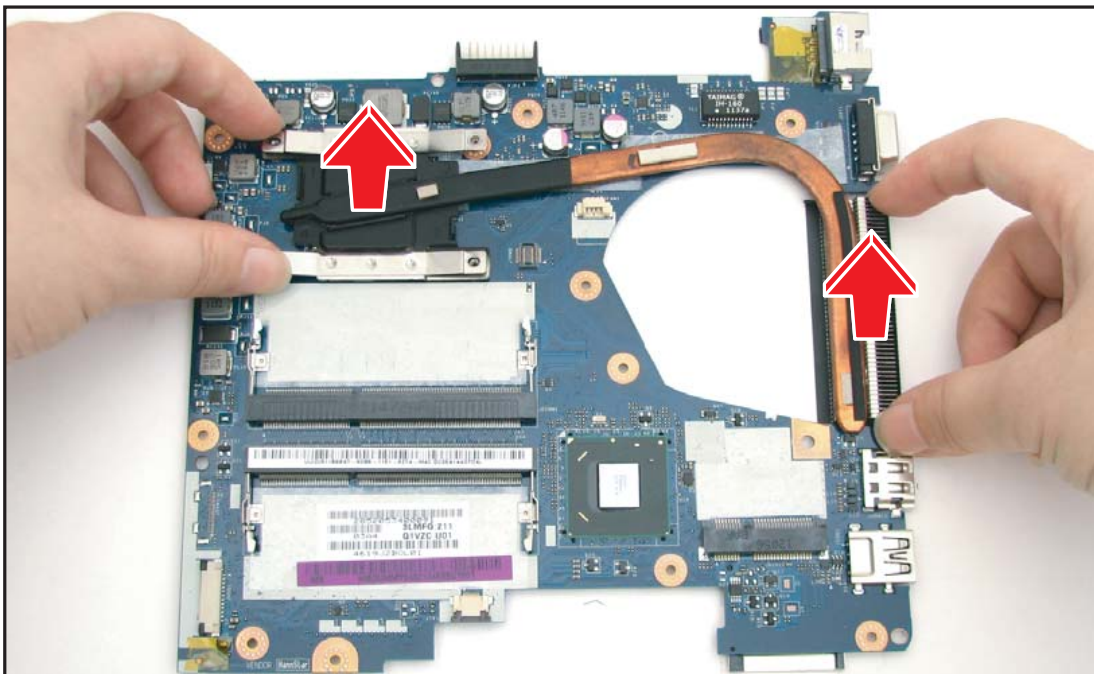

Figure 5:87. Removing the Thermal Module

Thermal Module Installation

1. Align the thermal module to the mainboard.

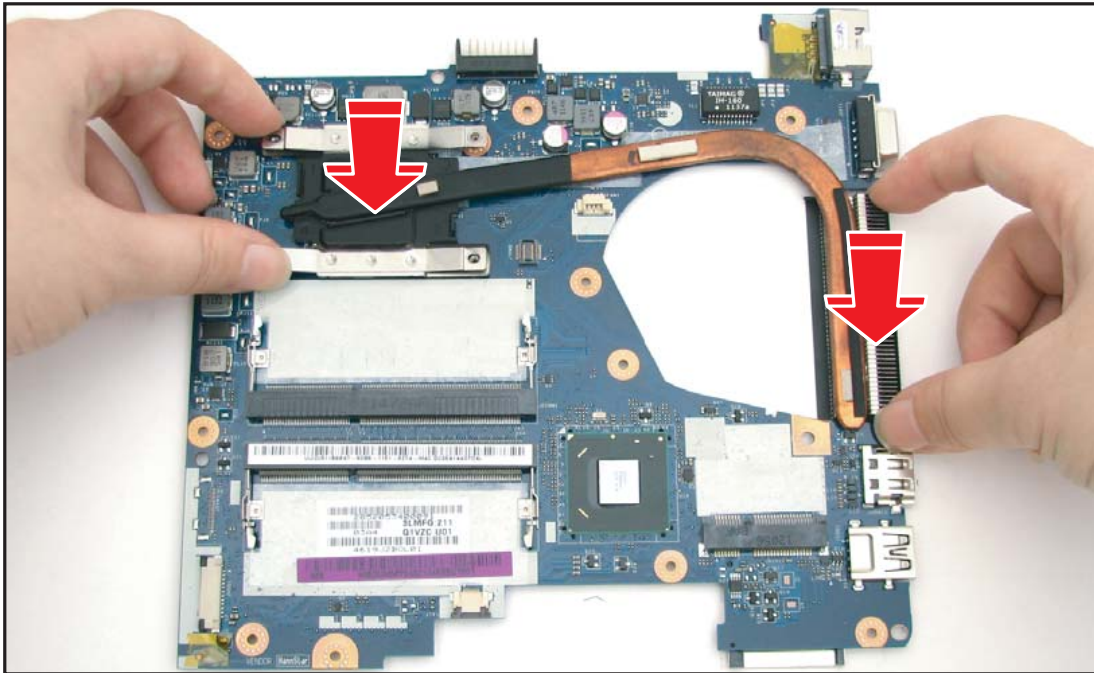

Figure 5:88. Installing the Thermal Module

2. Attach the four (4) screws to secure the thermal module to the mainboard.

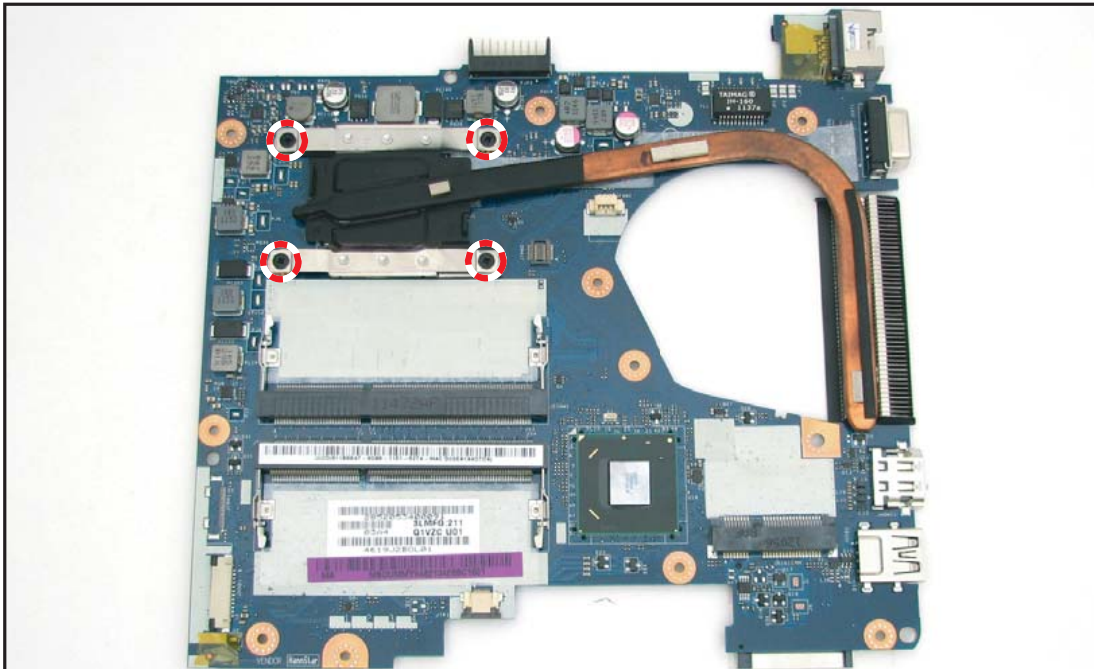



Figure 5:89. Securing the Thermal Module Screws

3. Install the mainboard (see [Mainboard Installation](#) on page [5-41](#)).

Table 5:18. Thermal Module Screws

Screw Name	Screw Type	Quantity
M 2.0 x 3.0		4

LCD Module Removal

Prerequisite:

※ [Mainboard Removal](#) on page [5-39](#)

1. Remove the DC-In cable from the guides on the lower case, then set the cable aside.

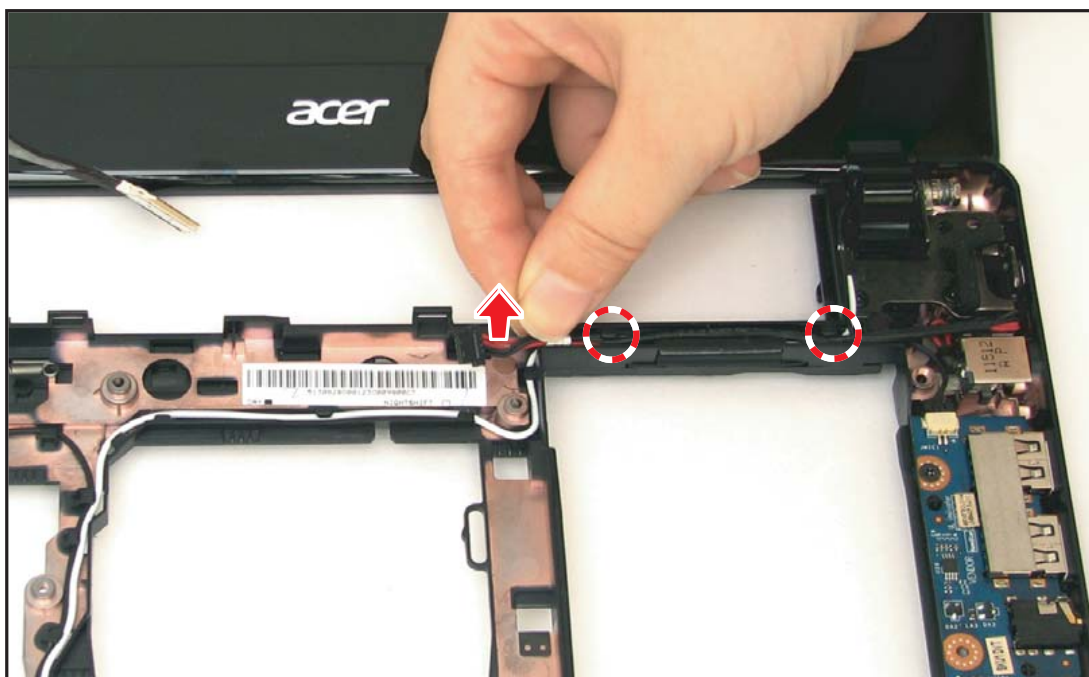

Figure 5:90. Removing the DC-In Cable

2. Disconnect the microphone cable connector from the IO board connector, and remove the microphone cable from the guide on the lower case.



Figure 5:91. Disconnecting the Microphone Cable

3. Remove the WLAN antenna cables from the guides on the lower case.

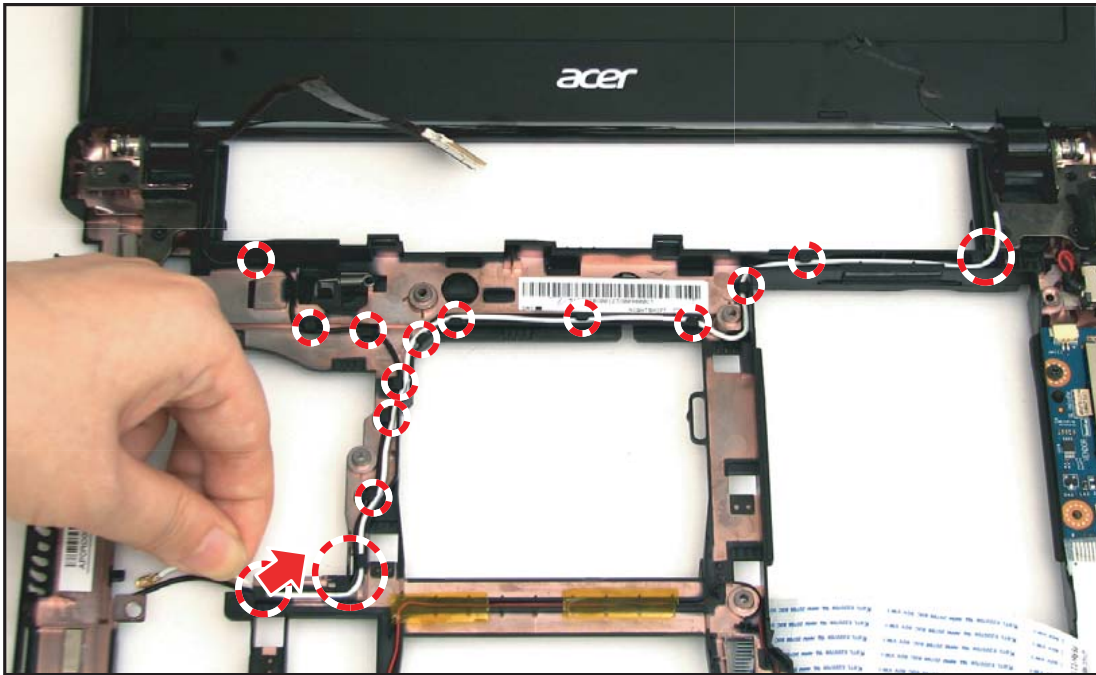

Figure 5:92. Removing the WLAN Antenna Cables

4. Remove the four (4) screws securing the LCD hinges to the lower case.



Figure 5:93. Removing the LCD Module Screws

5. Lift to remove the LCD module from the lower case.



Figure 5:94. Removing the LCD Module

LCD Module Installation

1. Align and place the LCD module hinges to the lower case.

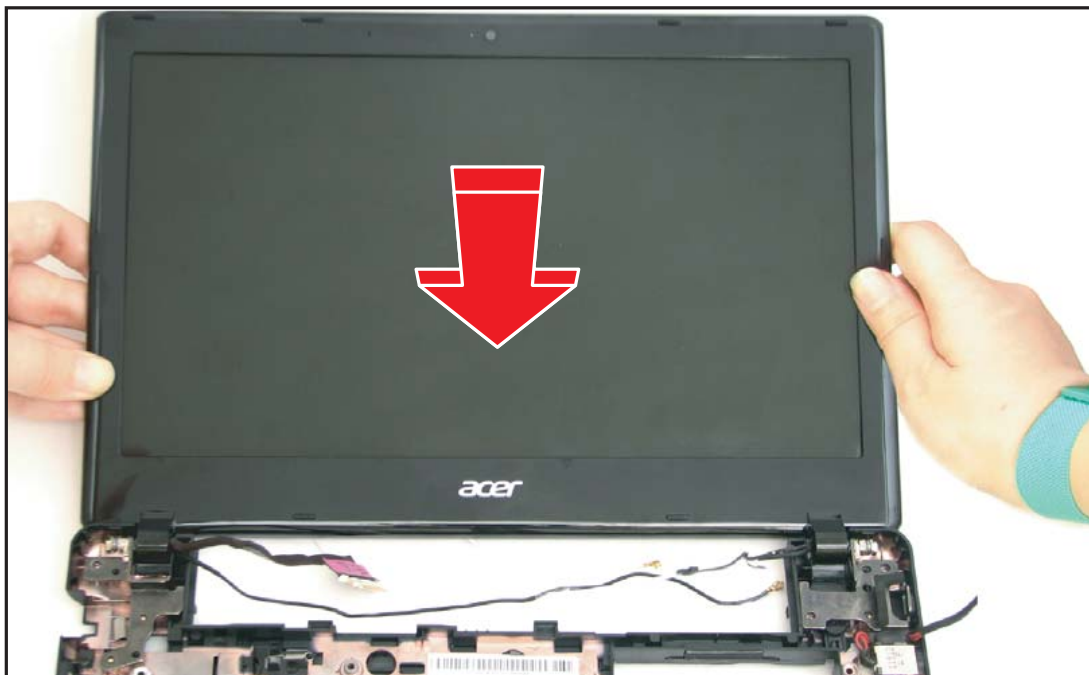

Figure 5:95. Installing the LCD Module

2. Attach the four (4) screws to secure the LCD module hinges to the lower case.



Figure 5:96. Securing the LCD Module Screws

3. Route the WLAN antenna cables on the guides on the lower case until the cables pass through the lower case hole.

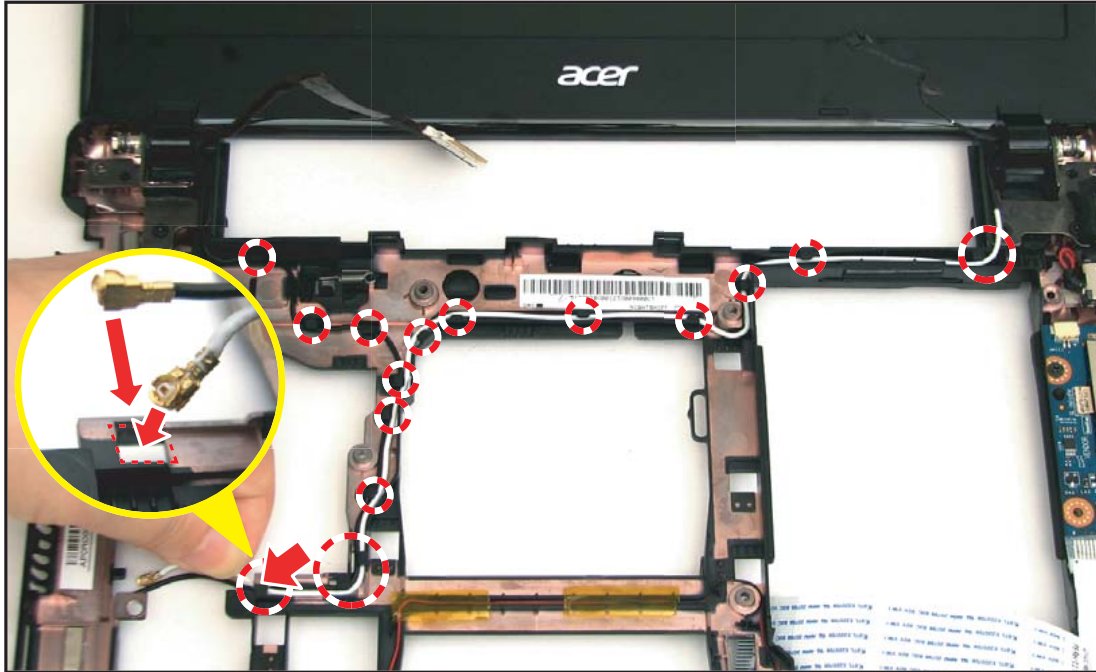

Figure 5:97. Routing the WLAN Antenna Cables

4. Route the microphone cable to the guide on the lower case and connect to the IO board connector.

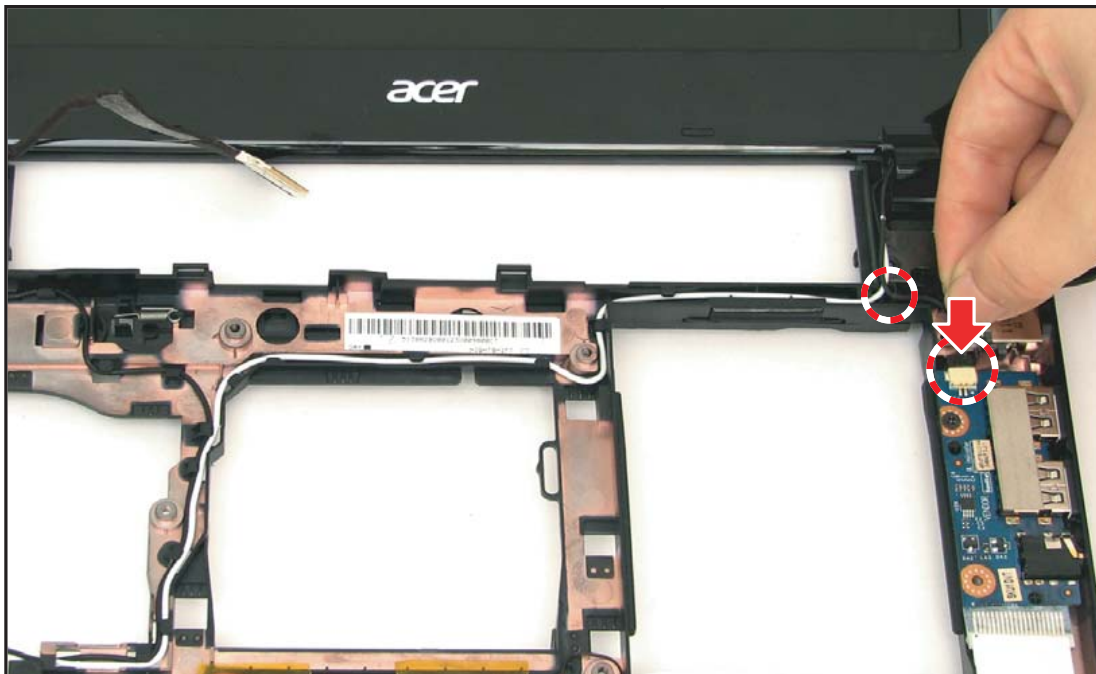

Figure 5:98. Connecting the Microphone Cable

5. Route the DC-In cable to the guide on the lower case.

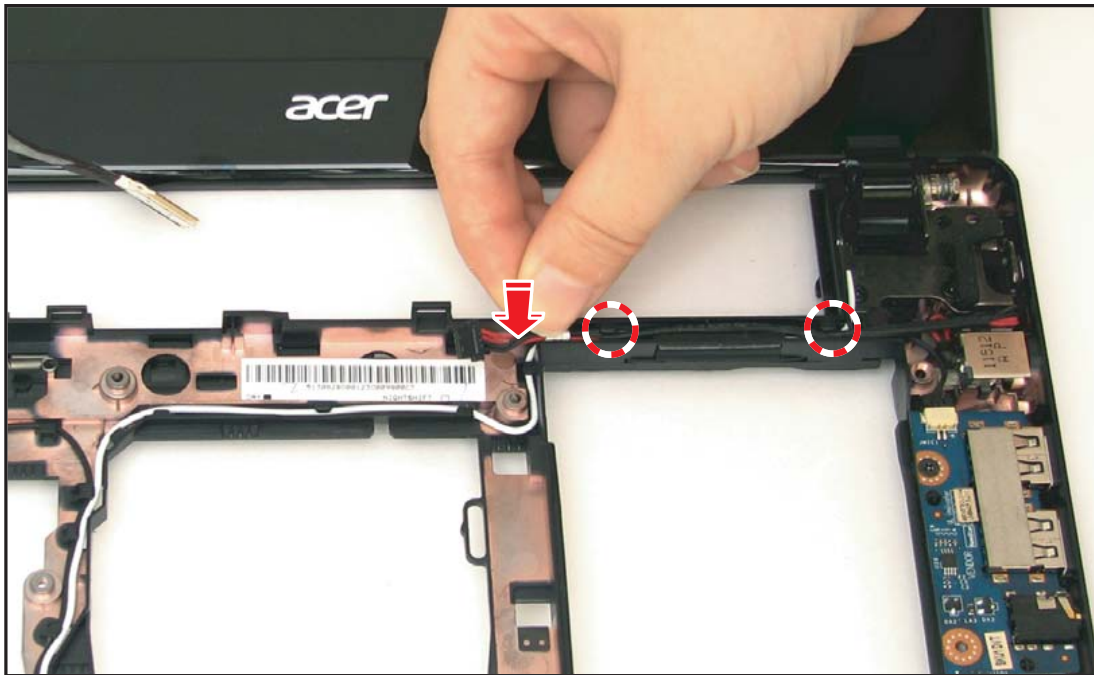



Figure 5:99. Routing the DC-In Cable

6. Install the mainboard (see [Mainboard Installation](#) on page 5-41).

Table 5:19. LCD Module Screws

Screw Name	Screw Type	Quantity
M 2.0 x 6.0		4

DC-In Cable Removal

Prerequisite

※ [LCD Module Removal](#) on page 5-66

Using the plastic pry, lift the DC-in cable jack.

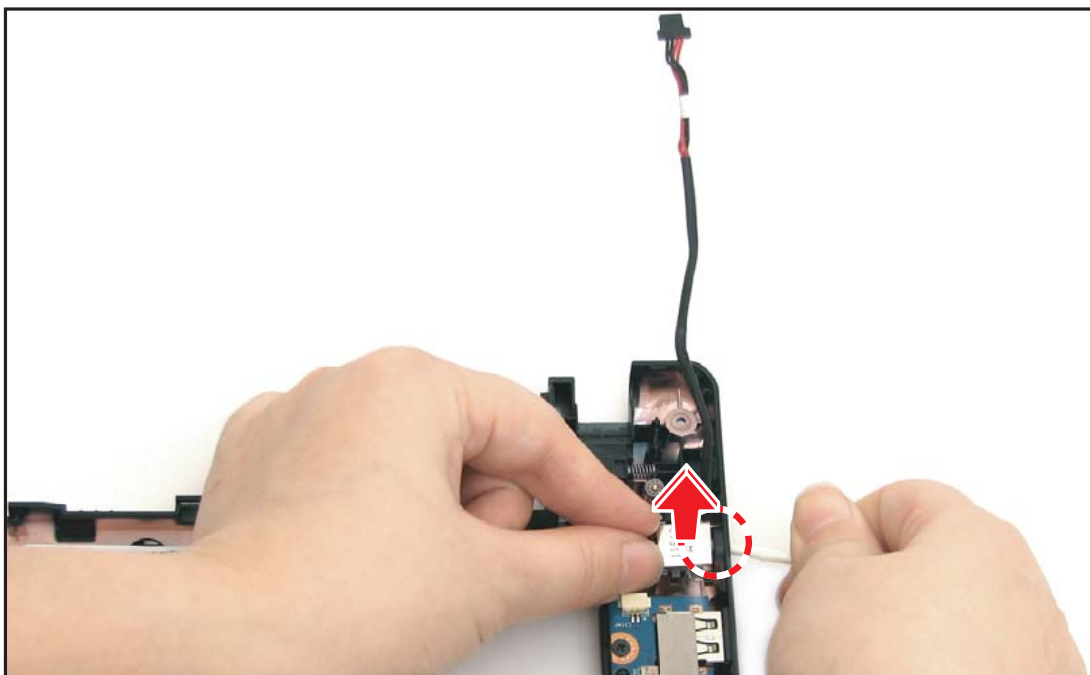

Figure 5:100. Removing the DC-In Cable (1 of 2)

DC-In Cable Installation

1. Install the DC-in cable jack to the lower case.

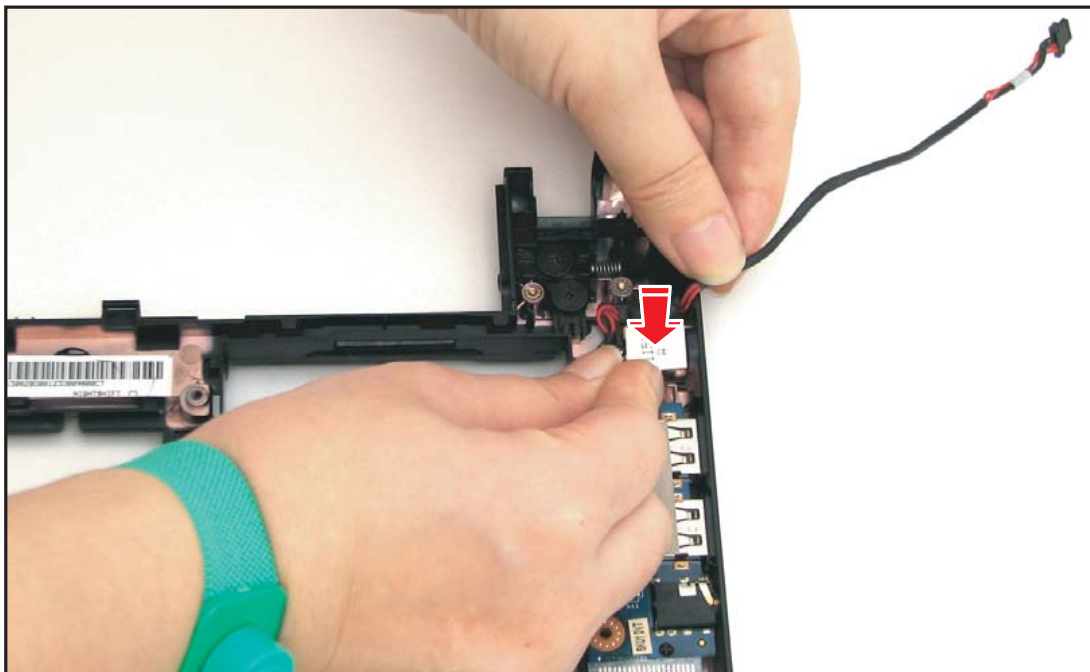

Figure 5:101. Installing the DC-In Cable

2. Install the LCD module (see [LCD Module Installation](#) on page [5-69](#)).

LCD Bezel Removal

Prerequisite:

※ [LCD Module Removal](#) on page 5-66

1. Pry inwards to release the top and side latches on the LCD bezel.



Figure 5:102. Removing the LCD Bezel (1 of 3)

2. Continue to pry the bottom side latches of the LCD bezel.

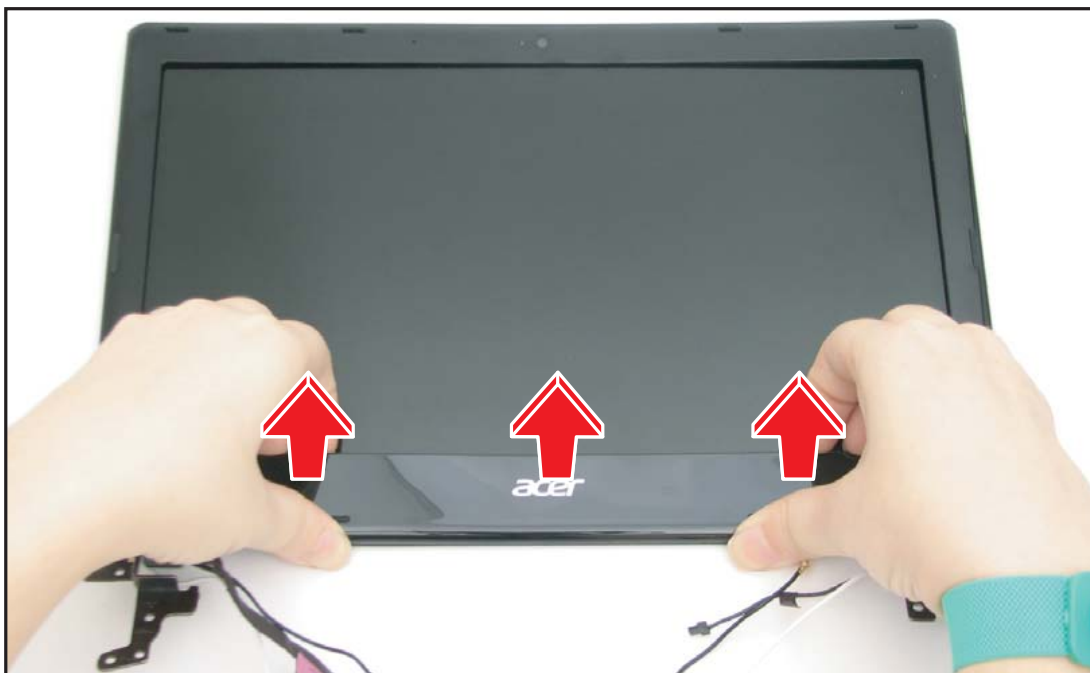

Figure 5:103. Removing the LCD Bezel (2 of 3)

3. Lift to remove the LCD bezel.



Figure 5:104. Removing the LCD Bezel (3 of 3)

LCD Bezel Installation

1. Align the LCD panel hinges to the LCD bezel.



Figure 5:105. Installing the LCD Bezel (1 of 3)

2. Secure the bottom side latches of the LCD bezel.

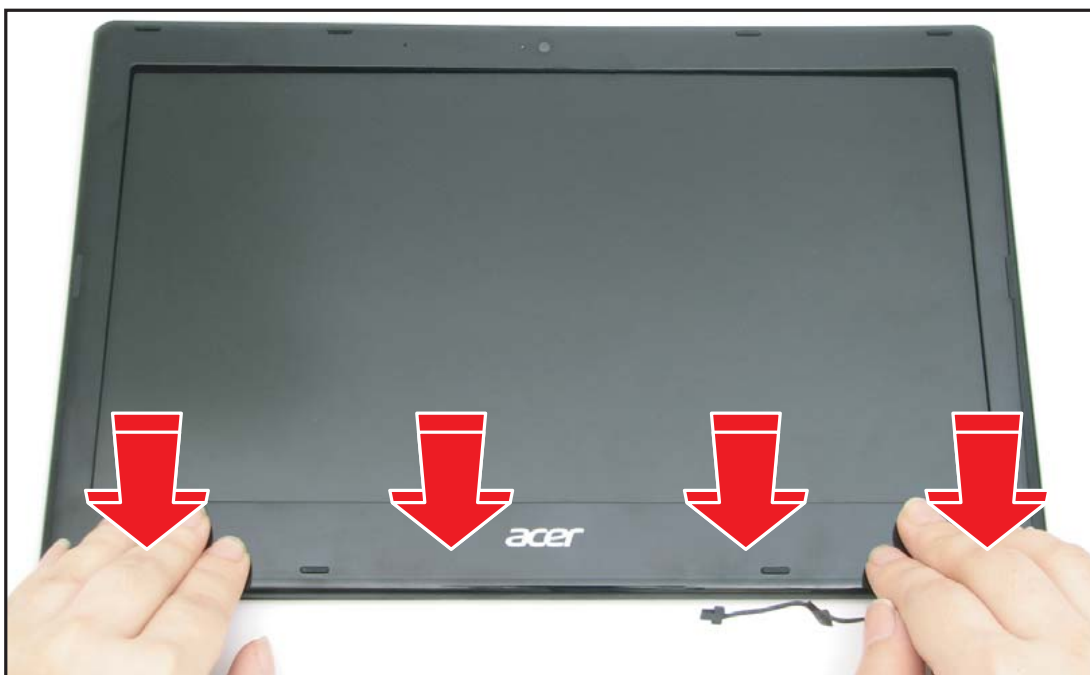

Figure 5:106. Installing the LCD Bezel (2 of 3)

3. Continue to secure the top and side latches.



Figure 5:107. Installing the LCD Bezel (3 of 3)

4. Install the LCD module (see [LCD Module Installation](#) on page [5-69](#)).

LCD Panel Removal

Prerequisite:

※ [LCD Bezel Removal](#) on page [5-74](#)

1. Remove the four (4) screws securing the LCD panel to the LCD cover.



Figure 5:108. Removing the LCD Panel Screws

2. Remove the LVDS mylar adhesives from the LCD panel.



Figure 5:109. Removing the LVDS Cable Adhesives

3. Lift to remove the LCD panel.



Figure 5:110. Removing the LCD Panel

4. On the underside of the LCD panel, lift the transparent mylar covering the LVDS cable connector.

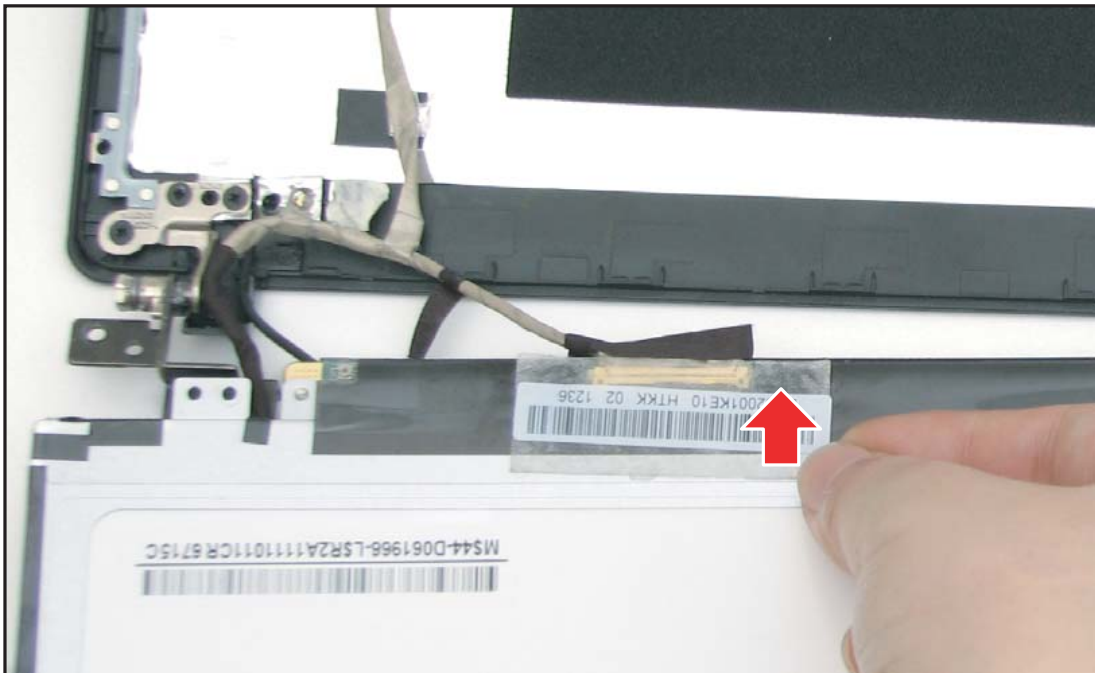

Figure 5:111. Disconnecting the LVDS Cable (1 of 2)

5. Disconnect the LVDS cable from the LCD panel connector.

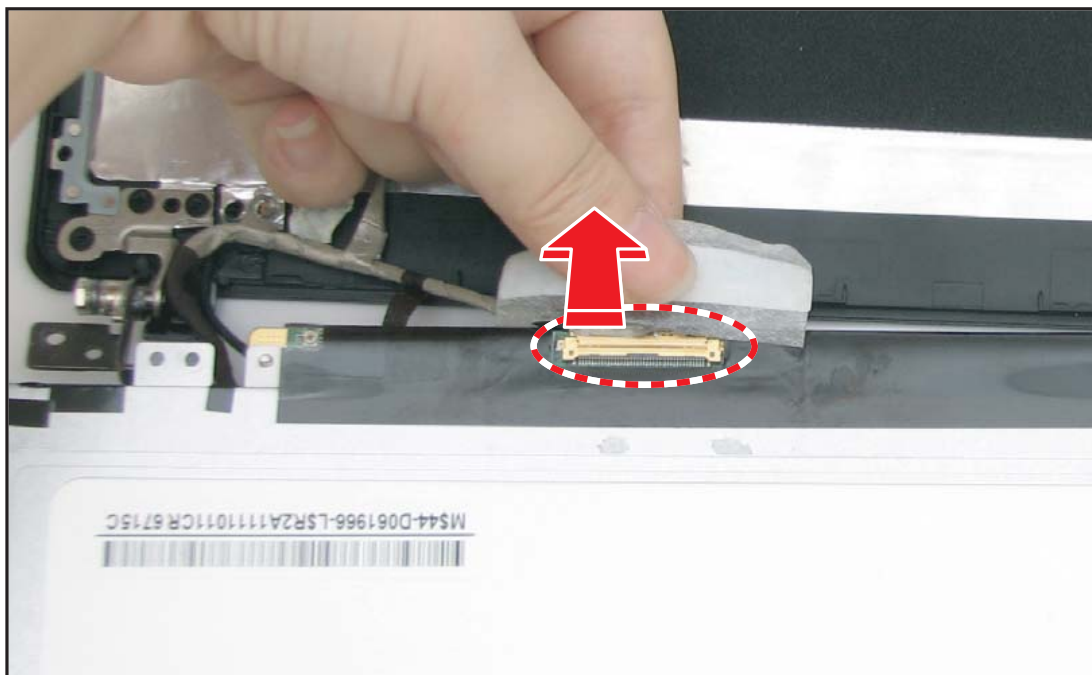

Figure 5:112. Disconnecting the LVDS Cable (2 of 2)

6. Remove the metallic tape securing the camera cable to the LCD cover.

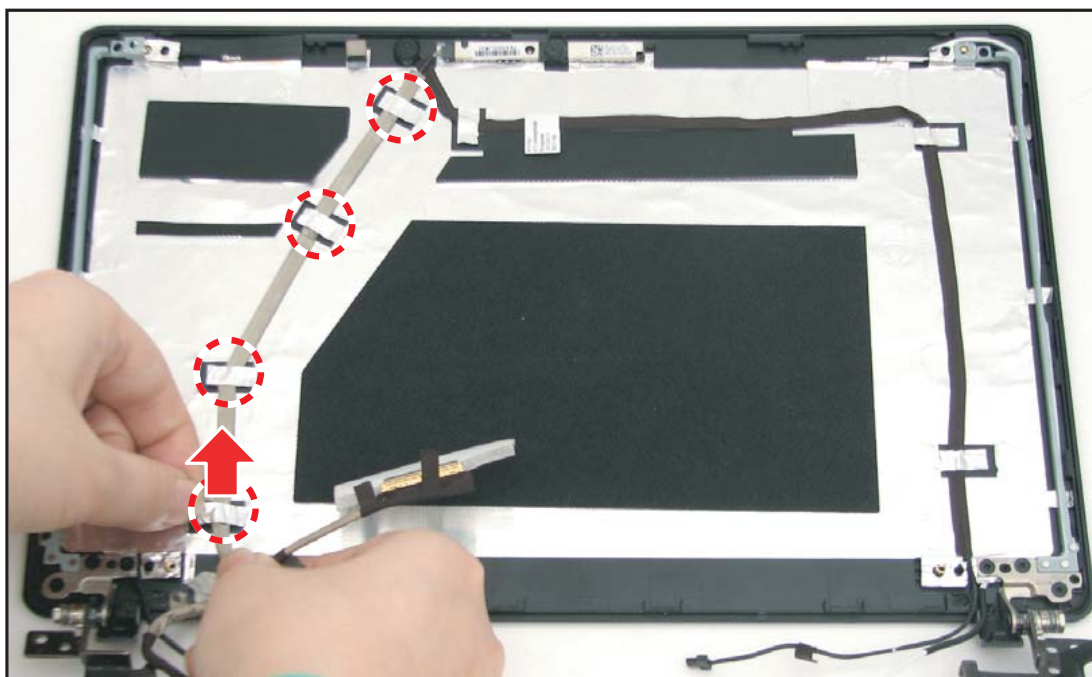

Figure 5:113. Removing the Metallic Tape

7. Lift to remove the camera from the LCD cover.

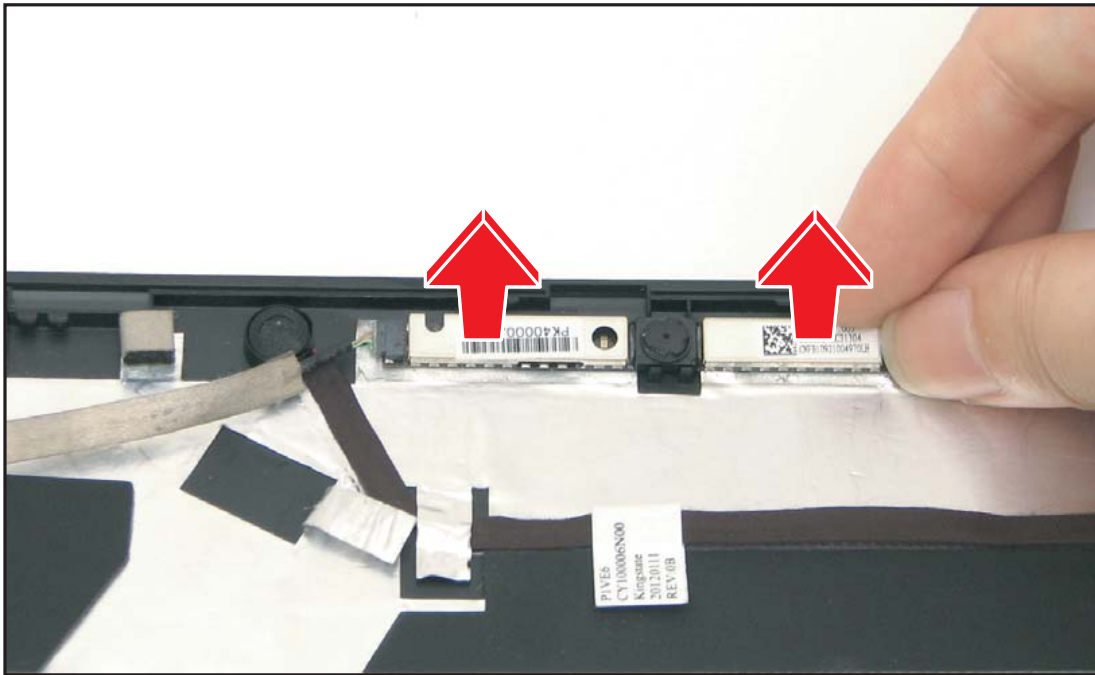

Figure 5:114. Removing the Camera

8. Disconnect the camera cable connector from the camera module.

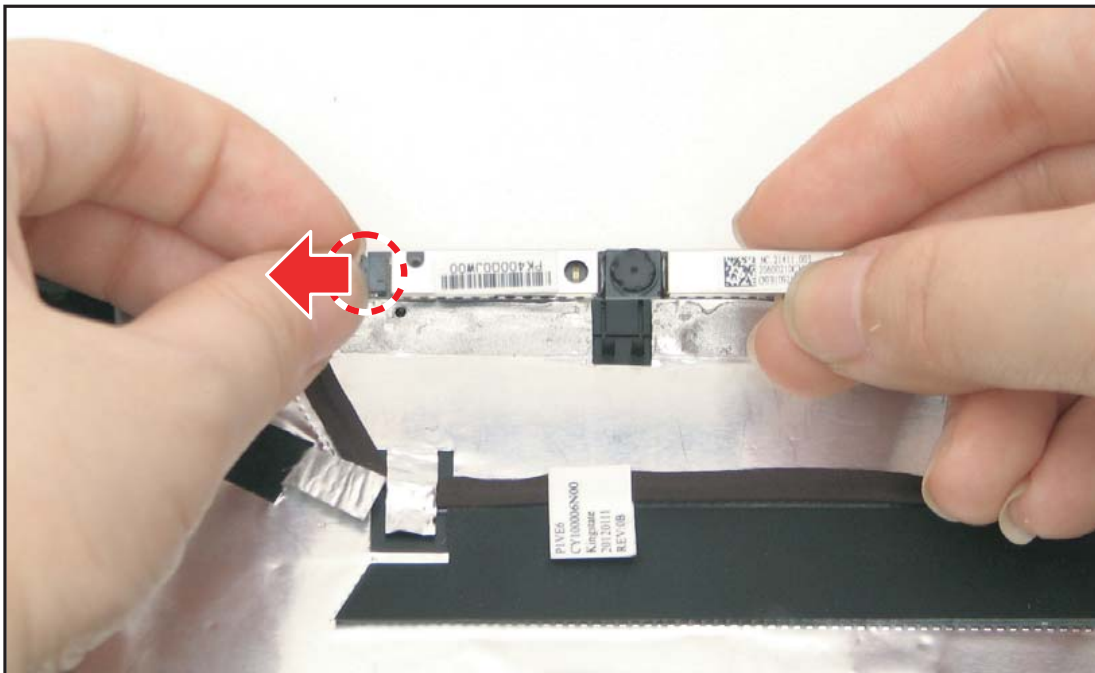

Figure 5:115. Disconnecting the Camera Cable

LCD Panel Installation

1. Connect the camera cable to the camera module connector.

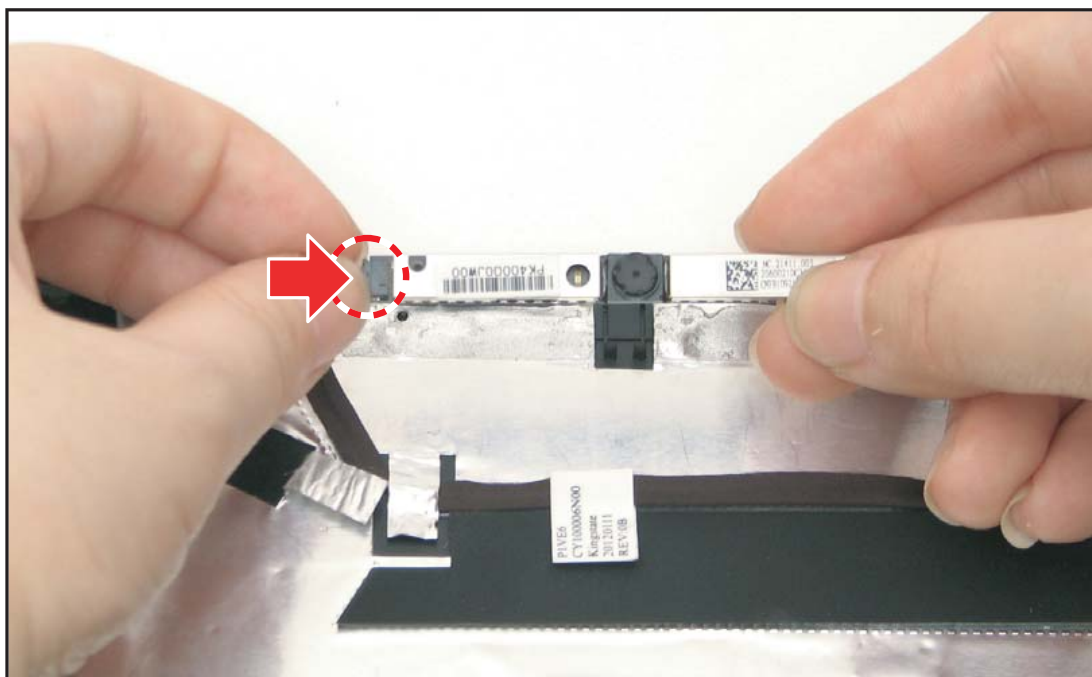

Figure 5:116. Connecting the Camera Cable

2. Install the camera module to the LCD cover.

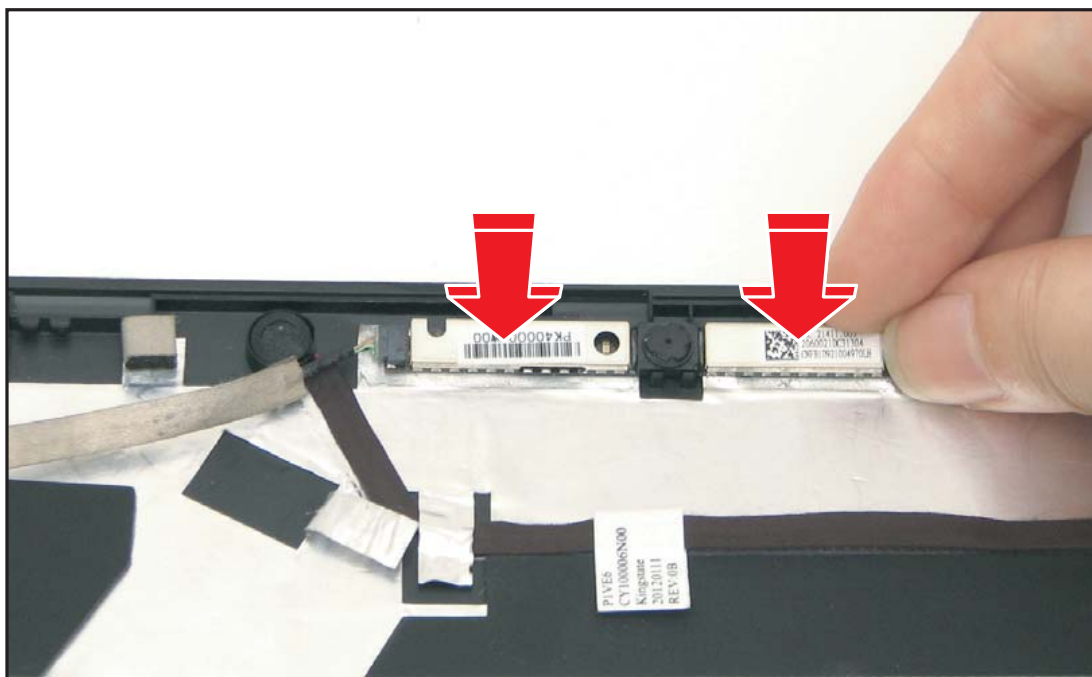

Figure 5:117. Installing the Camera Module

3. Attach the metallic tape to secure the camera cable to the LCD cover.

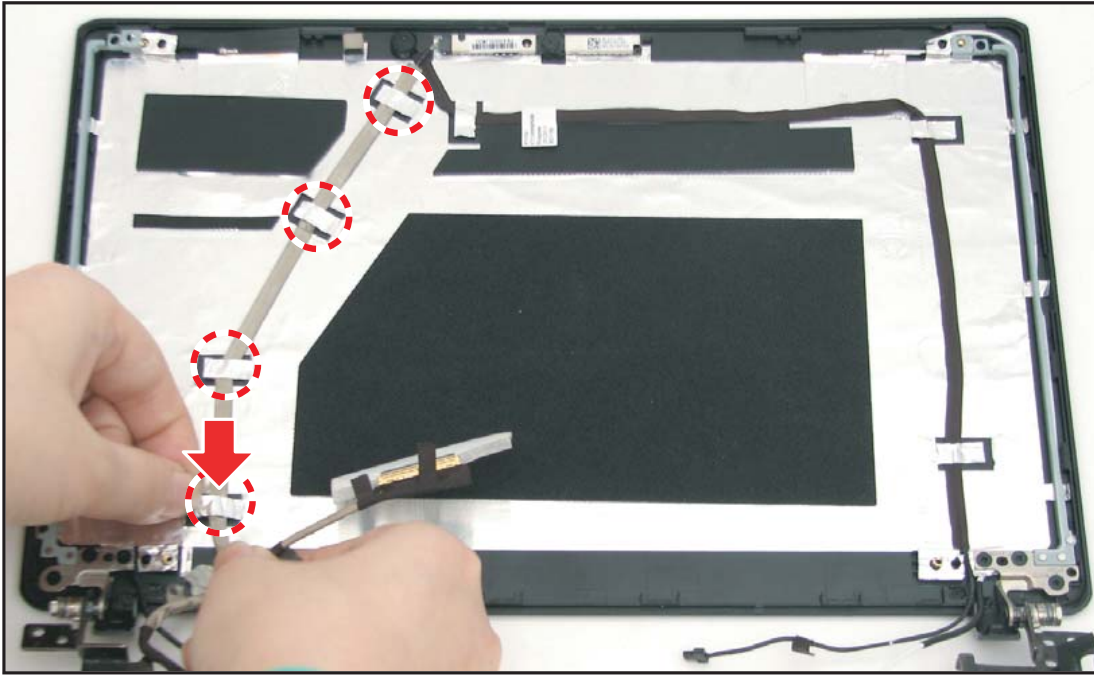

Figure 5:118. Securing the Camera Cable

4. Connect the LVDS cable connector the LCD panel connector.

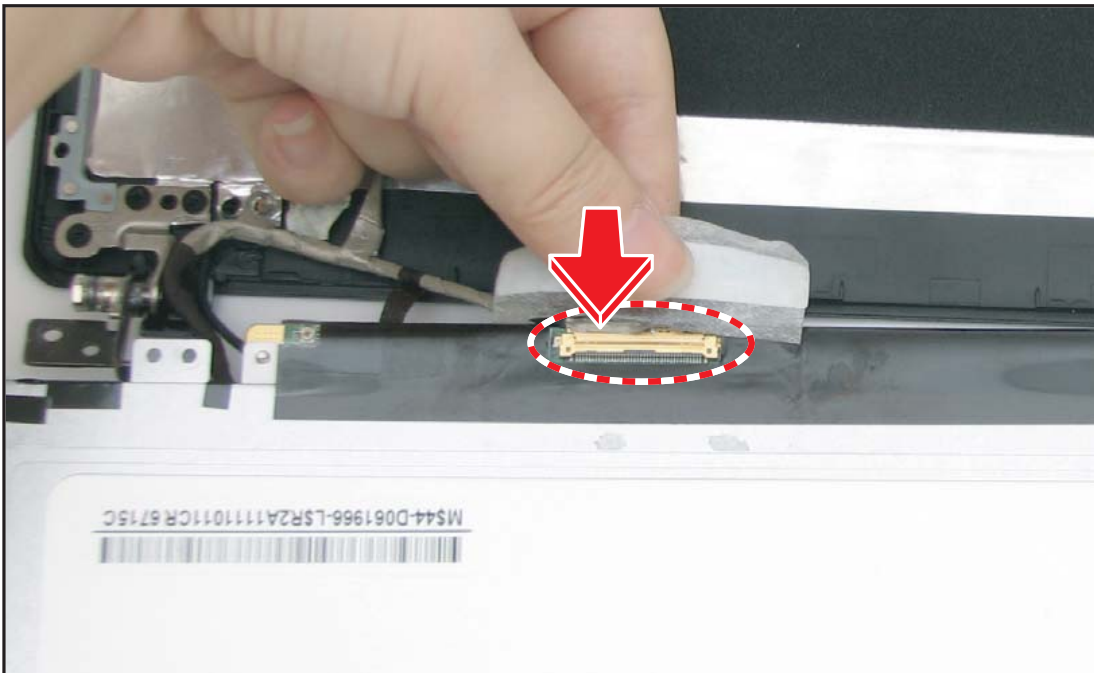

Figure 5:119. Connecting the LVDS Cable

5. Attach the transparent mylar to protect the LVDS cable connector.

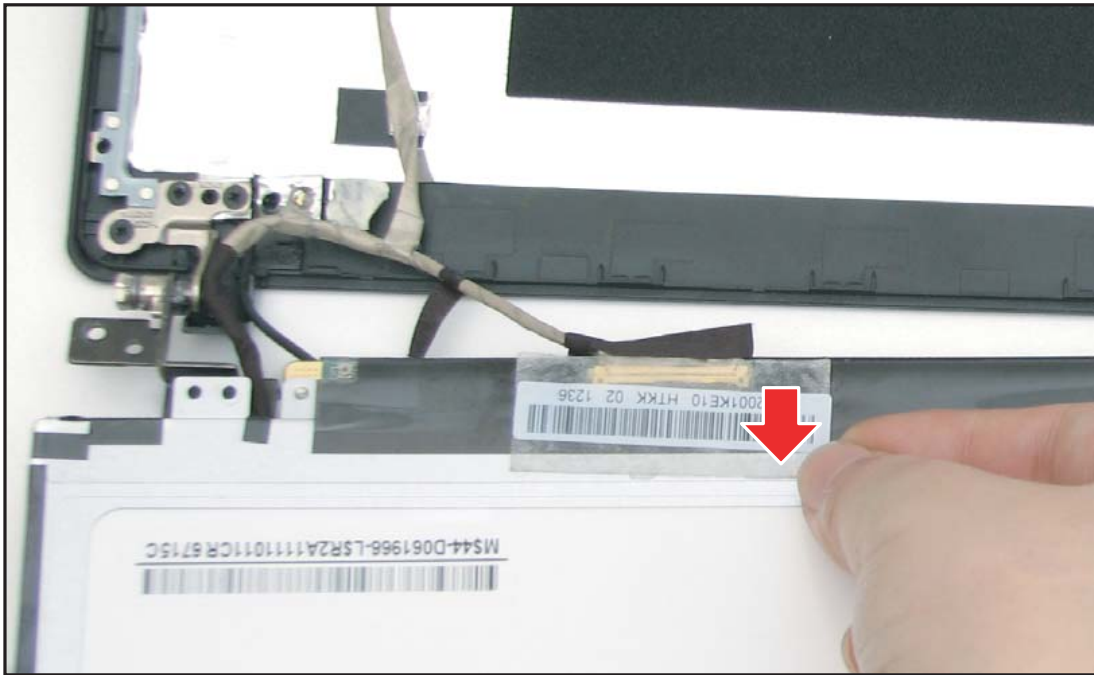

Figure 5:120. Attaching the Mylar

6. Align the LCD panel to the LCD bracket.



Figure 5:121. Installing the LCD Panel

- Attach the LVDS cable adhesives.



Figure 5:122. Attaching the LVDS Cable Adhesives

- Attach the four (4) screws to secure the LCD panel to the LCD cover.



Figure 5:123. Securing the LCD Panel Screws

- Install the LCD bezel (see [LCD Bezel Installation](#) on page 5-76).

Table 5:20. LCD Panel Screws

Screw Name	Screw Type	Quantity
M 2.0 x 3.0		4

CCD Module Removal

Prerequisite:

※ [LCD Bezel Removal](#) on page 5-74

1. Lift to remove the camera module.

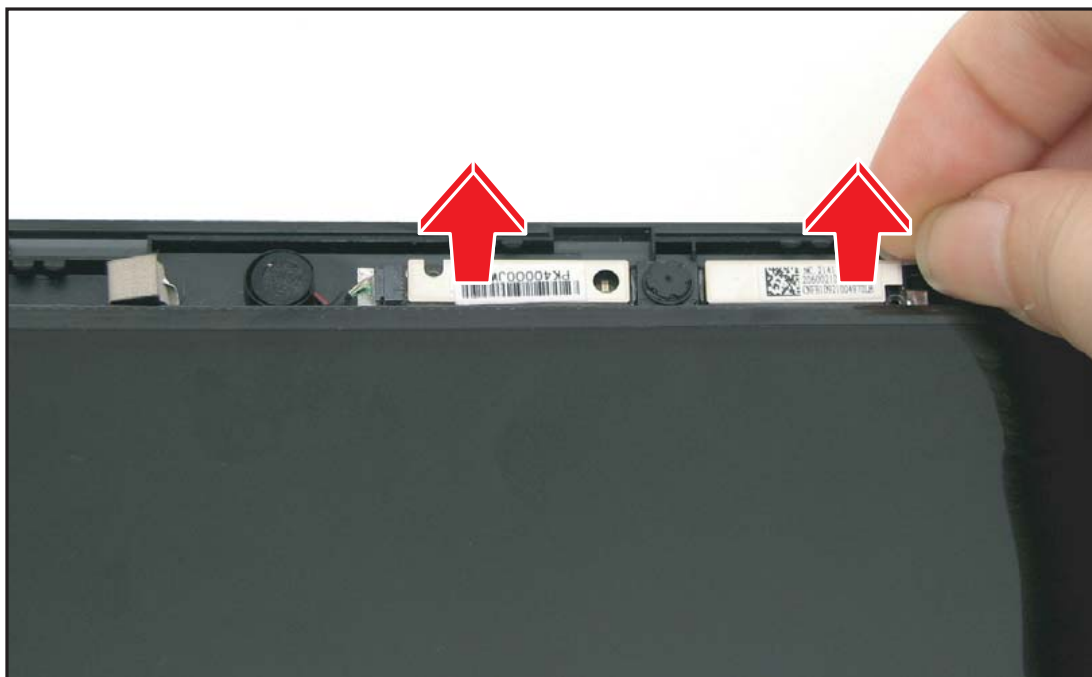

Figure 5:124. Removing the Camera Module (1 of 2)

2. Disconnect the camera cable connector.

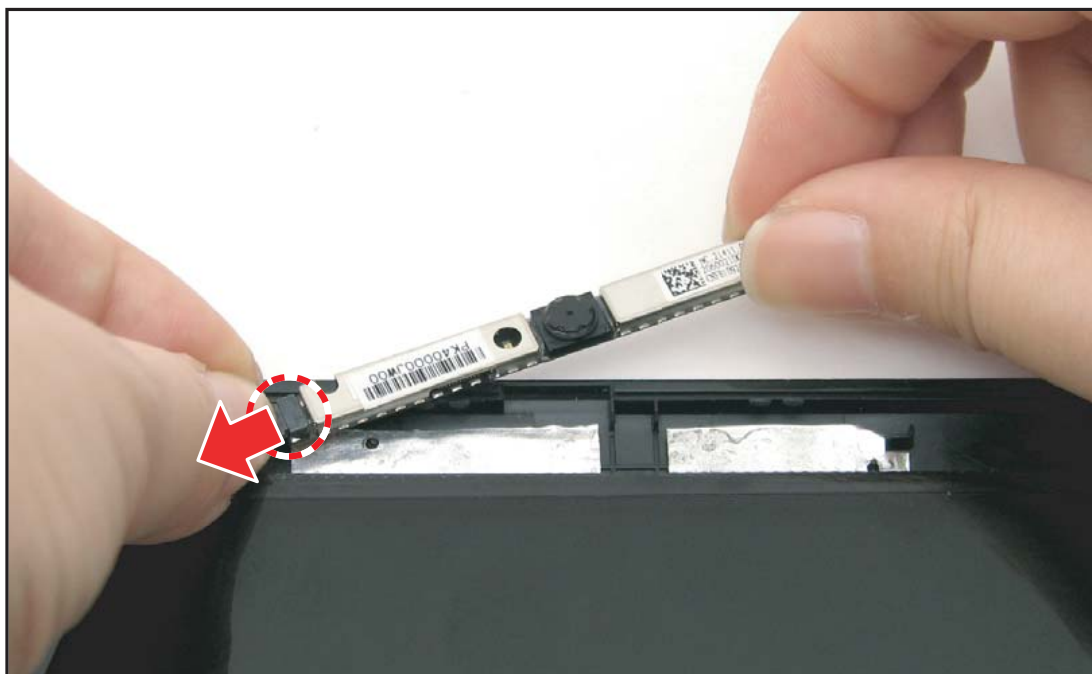

Figure 5:125. Removing the Camera Module (2 of 2)

CCD Module Installation

1. Connect the camera cable connector to the camera module.



Figure 5:126. Installing the Camera Module (1 of 2)

2. Install the camera module to the slot on the LCD cover.

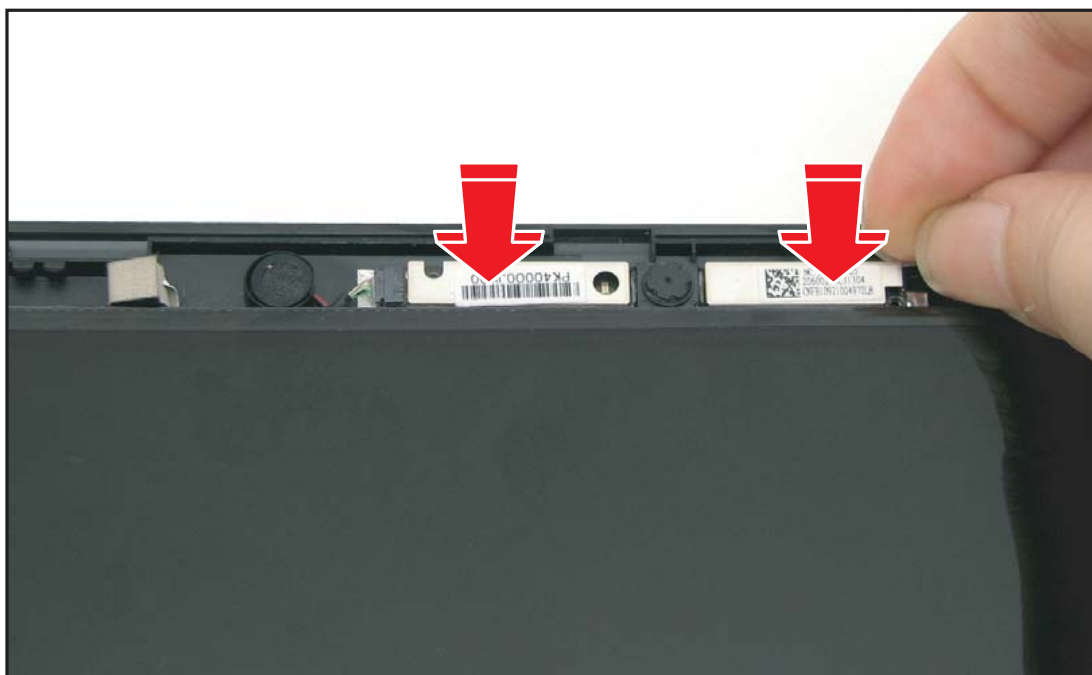

Figure 5:127. Installing the Camera Module (2 of 2)

3. Install the LCD bezel (see [LCD Bezel Installation](#) on page 5-76).

LCD Panel Brackets Removal

Prerequisite:

※ [LCD Panel Removal](#) on page 5-78

1. Remove the six (6) screws securing the LCD brackets to the LCD cover.

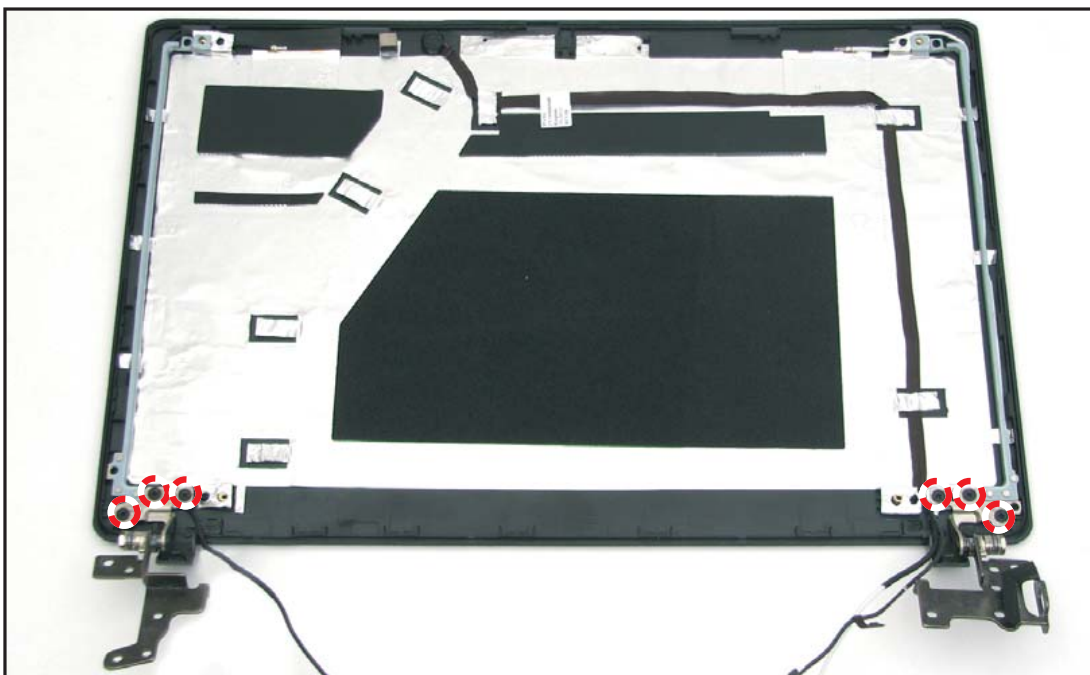

Figure 5:128. Removing the LCD Brackets (1 of 2)

2. Lift to remove the LCD brackets.

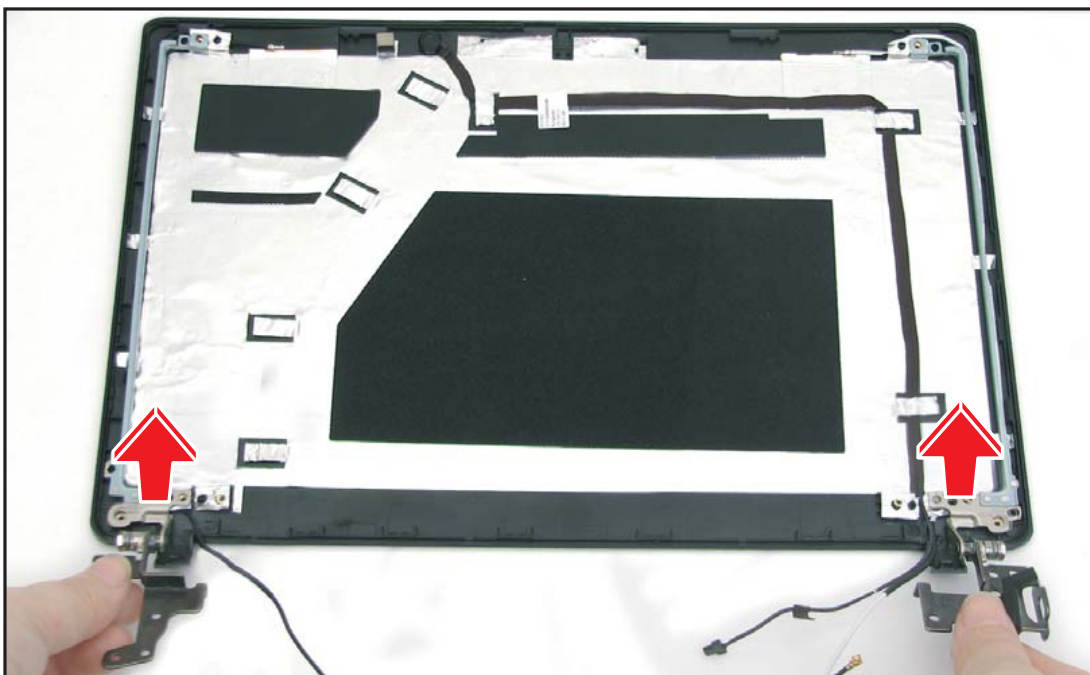

Figure 5:129. Removing the LCD Brackets (2 of 2)

LCD Panel Brackets Installation

1. Align the LCD brackets to the LCD cover.

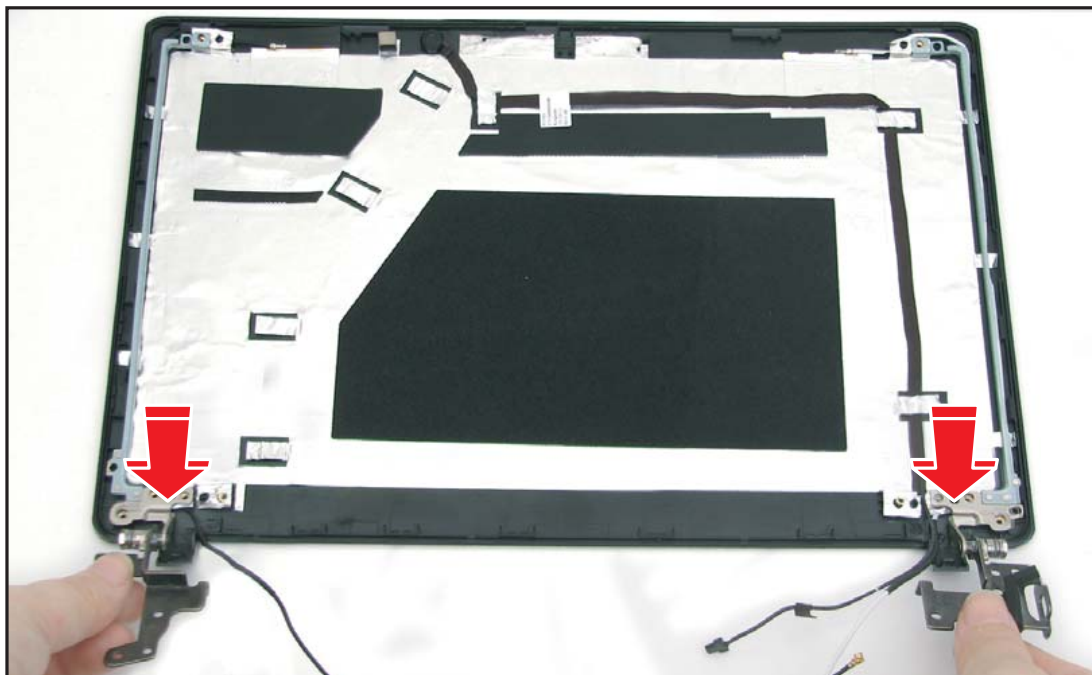

Figure 5:130. Installing the LCD Brackets (1 of 2)

2. Attach the six (6) screws to secure the LCD brackets to the LCD cover.

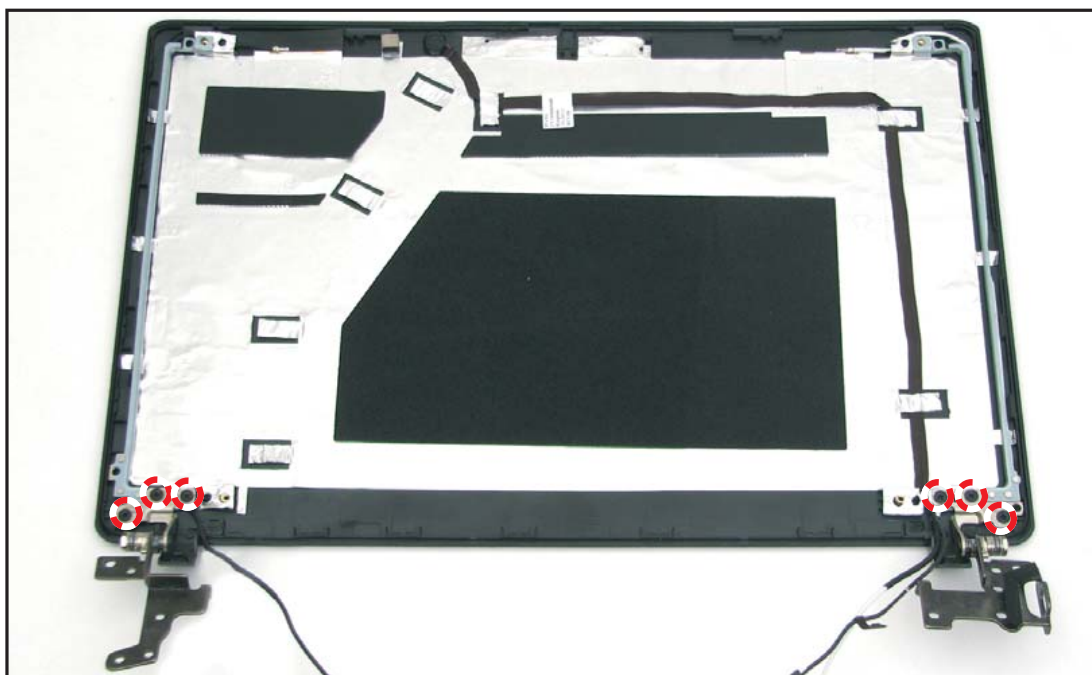

Figure 5:131. Installing the LCD Brackets (1 of 2)

3. Install the LCD panel (see [LCD Panel Installation](#) on page [5-82](#)).

Microphone Removal

Prerequisite:

※ [LCD Panel Removal](#) on page 5-78

1. Detach the metallic tapes securing the microphone cable.

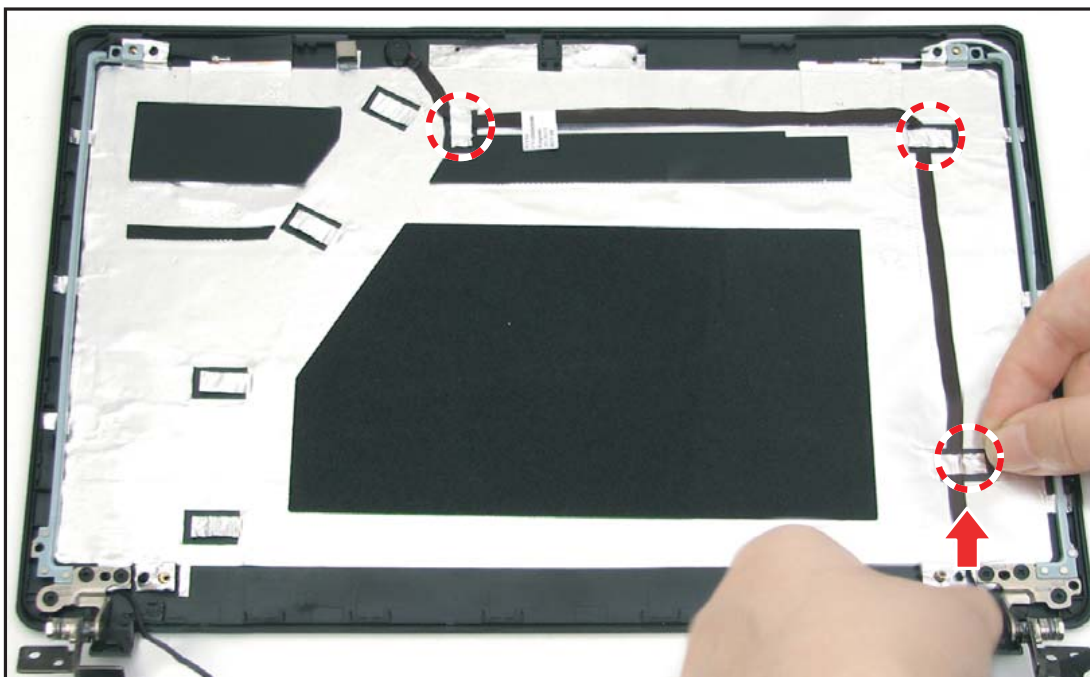

Figure 5:132. Removing the Microphone (1 of 2)

2. Lift to remove the microphone.

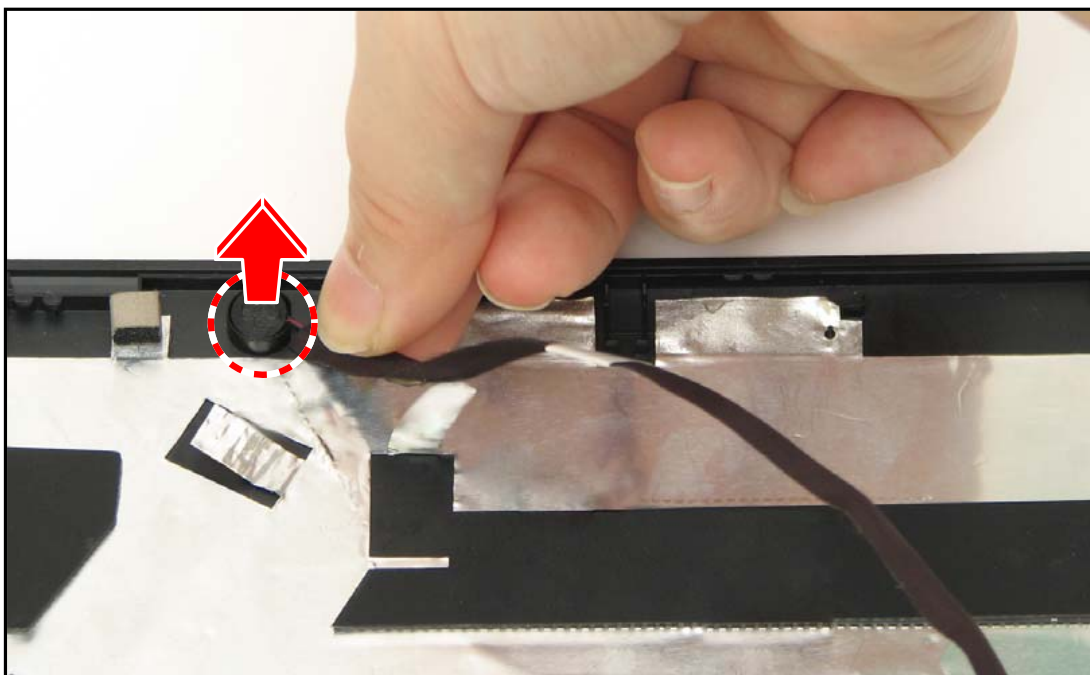

Figure 5:133. Removing the Microphone (2 of 2)

Microphone Installation

1. Place the microphone into its slot on the LCD cover.

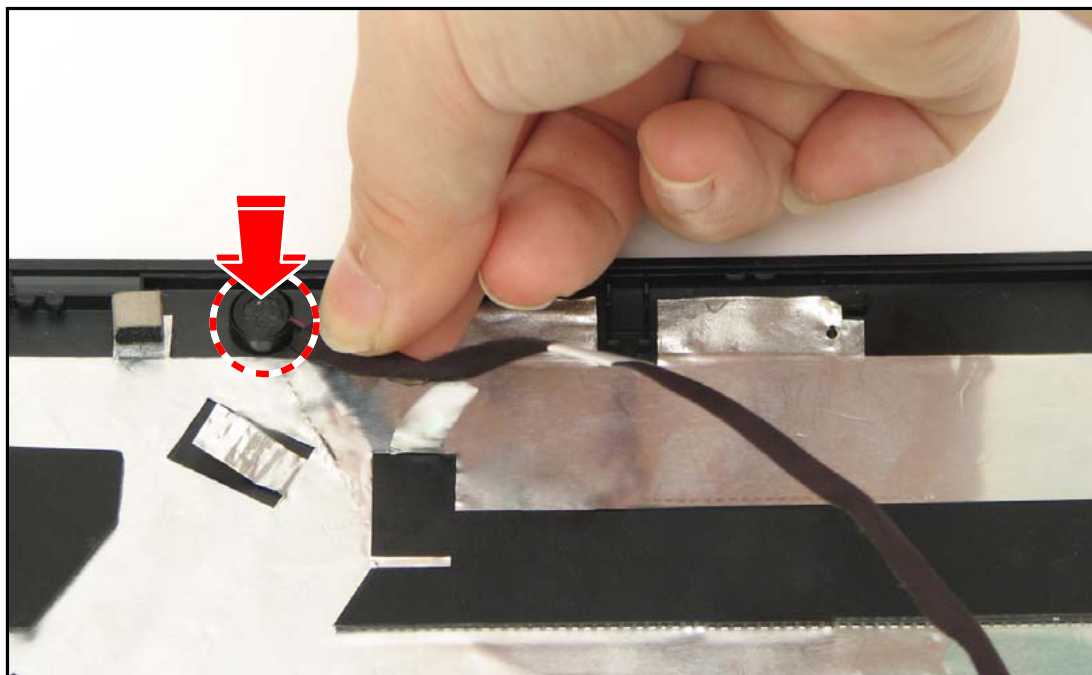

Figure 5:134. Installing the Microphone (1 of 2)

2. Attach the metallic tapes to secure the microphone cable.

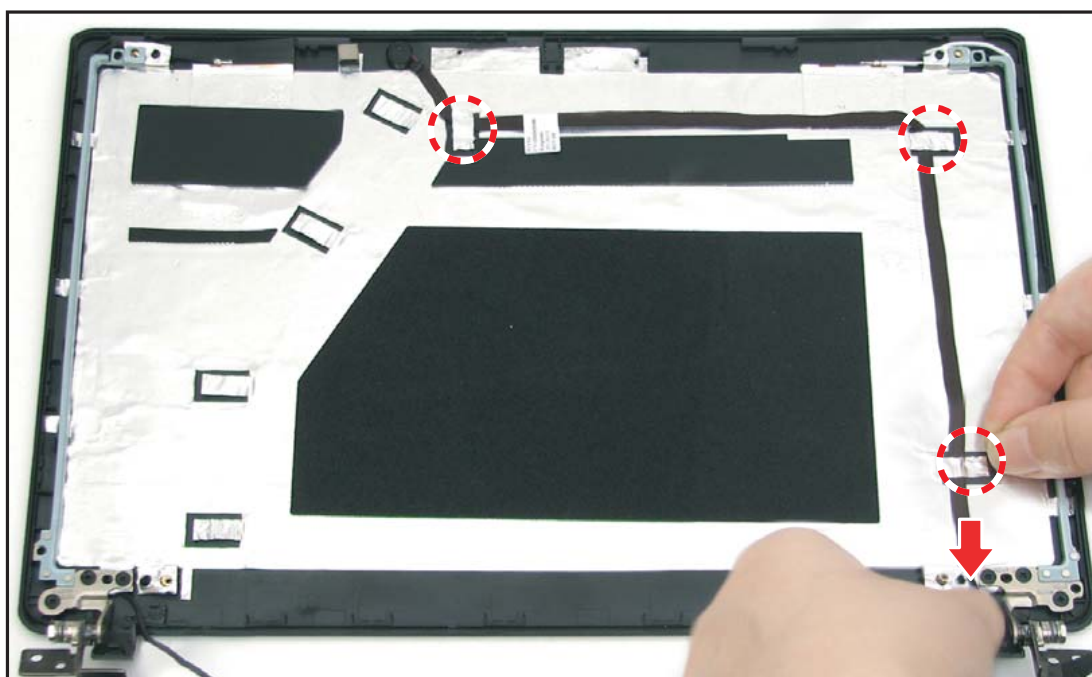

Figure 5:135. Installing the Microphone (2 of 2)

3. Install the LCD panel (see [LCD Panel Installation](#) on page [5-82](#)).

WLAN Antenna (Main) Removal

Prerequisite:

※ [LCD Panel Brackets Removal](#) on page 5-88

1. Remove the main antenna cable from the guides on the LCD cover.

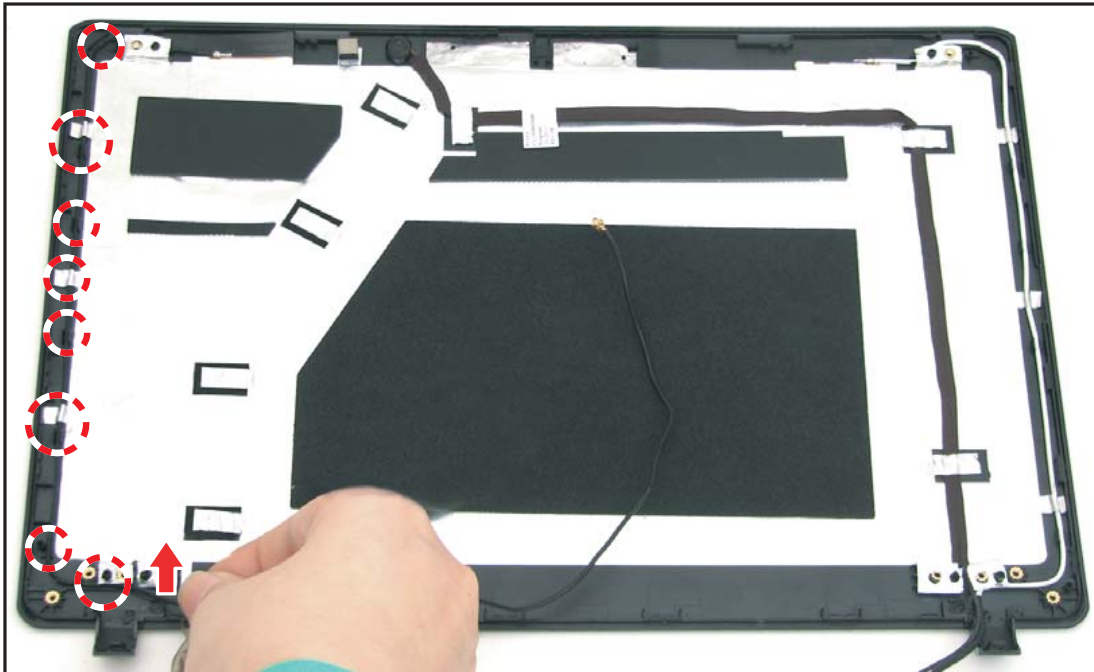

Figure 5:136. Removing the Main Antenna (1 of 3)

2. Remove the mylar.

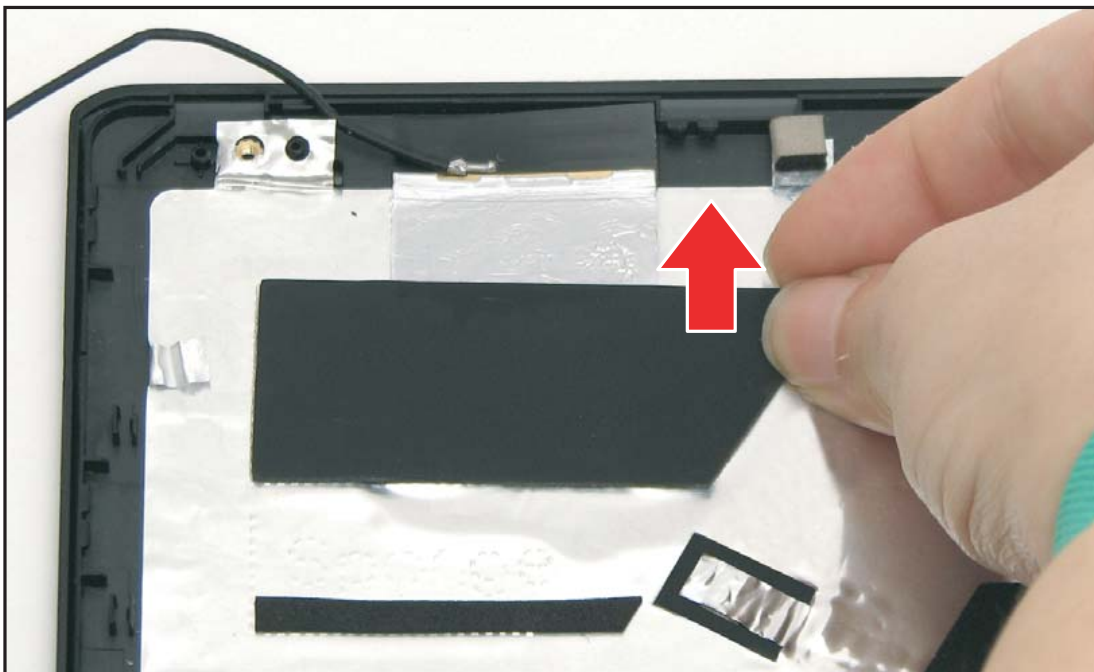

Figure 5:137. Removing the Main Antenna (2 of 3)

3. Remove the main antenna from the LCD cover.

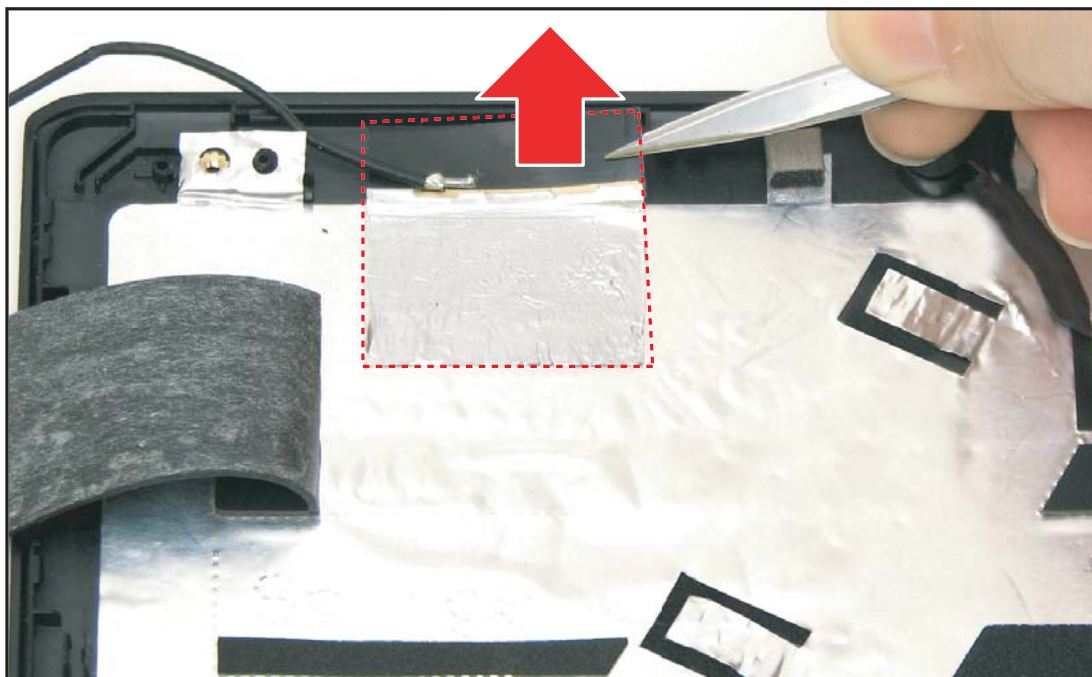

Figure 5:138. Removing the Main Antenna (3 of 3)

WLAN Antenna (Main) Installation

1. Align and place the main antenna on its slot on the LCD cover.

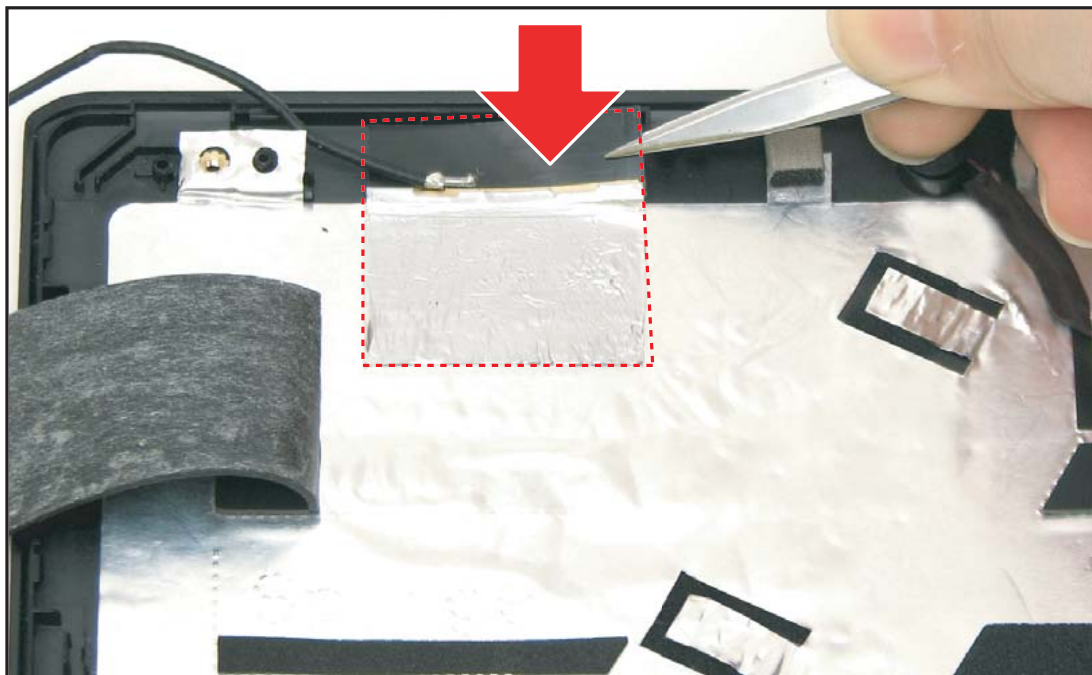

Figure 5:139. Installing the Main Antenna (1 of 3)

2. Install the mylar to protect the main antenna.

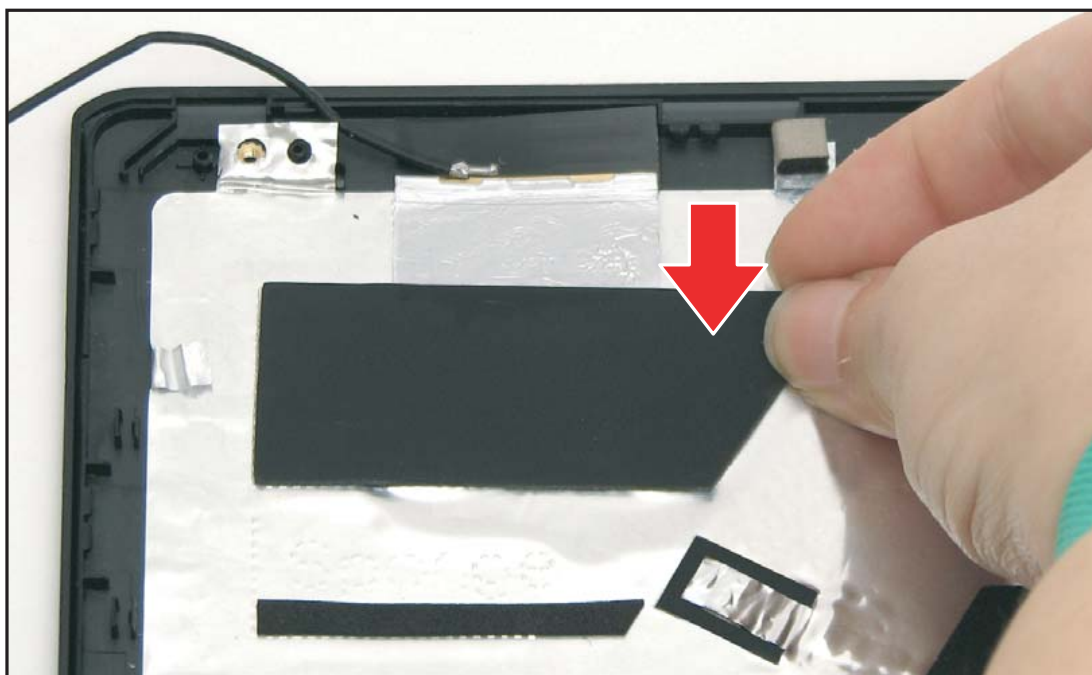

Figure 5:140. Installing the Main Antenna (2 of 3)

3. Route the main antenna cable through the guides on the LCD cover.

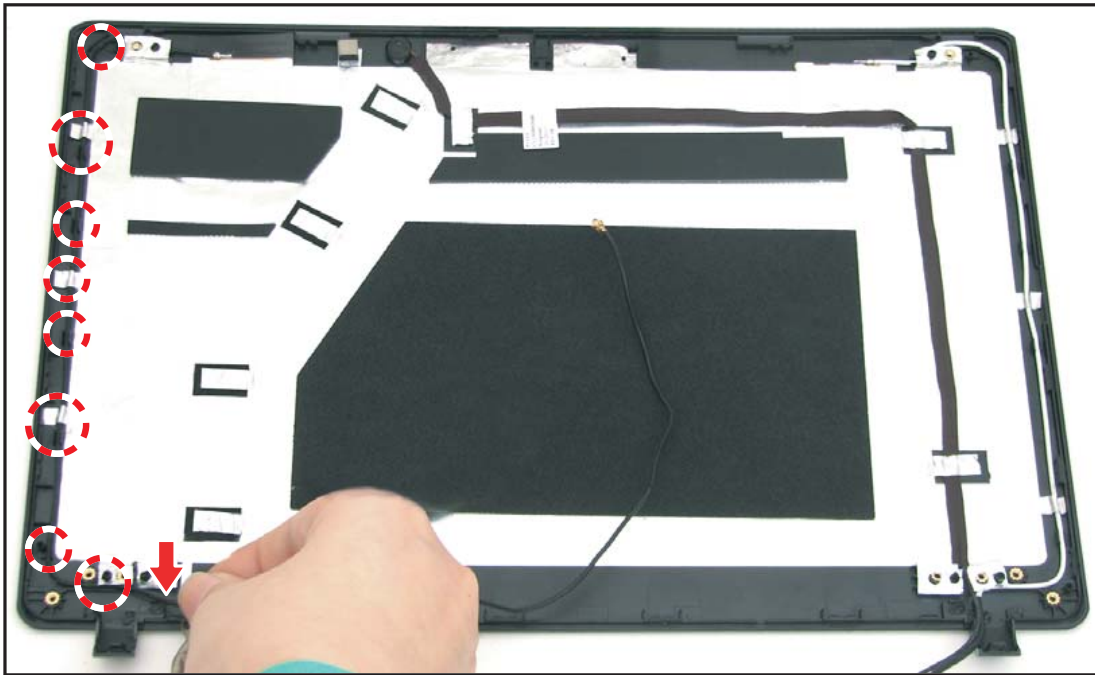

Figure 5:141. Installing the Main Antenna (3 of 3)

4. Install the LCD panel brackets (see [LCD Panel Brackets Installation](#) on page [5-89](#)).

WLAN Antenna (Auxiliary) Removal

Prerequisite:

※ [LCD Panel Brackets Removal](#) on page 5-88

1. Remove the auxiliary antenna cable from the guides on the LCD cover.

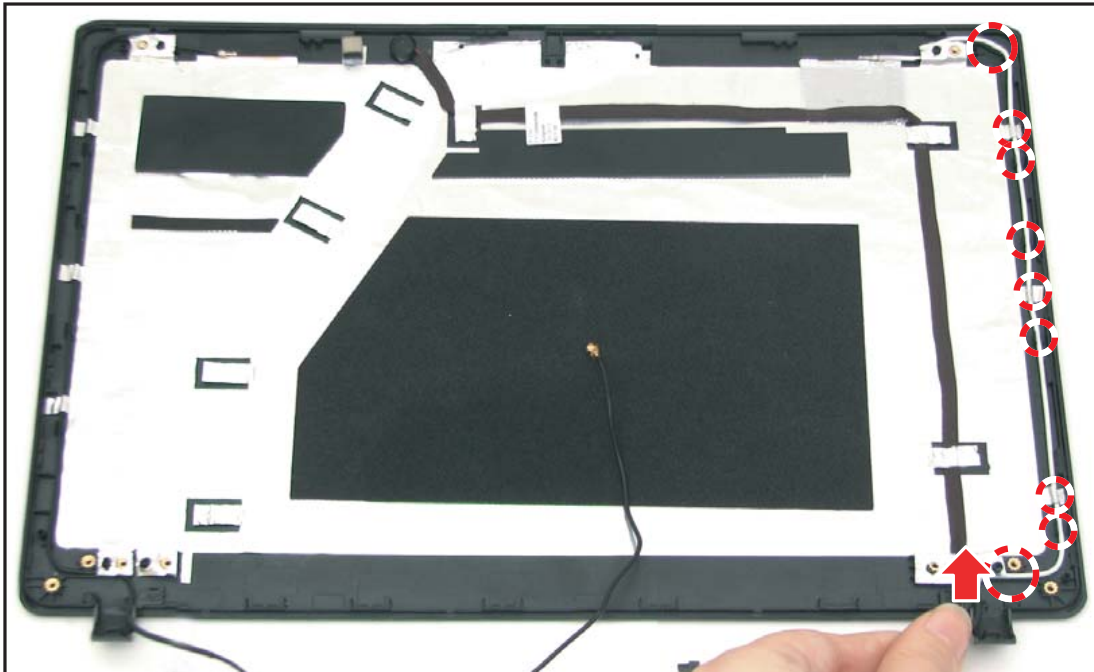

Figure 5:142. Removing the Auxiliary Antenna (1 of 2)

2. Remove the auxiliary antenna cable from its slot on the LCD cover.

TIP: Slightly move the microphone cable to detach its adhesives on the auxiliary antenna.

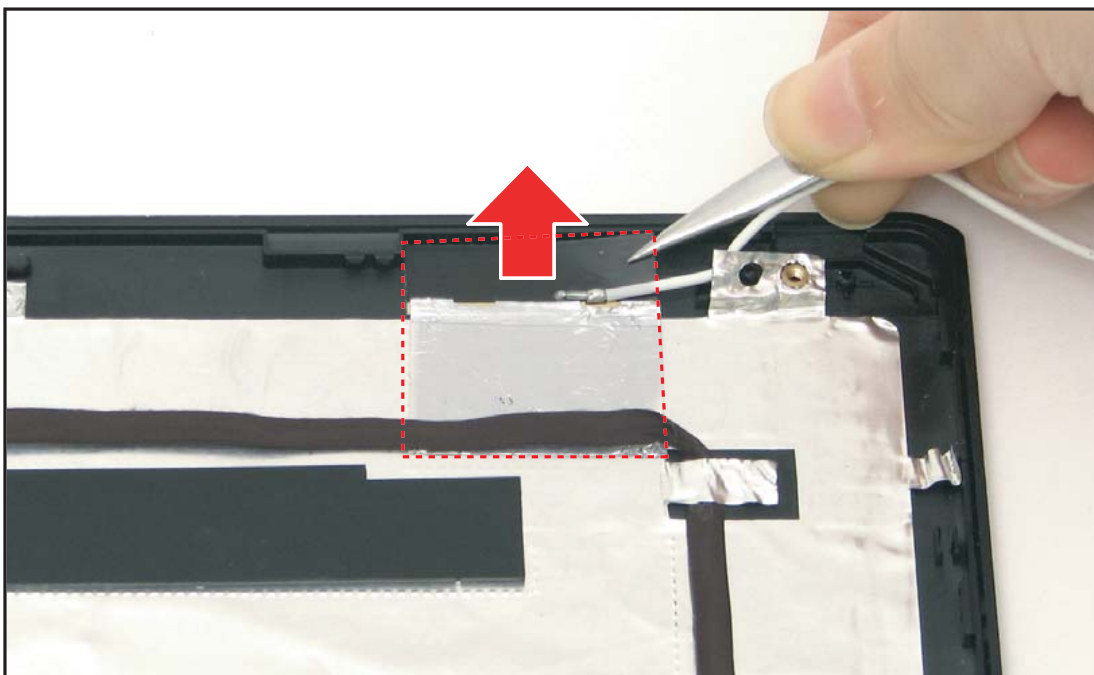

Figure 5:143. Removing the Auxiliary Antenna (1 of 2)

WLAN Antenna (Auxiliary) Installation

1. Align and place the auxiliary antenna on its slot on the LCD cover.

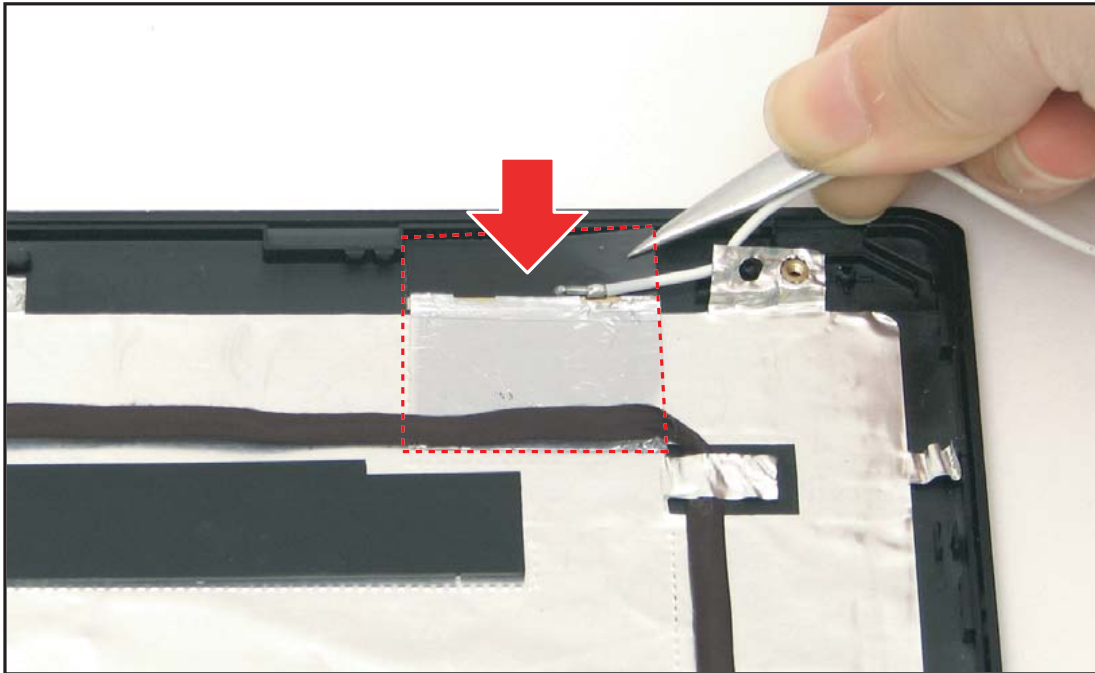

Figure 5:144. Installing the Auxiliary Antenna (1 of 2)

2. Route the auxiliary antenna cable through the guides on the LCD cover.

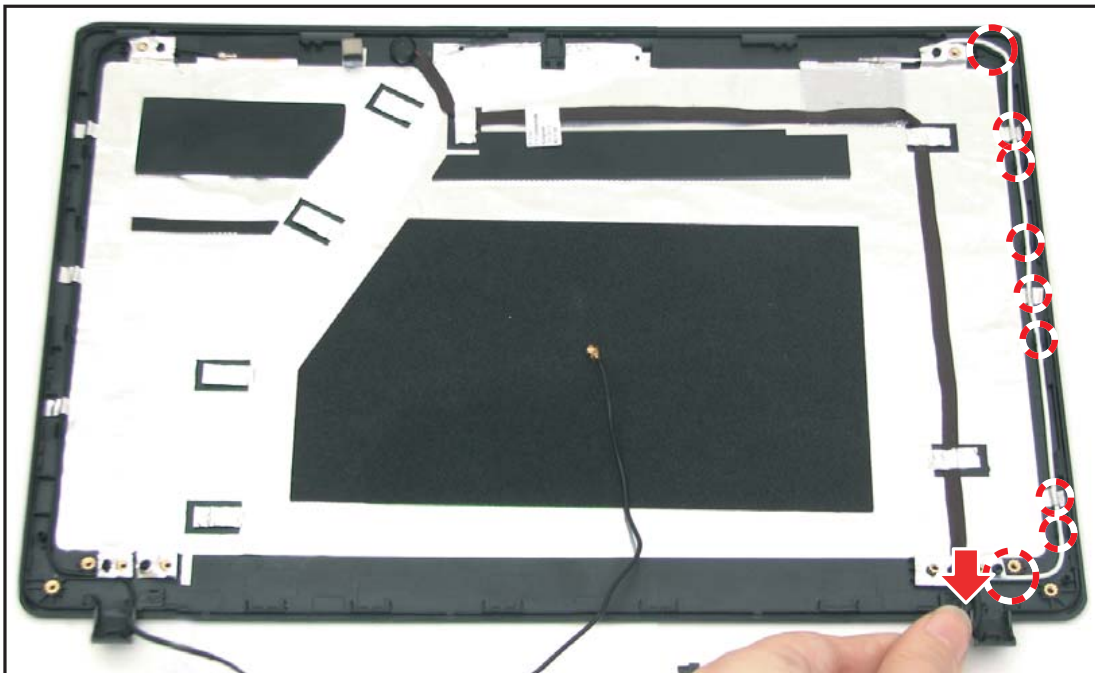

Figure 5:145. Installing the Auxiliary Antenna (2 of 2)

3. Install the LCD panel brackets (see [LCD Panel Brackets Installation](#) on page 5-89).

Field Replaceable Unit List

FRU (Field Replaceable Unit) List	6-2
Exploded Diagram	6-3
Main Assembly	6-3
Lower Case Assembly	6-5
Upper Case Assembly	6-6
LCD Assembly	6-8
HDD Assembly	6-10
FRU List	6-11
Screw List	6-16

FRU (Field Replaceable Unit) List

This chapter provides the FRU (Field Replaceable Unit) listing in global configurations for the TravelMate B113 Series. Refer to this chapter whenever ordering for parts to repair or for RMA (Return Merchandise Authorization).

⇒ NOTE:

When ordering FRU parts, check the most up-to-date information available on the regional web or channel. Part number changes will not be noted on the printed Service Guide. For Acer Authorized Service Providers, the Acer office may have a different part number code from those given in the FRU list of this printed Service Guide. Users **MUST** use the local FRU list provided by the regional Acer office to order FRU parts for repair and service of customer machines.

⇒ NOTE:

To scrap or to return the defective parts, users should follow local government ordinances or regulations on proper disposal, or follow the rules set by the regional Acer office on how to return the defective parts.

Exploded Diagram

Main Assembly

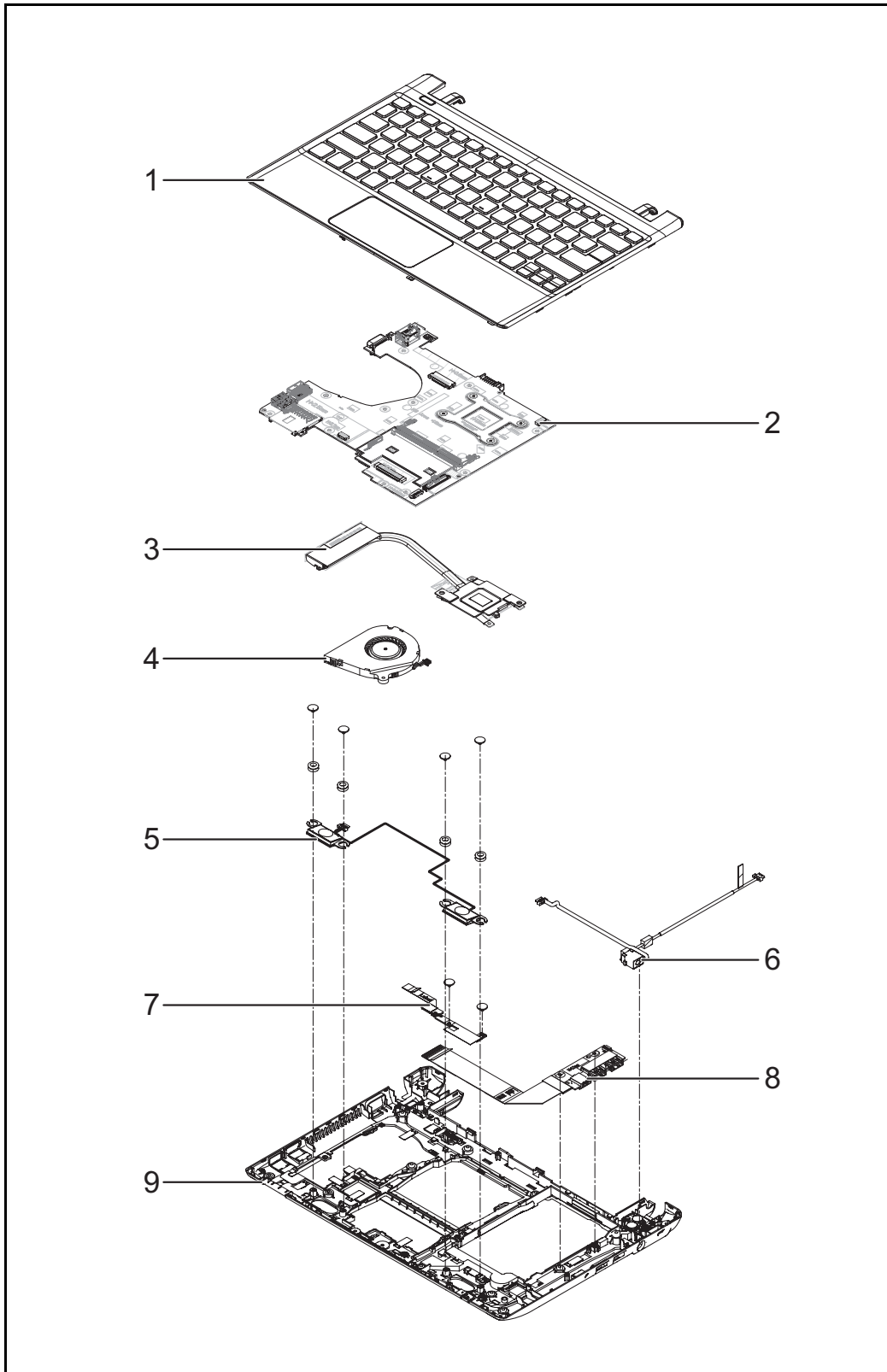

Figure 6:1. Main Assembly Exploded Diagram

Table 6:1. Main Assembly Exploded Diagram

No.	Description	P/N
1	UPPER CASE	60.SGYN2.001
2	MAINBOARD	NB.M3A11.004
3	THERMAL MODULE W/O FAN	60.SGYN2.007
4	FAN	23.SGYN2.001
5	SPEAKERS L+R	23.SGYN2.003
6	DC-IN CABLE	50.SGYN2.002
7	LED BOARD WITH FFC	55.SGYN2.003
8	IO BOARD WITH FFC	55.SGYN2.002
9	LOWER CASE	60.SGYN2.002

Lower Case Assembly

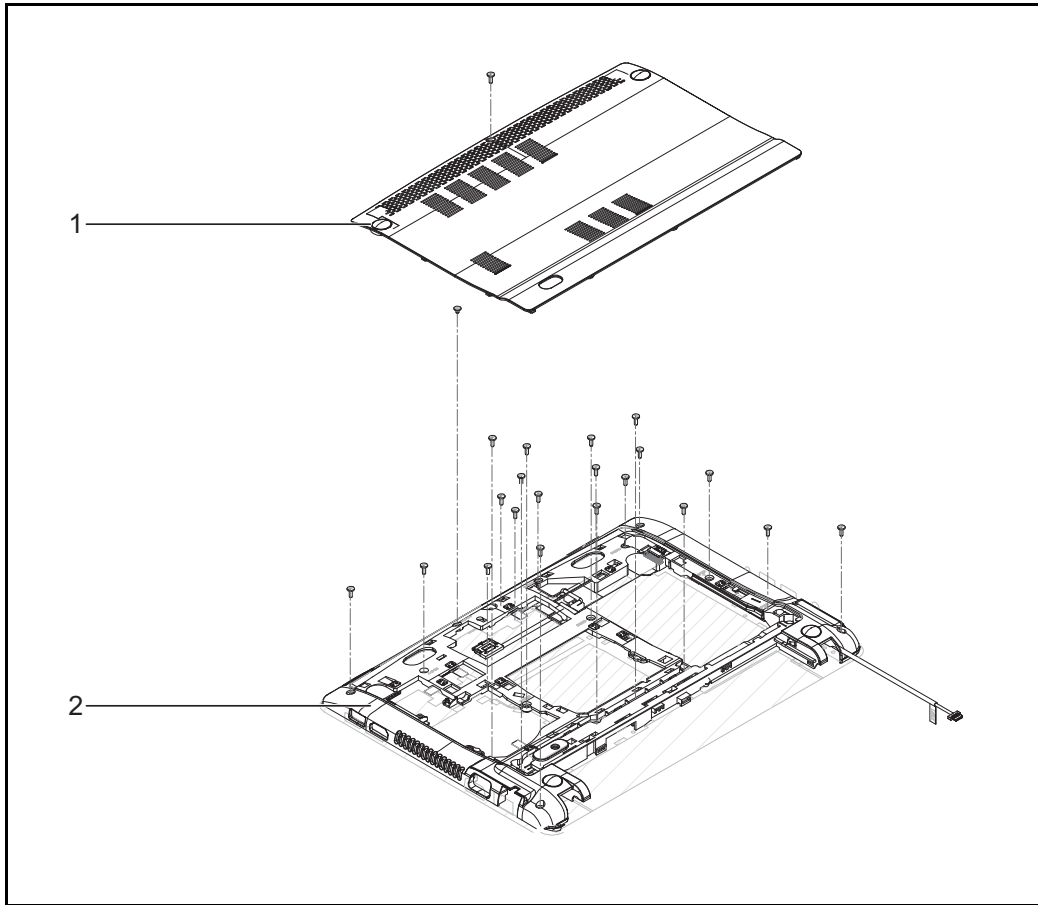

Figure 6:2. Lower Case Assembly Exploded Diagram

Table 6:2. Lower Case Assembly Exploded Diagram

No.	Description	P/N
1	UNILoad DOOR	60.SGYN2.004
2	LOWER CASE	60.SGYN2.002

Upper Case Assembly

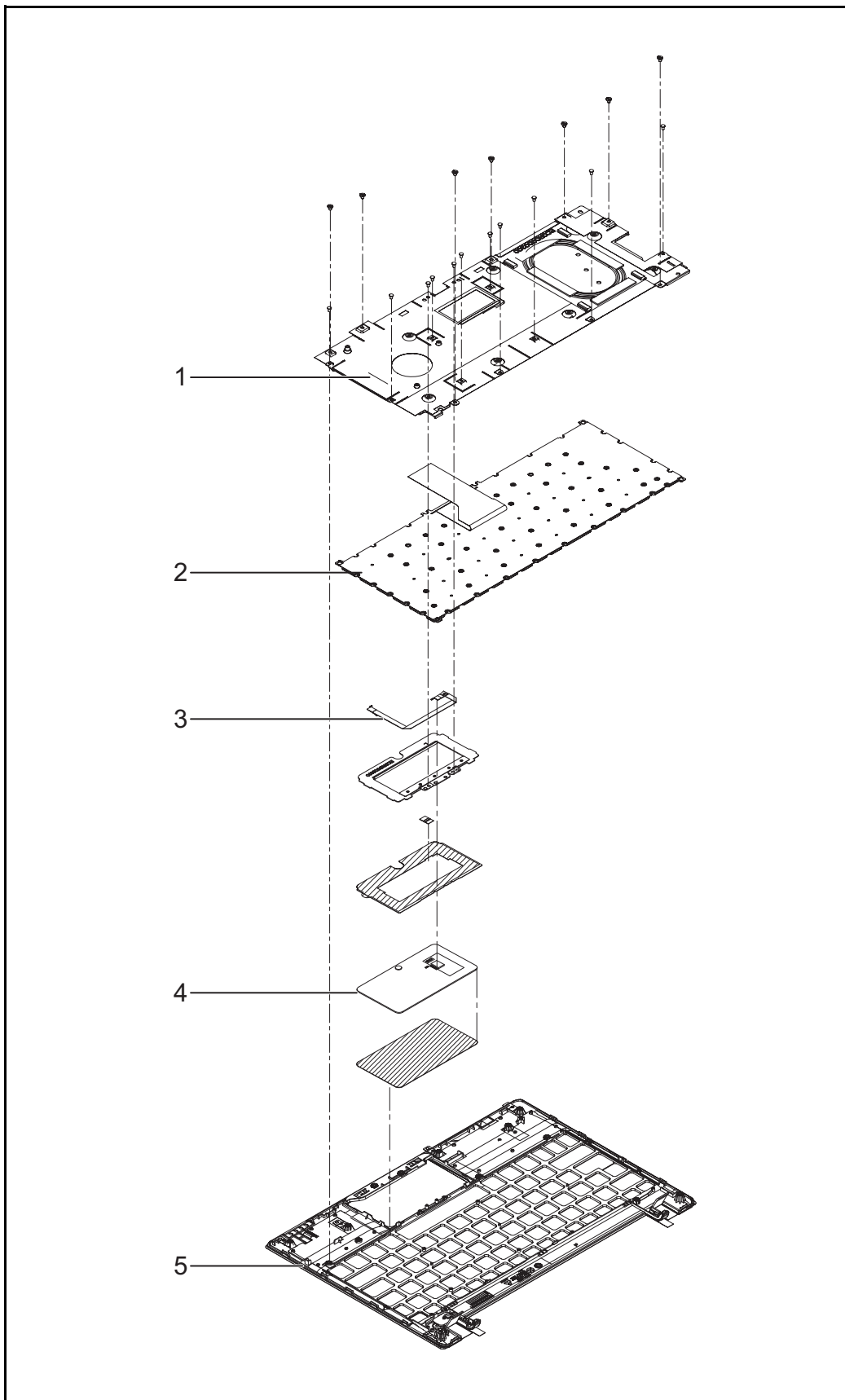

Figure 6:3. Upper Case Assembly Exploded Diagram

Table 6:3. Upper Case Assembly Exploded Diagram

No.	Description	P/N
1	KEYBOARD SUPPORT PLATE	33.SGYN2.001
2	KEYBOARD	KB.I100A.207
3	TOUCHPAD FFC	50.SGYN2.001
4	TOUCHPAD ASSEMBLY	60.SGYN2.003
5	UPPER CASE	60.SGYN2.001

LCD Assembly

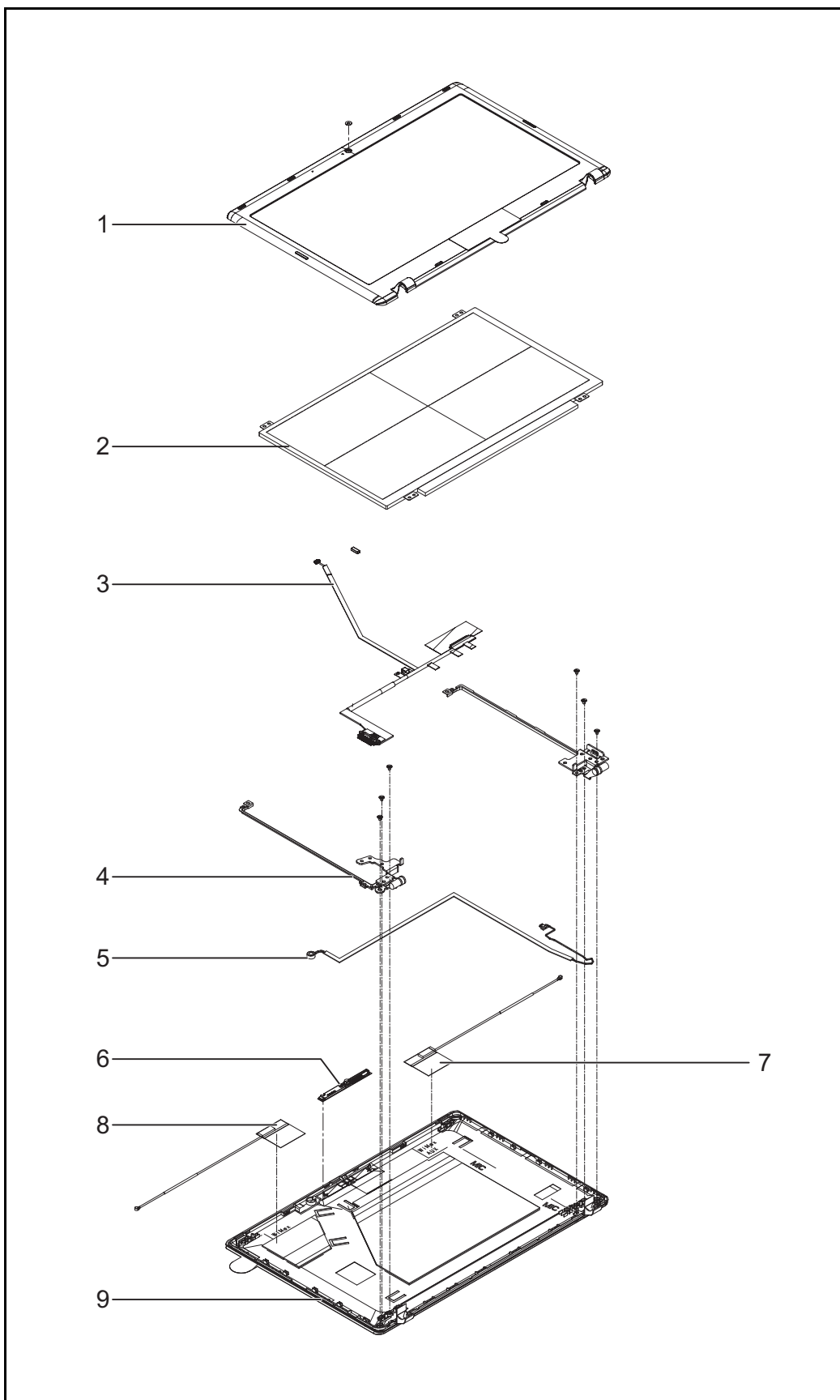

Figure 6:4. LCD Assembly Exploded Diagram

Table 6:4. LCD Assembly Exploded Diagram

No.	Description	P/N
1	LCD BEZEL	TBD
2	LCD PANEL	TBD
3	LVDS CABLE	50.SGYN2.005
4	LCD BRACKET R+L	33.SGYN2.003
5	MIC SET	23.SGYN2.002
6	CAMERA 1M	57.SGYN2.001
7	WLAN ANTENNA AUX	50.SGYN2.004
8	WLAN ANTENNA MAIN	50.SGYN2.003
9	LCD COVER	TBD

HDD Assembly

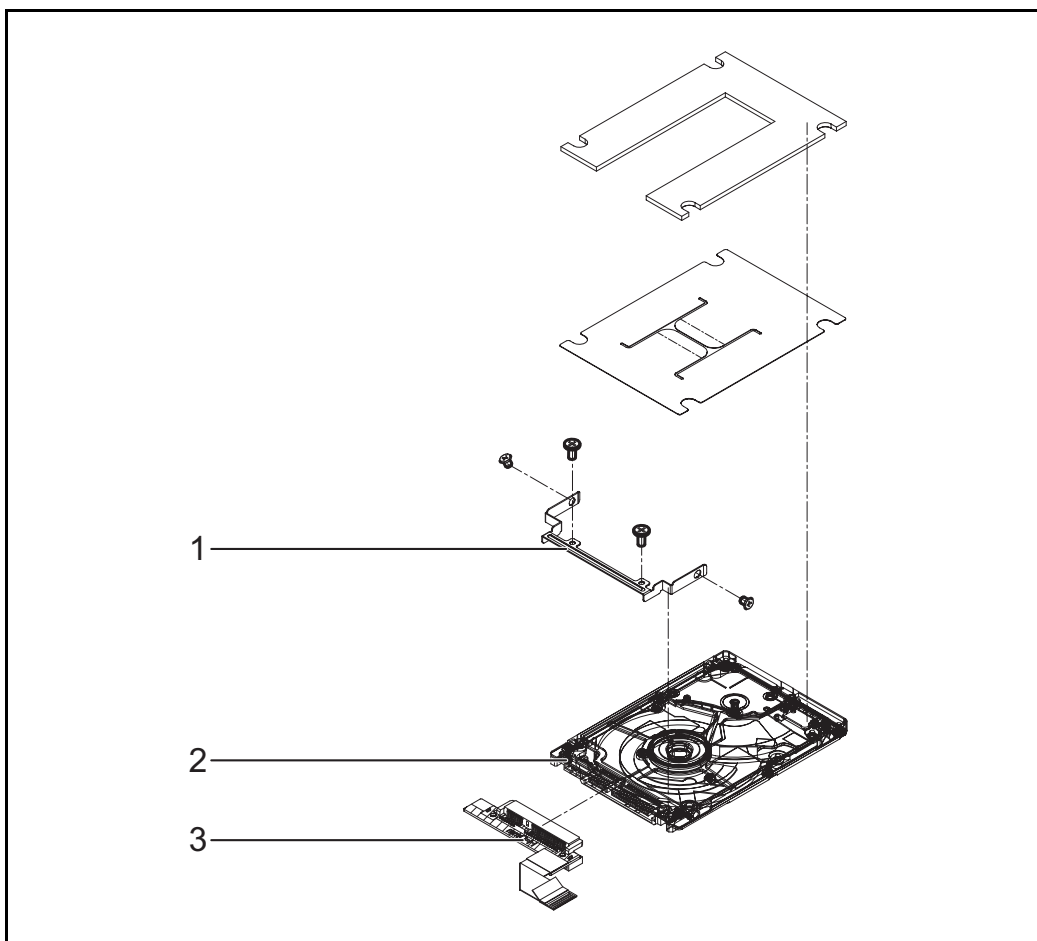

Figure 6:5. HDD Assembly Exploded Diagram





Table 6:5. HDD Assembly Exploded Diagram

No.	Description	P/N
1	HDD BRACKET	33.SGYN2.002
2	HDD	TBD
3	HDD BOARD	55.SGYN2.001



FRU List



CATEGORY	DESCRIPTION	PART NO.
BOARD		
A small green printed circuit board (PCB) with gold-plated contacts at the bottom. It features a barcode and technical specifications printed on it.	Foxconn 3rd WiFi 2x2 AGN+ BT4.0 Broadcom 43228+20702 (WiFi 43228 2x2 DB AGN+BT4.0 20702)	NI.23600.100
	Foxconn 3rd WiFi 2x2 AGN+ BT4.0 Atheros WB222	NI.23600.102
	Liteon 3rd WiFi 2x2 AGN+ BT4.0 Atheros WB222	NI.23600.103
	Liteon 3rd WiFi 2x2 AGN+ BT4.0 Broadcom 43228+20702 (WiFi 43228 2x2 DB AGN+BT4.0 20702)	NC.23611.003
	Foxconn Wireless LAN Atheros HB125 1x1 BGN	NI.23600.085
	Liteon Wireless LAN Atheros HB125 1x1 BGN	NI.23600.086
	Foxconn Wireless LAN Broadcom 4313 IPA 1x1 BGN	NI.23600.090
A small blue PCB with a white SATA-to-USB adapter cable attached to one end.	HDD BOARD	55.SGYN2.001
A small blue PCB with a long, white flexible flat cable (FFC) attached to one end.	IO BOARD W/ FFC	55.SGYN2.002
A small blue PCB with a long, white flexible flat cable (FFC) attached to one end.	LED BOARD W/ FFC	55.SGYN2.003
CABLE		
A long, thin, white flexible flat cable (FFC) with connectors at both ends.	TP FFC	50.SGYN2.001
A black power cable with a DC connector on one end and a standard power plug on the other.	DC-IN CABLE 40W	50.SGYN2.002
	AC CLIP US	27.WH202.001
	AC CLIP EU	27.WH202.002

CATEGORY	DESCRIPTION	PART NO.
	AC CLIP AUSTRALIA	27.WH202.003
	AC CLIP UK	27.WH202.004
	AC CLIP ARGENTINA	27.WH202.005
	AC CLIP CHINA	27.WH202.006
	AC CLIP BRAZIL	27.WH202.007
	AC CLIP S-AFRICA	27.WH202.008
	AC CLIP KOREA	27.WH202.009
	AC CLIP AF	27.WH202.010
	ANTENNA MAIN	50.SGYN2.003
	ANTENNA AUX	50.SGYN2.004
	LVDS CABLE	50.SGYN2.005
CASE/COVER/BRACKET ASSEMBLY		
	UPPER CASE-BLACK	60.SGYN2.001
	UPPER CASE-SILVER	60.SGTN2.001
	UPPER CASE-RED	60.SGZN2.001
	UPPER CASE-BLUE	60.SH0N2.001
	UPPER CASE-SILVER FOR V5-171	60.M3AN2.001
	UPPER CASE-BLACK FOR TRAVELMATE	60.V7PN2.001
	LOWER CASE	60.SGYN2.002







CATEGORY	DESCRIPTION	PART NO.
	TOUCHPAD ASSY-BLACK	60.SGYN2.003
	TOUCHPAD ASSY-SILVER	60.SGTN2.002
	TOUCHPAD ASSY-RED	60.SGZN2.002
	TOUCHPAD ASSY-BLUE	60.SH0N2.002
	TOUCHPAD ASSY-SILVER FOR V5-171	60.M3AN2.002
	UNILOAD DOOR	60.SGYN2.004
	KB SUPPORT PLATE	33.SGYN2.001
	HDD BRACKET	33.SGYN2.002
	LCD BRACKET R&L	33.SGYN2.003
	TBD	TBD
	TBD	TBD
	TBD	TBD
KEYBOARD		
	Keyboard ACER AF1S_A10B AF1S Internal 10 Standard 84KS Black US International Texture	KB.I100A.207
	Keyboard ACER AF1S_A10B AF1S Internal 10 Standard 84KS Black Greek Texture	KB.I100A.191
	Keyboard ACER AF1S_A10B AF1S Internal 10 Standard 84KS Black Arabic Texture	KB.I100A.181
	Keyboard ACER AF1S_A10B AF1S Internal 10 Standard 84KS Black Chinese Texture	KB.I100A.186
	Keyboard ACER AF1S_A10B AF1S Internal 10 Standard 84KS Black Russian Texture	KB.I100A.199
	Keyboard ACER AF1S_A10B AF1S Internal 10 Standard 84KS Black US International w/ Hebrew Texture	KB.I100A.208

CATEGORY	DESCRIPTION	PART NO.
	Keyboard ACER AF1S_A10B AF1S Internal 10 Standard 84KS Black Thailand Texture	KB.I100A.204
	Keyboard ACER AF1S_A10B AF1S Internal 10 Standard 84KS Black Korean Texture	KB.I100A.195
	Keyboard ACER AF1S_A10B AF1S Internal 10 Standard 85KS Black UK Texture	KB.I100A.206
	Keyboard ACER AF1S_A10B AF1S Internal 10 Standard 85KS Black German Texture	KB.I100A.190
	Keyboard ACER AF1S_A10B AF1S Internal 10 Standard 85KS Black Swiss/G Texture	KB.I100A.203
	Keyboard ACER AF1S_A10B AF1S Internal 10 Standard 85KS Black Belgium Texture	KB.I100A.182
	Keyboard ACER AF1S_A10B AF1S Internal 10 Standard 85KS Black Danish Texture	KB.I100A.187
	Keyboard ACER AF1S_A10B AF1S Internal 10 Standard 85KS Black Italian Texture	KB.I100A.193
	Keyboard ACER AF1S_A10B AF1S Internal 10 Standard 85KS Black French Texture	KB.I100A.189
	Keyboard ACER AF1S_A10B AF1S Internal 10 Standard 85KS Black Hungarian Texture	KB.I100A.192
	Keyboard ACER AF1S_A10B AF1S Internal 10 Standard 85KS Black Norwegian Texture	KB.I100A.197
	Keyboard ACER AF1S_A10B AF1S Internal 10 Standard 85KS Black Portuguese Texture	KB.I100A.198
	Keyboard ACER AF1S_A10B AF1S Internal 10 Standard 85KS Black Spanish Texture	KB.I100A.201
	Keyboard ACER AF1S_A10B AF1S Internal 10 Standard 85KS Black US w/ Canadian French Texture	KB.I100A.209
	Keyboard ACER AF1S_A10B AF1S Internal 10 Standard 85KS Black Turkish Texture	KB.I100A.205
	Keyboard ACER AF1S_A10B AF1S Internal 10 Standard 85KS Black Sweden Texture	KB.I100A.202
	Keyboard ACER AF1S_A10B AF1S Internal 10 Standard 85KS Black FR/Arabic Texture	KB.I100A.188
	Keyboard ACER AF1S_A10B AF1S Internal 10 Standard 85KS Black Nordic Texture	KB.I100A.196
	Keyboard ACER AF1S_A10B AF1S Internal 10 Standard 85KS Black SLO/CRO Texture	KB.I100A.200

CATEGORY	DESCRIPTION	PART NO.
	Keyboard ACER AF1S_A10B AF1S Internal 10 Standard 85KS Black CZ/SK Texture	KB.I100A.185
	Keyboard ACER AF1S_A10B AF1S Internal 10 Standard 85KS Black Bulgaria Texture	KB.I100A.184
	Keyboard ACER AF1S_A10B AF1S Internal 10 Standard 85KS Black Brazilian Portuguese Texture	KB.I100A.183
	Keyboard ACER AF1S_A10B AF1S Internal 10 Standard 88KS Black Japanese Texture	KB.I100A.194
DIGITAL LIGHT DEVICE		
	CAMERA 1M	57.SGYN2.001
MAINBOARD		
	Mainboard V5-171,TMB13-M Intel HM77 UMA Broadcom 57785 Acer Logo LF CPU i3 3217	NB.M3A11.004
	Mainboard V5-171,TMB13-M Intel HM77 UMA Broadcom 57785 Acer Logo LF CPU i5 3317	NB.M3A11.001
	Mainboard AO756,TMB13-E Intel HM70 UMA Broadcom 57785 Acer Logo LF CPU B877	NB.SH011.003
	Mainboard AO756,TMB13-E Intel HM70 UMA Broadcom 57785 Acer Logo LF CPU B967	NB.SH011.002
	Mainboard AO756,TMB13-E Intel HM70 UMA Broadcom 57785 Acer Logo LF CPU B987	NB.SH011.001
	Mainboard V5-171,TMB13-M Intel HM77 UMA Broadcom 57785 Acer Logo LF CPU i3 2367	NB.M3A11.003
	Mainboard V5-171,TMB13-M Intel HM77 UMA Broadcom 57785 Acer Logo LF CPU i3 2377	NB.M3A11.005
FAN		
	FAN	23.SGYN2.001
HEATSINK		

CATEGORY	DESCRIPTION	PART NO.
	THERMAL MODULE W/O FAN	60.SGYN2.007
SPEAKER		
	MIC SET	23.SGYN2.002
	SPEAKER L+R	23.SGYN2.003
MISCELLANEOUS		
	DUMMY SD CARD	47.SGYN2.001
	HDD MYLAR W/ SPONGE	47.SGYN2.002

Screw List

CATEGORY	Description	Part No.
SCREWS		
	SCREW 2D 2.5L K 4.05D NI NL	86.SGYN2.001
	SCREW 2D 3L K 4.5D ZK NL CR3 0.4T	86.SGYN2.002
	SCREW 2D 3L K 4.5D ZK NL	86.SGYN2.003
	SCREW 2D 6L K 4.6D ZK NL CR3	86.SGYN2.004
	SCREW 3.0D 3.0L K 4.9D NI	86.SGYN2.005
	SCREW 2D 3L K 8D ZK NL	86.SGYN2.006
	SCREW M1.7X0.35+2.5P-ZK	86.SGYN2.007

Test Compatible Components

Test Compatible Components	7-2
Microsoft® Windows® 7 Environment Test	7-2

Test Compatible Components

This computer's compatibility is tested and verified by Acer's internal testing department. All of its system functions are tested under Windows® 7 environment.

Refer to the following lists for components, adapter cards, and peripherals which have passed these tests. Regarding configuration, combination and test procedures, please refer to the TravelMate B113 Series Compatibility Test Report released by the Acer Mobile System Testing Department.

Microsoft® Windows® 7 Environment Test

TravelMate B113 Series

Table 7:1. TravelMate B113 Series

ADAPTER			
60026861 LEADER	40W	Adapter LEADER 40W 19V 1.7x5.5x11 Black IU40-11190-011S, wall-mounted, LV5+OBL LF	AP.04007.002
10001081 DELTA	40W	Adapter DELTA 40W 19V 1.7x5.5x11 Black ADP-40 TH AA, LV5 wall-mounted, OBL LF	AP.04001.002
60016453 CHICONY POWER	40W	Adapter Chicony Power 40W 19V 1.7x5.5x11 Black W10-040N1A, wall-mounted LV5 LF	AP.0400H.001
BATTERY			
60001921 SANYO	4CELL2.5	Battery SANYO AL12B32 Li-Ion 4S1P SANYO 4 cell 2500mAH Main COMMON	KT.00403.004
CAMERA			
10001044 CHICONY	HD	Chicony HD CH_OV9726_AU	NC.21411.005
PLM00012 Suyin	HD	Suyin HD SY_OV9726_AU	NC.21411.008
CPU			
10001067 INTEL	CM877B	CPU Intel Celeron 877 BGA 1.4G 17W DDR3-1333	KC.NB001.877
10001067 INTEL	PMD987B	CPU Intel Pentium Dual-Core 987 BGA 1.5G 17W DDR3-1333	KC.PB001.987
10001067 INTEL	PMD967B	CPU Intel Pentium Dual-Core 967 BGA 1.3G 17W DDR3-1333	KC.PB001.967
10001067 INTEL	Ci52467MB	CPU Intel Core i5 2467M BGA 1.6G 17W	KC.24601.7MB

10001067 INTEL	Ci32367MB	CPU Intel Core i3 2367M BGA 1.4G 17W	KC.23601.7MB
10001067 INTEL	Ci32377MB	CPU Intel Core i3 2377M BGA 1.5G 17W	KC.23701.7MB
10001067 INTEL	Ci53317UB	CPU Intel Core i5 i5-3317U BGA 1.7G 1600 17W Ivy Bridge	KC.33101.5UM
10001067 INTEL	Ci33217UB	CPU Intel Core i3 i3-3217U BGA 1.8G 1600 17W Ivy Bridge	KC.32101.3UM
HDD			
60002005 HGST SG	N320GB5.4 KS	HDD HGST 2.5" 5400rpm 320GB HTS543232A7A384,0J28213,Eagle B7, 320G/P 7mmzh SATA 8MB LF+HF F/ W:DA4788	KH.32007.017
60002036 SEAGATE	N320GB5.4 KS_4K	HDD SEAGATE 2.5" 5400rpm 320GB 9WS14C-188 ST320LT012, Yarra 500G/ P, 7mmzh SATA 8MB LF+HF F/ W:0001SDM1	KH.32001.024
60002036 SEAGATE	N320GB5.4 KS_4K	HDD SEAGATE 2.5" 5400rpm 320GB ST320LT020/9YG142-188, Sapta 15,320G/P SATA 8MB LF+HF F/ W:0001SDM1 7mmzh	KH.32001.021
60002036 SEAGATE	N320GB5.4 KS_4K	HDD SEAGATE 2.5" 5400rpm 320GB 320G/P, 7mmzh, 9YG142-190, Sapta 15 SATA 8MB LF+HF F/W:0010SDM1	KH.32001.026
60002005 HGST SG	N500GB5.4 KS_4K	HDD HGST 2.5" 5400rpm 500GB HTS545050A7E380, Jaguar B7,0J23335, 500G/P SATA 8MB LF+HF F/W:DA4837 7mmzh HDD	KH.50007.023
60001994 WD	N500GB5.4 KS_4K	HDD WD 2.5" 5400rpm 500GB WD5000LPVT-22G33T0, MN500S, 500G/P, 7mmzh HDD SATA 8MB LF+HF F/W: 01.01A01	KH.50008.040
KB			
10000981 MISC	AF1S_A10B	Keyboard ACER AF1S_A10B AF1S Internal 10 Standard Black NONE Y2010 Acer Legend	KB.I100A.179
LCD			
60003316 AUO	NLED11.6W XGAGS	LED LCD AUO 11.6" WXGA Glare B116XW03 V201 LF 200nit 8ms 500:1	LK.11605.009
60003316 AUO	NLED11.6W XGAGS	LED LCD AUO 11.6" WXGA Glare B116XW03 V2 LF 200nit 8ms 500:1	LK.11605.007
10001022 CMI	NLED11.6W XGAGS	LED LCD CMO 11.6" WXGA Glare N116BGE-L41 LF 200nit 10ms 500:1	LK.1160D.006

60003316 AUO	NLED11.6W XGAS	LED LCD AUO 11.6' WXGA None Glare B116XTN04.0 LF 200nit 8ms 400:1	KL.11605.002
10001022 CMI	NLED11.6W XGAS	LED LCD CMI 11.6' WXGA None Glare N116BGE-L32 LF 200nit 10ms 500:1	KL.1160D.002
MEMORY			
60024207 KINGSTON-FAR EAST	SO1GBIII13	Memory KINGSTON SO-DIMM DDRIII 1333 1GB ACR128X64D3S1333C9 LF 128*8 0.065um	KN.1GB07.004
60033738 RAMAXEL	SO1GBIII13	Memory RAMAXEL SO-DIMM DDRIII 1333 1GB RMT3010EF48E7W-1333 LF+HF	KN.1GB0R.001
60002000 UNIFOSA	SO1GBIII13	Memory UNIFOSA SO-DIMM DDRIII 1333 1GB GU672203EP0200 LF 128*8 0.065um	KN.1GB0H.017
60002045 HYNIX	SO2GBIII13	Memory HYNIX SO-DIMM DDRIII 1333 2GB HMT325S6CFR8C-H9 LF+HF 256x8 38nm	KN.2GB0G.031
60001993 NANYA	SO2GBIII13	Memory NANYA SO-DIMM DDRIII 1333 2GB NT2GC64B88G0NS-CG LF+HF	KN.2GB03.025
60004668 ELPIDA	SO2GBIII13	Memory ELPIDA SO-DIMM DDRIII 1600 2GB EBJ20UF8BDU0-GN-F LF+HF 256*8 38nm	KN.2GB09.012
60024207 KINGSTON-FAR EAST	SO2GBIII	Memory KINGSTON SO-DIMM DDRIII 1600 2GB ACR256X64D3S16C11G LF+HF 256*8 38nm	KN.2GB07.008
60002045 HYNIX	SO4GBIII13	Memory HYNIX SO-DIMM DDRIII 1333 4GB HMT351S6CFR8C-H9 LF+HF 256x8 38nm	KN.4GB0G.012
60001993 NANYA	SO4GBIII13	Memory NANYA SO-DIMM DDRIII 1333 4GB NT4GC64B8HG0NS-CG LF+HF 46nm	KN.4GB03.009
60001955 A- DATA	SO4GBIII16	Memory A-DATA SO-DIMM DDRIII 1600 4GB AM1U16BC4P2-B19B LF+HF 256*8 38nm	KN.4GB0C.004
60004668 ELPIDA	SO4GBIII13	Memory ELPIDA SO-DIMM DDRIII 1600 4GB EBJ40UG8BBU0-GN-F LF+HF 512*8 38nm	KN.4GB09.005
60024207 KINGSTON-FAR EAST	SO4GBIII	Memory KINGSTON SO-DIMM DDRIII 1600 4GB ACR512X64D3S16C11G LF+HF 256*8 38nm	KN.4GB07.003
NB CHIPSET			
10001067 INTEL	HM70	NB Chipset Intel CS HM70 Chief River	KI.G7501.004
10001067 INTEL	HM77	NB Chipset Intel CS HM77 Chief River	KI.G7501.002

TOUCHPAD			
10000981 MISC	CP1ISV1M	Elantech Touchpad CP1ISV1M	NC.24611.009
10000981 MISC	CP1ISV1M	Synaptics Touchpad CP1ISV1M	NC.24611.00A
WLAN			
10001018 HON HAI	3rd WiFi 2x2 AGN+ BT4.0	Foxconn 3rd WiFi 2x2 AGN+ BT4.0 Atheros WB222	NI.23600.102
10001023 LITE-ON	3rd WiFi 2x2 AGN+ BT4.0	Liteon 3rd WiFi 2x2 AGN+ BT4.0 Atheros WB222	NI.23600.103

Online Support Information

Online Support Information	8-2
Introduction	8-2

Online Support Information

Introduction

This section describes online technical support services available to help users repair their Acer Systems.

For distributors, dealers, ASP or TPM, please refer the technical queries to a local Acer branch office. Acer Branch Offices and Regional Business Units may access our website. However some information sources will require a user i.d. and password. These can be obtained directly from Acer CSD Taiwan.

Acer's Website offers convenient and valuable support resources.

In the Technical Information section users can download information on all of Acer's Notebook, Desktop and Server models including:

- Service guides for all models
- Bios updates
- Software utilities
- Spare parts lists
- TABs (Technical Announcement Bulletin)

For these purposes, we have included an Acrobat File to facilitate the problem-free downloading of our technical materials.

Also contained on this website are:

- Detailed information on Acer's International Traveler's Warranty (ITW)
- Returned material authorization procedures
- An overview of all the support services we offer, accompanied by a list of telephone, fax and email contacts for all your technical queries.

We are always looking for ways to optimize and improve our services, do not hesitate to direct any suggestions or comments to us.

