



[www.lenovo.com](http://www.lenovo.com)



**lenovo**  
WORLDWIDE PARTNER



Version 1.0



31032754

# Lenovo IdeaCenter K User Guide



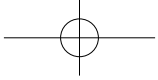

## Key to signs used in this manual



Prohibition: Dangerous operations



Danger: Watch out for high risks



Caution: Watch out for medium risks



Attention: Pay attention to low risks



Recommendation: Helpful tips

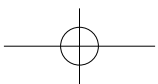
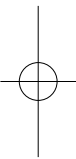
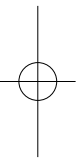
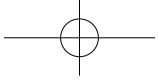

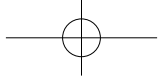

# Table of contents

## Key to signs used in this manual

<b>Chapter 1 Instructions for using computer hardware.....</b>	<b>1</b>
1.1 Front View of the Chassis .....	2
1.2 Rear view of the chassis .....	3
1.3 Speaker.....	6
1.4 Notes on computer cabling and installation .....	7
1.5 Keyboard.....	8
<b>Chapter 2 Lenovo Computer Rescue System Operation</b>	
<b>Instruction.....</b>	<b>9</b>
Note about service partition: .....	10
2.1 Installing Drivers and Software Shipped with Computer .....	10
2.2 OneKey Recovery .....	11
2.3 File Management .....	15
2.4 OneKey Antivirus .....	16
<b>Chapter 3 Using the software.....</b>	<b>19</b>
3.1 Power2Go — Burning Discs.....	20
3.2 WinDVD .....	21
3.3 PC-cillin.....	22
3.4 Lenovo Healthcare Software.....	23
<b>Chapter 4 System maintenance and recovery.....</b>	<b>25</b>
4.1 Restoring the system.....	26
4.2 Cleaning up the disk.....	26
4.3 Checking for, and correcting disk errors.....	27
4.4 Defragmenting the disk(s) .....	27
4.5 Performing daily maintenance tasks.....	27

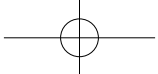

## **Chapter 5 Troubleshooting and Confirming Setup..... 29**

- 5.1 Troubleshooting display problems.....30
- 5.2 Troubleshooting audio problems .....30
- 5.3 Troubleshooting software problems .....31
- 5.4 Troubleshooting problems with optical drives and hard disks .....32

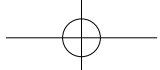

# 1

Chapter

## Instructions for using computer hardware

### This chapter is organized under the following topics:

- Front view of the chassis (Instruction for the use of buttons and functional keys on the front panel of the chassis)
- Rear view of the chassis (Instruction for the use of all I/O interfaces on the rear panel of the chassis)
- Connection of the speakers
- Notes on computer cabling and installation
- Keyboard

These topics describe some of the operations commonly performed during routine use of the computer, including the proper connection of components. Please read it carefully.

**!** **Note:** The configuration of your computer model may vary slightly from the illustrations used in this document.

1

2

3

4

5

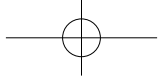

## 1.1 Front View of the Chassis

Instructions for the use of buttons and functional keys that are located at the front of the computer.

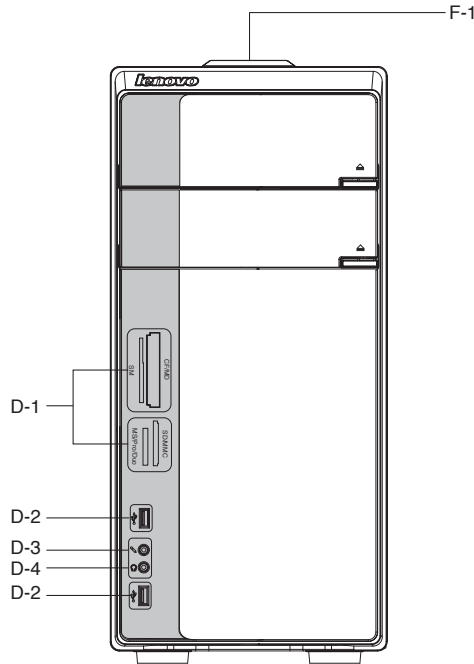

**F-1 Top Mounted Buttons:** Including power switch.

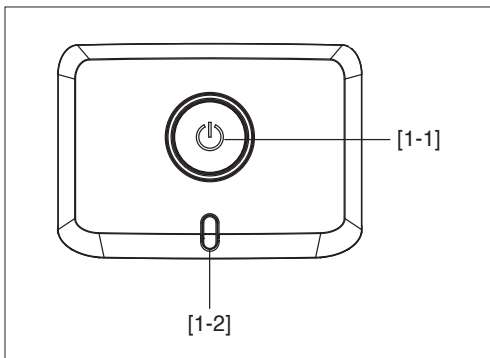

**[1-1] Power switch:** Press this button to turn the computer on or off, or, if the Power Option in the Control Panel has been set to allow it, to hibernate or wake up the computer.

**[1-2] Hard Disk Drive Indicator:** Indicates the read/write operations of the hard disk.

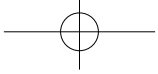

**D-1 Memory card reader Connector:** Able to read/write data from XD, CFI, II MD, MS, PRO, DUO, PRO DUO, SD, MINI, HC, MINIHC, MMS, RS, PLUS, Mobile memory cards.

**D-2 USB Connectors:** To connect USB devices.

**D-3 Microphone Connector:** To connect the microphone and pass the microphone audio input to the computer.

**D-4 Speakers/Headphones Connector:** To connect speakers or headphones. If it is necessary to connect the headphones, remove the speaker plug and insert the headphones plug.

## 1.2 Rear view of the chassis

### Instructions for the use of all I/O interfaces on the rear panel of the computer.

The following illustrations show connections located at the rear of some computer models. The locations of connectors on your computer will be similar to, but possibly not identical to these. Following the illustrations is a key that explains the symbol callouts used in the figures.

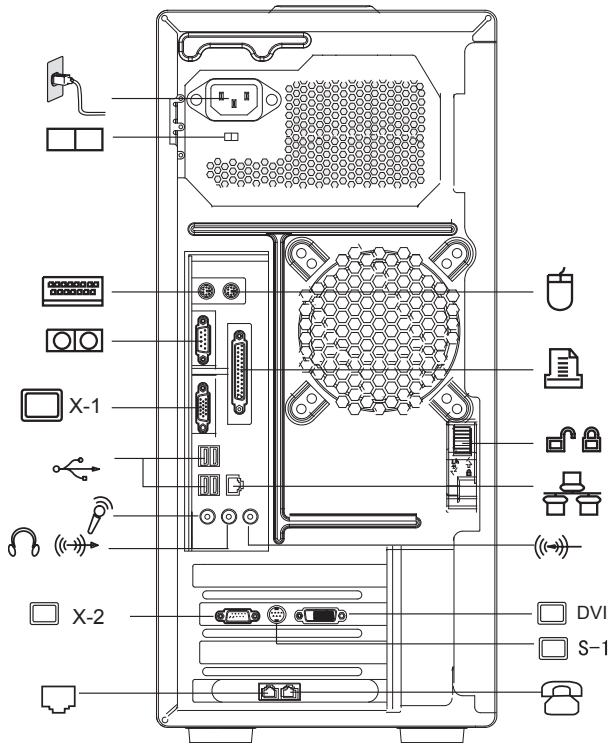

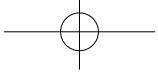

## Key to symbols used in the above illustrations of the rear of the chassis:



—— **Power Connector:** To supply power to the computer.



—— **PS/2 Mouse Connector:** To connect a mouse having a PS/2 connector.



—— **PS/2 Keyboard Connector:** To connect a keyboard having a PS/2 connector.



—— **Serial Connector:** To connect devices requiring a serial connection (COM Connector).



—— **Parallel Connector:** To connect devices requiring a parallel connection.



—— **X-1 On-board VGA Card Connector:** To connect with the signal cable of a monitor. On computer models that have an external graphics card, on-board graphics card signals are shielded and there are no VGA signal outputs. (some models are equipped with this connector.)



—— **USB Connector:** To connect USB devices.



—— **Ethernet Connector:** To connect LAN or broadband network devices.



—— **X-2 External VGA Card Connector:** To connect with the signal cable of a monitor. It connects with the data cable of the monitor. (Some models are equipped with this connector.)



—— **DVI External DVI Card Connector:** To connect to the data cable of the DVI connector. (Some models are equipped with this connector)



—— **S-1 S Video Connector:** To connect the data cable of the S video. (You cannot connect with the data cable of the S video provided with the computer.) Some models are equipped with this connector.

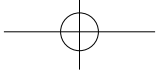

**Chassis Side Lock:** After installing the side panel of the chassis, push the lock upward to lock the side panel in place. To remove the side panel, depress the lock first.



**Audio Line-in Connector:** To connect audio input to the computer.

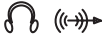

**Audio Line-out Connector:** To connect to the speakers or headphones.



**Microphone Jack:** To connect to audio input from a microphone.



Used to attach your computer to a telephone line for modem use. (some models equipped with this connector)



Used to attach a telephone line to your computer. (some models equipped with this connector)



**Voltage: selection switch (Some models are equipped with this switch)**

Check the position of the voltage-selection switch on the rear of the computer. Use a ballpoint pen to slide the switch, if necessary.

1. If the voltage supply range is 100-127 V ac, set the switch to 115 V.
2. If the voltage supply range is 200-240 V ac, set the switch to 230 V.

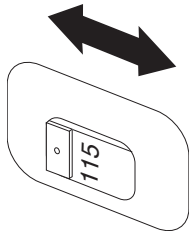

Figure 1

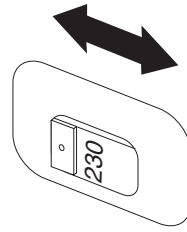
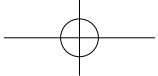
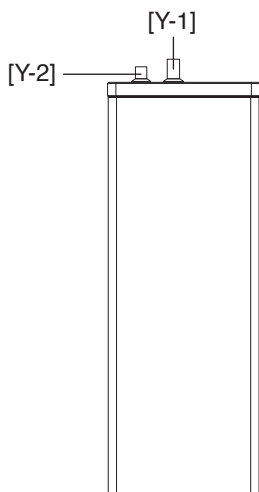

Figure 2



### 1.3 Speaker (some models equipped with Speaker)



Side elevation

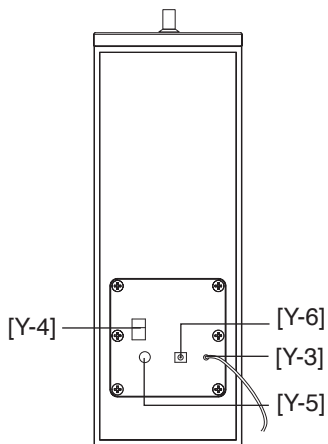

Back elevation

**Y-1** Volume Adjusting Knob

**Y-2** Bass Adjusting Knob

**Y-3** Connect to computer Audio-out

**Y-4** Speaker Power Switch

**Y-5** Speaker DC IN

**Y-6** Primary and secondary speaker cables

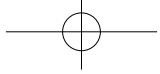

## 1.4 Notes on computer cabling and installation

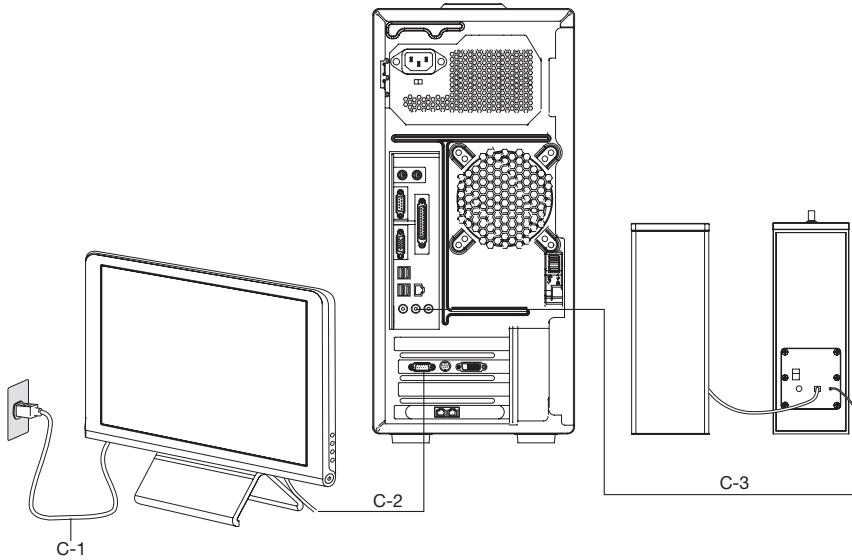

**C-1 Monitor power cord**

**C-2 Monitor data cable**

**C-3 Speaker audio signal cable**

1. Connect the monitor signal cable to the on-board graphics card connector if the model you purchased is not equipped with an external graphics card.
2. If there is an external graphics card, connect the monitor signal cable to the VGA or DVI connector in the external graphics card.
3. If both your computer and monitor have the DVI connector, you can connect the computer to the monitor through your own DVI data cable.
4. If there is only DVI connector in the external graphics card and the monitor only have the VGA connector, connect the monitor data cable and DVI connector by the DVI-VGA converter,

### **!** Notes:

- Keep speakers away from the monitor to avoid magnetic interference.
- Ensure the monitor-to-computer cable connections are secure, with screws tightened.
- Connect the monitor signal cable to the on-board graphics card connector if the model you purchased is not equipped with an external graphics card.

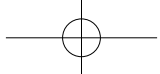

## 1.5 Keyboard

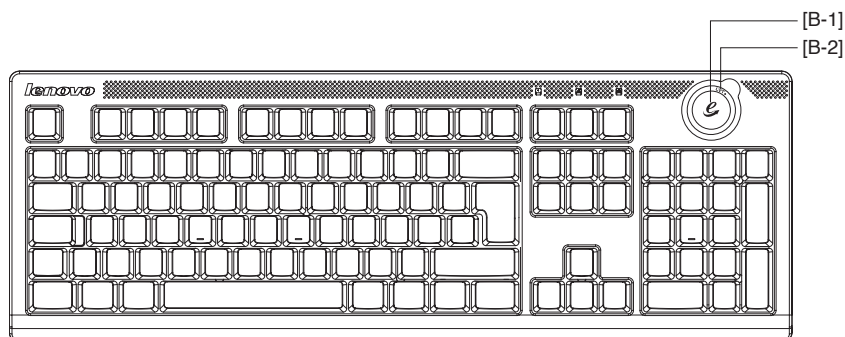

(This picture is only a sketch map for the keyboard, it does not show the detail of the key)

**[B-1]** — Press this key under Windows system to launch the IE.

**[B-2]** — LVT key, available for models with the “**System rescue**” feature. Press this key to launch “**System rescue**” when the “LENOVO” screen appears during booting.

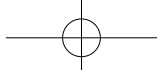

# 2

Chapter

## Lenovo Computer Rescue System Operation Instruction

---

---

### The following topics will be introduced in this chapter:

- Installing Drivers and Software
- OneKey Recovery
- File Management
- OneKey Antivirus

You can recover drive C of the computer to factory status or the last system backup status using OneKey Recovery. With this operation, all of the existing data in drive C will be lost while content and format of the other partitions in the hard disk drive will remain unchanged.

1

2

3

4

5

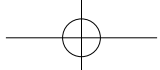

## Note about service partition:

The files and relevant data of the rescue system are saved in the service partition. Do not delete this partition. Otherwise, the rescue system will become unusable. For detailed operations, see the following instructions:

By selecting **Control Panel** → **Management Tools** → **Computer Management** → **Disk Management**, you can see the service partition, which must not be deleted.

**!** **Note:** The recovery files and relevant data of the rescue system are saved in the service partition. If the service partition is deleted or damaged by someone other than Lenovo maintainers, Lenovo (Beijing) Co., Ltd. shall not be liable for any losses arising therefrom in any way.

## Rescue system and keyboard operation

The rescue system works only if it runs together with the standard-configuration keyboard of this model. If there is no keyboard of standard configuration, the rescue system function will not work normally.

## 2.1 Installing Drivers and Software Shipped with Computer

The “Installing drivers and software” in the rescue system provides a way for the user to install the drivers and software shipped with the computer conveniently. It can install all drivers and software shipped with the computer automatically, and can selectively install some of the drivers and software as required by the user.

### Method 1: Automatic Installation

Power on the computer. When the screen displays the “Lenovo” picture initially, press the “LVT” key on the keyboard to start the **Rescue System**, select **Install drivers and software**.

Install them as prompted. Click Install to start installing the drivers and software.

The system restarts. After the system is restarted, the installation process goes on until completion.

### Method 2: Manual Installation

#### Launch

In the Windows system, launch **Start** → **All Programs** → **Lenovo** → **Drivers &**

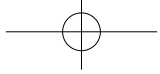

**Application Installation.** In the main interface of software, install all the drivers and software automatically, or install some of them selectively.

In the software list, check the software to be installed. It is recommended not to install the software which is already on the computer.

**!** **Note:** In order to use all software shipped with the computer properly, the tool software pctype must be installed. Otherwise, certain software shipped with the computer cannot work normally!

## 2.2 OneKey Recovery

**!** **Note:** Do not delete or change the backup data in the service partition without permission. Otherwise, it will affect or damage the rescue system programs.

### Main Functions:

OneKey Recovery in the LEOS (press the system rescue button to access system rescue directly without starting the operating system)

If Windows operating system is installed in your computer before delivery, the OneKey Recovery function works in the following way:

Recover Factory Backup	Recover the computer system partition (drive C) to the state which exists before delivery	<b>!</b> <b>Note:</b> After this operation, all existing data in the system partition will be lost, and other partitions on the disk will keep unchanged. In order to prevent loss of data, be sure to back up important data before this operation.
Instant Recovery	Recover the system partition (drive C) of the computer to the state which exists when the user performs the previous "Instant Backup" operation. If the user has not performed "instant backup", the instant recovery operation will recover the system partition to the "base backup" state directly.	

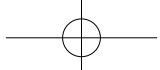



<p>Instant Backup</p>	<p>This operation backs up the current data of the system partition (drive C) of the computer quickly. When the user performs “Instant Recovery” later, the system partition will be recovered to this backup state quickly.</p>	<p><b>!</b> <b>Note:</b> In this operation, other partitions are not changed or backed up. Recommendation: Keep at least 1G of space in the system partition (drive C) to ensure the space required for instant backup.</p>
-----------------------	--	---

If Windows operating system is not installed in your computer before delivery, the OneKey Recovery function works in the following way:

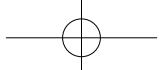
<p>Create Base Backup</p>	<p>Without factory backup, the Lenovo “OneKey Recovery” enables you to back up all data of the current system partition manually after installing the operating system and common software. Upon completion of “base backup”, you can use the “Recover Base Backup” function to recover the system partition to the state of this backup.</p>	<p><b>!</b> <b>Note:</b> Once the user has performed the operation of base backup, such operation is disabled. It is recommended to perform that operation after installing Windows operating system and the drivers &amp; software shipped together with the computer. Otherwise, the backup space is deficient.</p>
---------------------------	---	---



Recover Base Backup	This operation recovers the computer system partition (drive C) to the state of base backup.	 <b>Note:</b> After this operation, all existing data in the system partition will be lost, and other partitions on the disk will keep unchanged. In order to prevent loss of data, be sure to back up important data before this operation.
Instant Recovery	This operation recovers the system partition (drive C) of the computer to the state which exists when the user performs the previous “Instant Backup” operation. If the user has not performed “Instant Backup”, the instant recovery operation will recover the system partition to the “base backup” state directly.	
Instant Backup	Back up the current data of the system partition (drive C) of the computer quickly. When the user performs “Instant Recovery” later, the system partition will be recovered to this backup state quickly.	 <b>Note:</b> In this operation, other partitions are not changed or backed up. Recommendation: Keep at least 1G of space in the system partition (drive C) to ensure the space required for instant backup.

### OneKey Recovery in Windows Operating System:

In addition to Instant Recovery and Instant Backup, Windows operating system provides the functions enabled only in the Windows environment:

**Create Base Backup** — Back up data in system partition (drive C). This backup is base data of instant backup.

**Recover Base Backup** — Recover the data of system partition (drive C) which exists at the time of “creating base backup”.

**Close Instant Backup and Recovery** — After the Instant Backup and Recovery function is closed, all Instant Backup and Base Backup data will be deleted. Make sure you do not require such data before closing that function.

**Update Base Backup** — Use the system partition (drive C) data in the latest state as Base Backup to overwrite the old Base Backup data. The old Base Backup

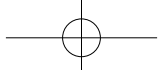

data will be lost. Make sure that you do not need the old Base Backup data any longer before that operation.

Instant Recovery and Instant Backup are the same as the functions under LEOS.

**! Note:**

1. Before performing the Instant Recovery and Instant Backup under LEOS, execute “Create Base Backup” under Windows first.
2. In order to prevent failure of the recovery operation, do not change the size of drive C after the backup operation.
3. Make sure to disable the Instant Backup and Recovery function or uninstall the “OneKey Recovery” function before reinstalling the operating system. Otherwise, the operating system cannot be reinstalled.
4. Before performing defragment of the operating system or the system maintenance functions such as error detection or backup, disable the Instant Backup and Recovery function first. Otherwise, the running of such software will be disabled or affected.
5. Precondition of updating base backup:
  - 1) After the system software or system state changes sharply, if you confirm such change and do not require the system to recover the state existent before the change, you can perform the update of Base Backup which serves as base data of future instant backup. You can also free up the hard disk drive space excessively occupied by the base backup.
  - 2) When the system disk space is less than 1G, the OneKey Recovery function will prompt you to perform disk cleanup and update base backup.
6. The “OneKey Recovery” function will run automatically on the background with the startup of the Windows. Certain antivirus software may regard such automatically running process as risk and warn the user. In such circumstances, choose to allow the software to go on automatically, whereupon the antivirus software will not give such prompt any longer.

## **Detailed operation procedure (example: Recovering Factory Backup):**

### **Recover Factory Backup**

1. Power on the computer. When the screen displays the “Lenovo” picture initially, press the “LVT” key on the keyboard to start the Rescue System, where you can select OneKey Recovery.
2. Select **Recover Factory Backup** to start the system recovery function.

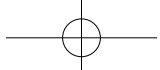

**!** **Note:** System Recovery will overwrite all of the data in drive C; please backup relevant data before performing system recovery to prevent your important data from missing.

3. Follow the onscreen instructions, and press E on the keyboard to start recovery if you are sure to recover.
4. Please wait in the process of system recovery. Do not interrupt the operation.
5. After the system is recovered successfully, the software prompts to restart the computer. Restart the computer and enter the system.

## 2.3 File Management

With the **File Management** module, you may access the critical data in directories such as **Desktop** or **My Document** of the system partition (usually drive C) when the system crashes and is irrecoverable, and back up such data into other partitions or storage devices.

### Launch

Power on the computer. When the “Lenovo” picture appears on the screen initially, press the “LVT” key to launch **Rescue System**. Then select **File Management**.

### File Backup

Select the file and folder to be copied in the left dialog box, and select the target folder and drive letter in the right dialog box. The drive letter of the source file must be different with the target drive letter. Then click **Copy**.

### File Backup

Wait while copying.

**!** **Note:** Please wait while copying; time for this operation depends on the quantity and size of files you need to copy. Do not turn off the power forcefully, otherwise it might cause file system abnormality.

### Configuring a Password

Click the key-shape icon on the upper right side of the main interface to configure the password.

To ensure authentication of the user ID who is copying the files, the Lenovo file management function enables you to configure a protection password - the user is unable to access the files in your hard disk drive partitions without passing the password authentication.

The default password is blank.

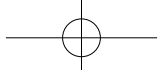

File management provides the search function, and backs up the searched files. Input the file or file type to be searched, click **Search** on the lower side to start searching files.

### Precautions:

1. In the process of copying files, do not cut off the power supply of the computer. Otherwise, it may damage the files in the hard disk drive.
2. The disk partition identifier in the file management interface may fail to correspond to that in the Windows system. Select it according to the directory content.
3. The file copying function cannot be performed in the same partition. If the source address and the target address share the same partition, the Copy button is disabled.

## 2.4 OneKey Antivirus

The OneKey Antivirus is independent of the operating system. It can implement general virus scan and killing, and can scan and kill viruses even when the Windows cannot start and the antivirus software cannot work as a result of virus infection, thus solving the problem of inability of using the computer after the virus damages the operating system.

### Launch

Power on the computer. When the “Lenovo” picture appears on the screen initially, press the “LVT” key to launch Rescue System. Then select OneKey Antivirus.

### Scan and kill viruses

Select **Full Scan** or **System Scan** to scan the disks.

**Full Scan** — Scan all partitions of the disk consecutively and kill the detected viruses.

**System Scan** — Only scan the operating system partition (usually drive C) and kill viruses in it.

### Scan and kill viruses

Please wait while the software is scanning and killing viruses. Try to avoid interruption of the process.

### Scan and kill viruses — stop

If you need to stop scanning or killing viruses halfway, click **Stop**. In the stop interface, click **OK** to stop the virus killing process. Or click **Cancel** to continue

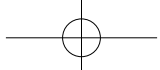

scanning.

### **Scan and kill viruses — results of scan**

The software will report the results of scan upon completion of virus scanning and killing, and will list all viruses killed and quarantined.

### **Scan and kill viruses — quarantined zone**

Click **View quarantine** to display the files which are infected with viruses and quarantined.

In the quarantined zone, you can clear, delete and recover the infected files.

### **Update**

To get OneKey Antivirus function to work normally and ensure detection of the latest viruses, the virus definitions need to be updated continuously. In the **OneKey Antivirus** main interface, select **Update** to start update of virus definitions.

#### **Update — online Update**

Virus definitions can be updated by:

1. Downloading the latest virus package online.
2. Obtaining the latest virus package from the flash disk.

First, we introduce the method of updating online. Select **Download latest virus package from Trend Technologies**, and click **Update Now**.

#### **Update — online update**

Depending on the network access mode of the computer, select “ADSL” or “LAN connection” in the network connection modes.

#### **Update — online update**

If you select “ADSL”, input the username and password of the ADSL connection.

If you select “LAN connection”, configure the IP address and proxy server of the LAN.

#### **Update — online update**

After the network is configured properly, the software will prompt success of network configuring. Click **OK** to start updating.

#### **Update — online update**

Please wait while the update process is going on. Try to avoid interruption of the process.

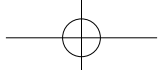

After the virus definitions are updated successfully, the software will prompt success of update.

### **Update — Obtaining the latest virus package from the flash disk**

First, make a flash disk for purpose of OneKey Antivirus in the Windows system. Connect the flash disk to the USB connector, and click **Start** → **All Programs** → **Lenovo** → **Download USB update package**.

**!** **Note:** Connect to the Internet before making the OneKey Antivirus flash disk.

### **Update — Obtaining the latest virus package from the flash disk**

Save the latest virus definitions in the flash disk. Restart the computer and access the OneKey Antivirus interface.

### **Update — Obtaining the latest virus package from the flash disk**

Select **Obtain latest virus package from flash disk**, and click **Update Now**. The virus definitions will be updated automatically.

**!** **Note:**

1. OneKey Antivirus does not promise to solve all problems caused by computer viruses. If the problems persist after you apply the OneKey Antivirus, use other methods to recover the system or solve the system problems.
2. This software only scans and kills the viruses in the hard disk drive partitions instead of the floppy disk, flash disk or CD. You can install and use the virus killer software under the Windows to scan such media.
3. In the process of cleaning viruses, do not cut off the power supply of the computer. Otherwise, it may damage the files in the hard disk drive.

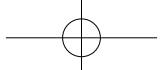

# 3

Chapter

## Using the software

### This chapter contains the following topics:

- CD/DVD Burner
- WinDVD
- PC-cillin
- Lenovo Healthcare Software

#### 1. Intervideo: WinDVD

**Webmail:** [www.intervideo.com](http://www.intervideo.com)

**Support E-mail:** [support@intervideo.com](mailto:support@intervideo.com)

#### 2. Cyberlink: Power2go

Europe (German, French, Italy, Spain)

**Webmail:** [http://de.cyberlink.com/multi/program/page/\\_page\\_display.jsp?seqno=173](http://de.cyberlink.com/multi/program/page/_page_display.jsp?seqno=173)

**Tel:** + 49-700-462-92375 Europe free support line, Located in Germany (Users have to pay phone charge)

**Support E-mail:** [goCyberlink@aixtema.de](mailto:goCyberlink@aixtema.de)



**Note:** The interface of each of these features is subject to the actual software that was shipped with computer model that you purchased.

1

2

3

4

5

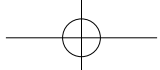

## 3.1 Power2Go — Burning Discs

Power2Go is the software for disc burning. It provides various burning tools that enable you to easily store your files into CDs or DVDs.

Power2Go can make common data discs, music discs, video/photo discs and mixed discs. It also supports disc duplication.



### Shortcuts

Choose **Programs** → **Lenovo** → **Power2Go** → **Power2GoExpress** from the **Start** menu to launch the burner program. The shortcut to launch the burner software is the block icon on the desktop. To launch a burner program, just drag and drop the files to be recorded onto their appropriate data, music, or video icon.

### Starting the burner software

1. Select **Programs** → **Lenovo** → **Power2Go** → **Power2Go** from the Start menu to launch the burner program.
2. Choose a task for the burner from the task list. Then start the burner to record files.

### Burning data discs

1. You can store data files such as documents or pictures by burning them to CD or DVD. From the **Disc Type**, choose the medium to burn, then click **OK**.
2. From the **Select Source** box, select the file to be burned. Then click the Add files icon to add your files into the **Disc compilation** column. Click the **Burn** icon to start burning those files.

### Burning music discs

1. You can also burn music discs, including WAV or WMA formats. Choose the medium from the **Disc Type** field and type of music discs from the **Content Type** field, then click **OK**.
2. From the **Select Source** box, select music files to be burned. Then click the

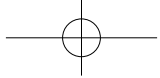

**Add files** icon to add music into the music list. Click the **Burn** icon to start burning the disc.

### Burning video/photo discs

1. You can also burn movies into CD/DVD. From the **Disc Type**, choose the medium to burn, then click **OK**.
2. Click the **Add files** icon from the video column and select the video files to be burned.
3. Set various properties for your CD/DVD in the menu bar, then click the **Burn** icon to start burning the disc with your videos.

### Disc duplication

The duplication feature copies discs directly.

### Mixed discs

You can burn music in different formats onto a same disc.

### Disc Utility

The burner also provides utility tools for preparing and processing various CDs or DVDs, including the recording of mirror files, erasing of discs and the conversion of audios.

### Help

For further information about the use of Power2Go, click the Help icon.

## 3.2 WinDVD

With WinDVD, you can play DVD and VCD.



### To launch the player:

Double click the **InterVideo WinDVD8** on the desktop.  
Launch the player.

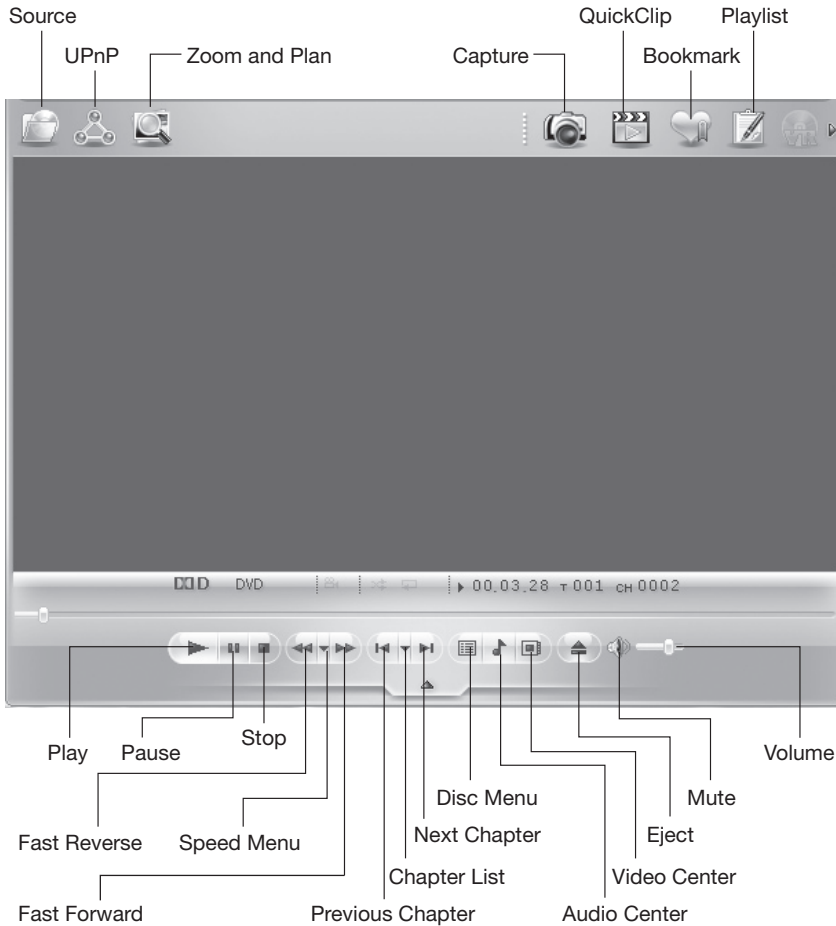
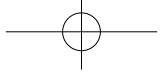

Click the “?” icon to obtain more information about WinDVD.

### 3.3 PC-cillin

If the PC cillin antivirus software is installed on your computer, operate according to the following instructions.

PC-cillin is a common type of antivirus software. It can scan and kill virus programs and Trojan (spy) programs in the computer and filter out harmful network programs.

#### Launch of PC-cillin

Click **Start** → **All Programs** → **Trend Micro PC-cillin Internet Security2007** →

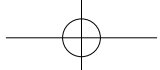

**Trend Micro PC-cillin Internet Security2007 Open Main Console** to launch the PC-cillin antivirus software.

Or right click the icon of PC-cillin in the notification area and launch the antivirus software in the pop-up options.

### Scanning viruses

In the main interface of PC-cillin, click **Scan Now** to scan the computer. Upon completion of scanning, the software will pop up a system scanning report, which lists all virus files detected, and you can quarantine or delete them as required.

### Upgrade

In the main interface of PC-cillin, click **Update Now** to upgrade the virus definitions of the software.

 **Note:** Connect to the Internet before upgrade.

### Configure scanning of the specified disk

In the main interface of PC-cillin, click **More options**. In the virus detection function here, you can select the disks that you want to scan in the scan targets.

### Other protection functions

Other settings of the software are available in the toolbar on the left side, including setting of protection against Trojan (spy) viruses, setting of personal network and firewall, interconnection and email setting. Configure them as specifically required.

### Help and support

For more software information and operation help information, see **Product Help Information** in the **Help and Support** option. In the help document, you can understand more software operation details and setting methods.

## 3.4 Lenovo Healthcare Software

Lenovo Healthcare Software is a smart software platform that helps parents to guide their children to use computer correctly, thus to protect and promote healthy growth of their children.

### With the bright vision function, the Lenovo Healthcare Software:

- Automatically monitors the distance between the child's head and the computer display during computer operation, and prompts the child to keep a proper distance from the computer monitor.
- Automatically adjusts the display brightness of the computer according to the

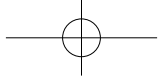

ambient brightness.

- Helps the child keep a proper sitting posture while operating a computer.

In a word, the Lenovo Healthcare Software protects the healthy growth of children's spines and vision (the use of Lenovo Bright Eye camera is required before such functions are available).

## Bright Vision Setting

1. The Lenovo Bright Eye camera and Lenovo Healthcare Software work together to ensure proper distance between the computer operator and the computer display and adjust the display brightness to a comfortable level, thus to protect the operator's vision.
2. This function applies only to the computers equipped with Lenovo Bright Eye camera and is available only after the camera is installed.
3. For details about installing Lenovo Bright Eye camera, see "**Installation Guide for Lenovo Bright Eye Camera**" in this document.
4. Before using this software, you need adjust the pitching angle of web camera to appropriate position.

**The operation is as following:**

- 1) Click **Star** → **All Programs** → **Vimicro UVC Camera** → **vmcap**.

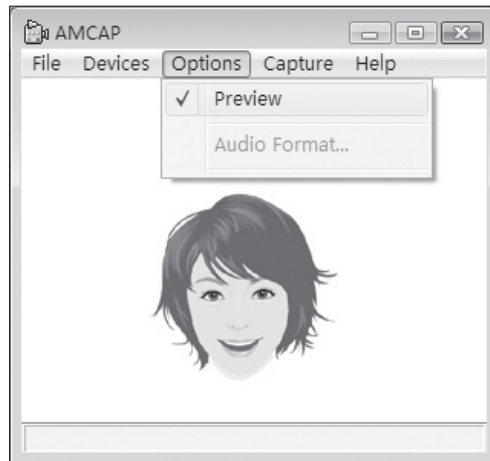

- 2) Select **Options** → **Preview** from the pop window to display image in the video capture window.

**!** **Note:** If there is no image display in AMCAP video capture window, please confirm whether the "Preview" in the "Options" has been checked.

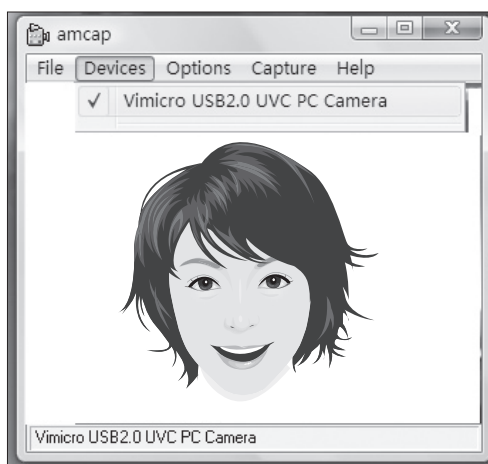
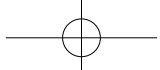

- 3) Confirm the **Devices** → **Vimicro USB 2.0 UVC PC Camera** has been checked. Now, an image, which is caught by Lenovo Bright Eye camera, will be displayed in the video capture window. Adjusting the position and pitching angle of the camera to make the whole face display in the video capture window. So that you may use **the Bright Eye camera** and **Lenovo Health Care Software** very well.
- 5 Select **Lenovo Healthcare Software** → **Bright Vision**.
- 6 After installing the camera, click **Distance Setup** or **Brightness Adjustment** to set it.

## Distance Setup

1. Select the display type according to the size of the display used.
2. Select **Healthy Viewing Distance Selection** to set the distance between the computer operator and the computer display.  
By default, "Default" is selected. You can adjust the viewing distance according to your requirement.
3. Select **Response Time Setting** to set the duration when the distance between the operator and the display is shorter than the health viewing distance before an alarm is given.

## Brightness Adjustment

1. Adjust the display brightness according to the ambient brightness.
2. There are three levels of ambient brightness: Dim, Moderate, and Bright.
3. When you use the computer for the first time, you should set the proper display

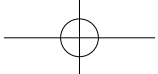

brightness according to each level of ambient brightness.

4. For each level of the ambient brightness, the recommended display brightness is selected by default. Please adjust your display brightness to a comfortable level.
5. After the brightness setting is completed, the display brightness will be automatically changed according to the current level of ambient brightness.

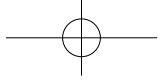

# 4

Chapter

## System maintenance and recovery

### This chapter includes the following topics:

- System restoration
- Hard disk cleanup
- Hard disk error checking and correcting
- Hard disk defragmenting
- Daily maintenance

1

2

3

4

5

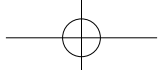

## 4.1 Restoring the system

The system can develop problems due to erroneous operation or the installation of additional software. If software problems develop in the originally installed software, you can restore the system by using system backup and restoration features.

### Notes:

- The system closes all programs before it performs system restoration. Be sure to save your data.
- The existing system settings will change after restoration. Check the settings of the restored system to ensure they match settings that may be critical to your needs.

Use the following procedure to restore the software to a known functional level:

1. Choose **System Restoration via Start** → **Programs** → **Accessories** → **System tools**.
2. Choose either the recommended restore or select a different recovery time from the pop-up box. Choose the latest date when the system was running properly.
3. Click **Next**.

The system starts restoration. When all processes run to completion, the system displays a message informing you that the restore operation has completed successfully.

### File Backup

For security purposes, you can back up the system status before you install additional software, or otherwise modify system settings. To backup up the system status, do the following:

1. Follow the above steps to enter the backup status and configuration. Select **Run file backup immediately**.
2. Select the location for your backup. Click **Next** and follow the instructions to continue.

## 4.2 Cleaning up the disk

Do the following periodically to cleanup the disks and possibly enhance your computer's performance.

1. Choose **Disk Cleanup via Start** → **Programs** → **Accessories** → **System tools**.
2. Choose the file you want to clean up.

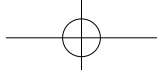

3. Click the **OK** button to start the cleanup process.

### 4.3 Checking for, and correcting disk errors

To properly maintain your system, you should periodically check for and fix hard disk errors by doing the following:

1. Right-click the icon for the hard disk drive (HDD) that you want to reorganize, then select Properties from the pop-up menu.
2. Select the **Tools** tab, then click **Check Now**.
3. Check your inspection items for the disk and click **Start**.

You cannot start error checking until the computer is restarted and initialized.

### 4.4 Defragmenting the disk(s)

Disk fragments are tiny unused storage areas scattered on the disk. The system cannot directly reutilize these 'blank' spaces and system performance can decrease as system operations usually cause the number of unused storage gaps to increase. To defragment your disk storage, do the following:

1. Go to the Tools tab from disk Properties and select Defragment Now.
2. Select the time and scheme to be used by the defragging program, then start the defragmenting program.

Defragmentation usually takes a long time.

### 4.5 Performing daily maintenance tasks

#### Cleaning the computer components

Because many of the computer components consist of sophisticated integrated circuit boards, it is very important to periodically clean around the computer to prevent dust buildup. The cleaning supplies you need in order to clean the components include: a vacuum cleaner, a soft cotton cloth, clear water (pure water preferred) and cotton swabs.

#### Following are general methods for cleaning the components:

- You can use a soft cloth to remove dust on the surface of the computer, the monitor, the printer, the speakers and the mouse.
- You can use a vacuum cleaner to clean in otherwise inaccessible corners.
- To clean the keyboard thoroughly, shut down the computer and scrub it gently with a wet cloth
- Do not use the keyboard until it is dry.

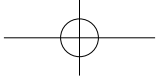

**Do not do any of the following:**

- Allow water to enter the computer
- Use a heavily dampened cloth
- Do not spray water directly onto the surface of the monitor or inside of computer.

Daily attention should be given to LCD monitors. Use a dry cloth daily to brush dust from the monitor and keyboard. Keep all surfaces clean and free of grease stains.

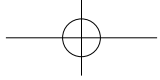

# 5

Chapter

## Troubleshooting and Confirming Setup

---

**This chapter contains information on the following topics:**

- Troubleshooting display problems
- Troubleshooting audio problems
- Troubleshooting software problems
- Troubleshooting problems with optical drives and hard disks

The description of the TV card in this manual is only used for the machines which have the TV card. It is invalid for those machines which do not have TV card.

1

2

3

4

5

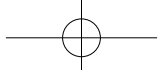

## 5.1 Troubleshooting display problems

**Problem:** Blank screen or no image is displayed on the monitor

### Troubleshooting and problem resolution:

1. Check that the monitor has been turned on; if not, press the power button.
2. Check to see if the monitor power cord is loose; if so, securely plug the power cord to the monitor.
3. Check that the signal cable to the monitor is securely connected to the connector on the computer graphics card; if not, shut down the computer then securely connect the signal cable of the monitor.

**Problem:** You need to change display property settings

### Setting display background and icon properties:

1. Right-click the desktop anywhere except over an icon, then select **Personalize** from the pop-up menu.
2. From here, select the appropriate options to:
  - Change the desktop background
  - Select a screen saver
  - Select colors and appearance options for icons and characters
  - Set resolution and colors by using Display Settings options.

**Problem:** Ripple on screen

### Troubleshooting and problem resolution:

1. Check for devices located less than one meter from the computer such as refrigerators, electric fans, electric dryers, UPSs, regulators, fluorescent lamps or other computers that may be generating magnetic interference.
2. Move any interfering devices away from the computer.
3. If the problem persists, consult with Lenovo Service.

## 5.2 Troubleshooting audio problems

**Problem:** When you connect the headphones to the front audio output connector, the speakers connected to the back audio output connector are silenced.

### Troubleshooting and problem resolution:

The front audio output connector is provided for convenience and has a priority higher than the back audio output connector. If a speaker or headphones are connected to the front audio output connector, sound is delivered through those devices and any devices connected to the rear connector become silenced.

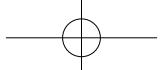

**Problem:** You are unable to get any sound from either the front or the rear output connectors.

#### **Troubleshooting and problem resolution:**

1. Check that the cable between the speakers and computer is properly connected.
2. Make sure the audio option in the lower right corner of the taskbar is not Mute.
3. Check that the volume of each sound channel is set to an audible level; if not adjust the volume to the appropriate level.
4. If the problem persists, re-install the driver for the audio card by clicking in succession **Start** → **All Programs** → **Lenovo** → **Drivers and Software Installation**.

### **5.3 Troubleshooting software problems**

**Problem:** You are unable exit a running problem normally.

#### **Troubleshooting and problem resolution:**

1. Open the **Task Manager** window by pressing **Ctrl, Alt** and **Delete** at the same time.
2. Select the **Application** tab, select the problem program, then click the **End Task** button.

**Problem:** You need to install or uninstall a program.

#### **Problem resolution:**

***During installation*** never abort the install process by powering the system off or through other drastic means. This can cause system program disorder or even failure during system initialization.

***During the uninstall process***, never directly delete the files or folders. This is harmful to the system, and might cause a system-wide malfunction.

Use the following procedure to properly uninstall programs:

1. Backup all documents and system settings related to the program before removing it.
2. If the program has its own uninstaller, run it directly to uninstall the program.
3. If the program does not have its own uninstaller, then select **Control Panel** from **Start** menu.
4. From the **Control Panel**, choose **Programs and Functions**.
5. Find the applicable program from the **Programs and Functions** dialog box and then select **Uninstall/Modify**.
6. Perform the instructions displayed to uninstall the software.

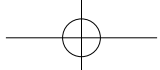

## 5.4 Troubleshooting problems with optical drives and hard disks

**Problem:** The Optical drive is unable to Read a CD/DVD.

### Troubleshooting and problem resolution:

1. Check to determine if there is an optical drive icon in the resource manager of the operating system. If not, restart your computer. If there is still no icon, contact Lenovo Service. Otherwise, continue with the next step of this procedure.
2. Confirm that the CD/DVD has been properly placed in the drive. If not, reload the CD or DVD. Otherwise, continue with the next step of this procedure.
3. Check the specifications that came with your computer to confirm that this optical drive is supposed to be able to read this type of CD or DVD.
4. If the CD/DVD can not be read, replace it with a known good CD/DVD such as one that was shipped with the computer.
5. If the known good CD can not be read, visually check the operating side of the CD/DVD for defects.

**Problem:** The capacity of the hard disk, as indicated by the system, is less than the nominal capacity.

**Troubleshooting and problem resolution:** For computers equipped with the One-Key Recovery feature, the system recovery feature needs to occupy some hard disk space. This may account for the apparent hard disk capacity deficit.

**Further Technical Explanation:** The nominal capacity of the hard disk is expressed in the decimal system, 1000 bytes. But the actual hard disk capacity is expressed in the binary system as 1024 bytes. (For example, the nominal capacity 1G is 1000M, while the actual capacity 1G is 1024M).

The capacity of the hard disk shown in Windows can be calculated according to the calculations in the following example:

The nominal capacity of the hard disk is 40G, while its actual capacity should be:  $40 \times 1000 \times 1000 \times 1000 / (1024 \times 1024 \times 1024) = 37\text{G}$ .

If the Service partition of 3G -  $3 \times 1000 \times 1000 \times 1000 / (1024 \times 1024 \times 1024) = 2.79\text{G}$  is subtracted, the capacity of the hard disk shown in the system can be obtained.

The capacity of the hard disk as calculated using this method may be slightly different from the actual capacity due to the rounding of totals.